

**ELECTROMAGNETIC EMISSIONS COMPLIANCE REPORT
FCC PART 15 SUBPART C REQUIREMENT**

OF

Wi-Fi + BLE Stick

Model No.:

**EESW-A413, EESW-A400, EESW-A401, EESW-A402, EESW-A404,
EESW-A407, EESW-A408, EESW-A411, EESW-A415, EESW-A416,
EESW-A417, EESW-A418, EESW-A200**

Trademark:  **E-LINTER**
connection creates value

FCC ID: 2BAGJ-EESWA413

Report No.: E01A23021023F00306

Issue Date: March 17, 2023

Prepared for

Chengdu E-LINTER Information Technology Co., Ltd.

**Floor 9, Building 10, No.399 West Section of Fucheng Aven. , Chengdu,
Sichuan, China**

Prepared by

Dong Guan Anci Electronic Technology Co., Ltd.

**1-2 Floor, Building A, No.11, Headquarters 2 Road, Songshan, Lake Hi-tech
Industrial Development Zone, Dongguan City, Guangdong Pr., China..**

**This report shall not be reproduced, except in full, without the written approval of
Dong Guan Anci Electronic Technology Co., Ltd.**

VERIFICATION OF COMPLIANCE

Applicant:	Chengdu E-LINTER Information Technology Co., Ltd. Floor 9, Building 10, No.399 West Section of Fucheng Aven. , Chengdu, Sichuan, China.
Manufacturer:	Chengdu E-LINTER Information Technology Co., Ltd. Floor 9, Building 10, No.399 West Section of Fucheng Aven. , Chengdu, Sichuan, China
Product Description:	Wi-Fi + BLE Stick
Model/Type reference	EESW-A413, EESW-A400, EESW-A401, EESW-A402, EESW-A404, EESW-A407, EESW-A408, EESW-A411, EESW-A415, EESW-A416, EESW-A417, EESW-A418, EESW-A200 (There is no difference except for the model name , so we performed on the model EESW-A413)
Trade Mark:	
Test Model Number:	EESW-A413
Sample number:	A23021023 012

We hereby certify that:

The above equipment was tested by Dong Guan Anci Electronic Technology Co., Ltd. The test data, data evaluation, test procedures, and equipment configurations shown in this report were made in accordance with the procedures given in ANSI C63.10-2013 and the energy emitted by the sample EUT tested as described in this report is in compliance with conducted and radiated emission limits of FCC Rules Part 15.247(2022).

Date of Test : March 2, 2023 to March 15, 2023

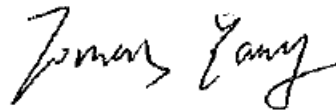

Prepared by :

Tomas Yang/Editor

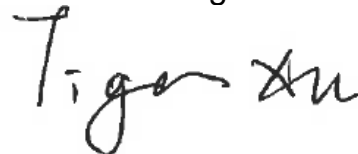

Approved & Authorized Signer :

Tiger Xu / Supervisor

Modified Information

Version	Summary	Revision Date	Report No.
Ver.1.0	Original Report	/	E01A23021023F00306

Table of Contents

1.	GENERAL INFORMATION.....	6
1.1	PRODUCT DESCRIPTION	6
1.2	TEST METHODOLOGY	6
2.	TEST FACILITY	7
3.	DESCRIPTION OF TEST MODES.....	8
4.	SUMMARY OF TEST RESULTS	10
6DB BANDWIDTH MEASUREMENT		10
5.	TEST SYSTEM UNCERTAINTY	11
6.	CONDUCTED EMISSIONS TEST	12
6.1	MEASUREMENT PROCEDURE:	12
6.2	TEST SET-UP (BLOCK DIAGRAM OF CONFIGURATION)	12
6.3	MEASUREMENT EQUIPMENT USED:	12
6.4	CONDUCTED EMISSION LIMIT	13
6.5	MEASUREMENT RESULT:	13
6.5	CONDUCTED MEASUREMENT PHOTOS:.....	16
7.	RADIATED EMISSION TEST	17
7.1	MEASUREMENT PROCEDURE	17
7.2	TEST SET-UP (BLOCK DIAGRAM OF CONFIGURATION)	19
7.3	MEASUREMENT EQUIPMENT USED:	20
7.4	RADIATED EMISSION LIMIT.....	21
7.5	MEASUREMENT RESULT	22
7.6	RADIATED MEASUREMENT PHOTOS:.....	28
8.	6DB BANDWIDTH MEASUREMENT	29
8.1	MEASUREMENT PROCEDURE	29
8.2	TEST SET-UP (BLOCK DIAGRAM OF CONFIGURATION)	29
8.3	MEASUREMENT EQUIPMENT USED:	29
8.4	LIMIT	30
8.5	MEASUREMENT RESULTS:	30
9.	MAXIMUM PEAK OUTPUT POWER TEST	31
9.1	MEASUREMENT PROCEDURE	33
9.2	TEST SET-UP (BLOCK DIAGRAM OF CONFIGURATION)	33
9.3	MEASUREMENT EQUIPMENT USED:	33
9.4	PEAK POWER OUTPUT LIMIT	33
9.5	MEASUREMENT RESULTS:.....	34
10.	POWER SPECTRAL DENSITY MEASUREMENT	37
10.1	MEASUREMENT PROCEDURE	37
10.2	TEST SET-UP (BLOCK DIAGRAM OF CONFIGURATION)	37
10.3	MEASUREMENT EQUIPMENT USED:	37

10.4 MEASUREMENT PROCEDURE	37
10.5 MEASUREMENT RESULTS:	38
11. BAND EDGE TEST	41
11.1 MEASUREMENT PROCEDURE	41
11.2 TEST SET-UP (BLOCK DIAGRAM OF CONFIGURATION)	42
11.3 MEASUREMENT EQUIPMENT USED:	42
11.4 MEASUREMENT RESULTS:	43
12 ANTENNA APPLICATION	47
12.1 ANTENNA REQUIREMENT.....	47
12.2 RESULT	47
APPENDIX (PHOTOS OF EUT) (7 PAGES)	

1. GENERAL INFORMATION

1.1 Product Description

Characteristics	Description
Product Name	Wi-Fi + BLE Stick
Model number	EESW-A413
Power Supply	DC 5V
Kind of Device	Bluetooth Ver.5.0 BLE
Modulation	GFSK
Operating Frequency Range	2402-2480MHz
Number of Channels	40
Transmit Power Max(PK)	4.89dBm(0.0031W)
Antenna Type	Internal PCB antenna
Antenna Gain	4.16dBi
Date of Sample Received	March 2, 2023

1.2 Test Methodology

All the test program has follow FCC new test procedure KDB 558074 D01 DTS Meas Guidance v05 and in accordance with the procedures given in ANSI C63.10-2013.

2. Test Facility

Site Description

EMC Lab. : Accredited by FCC, May 30, 2019
Designation Number: CN1230
Test Firm Registration Number: 991798

Name of Firm : Dong Guan Anci Electronic Technology Co., Ltd.

Site Location : 1-2 Floor, Building A, No.11, Headquarters 2 Road, Songshan,
Lake Hi-tech Industrial Development Zone, Dongguan City,
Guangdong Pr., China.

3. Description of test modes

The EUT has been tested under its typical operating condition and fully-charged battery for EUT tested alone. Pre-defined engineering program for regulatory testing used to control the EUT for staying in continuous transmitting. Only the worst case data were reported.

For Radiated: The EUT's antenna was pre-tested under the following modes:

Test Mode	Description
Mode A	X-Y axis
Mode B	Y-Z axis
Mode C	X-Z axis

From the above modes, the worst case was found in Mode C. Therefore only the test data of the mode was recorded in this report.

The EUT has been associated with peripherals pursuant to ANSI C63.10-2013 and configuration operated in a manner tended to maximize its emission characteristics in a typical application. Frequency range investigated: radiation (9 KHz to the 10th harmonics of the highest fundamental frequency or to 40 GHz, whichever is lower).

Configuration of Tested System



Equipment Used in Tested System

Item	Equipment	Trademark	Manufacturer	Model No.	FCC ID	Note
1.	Wi-Fi + BLE Stick	 E-LINTER connection creates value	Chengdu E-LINTER Information Technology Co., Ltd.	EESW-A413	2BAGJ-EESWA413	<i>EUT</i>

The EUT has been tested under TX operating condition.

Channel List:

Channel	Frequency (MHz)	Channel	Frequency (MHz)	Channel	Frequency (MHz)
00	2402	14	2430	28	2458
01	2404	15	2432	29	2460
02	2406	16	2434	30	2462
03	2408	17	2436	31	2464
04	2410	18	2438	32	2466
05	2412	19	2440	33	2468
06	2414	20	2442	34	2470
07	2416	21	2444	35	2472
08	2418	22	2446	36	2474
09	2420	23	2448	37	2476
10	2422	24	2450	38	2478
11	2424	25	2452	39	2480
12	2426	26	2454		
13	2428	27	2456		

Note:

1. Test of channel was included the lowest 2402MHz, middle 2440MHz and highest frequency 2480MHz in highest data rate and to perform the test, then record on this report.

4. Summary of Test Results

FCC Rules	Description Of Test	Result
§15.207	AC Power Conducted Emission	N/A (See Remark)
§15.247(d),§15.209	Radiated Emission	Compliant
§15.247(a)(2)	6dB Bandwidth Measurement	Compliant
§15.247(b)	MAXIMUM PEAK OUTPUT POWER TEST	Compliant
§15.247(e)	Power Spectral Density Measurement	Compliant
§15.247(d)	Band EDGE test	Compliant
§15.203	Antenna Requirement	Compliant
<p>Remark:</p> <p>N/A :The EUT is supplied by Battery, so this item does not applicable.</p> <p>According to FCC OET KDB 558074, the report use radiated measurements in the restricted frequency bands. In addition, the radiated test is also performed to ensure the emissions emanating from the device cabinet also comply with the applicable limits.</p>		

5. TEST SYSTEM UNCERTAINTY

The following measurement uncertainty levels have been estimated for tests performed on the apparatus:

Parameter	Uncertainty
Radio Frequency	$\pm 1 \times 10^{-5}$
Maximum Peak Output Power Test	$\pm 1.0\text{dB}$
Conducted Emissions Test	$\pm 2.0\text{dB}$
Radiated Emission Test	$\pm 2.0\text{dB}$
Power Density	$\pm 2.0\text{dB}$
Occupied Bandwidth Test	$\pm 1.0\text{dB}$
Band Edge Test	$\pm 3\text{dB}$
All emission, radiated	$\pm 3\text{dB}$
Antenna Port Emission	$\pm 3\text{dB}$
Temperature	$\pm 0.5^{\circ}\text{C}$
Humidity	$\pm 3\%$

Remark: The coverage Factor ($k=2$), and measurement Uncertainty for a level of Confidence of 95%

6. Conducted Emissions Test

6.1 Measurement Procedure:

1. The EUT was placed on a table, which is 0.8m above ground plane.
2. Maximum procedure was performed on the six highest emissions to ensure EUT compliance.
3. Repeat above procedures until all frequency measured was complete.

6.2 Test SET-UP (Block Diagram of Configuration)

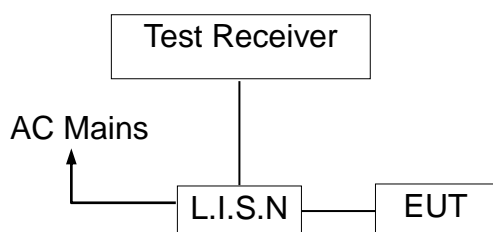

6.3 Measurement Equipment Used:

C	Instr.Code	Kind of Equipment	Manufacturer	Type No.	Serial No.	Calibrated until
1	AN-E010	L.I.S.N	SCHWARZBECK	NSLK 8127	8127-669	2023-05-12
2	AN-E078	TRANSIENT LIMITER	CYBERTEK	EM5010A	E1950100113	2023-05-12
3	AN-E022	RF Cable	N/A	ZT06S-BNCJ-NJ-7.5M	19044020	2023-05-12
4	AN-E020	EMI Test Receiver	ROHDE&SCHWARZ	ESCI	101358	2023-05-12
5	AN-E058	1# Shielded Room	chengyu	8m*4m*3.3m	N/A	2024-11-12
6	AN-E046	Test Software	Farad	EZ-EMC (Ver.ANCI-3A1)	N/A	N/A

6.4 Conducted Emission Limit

(7) Conducted Emission

Frequency(MHz)	Quasi-peak	Average
0.15-0.5	66-56	56-46
0.5-5.0	56	46
5.0-30.0	60	50

Note:

1. The lower limit shall apply at the transition frequencies
2. The limit decreases in line with the logarithm of the frequency in the range of 0.15 to 0.50MHz.

6.5 Measurement Result:

Operation Mode:	TX	Test Date :	March 15, 2023
Frequency Range:	0.15MHz~30MHz	Temperature :	23.5°C
Test Result:	PASS	Humidity :	52.6 %
Test By:	Sunshine		

All the modulation modes were tested the data of the worst mode (Pi/4-DQPSK TX 2402MHz) are recorded in the following pages and the others modulation methods do not exceed the limits.

Please refer to the following data.

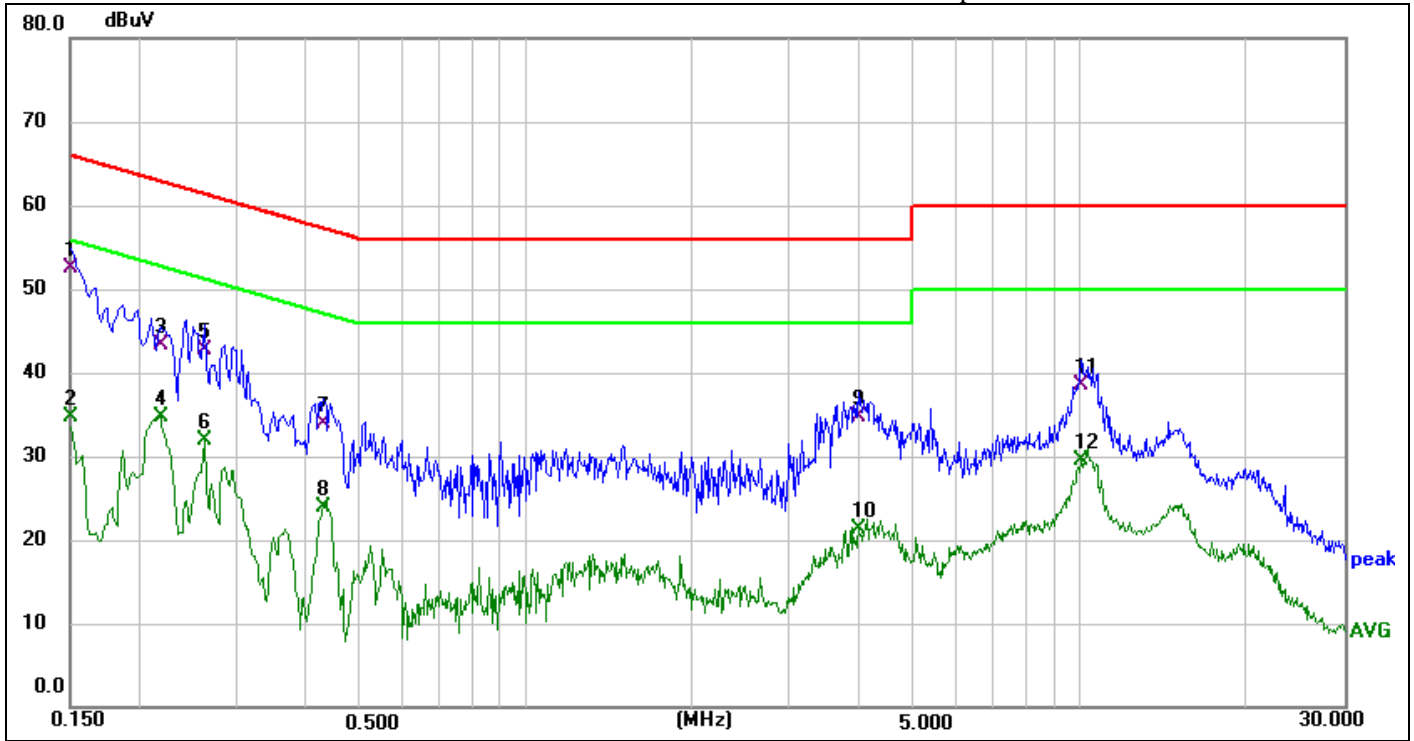

Site:	843	Phase:	L1	Temperature(C):	23.5(C)
Limit:	FCC PART 15C Conduction(QP)	Test Time:	2023-03-15 21:20:13	Humidity(%):	52.6%
EUT:	Wi-Fi + BLE Stick	Power Rating:	DC 5V	Test Engineer:	Sunshine
M/N.:	EESW-A413				
Mode:	Pi/4-DQPSK TX 2402MHz				
Note:					

No.	Frequency (MHz)	Reading Level(dBuV)	Factor (dB)	Measurement(dBuV)	Limit (dBuV)	Over (dB)	Detector	Comment
1 *	0.1500	42.49	9.93	52.42	66.00	-13.58	QP	
2	0.1500	24.72	9.93	34.65	56.00	-21.35	AVG	
3	0.2180	33.09	10.17	43.26	62.89	-19.63	QP	
4	0.2180	24.48	10.17	34.65	52.89	-18.24	AVG	
5	0.2620	32.27	10.35	42.62	61.37	-18.75	QP	
6	0.2620	21.63	10.35	31.98	51.37	-19.39	AVG	
7	0.4300	23.20	10.61	33.81	57.25	-23.44	QP	
8	0.4300	13.24	10.61	23.85	47.25	-23.40	AVG	
9	3.9900	24.69	9.97	34.66	56.00	-21.34	QP	
10	3.9900	11.39	9.97	21.36	46.00	-24.64	AVG	
11	10.0580	28.54	9.97	38.51	60.00	-21.49	QP	
12	10.0580	19.55	9.97	29.52	50.00	-20.48	AVG	

*:Maximum data x:Over limit !:over margin

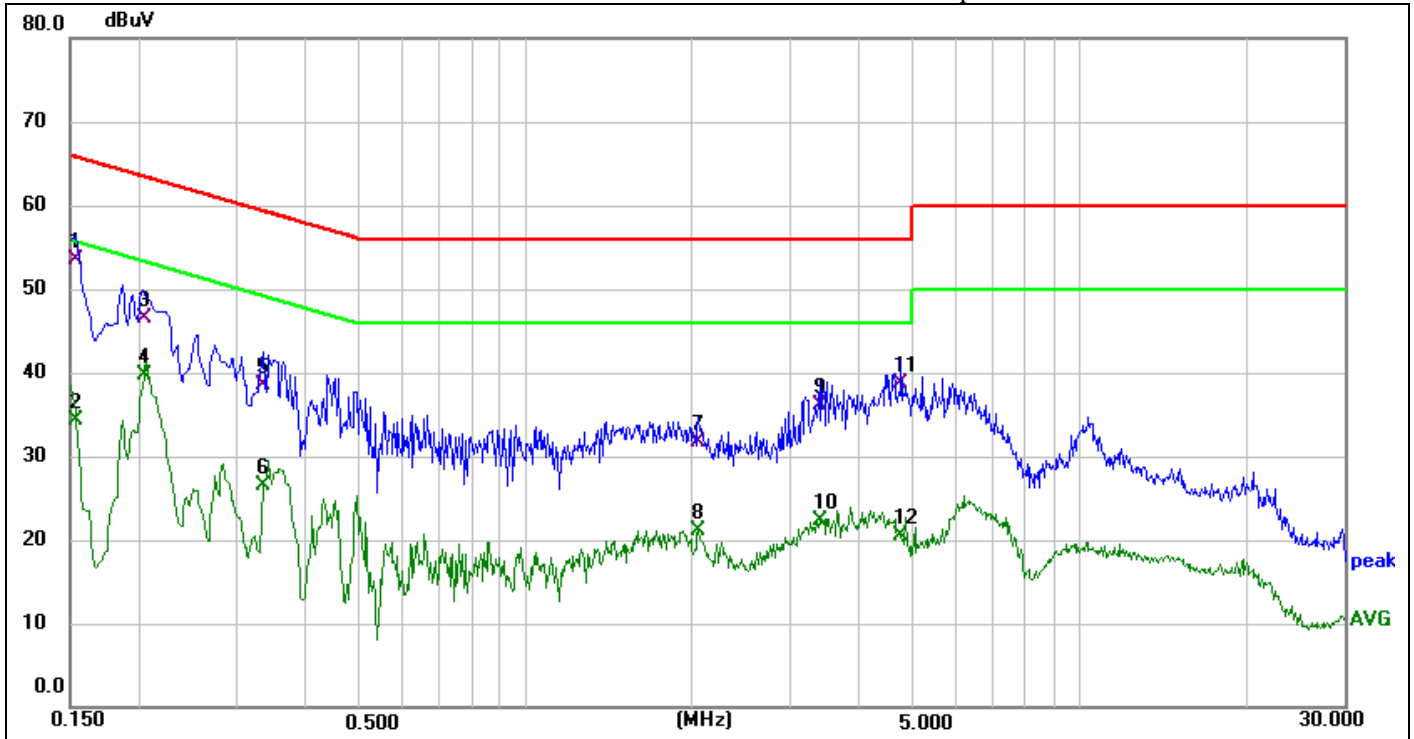

Site:	843	Phase:	N	Temperature(C):	23.5(C)
Limit:	FCC PART 15C Conduction(QP)	Test Time:	2023-03-15 21:22:51	Humidity(%):	52.6%
EUT:	Wi-Fi + BLE Stick	Power Rating:	DC 5V	Test Engineer:	Sunshine
M/N.:	EESW-A413				
Mode:	Pi/4-DQPSK TX 2402MHz				
Note:					

No.	Frequency (MHz)	Reading Level(dBuV)	Factor (dB)	Measurement(dBuV)	Limit (dBuV)	Over (dB)	Detector	Comment
1 *	0.1539	43.66	9.90	53.56	65.79	-12.23	QP	
2	0.1539	24.37	9.90	34.27	55.79	-21.52	AVG	
3	0.2040	36.37	10.10	46.47	63.45	-16.98	QP	
4	0.2040	29.54	10.10	39.64	53.45	-13.81	AVG	
5	0.3339	28.33	10.26	38.59	59.35	-20.76	QP	
6	0.3339	16.25	10.26	26.51	49.35	-22.84	AVG	
7	2.0460	21.74	10.03	31.77	56.00	-24.23	QP	
8	2.0460	11.03	10.03	21.06	46.00	-24.94	AVG	
9	3.3900	26.13	10.06	36.19	56.00	-19.81	QP	
10	3.3900	12.26	10.06	22.32	46.00	-23.68	AVG	
11	4.7580	28.77	9.96	38.73	56.00	-17.27	QP	
12	4.7580	10.48	9.96	20.44	46.00	-25.56	AVG	

*:Maximum data x:Over limit !:over margin

6.5 Conducted Measurement Photos:



7. Radiated Emission Test

7.1 Measurement Procedure

1. The testing follows the guidelines in ANSI C63.10-2013.
2. Below 1000MHz, The EUT was placed on a turn table which is 0.8m above ground plane. And above 1000MHz, The EUT was placed on a styrofoam table which is 1.5m above ground plane.
3. The EUT was set 3 meters from the interference receiving antenna, which was mounted on the top of a variable height antenna tower.
4. The EUT was arranged to its worst case and then tune the Antenna tower (From 1m to 4m) and turntable (from 0 degree to 360 degrees) to find the maximum reading. A pre-amp and a high pass filter are used for the test in order to get better signal level.
5. For measurement below 1GHz, if the emission level of the EUT measured by the peak detector is 3dB lower than the applicable limit, the peak emission level will be reported. Otherwise, the emission measurement will be repeated using the quasi-peak detector and reported.
6. Final measurement (Above 1GHz): The frequency range will be divided into different sub ranges depending of the frequency range of the used horn antenna. The EMI Receiver set to peak and average mode and a resolution bandwidth of 1MHz. The measurement will be performed in horizontal and vertical polarization of the measuring antenna and while rotating the EUT in its vertical axis in the range of 0 degree to 360 degree in order to have the antenna inside the cone of radiation.
7. Test Procedure of measurement (For Above 1GHz):
 - 1) Monitor the frequency range at horizontal polarization and move the antenna over all sides of the EUT(if necessary move the EUT to another orthogonal axis).
 - 2) Change the antenna polarization and repeat 1) with vertical polarization.
 - 3) Make a hardcopy of the spectrum.
 - 4) Measure the frequency of the detected emissions with a lower span and resolution bandwidth to increase the accuracy and note the frequency value.
 - 5) Change the analyser mode to Clear/ Write and found the cone of emission.
 - 6) Rotate and move the EUT, so that the measuring distance can be enlarged to 3m and the antenna will be still inside the cone of emission.
 - 7) Measure the level of the detected frequency with the correct resolution bandwidth, with the antenna polarization and azimuth and the peak and average detector, which causes the maximum emission.
 - 8) Repeat steps 1) to 7) for the next antenna spot if the EUT is larger than the antenna beamwidth.

Use the following spectrum analyzer settings:

When spectrum scanned from 30MHz to 1GHz setting resolution bandwidth 120KHz and video bandwidth 300KHz:

EMI Test Receiver	Setting
Attenuation	Auto
RB	120KHz
VB	300KHz
Detector	QP
Trace	Max hold

When spectrum scanned above 1GHz setting resolution bandwidth 1MHz, video bandwidth 3MHz:

EMI Test Receiver	Setting
Attenuation	Auto
RB	1MHz
VB	3MHz
Detector	Peak
Trace	Max hold

When spectrum scanned above 1GHz setting resolution bandwidth 1MHz, video bandwidth 10Hz:

EMI Test Receiver	Setting
Attenuation	Auto
RB	1MHz
VB	10Hz
Detector	Average
Trace	Max hold

For Average Measurement:

VBW=10Hz, when duty cycle is no less than 98 percent.

$VBW \geq 1/T$, when duty cycle is less than 98 percent where T is the minimum transmission duration over which the transmitter is on and is transmitting at its maximum power control level for the tested mode of operation.

Band	Duty Cycle(%)	T(μ s)	1/T(KHz)	Average Correction Factor	VBW Setting
2402-2480	100	-	-	0	10Hz

7.2 Test SET-UP (Block Diagram of Configuration)

(A) Radiated Emission Test Set-Up, Frequency Below 30MHz

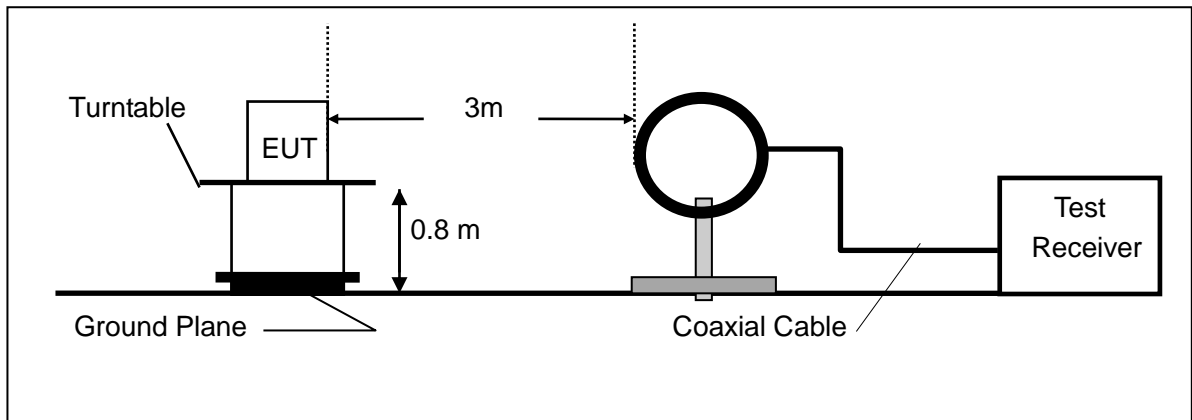

(B) Radiated Emission Test Set-Up, Frequency Below 1000MHz

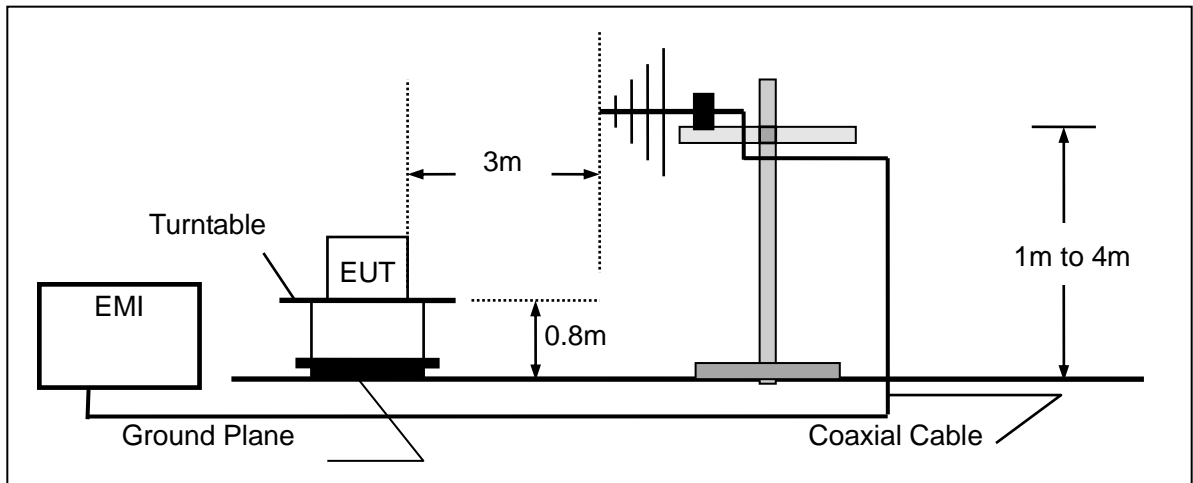

(C) Radiated Emission Test Set-Up, Frequency above 1000MHz

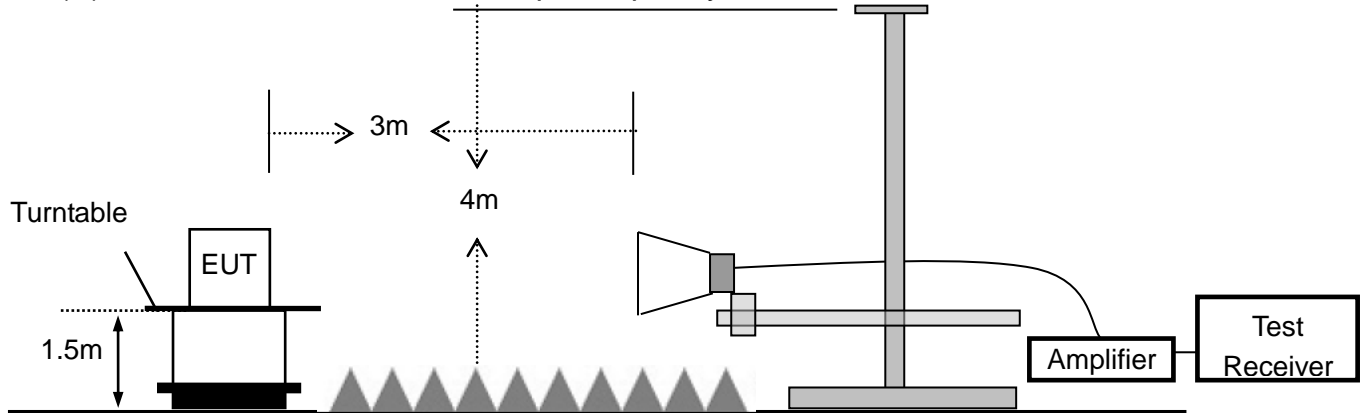

7.3 Measurement Equipment Used:

3m Radiated Emission Measurement 30M-1G

Item	Instr.Code	Kind of Equipment	Manufacturer	Type No.	Serial No.	Calibrated until
1	AN-E023	EMI Test Receiver	Rohde & Schwarz	ESPI7	100502	2023-10-07
2	AN-E061	Pre-Amplifier	Anritsu	MH648A	M57886	2023-05-12
3	AN-E076	Bilog Antenna	Schwarzbeck	VULB9163	VULB9163-1290	2023-12-11
4	AN-E062	RF Cable	N/A	ZT06S-NJ-NJ-11M	19060398	2023-05-12
5	AN-E063	RF Cable	N/A	ZT06S-NJ-NJ-0.5M	19060400	2023-05-12
6	AN-E064	RF Cable	N/A	ZT06S-NJ-NJ-2.5M	19060404	2023-05-12
7	AN-E056	3m Semi-anechoic Chamber	chengyu	9m*6m*6m	N/A	2024-11-11
8	AN-E069	Test Software	Farad	EZ-EMC (Ver.FA-03A2 RE)	N/A	N/A

3m Radiated Emission Measurement 1G-18G

Item	Instr.Code	Kind of Equipment	Manufacturer	Type No.	Serial No.	Calibrated until
1	AN-E023	EMI Test Receiver	Rohde & Schwarz	ESPI7	100502	2023-10-07
2	AN-E015	Low noise Amplifiers	A-INFO	LA1018N4009	J1013130524001	2023-05-12
3	AN-E014	Horn antenna	A-INFO	LB-10180-SF	J2031090612123	2024-05-14
4	AN-E065	RF Cable	N/A	ZT26-NJ-NJ-11M	19060401	2023-05-12
5	AN-E067	RF Cable	N/A	ZT26-NJ-NJ-2.5M	19060402	2023-05-12
6	AN-E068	RF Cable	N/A	ZT26-NJ-NJ-0.5M	19060403	2023-05-12
7	AN-E056	3m Semi-anechoic Chamber	chengyu	9m*6m*6m	N/A	2024-11-12
8	AN-E069	Test Software	Farad	EZ-EMC (Ver.FA-03A2 RE)	N/A	N/A

7.4 Radiated emission limit

The emissions from an intentional radiator shall not exceed the field strength levels specified in the following table 15.209(a):

Frequencies (MHz)	Field Strength (micorvolts/meter)	Measurement Distance (meters)
0.009~0.490	2400/F(KHz)	300
0.490~1.705	24000/F(KHz)	30
1.705~30.0	30	30
30~88	100	3
88~216	150	3
216~960	200	3
Above 960	500	3

15.205 Restricted bands of operation

MHz	MHz	MHz	GHz
0.090 - 0.110	16.42 - 16.423	399.9 - 410	4.5 - 5.15
¹ 0.495 - 0.505	16.69475 - 16.69525	608 - 614	5.35 - 5.46
2.1735 - 2.1905	16.80425 - 16.80475	960 - 1240	7.25 - 7.75
4.125 - 4.128	25.5 - 25.67	1300 - 1427	8.025 - 8.5
4.17725 - 4.17775	37.5 - 38.25	1435 - 1626.5	9.0 - 9.2
4.20725 - 4.20775	73 - 74.6	1645.5 - 1646.5	9.3 - 9.5
6.215 - 6.218	74.8 - 75.2	1660 - 1710	10.6 - 12.7
6.26775 - 6.26825	108 - 121.94	1718.8 - 1722.2	13.25 - 13.4
6.31175 - 6.31225	123 - 138	2200 - 2300	14.47 - 14.5
8.291 - 8.294	149.9 - 150.05	2310 - 2390	15.35 - 16.2
8.362 - 8.366	156.52475 - 156.52525	2483.5 - 2500	17.7 - 21.4
8.37625 - 8.38675	156.7 - 156.9	2690 - 2900	22.01 - 23.12
8.41425 - 8.41475	162.0125 - 167.17	3260 - 3267	23.6 - 24.0
12.29 - 12.293	167.72 - 173.2	3332 - 3339	31.2 - 31.8
12.51975 - 12.52025	240 - 285	3345.8 - 3358	36.43 - 36.5
12.57675 - 12.57725	322 - 335.4	3600 - 4400	(²)

- Remark 1. Emission level in dBuV/m=20 log (uV/m)
- :
- Measurement was performed at an antenna to the closed point of EUT distance of meters.
 - Only spurious frequency is permitted to locate within the Restricted Bands specified in provision of ξ 15.205, and the emissions located in restricted bands also comply with 15.209 limit.

7.5 Measurement Result

Below 30MHz:

Operation Mode:	TX	Test Date :	2023-3-13
Frequency Range:	9KHz~30MHz	Temperature :	25°C
Test Result:	PASS	Humidity :	58 %
Measured Distance:	3m	Test By:	Best

Freq. (MHz)	Ant.Pol. H/V	Emission Level (dBuV/m)	Limit 3m (dBuV/m)	Over (dB)
--	--	--	--	--

Note: The low frequency, which started from 9KHz-30MHz, was pre-scanned and the result which was 20dB lower than the limit line per 15.31(o) was not reported.

Below 1000MHz:

Pass.

The data of the mode (GFSK 2402MHz) are recorded in the following pages.

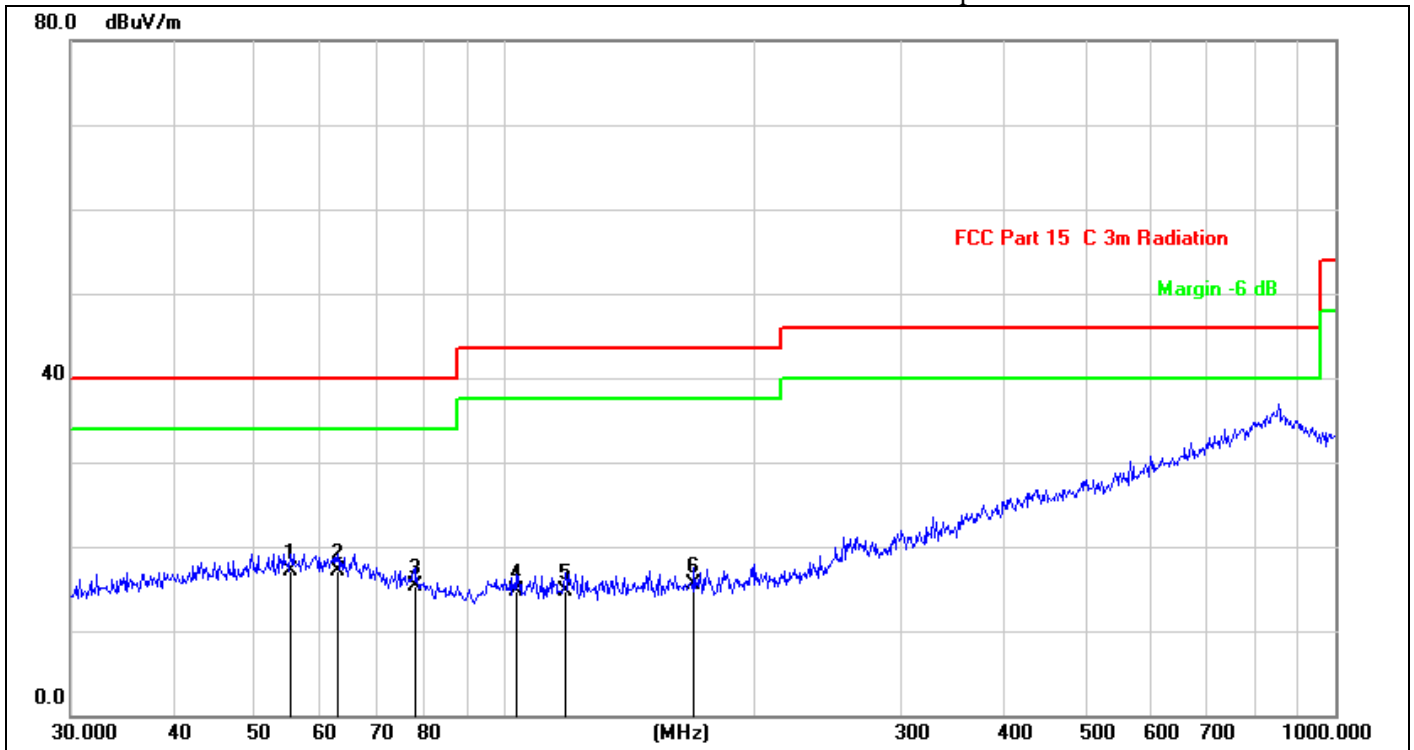

Site:	LAB	Antenna::Horizontal	Temperature(C):25.0(C)
Limit:	FCC Part 15 C 3m Radiation		Humidity(%):54.1%
EUT:	Wi-Fi + BLE Stick	Test Time:	2023/03/13 20:00:22
M/N.:	EESW-A413	Power Rating:	DC 5V
Mode:	GFSK 2402MHz	Test Engineer:	Sunshine
Note:			

No.	Frequency (MHz)	Reading (dBuV)	Factor (dB/m)	Level (dBuV/m)	Limit (dBuV/m)	Margin (dB)	Det.	Remark
1 *	55.2207	26.24	-9.08	17.16	40.00	-22.84	QP	
2	62.8708	26.00	-8.91	17.09	40.00	-22.91	QP	
3	77.8654	27.45	-12.05	15.40	40.00	-24.60	QP	
4	103.0800	26.48	-11.78	14.70	43.50	-28.80	QP	
5	118.1862	26.63	-11.83	14.80	43.50	-28.70	QP	
6	169.0054	27.04	-11.56	15.48	43.50	-28.02	QP	

Note: 1. Result Level = Read Level+ Antenna Factor+ Cable Loss- Amp. Factor

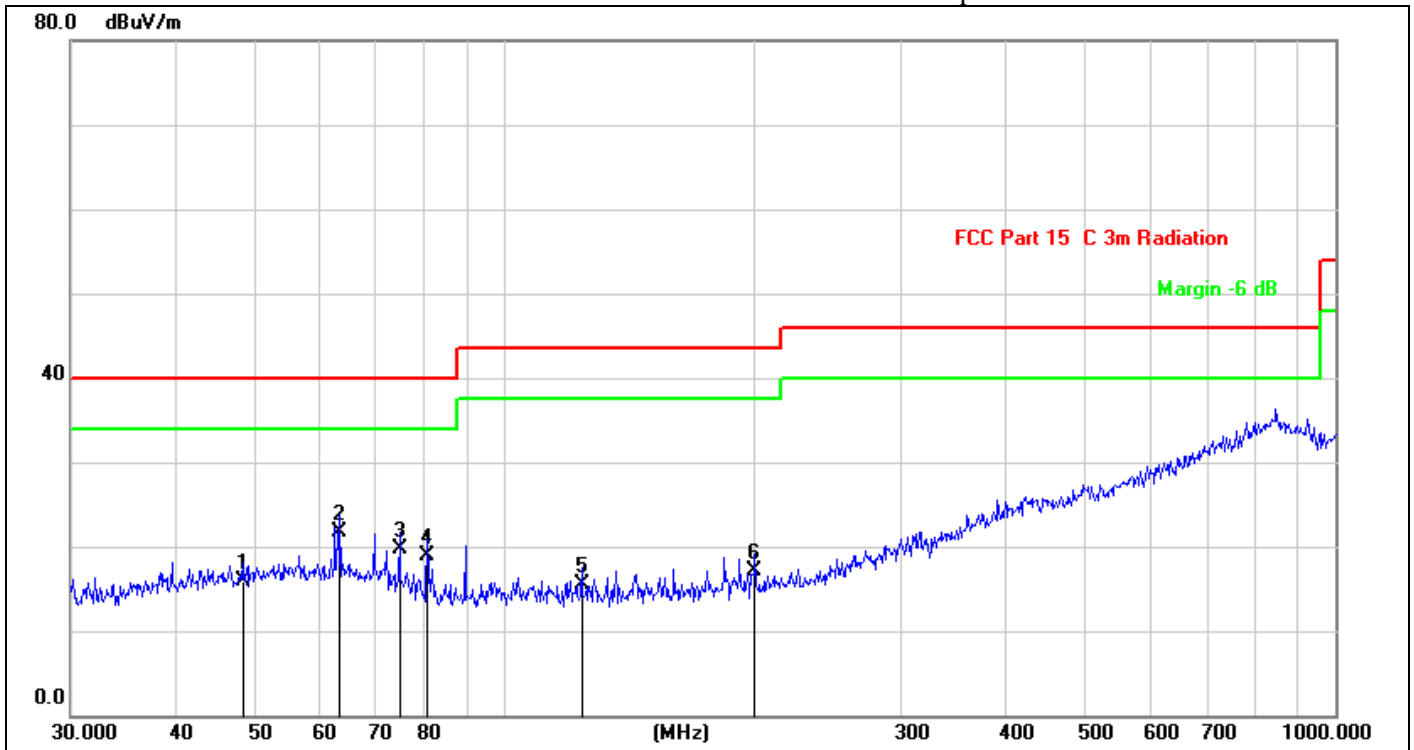

Site:	LAB	Antenna::	Vertical	Temperature(C):	25.0(C)
Limit:	FCC Part 15 C 3m Radiation			Humidity(%):	54.1%
EUT:	Wi-Fi + BLE Stick	Test Time:		2023/03/13 19:59:06	
M/N.:	EESW-A413	Power Rating:		DC 5V	
Mode:	GFSK 2402MHz	Test Engineer:		Sunshine	
Note:					

No.	Frequency (MHz)	Reading (dBuV)	Factor (dB/m)	Level (dBuV/m)	Limit (dBuV/m)	Margin (dB)	Det.	Remark
1	48.3318	25.92	-9.92	16.00	40.00	-24.00	QP	
2 *	63.3132	30.70	-8.97	21.73	40.00	-18.27	QP	
3	74.6569	30.98	-11.28	19.70	40.00	-20.30	QP	
4	80.6442	31.42	-12.43	18.99	40.00	-21.01	QP	
5	123.6985	27.13	-11.63	15.50	43.50	-28.00	QP	
6	199.9856	28.40	-11.29	17.11	43.50	-26.39	QP	

Note: 1. Result Level = Read Level+ Antenna Factor+ Cable Loss- Amp. Factor

Above 1000MHz~10th Harmonics:

Operation Mode: TX Mode (CH00: 2402MHz) Test Date : 2023-03-13
 Frequency Range: 1-25GHz Temperature : 25°C
 Test Result: PASS Humidity : 58 %
 Measured Distance: 3m Test By: Best

Freq. (MHz)	Ant. Pol. H/V	Reading Level(dBuV/m)		Correct Factor dB	Emission Level(dBuV/m)		Limit 3m(dBuV/m)		Over(dB)	
		PK	AV		PK	AV	PK	AV	PK	AV
4804	V	94.37	73.21	-32.3	62.07	40.91	74	54	-11.93	-13.09
7206	V	95.18	73.64	-37.2	57.98	36.44	74	54	-16.02	-17.56
9608	V	94.28	73.29	-39.8	54.48	33.49	74	54	-19.52	-20.51
12010	V	96.31	74.28	-40.5	55.81	33.78	74	54	-18.19	-20.22
14412	V	97.28	75.33	-41.7	55.58	33.63	74	54	-18.42	-20.37
16814	V	95.36	74.86	-40	55.36	34.86	74	54	-18.64	-19.14
4804	H	93.35	74.57	-31.6	61.75	42.97	74	54	-12.25	-11.03
7206	H	94.28	74.38	-35.5	58.78	38.88	74	54	-15.22	-15.12
9608	H	93.27	74.69	-38.3	54.97	36.39	74	54	-19.03	-17.61
12010	H	94.88	74.29	-39	55.88	35.29	74	54	-18.12	-18.71
14412	H	96.85	74.38	-42	54.85	32.38	74	54	-19.15	-21.62
16814	H	92.35	73.05	-39.3	53.05	33.75	74	54	-20.95	-20.25

Other harmonics emissions are lower than 20dB below the allowable limit.

- Note:**
- (1) All Readings are Peak Value and AV.
 - (2) Emission Level= Reading Level+ Probe Factor +Cable Loss.
 - (3) The average measurement was not performed when the peak measured data under the limit of average detection.
 - (4) Measuring frequencies from 1GHz to 25GHz.

Operation Mode: TX Mode (CH19: 2440MHz) Test Date : 2023-03-13
 Frequency Range: 1-25GHz Temperature : 25°C
 Test Result: PASS Humidity : 58 %
 Measured Distance: 3m Test By: Best

Freq. (MHz)	Ant. Pol. H/V	Reading Level(dBuV/m)		Correct Factor dB	Emission Level(dBuV/m)		Limit 3m(dBuV/m)		Margin(dB)	
		PK	AV		PK	AV	PK	AV	PK	AV
4880	V	96.58	76.65	-32.3	64.28	44.35	74	54	-9.72	-9.65
7320	V	96.25	77.59	-37.2	59.05	40.39	74	54	-14.95	-13.61
9760	V	97.68	78.02	-39.8	57.88	38.22	74	54	-16.12	-15.78
12200	V	96.58	77.35	-40.5	56.08	36.85	74	54	-17.92	-17.15
14640	V	96.35	78.2	-41	55.35	37.2	74	54	-18.65	-16.8
17080	V	94.36	76.88	-41.1	53.26	35.78	74	54	-20.74	-18.22
4880	H	94.52	75.35	-31.6	62.92	43.75	74	54	-11.08	-10.25
7320	H	94.68	74.62	-35.5	59.18	39.12	74	54	-14.82	-14.88
9760	H	95.36	77.22	-38.3	57.06	38.92	74	54	-16.94	-15.08
12200	H	94.68	75.96	-39	55.68	36.96	74	54	-18.32	-17.04
14640	H	95.31	77.21	-42	53.31	35.21	74	54	-20.69	-18.79
17080	H	96.13	76.83	-41.5	54.63	35.33	74	54	-19.37	-18.67

Other harmonics emissions are lower than 20dB below the allowable limit.

- Note:**
- (1) All Readings are Peak Value and AV.
 - (2) Emission Level= Reading Level+ Probe Factor +Cable Loss.
 - (3) The average measurement was not performed when the peak measured data under the limit of average detection.
 - (4) Measuring frequencies from 1GHz to 25GHz.

Operation Mode: TX Mode (CH39: 2480MHz) Test Date : 2023-03-13
 Frequency Range: 1-25GHz Temperature : 25°C
 Test Result: PASS Humidity : 58 %
 Measured Distance: 3m Test By: Best

Freq. (MHz)	Ant. Pol. H/V	Reading Level(dBuV/m)		Correct Factor dB	Emission Level(dBuV/m)		Limit 3m(dBuV/m)		Margin(dB)	
		PK	AV		PK	AV	PK	AV	PK	AV
4960	V	96.32	77.58	-32.3	64.02	45.28	74	54	-9.98	-8.72
7440	V	96.48	77.35	-37.2	59.28	40.15	74	54	-14.72	-13.85
9920	V	97.01	78.25	-39.8	57.21	38.45	74	54	-16.79	-15.55
12400	V	96.58	77.02	-40.5	56.08	36.52	74	54	-17.92	-17.48
14880	V	96.86	78.12	-41	55.86	37.12	74	54	-18.14	-16.88
17360	V	95.21	76.14	-41.1	54.11	35.04	74	54	-19.89	-18.96
4960	H	95.35	74.59	-31.6	63.75	42.99	74	54	-10.25	-11.01
7440	H	94.56	74.68	-35.5	59.06	39.18	74	54	-14.94	-14.82
9920	H	94.36	75.28	-38.3	56.06	36.98	74	54	-17.94	-17.02
12400	H	94.63	75.12	-39	55.63	36.12	74	54	-18.37	-17.88
14880	H	95.02	75.21	-42	53.02	33.21	74	54	-20.98	-20.79
17360	H	94.61	76.32	-41.5	53.11	34.82	74	54	-20.89	-19.18

Other harmonics emissions are lower than 20dB below the allowable limit.

- Note:**
- (1) All Readings are Peak Value and AV.
 - (2) Emission Level= Reading Level+ Probe Factor +Cable Loss.
 - (3) The average measurement was not performed when the peak measured data under the limit of average detection.
 - (4) Measuring frequencies from 1GHz to 25GHz.

7.6 Radiated Measurement Photos:



8. 6dB Bandwidth Measurement

8.1 Measurement Procedure

The EUT was operating in Bluetooth mode or could be controlled its channel. Printed out the test result from the spectrum by hard copy function.

8.2 Test SET-UP (Block Diagram of Configuration)

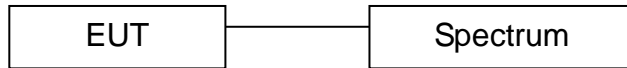

8.3 Measurement Equipment Used:

Item	Instr.Code	Kind of Equipment	Manufacturer	Type No.	Serial No.	Calibrated until
1	AN-E037	Spectrum Analyzer	KEYSIGHT	N9020A	MY61250185	2023-10-07
2	AN-E040	WIDEBAND RADIO COMMUNICATION	Rohde & Schwarz	CMW500	157423	2023-10-07
3	AN-E039	MXG Vector Signal Generator	KEYSIGHT	N5182B	MY61250185	2023-10-07
4	AN-E038	EXG Analog Signal Generator	KEYSIGHT	N5173B	My61252603	2023-10-07
5	AN-E041	USB RF Power sensor	RadiPower	RPR3006W	17I00015SNO88	2023-10-07
6	AN-E042	USB RF Power sensor	RadiPower	RPR3006W	17I00015SNO89	2023-10-07
7	/	RF Test Software	MWRF-test	MTS 8310	N/A	N/A
8	AN-E092	Radio Frequency control box	MWRF-test	MW200-RFCB	MW220111ANCI	2023-05-12
9	AN-E093	Radio Frequency control box	MWRF-test	MW200-RFCB 2#	/	2023-05-12

Remark: The temporary antenna connector is soldered on the PCB board in order to perform conducted tests and this temporary antenna connector is listed in the equipment list.

8.4 Limit

The minimum 6dB bandwidth shall be at least 500kHz.

8.5 Measurement Results:

Refer to attached data chart.

Spectrum Detector:	PK	Test Date :	2023-03-13
Test By:	Best	Temperature :	24 °C
Test Result:	PASS	Humidity :	53 %

Condition	Mode	Frequency (MHz)	Antenna	-6 dB Bandwidth (MHz)	Limit -6 dB Bandwidth (MHz)	Verdict
NVNT	BLE 1M	2402	Ant1	0.639	0.5	Pass
NVNT	BLE 1M	2440	Ant1	0.635	0.5	Pass
NVNT	BLE 1M	2480	Ant1	0.64	0.5	Pass

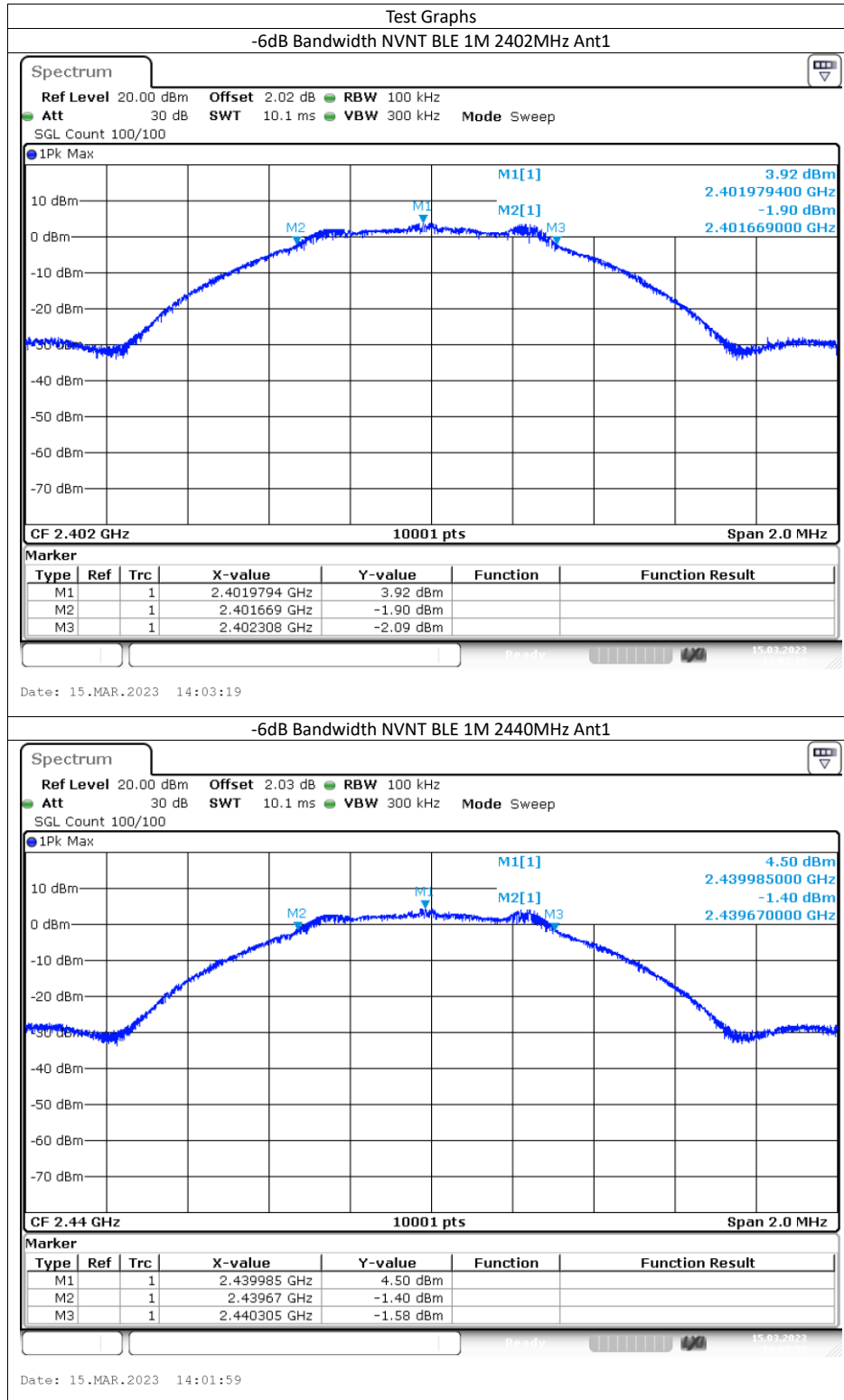

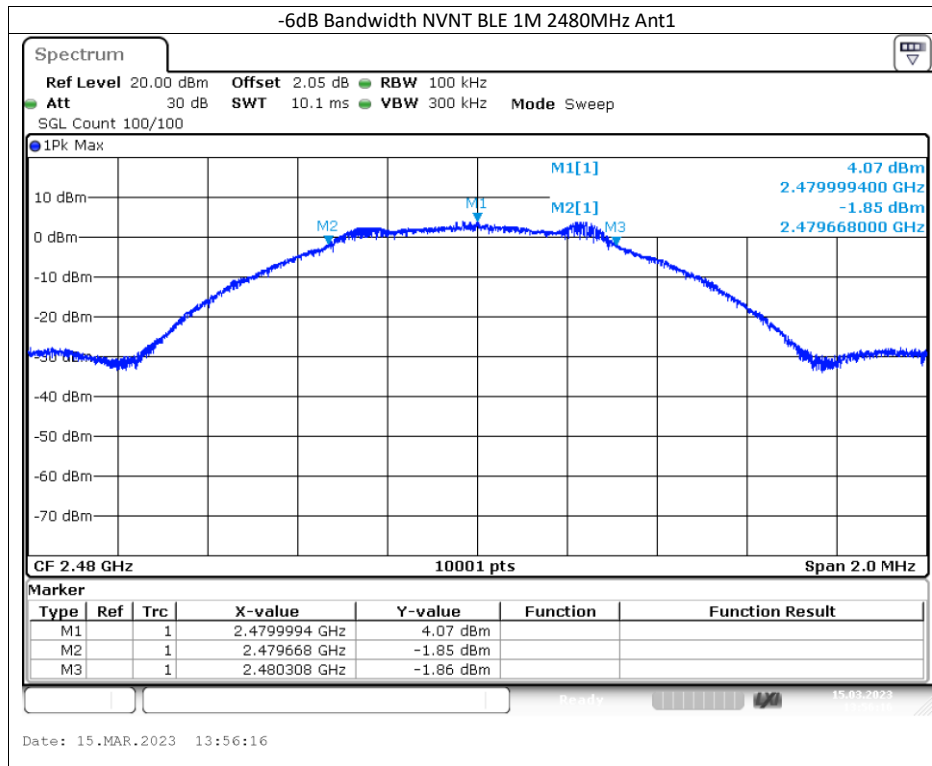

9. MAXIMUM PEAK OUTPUT POWER TEST

9.1 Measurement Procedure

- The Transmitter output (antenna port) was connected to the spectrum Analyzer.
- Turn on the EUT and then record the peak power value.
- Repeat above procedures on all channels needed to be tested.

9.2 Test SET-UP (Block Diagram of Configuration)

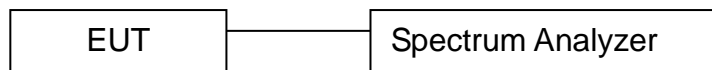

9.3 Measurement Equipment Used:

Item	Instr.Code	Kind of Equipment	Manufacturer	Type No.	Serial No.	Calibrated until
1	AN-E037	Spectrum Analyzer	KEYSIGHT	N9020A	MY61250185	2023-10-07
2	AN-E040	WIDEBAND RADIO COMMUNICATION	Rohde & Schwarz	CMW500	157423	2023-10-07
3	AN-E039	MXG Vector Signal Generator	KEYSIGHT	N5182B	MY61250185	2023-10-07
4	AN-E038	EXG Analog Signal Generator	KEYSIGHT	N5173B	My61252603	2023-10-07
5	AN-E041	USB RF Power sensor	RadiPower	RPR3006W	17I00015SNO88	2023-10-07
6	AN-E042	USB RF Power sensor	RadiPower	RPR3006W	17I00015SNO89	2023-10-07
7	/	RF Test Software	MWRF-test	MTS 8310	N/A	N/A
8	AN-E092	Radio Frequency control box	MWRF-test	MW200-RFCB	MW220111ANCI	2023-05-12
9	AN-E093	Radio Frequency control box	MWRF-test	MW200-RFCB 2#	/	2023-05-12

Remark: The temporary antenna connector is soldered on the PCB board in order to perform conducted tests and this temporary antenna connector is listed in the equipment list.

9.4 Peak Power output limit

The maximum peak power shall be less 1Watt.

9.5 Measurement Results:

Refer to attached data chart.

Spectrum Detector: PK Test Date : 2023-03-13
Test By: Best Temperature : 24 °C
Test Result: PASS Humidity : 53 %

Condition	Mode	Frequency (MHz)	Antenna	Conducted Power (dBm)	Duty Factor (dB)	Total Power (dBm)	Limit (dBm)	Verdict
NVNT	BLE 1M	2402	Ant1	4.31	0	4.31	30	Pass
NVNT	BLE 1M	2440	Ant1	4.89	0	4.89	30	Pass
NVNT	BLE 1M	2480	Ant1	4.48	0	4.48	30	Pass

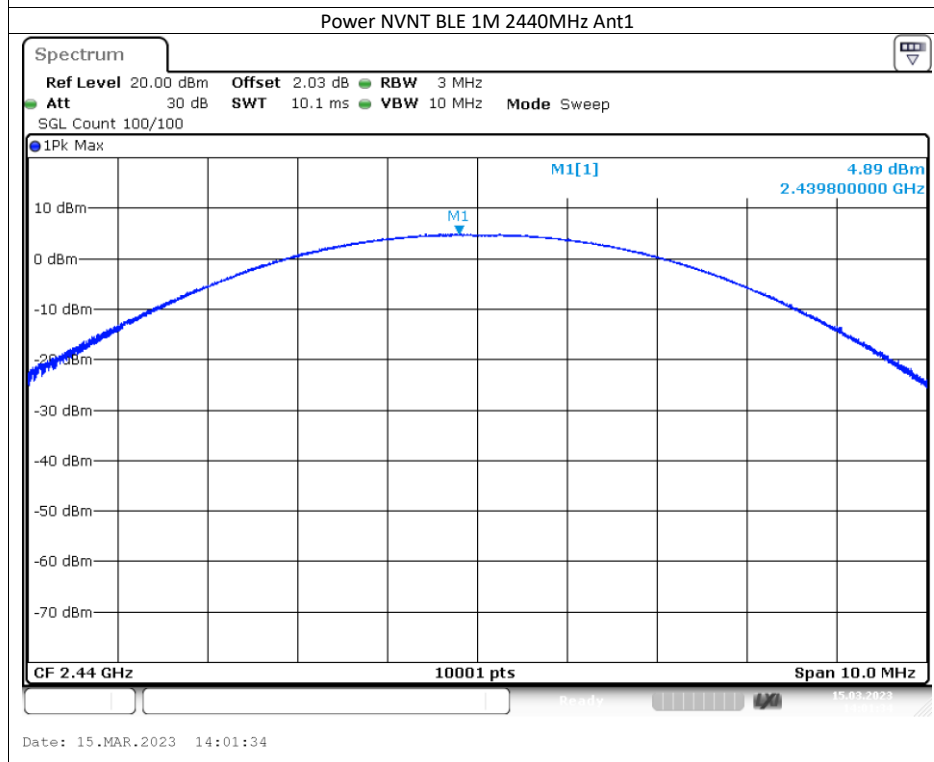
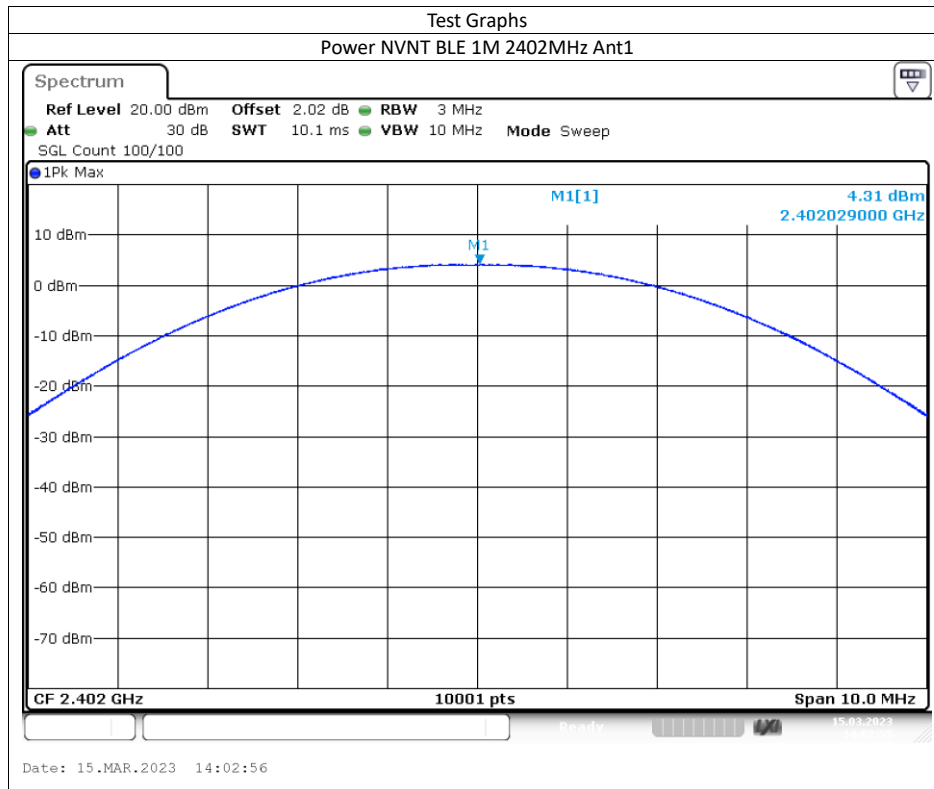

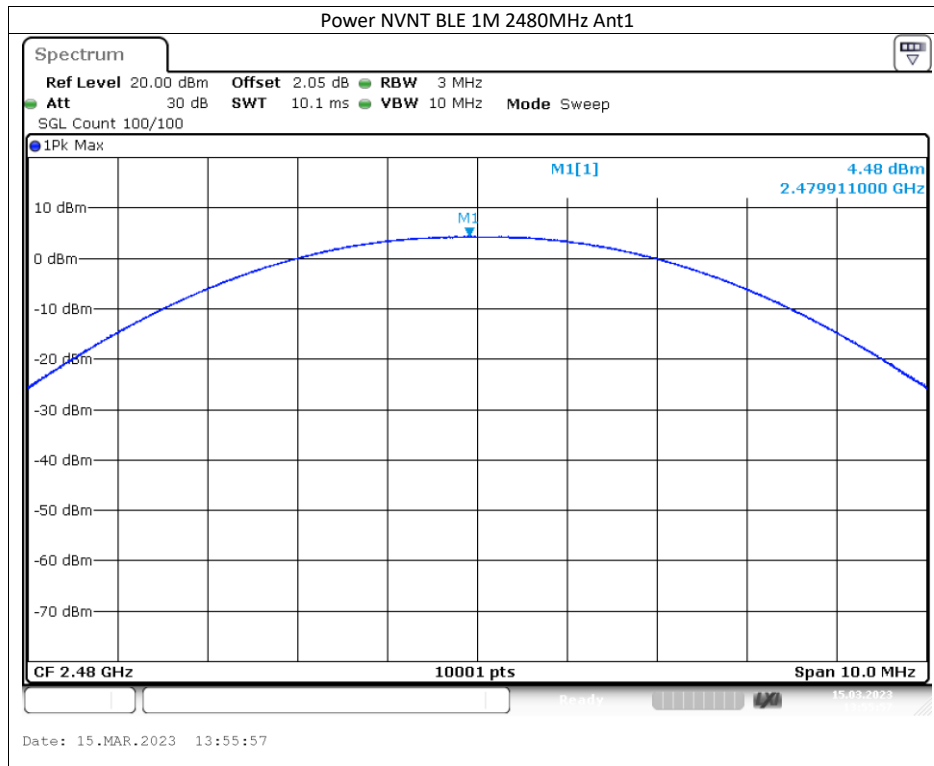

10. Power Spectral Density Measurement

10.1 Measurement Procedure

The EUT was operating in Bluetooth mode or could be controlled its channel. Printed out the test result from the spectrum by hard copy function.

10.2 Test SET-UP (Block Diagram of Configuration)

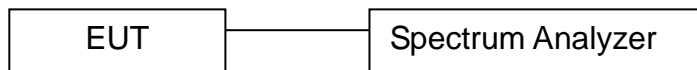

10.3 Measurement Equipment Used:

Item	Instr.Code	Kind of Equipment	Manufacturer	Type No.	Serial No.	Calibrated until
1	AN-E037	Spectrum Analyzer	KEYSIGHT	N9020A	MY61250185	2023-10-07
2	AN-E040	WIDEBAND RADIO COMMUNICATION	Rohde & Schwarz	CMW500	157423	2023-10-07
3	AN-E039	MXG Vector Signal Generator	KEYSIGHT	N5182B	MY61250185	2023-10-07
4	AN-E038	EXG Analog Signal Generator	KEYSIGHT	N5173B	My61252603	2023-10-07
5	AN-E041	USB RF Power sensor	RadiPower	RPR3006W	17I000155NO88	2023-10-07
6	AN-E042	USB RF Power sensor	RadiPower	RPR3006W	17I000155NO89	2023-10-07
7	/	RF Test Software	MWRF-test	MTS 8310	N/A	N/A
8	AN-E092	Radio Frequency control box	MWRF-test	MW200-RFCB	MW220111ANCI	2023-05-12
9	AN-E093	Radio Frequency control box	MWRF-test	MW200-RFCB 2#	/	2023-05-12

Remark: The temporary antenna connector is soldered on the PCB board in order to perform conducted tests and this temporary antenna connector is listed in the equipment list.

10.4 Measurement Procedure

10.4.1 The RF output of EUT was connected to the spectrum analyzer by RF cable and attenuator. The path loss was compensated to the results for each measurement.

10.4.2. Set to the maximum power setting and enable the EUT transmit continuously.

10.4.3. Make the measurement with the spectrum analyzer's resolution bandwidth (RBW) = 3 kHz. Video bandwidth VBW = 10 kHz In order to make an accurate measurement, set the span to 1.5 times DTS Channel Bandwidth. (6dB BW)

10.4.4. Detector = peak, Sweep time = auto couple, Trace mode = max hold, Allow trace to fully stabilize. Use the peak marker function to determine the maximum power level.

10.4.5. Measure and record the results in the test report.

10.4.6. The Measured power density (dBm)/ 100KHz is a reference level and used as 20dBc down limit line for Conducted Band Edges and Conducted Spurious Emission.

10.5 Measurement Results:

The following table is the setting of spectrum analyzer.

Spectrum analyzer	Setting
Attenuation	Auto
Span Frequency	Set the span to 1.5 times the DTS bandwidth.
RB	3KHz
VB	10KHz
Detector	Peak
Trace	Max hold
Sweep Time	Automatic

Refer to attached data chart.

Spectrum Detector:	PK	Test Date :	2023-03-13
Test By:	Best	Temperature :	24 °C
Test Result:	PASS	Humidity :	53 %

Condition	Mode	Frequency (MHz)	Antenna	Conducted PSD (dBm/3kHz)	Duty Factor (dB)	Total PSD (dBm/3kHz)	Limit (dBm/3kHz)	Verdict
NVNT	BLE 1M	2402	Ant1	-12.27	0	-12.27	8	Pass
NVNT	BLE 1M	2440	Ant1	-11.73	0	-11.73	8	Pass
NVNT	BLE 1M	2480	Ant1	-11.74	0	-11.74	8	Pass

Note:

1. Measured power density(dBm) has offset with cable loss.
2. The measured power density(dBm)/100KHz is reference level and used as 20dBc down for Conducted Band Edges and Conducted Spurious Emission limit line.

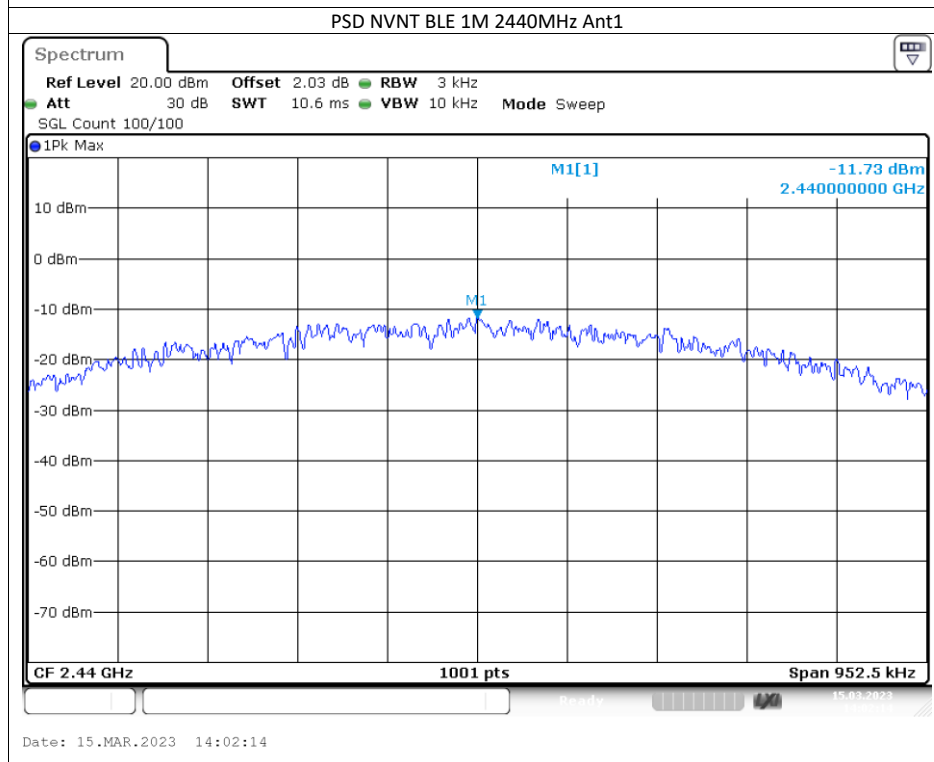
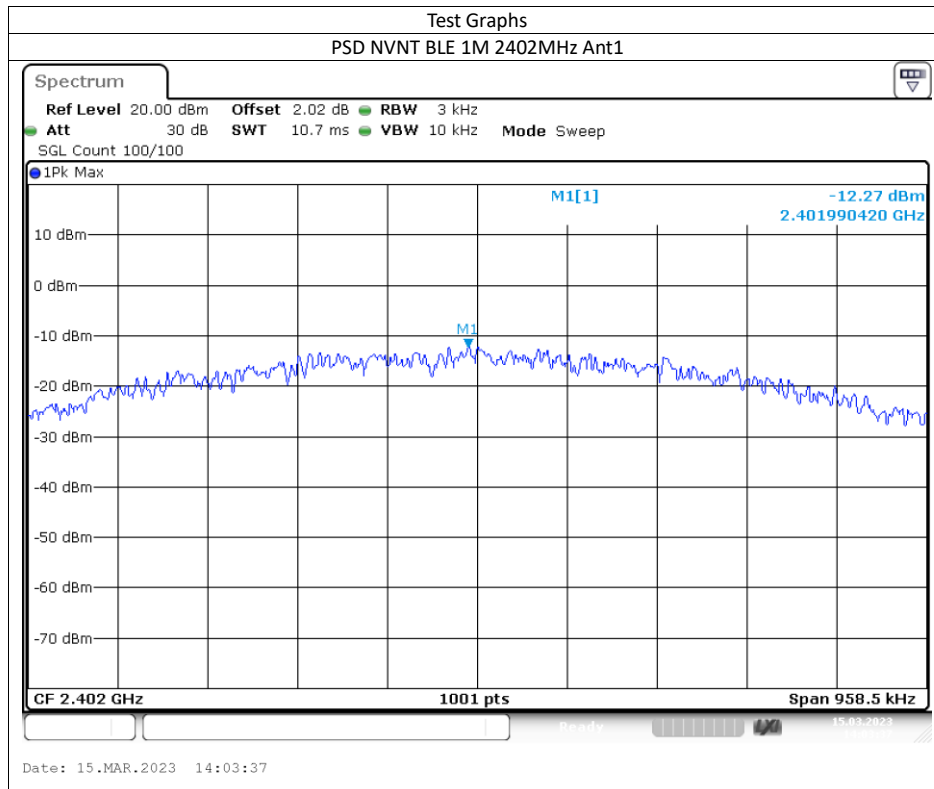

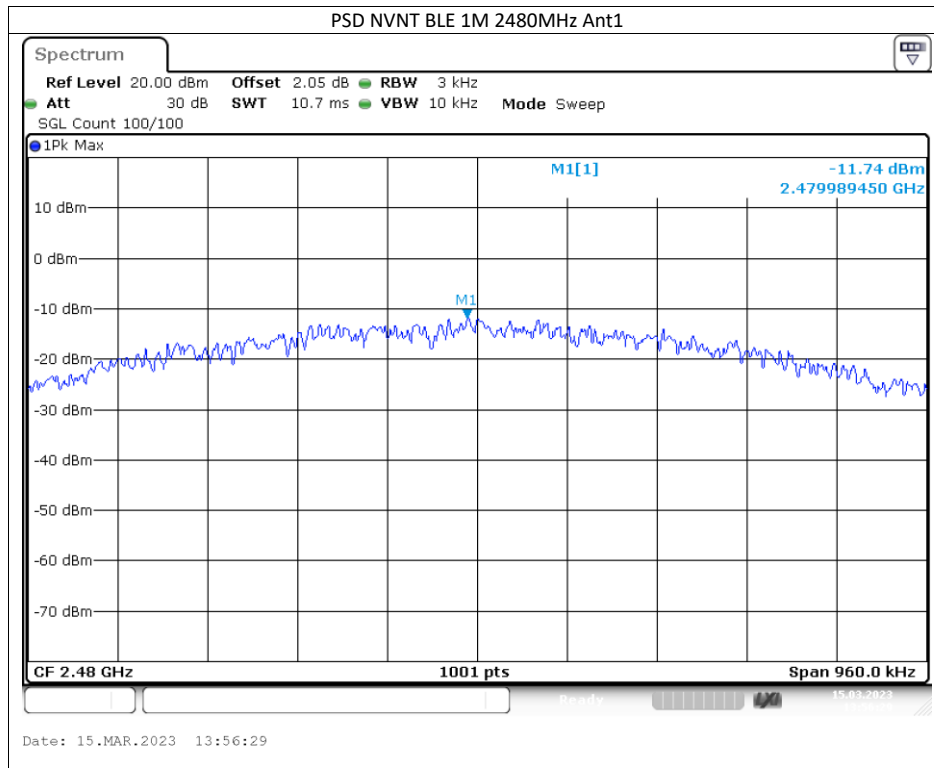

11. Band EDGE test

11.1 Measurement Procedure

For Conducted Test

1. The transmitter output is connected to a spectrum analyzer. The resolution bandwidth is set to 100KHz. The video bandwidth is set to 300KHz.
2. The spectrum from 30MHz to 26 GHz is investigated with the transmitter set to the lowest, middle, and highest channels.

EMI Test Receiver	Setting
Attenuation	Auto
RBW	100KHz
VBW	300KHz
Detector	Peak
Trace	Max hold

For Radiated emission Test

The EUT was placed on a styrofoam table which is 1.5m above ground plane.

The measurement procedure at the band edges was simplified by performing the measurement in just one plot. Both, the in-band-emission and the unwanted emission were encompassed by the span. After trace stabilization, the maximum peak was determined by a peak detector and the value was marked by an appropriate limit line. The second limit line, which is 20dB below the first, marks the limit for the emissions in the unrestricted band. A maximum-peak-detector marks the highest emission in the unrestricted band next to the band edge.

The measurements were performed at the lower end of the 2.4GHz band.

Use the following spectrum analyzer settings:

For Restricted Band, When spectrum scanned above 1GHz setting resolution bandwidth 1MHz, video bandwidth 3MHz:

EMI Test Receiver	Setting
Attenuation	Auto
RBW	1MHz
VBW	3MHz
Detector	Peak
Trace	Max hold

For Non-Restricted Band, When spectrum scanned above 1GHz setting resolution bandwidth 100KHz, video bandwidth 300KHz:

EMI Test Receiver	Setting
Attenuation	Auto
RBW	100KHz
VBW	300KHz
Detector	Peak
Trace	Max hold

11.2 Test SET-UP (Block Diagram of Configuration)

For Conducted Test

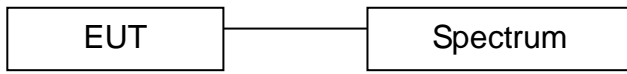

For Radiated emission Test

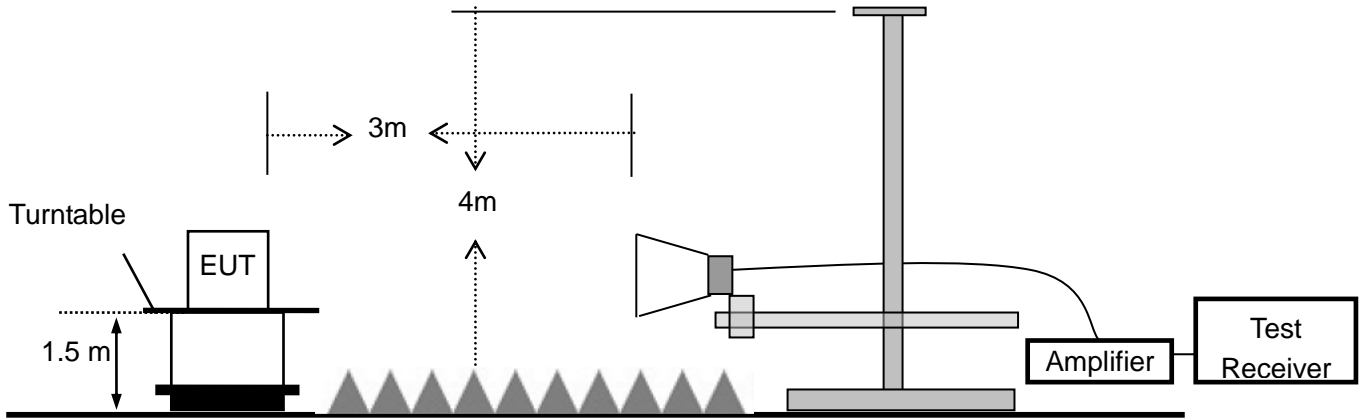

11.3 Measurement Equipment Used:

For Conducted Test

Remark: The temporary antenna connector is soldered on the PCB board in order to perform

Item	Instr.Code	Kind of Equipment	Manufacturer	Type No.	Serial No.	Calibrated until
1	AN-E037	Spectrum Analyzer	KEYSIGHT	N9020A	MY61250185	2023-10-07
2	AN-E040	WIDEBAND RADIO COMMUNICATION	Rohde & Schwarz	CMW500	157423	2023-10-07
3	AN-E039	MXG Vector Signal Generator	KEYSIGHT	N5182B	MY61250185	2023-10-07
4	AN-E038	EXG Analog Signal Generator	KEYSIGHT	N5173B	My61252603	2023-10-07
5	AN-E041	USB RF Power sensor	RadiPower	RPR3006W	17I00015SNO88	2023-10-07
6	AN-E042	USB RF Power sensor	RadiPower	RPR3006W	17I00015SNO89	2023-10-07
7	/	RF Test Software	MWRF-test	MTS 8310	N/A	N/A
8	AN-E092	Radio Frequency control box	MWRF-test	MW200-RFCB	MW220111ANCI	2023-05-12
9	AN-E093	Radio Frequency control box	MWRF-test	MW200-RFCB 2#	/	2023-05-12

conducted tests and this temporary antenna connector is listed in the equipment list.

11.4 Measurement Results:

Refer to attached data chart.

Spectrum Detector: PK Test Date : 2023-03-13
Test By: Best Temperature : 24 °C
Test Result: PASS Humidity : 53 %

1. Conducted Test

Condition	Mode	Frequency (MHz)	Antenna	Max Value (dBc)	Limit (dBc)	Verdict
NVNT	BLE 1M	2402	Ant1	-57.98	-20	Pass
NVNT	BLE 1M	2480	Ant1	-59.86	-20	Pass

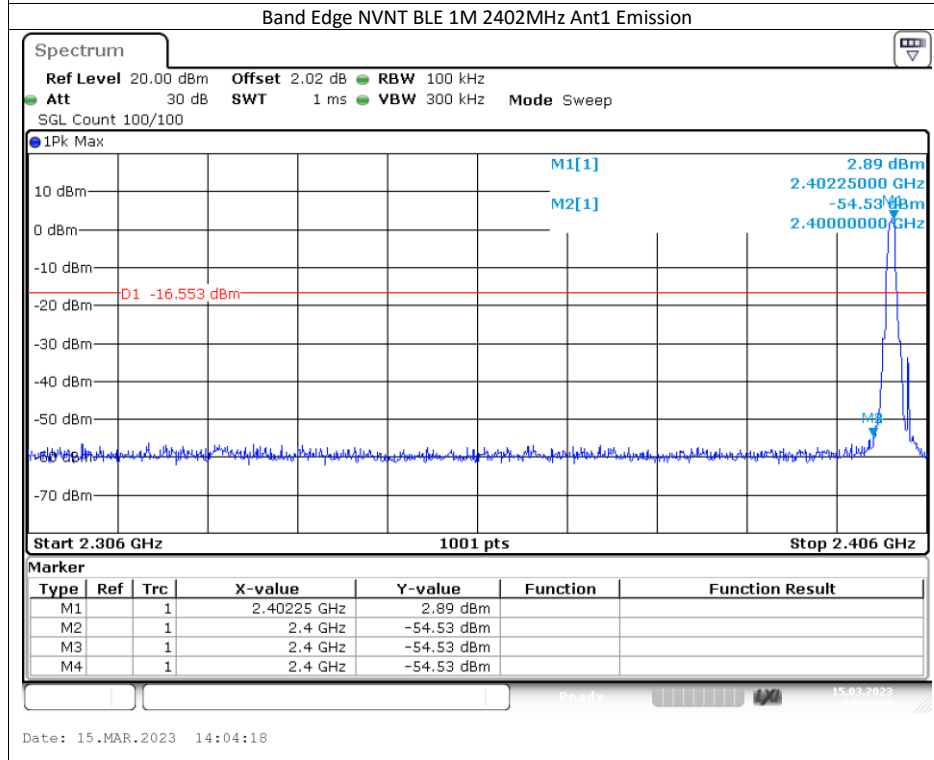
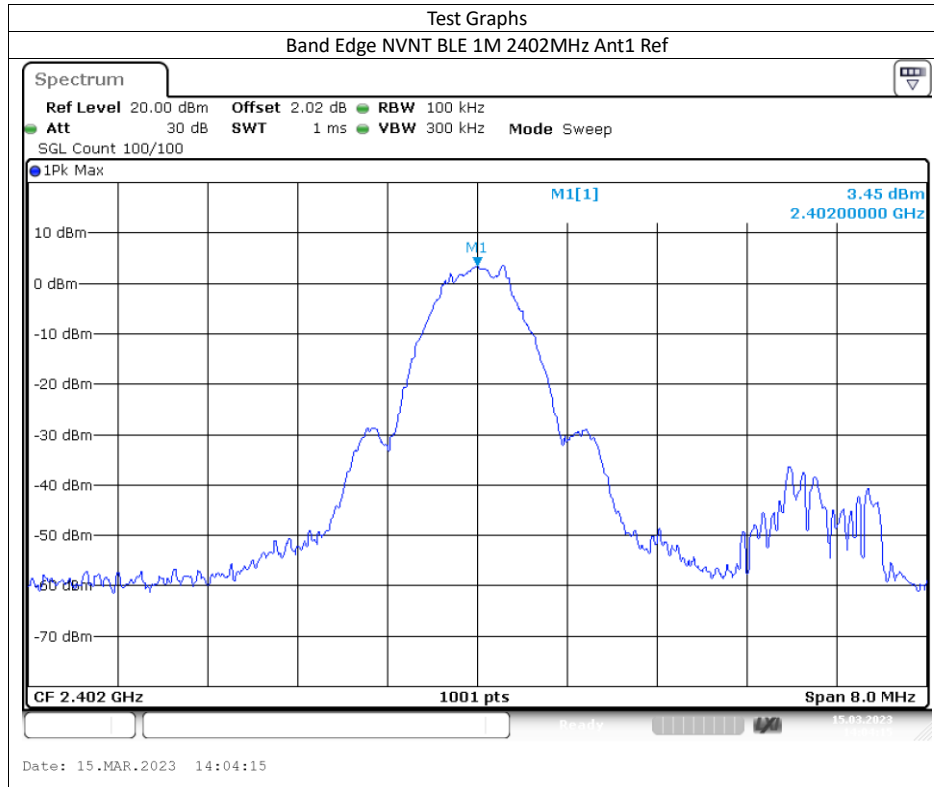

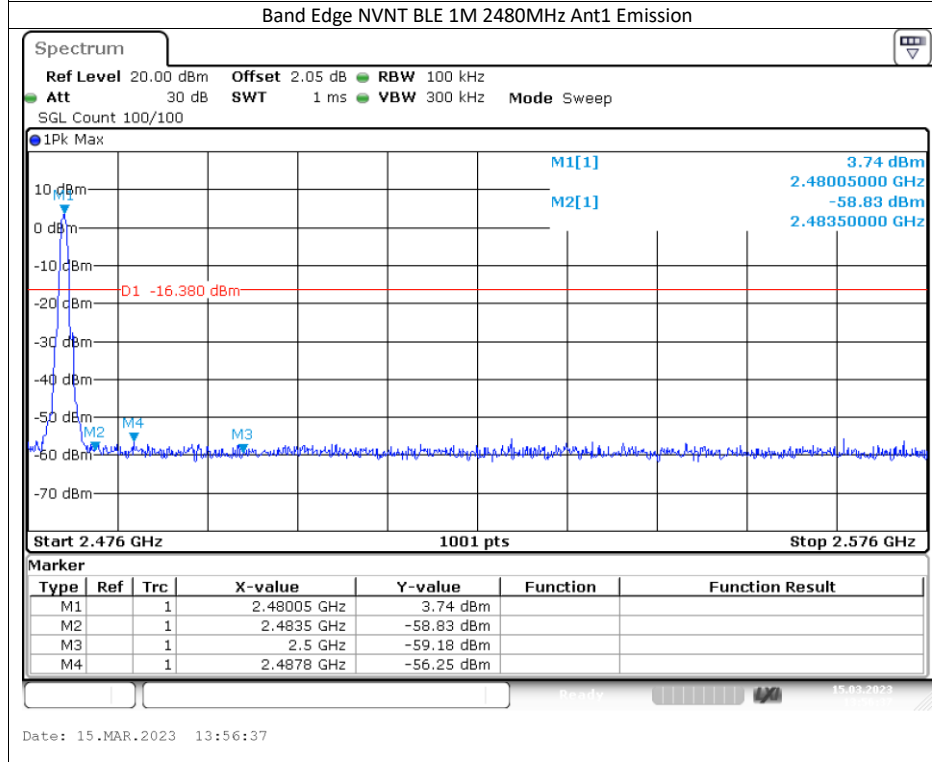
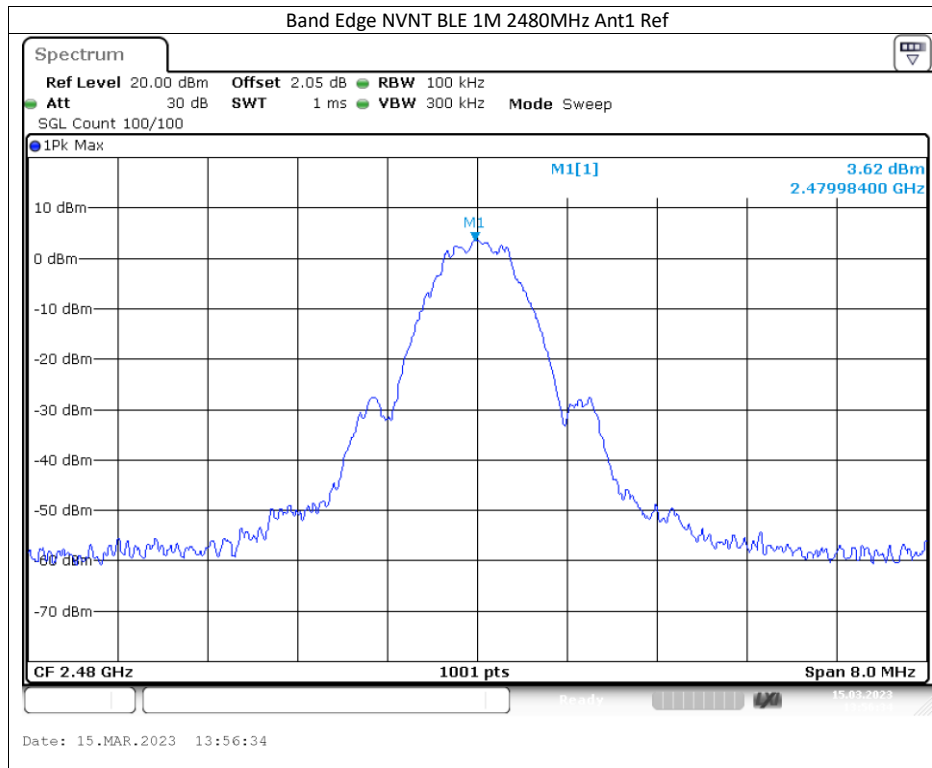

2. Radiated emission Test

Spectrum Detector:

PK/AV

Test Date :

2023-03-13

Test By:

Sunshine

Temperature :

28 °C

Humidity :

65 %

BLE 1M 2402MHz

Freq. (MHz)	Ant. Pol. H/V	Reading Level(dBuV/m)		Correct Factor dB	Emission Level(dBuV/m)		Limit 3m(dBuV/m)		Margin(dB)	
		PK	AV		PK	AV	PK	AV	PK	AV
<2400	H	85.67	67.54	-26.3	59.37	41.24	74	54	-14.63	-12.76
<2400	V	84.58	64.95	-26.1	58.48	38.85	74	54	-15.52	-15.15
>2483.5	H	84.96	67.31	-26.3	58.66	41.01	74	54	-15.34	-12.99
>2483.5	V	86.31	64.86	-26.1	60.21	38.76	74	54	-13.79	-15.24

BLE 1M 2480MHz

Freq. (MHz)	Ant. Pol. H/V	Reading Level(dBuV/m)		Correct Factor dB	Emission Level(dBuV/m)		Limit 3m(dBuV/m)		Margin(dB)	
		PK	AV		PK	AV	PK	AV	PK	AV
<2400	H	85.46	65.87	-26.3	59.16	39.57	74	54	-14.84	-14.43
<2400	V	84.63	65.21	-26.1	58.53	39.11	74	54	-15.47	-14.89
>2483.5	H	86.31	65.94	-26.3	60.01	39.64	74	54	-13.99	-14.36
>2483.5	V	86.23	66.23	-26.1	60.13	40.13	74	54	-13.87	-13.87

12 Antenna Application

12.1 Antenna requirement

The EUT'S antenna is met the requirement of FCC part 15C section 15.203 and 15.247.

FCC part 15C section 15.247 requirements:

Systems operating in the 2402-2480MHz band that are used exclusively for fixed, point-to-point operations may employ transmitting antennas with directional gain greater than 6dBi provided the maximum peak output power of the intentional radiator is reduced by 1dB for every 3dB that the directional gain of the antenna exceeds 6dBi.

12.2 Result

The EUT's antenna, permanent attached antenna, used a ceramic antenna and integrated on PCB, The antenna's gain is 4.16dBi and meets the requirement.

APPENDIX I (Photos of EUT)

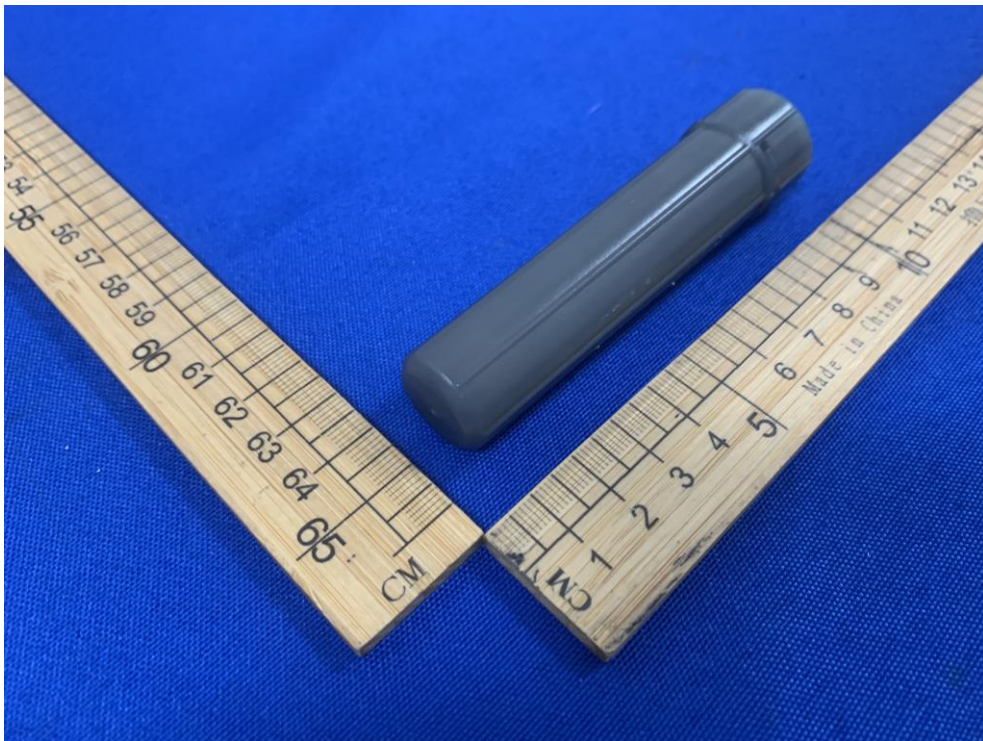
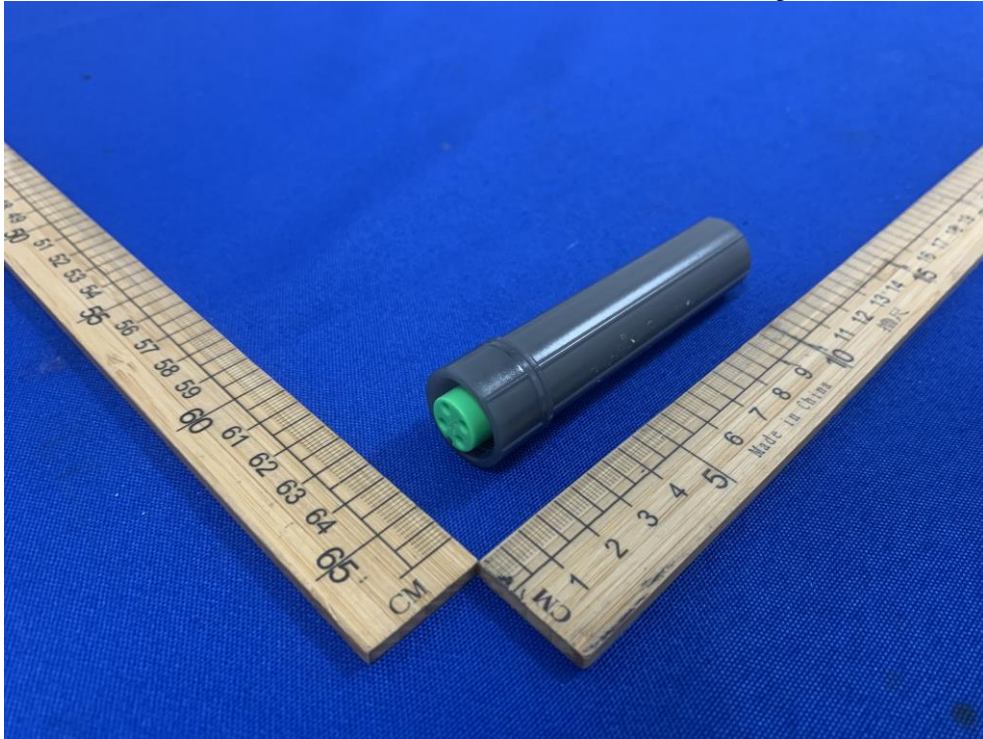



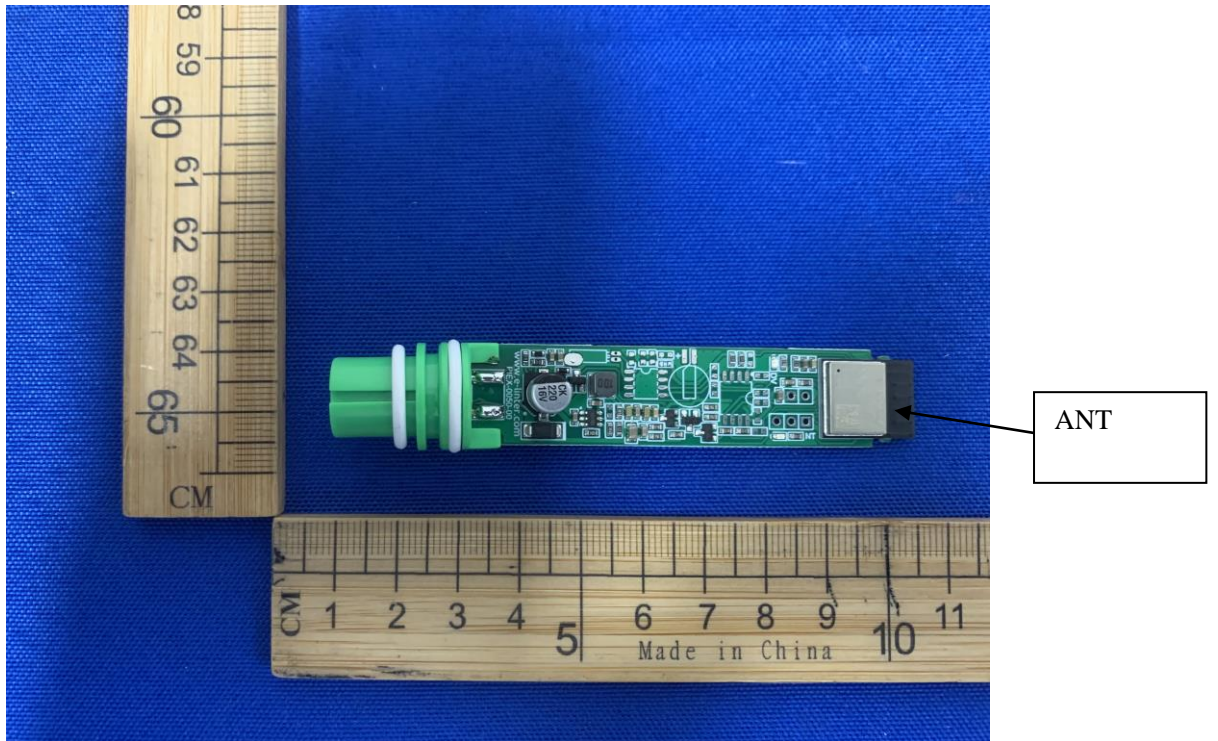

--- End of Report ---