

TEST REPORT

CERTIFICATE OF CONFORMITY

Standard: 47 CFR FCC Part 15, Subpart C (Section 15.247)

Report No.: RFBAYG-WTW-P23080115

FCC ID: 2BAGA010011L

Product: Sleepbuds

Brand: OZLO

Model No.: 010011L

Received Date: 2023/8/4

Test Date: 2023/9/21 ~ 2023/12/21

Issued Date: 2024/1/17

Applicant: Drowsy Digital Inc

Address: 850 New Burton Road Suite 201 19904 Dover Delaware United States 19904

Issued By: Bureau Veritas Consumer Products Services (H.K.) Ltd., Taoyuan Branch
Lin Kou Laboratories

Lab Address: No. 47-2, 14th Ling, Chia Pau Vil., Lin Kou Dist., New Taipei City, Taiwan

Test Location: No. 47-2, 14th Ling, Chia Pau Vil., Lin Kou Dist., New Taipei City, Taiwan

FCC Registration / 198487 / TW2021

Designation Number:

Approved by: Jeremy Lin, **Date:** 2024/1/17
Jeremy Lin / Project Engineer

This test report consists of 49 pages in total. It may be duplicated completely for legal use with the approval of the applicant. It should not be reproduced except in full, without the written approval of our laboratory. The test results in the report only apply to the tested sample. The test results in this report are traceable to the national or international standards.



Prepared by : Annie Chang / Senior Specialist

This report is governed by, and incorporates by reference, the Conditions of Testing as posted at the date of issuance of this report at <http://www.bureauveritas.com/home/about-us/our-business/cps/about-us/terms-conditions/> and is intended for your exclusive use. Any copying or replication of this report to or for any other person or entity, or use of our name or trademark, is permitted only with our prior written permission. This report sets forth our findings solely with respect to the test samples identified herein. The results set forth in this report are not indicative or representative of the quality or characteristics of the lot from which a test sample was taken or any similar or identical product unless specifically and expressly noted. Our report includes all of the tests requested by you and the results thereof based upon the information that you provided to us. Measurement uncertainty is only provided upon request for accredited tests. Statements of conformity are based on simple acceptance criteria without taking measurement uncertainty into account, unless otherwise requested in writing. You have 60 days from date of issuance of this report to notify us of any material error or omission caused by our negligence or if you require measurement uncertainty; provided, however, that such notice shall be in writing and shall specifically address the issue you wish to raise. A failure to raise such issue within the prescribed time shall constitute your unqualified acceptance of the completeness of this report, the tests conducted and the correctness of the report contents.

Table of Contents

Release Control Record	4
1 Certificate	5
2 Summary of Test Results	6
2.1 Measurement Uncertainty	6
2.2 Supplementary Information	6
3 General Information	7
3.1 General Description	7
3.2 Antenna Description of EUT	7
3.3 Channel List	8
3.4 Test Mode Applicability and Tested Channel Detail	9
3.5 Duty Cycle of Test Signal	10
3.6 Test Program Used and Operation Descriptions	11
3.7 Connection Diagram of EUT and Peripheral Devices	11
3.8 Configuration of Peripheral Devices and Cable Connections	12
4 Test Instruments	13
4.1 RF Output Power	13
4.2 Power Spectral Density	13
4.3 6 dB Bandwidth	13
4.4 Conducted Out of Band Emissions	13
4.5 AC Power Conducted Emissions	14
4.6 Unwanted Emissions below 1 GHz	15
4.7 Unwanted Emissions above 1 GHz	16
5 Limits of Test Items	17
5.1 RF Output Power	17
5.2 Power Spectral Density	17
5.3 6 dB Bandwidth	17
5.4 Conducted Out of Band Emissions	17
5.5 AC Power Conducted Emissions	17
5.6 Unwanted Emissions below 1 GHz	17
5.7 Unwanted Emissions above 1 GHz	18
6 Test Arrangements	19
6.1 RF Output Power	19
6.1.1 Test Setup	19
6.1.2 Test Procedure	19
6.2 Power Spectral Density	19
6.2.1 Test Setup	19
6.2.2 Test Procedure	19
6.3 6 dB Bandwidth	20
6.3.1 Test Setup	20
6.3.2 Test Procedure	20
6.4 Conducted Out of Band Emissions	20
6.4.1 Test Setup	20
6.4.2 Test Procedure	20
6.5 AC Power Conducted Emissions	21
6.5.1 Test Setup	21
6.5.2 Test Procedure	21
6.6 Unwanted Emissions below 1 GHz	22
6.6.1 Test Setup	22
6.6.2 Test Procedure	23
6.7 Unwanted Emissions above 1 GHz	24
6.7.1 Test Setup	24
6.7.2 Test Procedure	24
7 Test Results of Test Item	25



7.1	RF Output Power	25
7.2	Power Spectral Density	26
7.3	6 dB Bandwidth	27
7.4	Conducted Out of Band Emissions	28
7.5	AC Power Conducted Emissions	30
7.6	Unwanted Emissions below 1 GHz	34
7.7	Unwanted Emissions above 1 GHz.....	38
8	Pictures of Test Arrangements	48
9	Information of the Testing Laboratories	49



Release Control Record

Issue No.	Description	Date Issued
RFBAYG-WTW-P23080115	Original release.	2024/1/17

1 Certificate

Product: Sleepbuds

Brand: OZLO

Test Model: 010011L

Sample Status: Engineering sample

Applicant: Drowsy Digital Inc

Test Date: 2023/9/21 ~ 2023/12/21

Standard: 47 CFR FCC Part 15, Subpart C (Section 15.247)

Measurement ANSI C63.10-2013

procedure: KDB 558074 D01 15.247 Meas Guidance v05r02

The above equipment has been tested by **Bureau Veritas Consumer Products Services (H.K.) Ltd., Taoyuan Branch**, and found compliance with the requirement of the above standards. The test record, data evaluation & Equipment Under Test (EUT) configurations represented herein are true and accurate accounts of the measurements of the sample's RF characteristics under the conditions specified in this report.

2 Summary of Test Results

47 CFR FCC Part 15, Subpart C (Section 15.247)			
Standard / Clause	Test Item	Result	Remark
15.247(b)	RF Output Power	Pass	Meet the requirement of limit.
15.247(e)	Power Spectral Density	Pass	Meet the requirement of limit.
15.247(a)(2)	6 dB Bandwidth	Pass	Meet the requirement of limit.
15.247(d)	Conducted Out of Band Emissions	Pass	Meet the requirement of limit.
15.207	AC Power Conducted Emissions	Pass	Minimum passing margin is -15.51 dB at 8.72327 MHz
15.205 / 15.209 / 15.247(d)	Unwanted Emissions below 1 GHz	Pass	Minimum passing margin is -8.6 dB at 36.40 MHz
15.205 / 15.209 / 15.247(d)	Unwanted Emissions above 1 GHz	Pass	Minimum passing margin is -2.1 dB at 4960.00 MHz
15.203	Antenna Requirement	Pass	No antenna connector is used.

Note: Determining compliance based on the results of the compliance measurement, not taking into account measurement instrumentation uncertainty.

2.1 Measurement Uncertainty

Where relevant, the following measurement uncertainty levels have been estimated for tests performed on the EUT as specified in CISPR 16-4-2:

Measurement	Specification	Expanded Uncertainty (k=2) (±)
RF Output Power	-	1.1 dB
Power Spectral Density	-	1.2 dB
6 dB Bandwidth	-	960 Hz
Conducted Out of Band Emissions	9 kHz ~ 40 GHz	2.63 dB
AC Power Conducted Emissions	9 kHz ~ 30 MHz	2.88 dB
Unwanted Emissions below 1 GHz	9 kHz ~ 30 MHz	2.38 dB
	30 MHz ~ 1 GHz	5.7 dB
Unwanted Emissions above 1 GHz	1 GHz ~ 6 GHz	4.83 dB
	6 GHz ~ 18 GHz	5.37 dB
	18 GHz ~ 40 GHz	5.24 dB

The other instruments specified are routine verified to remain within the calibrated levels, no measurement uncertainty is required to be calculated.

2.2 Supplementary Information

There is not any deviation from the test standards for the test method, and no modifications required for compliance.

3 General Information

3.1 General Description

Product	Sleepbuds
Brand	OZLO
Test Model	010011L
Status of EUT	Engineering sample
Power Supply Rating	3.7Vdc from Battery or 5Vdc from pogo connector via charging case
Modulation Type	GFSK
Modulation Technology	DTS
Transfer Rate	Up to 2 Mbps
Operating Frequency	2.402 GHz ~ 2.48 GHz
Number of Channel	40
Output Power	1.019 mW (0.08 dBm)

Note: The above EUT information is declared by manufacturer and for more detailed features description, please refer to the manufacturer's specifications or User's Manual.

3.2 Antenna Description of EUT

The antenna information is listed as below.

Gain (dBi)	Antenna Type	Connector Type
-6	LDS	N/A

* Detail antenna specification please refer to antenna datasheet and/or antenna measurement report.

3.3 Channel List

40 channels are provided for BT-LE:

Channel	Frequency (MHz)	Channel	Frequency (MHz)	Channel	Frequency (MHz)	Channel	Frequency (MHz)
0	2402	10	2422	20	2442	30	2462
1	2404	11	2424	21	2444	31	2464
2	2406	12	2426	22	2446	32	2466
3	2408	13	2428	23	2448	33	2468
4	2410	14	2430	24	2450	34	2470
5	2412	15	2432	25	2452	35	2472
6	2414	16	2434	26	2454	36	2474
7	2416	17	2436	27	2456	37	2476
8	2418	18	2438	28	2458	38	2478
9	2420	19	2440	29	2460	39	2480

3.4 Test Mode Applicability and Tested Channel Detail

Pre-Scan:	1. EUT can be used in the following ways: XYZ 3-axis. Pre-scan in these ways and find the worst case as a representative test condition. 2. For Unwanted Emission below 1 GHz has Charging case with earphone connect NB/ Charging case with earphone connect adapter modes of power supply. Pre-scan these modes and find the worst charging case as a representative test condition.
Worst Case:	1. X/ Y/ Z Worst Condition: X Axis for Unwanted Emission above 1GHz and Unwanted Emission below 1GHz 2. For Unwanted Emission below 1 GHz Charging case with earphone connect NB mode is the worst charging case of power supply.

Following channel(s) was (were) selected for the final test as listed below:

Test Item	EUT Configure Mode	Mode	Tested Channel	Modulation	Data Rate Parameter
RF Output Power / Power Spectral Density	A	BT-LE 1M	0, 19, 39	GFSK	1Mb/s
		BT-LE 2M	0, 19, 39	GFSK	2Mb/s
6 dB Bandwidth / Conducted Out of Band Emissions	A	BT-LE 1M	0, 19, 39	GFSK	1Mb/s
		BT-LE 2M	0, 19, 39	GFSK	2Mb/s
AC Power Conducted Emissions	B	-	-	-	-
	C	-	-	-	-
Unwanted Emissions below 1 GHz	A	BT-LE 2M	0	GFSK	2Mb/s
	B	-	-	-	-
Unwanted Emissions above 1 GHz	A	BT-LE 1M	0, 19, 39	GFSK	1Mb/s
		BT-LE 2M	0, 19, 39	GFSK	2Mb/s
EUT Configure Mode:	A	EUT only			
	B	Charging case with earphone connect NB			
	C	Charging case with earphone connect adapter			

3.5 Duty Cycle of Test Signal

BT-LE 1M: Duty cycle = $0.404 \text{ ms} / 0.625 \text{ ms} \times 100\% = 64.6\%$, duty factor = $10 * \log (1/\text{Duty cycle}) = 1.89 \text{ dB}$

BT-LE 2M: Duty cycle = $1.091 \text{ ms} / 1.874 \text{ ms} \times 100\% = 58.2\%$, duty factor = $10 * \log (1/\text{Duty cycle}) = 2.35 \text{ dB}$

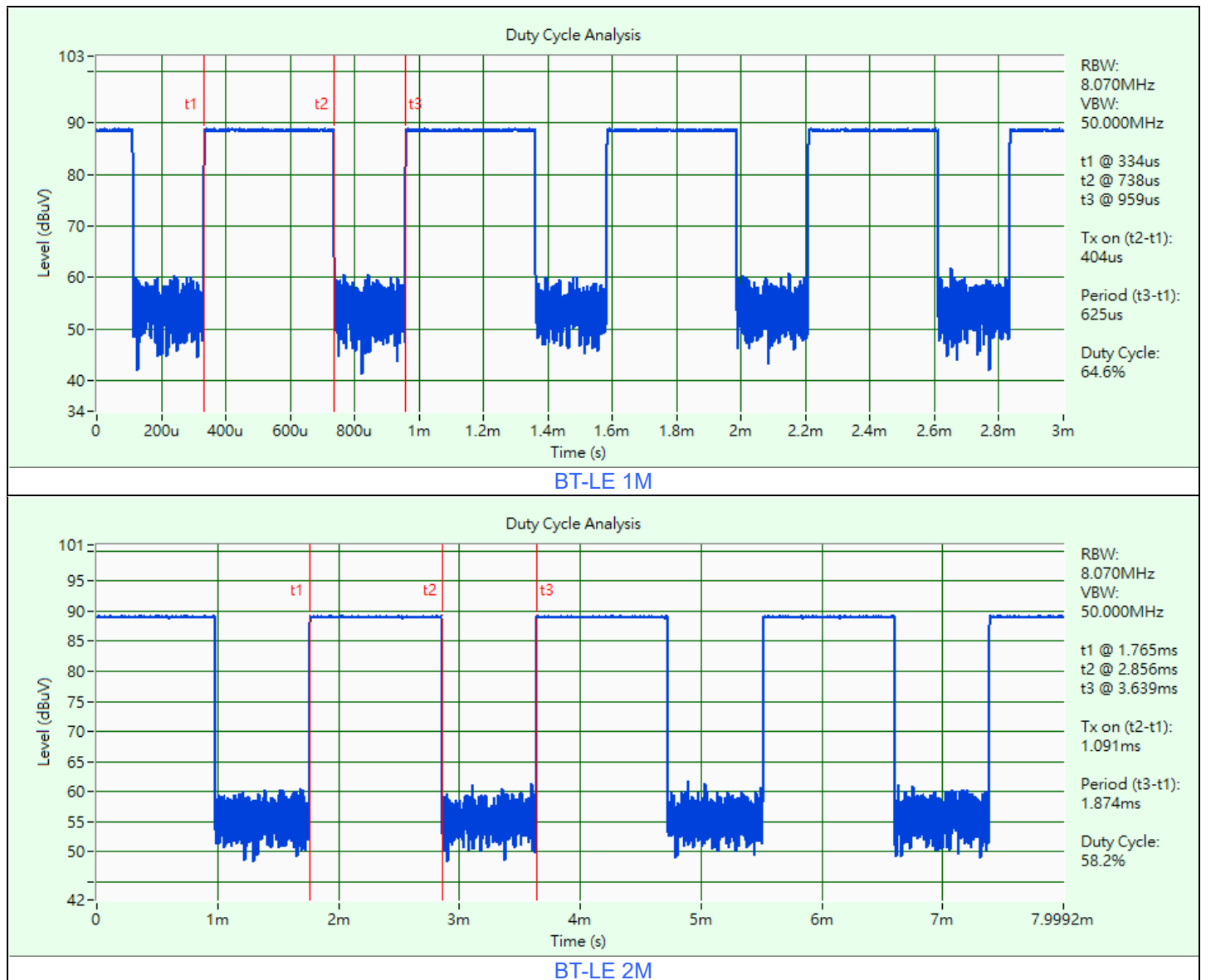

3.6 Test Program Used and Operation Descriptions

Controlling software (cmd v10.0.19045.3803) has been activated to set the EUT under transmission condition continuously at specific channel frequency.

3.7 Connection Diagram of EUT and Peripheral Devices

Mode A



Mode B

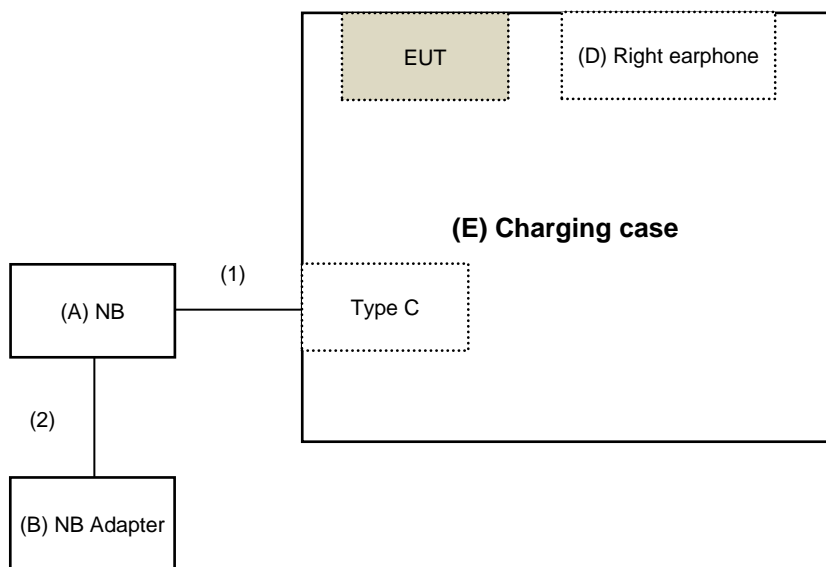

Mode C

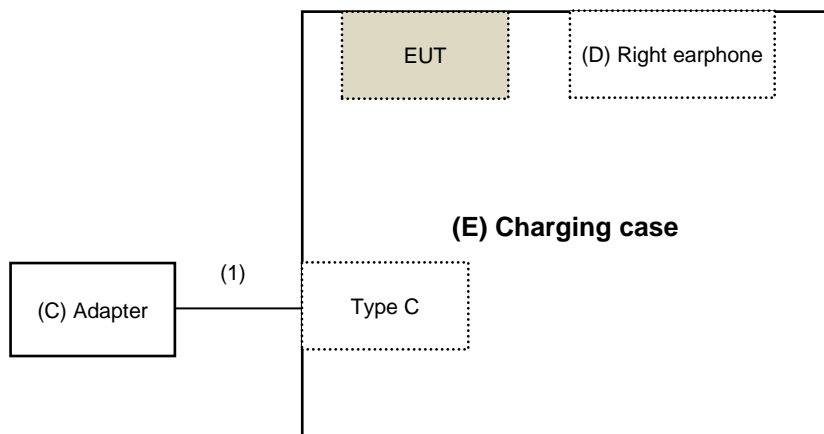

3.8 Configuration of Peripheral Devices and Cable Connections

ID	Product	Brand	Model No.	Serial No.	FCC ID	Remarks
A	NB	LENOVO	IdeaPad 5 15ITL05	N/A	N/A	Provided by Lab
B	NB Adapter	LENOVO	ADLX65CLGU2A	N/A	N/A	Provided by Lab
C	Adapter	APPLE	A1385	N/A	N/A	Provided by Lab
D	Right earphone	OZLO	010011R	N/A	2BAGA010011R	Supplied by applicant
E	Charging case	OZLO	010011	N/A	2BAGA010011	Supplied by applicant

ID	Cable Descriptions	Qty.	Length (m)	Shielding (Yes/No)	Cores (Qty.)	Remarks
1	USB A to USB C cable	1	1	Y	0	Supplied by applicant
2	DC cable	1	1.8	N	0	Provided by Lab

4 Test Instruments

The calibration interval of the all test instruments are 12 months and the calibrations are traceable to NML/ROC and NIST/USA.

4.1 RF Output Power

Description Manufacturer	Model No.	Serial No.	Calibrated Date	Calibrated Until
Power Meter Anritsu	ML2495A	0842014	2023/5/5	2024/5/4
Pulse Power Sensor Anritsu	MA2411B	0738404	2023/5/5	2024/5/4
USB Wideband Power Sensor Keysight	U2021XA	U2021XA_001	2023/6/6	2024/6/5

Notes:

1. The test was performed in LK - Oven
2. Tested Date: 2023/12/21

4.2 Power Spectral Density

Description Manufacturer	Model No.	Serial No.	Calibrated Date	Calibrated Until
PXA Signal Analyzer Keysight	N9030A	MY54490260	2023/7/13	2024/7/12
Signal Analyzer R&S	FSV40	101042	2023/9/5	2024/9/4
		101544	2023/5/9	2024/5/8
Software	ADT_RF Test Software V6.6.5.4	N/A	N/A	N/A

Notes:

1. The test was performed in LK - Oven
2. Tested Date: 2023/12/21

4.3 6 dB Bandwidth

Refer to section 4.2 to get information of the instruments.

4.4 Conducted Out of Band Emissions

Refer to section 4.2 to get information of the instruments.

4.5 AC Power Conducted Emissions

Description Manufacturer	Model No.	Serial No.	Calibrated Date	Calibrated Until
50 ohm terminal resistance LYNICS	0900510	E1-01-305	2023/2/13	2024/2/12
		E1-011285	2023/9/21	2024/9/20
		E1-011286	2023/9/21	2024/9/20
EMI Test Receiver R&S	ESCS 30	100276	2023/4/20	2024/4/19
	ESR3	102412	2022/12/21	2023/12/20
Fixed Attenuator STI	STI02-2200-10	NO.4	2023/9/1	2024/8/31
High Voltage Probe Schwarzbeck	TK9420	00982	2022/12/14	2023/12/13
LISN R&S	ENV216	101197	2023/7/12	2024/7/11
LISN Schwarzbeck	NNLK 8121	8121-731	2023/6/9	2024/6/8
		8121-808	2023/5/2	2024/5/1
	NNLK 8129	8129229	2023/6/27	2024/6/26
	NSLK 8128	8128-244	2022/11/8	2023/11/7
RF Coaxial Cable PEWC	5D-FB	Cable-CO5-01	2023/1/19	2024/1/18
Software BVADT	Cond_V7.3.7.4	N/A	N/A	N/A

Notes:

1. The test was performed in Linkou Conduction 5.
2. Tested Date: 2023/9/23

4.6 Unwanted Emissions below 1 GHz

Description Manufacturer	Model No.	Serial No.	Calibrated Date	Calibrated Until
Bi_Log Antenna Schwarzbeck	VULB 9168	137	2022/10/21	2023/10/20
Coupling / Decoupling Network Schwarzbeck	CDNE-M2	00097	2023/5/25	2024/5/24
	CDNE-M3	00091	2023/5/25	2024/5/24
Loop Antenna EMCI	LPA600	270	2023/9/4	2024/9/3
MXE EMI Receiver Agilent	N9038A	MY51210129	2023/3/24	2024/3/23
		MY51210137	2023/6/5	2024/6/4
Preamplifier EMCI	EMC001340	980269	2023/6/27	2024/6/26
Preamplifier HP	8447D	2432A03504	2023/2/16	2024/2/15
RF Coaxial Cable Pacific	8D-FB	Cable-CH6-02	2023/6/27	2024/6/26
Signal Analyzer R&S	FSV40	101544	2023/5/9	2024/5/8
Software BVADT	Radiated_V8.7.08	N/A	N/A	N/A
Tower ADT	AT100	0306	N/A	N/A
Turn Table ADT	TT100	0306	N/A	N/A

Notes:

1. The test was performed in Linkou 966 Chamber 6 (CH 6).
2. Tested Date: 2023/9/23

4.7 Unwanted Emissions above 1 GHz

Description Manufacturer	Model No.	Serial No.	Calibrated Date	Calibrated Until
Band Pass Filter Micro-Tronics	BRM17690	005	2023/5/25	2024/5/24
Boresight antenna tower fixture BV	BAF-02	6	N/A	N/A
High Pass Filter Wainwright	WHK 3.1/18G-10SS	SN 8	2023/5/25	2024/5/24
Horn Antenna EMCO	3115	00028257	2022/11/13	2023/11/12
Horn Antenna ETS-Lindgren	3117-PA	00215857	2022/11/13	2023/11/12
Horn Antenna Schwarzbeck	BBHA 9170	212	2022/10/20	2023/10/19
		BBHA9170241	2022/10/20	2023/10/19
MXE EMI Receiver Agilent	N9038A	MY51210129	2023/3/24	2024/3/23
		MY51210137	2023/6/5	2024/6/4
Notch Filter Micro-Tronics	BRC50703-01	010	2023/5/25	2024/5/24
Preamplifier EMCI	EMC0126545 EMC184045B	980076	2023/2/16	2024/2/15
		980175	2023/9/2	2024/9/1
		980235	2023/2/16	2024/2/15
Preamplifier HP	8449B	3008A01201	2023/2/16	2024/2/15
RF Coaxial Cable EMCI	EMC102-KM-KM-1000 EMC104	200310	2023/3/12	2024/3/11
		190801	2023/9/13	2024/9/12
		190804	2023/9/13	2024/9/12
RF Coaxial Cable HUBER+SUHNER	SF-104	Cable-CH6-01	2023/9/13	2024/9/12
Signal Analyzer R&S	FSV40	101042	2023/9/5	2024/9/4
		101544	2023/5/9	2024/5/8
Software BVADT	Radiated_V7.7.1.1.1	N/A	N/A	N/A
Tower ADT	AT100	0306	N/A	N/A
Turn Table ADT	TT100	0306	N/A	N/A

Notes:

1. The test was performed in Linkou 966 Chamber 6 (CH 6).
2. Tested Date: 2023/9/21

5 Limits of Test Items

5.1 RF Output Power

For systems using digital modulation in the 2400–2483.5 MHz bands: 1 Watt (30 dBm)

5.2 Power Spectral Density

The Maximum of Power Spectral Density Measurement is 8 dBm in any 3 kHz.

5.3 6 dB Bandwidth

The minimum of 6 dB Bandwidth Measurement is 0.5 MHz.

5.4 Conducted Out of Band Emissions

Below 20 dB of the highest emission level of operating band (in 100 kHz Resolution Bandwidth).

5.5 AC Power Conducted Emissions

Frequency (MHz)	Conducted Limit (dBuV)	
	Quasi-peak	Average
0.15 - 0.5	66 - 56	56 - 46
0.50 - 5.0	56	46
5.0 - 30.0	60	50

Notes:

1. The lower limit shall apply at the transition frequencies.
2. The limit decreases in line with the logarithm of the frequency in the range of 0.15 to 0.50 MHz.

5.6 Unwanted Emissions below 1 GHz

Radiated emissions up to 1 GHz which fall in the restricted bands must comply with the radiated emission limits specified as below table. Other emissions shall be at least 20 dB below the highest level of the desired power:

Frequencies (MHz)	Field Strength (microvolts/meter)	Measurement Distance (meters)
0.009 ~ 0.490	2400/F(kHz)	300
0.490 ~ 1.705	24000/F(kHz)	30
1.705 ~ 30.0	30	30
30 ~ 88	100	3
88 ~ 216	150	3
216 ~ 960	200	3
Above 960	500	3

Notes:

1. The lower limit shall apply at the transition frequencies.
2. Emission level (dBuV/m) = 20 log Emission level (uV/m).

5.7 Unwanted Emissions above 1 GHz

Radiated emissions above 1 GHz which fall in the restricted bands must comply with the radiated emission limits specified as below table. Other emissions shall be at least 20 dB below the highest level of the desired power:

Frequencies (MHz)	Field Strength (microvolts/meter)	Measurement Distance (meters)
Above 960	500	3

Notes:

1. The lower limit shall apply at the transition frequencies.
2. Emission level (dBuV/m) = 20 log Emission level (uV/m).
3. For frequencies above 1000 MHz, the field strength limits are based on average detector, however, the peak field strength of any emission shall not exceed the maximum permitted average limits, specified above by more than 20 dB under any condition of modulation.

6 Test Arrangements

6.1 RF Output Power

6.1.1 Test Setup

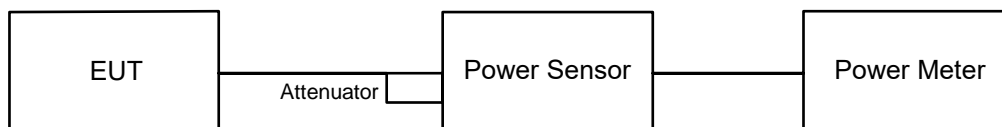

6.1.2 Test Procedure

Peak Power:

A peak power sensor was used on the output port of the EUT. A power meter was used to read the response of the peak power sensor. Record the power level.

Average Power:

Average power sensor was used to perform output power measurement, trigger and gating function of wide band power meter is enabled to measure max output power of TX on burst. Duty factor is not added to measured value.

6.2 Power Spectral Density

6.2.1 Test Setup

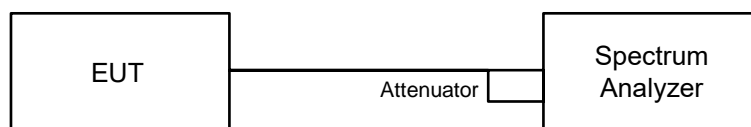

6.2.2 Test Procedure

- a. Set analyzer center frequency to DTS channel center frequency.
- b. Set the span to 1.5 times the DTS bandwidth.
- c. Set the RBW to: 3 kHz.
- d. Set the VBW $\geq 3 \times$ RBW.
- e. Detector = peak.
- f. Sweep time = auto couple.
- g. Trace mode = max hold.
- h. Allow trace to fully stabilize.
- i. Use the peak marker function to determine the maximum amplitude level within the RBW.

6.3 6 dB Bandwidth

6.3.1 Test Setup

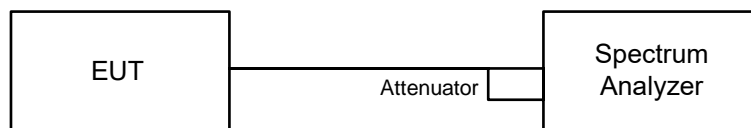

6.3.2 Test Procedure

- a. Set resolution bandwidth (RBW) = 100 kHz.
- b. Set the video bandwidth (VBW) $\geq 3 \times$ RBW, Detector = Peak.
- c. Trace mode = max hold.
- d. Sweep = auto couple.
- e. Measure the maximum width of the emission that is constrained by the frequencies associated with the two amplitude points (upper and lower) that are attenuated by 6 dB relative to the maximum level measured in the fundamental emission.

6.4 Conducted Out of Band Emissions

6.4.1 Test Setup

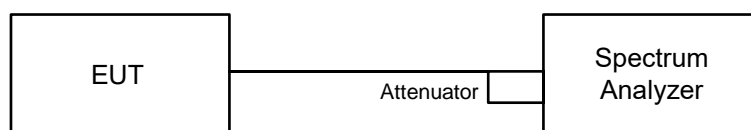

6.4.2 Test Procedure

MEASUREMENT PROCEDURE REF

- a. Set the RBW = 100 kHz.
- b. Set the VBW ≥ 300 kHz.
- c. Detector = peak.
- d. Sweep time = auto couple.
- e. Trace mode = max hold.
- f. Allow trace to fully stabilize.
- g. Use the peak marker function to determine the maximum power level in any 100 kHz band segment within the fundamental EBW.

MEASUREMENT PROCEDURE OOB

- a. Set RBW = 100 kHz.
- b. Set VBW ≥ 300 kHz.
- c. Detector = peak.
- d. Sweep = auto couple.
- e. Trace Mode = max hold.
- f. Allow trace to fully stabilize.
- g. Use the peak marker function to determine the maximum amplitude level.

6.5 AC Power Conducted Emissions

6.5.1 Test Setup

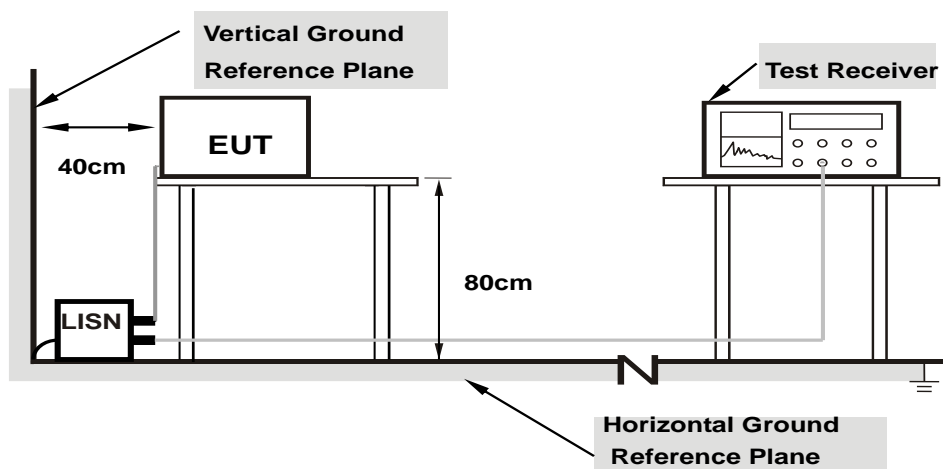

Note: 1.Support units were connected to second LISN.

For the actual test configuration, please refer to the attached file (Test Setup Photo).

6.5.2 Test Procedure

- The EUT was placed on a 0.8 meter to the top of table and placed 0.4 meters from the conducting wall of the shielded room with EUT being connected to the power mains through a line impedance stabilization network (LISN). Other support units were connected to the power mains through another LISN. The two LISNs provide 50 ohm/ 50 uH of coupling impedance for the measuring instrument.
- Both lines of the power mains connected to the EUT were checked for maximum conducted interference.
- The frequency range from 150 kHz to 30 MHz was searched. Emission levels under (Limit – 20 dB) was not recorded.

Note: The resolution bandwidth and video bandwidth of test receiver is 9 kHz for quasi-peak detection (QP) and average detection (AV) at frequency 0.15 MHz-30 MHz.

6.6 Unwanted Emissions below 1 GHz

6.6.1 Test Setup

For Radiated emission below 30 MHz

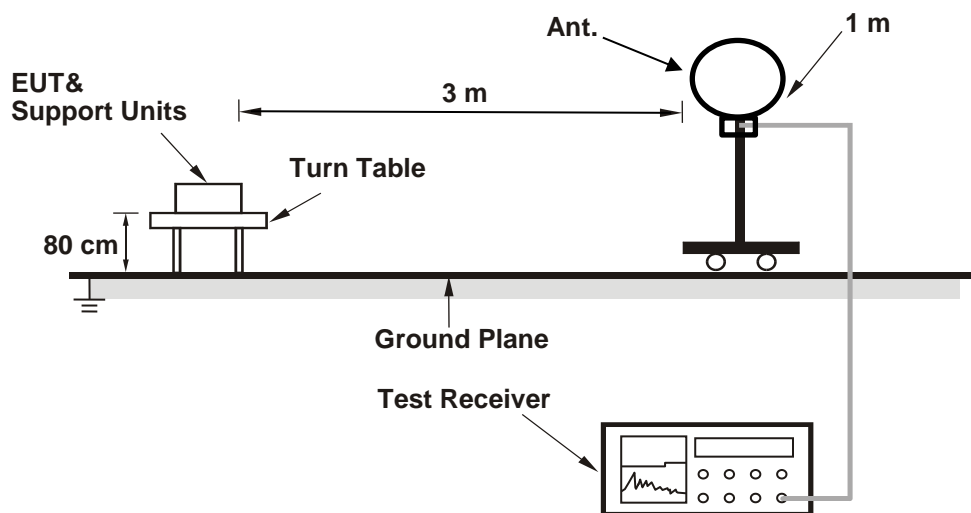

For Radiated emission above 30 MHz

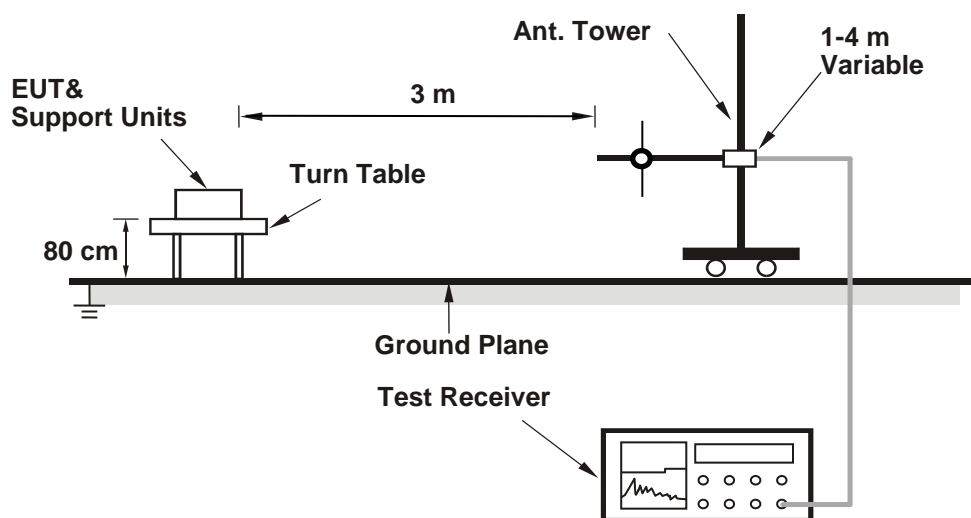

For the actual test configuration, please refer to the attached file (Test Setup Photo).

6.6.2 Test Procedure

For Radiated emission below 30 MHz

- a. The EUT was placed on the top of a rotating table 0.8 meters above the ground at 3 meter chamber room for test. The table was rotated 360 degrees to determine the position of the highest radiation.
- b. The EUT was set 3 meters away from the interference-receiving antenna, which was mounted on the top of a variable-height antenna tower.
- c. Parallel, perpendicular, and ground-parallel orientations of the antenna are set to make the measurement.
- d. For each suspected emission, the EUT was arranged to its worst case and the rotatable table was turned from 0 degrees to 360 degrees to find the maximum reading.
- e. The test-receiver system was set to Quasi-Peak Detect Function and Specified Bandwidth with Maximum Hold Mode, except for the frequency band (9 kHz to 90 kHz and 110 kHz to 490 kHz) set to average detect function and peak detect function.

Notes:

1. The resolution bandwidth and video bandwidth of test receiver/spectrum analyzer is 200 Hz at frequency below 150 kHz.
2. The resolution bandwidth and video bandwidth of test receiver/spectrum analyzer is 9 kHz or 10 kHz at frequency (150 kHz to 30 MHz).
3. All modes of operation were investigated and the worst-case emissions are reported.

For Radiated emission above 30 MHz

- a. The EUT was placed on the top of a rotating table 0.8 meters above the ground at 3 meter chamber room for test. The table was rotated 360 degrees to determine the position of the highest radiation.
- b. The EUT was set 3 meters away from the interference-receiving antenna, which was mounted on the top of a variable-height antenna tower.
- c. The height of antenna is varied from one meter to four meters above the ground to determine the maximum value of the field strength. Both horizontal and vertical polarizations of the antenna are set to make the measurement.
- d. For each suspected emission, the EUT was arranged to its worst case and then the antenna was tuned to heights from 1 meter to 4 meters and the rotatable table was turned from 0 degrees to 360 degrees to find the maximum reading.
- e. The test-receiver system was set to quasi-peak detect function and specified bandwidth with maximum hold mode when the test frequency is below 1 GHz.

Notes:

1. The resolution bandwidth and video bandwidth of test receiver/spectrum analyzer is 120 kHz for Quasi-peak detection (QP) at frequency below 1 GHz.
2. All modes of operation were investigated and the worst-case emissions are reported.

6.7 Unwanted Emissions above 1 GHz

6.7.1 Test Setup

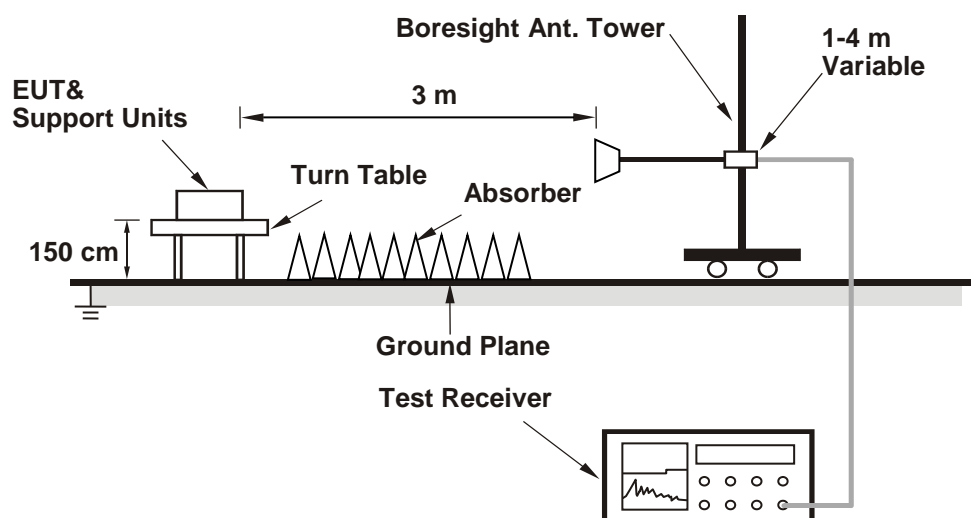

For the actual test configuration, please refer to the attached file (Test Setup Photo).

6.7.2 Test Procedure

- The EUT was placed on the top of a rotating table 1.5 meters above the ground at 3 meter chamber room for test. The table was rotated 360 degrees to determine the position of the highest radiation.
- The EUT was set 3 meters away from the interference-receiving antenna, which was mounted on the top of a variable-height antenna tower.
- The height of antenna is varied from one meter to four meters above the ground to determine the maximum value of the field strength. Both horizontal and vertical polarizations of the antenna are set to make the measurement.
- For each suspected emission, the EUT was arranged to its worst case and then the antenna was tuned to heights from 1 meter to 4 meters and the rotatable table was turned from 0 degrees to 360 degrees to find the maximum reading.
- The test-receiver/spectrum analyzer was set to peak and average detects function and specified bandwidth with maximum hold mode when the test frequency is above 1 GHz. If the peak reading value also meets average limit, measurement with the average detector is unnecessary.

Notes:

- The resolution bandwidth of test receiver/spectrum analyzer is 1 MHz and the video bandwidth is 3 MHz for Peak detection (PK) and Average detection (AV) at frequency above 1 GHz.
- For harmonic signal measurement, the resolution bandwidth of test receiver/spectrum analyzer is 1 MHz and the video bandwidth is $\geq 1/T$ (Duty cycle $< 98\%$) or 10 Hz (Duty cycle $\geq 98\%$) for Average detection (AV) at frequency above 1 GHz.
- All modes of operation were investigated and the worst-case emissions are reported.

7 Test Results of Test Item

7.1 RF Output Power

Input Power:	3.7 Vdc	Environmental Conditions:	25°C, 76% RH	Tested By:	Dalen Dai
--------------	---------	---------------------------	--------------	------------	-----------

For Peak Power

BT-LE 1M

Chan.	Chan. Freq. (MHz)	Peak Power (mW)	Peak Power (dBm)	Power Limit (dBm)	Test Result
0	2402	1.016	0.07	30	Pass
19	2440	0.9772	-0.10	30	Pass
39	2480	0.929	-0.32	30	Pass

Note: The antenna gain is -6 dBi < 6 dBi, so the output power limit shall not be reduced.

BT-LE 2M

Chan.	Chan. Freq. (MHz)	Peak Power (mW)	Peak Power (dBm)	Power Limit (dBm)	Test Result
0	2402	1.019	0.08	30	Pass
19	2440	0.9683	-0.14	30	Pass
39	2480	0.9376	-0.28	30	Pass

Note: The antenna gain is -6 dBi < 6 dBi, so the output power limit shall not be reduced.

For Average Power

BT-LE 1M

Chan.	Chan. Freq. (MHz)	Average Power (mW)	Average Power (dBm)
0	2402	0.9638	-0.16
19	2440	0.9311	-0.31
39	2480	0.8831	-0.54

BT-LE 2M

Chan.	Chan. Freq. (MHz)	Average Power (mW)	Average Power (dBm)
0	2402	0.9683	-0.14
19	2440	0.929	-0.32
39	2480	0.8831	-0.54

7.2 Power Spectral Density

Input Power:	3.7 Vdc	Environmental Conditions:	25°C, 76% RH	Tested By:	Dalen Dai
--------------	---------	---------------------------	--------------	------------	-----------

BT-LE 1M

Channel	Freq. (MHz)	PSD (dBm/3kHz)	PSD Limit (dBm/3kHz)	Pass / Fail
0	2402	-14.61	8	Pass
19	2440	-14.71	8	Pass
39	2480	-15.18	8	Pass

Note: The antenna gain is -6 dBi < 6 dBi, so the power density limit shall not be reduced.

BT-LE 2M

Channel	Freq. (MHz)	PSD (dBm/3kHz)	PSD Limit (dBm/3kHz)	Pass / Fail
0	2402	-17.92	8	Pass
19	2440	-17.69	8	Pass
39	2480	-18.56	8	Pass

Note: The antenna gain is -6 dBi < 6 dBi, so the power density limit shall not be reduced.

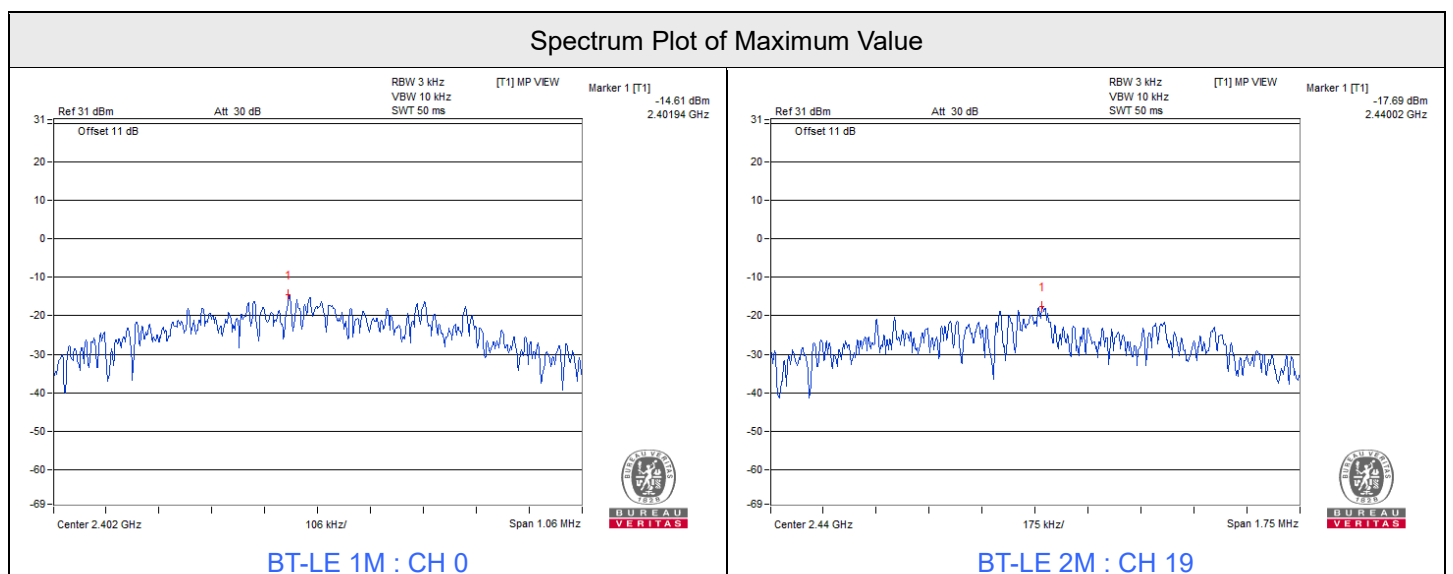

7.3 6 dB Bandwidth

Input Power:	3.7 Vdc	Environmental Conditions:	25°C, 76% RH	Tested By:	Dalen Dai
--------------	---------	---------------------------	--------------	------------	-----------

BT-LE 1M

Channel	Frequency (MHz)	6 dB Bandwidth (MHz)	Minimum Limit (MHz)	Test Result
0	2402	0.71	0.5	Pass
19	2440	0.71	0.5	Pass
39	2480	0.7	0.5	Pass

BT-LE 2M

Channel	Frequency (MHz)	6 dB Bandwidth (MHz)	Minimum Limit (MHz)	Test Result
0	2402	1.19	0.5	Pass
19	2440	1.17	0.5	Pass
39	2480	1.18	0.5	Pass

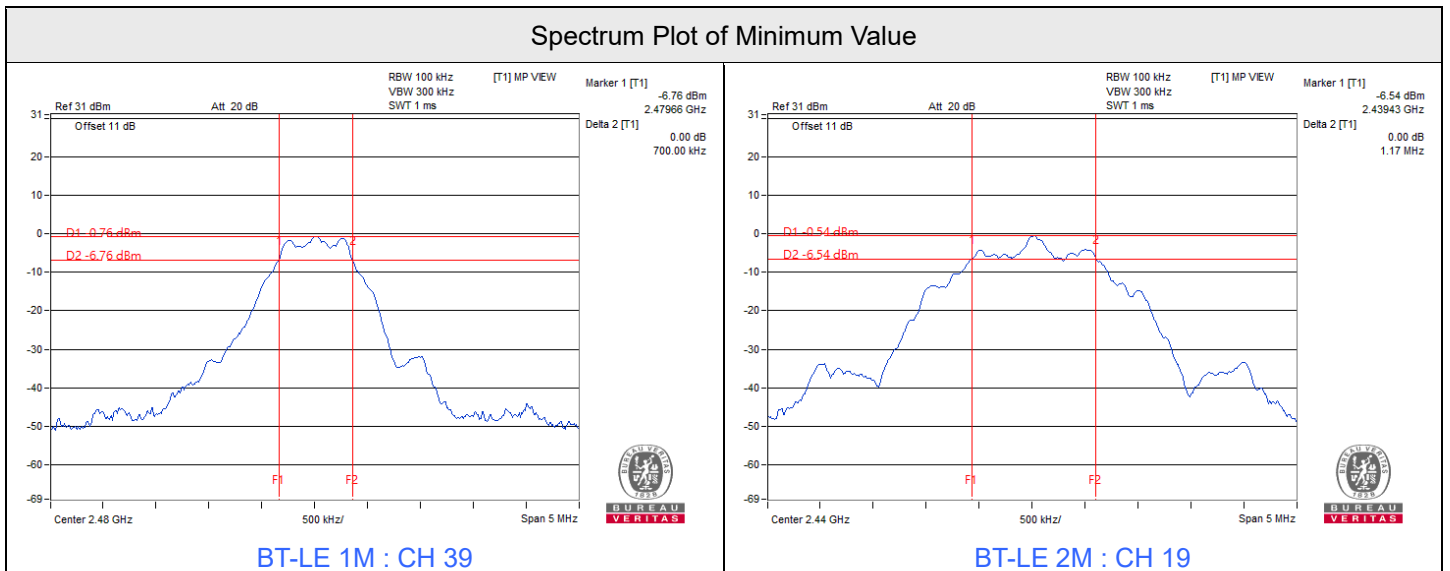



7.4 Conducted Out of Band Emissions

Input Power:	3.7 Vdc	Environmental Conditions:	25°C, 76% RH	Tested By:	Dalen Dai
--------------	---------	---------------------------	--------------	------------	-----------

BT-LE 1M

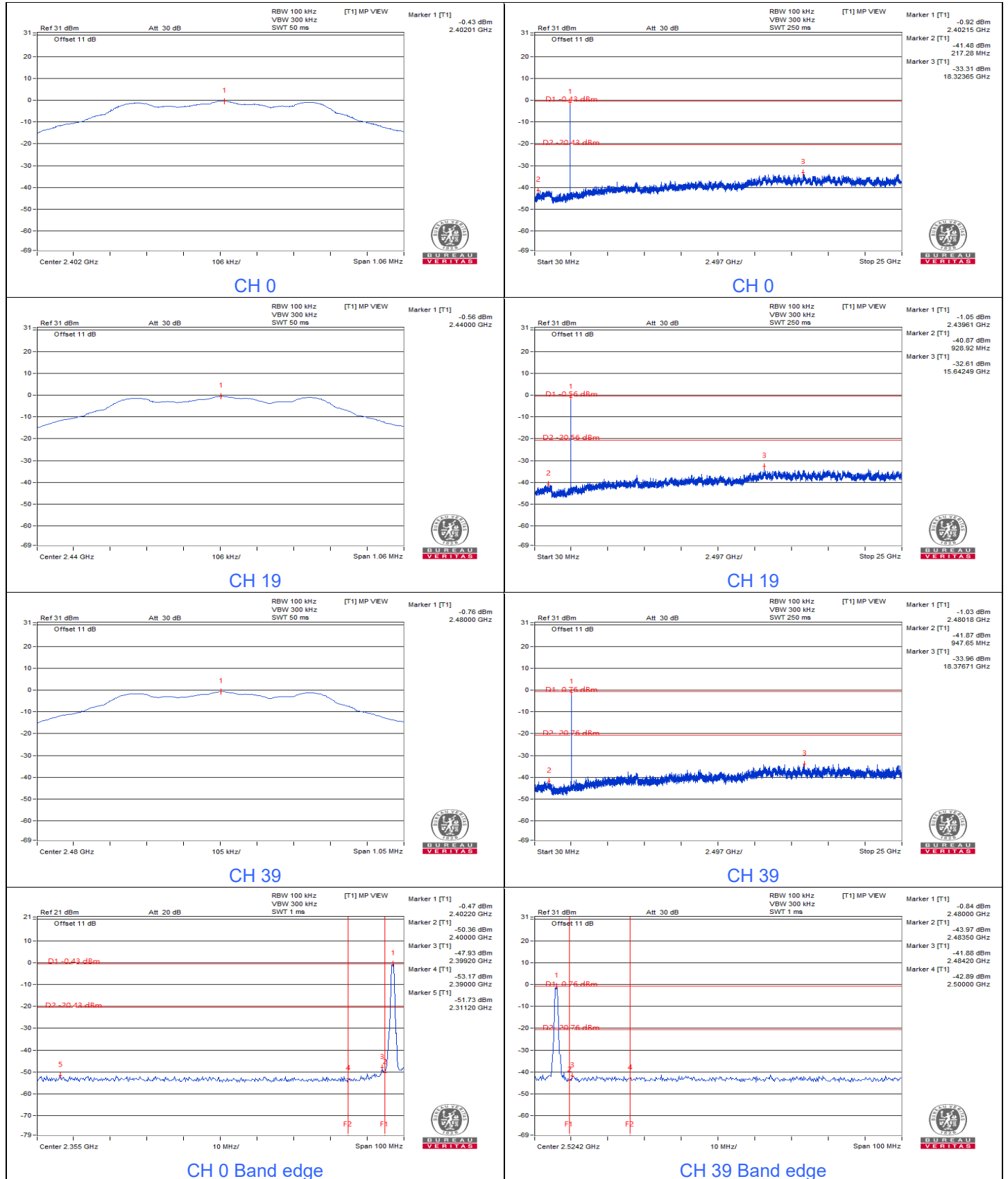

BT-LE 2M

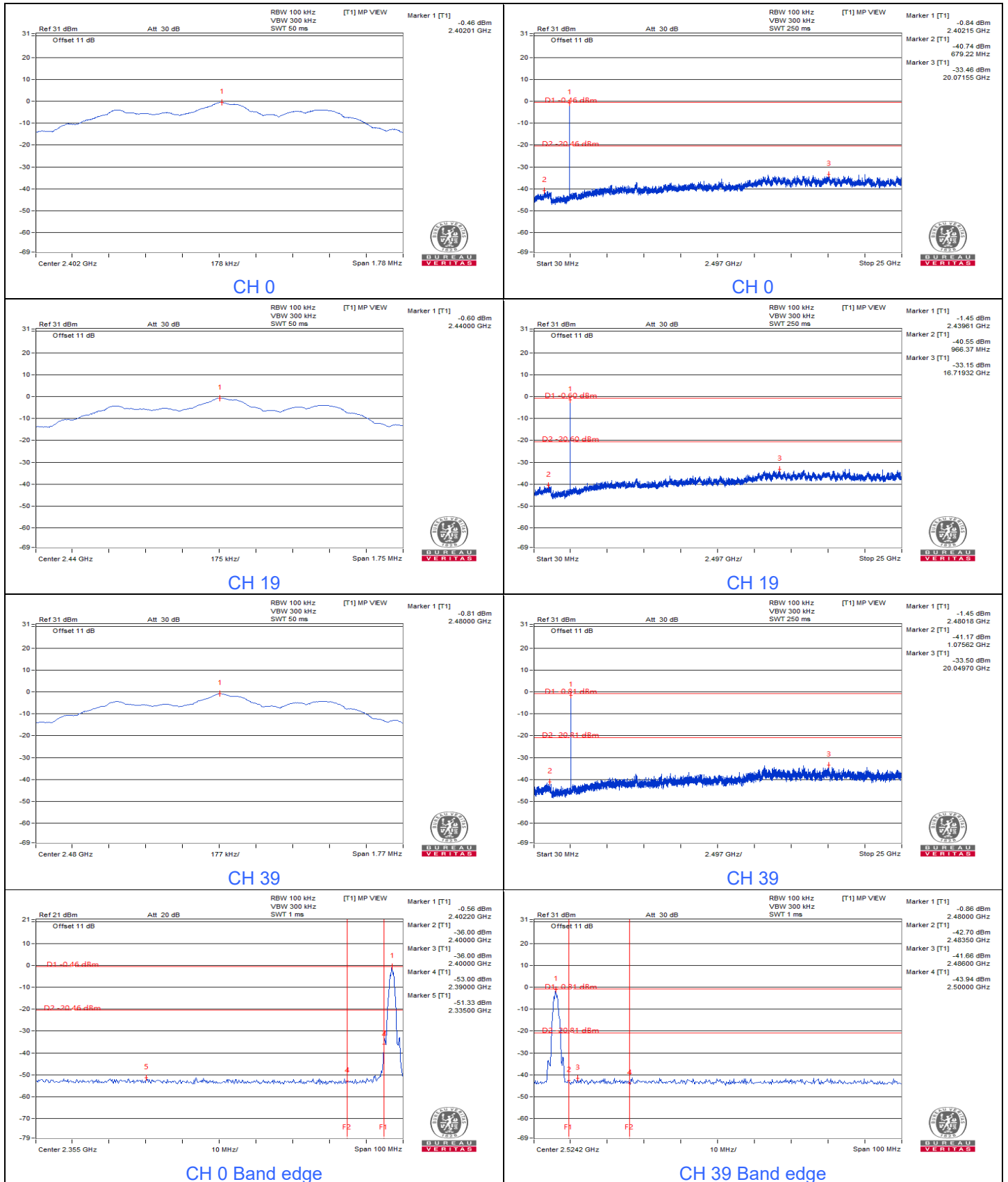

7.5 AC Power Conducted Emissions

Mode B

Frequency Range	150 kHz ~ 30 MHz	Detector Function & Resolution Bandwidth	Quasi-Peak (QP) / Average (AV), 9 kHz
Input Power	120 Vac, 60 Hz	Environmental Conditions	25°C, 75% RH
Tested By	Jed Wu		

Phase Of Power : Line (L)										
No	Frequency (MHz)	Correction Factor (dB)	Reading Value (dBuV)		Emission Level (dBuV)		Limit (dBuV)		Margin (dB)	
			Q.P.	AV.	Q.P.	AV.	Q.P.	AV.	Q.P.	AV.
1	0.15719	10.07	39.57	20.49	49.64	30.56	65.61	55.61	-15.97	-25.05
2	0.25951	10.16	28.39	17.55	38.55	27.71	61.45	51.45	-22.90	-23.74
3	0.43159	10.24	22.37	8.88	32.61	19.12	57.22	47.22	-24.61	-28.10
4	3.77950	10.51	28.08	17.96	38.59	28.47	56.00	46.00	-17.41	-17.53
5	6.57222	10.61	25.06	18.07	35.67	28.68	60.00	50.00	-24.33	-21.32
6	8.72327	10.69	30.75	23.80	41.44	34.49	60.00	50.00	-18.56	-15.51

Remarks:

1. Q.P. and AV. are abbreviations of quasi-peak and average individually.
2. The emission levels of other frequencies were very low against the limit.
3. Margin value = Emission level – Limit value
4. Correction factor = Insertion loss + Cable loss
5. Emission Level = Correction Factor + Reading Value

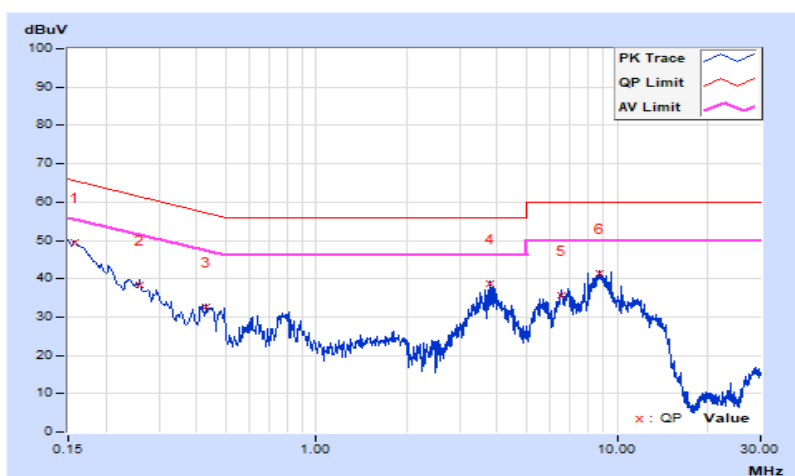

Frequency Range	150 kHz ~ 30 MHz	Detector Function & Resolution Bandwidth	Quasi-Peak (QP) / Average (AV), 9 kHz
Input Power	120 Vac, 60 Hz	Environmental Conditions	25°C, 75% RH
Tested By	Jed Wu		

Phase Of Power : Neutral (N)										
No	Frequency (MHz)	Correction Factor (dB)	Reading Value (dBuV)		Emission Level (dBuV)		Limit (dBuV)		Margin (dB)	
			Q.P.	AV.	Q.P.	AV.	Q.P.	AV.	Q.P.	AV.
1	0.15391	10.03	39.54	20.56	49.57	30.59	65.79	55.79	-16.22	-25.20
2	0.23586	10.16	31.22	21.24	41.38	31.40	62.24	52.24	-20.86	-20.84
3	0.45696	10.18	22.39	16.93	32.57	27.11	56.75	46.75	-24.18	-19.64
4	3.84208	10.40	26.24	17.24	36.64	27.64	56.00	46.00	-19.36	-18.36
5	6.58004	10.53	25.03	18.33	35.56	28.86	60.00	50.00	-24.44	-21.14
6	8.59812	10.62	29.31	22.70	39.93	33.32	60.00	50.00	-20.07	-16.68

Remarks:

1. Q.P. and AV. are abbreviations of quasi-peak and average individually.
2. The emission levels of other frequencies were very low against the limit.
3. Margin value = Emission level – Limit value
4. Correction factor = Insertion loss + Cable loss
5. Emission Level = Correction Factor + Reading Value

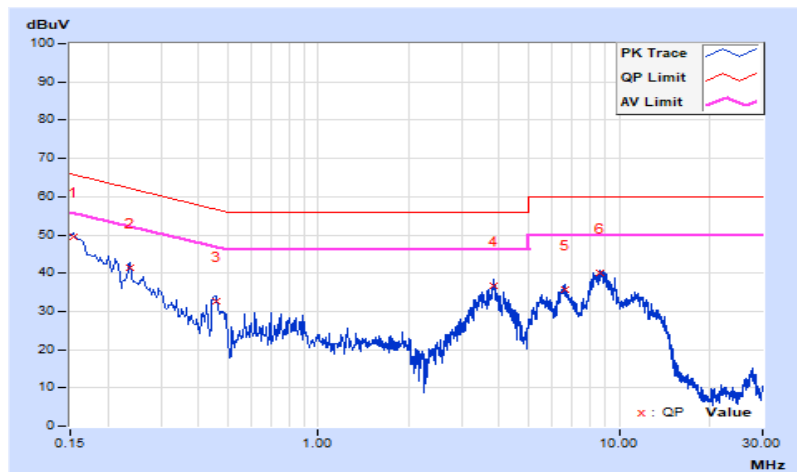

Mode C

Frequency Range	150 kHz ~ 30 MHz	Detector Function & Resolution Bandwidth	Quasi-Peak (QP) / Average (AV), 9 kHz
Input Power	120 Vac, 60 Hz	Environmental Conditions	25°C, 75% RH
Tested By	Jed Wu		

Phase Of Power : Line (L)										
No	Frequency (MHz)	Correction Factor (dB)	Reading Value (dBuV)		Emission Level (dBuV)		Limit (dBuV)		Margin (dB)	
			Q.P.	AV.	Q.P.	AV.	Q.P.	AV.	Q.P.	AV.
1	0.16173	10.07	34.22	11.92	44.29	21.99	65.37	55.37	-21.08	-33.38
2	0.26342	10.16	25.08	11.19	35.24	21.35	61.32	51.32	-26.08	-29.97
3	0.67991	10.30	22.94	9.85	33.24	20.15	56.00	46.00	-22.76	-25.85
4	0.80115	10.32	22.22	14.74	32.54	25.06	56.00	46.00	-23.46	-20.94
5	3.89683	10.51	19.36	9.94	29.87	20.45	56.00	46.00	-26.13	-25.55
6	9.48384	10.72	18.36	12.45	29.08	23.17	60.00	50.00	-30.92	-26.83

Remarks:

1. Q.P. and AV. are abbreviations of quasi-peak and average individually.
2. The emission levels of other frequencies were very low against the limit.
3. Margin value = Emission level – Limit value
4. Correction factor = Insertion loss + Cable loss
5. Emission Level = Correction Factor + Reading Value

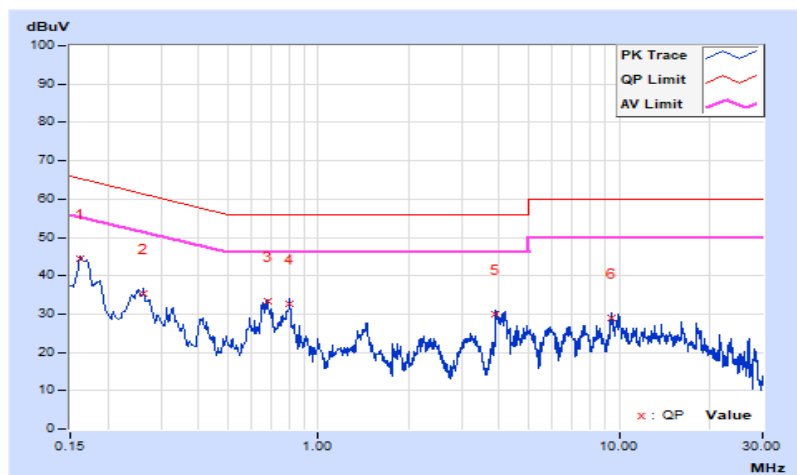

Frequency Range	150 kHz ~ 30 MHz	Detector Function & Resolution Bandwidth	Quasi-Peak (QP) / Average (AV), 9 kHz
Input Power	120 Vac, 60 Hz	Environmental Conditions	25°C, 75% RH
Tested By	Jed Wu		

Phase Of Power : Neutral (N)										
No	Frequency (MHz)	Correction Factor (dB)	Reading Value (dBuV)		Emission Level (dBuV)		Limit (dBuV)		Margin (dB)	
			Q.P.	AV.	Q.P.	AV.	Q.P.	AV.	Q.P.	AV.
1	0.16526	10.06	35.54	11.77	45.60	21.83	65.20	55.20	-19.60	-33.37
2	0.24777	10.16	29.68	15.90	39.84	26.06	61.83	51.83	-21.99	-25.77
3	0.32991	10.17	24.33	9.29	34.50	19.46	59.45	49.45	-24.95	-29.99
4	0.72656	10.21	28.30	16.72	38.51	26.93	56.00	46.00	-17.49	-19.07
5	3.77168	10.39	18.64	9.78	29.03	20.17	56.00	46.00	-26.97	-25.83
6	5.79784	10.49	20.45	12.98	30.94	23.47	60.00	50.00	-29.06	-26.53

Remarks:

1. Q.P. and AV. are abbreviations of quasi-peak and average individually.
2. The emission levels of other frequencies were very low against the limit.
3. Margin value = Emission level – Limit value
4. Correction factor = Insertion loss + Cable loss
5. Emission Level = Correction Factor + Reading Value

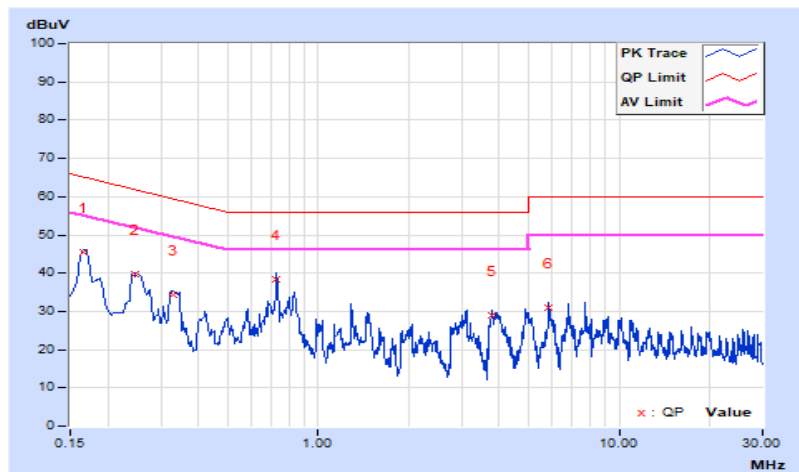

7.6 Unwanted Emissions below 1 GHz

Mode A

RF Mode	BT-LE 2M	Channel	CH 0 : 2402 MHz
Frequency Range	30 MHz ~ 1 GHz	Detector Function & Bandwidth	QP: RB=120kHz, DET=Quasi-Peak
Input Power	3.7 Vdc	Environmental Conditions	23°C, 69% RH
Tested By	Jed Wu		

Antenna Polarity & Test Distance : Horizontal at 3 m

No	Frequency (MHz)	Emission Level (dBuV/m)	Limit (dBuV/m)	Margin (dB)	Antenna Height (m)	Table Angle (Degree)	Raw Value (dBuV)	Correction Factor (dB/m)
1	66.42	24.1 QP	40.0	-15.9	1.82 H	18	34.4	-10.3
2	157.56	20.0 QP	43.5	-23.5	1.43 H	118	28.2	-8.2
3	290.78	20.7 QP	46.0	-25.3	1.69 H	291	27.3	-6.6
4	329.34	22.3 QP	46.0	-23.7	1.72 H	287	27.7	-5.4
5	401.51	24.5 QP	46.0	-21.5	1.91 H	179	28.8	-4.3
6	454.67	25.0 QP	46.0	-21.0	1.32 H	350	27.8	-2.8

Remarks:

1. Emission Level(dBuV/m) = Raw Value(dBuV) + Correction Factor(dB/m)
2. Correction Factor(dB/m) = Antenna Factor(dB/m) + Cable Factor(dB) – Pre-Amplifier Factor(dB)
3. Margin value = Emission Level – Limit value
4. The other emission levels were very low against the limit of frequency range 30 MHz ~ 1 GHz.
5. The frequency range 9 kHz ~ 30 MHz: all emissions are more than 20 dB below the limit, therefore do not be recorded in this report.

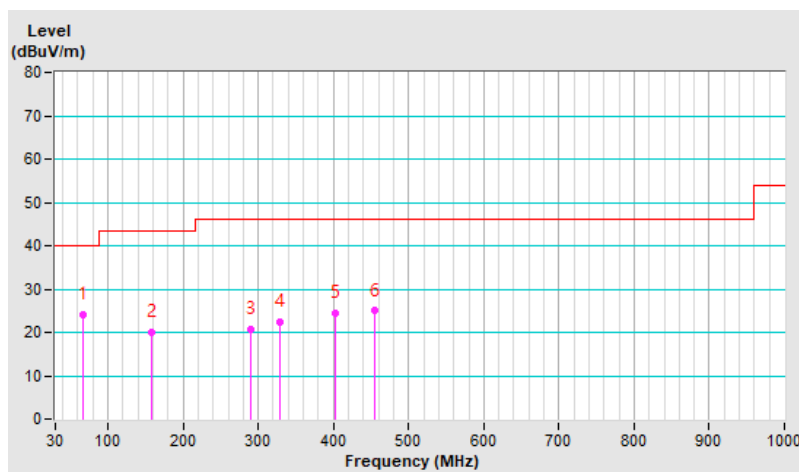

RF Mode	BT-LE 2M	Channel	CH 0 : 2402 MHz
Frequency Range	30 MHz ~ 1 GHz	Detector Function & Bandwidth	QP: RB=120kHz, DET=Quasi-Peak
Input Power	3.7 Vdc	Environmental Conditions	23°C, 69% RH
Tested By	Jed Wu		

Antenna Polarity & Test Distance : Vertical at 3 m								
No	Frequency (MHz)	Emission Level (dBuV/m)	Limit (dBuV/m)	Margin (dB)	Antenna Height (m)	Table Angle (Degree)	Raw Value (dBuV)	Correction Factor (dB/m)
1	36.45	28.5 QP	40.0	-11.5	1.28 V	360	38.6	-10.1
2	148.97	18.7 QP	43.5	-24.8	1.43 V	30	27.2	-8.5
3	280.94	20.3 QP	46.0	-25.7	1.50 V	110	27.2	-6.9
4	351.94	21.9 QP	46.0	-24.1	1.67 V	322	27.3	-5.4
5	432.50	24.8 QP	46.0	-21.2	1.93 V	188	28.1	-3.3
6	514.85	26.8 QP	46.0	-19.2	1.10 V	331	28.5	-1.7

Remarks:

1. Emission Level(dBuV/m) = Raw Value(dBuV) + Correction Factor(dB/m)
2. Correction Factor(dB/m) = Antenna Factor(dB/m) + Cable Factor(dB) – Pre-Amplifier Factor(dB)
3. Margin value = Emission Level – Limit value
4. The other emission levels were very low against the limit of frequency range 30 MHz ~ 1 GHz.
5. The frequency range 9 kHz ~ 30 MHz: all emissions are more than 20 dB below the limit, therefore do not be recorded in this report.

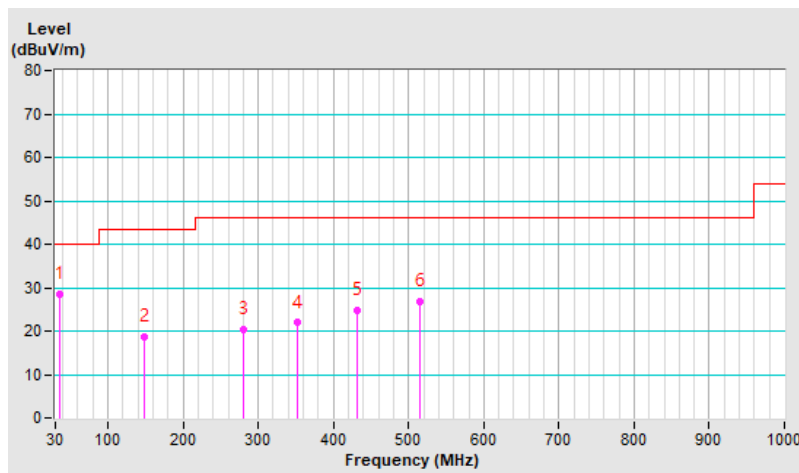

Mode B

Frequency Range	30 MHz ~ 1 GHz	Detector Function & Bandwidth	QP: RB=120kHz, DET=Quasi-Peak
Input Power	120 Vac, 60 Hz	Environmental Conditions	23°C, 69% RH
Tested By	Jed Wu		

Antenna Polarity & Test Distance : Horizontal at 3 m								
No	Frequency (MHz)	Emission Level (dBuV/m)	Limit (dBuV/m)	Margin (dB)	Antenna Height (m)	Table Angle (Degree)	Raw Value (dBuV)	Correction Factor (dB/m)
1	66.52	22.6 QP	40.0	-17.4	1.10 H	96	32.9	-10.3
2	193.15	25.0 QP	43.5	-18.5	1.07 H	272	35.9	-10.9
3	262.22	24.2 QP	46.0	-21.8	1.34 H	1	31.9	-7.7
4	383.86	23.5 QP	46.0	-22.5	1.26 H	106	28.1	-4.6
5	474.16	25.1 QP	46.0	-20.9	1.46 H	325	27.6	-2.5
6	558.99	27.4 QP	46.0	-18.6	1.58 H	142	28.3	-0.9

Remarks:

1. Emission Level(dBuV/m) = Raw Value(dBuV) + Correction Factor(dB/m)
2. Correction Factor(dB/m) = Antenna Factor(dB/m) + Cable Factor(dB) – Pre-Amplifier Factor(dB)
3. Margin value = Emission Level – Limit value
4. The other emission levels were very low against the limit of frequency range 30 MHz ~ 1 GHz.
5. The frequency range 9 kHz ~ 30 MHz: all emissions are more than 20 dB below the limit, therefore do not be recorded in this report.

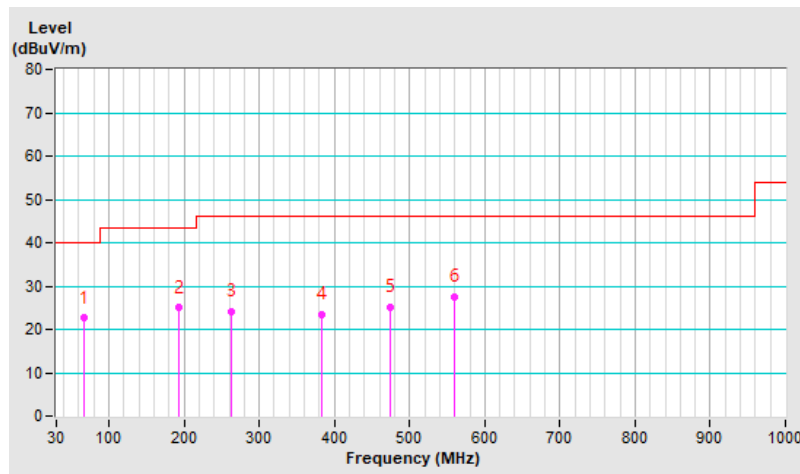

Frequency Range	30 MHz ~ 1 GHz	Detector Function & Bandwidth	QP: RB=120kHz, DET=Quasi-Peak
Input Power	120 Vac, 60 Hz	Environmental Conditions	23°C, 69% RH
Tested By	Jed Wu		

Antenna Polarity & Test Distance : Vertical at 3 m								
No	Frequency (MHz)	Emission Level (dBuV/m)	Limit (dBuV/m)	Margin (dB)	Antenna Height (m)	Table Angle (Degree)	Raw Value (dBuV)	Correction Factor (dB/m)
1	36.40	31.4 QP	40.0	-8.6	1.26 V	224	41.5	-10.1
2	67.49	24.6 QP	40.0	-15.4	1.53 V	18	35.1	-10.5
3	142.42	25.4 QP	43.5	-18.1	1.49 V	262	34.3	-8.9
4	178.85	24.2 QP	43.5	-19.3	1.86 V	262	33.7	-9.5
5	278.71	22.0 QP	46.0	-24.0	1.73 V	262	28.9	-6.9
6	355.39	22.4 QP	46.0	-23.6	1.02 V	253	27.8	-5.4

Remarks:

1. Emission Level(dBuV/m) = Raw Value(dBuV) + Correction Factor(dB/m)
2. Correction Factor(dB/m) = Antenna Factor(dB/m) + Cable Factor(dB) – Pre-Amplifier Factor(dB)
3. Margin value = Emission Level – Limit value
4. The other emission levels were very low against the limit of frequency range 30 MHz ~ 1 GHz.
5. The frequency range 9 kHz ~ 30 MHz: all emissions are more than 20 dB below the limit, therefore do not be recorded in this report.

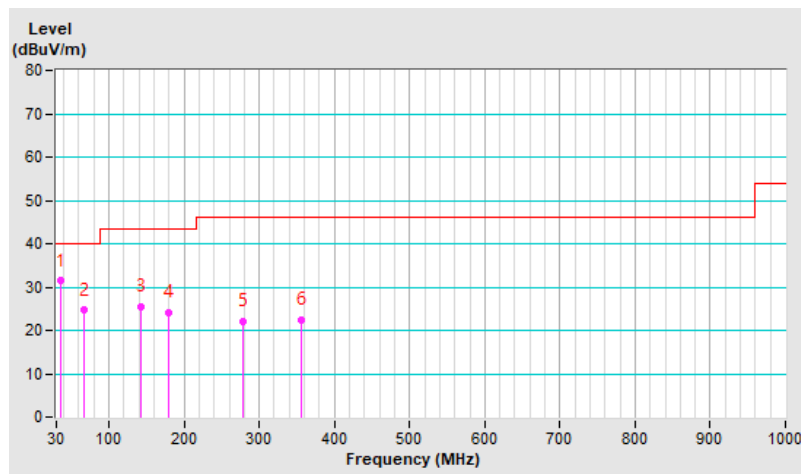

7.7 Unwanted Emissions above 1 GHz

RF Mode	BT-LE 1M	Channel	CH 0 : 2402 MHz
Frequency Range	1 GHz ~ 25 GHz	Detector Function & Bandwidth	PK: RB=1 MHz, VB=3 MHz, DET=Peak AV: RB=1 MHz, VB=3 kHz, DET=Peak
Input Power	3.7 Vdc	Environmental Conditions	23°C, 69% RH
Tested By	Jed Wu		

Antenna Polarity & Test Distance : Horizontal at 3 m								
No	Frequency (MHz)	Emission Level (dBuV/m)	Limit (dBuV/m)	Margin (dB)	Antenna Height (m)	Table Angle (Degree)	Raw Value (dBuV)	Correction Factor (dB/m)
1	2390.00	52.6 PK	74.0	-21.4	1.51 H	252	53.8	-1.2
2	2390.00	40.1 AV	54.0	-13.9	1.51 H	252	41.3	-1.2
3	*2402.00	84.7 PK			1.51 H	252	86.0	-1.3
4	*2402.00	82.7 AV			1.51 H	252	84.0	-1.3
5	4804.00	54.9 PK	74.0	-19.1	3.35 H	304	46.8	8.1
6	4804.00	48.6 AV	54.0	-5.4	3.35 H	304	40.5	8.1
Antenna Polarity & Test Distance : Vertical at 3 m								
No	Frequency (MHz)	Emission Level (dBuV/m)	Limit (dBuV/m)	Margin (dB)	Antenna Height (m)	Table Angle (Degree)	Raw Value (dBuV)	Correction Factor (dB/m)
1	2390.00	52.3 PK	74.0	-21.7	3.93 V	250	53.5	-1.2
2	2390.00	39.8 AV	54.0	-14.2	3.93 V	250	41.0	-1.2
3	*2402.00	80.0 PK			3.93 V	250	81.3	-1.3
4	*2402.00	78.6 AV			3.93 V	250	79.9	-1.3
5	4804.00	51.1 PK	74.0	-22.9	1.10 V	280	43.0	8.1
6	4804.00	41.6 AV	54.0	-12.4	1.10 V	280	33.5	8.1

Remarks:

1. Emission Level(dBuV/m) = Raw Value(dBuV) + Correction Factor(dB/m)
2. Correction Factor(dB/m) = Antenna Factor(dB/m) + Cable Factor(dB) – Pre-Amplifier Factor(dB)
3. Margin value = Emission Level – Limit value
4. The other emission levels were very low against the limit.
5. " * " : Fundamental frequency, the limit was restricted at the RF Output Power.



RF Mode	BT-LE 1M	Channel	CH 19 : 2440 MHz
Frequency Range	1 GHz ~ 25 GHz	Detector Function & Bandwidth	PK: RB=1 MHz, VB=3 MHz, DET=Peak AV: RB=1 MHz, VB=3 kHz, DET=Peak
Input Power	3.7 Vdc	Environmental Conditions	23°C, 69% RH
Tested By	Jed Wu		

Antenna Polarity & Test Distance : Horizontal at 3 m

No	Frequency (MHz)	Emission Level (dBuV/m)	Limit (dBuV/m)	Margin (dB)	Antenna Height (m)	Table Angle (Degree)	Raw Value (dBuV)	Correction Factor (dB/m)
1	*2440.00	84.8 PK			1.49 H	250	85.8	-1.0
2	*2440.00	83.4 AV			1.49 H	250	84.4	-1.0
3	4880.00	54.1 PK	74.0	-19.9	2.31 H	326	46.1	8.0
4	4880.00	47.5 AV	54.0	-6.5	2.31 H	326	39.5	8.0

Antenna Polarity & Test Distance : Vertical at 3 m

No	Frequency (MHz)	Emission Level (dBuV/m)	Limit (dBuV/m)	Margin (dB)	Antenna Height (m)	Table Angle (Degree)	Raw Value (dBuV)	Correction Factor (dB/m)
1	*2440.00	80.2 PK			3.91 V	248	81.2	-1.0
2	*2440.00	79.3 AV			3.91 V	248	80.3	-1.0
3	4880.00	50.3 PK	74.0	-23.7	2.14 V	302	42.3	8.0
4	4880.00	40.5 AV	54.0	-13.5	2.14 V	302	32.5	8.0

Remarks:

1. Emission Level(dBuV/m) = Raw Value(dBuV) + Correction Factor(dB/m)
2. Correction Factor(dB/m) = Antenna Factor(dB/m) + Cable Factor(dB) – Pre-Amplifier Factor(dB)
3. Margin value = Emission Level – Limit value
4. The other emission levels were very low against the limit.
5. " * " : Fundamental frequency, the limit was restricted at the RF Output Power.



RF Mode	BT-LE 1M	Channel	CH 39 : 2480 MHz
Frequency Range	1 GHz ~ 25 GHz	Detector Function & Bandwidth	PK: RB=1 MHz, VB=3 MHz, DET=Peak AV: RB=1 MHz, VB=3 kHz, DET=Peak
Input Power	3.7 Vdc	Environmental Conditions	23°C, 69% RH
Tested By	Jed Wu		

Antenna Polarity & Test Distance : Horizontal at 3 m

No	Frequency (MHz)	Emission Level (dBuV/m)	Limit (dBuV/m)	Margin (dB)	Antenna Height (m)	Table Angle (Degree)	Raw Value (dBuV)	Correction Factor (dB/m)
1	*2480.00	87.9 PK			1.47 H	244	88.9	-1.0
2	*2480.00	86.5 AV			1.47 H	244	87.5	-1.0
3	2483.50	52.5 PK	74.0	-21.5	1.47 H	244	53.4	-0.9
4	2483.50	40.4 AV	54.0	-13.6	1.47 H	244	41.3	-0.9
5	4960.00	57.1 PK	74.0	-16.9	2.73 H	330	49.1	8.0
6	4960.00	51.9 AV	54.0	-2.1	2.73 H	330	43.9	8.0

Antenna Polarity & Test Distance : Vertical at 3 m

No	Frequency (MHz)	Emission Level (dBuV/m)	Limit (dBuV/m)	Margin (dB)	Antenna Height (m)	Table Angle (Degree)	Raw Value (dBuV)	Correction Factor (dB/m)
1	*2480.00	83.5 PK			3.89 V	258	84.5	-1.0
2	*2480.00	82.6 AV			3.89 V	258	83.6	-1.0
3	2483.50	52.1 PK	74.0	-21.9	3.89 V	258	53.0	-0.9
4	2483.50	40.0 AV	54.0	-14.0	3.89 V	258	40.9	-0.9
5	4960.00	53.3 PK	74.0	-20.7	1.72 V	306	45.3	8.0
6	4960.00	44.9 AV	54.0	-9.1	1.72 V	306	36.9	8.0

Remarks:

1. Emission Level(dBuV/m) = Raw Value(dBuV) + Correction Factor(dB/m)
2. Correction Factor(dB/m) = Antenna Factor(dB/m) + Cable Factor(dB) – Pre-Amplifier Factor(dB)
3. Margin value = Emission Level – Limit value
4. The other emission levels were very low against the limit.
5. " * ": Fundamental frequency, the limit was restricted at the RF Output Power.



RF Mode	BT-LE 2M	Channel	CH 0 : 2402 MHz
Frequency Range	1 GHz ~ 25 GHz	Detector Function & Bandwidth	PK: RB=1 MHz, VB=3 MHz, DET=Peak AV: RB=1 MHz, VB=1 kHz, DET=Peak
Input Power	3.7 Vdc	Environmental Conditions	23°C, 69% RH
Tested By	Jed Wu		

Antenna Polarity & Test Distance : Horizontal at 3 m

No	Frequency (MHz)	Emission Level (dBuV/m)	Limit (dBuV/m)	Margin (dB)	Antenna Height (m)	Table Angle (Degree)	Raw Value (dBuV)	Correction Factor (dB/m)
1	2390.00	52.5 PK	74.0	-21.5	1.35 H	248	53.7	-1.2
2	2390.00	39.2 AV	54.0	-14.8	1.35 H	248	40.4	-1.2
3	*2402.00	88.5 PK			1.35 H	248	89.8	-1.3
4	*2402.00	85.2 AV			1.35 H	248	86.5	-1.3
5	4804.00	60.5 PK	74.0	-13.5	3.35 H	317	52.4	8.1
6	4804.00	51.1 AV	54.0	-2.9	3.35 H	317	43.0	8.1

Antenna Polarity & Test Distance : Vertical at 3 m

No	Frequency (MHz)	Emission Level (dBuV/m)	Limit (dBuV/m)	Margin (dB)	Antenna Height (m)	Table Angle (Degree)	Raw Value (dBuV)	Correction Factor (dB/m)
1	2390.00	52.2 PK	74.0	-21.8	3.77 V	254	53.4	-1.2
2	2390.00	38.9 AV	54.0	-15.1	3.77 V	254	40.1	-1.2
3	*2402.00	83.8 PK			3.77 V	254	85.1	-1.3
4	*2402.00	81.2 AV			3.77 V	254	82.5	-1.3
5	4804.00	56.7 PK	74.0	-17.3	1.10 V	293	48.6	8.1
6	4804.00	44.1 AV	54.0	-9.9	1.10 V	293	36.0	8.1

Remarks:

1. Emission Level(dBuV/m) = Raw Value(dBuV) + Correction Factor(dB/m)
2. Correction Factor(dB/m) = Antenna Factor(dB/m) + Cable Factor(dB) – Pre-Amplifier Factor(dB)
3. Margin value = Emission Level – Limit value
4. The other emission levels were very low against the limit.
5. " * ": Fundamental frequency, the limit was restricted at the RF Output Power.



RF Mode	BT-LE 2M	Channel	CH 19 : 2440 MHz
Frequency Range	1 GHz ~ 25 GHz	Detector Function & Bandwidth	PK: RB=1 MHz, VB=3 MHz, DET=Peak AV: RB=1 MHz, VB=1 kHz, DET=Peak
Input Power	3.7 Vdc	Environmental Conditions	23°C, 69% RH
Tested By	Jed Wu		

Antenna Polarity & Test Distance : Horizontal at 3 m

No	Frequency (MHz)	Emission Level (dBuV/m)	Limit (dBuV/m)	Margin (dB)	Antenna Height (m)	Table Angle (Degree)	Raw Value (dBuV)	Correction Factor (dB/m)
1	*2440.00	88.5 PK			1.50 H	249	89.5	-1.0
2	*2440.00	85.2 AV			1.50 H	249	86.2	-1.0
3	4880.00	59.4 PK	74.0	-14.6	2.31 H	327	51.4	8.0
4	4880.00	49.9 AV	54.0	-4.1	2.31 H	327	41.9	8.0

Antenna Polarity & Test Distance : Vertical at 3 m

No	Frequency (MHz)	Emission Level (dBuV/m)	Limit (dBuV/m)	Margin (dB)	Antenna Height (m)	Table Angle (Degree)	Raw Value (dBuV)	Correction Factor (dB/m)
1	*2440.00	83.8 PK			3.92 V	254	84.8	-1.0
2	*2440.00	81.1 AV			3.92 V	254	82.1	-1.0
3	4880.00	55.6 PK	74.0	-18.4	1.11 V	276	47.6	8.0
4	4880.00	42.9 AV	54.0	-11.1	1.11 V	276	34.9	8.0

Remarks:

1. Emission Level(dBuV/m) = Raw Value(dBuV) + Correction Factor(dB/m)
2. Correction Factor(dB/m) = Antenna Factor(dB/m) + Cable Factor(dB) – Pre-Amplifier Factor(dB)
3. Margin value = Emission Level – Limit value
4. The other emission levels were very low against the limit.
5. " * " : Fundamental frequency, the limit was restricted at the RF Output Power.



RF Mode	BT-LE 2M	Channel	CH 39 : 2480 MHz
Frequency Range	1 GHz ~ 25 GHz	Detector Function & Bandwidth	PK: RB=1 MHz, VB=3 MHz, DET=Peak AV: RB=1 MHz, VB=1 kHz, DET=Peak
Input Power	3.7 Vdc	Environmental Conditions	23°C, 69% RH
Tested By	Jed Wu		

Antenna Polarity & Test Distance : Horizontal at 3 m

No	Frequency (MHz)	Emission Level (dBuV/m)	Limit (dBuV/m)	Margin (dB)	Antenna Height (m)	Table Angle (Degree)	Raw Value (dBuV)	Correction Factor (dB/m)
1	*2480.00	87.4 PK			1.46 H	247	88.4	-1.0
2	*2480.00	84.4 AV			1.46 H	247	85.4	-1.0
3	2483.50	52.6 PK	74.0	-21.4	1.46 H	247	53.5	-0.9
4	2483.50	39.4 AV	54.0	-14.6	1.46 H	247	40.3	-0.9
5	4960.00	56.4 PK	74.0	-17.6	3.50 H	302	48.4	8.0
6	4960.00	46.7 AV	54.0	-7.3	3.50 H	302	38.7	8.0

Antenna Polarity & Test Distance : Vertical at 3 m

No	Frequency (MHz)	Emission Level (dBuV/m)	Limit (dBuV/m)	Margin (dB)	Antenna Height (m)	Table Angle (Degree)	Raw Value (dBuV)	Correction Factor (dB/m)
1	*2480.00	82.8 PK			3.88 V	255	83.8	-1.0
2	*2480.00	80.0 AV			3.88 V	255	81.0	-1.0
3	2483.50	52.3 PK	74.0	-21.7	3.88 V	255	53.2	-0.9
4	2483.50	39.1 AV	54.0	-14.9	3.88 V	255	40.0	-0.9
5	4960.00	52.6 PK	74.0	-21.4	1.25 V	282	44.6	8.0
6	4960.00	39.7 AV	54.0	-14.3	1.25 V	282	31.7	8.0

Remarks:

1. Emission Level(dBuV/m) = Raw Value(dBuV) + Correction Factor(dB/m)
2. Correction Factor(dB/m) = Antenna Factor(dB/m) + Cable Factor(dB) – Pre-Amplifier Factor(dB)
3. Margin value = Emission Level – Limit value
4. The other emission levels were very low against the limit.
5. " * ": Fundamental frequency, the limit was restricted at the RF Output Power.

Plot of Band Edge

Frequency Range	2.31 GHz ~ 2.5 GHz	Detector Function & Bandwidth	PK: RB=1 MHz, VB=3 MHz, DET=Peak AV: RB=1 MHz, VB=3 kHz, DET=Peak
-----------------	--------------------	-------------------------------	--

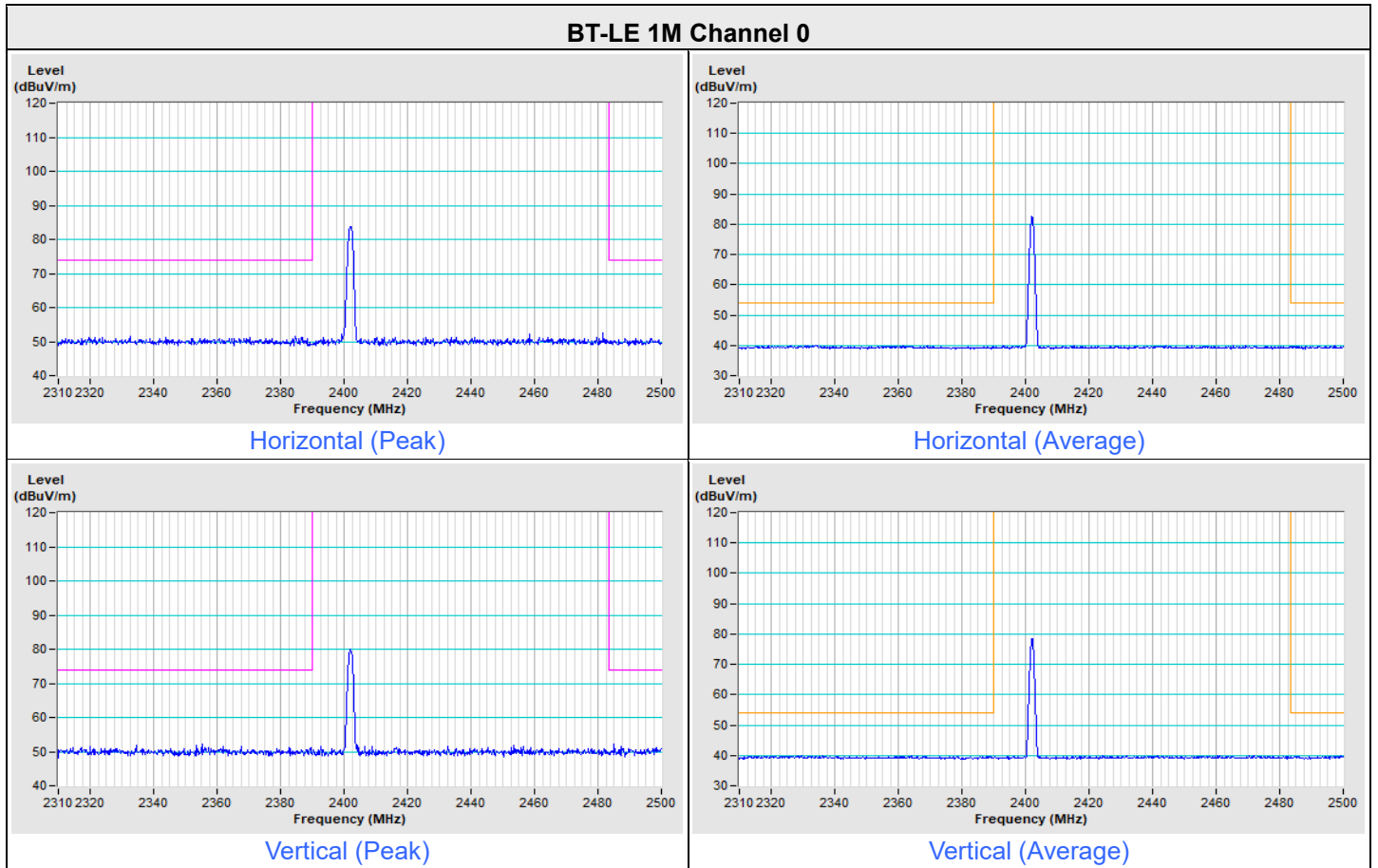

BT-LE 1M Channel 39

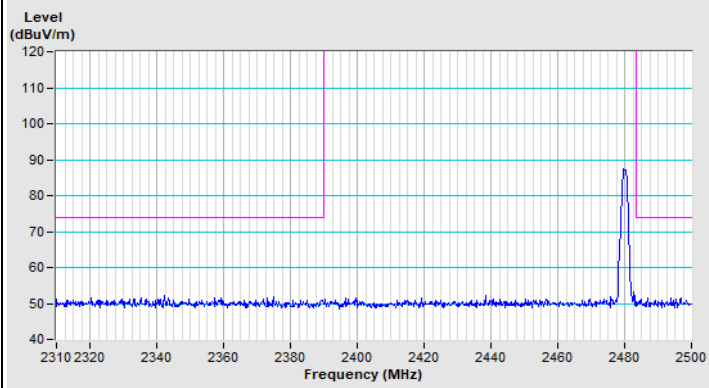

Horizontal (Peak)

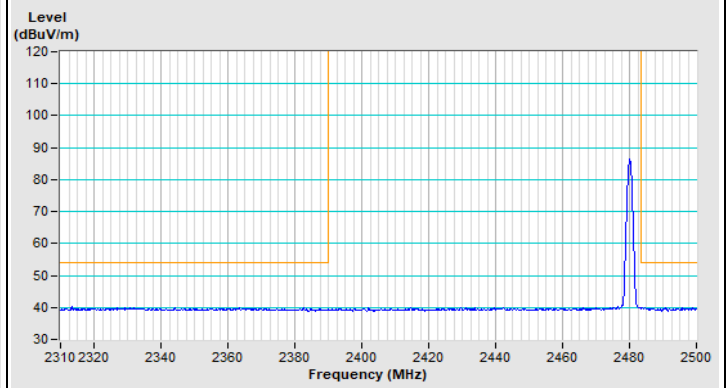

Horizontal (Average)

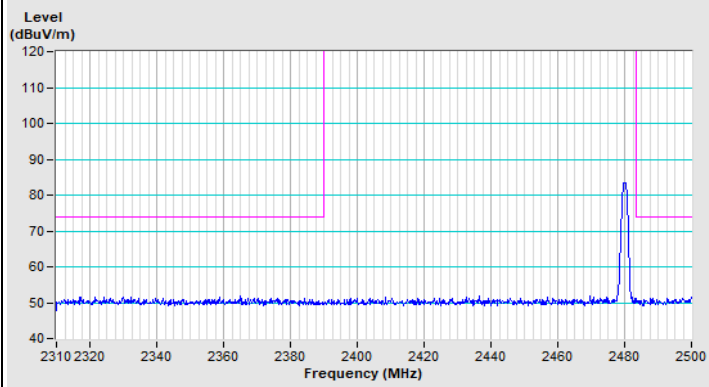

Vertical (Peak)

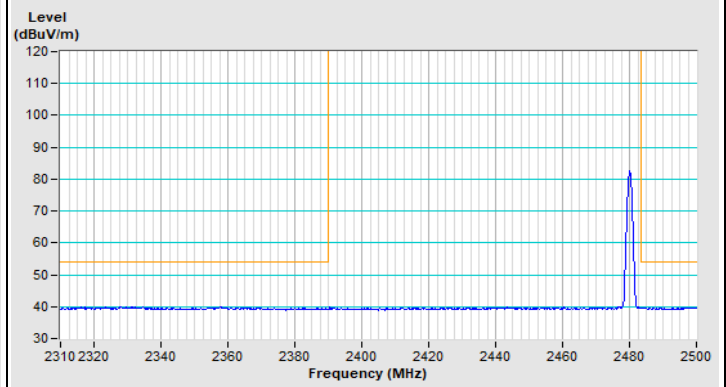

Vertical (Average)

Frequency Range	2.31 GHz ~ 2.5 GHz	Detector Function & Bandwidth	PK: RB=1 MHz, VB=3 MHz, DET=Peak AV: RB=1 MHz, VB=1 kHz, DET=Peak
-----------------	--------------------	-------------------------------	--

BT-LE 2M Channel 0

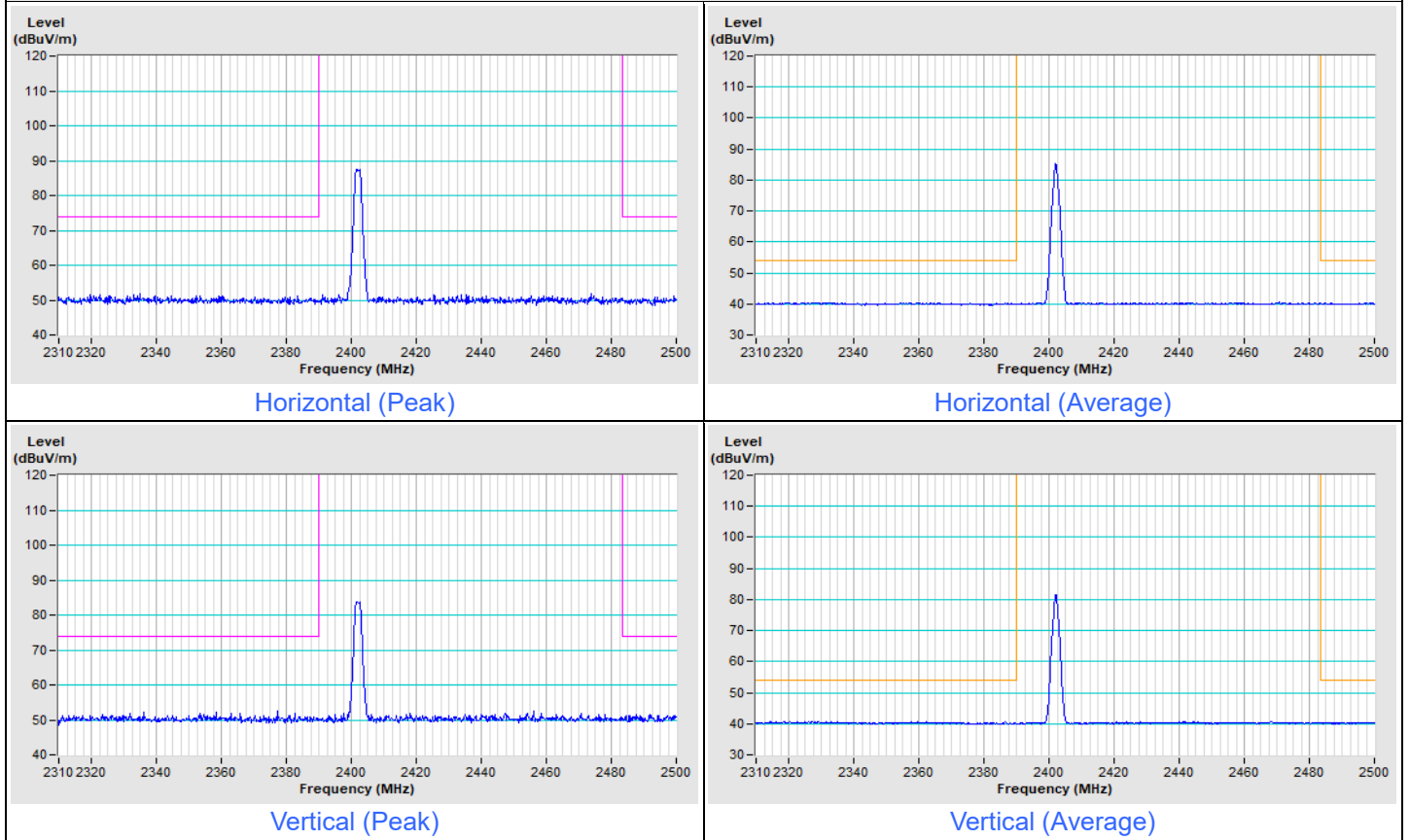

BT-LE 2M Channel 39

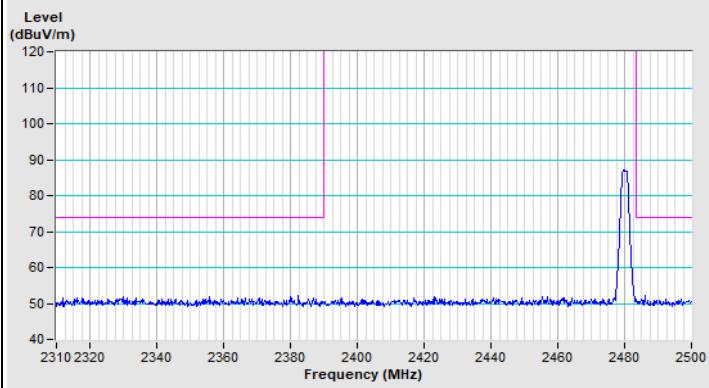

Horizontal (Peak)

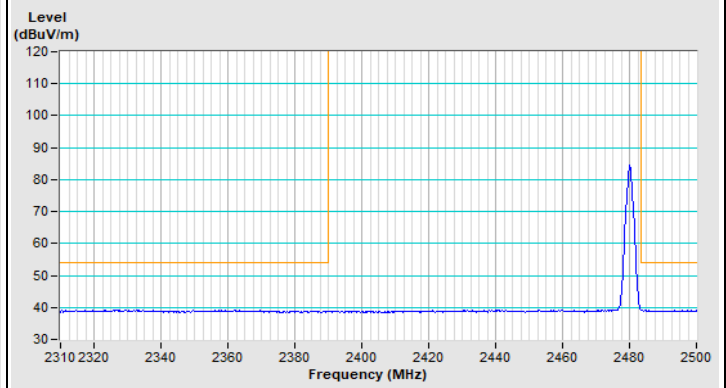

Horizontal (Average)

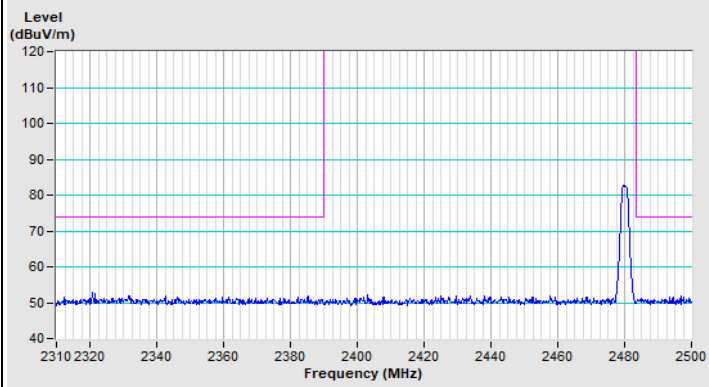

Vertical (Peak)

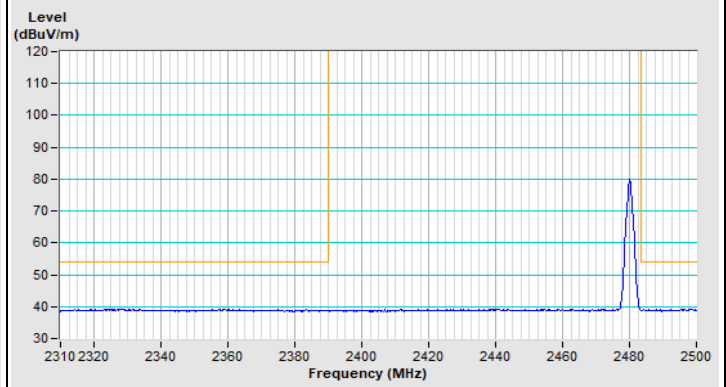

Vertical (Average)

8 Pictures of Test Arrangements

Please refer to the attached file (Test Setup Photo)

9 Information of the Testing Laboratories

We, Bureau Veritas Consumer Products Services (H.K.) Ltd., Taoyuan Branch, were founded in 1988 to provide our best service in EMC, Radio, Telecom and Safety consultation. Our laboratories are FCC recognized accredited test firms and accredited according to ISO/IEC 17025.

If you have any comments, please feel free to contact us at the following:

Lin Kou EMC/RF Lab

Tel: 886-2-26052180

Fax: 886-2-26051924

Hsin Chu EMC/RF/Telecom Lab

Tel: 886-3-6668565

Fax: 886-3-6668323

Hwa Ya EMC/RF/Safety Lab

Tel: 886-3-3183232

Fax: 886-3-3270892

Email: service.adt@bureauveritas.com

Web Site: <http://ee.bureauveritas.com.tw>

The address and road map of all our labs can be found in our web site also.

--- END ---