



东莞市仕研电子通讯有限公司

DONGGUAN SEYA ELECTRONIC COMMUNICATION CO.,LTD

规格承认书

SPECIFICATION FOR APPROVAL

客户

CUSTOMER: Tinyphoton Ltd.

客户地址

Customer Address: Room A708 Hui bao jiang Building, No. 398

Minzhi Avenue, Shenzhen, China.

客户料号

CUSTOMER NO: 4051400000019

品名

PART NAME: 2.4-5.8G WIFI ANTENNA

供方料号

SUPPLIER NO: SY-W90PE2283B070C-L01

送样日期Date: 2022.12.07

送样数量Q' TY: PCS

客户确认 CUSTOMER APPROVED BY		
APPROVAL	CHIEF	SUPERVISOR

供方确认 SUPPLIER SIGNATURE		
APPROVAL	CHECK	DESIGN
Jammy	Jerry	Patrick



東莞市仕研電子通訊有限公司

DONGGUAN SEYA ELECTRONIC COMMUNICATION CO.,LTD

承认书项目表

Spec Item

NO.	内容 (Contents)	页数 (Number of Page)	页码 (Page Code)
1	承认书封面 (Spec Cover)	1	1
2	承认书项目表 (Spec Item)	1	2
3	产品图片 (Product Pictures)	1	3
4	产品规格描述 (Product specification describes)	1	4
4	工程成品图 (Drawing)	1	5
5	包装规范 (Packing Specification)	1	6
6	网络测试 (Network Test)	4	7-10



東莞市仕研電子通訊有限公司

DONGGUAN SEYA ELECTRONIC COMMUNICATION CO.,LTD

产品图片

Product Pictures





产品规格概述

Product specification describes

Electrical Properties	
Frequency	2400-2500;5150-5850MHz
Impedance	50 Ohm Nominal
V.S.W.R	≤ 2.0
Radiation	Omni-directional
Gain (Peak)	2.4G @ 1.2dBi 5.8G @ 4.0dBi
Connector	MHF-4
Physical Properties	
Antenna Material	FPC
Cable Type	0.81 CABLE
Storage Temp.	-20 ~ +75 °C
Cable Color	BLACK

2	1
REV.	CONTENT
A	First
DATE	2022-09-17

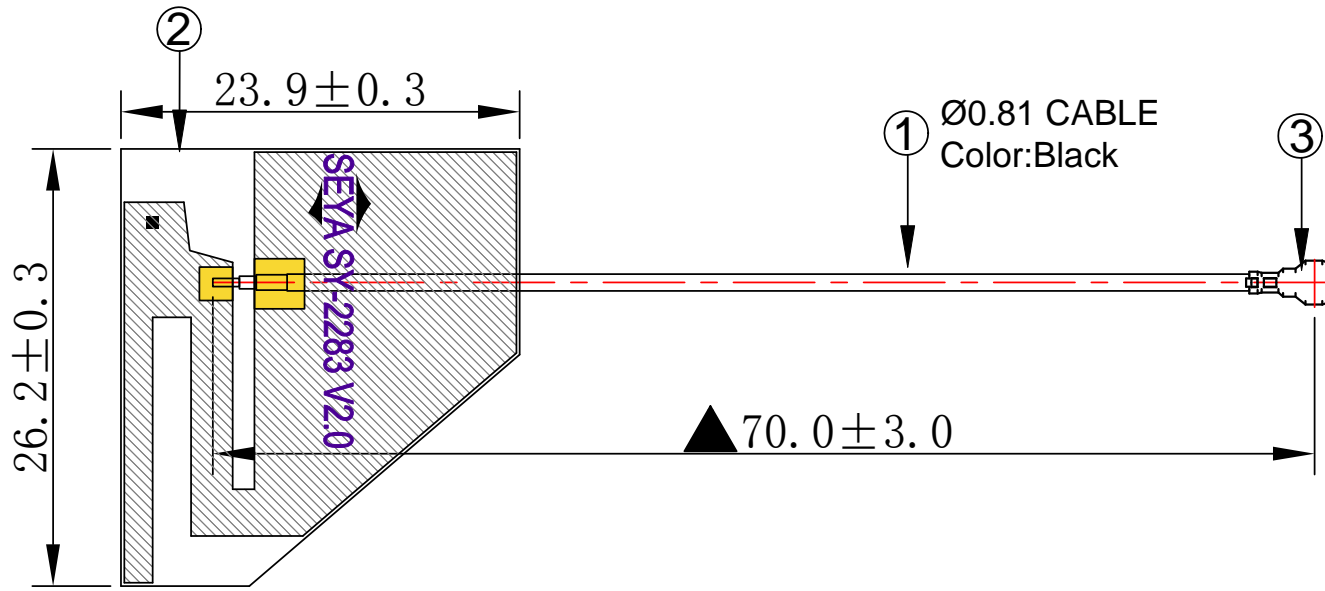

Note:
 Network Test:
 Test Frequency Band: 2400-2500;5150-5850MHz
 VSWR:2.0MAX
 GAIN:2.4G @ 1.2dBi
 5.8G @ 4.0dBi

 东莞市仕研电子通讯有限公司 DONGGUAN SEYA ELECTRONIC COMMUNICATION CO.,LTD			CUSTOMER		05.01.606	
			PART NO			
TOLERANCE UNLESS OTHERWISE SPECIFIED			TITLE		2.4-5.8GHz WIFI ANTENNA	
			S. H P/NO		SY-W90PE2283B070C-L01	
UNIT:mm SHEET: 1/1 SCALE: 1/1			SIZE	DRAWN	CHECKED	APPROVED
ANGLES ±0.5° X. ±2.0 X.XX ±0.2 XX. ±5.0 X.X ±0.5 DATE:2022-09-17			A4	Patrick	Jerry	Jammy

			1PC
			1PC
			1PC
			Q'ty





包裝規範
Packing

产品料号 P/N	SY-W90PE2283B070C-L01	版本 Rev	A
产品品名 ITEM	2.4-5.8GHz WIFI ANTENNA	客户 CUS	

包裝步骤与规范如下:

Packaging steps and specifications are as follows

1. 产品照片Product photos	2. 50PCS/Bun; 100PCS/PE BAG
	
3. XXX PCS装箱, 可根据订单数量及可装箱数量进行包装。Packing can be carried out according to the order quantity and the quantity that can be packed.	4. 放入纸箱内打好包装带贴上相应的标签Put it into the carton, make the packing tape and stick the corresponding label
	

Approved : Jammy

Audit : Jerry

Formulate : Patrick



Network test 网络测试

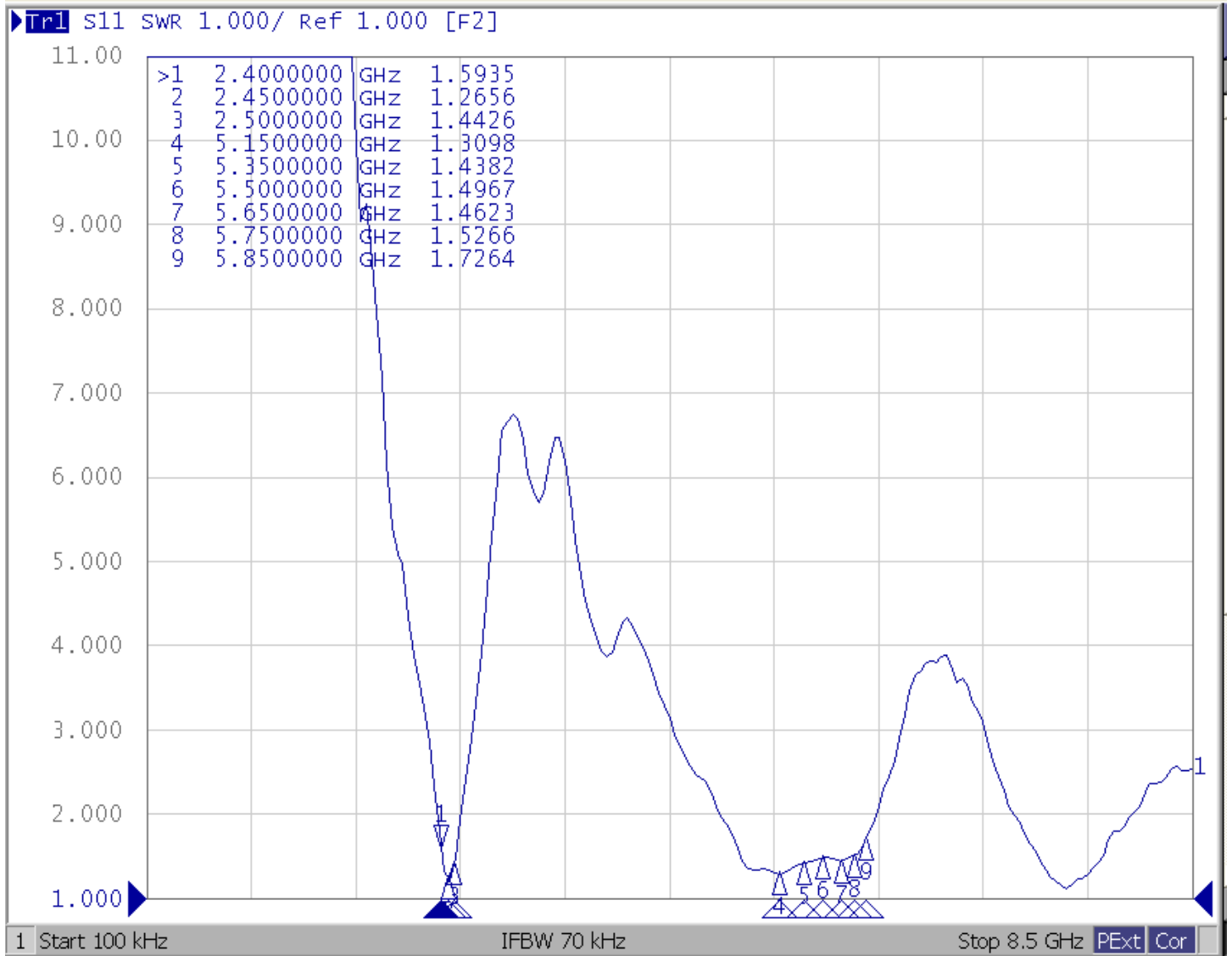



東莞市仕研電子通訊有限公司
DONGGUAN SEYA ELECTRONIC COMMUNICATION CO.,LTD

Field Plot 2.4G

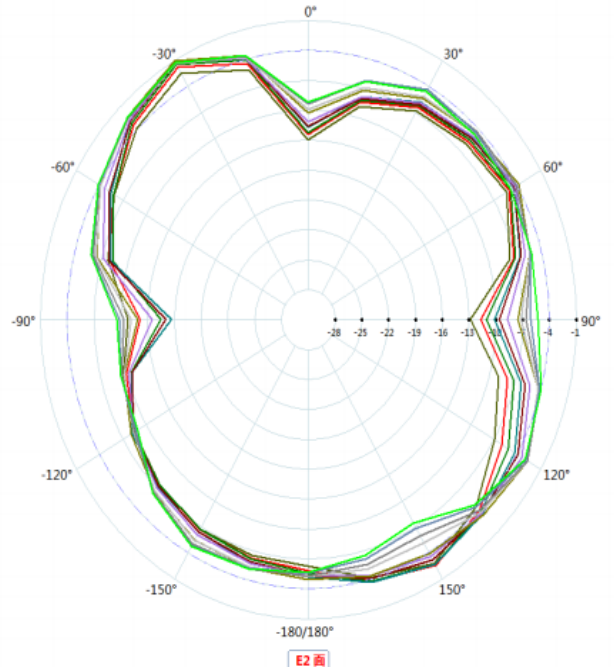
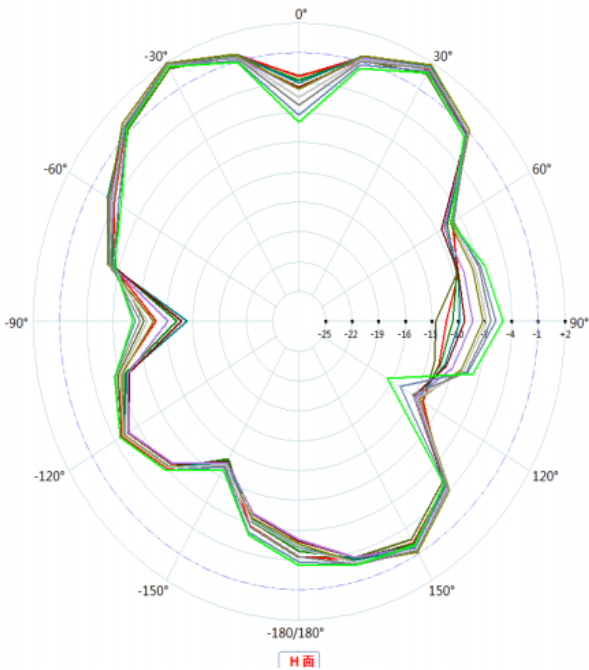
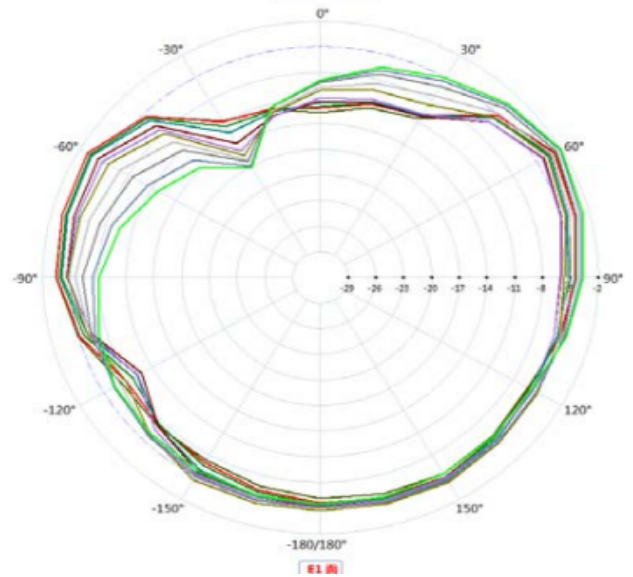
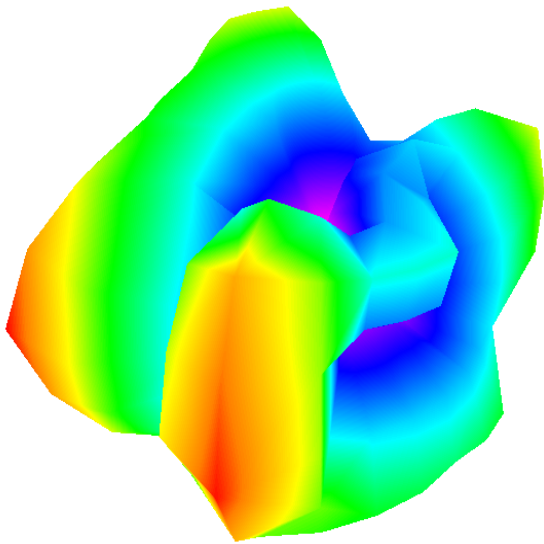



東莞市仕研電子通訊有限公司
DONGGUAN SEYA ELECTRONIC COMMUNICATION CO.,LTD

Field Plot 5.8G

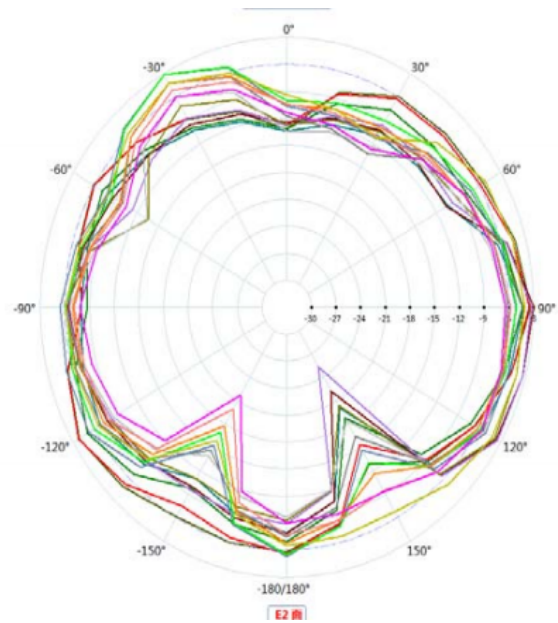
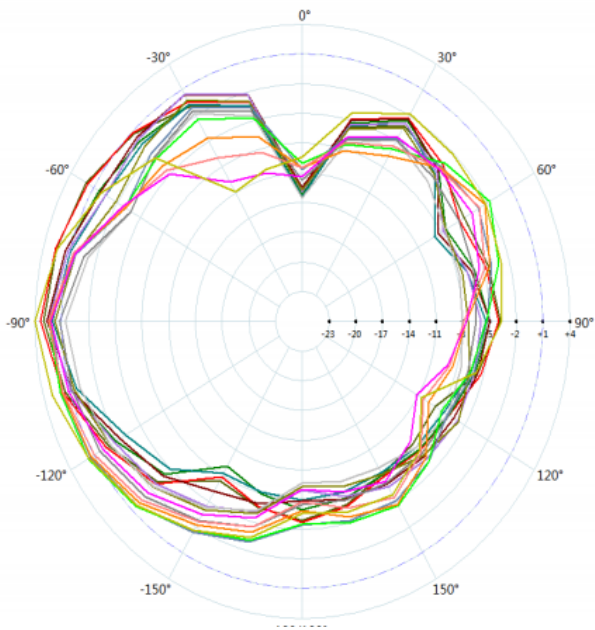
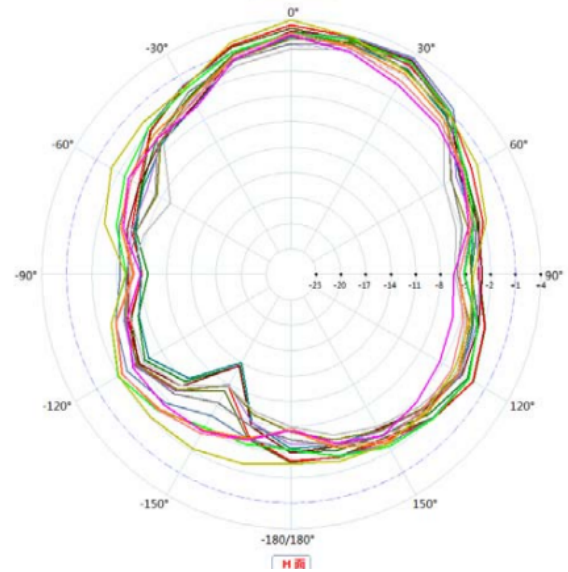
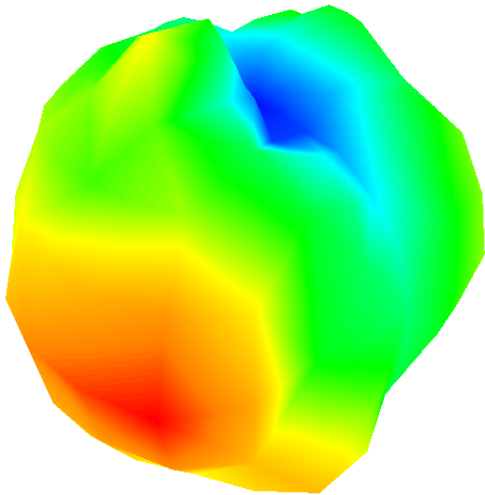



Passive Data
无源数据

Freq (MHz)	Effi (%)	Gain (dBi)
2400	43.28	1.15
2450	42.07	1.20
2500	40.24	1.02
5150	59.84	4.01
5350	53.95	3.55
5500	50.36	3.54
5650	52.45	3.49
5750	51.54	3.55
5850	50.58	3.48