

TEST REPORT

FCC Rules Part 15.247

Report Reference No.....: MTEB23020129-R2

FCC ID..... : 2BAA5-MNX6

Compiled by
(position+printed name+signature)..: File administrators Alisa Luo



Supervised by
(position+printed name+signature)..: Test Engineer Sunny Deng



Approved by
(position+printed name+signature)..: Manager Yvette Zhou



Date of issue.....: **February 28, 2023**

Representative Laboratory Name .: Shenzhen Most Technology Service Co., Ltd.

Address: No.5, 2nd Langshan Road, North District, Hi-tech Industrial Park,
Nanshan, Shenzhen, Guangdong, China.

Applicant's name.....: AcoustMax International Corporation

Address: Room 501,Lingyun Building ,HongLang North 2 Road, Baoan
District, ShenZhen, China

Test specification/ Standard: FCC Rules Part 15.247

TRF Originator.....: Shenzhen Most Technology Service Co., Ltd.

Shenzhen Most Technology Service Co., Ltd. All rights reserved.

This publication may be reproduced in whole or in part for non-commercial purposes as long as the Shenzhen Most Technology Service Co., Ltd. is acknowledged as copyright owner and source of the material. Shenzhen Most Technology Service Co., Ltd. takes no responsibility for and will not assume liability for damages resulting from the reader's interpretation of the reproduced material due to its placement and context.

Test item description: X6

Trade Mark: Monster

Manufacturer: AcoustMax International Corporation

Model/Type reference.....: MNX6

Listed Models: MNX6 PLUS,MNX6+,MNX6-2,MNPAX-600,MNPAX-650,MNPAX-700,MNPAX-600-C,MNPAX-650-C,MNPAX-700-C,MNPAX-600LED,MNPAX-650LED,MNPAX-700LED,MNPAX-600LED-C, MNPAX-650LED-C,MNPAX-700LED-C

Modulation Type.....: GFSK, π/4DQPSK, 8DPSK

Operation Frequency.....: From 2402MHz to 2480MHz

Hardware Version.....: V01

Software Version: V1.0

Rating: AC 100-240V,50/60Hz,200W

Result.....: PASS

TEST REPORT

Equipment under Test : X6

Model /Type : MNX6

Listed Models : MNX6 PLUS,MNX6+,MNX6-2,MNPAX-600,MNPAX-650,
MNPAX-700,MNPAX-600-C,MNPAX-650-C,MNPAX-700-
C,MNPAX-600LED,MNPAX-650LED,MNPAX-700LED,
MNPAX-600LED-C,MNPAX-650LED-C,MNPAX-700LED-C

Remark : Only models are different.

Applicant : AcoustMax International Corporation

Address : Room 501,Lingyun Building ,HongLang North 2 Road, Baoan
District, ShenZhen, China

Manufacturer : AcoustMax International Corporation

Address : Room 501,Lingyun Building ,HongLang North 2 Road, Baoan
District, ShenZhen, China

Test Result:	PASS
---------------------	-------------

The test report merely corresponds to the test sample.
It is not permitted to copy extracts of these test result without the written permission of the test laboratory.

Contents

<u>1 REVISION HISTORY</u>	<u>4</u>
<u>2 TEST STANDARDS</u>	<u>5</u>
<u>3 SUMMARY</u>	<u>6</u>
3.1 General Remarks	6
3.2 Product Description	6
3.3 Equipment Under Test	6
3.4 Short description of the Equipment under Test (EUT)	6
3.5 EUT operation mode	7
3.6 Block Diagram of Test Setup	7
3.7 Test Item (Equipment Under Test) Description*	7
3.8 Auxiliary Equipment (AE) Description	7
3.9 Antenna Information*	7
3.10 Related Submittal(s) / Grant (s).....	8
3.11 Modifications	8
<u>4 TEST ENVIRONMENT</u>	<u>9</u>
4.1 Address of the test laboratory	9
4.2 Environmental conditions	9
4.3 Summary of measurement results	10
4.4 Statement of the measurement uncertainty	10
4.5 Equipments Used during the Test	11
<u>5 TEST CONDITIONS AND RESULTS</u>	<u>12</u>
5.1 AC Power Conducted Emission.....	12
5.2 Radiated Emission	15
5.3 Maximum Peak Output Power	21
5.4 20dB Bandwidth	22
5.5 Frequency Separation.....	26
5.6 Number of hopping frequency	30
5.7 Time of Occupancy (Dwell Time)	32
5.8 Spurious RF Conducted Emission	35
5.9 Pseudorandom Frequency Hopping Sequence	41
5.10 Antenna Requirement	42
<u>6 TEST SETUP PHOTOS OF THE EUT</u>	<u>43</u>
<u>7 PHOTOS OF THE EUT</u>	<u>44</u>

1 Revision History

Revision	Issue Date	Revisions	Revised By
00	2023.02.28	Initial Issue	Alisa Luo

2 TEST STANDARDS

The tests were performed according to following standards:

[FCC Rules Part 15.247](#): Frequency Hopping, Direct Spread Spectrum and Hybrid Systems that are in operation within the bands of 902-928 MHz, 2400-2483.5 MHz, and 5725-5850 MHz.

[ANSI C63.10-2013](#): American National Standard for Testing Unlicensed Wireless Devices

3 SUMMARY

3.1 General Remarks

Date of receipt of test sample	:	2023.02.14
Testing commenced on	:	2023.02.15
Testing concluded on	:	2023.02.23

3.2 Product Description

Product Name:	X6
Model/Type reference:	MNX6
Power Supply:	AC 100-240V,50/60Hz,200W
Testing sample ID:	MT23020119
Bluetooth :	
Supported Type:	Bluetooth BR/EDR
Modulation:	GFSK, $\pi/4$ DQPSK, 8DPSK
Operation frequency:	2402MHz~2480MHz
Channel number:	79
Channel separation:	1MHz
Antenna type:	PCB antenna
Antenna gain:	0dBi

3.3 Equipment Under Test

Power supply system utilised

Power supply voltage	:	<input type="radio"/> 230V / 50 Hz	<input checked="" type="radio"/> 120V / 60Hz
		<input type="radio"/> 12 V DC	<input type="radio"/> 24 V DC
		<input type="radio"/> Other (specified in blank below)	

AC 100-240V,50/60Hz,200W

3.4 Short description of the Equipment under Test (EUT)

This is a X6 For more details, refer to the user's manual of the EUT.

3.5 EUT operation mode

The Applicant provides communication tools software(Engineer mode) to control the EUT for staying in continuous transmitting (Duty Cycle more than 98%) and receiving mode for testing .There are 79 channels provided to the EUT and Channel 00/39/78 were selected to test.

Operation Frequency:

Channel	Frequency (MHz)
0	2402
1	2403
⋮	⋮
38	2440
39	2441
40	2442
⋮	⋮
77	2479
78	2480

3.6 Block Diagram of Test Setup

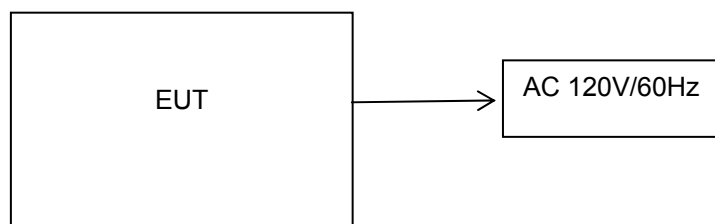

3.7 Test Item (Equipment Under Test) Description*

Short designation	EUT Name	EUT Description	Serial number	Hardware status	Software status
EUT A					
EUT B					

*: declared by the applicant. According to customers information EUTs A and B are the same devices.

3.8 Auxiliary Equipment (AE) Description

AE short designation	EUT Name (if available)	EUT Description	Serial number (if available)	Software (if used)
AE 1				
AE 2	-			

3.9 Antenna Information*

Short designation	Antenna Name	Antenna Type	Frequency Range	Serial number	Antenna Peak Gain
Antenna 1	---	PCB antenna	2.4 - 2.5 GHz	---	0dBi
Antenna 2					

*: declared by the applicant.

3.10 Related Submittal(s) / Grant (s)

This submittal(s) (test report) is intended for the device filing to comply with Section 15.247 of the FCC Part 15, Subpart C Rules.

3.11 Modifications

No modifications were implemented to meet testing criteria.

4 TEST ENVIRONMENT

4.1 Address of the test laboratory

Shenzhen Most Technology Service Co., Ltd.

No.5, 2nd Langshan Road, North District, Hi-tech Industrial Park, Nanshan, Shenzhen, Guangdong, China.
The 3m-Semi anechoic test site fulfils CISPR 16-1-4 according to ANSI C63.4:2014 and CISPR 16-1-4:2010 SVSWR requirement for radiated emission above 1GHz.

Test Facility

The test facility is recognized, certified, or accredited by the following organizations:

FCC-Designation No.: CN1315

Shenzhen Most Technology Service Co., Ltd. EMC Laboratory has been registered and fully described in a report filed with the (FCC) Federal Communications Commission. The acceptance letter from the FCC is maintained in our files.

A2LA-Lab Cert. No.: 6343.01

Shenzhen Most Technology Service Co., Ltd. EMC Laboratory has been accredited by A2LA for technical competence in the field of electrical testing, and proved to be in compliance with ISO/IEC 17025: 2005 General Requirements for the Competence of Testing and Calibration Laboratories and any additional program requirements in the identified field of testing.

4.2 Environmental conditions

During the measurement the environmental conditions were within the listed ranges:

Radiated Emission:

Temperature:	23 ° C
Humidity:	48 %
Atmospheric pressure:	950-1050mbar

AC Main Conducted testing:

Temperature:	24 ° C
Humidity:	45 %
Atmospheric pressure:	950-1050mbar

Conducted testing:

Temperature:	24 ° C
Humidity:	45 %
Atmospheric pressure:	950-1050mbar

4.3 Summary of measurement results

Test Specification clause	Test case	Test Mode	Test Channel	Recorded In Report		Test result
§15.247(a)(1)	Carrier Frequency separation	GFSK Π/4DQPSK 8DPSK	<input checked="" type="checkbox"/> Lowest <input checked="" type="checkbox"/> Middle <input checked="" type="checkbox"/> Highest	GFSK Π/4DQPSK 8DPSK	<input checked="" type="checkbox"/> Middle	Compliant
§15.247(a)(1)	Number of Hopping channels	GFSK Π/4DQPSK 8DPSK	<input checked="" type="checkbox"/> Full	GFSK 8DPSK	<input checked="" type="checkbox"/> Full	Compliant
§15.247(a)(1)	Time of Occupancy (dwell time)	GFSK Π/4DQPSK 8DPSK	<input checked="" type="checkbox"/> Lowest <input checked="" type="checkbox"/> Middle <input checked="" type="checkbox"/> Highest	GFSK Π/4DQPSK 8DPSK	<input checked="" type="checkbox"/> Middle	Compliant
§15.247(a)(1)	Spectrum bandwidth of aFHSS system 20dB bandwidth	GFSK Π/4DQPSK 8DPSK	<input checked="" type="checkbox"/> Lowest <input checked="" type="checkbox"/> Middle <input checked="" type="checkbox"/> Highest	GFSK Π/4DQPSK 8DPSK	<input checked="" type="checkbox"/> Lowest <input checked="" type="checkbox"/> Middle <input checked="" type="checkbox"/> Highest	Compliant
§15.247(b)(1)	Maximum output power	GFSK Π/4DQPSK 8DPSK	<input checked="" type="checkbox"/> Lowest <input checked="" type="checkbox"/> Middle <input checked="" type="checkbox"/> Highest	GFSK Π/4DQPSK 8DPSK	<input checked="" type="checkbox"/> Lowest <input checked="" type="checkbox"/> Middle <input checked="" type="checkbox"/> Highest	Compliant
§15.247(d)	Band edge compliance conducted	GFSK Π/4DQPSK 8DPSK	<input checked="" type="checkbox"/> Lowest <input checked="" type="checkbox"/> Highest	GFSK Π/4DQPSK 8DPSK	<input checked="" type="checkbox"/> Lowest <input checked="" type="checkbox"/> Highest	Compliant
§15.205	Band edge compliance radiated	GFSK Π/4DQPSK 8DPSK	<input checked="" type="checkbox"/> Lowest <input checked="" type="checkbox"/> Highest	GFSK	<input checked="" type="checkbox"/> Lowest <input checked="" type="checkbox"/> Highest	Compliant
§15.247(d)	TX spurious emissions conducted	GFSK Π/4DQPSK 8DPSK	<input checked="" type="checkbox"/> Lowest <input checked="" type="checkbox"/> Middle <input checked="" type="checkbox"/> Highest	GFSK Π/4DQPSK 8DPSK	<input checked="" type="checkbox"/> Lowest <input checked="" type="checkbox"/> Middle <input checked="" type="checkbox"/> Highest	Compliant
§15.247(d)	TX spurious emissions radiated	GFSK Π/4DQPSK 8DPSK	<input checked="" type="checkbox"/> Lowest <input checked="" type="checkbox"/> Middle <input checked="" type="checkbox"/> Highest	GFSK	<input checked="" type="checkbox"/> Lowest <input checked="" type="checkbox"/> Middle <input checked="" type="checkbox"/> Highest	Compliant
§15.209(a)	TX spurious Emissions radiated Below 1GHz	GFSK Π/4DQPSK 8DPSK	<input checked="" type="checkbox"/> Lowest <input checked="" type="checkbox"/> Middle <input checked="" type="checkbox"/> Highest	GFSK	<input checked="" type="checkbox"/> Middle	Compliant
§15.107(a) §15.207	Conducted Emissions 9KHz-30 MHz	GFSK Π/4DQPSK 8DPSK	<input checked="" type="checkbox"/> Lowest <input checked="" type="checkbox"/> Middle <input checked="" type="checkbox"/> Highest	GFSK	<input checked="" type="checkbox"/> Middle	Compliant

Remark:

1. The measurement uncertainty is not included in the test result.
2. We tested all test mode and recorded worst case in report

4.4 Statement of the measurement uncertainty

The data and results referenced in this document are true and accurate. The reader is cautioned that there may be errors within the calibration limits of the equipment and facilities. The measurement uncertainty was calculated for all measurements listed in this test report acc. to CISPR 16 - 4 „Specification for radio disturbance and immunity measuring apparatus and methods – Part 4: Uncertainty in EMC Measurements“ and is documented in the Shenzhen Most Technology Service Co., Ltd. quality system acc. to DIN EN ISO/IEC 17025. Furthermore, component and process variability of devices similar to that tested may result in additional deviation. The manufacturer has the sole responsibility of continued compliance of the device.

Hereafter the best measurement capability for Shenzhen Most Technology Service Co., Ltd. is reported:

Test	Range	Measurement Uncertainty	Notes
Radiated Emission	30~1000MHz	4.10 dB	(1)
Radiated Emission	1~18GHz	4.32 dB	(1)
Radiated Emission	18-40GHz	5.54 dB	(1)
Conducted Disturbance	0.15~30MHz	3.12 dB	(1)

- (1) This uncertainty represents an expanded uncertainty expressed at approximately the 95% confidence level using a coverage factor of k=2.

4.5 Equipments Used during the Test

Item	Equipment	Manufacturer	Model No.	Serial No.	Firmware versions	Last Cal.	Cal. Interval
1.	L.I.S.N.	R&S	ENV216	100093	/	2022/04/18	1 Year
2	Three-phase artificial power network	Schwarzback Mess	NNLK8129	8129178	/	2022/04/18	1 Year
3.	Receiver	R&S	ESCI	100492	V3.0-10-2	2022/04/06	1 Year
4	Receiver	R&S	ESPI	101202	V3.0-10-2	2022/04/06	1 Year
5	Spectrum analyzer	Agilent	9020A	MT-E306	A14.16	2022/04/06	1 Year
6	Bilong Antenna	Sunol Sciences	JB3	A121206	/	2022/03/13	1 Year
7	Horn antenna	HF Antenna	HF Antenna	MT-E158	/	2022/04/06	1 Year
8	Loop antenna	Beijing Daze	ZN30900B	/	/	2022/04/17	1 Year
9	Horn antenna	R&S	OBH100400	26999002	/	2022/04/17	1 Year
10	Wireless Communication Test Set	R&S	CMW500	/	CMW-BASE-3.7.21	2022/04/17	1 Year
11	Spectrum analyzer	R&S	FSP	100019	V4.40 SP2	2022/04/16	1 Year
12	High gain antenna	Schwarzbeck	LB-180400KF	MT-E389	/	2022/03/13	1 Year
13	Preamplifier	Schwarzbeck	BBV 9743	MT-E390	/	2022/03/13	1 Year
14	Pre-amplifier	EMCI	EMC051845S E	MT-E391	/	2022/03/13	1 Year
15	Pre-amplifier	Agilent	83051A	MT-E392	/	2022/03/13	1 Year
16	High pass filter unit	Tonscend	JS0806-F	MT-E393	/	2022/03/13	1 Year
17	RF Cable(below1GHz)	Times	9kHz-1GHz	MT-E394	/	2022/03/13	1 Year
18	RF Cable(above 1GHz)	Times	1-40G	MT-E395	/	2022/03/13	1 Year
19	RF Cable (9KHz-40GHz)	Tonscend	170660	N/A	/	2022/03/13	1 Year

Note: The Cal.Interval was one year.

5 TEST CONDITIONS AND RESULTS

5.1 AC Power Conducted Emission

TEST CONFIGURATION

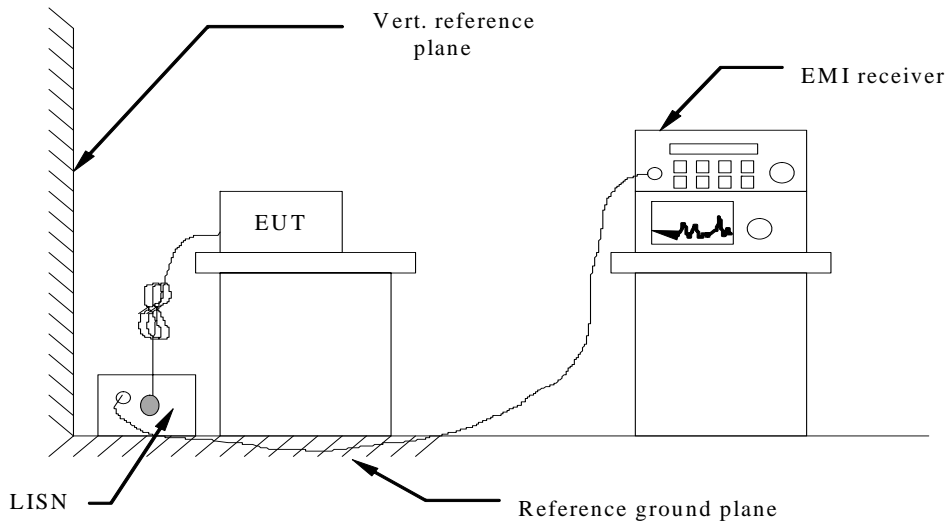

TEST PROCEDURE

- 1 The equipment was set up as per the test configuration to simulate typical actual usage per the user's manual. The EUT is a tabletop system, a wooden table with a height of 0.8 meters is used and is placed on the ground plane as per ANSI C63.10-2013.
- 2 Support equipment, if needed, was placed as per ANSI C63.10-2013
- 3 All I/O cables were positioned to simulate typical actual usage as per ANSI C63.10-2013
- 4 The EUT received DC 12V power from adapter, the adapter received AC120V/60Hz and AC 240V/60Hz power through a Line Impedance Stabilization Network (LISN) which supplied power source and was grounded to the ground plane.
- 5 All support equipments received AC power from a second LISN, if any.
- 6 The EUT test program was started. Emissions were measured on each current carrying line of the EUT using a spectrum Analyzer / Receiver connected to the LISN powering the EUT. The LISN has two monitoring points: Line 1 (Hot Side) and Line 2 (Neutral Side). Two scans were taken: one with Line 1 connected to Analyzer / Receiver and Line 2 connected to a 50 ohm load; the second scan had Line 1 connected to a 50 ohm load and Line 2 connected to the Analyzer / Receiver.
- 7 Analyzer / Receiver scanned from 150 KHz to 30MHz for emissions in each of the test modes.
- 8 During the above scans, the emissions were maximized by cable manipulation.

AC Power Conducted Emission Limit

For intentional device, according to § 15.207(a) AC Power Conducted Emission Limits is as following :

Frequency range (MHz)	Limit (dBuV)	
	Quasi-peak	Average
0.15-0.5	66 to 56*	56 to 46*
0.5-5	56	46
5-30	60	50

* Decreases with the logarithm of the frequency.

TEST RESULTS

Remark:

1. GFSK, $\pi/4$ DQPSK, 8DPSK modes were test at Low, Middle, and High channel; only the worst result of GFSK Middle Channel was reported as below:

Power supply: AC 120V/60Hz Polarization: L

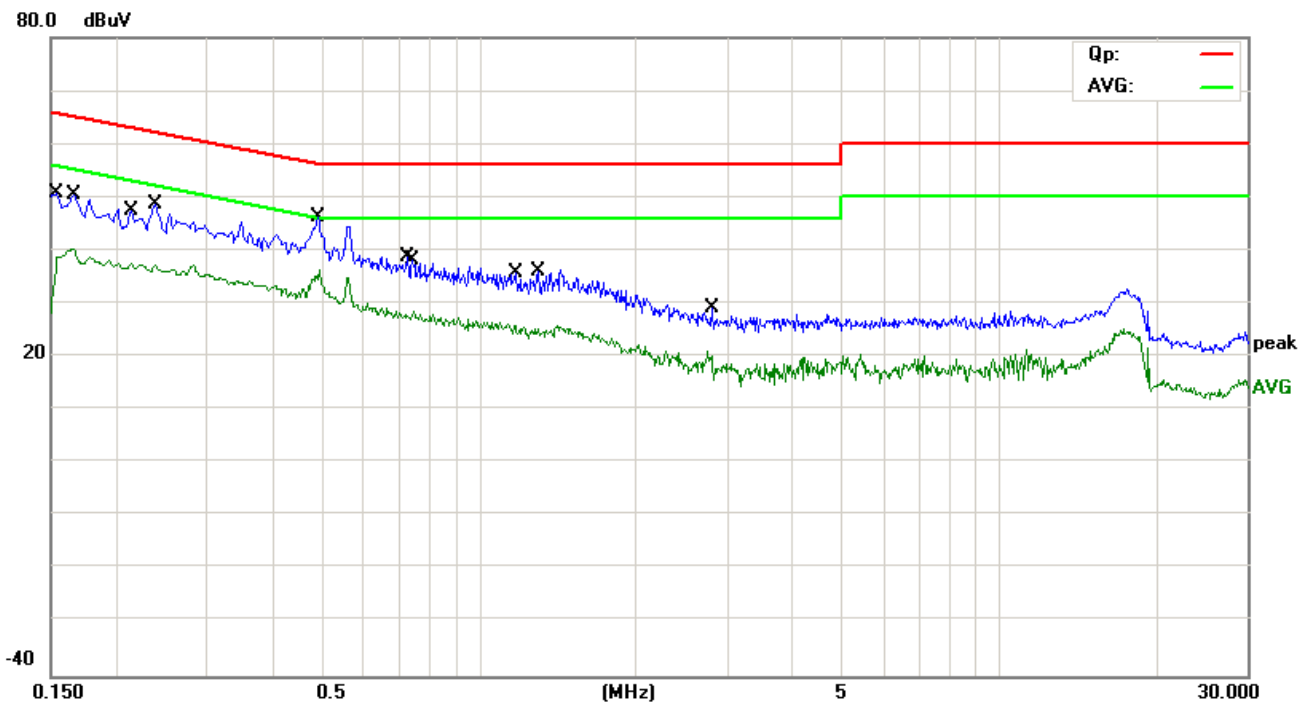

No.	Mk.	Freq. MHz	Reading Level dBuV	Correct Factor dB	Measure- ment dBuV	Limit dBuV	Over dB	Detector	Comment
1		0.1540	41.04	9.60	50.64	65.78	-15.14	QP	
2		0.1660	30.74	9.61	40.35	55.16	-14.81	AVG	
3		0.2140	27.82	9.60	37.42	53.05	-15.63	AVG	
4		0.2380	39.05	9.60	48.65	62.17	-13.52	QP	
5		0.4900	36.51	9.59	46.10	56.17	-10.07	QP	
6	*	0.4940	26.70	9.59	36.29	46.10	-9.81	AVG	
7		0.7300	29.19	9.60	38.79	56.00	-17.21	QP	
8		0.7500	19.03	9.60	28.63	46.00	-17.37	AVG	
9		1.1700	16.29	9.60	25.89	46.00	-20.11	AVG	
10		1.3020	26.31	9.60	35.91	56.00	-20.09	QP	
11		2.7540	11.33	9.61	20.94	46.00	-25.06	AVG	
12		2.8060	19.65	9.61	29.26	56.00	-26.74	QP	

*:Maximum data x:Over limit !:over margin

Power supply:	AC 120V/60Hz	Polarization	N
---------------	--------------	--------------	---

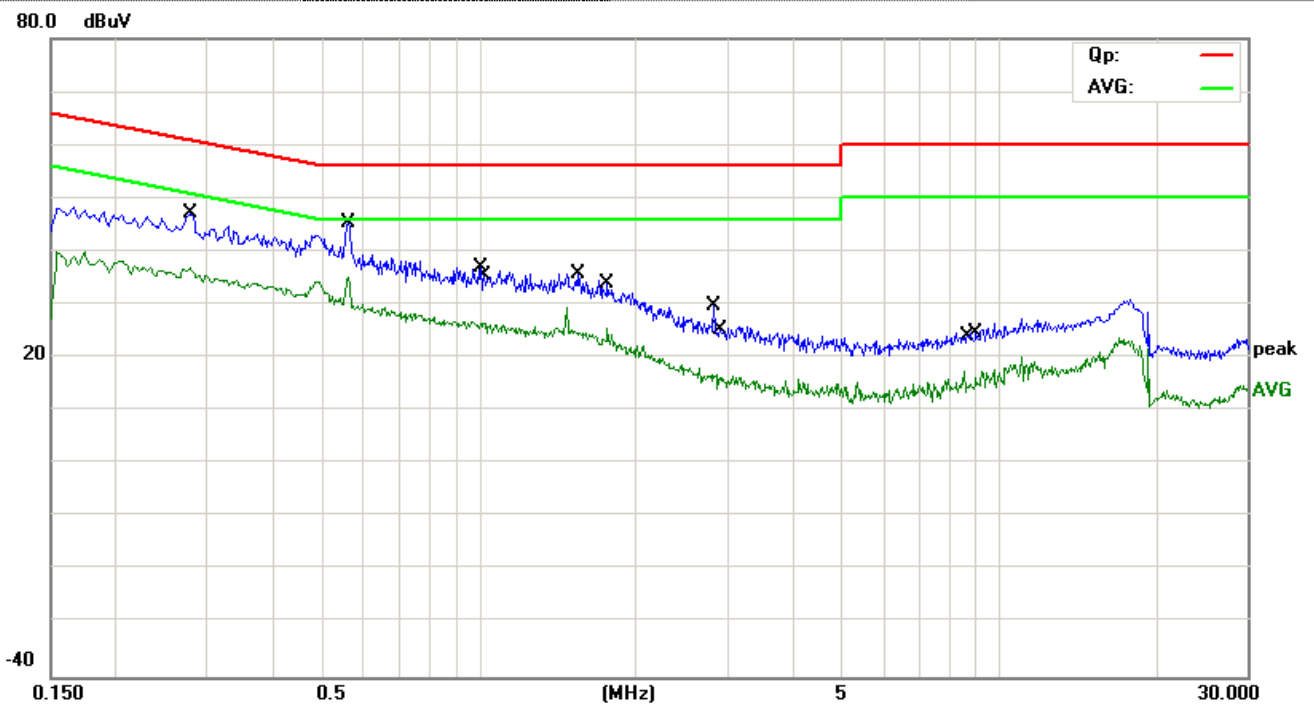

No.	Mk.	Freq. MHz	Reading Level dBuV	Correct Factor dB	Measure- ment dBuV	Limit dBuV	Over dB	Detector	Comment
1		0.2780	37.50	9.59	47.09	60.88	-13.79	QP	
2		0.2780	27.45	9.59	37.04	50.88	-13.84	AVG	
3	*	0.5620	35.86	9.59	45.45	56.00	-10.55	QP	
4		0.5620	25.50	9.59	35.09	46.00	-10.91	AVG	
5		1.0060	27.44	9.60	37.04	56.00	-18.96	QP	
6		1.0220	16.98	9.60	26.58	46.00	-19.42	AVG	
7		1.5500	26.02	9.60	35.62	56.00	-20.38	QP	
8		1.7700	15.88	9.60	25.48	46.00	-20.52	AVG	
9		2.8300	20.28	9.61	29.89	56.00	-26.11	QP	
10		2.8580	7.20	9.61	16.81	46.00	-29.19	AVG	
11		8.5740	7.68	9.67	17.35	50.00	-32.65	AVG	
12		9.0340	14.93	9.68	24.61	60.00	-35.39	QP	

*:Maximum data x:Over limit !:over margin

5.2 Radiated Emission

TEST CONFIGURATION

Frequency range 9 KHz – 30MHz

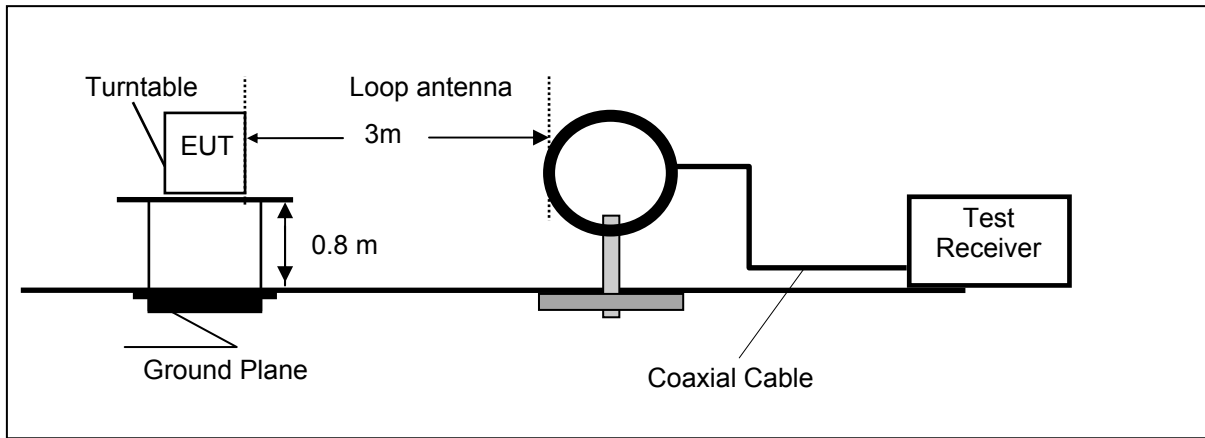

Frequency range 30MHz – 1000MHz

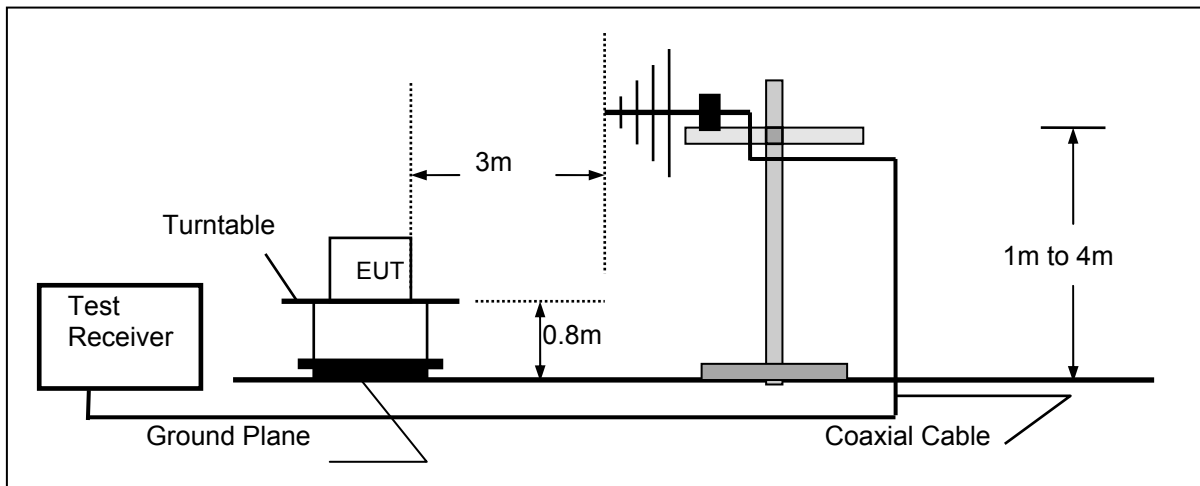

Frequency range above 1GHz-25GHz

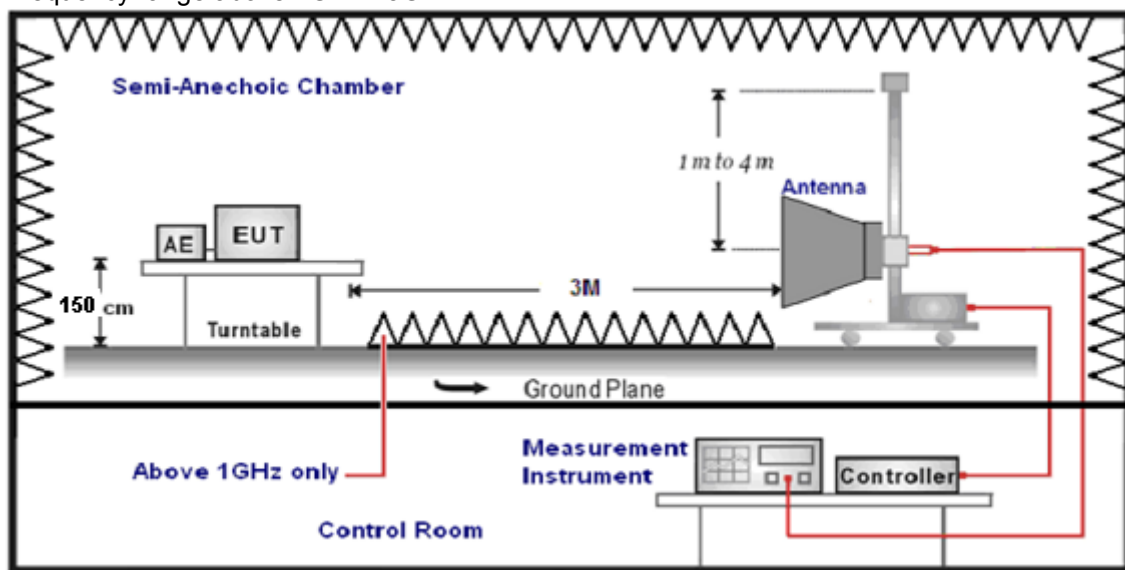

TEST PROCEDURE

1. The EUT was placed on a turn table which is 0.8m above ground plane when testing frequency range 9 KHz –1GHz;the EUT was placed on a turn table which is 1.5m above ground plane when testing frequency range 1GHz – 25GHz.
2. Maximum procedure was performed by raising the receiving antenna from 1m to 4m and rotating the turn table from 0° to 360° to acquire the highest emissions from EUT.
3. And also, each emission was to be maximized by changing the polarization of receiving antenna both horizontal and vertical.
4. Repeat above procedures until all frequency measurements have been completed.
5. Radiated emission test frequency band from 9KHz to 25GHz.
6. The distance between test antenna and EUT as following table states:

Test Frequency range	Test Antenna Type	Test Distance
9KHz-30MHz	Active Loop Antenna	3
30MHz-1GHz	Ultra-Broadband Antenna	3
1GHz-18GHz	Double Ridged Horn Antenna	3
18GHz-25GHz	Horn Antenna	1

7. Setting test receiver/spectrum as following table states:

Test Frequency range	Test Receiver/Spectrum Setting	Detector
9KHz-150KHz	RBW=200Hz/VBW=3KHz,Sweep time=Auto	QP
150KHz-30MHz	RBW=9KHz/VBW=100KHz,Sweep time=Auto	QP
30MHz-1GHz	RBW=120KHz/VBW=1000KHz,Sweep time=Auto	QP
1GHz-40GHz	Peak Value: RBW=1MHz/VBW=3MHz, Sweep time=Auto Average Value: RBW=1MHz/VBW=10Hz, Sweep time=Auto	Peak

Field Strength Calculation

The field strength is calculated by adding the Antenna Factor and Cable Factor and subtracting the Amplifier Gain and Duty Cycle Correction Factor(if any) from the measured reading. The basic equation with a sample calculation is as follows:

FS = RA + AF + CL - AG

Where FS = Field Strength	CL = Cable Attenuation Factor (Cable Loss)
RA = Reading Amplitude	AG = Amplifier Gain
AF = Antenna Factor	

Transd=AF +CL-AG

RADIATION LIMIT

For intentional device, according to § 15.209(a), the general requirement of field strength of radiated emission from intentional radiators at a distance of 3 meters shall not exceed the following table. According to § 15.247(d), in any 100kHz bandwidth outside the frequency band in which the EUT is operating, the radio frequency power that is produced by the intentional radiator shall be at least 20dB below that in the100kHz bandwidth within the band that contains the highest level of desired power.

The pre-test have done for the EUT in three axes and found the worst emission at position shown in test setup photos.

Frequency (MHz)	Distance (Meters)	Radiated (dBµV/m)	Radiated (µV/m)
0.009-0.49	3	20log(2400/F(KHz))+40log(300/3)	2400/F(KHz)
0.49-1.705	3	20log(24000/F(KHz))+ 40log(30/3)	24000/F(KHz)
1.705-30	3	20log(30)+ 40log(30/3)	30
30-88	3	40.0	100
88-216	3	43.5	150
216-960	3	46.0	200
Above 960	3	54.0	500

TEST RESULTS

Remark:

1. This test was performed with EUT in X, Y, Z position and the worse case was found when EUT in X position.
2. We measured Radiated Emission at GFSK, $\pi/4$ DQPSK and 8DPSK mode from 9 KHz to 25GHz and recorded worst case at GFSK DH5 mode.
3. For below 1GHz testing recorded worst at GFSK DH5 middle channel.
4. Radiated emission test from 9 KHz to 10th harmonic of fundamental was verified, and no emission found except system noise floor in 9 KHz to 30MHz and not recorded in this report.
5. Remark: Result=Reading value+Factor
6. We measured the radiated emission in all power supply modes, and recorded the worst case in DC5V(by USB) mode.

For 30MHz-1GHz

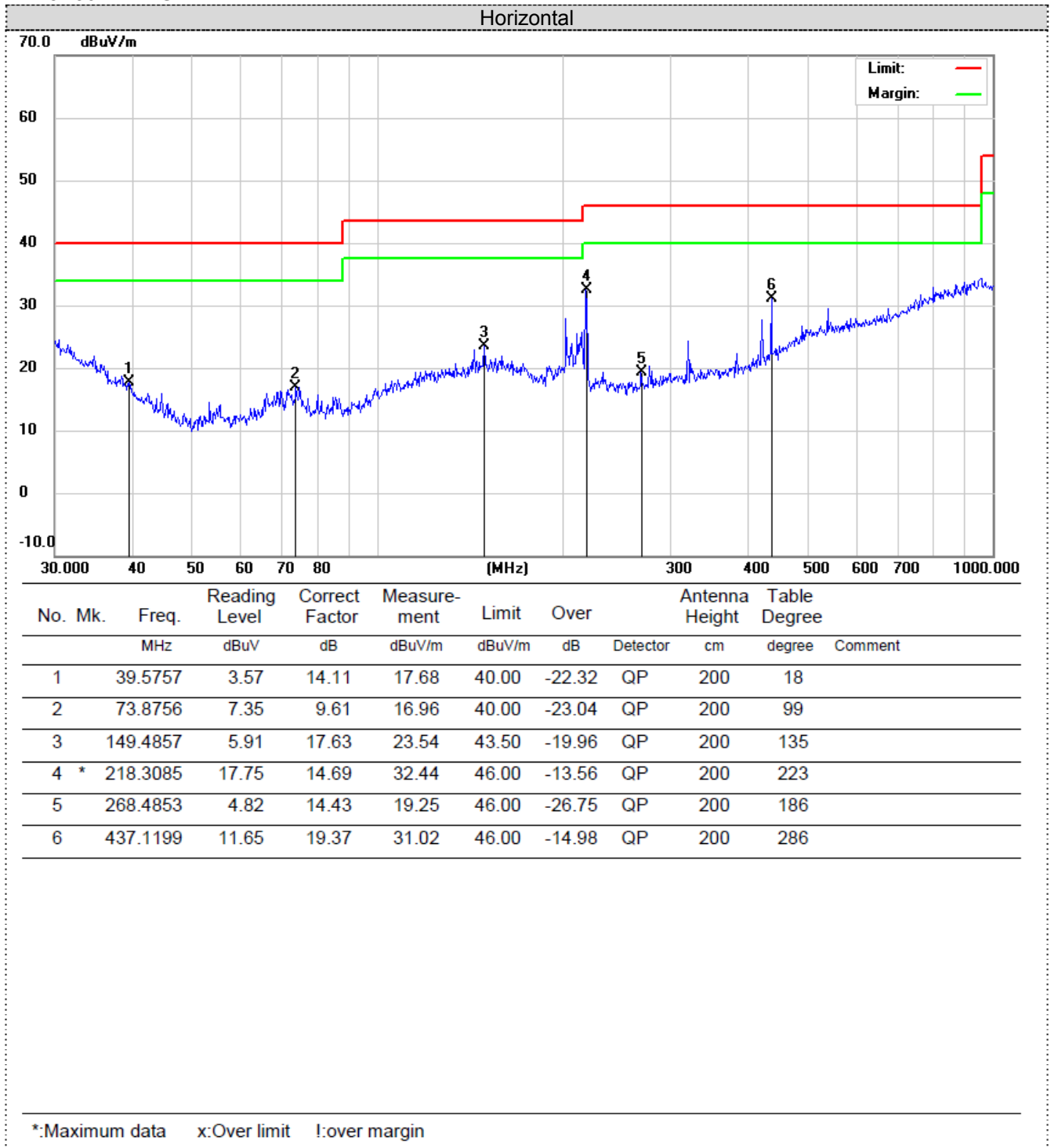

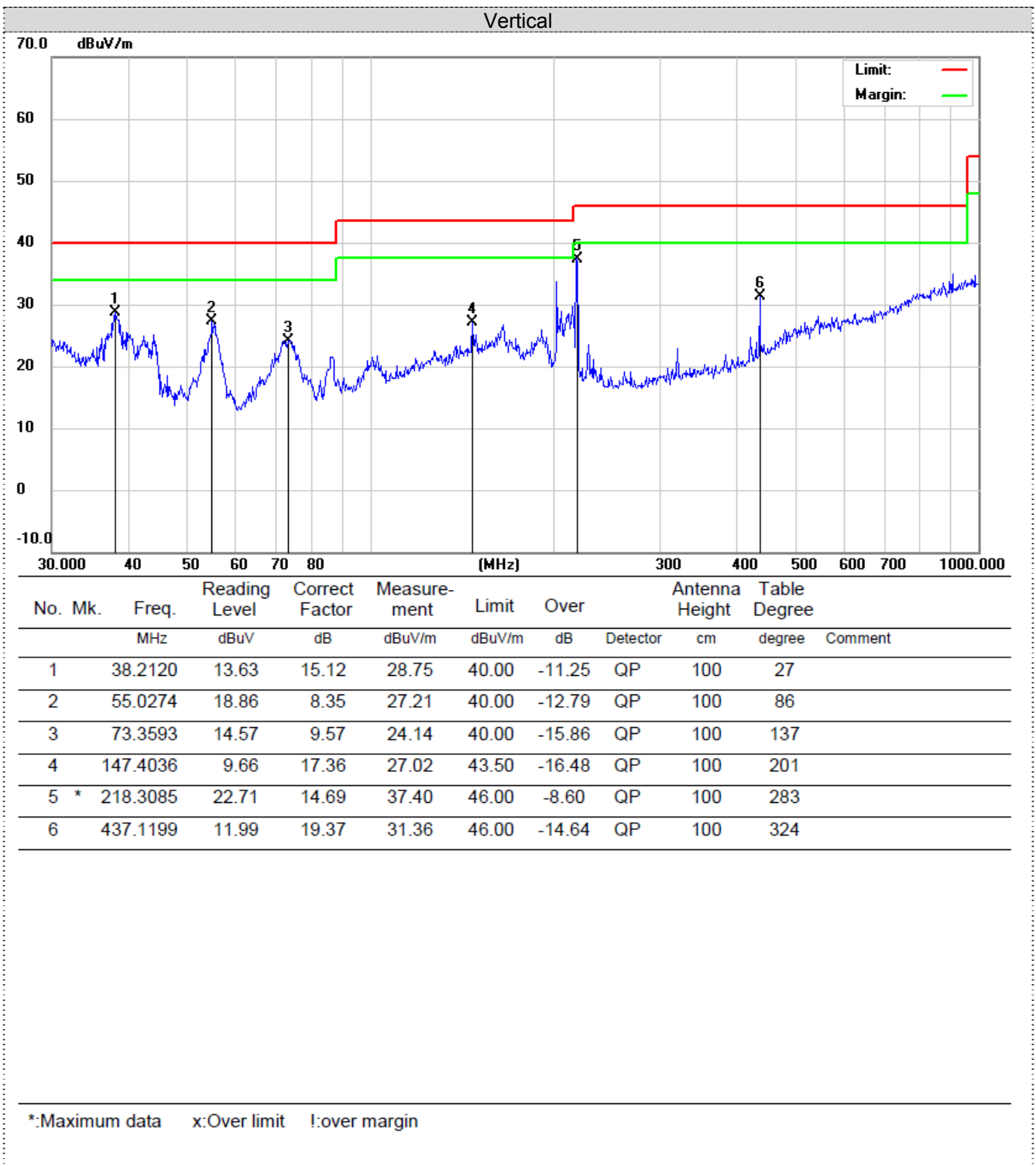

For 1GHz to 25GHz

Note: GFSK, Pi/4 DQPSK and 8DPSK all have been tested, only worse case GFSK is reported.

GFSK (above 1GHz)

Frequency(MHz):			2402		Polarity:		HORIZONTAL		
Frequency (MHz)	Emission Level (dBuV/m)		Limit (dBuV/m)	Margin (dB)	Raw Value (dBuV)	Antenna Factor (dB/m)	Cable Factor (dB)	Pre-amplifier (dB)	Correction Factor (dB/m)
4804	56.29	PK	74	17.71	54.39	31.42	6.98	36.5	1.9
4804	43.14	AV	54	10.86	41.24	31.42	6.98	36.5	1.9
7206	55.05	PK	74	18.95	44.45	37.03	8.87	35.3	10.6
7206	41.94	AV	54	12.06	31.34	37.03	8.87	35.3	10.6

Frequency(MHz):			2402		Polarity:		VERTICAL		
Frequency (MHz)	Emission Level (dBuV/m)		Limit (dBuV/m)	Margin (dB)	Raw Value (dBuV)	Antenna Factor (dB/m)	Cable Factor (dB)	Pre-amplifier (dB)	Correction Factor (dB/m)
4804	57.01	PK	74	16.99	55.11	31.42	6.98	36.5	1.9
4804	46.54	AV	54	7.46	44.64	31.42	6.98	36.5	1.9
7206	54.62	PK	74	19.38	44.02	37.03	8.87	35.3	10.6
7206	42.6	AV	54	11.4	32	37.03	8.87	35.3	10.6

Frequency(MHz):			2441		Polarity:		HORIZONTAL		
Frequency (MHz)	Emission Level (dBuV/m)		Limit (dBuV/m)	Margin (dB)	Raw Value (dBuV)	Antenna Factor (dB/m)	Cable Factor (dB)	Pre-amplifier (dB)	Correction Factor (dB/m)
4882	52.41	PK	74	21.59	50.35	30.98	7.58	36.5	2.06
4882	45.53	AV	54	8.47	43.47	30.98	7.58	36.5	2.06
7323	51.1	PK	74	22.9	40.18	37.66	8.56	35.3	10.92
7323	43.66	AV	54	10.34	32.74	37.66	8.56	35.3	10.92

Frequency(MHz):			2441		Polarity:		VERTICAL		
Frequency (MHz)	Emission Level (dBuV/m)		Limit (dBuV/m)	Margin (dB)	Raw Value (dBuV)	Antenna Factor (dB/m)	Cable Factor (dB)	Pre-amplifier (dB)	Correction Factor (dB/m)
4882	55.55	PK	74	18.45	53.49	30.98	7.58	36.5	2.06
4882	42.72	AV	54	11.28	40.66	30.98	7.58	36.5	2.06
7323	53.93	PK	74	20.07	43.01	37.66	8.56	35.3	10.92
7323	43.85	AV	54	10.15	32.93	37.66	8.56	35.3	10.92

Frequency(MHz):			2480		Polarity:		HORIZONTAL		
Frequency (MHz)	Emission Level (dBuV/m)		Limit (dBuV/m)	Margin (dB)	Raw Value (dBuV)	Antenna Factor (dB/m)	Cable Factor (dB)	Pre-amplifier (dB)	Correction Factor (dB/m)
4960	56.31	PK	74	17.69	53.24	31.47	7.8	36.2	3.07
4960	47.47	AV	54	6.53	44.4	31.47	7.8	36.2	3.07
7440	53.86	PK	74	20.14	42.12	38.32	8.72	35.3	11.74
7440	41.85	PK	54	12.15	30.11	38.32	8.72	35.3	11.74

Frequency(MHz):			2480		Polarity:		VERTICAL		
Frequency (MHz)	Emission Level (dBuV/m)		Limit (dBuV/m)	Margin (dB)	Raw Value (dBuV)	Antenna Factor (dB/m)	Cable Factor (dB)	Pre-amplifier (dB)	Correction Factor (dB/m)
4960	58.33	PK	74	15.67	55.26	31.47	7.8	36.2	3.07
4960	45.72	AV	54	8.28	42.65	31.47	7.8	36.2	3.07
7440	56.34	PK	74	17.66	44.6	38.32	8.72	35.3	11.74
7440	43.83	PK	54	10.17	32.09	38.32	8.72	35.3	11.74

REMARKS:

1. Emission level (dBuV/m) =Raw Value (dBuV)+Correction Factor (dB/m)
2. Correction Factor (dB/m) = Antenna Factor (dB/m)+Cable Factor (dB)- Pre-amplifier

3. Margin value = Limit value- Emission level.
4. -- Mean the PK detector measured value is below average limit.
5. The other emission levels were very low against the limit.

Results of Band Edges Test (Radiated)

Note: GFSK, Pi/4 DQPSK and 8DPSK all have been tested, only worse case GFSK is reported.

GFSK

Frequency(MHz):			2402		Polarity:		HORIZONTAL		
Frequency (MHz)	Emission Level (dBuV/m)		Limit (dBuV/m)	Margin (dB)	Raw Value (dBuV)	Antenna Factor (dB/m)	Cable Factor (dB)	Pre-amplifier (dB)	Correction Factor (dB/m)
2390	58.5	PK	74	15.5	63.91	27.49	3.32	36.22	-5.41
2390	40.27	AV	54	13.73	45.68	27.49	3.32	36.22	-5.41
Frequency(MHz):			2402		Polarity:		VERTICAL		
Frequency (MHz)	Emission Level (dBuV/m)		Limit (dBuV/m)	Margin (dB)	Raw Value (dBuV)	Antenna Factor (dB/m)	Cable Factor (dB)	Pre-amplifier (dB)	Correction Factor (dB/m)
2390	59.49	PK	74	14.51	64.9	27.49	3.32	36.22	-5.41
2390	41.89	AV	54	12.11	47.3	27.49	3.32	36.22	-5.41
Frequency(MHz):			2480		Polarity:		HORIZONTAL		
Frequency (MHz)	Emission Level (dBuV/m)		Limit (dBuV/m)	Margin (dB)	Raw Value (dBuV)	Antenna Factor (dB/m)	Cable Factor (dB)	Pre-amplifier (dB)	Correction Factor (dB/m)
2483.5	56.38	PK	74	17.62	61.89	27.45	3.38	36.34	-5.51
2483.5	41.75	AV	54	12.25	47.26	27.45	3.38	36.34	-5.51
Frequency(MHz):			2480		Polarity:		VERTICAL		
Frequency (MHz)	Emission Level (dBuV/m)		Limit (dBuV/m)	Margin (dB)	Raw Value (dBuV)	Antenna Factor (dB/m)	Cable Factor (dB)	Pre-amplifier (dB)	Correction Factor (dB/m)
2483.5	58.29	PK	74	15.71	63.8	27.45	3.38	36.34	-5.51
2483.5	42.19	AV	54	11.81	47.7	27.45	3.38	36.34	-5.51

REMARKS:

1. Emission level (dBuV/m) =Raw Value (dBuV)+Correction Factor (dB/m)
2. Correction Factor (dB/m) = Antenna Factor (dB/m)+Cable Factor (dB)- Pre-amplifier
3. Margin value = Limit value- Emission level.
4. -- Mean the PK detector measured value is below average limit.

5.3 Maximum Peak Output Power

Limit

The Maximum Peak Output Power Measurement is 125mW (20.97).

Test Procedure

Remove the antenna from the EUT and then connect a low loss RF cable from the antenna port to the powersensor.

Test Configuration

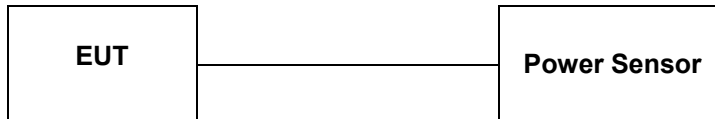

Test Results

Type	Channel	Output power (dBm)	Limit (dBm)	Result
GFSK	CH0	1.223	20.97	Pass
	CH39	0.858		
	CH78	0.598		
π/4DQPSK	CH0	1.025	20.97	Pass
	CH39	0.895		
	CH78	1.000		
8DPSK	CH0	1.023	20.97	Pass
	CH39	0.747		
	CH78	1.569		

Note: 1.The test results including the cable lose.

5.4 20dB Bandwidth

Limit

For frequency hopping systems operating in the 2400MHz-2483.5MHz no limit for 20dB bandwidth.

Test Procedure

The transmitter output was connected to the spectrum analyzer through an attenuator. The bandwidth of the fundamental frequency was measured by spectrum analyzer with 30 KHz RBW and 100 KHz VBW.

The 20dB bandwidth is defined as the total spectrum the power of which is higher than peak power minus 20dB.

Test Configuration

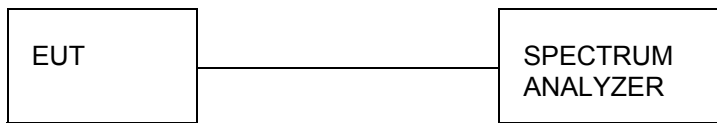

Test Results

Modulation	Channel	20dB bandwidth (MHz)	Result
GFSK	CH0	1.024	Pass
	CH39	1.038	
	CH78	1.032	
π/4DQPSK	CH0	1.319	
	CH39	1.327	
	CH78	1.331	
8DPSK	CH0	1.300	
	CH39	1.298	
	CH78	1.293	

Test plot as follows:

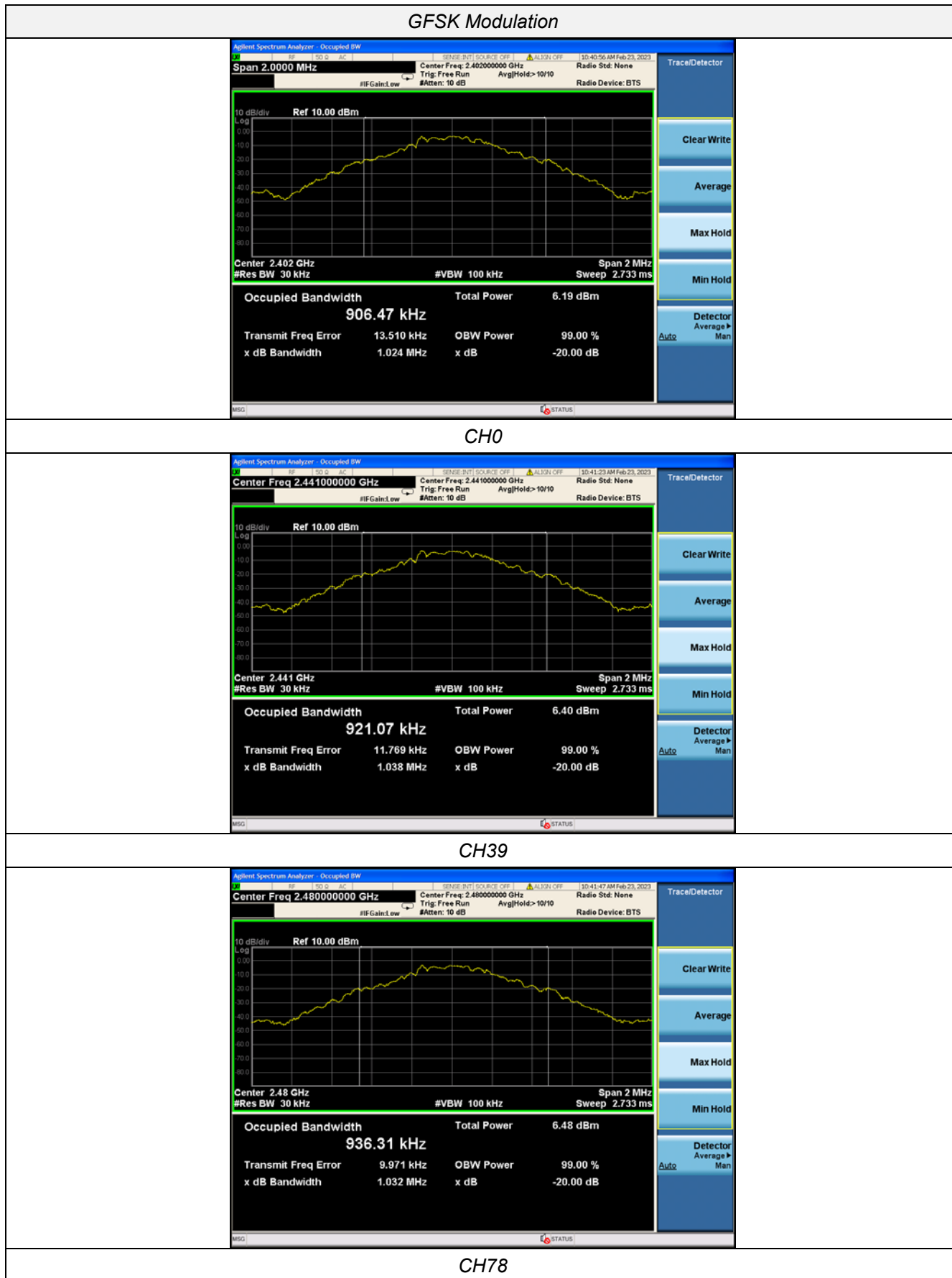

$\pi/4$ DQPSK Modulation

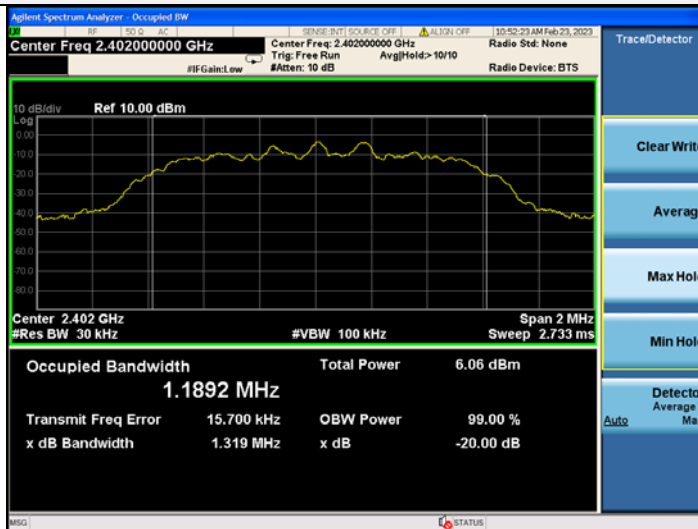

CH0

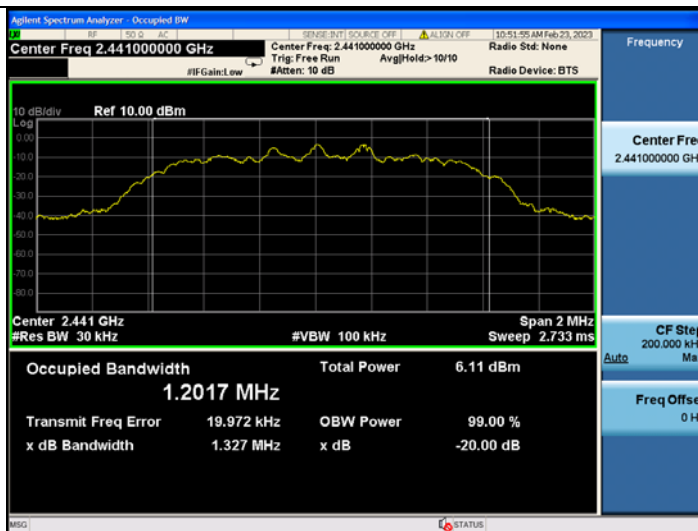

CH39

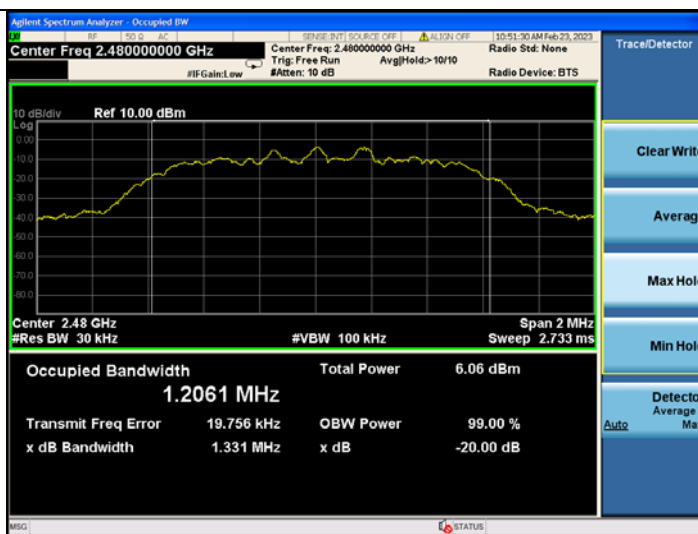

CH78

8DPSK Modulation

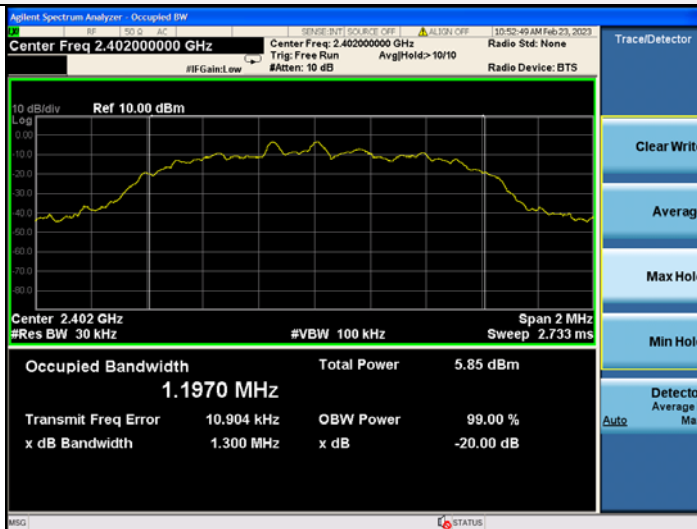

CH0

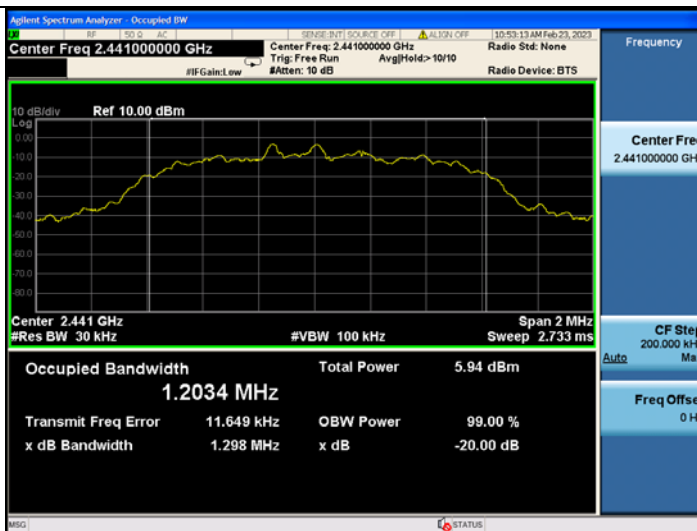

CH39



CH78

5.5 Frequency Separation

LIMIT

According to 15.247(a)(1), frequency hopping systems shall have hopping channel carrier frequencies separated by minimum of 25KHz or the $2/3 \times 20\text{dB}$ bandwidth of the hopping channel, whichever is greater.

TEST PROCEDURE

The transmitter output was connected to the spectrum analyzer through an attenuator. The bandwidth of the fundamental frequency was measured by spectrum analyzer with 100 KHz RBW and 300 KHz VBW.

TEST CONFIGURATION

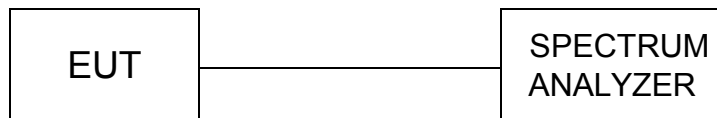

TEST RESULTS

Modulation	Channel	Channel Separation (MHz)	Limit(MHz) ($2/3 \times 20\text{dB}$ bandwidth)	Limit	Result
GFSK	CH0	0.990	0.682	25KHz	Pass
	CH39	0.996	0.692		
	CH78	0.996	0.688		
$\pi/4$ DQPSK	CH0	1.338	0.879	25KHz	Pass
	CH39	1.332	0.884		
	CH78	1.332	0.887		
8DPSK	CH0	1.332	0.866	25KHz	Pass
	CH39	1.338	0.865		
	CH78	1.341	0.862		

Note:

We have tested all mode at high, middle and low g..channel, and recorded worst case at middle

Test plot as follows:

GFSK Modulation

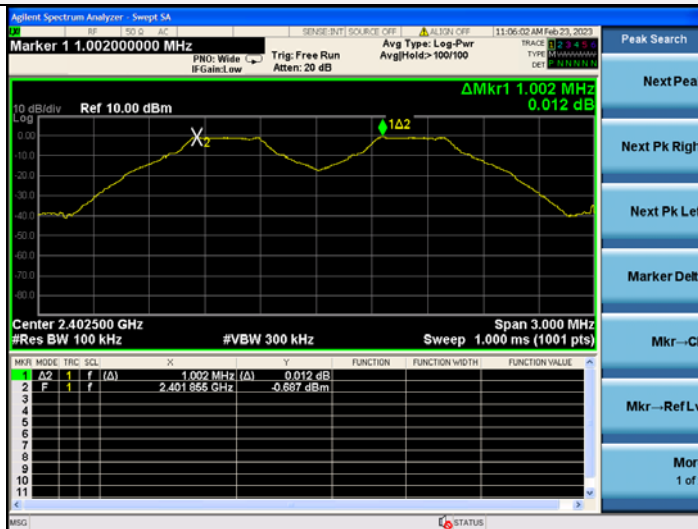

CH0

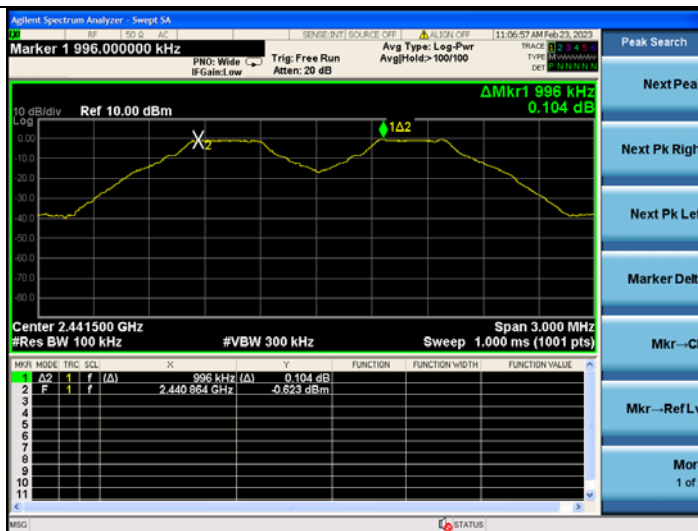

CH39

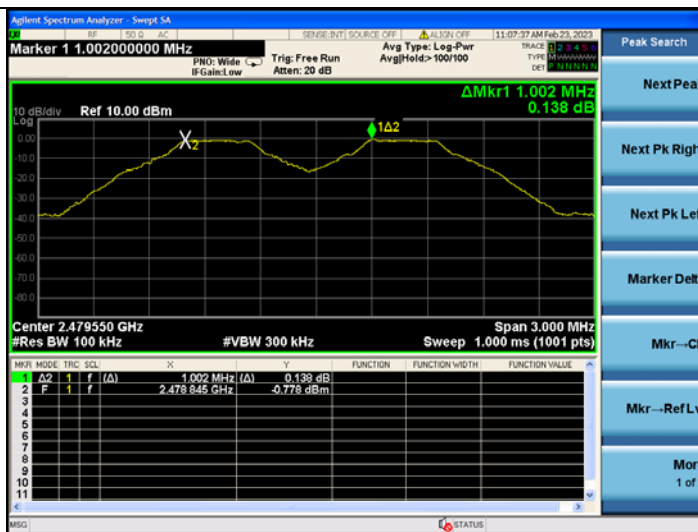

CH78

$\pi/4$ DQPSK Modulation



CH0

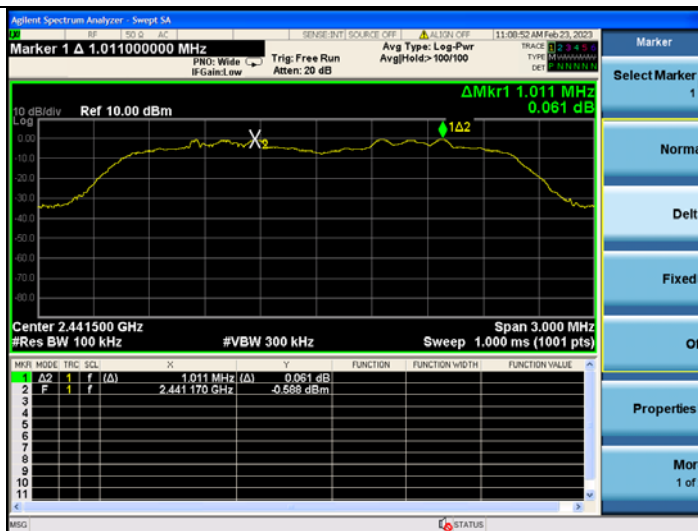

CH39

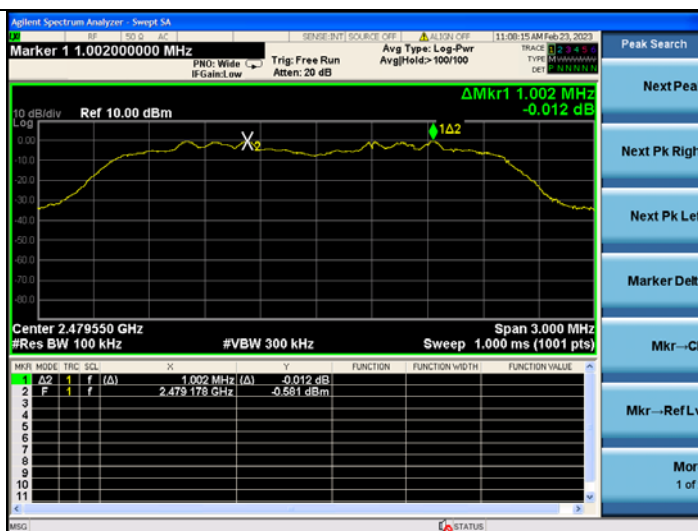

CH78

8DPSK Modulation



CH0

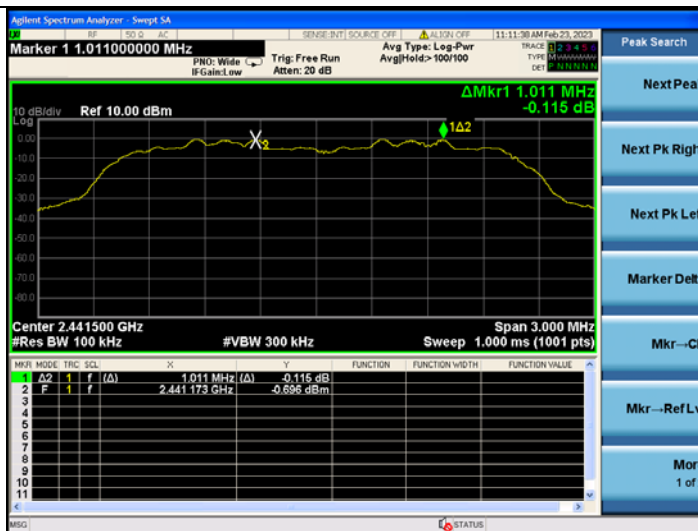

CH39



CH78

5.6 Number of hopping frequency

Limit

Frequency hopping systems in the 2400–2483.5 MHz band shall use at least 15 channels.

Test Procedure

The transmitter output was connected to the spectrum analyzer through an attenuator. Set spectrum analyzer start 2400MHz to 2483.5MHz with 100 KHz RBW and 300 KHz VBW.

Test Configuration

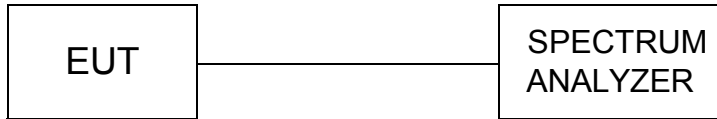

Test Results

Modulation	Number of Hopping Channel	Limit	Result
GFSK	79	≥15	Pass
$\pi/4$ DQPSK	79		
8DPSK	79		

Test plot as follows:



GFSK Modulation

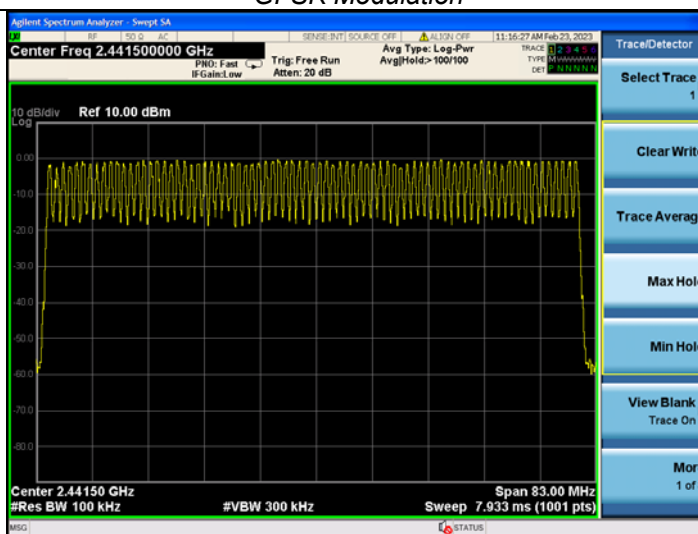

$\pi/4$ DQPSK Modulation

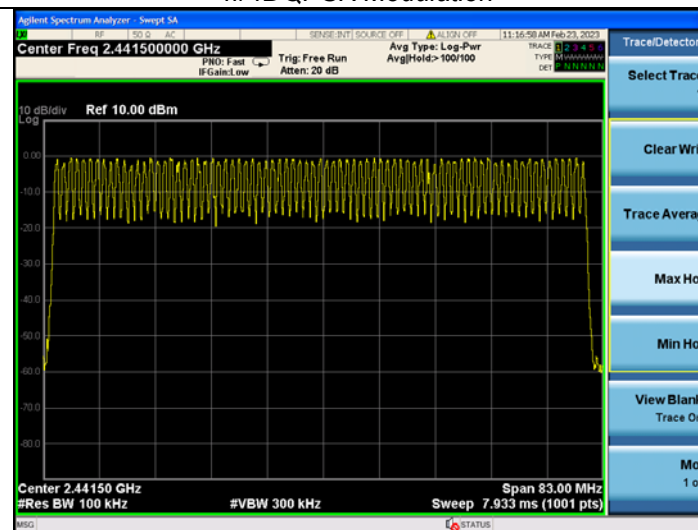

8DPSK Modulation

5.7 Time of Occupancy (Dwell Time)

Limit

The average time of occupancy on any channel shall not be greater than 0.4 seconds within a period of 0.4 seconds multiplied by the number of hopping channels employed.

Test Procedure

The transmitter output was connected to the spectrum analyzer through an attenuator. Set center frequency of spectrum analyzer=operating frequency with 1MHz RBW and 1MHz VBW, Span 0Hz.

Test Configuration

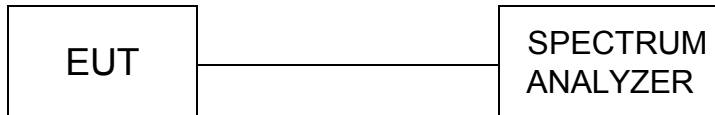

Test Results

Modulation	Packet	Burst time (ms)	Dwell time (s)	Limit (s)	Result
GFSK	DH1	0.380	0.1216	0.40	Pass
	DH3	1.640	0.2624		
	DH5	2.880	0.3081		
π/4DQPSK	2-DH1	0.390	0.1248	0.40	Pass
	2-DH3	1.635	0.2616		
	2-DH5	2.890	0.3092		
8DPSK	3-DH1	0.400	0.1280	0.40	Pass
	3-DH3	1.640	0.2624		
	3-DH5	2.875	0.3076		

Note: We have tested all mode at high, middle and low channel, and recorded worst case at middle channel.

Dwell time = Pulse time (ms) × (1600 ÷ 2 ÷ 79) × 31.6 Second for DH1, 2-DH1, 3-DH1

Dwell time = Pulse time (ms) × (1600 ÷ 4 ÷ 79) × 31.6 Second for DH3, 2-DH3, 3-DH3

Dwell time = Pulse time (ms) × (1600 ÷ 6 ÷ 79) × 31.6 Second for DH5, 2-DH5, 3-DH5

Test plot as follows:

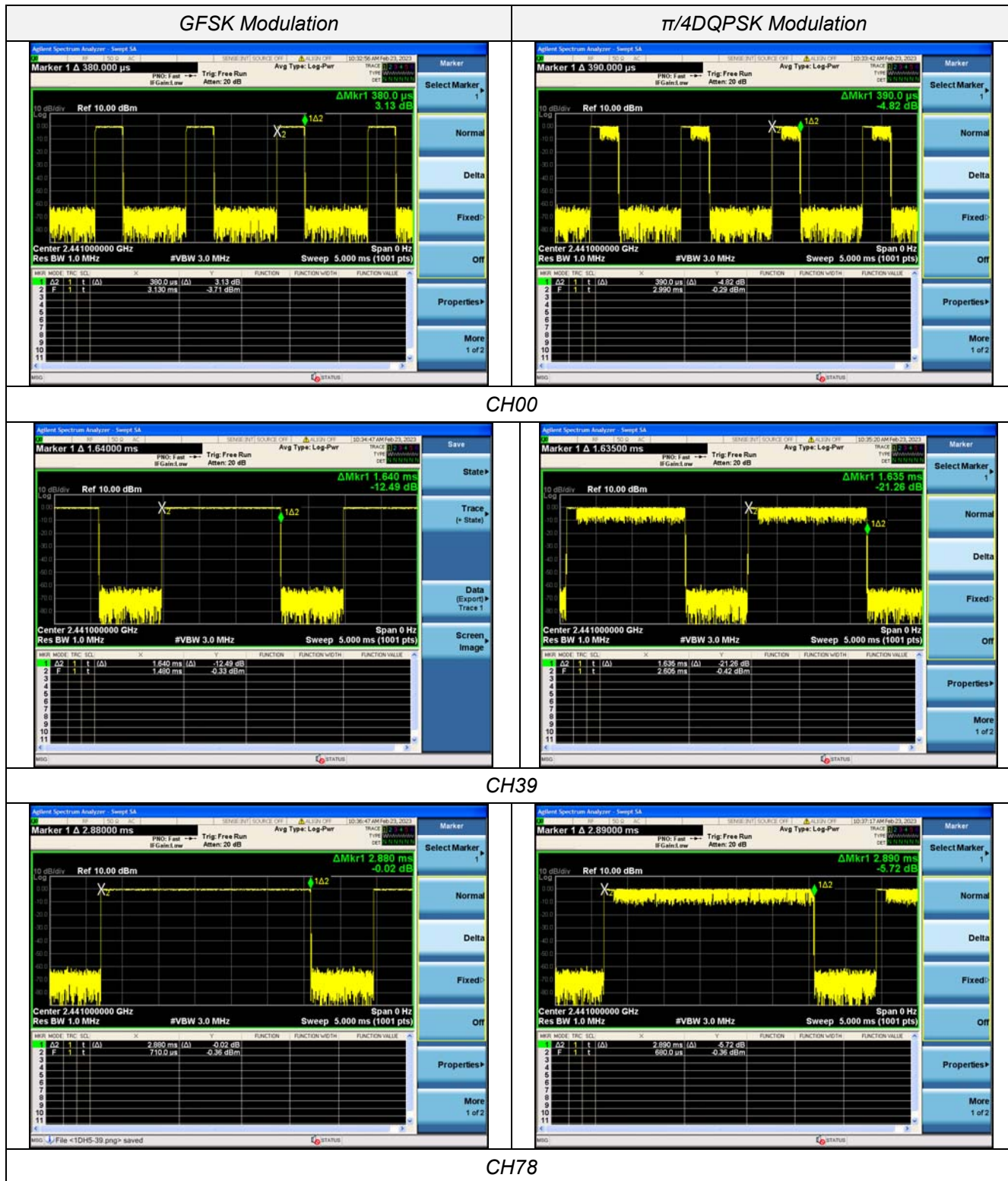

8DPSK Modulation

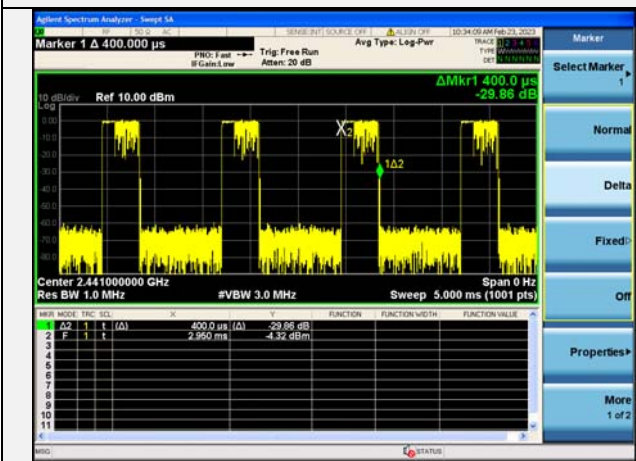

CH00

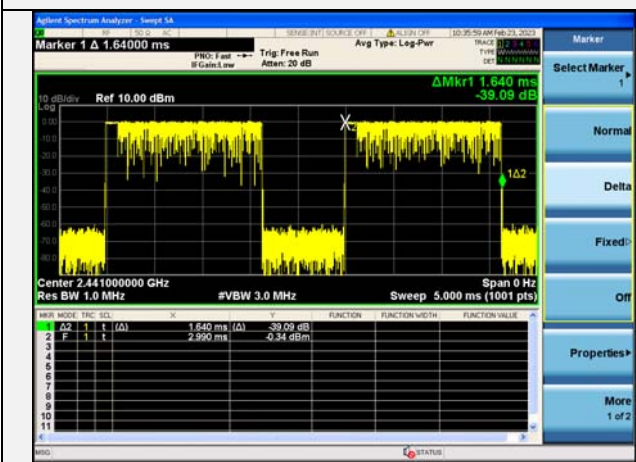

CH39

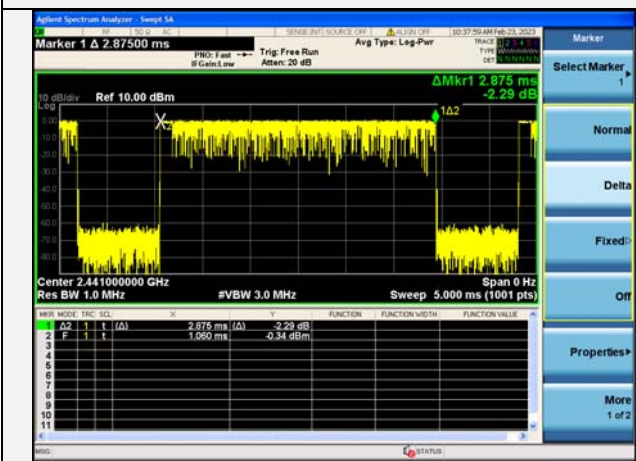

CH78

5.8 Spurious RF Conducted Emission

TEST CONFIGURATION

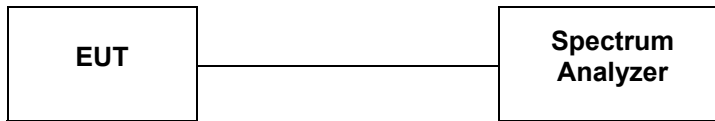

TEST PROCEDURE

The Spurious RF conducted emissions compliance of RF radiated emission should be measured by following the guidance in ANSI C63.10-2013 with respect to maximizing the emission by rotating the EUT, measuring the emission while the EUT is situated in three orthogonal planes (if appropriate), adjusting the measurement antenna height and polarization etc. Set RBW=100kHz and VBW= 300KHz to measure the peak field strength, and measure frequency range from 9KHz to 25GHz.

LIMIT

1. Below -20dB of the highest emission level in operating band.
2. Fall in the restricted bands listed in section 15.205. The maximum permitted average field strength is listed in section 15.209.

Test plot as follows:

GFSK CH00



30MHz -25GHz

GFSK CH39



30MHz -25GHz

GFSK CH78



30MHz -25GHz

$\pi/4$ DQPSK CH00



30MHz -25GHz

$\pi/4$ DQPSK CH39



30MHz -25GHz

$\pi/4$ DQPSK CH78



30MHz -25GHz

8DPSK CH00



30MHz -25GHz

8DPSK CH39



30MHz -25GHz

8DPSK CH78



30MHz -25GHz

Band-edge Measurements for RF Conducted Emissions:

GFSK

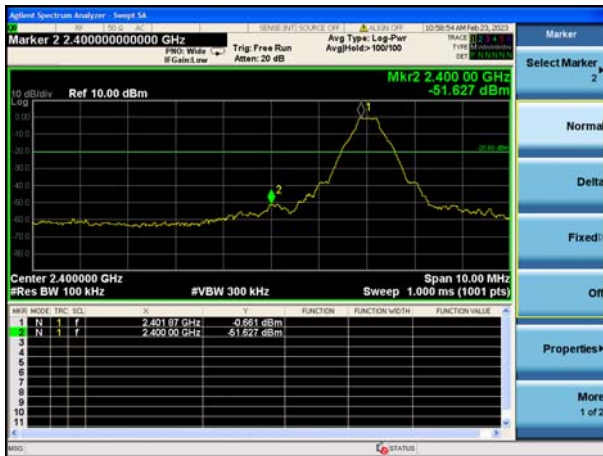

Left Band edge hopping off

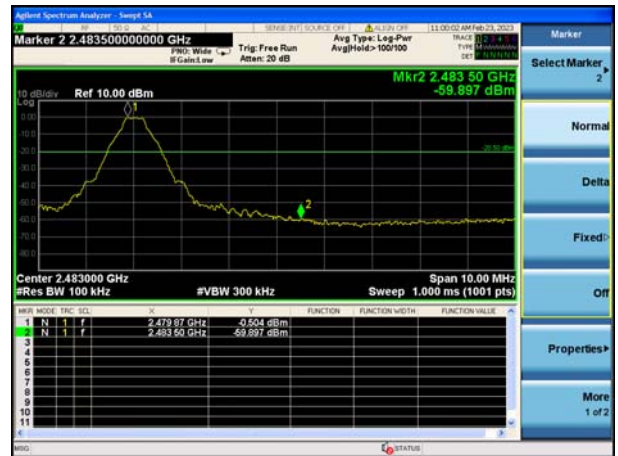

Right Band edge hopping off



Left Band edge hopping on



Right Band edge hopping on

$\pi/4$ DQPSK



Left Band edge hopping off



Right Band edge hopping off



Left Band edge hopping on



Right Band edge hopping on

8DPSK

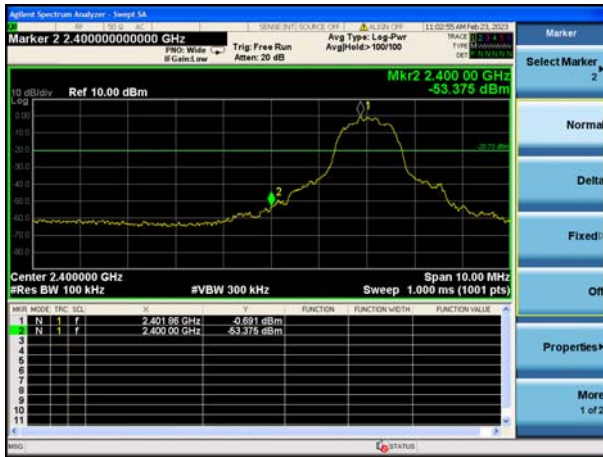

Left Band edge hopping off

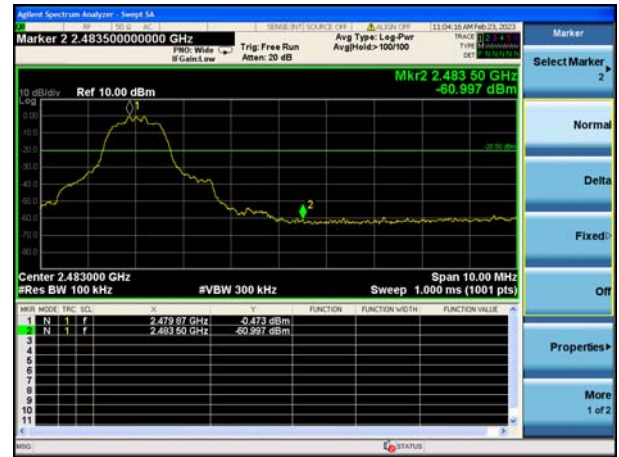

Right Band edge hopping off



Left Band edge hopping on

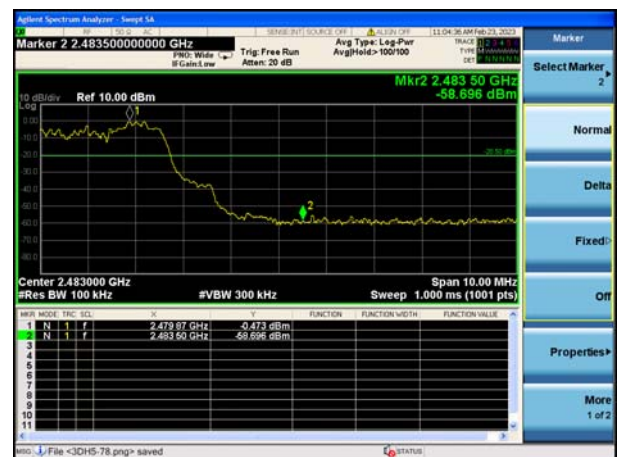

Right Band edge hopping on

5.9 Pseudorandom Frequency Hopping Sequence

TEST APPLICABLE

For 47 CFR Part 15C section 15.247 (a) (1) requirement:

Frequency hopping systems shall have hopping channel carrier frequencies separated by a minimum of 25 kHz or the 20 dB bandwidth of the hop-ping channel, whichever is greater. Alternatively, frequency hopping systems operating in the 2400–2483.5 MHz band may have hopping channel carrier frequencies that are separated by 25 kHz or two-thirds of the 20 dB bandwidth of the hopping channel, whichever is greater, provided the systems operate with an output power no greater than 125 mW. The system shall hop to channel frequencies that are selected at the system hopping rate from a pseudo randomly ordered list of hopping frequencies. Each frequency must be used equally on the average by each transmitter. The system receivers shall have input bandwidths that match the hop-ping channel bandwidths of their corresponding transmitters and shall shift frequencies in synchronization with the transmitted signals.

EUT Pseudorandom Frequency Hopping Sequence Requirement

The pseudorandom frequency hopping sequence may be generated in a nine-stage shift register whose 5th and 9th stage outputs are added in a modulo-two addition stage. And the result is fed back to the input of the first stage. The sequence begins with the first one of 9 consecutive ones, for example: the shift register is initialized with nine ones.

- Number of shift register stages:9
- Length of pseudo-random sequence:29-1=511 bits
- Longest sequence of zeros:8(non-inverted signal)

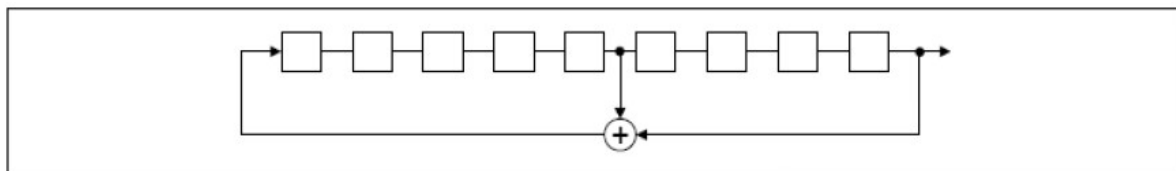

Linear Feedback Shift Register for Generation of the PRBS sequence

An example of pseudorandom frequency hopping sequence as follows:

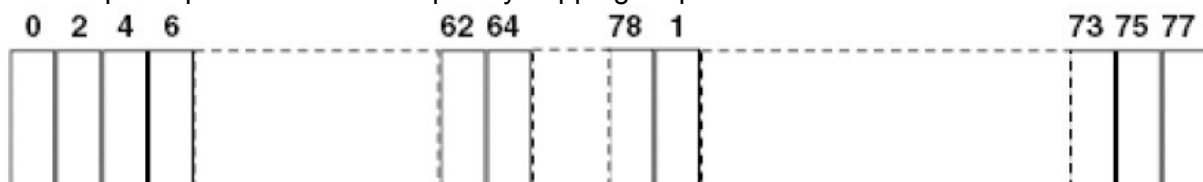

Each frequency used equally one the average by each transmitter.

The system receiver have input bandwidths that match the hopping channel bandwidths of their corresponding transmitter and shift frequencies in synchronization with the transmitted signals.

5.10 Antenna Requirement

Standard Applicable

For intentional device, according to FCC 47 CFR Section 15.203, an intentional radiator shall be designed to ensure that no antenna other than that furnished by the responsible party shall be used with the device.

And according to FCC 47 CFR Section 15.247 (c), if transmitting antennas of directional gain greater than 6dBi are used, the power shall be reduced by the amount in dB that the directional gain of the antenna exceeds 6dBi.

Refer to statement below for compliance

The manufacturer may design the unit so that the user can replace a broken antenna, but the use of a standard antenna jack or electrical connector is prohibited. Further, this requirement does not apply to intentional radiators that must be professionally installed.

Antenna Connected Construction

The directional gains of antenna used for transmitting is 0 dBi,, and the antenna is an PCB antenna connect to PCB board and no consideration of replacement. Please see EUT photo for details.

Results: Compliance.

6 Test Setup Photos of the EUT

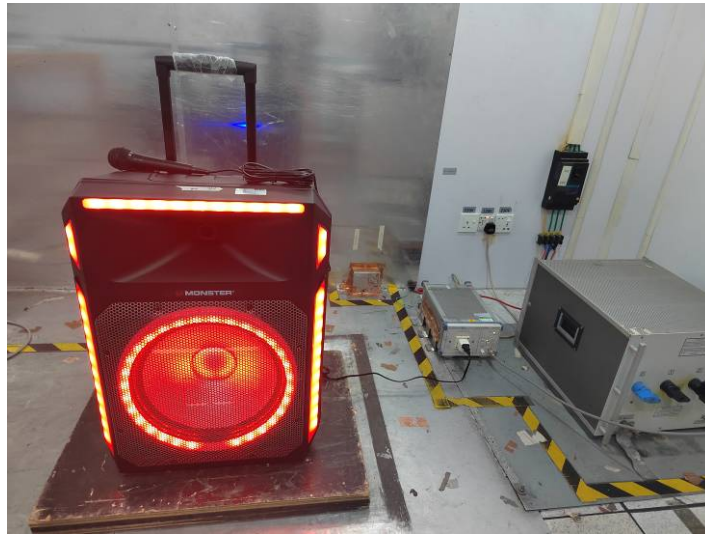

7 Photos of the EUT

***** End of Report *****