



## Instruction For Use

### Breathing Tester

- ◆ Thank you for purchasing the product of FEELLIFE HEALTH INC.
- ◆ In order to ensure your correct use of this product, be sure to read this IFU carefully before use.
- ◆ Please keep this IFU in a place where it can be easily accessed at any time.
- ◆ The illustrations in this IFU are schematic diagrams.



**Date of issue and edition:** 2022-11-19 V1.0

**Doc:** LFS-EN-UM-41B

**[Product name]:** Breathing Tester

**[Model]:** AirFit 1

**[Structural composition]:**

The Breathing Tester consists of mouthpiece, Venting hole, LCD screen, charging port, ON/OFF switch and Type-C cable.

**[Intended use]:**

The AirFit 1 will make your breathing muscles stronger, leading to reduced breathlessness during exercise or activity. This applies as much to committed athletes as it does to individuals with respiratory illnesses, such as COPD (chronic obstructive pulmonary disease) and asthma.

**[Storage and transportation]:**

Packaged Breathing Tester should be stored at a relative humidity not exceeding 93%, free of corrosive gases, ventilated.

It can be transported by ordinary means of transportation. Avoid impact, violent vibration, sun and rain during transportation.

**[Product Dimensions]:**

Length 141mmxWidth 26mmxHeight 11mm

**[Shelf life]:** 5 years.

**[Environmental environment]:**

Temperature: +5°C ~ +40°C

Relative Humidity: 15%~80% R.H.Non-condensing

Atmospheric Pressure: 86kPa~106kPa

**[Storage/Delivery environment]:**

Temperature: -20°C ~ +55°C

Relative Humidity: 10%~93% R.H.Non-condensing

Atmospheric Pressure: 70kPa~106kPa

**[Power supply]:**

Internal power supply: DC 3.7V, rechargeable lithium battery

External power supply: With DC5V, 1A adapter which meets IEC 60601-1



## Table of contents

Section I . Product overview.....	1
1. Product introduction.....	1
2. Product name.....	1
3. Model.....	1
4. Working principle.....	1
5. Software information.....	1
6. Structural composition.....	2
7. The appearance requirements of the device.....	3
8. Use and training.....	3
Section II . Safety.....	3
1. Safety operation instructions.....	3
2. Contraindications:.....	3
3. Warning:.....	4
4. Caution:.....	4
5. Declaration:.....	4
Section III. Quick Start Guide.....	5
1. Switch on and off the device.....	5
2. Start the training mode.....	5
3. Data view.....	5
4. History view.....	6
5. Power supply.....	6
6. Using the Nose-clip.....	6
7. Instructions for use of Breathing Tester app.....	7
Section IV. Cleaning and disinfection.....	8
Section V. Storage and Maintenance.....	9
Section VI. Signs and symbols.....	9
Section VII. Configuration list.....	10
Section VIII. Manufacturer and Rep. information.....	10



## **Section I . Product overview**

### 1. Product introduction

Dear customer, thank you for your purchase. The AirFit 1 will make your breathing muscles stronger, leading to reduced breathlessness during exercise or activity. This applies as much to committed athletes as it does to individuals with respiratory illnesses, such as COPD (chronic obstructive pulmonary disease) and asthma.

### 2. Product name

Breathing Tester

### 3. Model

AirFit 1

### 4. Working principle

The AirFit 1 Breathing Tester uses an electronically controlled airflow valve to create inspiratory resistance. Exercise your lung muscles with breathing resistance, increasing the strength of your arm muscles similar to lifting weights. When you use the Breathing Tester you will notice that the greater the resistance with each breath, which is the effect of the airflow resistance effect on your muscles (mainly the diaphragm and rib cage). There is no resistance during exhalation, and normal exhalation can be performed, allowing the chest and lung muscles to relax and naturally drain air from the lungs.

### 5. Software information

#### 5.1 Software model

Breathing Tester software model: AirFit 1

## 5.2 Software version

AirFit 1 Breathing Tester initial version: AirFit 1 V1.0, release version: AirFit 1 V1.0.

## 5.3 Version number naming convention

The full software version number consists of <project name> <major version number><minor version number>. The initial version number is V1.0.

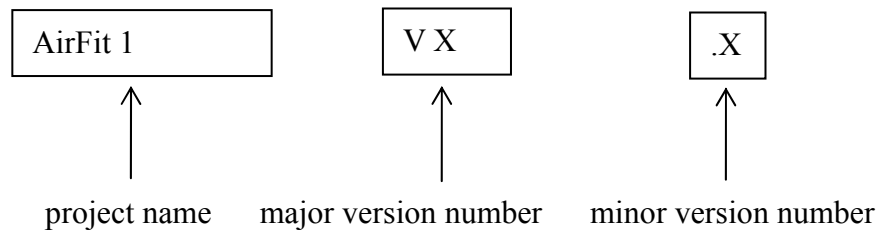

### 5.3.1 The meaning of each field of the software version number

- 1) Project name: product development project
- 2) Version number: Version ID, It consists of the letter V and a number. V is the abbreviation of Version, X is a number. For example, V1.0 means that the major version number of the software is V1, and the minor version number is 0.

### 5.3.2 Software Upgrade Instructions

- 1) When the software is relatively updated or there are many local corrections accumulated, resulting in a global change as a whole, the major version number is incremented by 1, and the minor version number remains unchanged. For example: when adding or deleting functions or major performance changes, when adapting updates, corrective updates, and build and corrective updates, upgrade from AirFit 1 V1.0 to AirFit 1 V2.0.
- 2) The software has some minor revisions. When bugs are corrected, the major version number of perfect update and preventive update will remain unchanged, and the minor version number will be increased by 1. For example, upgrading from AirFit 1 V1.0 to AirFit 1 V1.1.

## 6. Structural composition

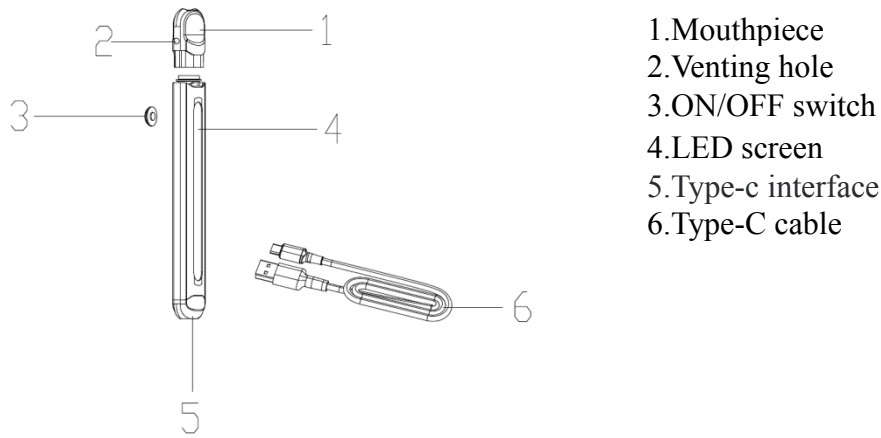

## 7. The appearance requirements of the device

1) The appearance should be neat, uniform in color and free from defects such as obvious scratches, cracks and deformation.

2) Text and logos should be clearly visible.

3) The keys should be flexible and reliable, the accessories should be connected reliably, and the fastening parts should not be loose.

## 8. Use and training

It is recommended to use AirFit 1 for 5-10 minutes a day, separate from other sports, that is, start training with 3-5 groups of exercises every day, and then continue to increase the intensity according to your own situation. Normally, you can feel a significant improvement in a month and a half to 2 months.

## Section II. Safety

### 1. Safety operation instructions

Breathing Testers are suitable for all and will not produce harmful side effects if used normally. Please read the following precautions to ensure that you are using your device safely and correctly

### 2. Contraindications:

During training, the Breathing Tester creates negative pressure in the chest, throat, ears and sinuses. You should not continue using any of the following if you have:

a. History of spontaneous pneumothorax (non-traumatic lung injury, such as rib fracture).

b. Lung injuries due to incomplete healing of trauma.

c. Rupture of the tympanic membrane that has not completely healed, or any other condition of



the tympanic membrane.

3.  Warning:

If you feel dizzy when training with the Breathing Tester, slow your breathing or pause until you are fully recovered.

If you have a cold, sinusitis, or respiratory infection, we recommend that you do not use this device until symptoms develop.

Some users may experience mild ear discomfort when the cold is not cured, which is caused by the imbalance of pressure on both sides. If symptoms persist, consult a doctor.

To prevent cross infection, we recommend that you bite your mouth and do not share it with others.

If you feel uncomfortable when using the Breathing Tester, stop immediately and consult a doctor.

4.  Caution:

1) Breathing Tester is designed to exercise your lung capacity and has no therapeutic effects.

2) This product is not intended to diagnose, monitor, treat, cure or prevent any disease.

3) All children under the age of 16 should only be used under the supervision of an adult.

4) Breathing Tester contains small parts and is not suitable for children under 7 years of age.

5) Do not use the device in other activities such as running, and driving.

6) If you have a pacemaker or other medical implant or electronic product containing magnets, consult your physician before using this product.

7) If you have any questions about the suitability of the product or if you have a medical condition, consult your doctor.

5. Declaration:

◆ The use of this product by children and special populations must be carried out under the proper guidance and supervision.

◆ Breathing Tester can only be used for the stated purpose and cannot be used for other purposes.

◆ If you find that the part is damaged or accidentally fell into the water, do not continue to use.

◆ Be sure to unplug the power supply before cleaning.

### Section III. Quick Start Guide

The Quick Start Guide section is for informational purposes only, and we recommend that you read the full article.

#### 1. Switch on and off the device

Long press(>3 seconds) the "ON/OFF switch"  to power on the system until the power-on interface is displayed as below.

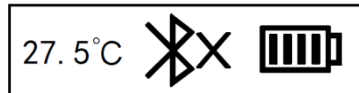

Figure 1

#### 2. Start the training mode

① Inhale as much as possible.

② Hold this device and mouth containing the mouthpiece. keep not to leakage.

③ Make sure to blow out the gas until you reach the point where no more exhalation is possible.

#### Note:

1) During the process of blowing gas, blow out the gas at a uniform speed. Remember not to blow too fast or too slow. It will make the result not exact if you blow at a fast or slow speed.

2) Remeasurement is required when the following conditions are encountered:

- a. Cough
- b. Exhalation time is too short
- c. Slow expiratory speed
- d. The measured value deviates significantly from the normal value

#### 3. Data view

During the blowing process, the numbers in the continuous to increase, and the indicator light are displayed from low to high until the blowing stops. The number will display on the screen, as shown in the figure below.

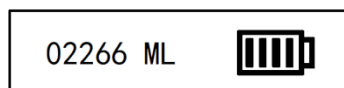

Figure 2



#### 4. History view

Short press(<1 second) the ON/OFF switch to enter the historical view state, the device can keep the last 5 sets of data. View in turn 5 sets of data by short(<1 seconds) press the ON/OFF switch.

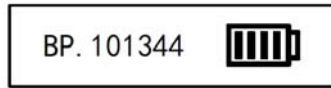

Figure 3

#### 5. Power supply

Use the Type-C cable for charging. The screen will display the icon and it will flash when charging shown as below. Full charged state will shown as figure 5.

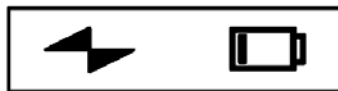

Figure 4



Figure 5

#### Note:

- 1)At the end of expect service life, please dispose this device and accessories according to the local environmental regulation, do not dispose together with the domestic refuse to avoid environment pollution.
- 2)Please use the power adapter (DV 5.0V, 1A) which meets IEC 60601-1 to power this device.
- 3)Do not modify this equipment without authorization of the manufacturer.
- 4)Do not disassemble or repair this device without permission, and do not disassemble or replace the battery without permission.If you need to replace the battery, please consult the manufacturer.
- 5)The device cannot work when charging.

#### Caution:

- 1)When the battery capacity is insufficient,please powered by charging cable.
- 2)Keep charging the device at least once per month during the storage period exceed one month.

#### 6.Using the Nose-clip

AirFit 1 is provided with a nose-clip to help you to breathe through your mouth rather than your nose.however. it is not essential and some people find it more comfortable to train



without the nose-clip.

## 7. Instructions for use of Breathing Tester app

### 7.1 Installation methods for different phone systems:

#### a. IOS system:

Connect the mobile phone to the Internet, scan QR code below or search for “AirSmart” from the APP store to download APP. Go back to the phone desktop to open the APP.



Figure 6

#### b. Android system:

Connect the mobile phone to the Internet, scan QR code below or search for “AirSmart” from the APP store to download APP. Go back to the phone desktop to open the APP.



Figure 7

### 7.2 Open the application interface, click the device button. There are three log in methods:

- a. Wechat
- b. Apple ID
- c. Tourist identify

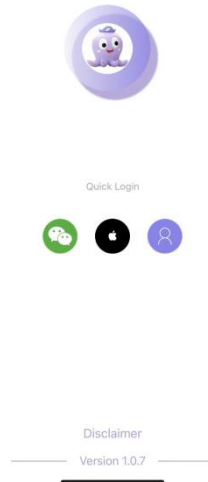

Figure 8

### 7.3 Connect the AirFit 1

- 1) Turn on the Bluetooth and log in.
- 2) Turn on the AirFit 1.
- 3) Search for the Breathing Tester , select the device, enter the main interface.

Figure 9

- 4) Go to the device page, the connected status will synchronize all the information of the device, and you can view the historical data, temperature, battery power, atmospheric pressure and so on in the App.

Figure 10

- 5) Historical data view

Figure 11

## Section IV. Cleaning and disinfection

Before and after each use, be sure to clean and disinfect the product. We suggest one device be used for single person.

### Cleaning

- 1) Clean the mouthpiece by clean medical gauze which soaks up the water.
- 2) Keep the device in dry and clean environment to avoid pollution.

### Note:

The equipment waterproof classification is IP22. To prevent the ingress of water, this device



cannot be washed by flowing water.

**Disinfection**

1)Clean the mouthpiece by clean medical gauze which soaks up the 70% ethyl alcohol .  
Wipe the shell of the product with 70% ethyl alcohol for several times and dry with clean medical gauze.



Warning:

Please don't use the disinfectant of Benzalkonium bromide or house bleach.  
Be careful not to damage the vibrating mesh when disinfecting and cleaning.  
Never use Sodium hypochlorite, Hypochlorous acid or quaternary ammonium compound to disinfect.  
The disinfectant residues should be cleaned thoroughly to assure safe use next time.











**Section V. Storage and Maintenance**

- 1)The storage and transportation conditions of the products are detailed in the first page of this Instructions for use.
- 2)Keep the device out of the reach of unsupervised infants and children. The small parts of this device may be swallowed by the infants and children.
- 3)Prevent pets and pests from damaging this device.
- 4)Dry the parts immediately after cleaning and disinfection. Store the device in the environment that meets the requirements, be careful to avoid collisions.
- 5)Make sure that unplug the power plug before storing.
- 6)When do not use the device for a long time, please unplug the power plug.
- 7)It should be stored in a place with no corrosive gas and good ventilation, please avoid severe shock during transportation.
- 8)Do not use benzene, diluents and flammable chemicals to clean the product.

**Section VI. Signs and symbols**

General symbol	Description / title	General symbol	Description / title
	Date of manufacture		General warning sign
	Manufacturer information		Refer to instructions for use
	Authorised representative in the European community		Keep dry
	Caution		This way up



	Temperature limit		Batch code
	Type BF applied part		Humidity limitation
	Keep away from sunlight		Atmospheric pressure limitation
<b>RoHS</b>	This device complies with the requirements of the RoHS Directive 2011/65/EU and the RoHS Standards IEC 62321-1:2013.		When this device life expires, the end users should discard this device according to the requirements from the local environment protection authority.
	Medical device		Please read the instructions for use carefully before using.
	Stand-by	<b>IP22</b>	Degree of protection against the ingress of water.

**Section VII. Configuration list**

Name	Quantity	Whether to configure	Model specifications
Main unit	1	√	
Mouthpiece	1	√	
Nose clip	1	√	
Type-C cable	1	√	
Instructions for use	1	√	/
Certificate	1	√	/

**Section VIII. Manufacturer and Rep. information**

FEELLIFE HEALTH INC.



Room 1903, Building A, No.9 Furong Road, Tantou Community,  
Songgang Subdistrict, Bao'an District, Shenzhen, 518104 Guangdong, China

TEL: +86-755-66867080

E-mail: [info@feellife.com](mailto:info@feellife.com)

Website: [www.feellife.com](http://www.feellife.com)



Lotus NL B.V.

Koningin Julianaplein 10,1e Verd,2595AA,The Hague, Netherlands.

### FCC Statement

This device complies with part 15 of the FCC Rules. Operation is subject to the following two conditions: (1) This device may not cause harmful interference, and (2) this device must accept any interference received, including interference that may cause undesired operation.

#### RF Exposure Information

Caution: Any changes or modifications to this device not explicitly approved by manufacturer could void your authority to operate this equipment.

This equipment has been tested and found to comply with the limits for a Class B digital device, pursuant to part 15 of the FCC Rules. These limits are designed to provide reasonable protection against harmful interference in a residential installation. This equipment generates, uses and can radiate radio frequency energy and, if not installed and used in accordance with the instructions, may cause harmful interference to radio communications. However, there is no guarantee that interference will not occur in a particular installation. If this equipment does cause harmful interference to radio or television reception, which can be determined by turning the equipment off and on, the user is encouraged to try to correct the interference by one or more of the following measures:

- Reorient or relocate the receiving antenna.
- Increase the separation between the equipment and receiver.
- Connect the equipment into an outlet on a circuit different from that to which the receiver is connected.
- Consult the dealer or an experienced radio/TV technician for help.

The device has been evaluated to meet general RF exposure requirement. This equipment should be installed and operated with minimum distance 0mm between the radiator & your body.