

# TEST REPORT

**Applicant:** SHENZHEN FUTURE ACCESS TECHNOLOGY CO., LIMITED  
**Address:** B-206, Block B, Tsinghua Unis Inforport, Hi-Tech Park(North), Nanshan District, Shenzhen, China  
**Equipment Type:** Wireless Earbuds  
**Model Name:** ColorBuds2 (refer section 2.4)  
**Brand Name:** HiFuture  
**FCC ID:** 2BA4V-HIFUTUREHECLB  
**Test Standard:** 47 CFR Part 15 Subpart C (refer section 3.1)  
**Sample Arrival Date:** May 10, 2023  
**Test Date:** May 13, 2023 - May 18, 2023  
**Date of Issue:** May 25, 2023

**ISSUED BY:**

Shenzhen BALUN Technology Co., Ltd.

**Tested by:** Julie Zhu

**Checked by:** Ye Hongji

**Approved by:** Liao Jianming  
(Technical Director)

*Julie Zhu*

*Ye Hongji*

*Liao Jianming*

<b>Revision History</b>		
<u>Version</u>	<u>Issue Date</u>	<u>Revisions</u>
<u>Rev. 01</u>	<u>May 25, 2023</u>	<u>Initial Issue</u>

## TABLE OF CONTENTS

1	GENERAL INFORMATION .....	4
1.1	Test Laboratory .....	4
1.2	Test Location .....	4
2	PRODUCT INFORMATION .....	5
2.1	Applicant Information .....	5
2.2	Manufacturer Information .....	5
2.3	Factory Information .....	5
2.4	General Description for Equipment under Test (EUT) .....	5
2.5	Technical Information .....	6
3	SUMMARY OF TEST RESULTS .....	8
3.1	Test Standards .....	8
3.2	Test Verdict .....	8
4	GENERAL TEST CONFIGURATIONS .....	9
4.1	Test Environments .....	9
4.2	Test Equipment List .....	9
4.3	Test Software List .....	9
4.4	Measurement Uncertainty .....	10
4.5	Description of Test Setup .....	10
4.6	Measurement Results Explanation Example .....	13
5	TEST ITEMS .....	14
5.1	Antenna Requirements .....	14
5.2	Frequency Hopping Systems .....	15
5.3	Number of Hopping Frequencies .....	17
5.4	Peak Output Power .....	18

5.5	Occupied Bandwidth .....	19
5.6	Carrier Frequency Separation .....	20
5.7	Time of Occupancy (Dwell time) .....	21
5.8	Conducted Spurious Emission & Authorized-band band-edge .....	23
5.9	Conducted Emission .....	24
5.10	Radiated Spurious Emission .....	25
5.11	Band Edge (Restricted-band band-edge).....	27
ANNEX A	TEST RESULT .....	28
A.1	Number of Hopping Frequency .....	28
A.2	Peak Output Power .....	29
A.3	20 dB and 99% bandwidth .....	32
A.4	Hopping Frequency Separation.....	36
A.5	Average Time of Occupancy .....	37
A.6	Conducted Spurious Emissions & Authorized-band band-edge .....	40
A.7	Conducted Emissions.....	47
A.8	Radiated Spurious Emission .....	49
A.9	Band Edge (Restricted-band band-edge).....	63
ANNEX B	TEST SETUP PHOTOS .....	67
ANNEX C	EUT EXTERNAL PHOTOS .....	67
ANNEX D	EUT INTERNAL PHOTOS .....	67

# 1 GENERAL INFORMATION

## 1.1 Test Laboratory

Name	Shenzhen BALUN Technology Co., Ltd.
Address	Block B, 1/F, Baisha Science and Technology Park, Shahe Xi Road, Nanshan District, Shenzhen, Guangdong Province, P. R. China
Phone Number	+86 755 6685 0100

## 1.2 Test Location

Name	Shenzhen BALUN Technology Co., Ltd.
Location	<input checked="" type="checkbox"/> Block B, 1/F, Baisha Science and Technology Park, Shahe Xi Road, Nanshan District, Shenzhen, Guangdong Province, P. R. China
	<input type="checkbox"/> 1/F, Building B, Ganghongji High-tech Intelligent Industrial Park, No. 1008, Songbai Road, Yangguang Community, Xili Sub-district, Nanshan District, Shenzhen, Guangdong Province, P. R. China
Accreditation Certificate	The laboratory is a testing organization accredited by FCC as a accredited testing laboratory. The designation number is CN1196.

## 2 PRODUCT INFORMATION

### 2.1 Applicant Information

Applicant	SHENZHEN FUTURE ACCESS TECHNOLOGY CO., LIMITED
Address	B-206, Block B, Tsinghua Unis Inforport, Hi-Tech Park(North), Nanshan District, Shenzhen, China

### 2.2 Manufacturer Information

Manufacturer	SHENZHEN FUTURE AUDIO TECHNOLOGY CO., LTD
Address	4~5F, Block A, Jinchi 3rd Industrial Park, Jiuwei, Hangcheng street, Baoan District, Shenzhen, Guangdong, China

### 2.3 Factory Information

Factory	N/A
Address	N/A

### 2.4 General Description for Equipment under Test (EUT)

EUT Name	Wireless Earbuds
Model Name Under Test	ColorBuds2
Series Model Name	FlyBuds3, TrueAir Pro
Description of Model name differentiation	The Circuit, PCB Layout, Electrical Parts, and appearance of the following product(s) are identical to the basic models, except the model name and product name changed for different market and customer, the others are the same. (this information provided by the customer)
Hardware Version	V1.0
Software Version	V1.0
Dimensions (Approx.)	N/A
Weight (Approx.)	N/A

## 2.5 Technical Information

Network and Wireless connectivity	Bluetooth (BR+EDR)
-----------------------------------	--------------------

The requirement for the following technical information of the EUT was tested in this report:

Modulation Technology	FHSS
Modulation Type	GFSK, $\pi/4$ -DQPSK
Product Type	<input type="checkbox"/> Mobile <input checked="" type="checkbox"/> Portable <input type="checkbox"/> Fix Location
Transfer Rate	DH5: 1 Mbps 2DH5: 2 Mbps
Frequency Range	The frequency range used is 2400 MHz to 2483.5 MHz.
Number of Channel	79 (at intervals of 1 MHz)
Tested Channel	0 (2402 MHz), 39 (2441 MHz), 78 (2480 MHz)
Antenna Type	Ceramic Antenna
Antenna Gain	4.08 dBi
Antenna Impedance	50 $\Omega$
Antenna System (MIMO Smart Antenna)	N/A

All channel was listed on the following table:

Channel number	Freq. (MHz)	Channel number	Freq. (MHz)	Channel number	Freq. (MHz)	Channel number	Freq. (MHz)
<b>0</b>	<b>2402</b>	21	2423	42	2444	63	2465
1	2403	22	2424	43	2445	64	2466
2	2404	23	2425	44	2446	65	2467
3	2405	24	2426	45	2447	66	2468
4	2406	25	2427	46	2448	67	2469
5	2407	26	2428	47	2449	68	2470
6	2408	27	2429	48	2450	69	2471
7	2409	28	2430	49	2451	70	2472
8	2410	29	2431	50	2452	71	2473
9	2411	30	2432	51	2453	72	2474
10	2412	31	2433	52	2454	73	2475
11	2413	32	2434	53	2455	74	2476
12	2414	33	2435	54	2456	75	2477
13	2415	34	2436	55	2457	76	2478
14	2416	35	2437	56	2458	77	2479
15	2417	36	2438	57	2459	<b>78</b>	<b>2480</b>
16	2418	37	2439	58	2460	-	-
17	2419	38	2440	59	2461	-	-
18	2420	<b>39</b>	<b>2441</b>	60	2462	-	-
19	2421	40	2442	61	2463	-	-
20	2422	41	2443	62	2464	-	-

### 3 SUMMARY OF TEST RESULTS

#### 3.1 Test Standards

No.	Identity	Document Title
1	47 CFR Part 15, Subpart C	Intentional radiators of radio frequency equipment
2	ANSI C63.10-2013	American National Standard for Testing Unlicensed Wireless Devices
3	KDB 558074 D01 15.247 Meas Guidance v05r02	Guidance for compliance measurements on digital transmission system, frequency hopping spread spectrum system, and hybrid system devices operating under section 15.247 of the FCC rules

#### 3.2 Test Verdict

No.	Description	FCC Part No.	Channel	Test Result	Verdict	Remark
1	Antenna Requirement	15.203	N/A	--	Pass	Note <sup>1</sup>
2	Number of Hopping Frequencies	15.247(a)	Hopping Mode	ANNEX A.1	Pass	--
3	Peak Output Power	15.247(b)	Low/Middle/High	ANNEX A.2	Pass	--
4	Occupied Bandwidth	15.247(a)	Low/Middle/High	ANNEX A.3	Pass	--
5	Carrier Frequency Separation	15.247(a)	Hopping Mode	ANNEX A.4	Pass	--
6	Time of Occupancy (Dwell time)	15.247(a)	Hopping Mode	ANNEX A.5	Pass	--
7	Conducted Spurious Emission & Authorized-band band-edge	15.247(d)	Hopping Mode; Low/Middle/High	ANNEX A.6	Pass	--
8	Conducted Emission	15.207	Low/Middle/High	ANNEX A.7	Pass	--
9	Radiated Spurious Emission	15.209 15.247(d)	Low/Middle/High	ANNEX A.8	Pass	--
10	Band Edge(Restricted-band band-edge)	15.209 15.247(d)	Low/High	ANNEX A.9	Pass	--
11	Receiver Spurious Emissions	--	--	--	N/A	Note <sup>2</sup>

Note <sup>1</sup>: Please refer to section 5.1

Note <sup>2</sup>: Only radio communication receivers operating in stand-alone mode within the band 30-960 MHz, as well as scanner receivers, are subject to Industry Canada requirements, so this test is not applicable.



## 4 GENERAL TEST CONFIGURATIONS

### 4.1 Test Environments

During the measurement, the normal environmental conditions were within the listed ranges:

Relative Humidity	48% to 61%	
Atmospheric Pressure	100 kPa to 102 kPa	
Temperature	NT (Normal Temperature)	+21.2°C to +23.9°C
Working Voltage of the EUT	NV (Normal Voltage)	3.7 V

### 4.2 Test Equipment List

Description	Manufacturer	Model	Serial No.	Cal. Date	Cal. Due
Spectrum Analyzer	KEYSIGHT	N9020A	MY50330200	2022.05.19	2023.05.18
Spectrum Analyzer	ROHDE&SCHWARZ	FSV-40	101544	2022.12.28	2023.12.27
Spectrum Analyzer	KEYSIGHT	N9020A	MY52510065	2022.09.06	2023.09.05
Signaling Unit	ROHDE&SCHWARZ	CMW500	171150	2022.06.29	2023.06.28
Test Antenna-Horn	SCHWARZBECK	BBHA 9120D	01631	2022.02.03	2025.02.02
Test Antenna-Horn	A-INFO	LB-180400KF	J211060273	2021.07.02	2024.07.01
Anechoic Chamber	RAINFORD	9m*6m*6m	144	2022.02.19	2024.09.03
EMI Receiver	ROHDE&SCHWARZ	ESRP	101036	2022.09.09	2023.09.08
Test Antenna-Loop	SCHWARZBECK	FMZB 1519	1519-037	2021.04.16	2024.04.15
Anechoic Chamber	EMC Electronic Co., Ltd	20.10*11.60*7.35m	130	2021.08.15	2024.08.14
Test Antenna-Bi-Log	SCHWARZBECK	VULB 9163	9163-624	2021.08.20	2024.08.19
EMI Receiver	KEYSIGHT	N9038A	MY53220118	2022.09.08	2023.09.07
Anechoic Chamber	RAINFORD	9m*6m*6m	101	2023.03.26	2026.03.03
EMI Receiver	KEYSIGHT	N9010B	MY57110309	2022.09.09	2023.09.08
LISN	SCHWARZBECK	NSLK 8127	8127-687	2022.06.01	2023.05.31
Shielded Enclosure	YiHeng Electronic Co., Ltd	3.5m*3.1m*2.8m	112	2022.02.19	2025.02.18
Amplifier	COM-MV	LSCX_LNA1-12G-01	180602	2020.09.08	2023.09.07
Amplifier	COM-MV	XKu_LNA7-18G-01	180601	2020.09.08	2023.09.07
Amplifier	COM-MV	KA_LNA18-40G-01	18050001	2020.09.08	2023.09.07
Amplifier	COM-MV	ZT30-1000M	B2017119082	2022.12.07	2023.12.06

### 4.3 Test Software List

Description	Manufacturer	Software Version	Serial No.	Applicable test Setup
BL410R	BALUN	V2.1.1.488	N/A	The section 4.5.1
BL410E	BALUN	V19.8.28.435	N/A	The section 4.5.2&4.5.3&4.5.4&4.5.5

### 4.4 Measurement Uncertainty

The following measurement uncertainty levels have been estimated for tests performed on the EUT as specified in CISPR 16-4-2.

This uncertainty represents an expanded uncertainty expressed at approximately the 95% confidence level using a coverage factor of k=2.

Parameters	Uncertainty
Occupied Channel Bandwidth	2.8%
RF output power, conducted	1.28 dB
Power Spectral Density, conducted	1.30 dB
Unwanted Emissions, conducted	1.84 dB
All emissions, radiated	5.36 dB
Temperature	0.82°C
Humidity	4.1%

### 4.5 Description of Test Setup

#### 4.5.1 For Antenna Port Test

$$\text{Conducted value (dBm)} = \text{Measurement value (dBm)} + \text{cable loss (dB)}$$

For example: the measurement value is 10 dBm and the cable 0.5dBm used, then the final result of EUT:

$$\text{Conducted value (dBm)} = 10 \text{ dBm} + 0.5 \text{ dB} = 10.5 \text{ dBm}$$

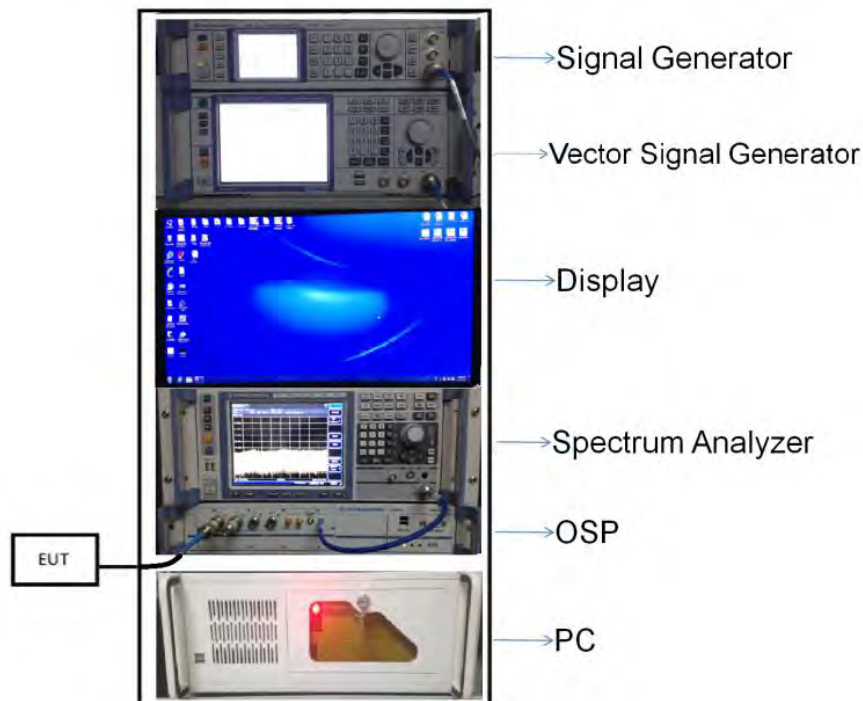

(Diagram 1)

### 4.5.2 For AC Power Supply Port Test



(Diagram 2)

### 4.5.3 For Radiated Test (Below 30 MHz)

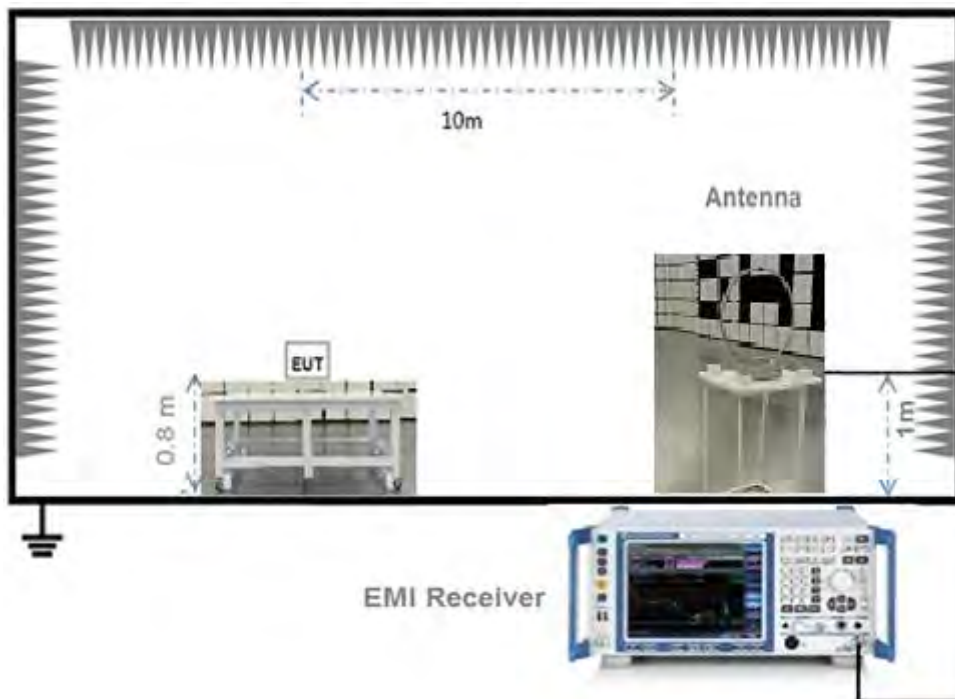

(Diagram 3)

#### 4.5.4 For Radiated Test (30 MHz-1 GHz)

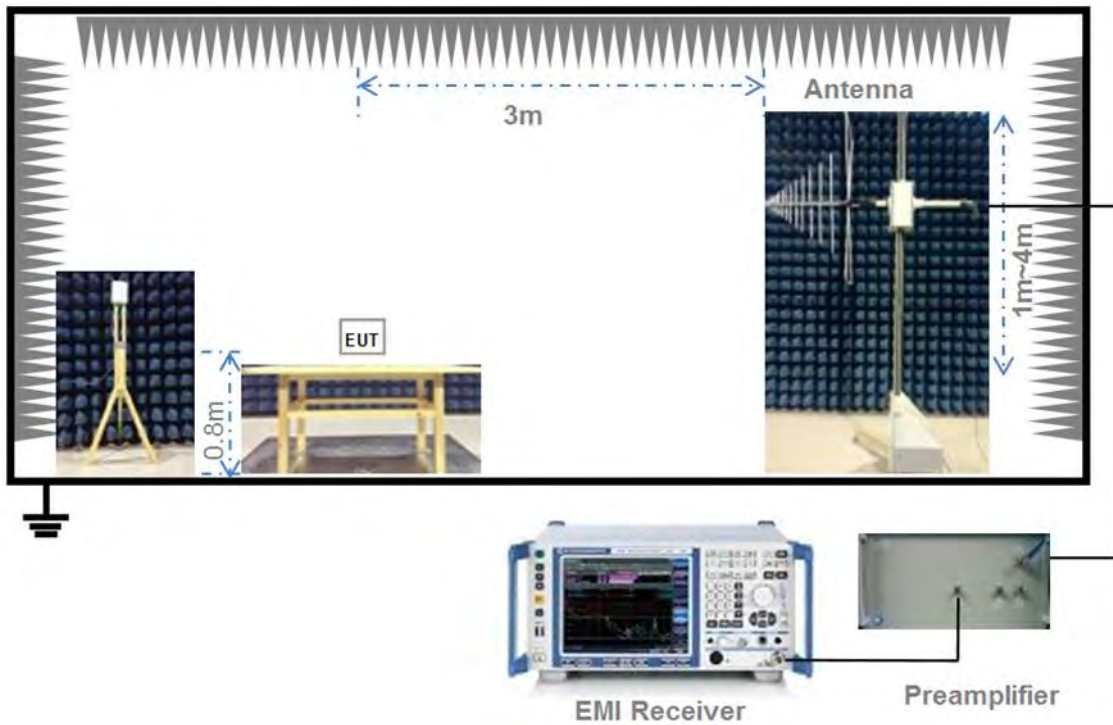

(Diagram 4)

#### 4.5.5 For Radiated Test (Above 1 GHz)

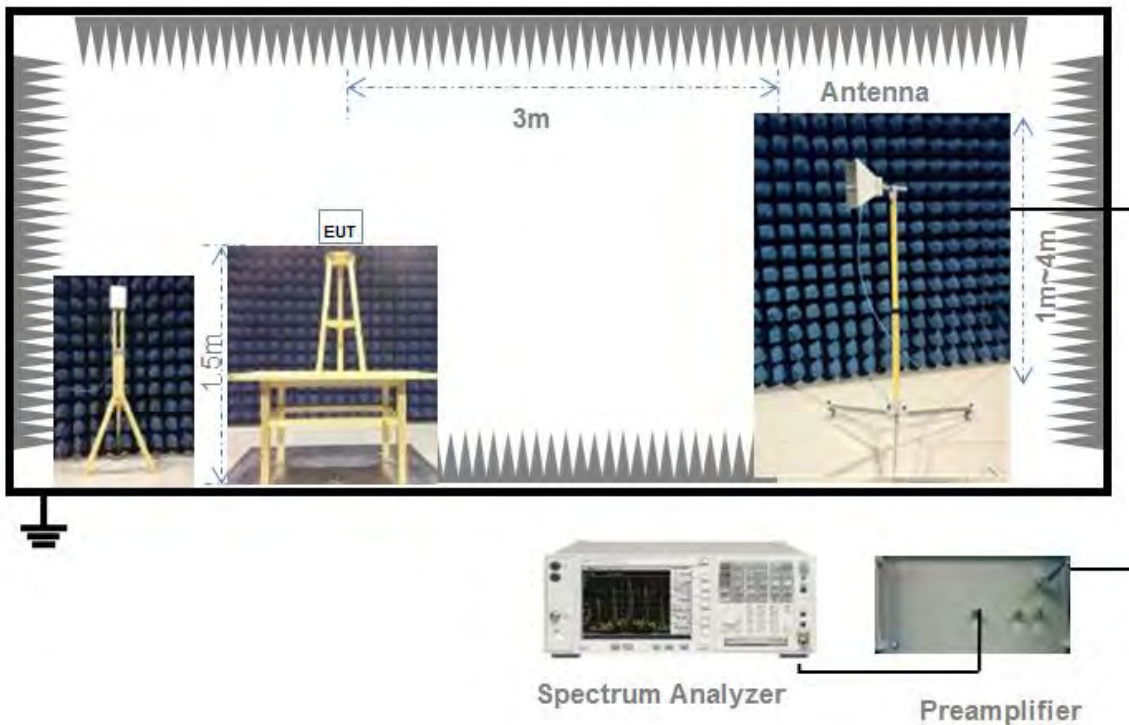

(Diagram 5)

## 4.6 Measurement Results Explanation Example

### 4.6.1 For conducted test items:

The offset level is set in the spectrum analyzer to compensate the RF cable loss and attenuator between EUT conducted output port and spectrum analyzer. With the offset compensation, the spectrum analyzer reading level is exactly the EUT RF output level.

The spectrum analyzer offset is derived from RF cable loss and attenuator factor.

Offset = RF cable loss + attenuator factor.

## 5 TEST ITEMS

### 5.1 Antenna Requirements

#### 5.1.1 Relevant Standards

FCC §15.203 & 15.247(b)

An intentional radiator shall be designed to ensure that no antenna other than that furnished by the responsible party shall be used with the device. The use of a permanently attached antenna or of an antenna that uses a unique coupling to the intentional radiator shall be considered sufficient to comply with the provisions of this section. The manufacturer may design the unit so that a broken antenna can be replaced by the user, but the use of a standard antenna jack or electrical connector is prohibited. This requirement does not apply to carrier current devices or to devices operated under the provisions of § 15.211, § 15.213, § 15.217, § 15.219, or § 15.221. Further, this requirement does not apply to intentional radiators that must be professionally installed, such as perimeter protection systems and some field disturbance sensors, or to other intentional radiators which, in accordance with § 15.31(d), must be measured at the installation site. However, the installer shall be responsible for ensuring that the proper antenna is employed so that the limits in this part are not exceeded.

If directional gain of transmitting antennas is greater than 6 dBi, the power shall be reduced by the same level in dB comparing to gain minus 6 dBi. For the fixed point-to-point operation, the power shall be reduced by one dB for every 3 dB that the directional gain of the antenna exceeds 6 dBi. The use of a permanently attached antenna or of an antenna that uses a unique coupling to the intentional radiator shall be considered sufficient to comply with the FCC rule.

#### 5.1.2 Antenna Anti-Replacement Construction

The Antenna Anti-Replacement as following method:

Protected Method	Description
The antenna is embedded in the product.	An embedded-in antenna design is used.

Reference Documents	Item
Photo	Please refer to the EUT Photo documents.

#### 5.1.3 Antenna Gain

The antenna peak gain of EUT is less than 6 dBi. Therefore, it is not necessary to reduce maximum peak output power limit.



## 5.2 Frequency Hopping Systems

### 5.2.1 Relevant Standards

FCC §15.247(a) (1) (i) (ii) (iii) (iv); FCC §15.247(g); FCC §15.247(h)

Describe how the hopping sequence is generated. Provide an example of the hopping sequence channels, to demonstrate that the sequence meets the requirement specified in the definition of an FHSS system. Per the definition in Section 2.1(c), the hop set shall appear as random in the near term, shall appear as evenly distributed in the long term, and sequential hops shall be randomly distributed in both direction and magnitude of change.

Describe how each individual EUT meets the requirement that each of its hopping channels is used equally on average (e.g., that each new transmission event begins on the next channel in the hopping sequence after the final channel used in the previous transmission event).

Describe how the associated receiver(s) complies with the requirement that the input bandwidth (either RF or IF) matches the bandwidth of the transmitted signal.

Describe how the associated receiver(s) has the ability to shift frequencies in synchronization with the transmitted signals.

For short burst systems, describe how the EUT complies with the requirement that it be designed to be capable of operating as a true frequency hopping system. Specifically, the device shall comply with the equal frequency use and pseudorandom hopping sequence requirement when transmitting in short bursts, and shall be designed to comply when presented with continuous data (or information) stream.

Describe how the EUT complies with the requirement that it not have the ability to be coordinated with other FHSS systems in an effort to avoid the simultaneous occupancy of individual hopping frequencies by multiple transmitters.

### 5.2.2 Description of the systems

1. According to the preset procedure of the whole network, all the stations in the automatic control network synchronously change the frequency multiple times within one second, and temporarily stay on each frequency hopping channel. Periodic synchronization signaling is sent from the primary station, instructing all slaves to simultaneously change the operating frequency, then the hopping sequence is generated.
2. The hop set shall appear as random in the near term, shall appear as evenly distributed in the long term, and sequential hops shall be randomly distributed in both direction and magnitude of change.

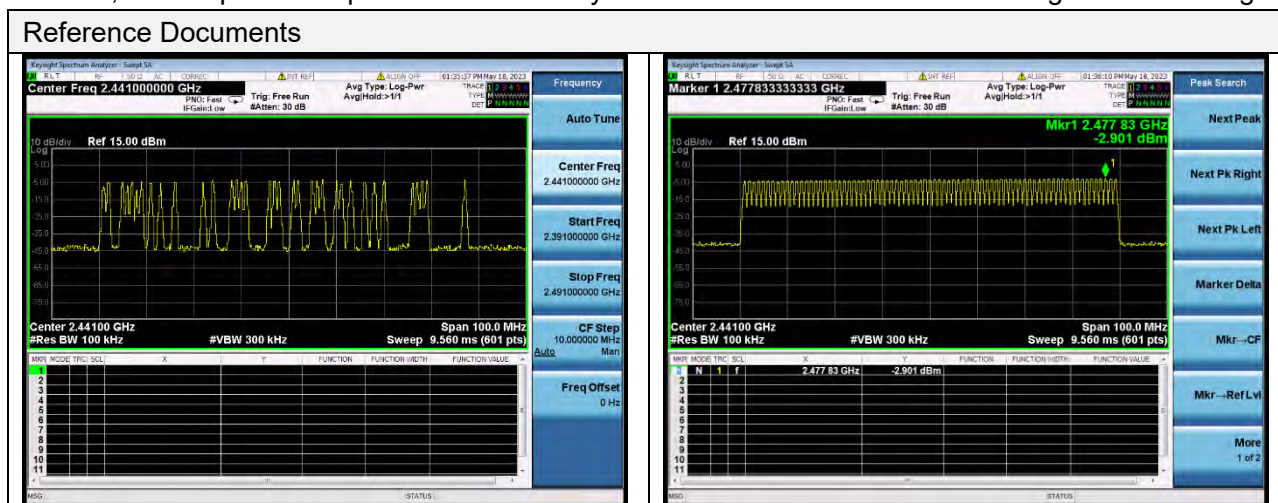

3. Channels are classified into two categories, used and unused, where used channels are part of the hopping sequence and unused channels are replaced in the hopping sequence by used channels in a pseudo-random way. Make each individual EUT meets the requirement that each of its hopping channels is used equally on average.
4. The input bandwidth and transmitted bandwidth are both 1MHz, the associated receiver(s) complies with the requirement that the input bandwidth matches the bandwidth of the transmitted signal.
5. Connected devices communicate on the same physical channel by synchronizing with a common clock and hopping sequence.
6. EUT isn't short burst systems.
7. EUT can't have the ability to be coordinated with other FHSS systems in an effort.



## 5.3 Number of Hopping Frequencies

### 5.3.1 Limit

FCC §15.247(a) (1) (iii)

Frequency hopping systems operating in the 2400 MHz to 2483.5 MHz bands shall use at least 15 hopping frequencies.

### 5.3.2 Test Setup

See section 4.5.1 for test setup description for the antenna port. The photo of test setup please refer to ANNEX B.

### 5.3.3 Test Procedure

The EUT must have its hopping function enabled. Use the following spectrum analyzer settings:

Span = The frequency band of operation

RBW = To identify clearly the individual channels, set the RBW to less than 30% of the channel spacing or the 20 dB bandwidth, whichever is smaller.

VBW  $\geq$  RBW

Sweep = auto

Detector function = peak

Trace = max hold

Allow the trace to stabilize

### 5.3.4 Test Result

Please refer to ANNEX A.1.

## 5.4 Peak Output Power

### 5.4.1 Test Limit

FCC § 15.247(b)

For frequency hopping systems operating in the 2400-2483.5 MHz band employing at least 75 non-overlapping hopping channels band: 1 watt. For all other frequency hopping systems in the 2400-2483.5 MHz band: 0.125 watts.

### 5.4.2 Test Setup

See section 4.5.1 for test setup description for the antenna port. The photo of test setup please refer to ANNEX B.

### 5.4.3 Test Procedure

The Module operates at hopping-off test mode. The lowest, middle and highest channels are selected to perform testing to verify the conducted RF output peak power of the Module.

Use the following spectrum analyzer settings:

Span = approximately 5 times the 20 dB bandwidth, centered on a hopping channel

RBW > the 20 dB bandwidth of the emission being measured

VBW  $\geq$  RBW

Sweep = auto

Detector function = peak

Trace = max hold

Allow the trace to stabilize.

### 5.4.4 Test Result

Please refer to ANNEX A.2.

## 5.5 Occupied Bandwidth

### 5.5.1 Limit

FCC §15.247(a)

Measurement of the 20dB bandwidth of the modulated signal.

### 5.5.2 Test Setup

See section 4.5.1 for test setup description for the antenna port. The photo of test setup please refer to ANNEX B.

### 5.5.3 Test Procedure

Use the following spectrum analyzer settings:

Span = approximately 2 to 5 times the 20 dB bandwidth, centered on a hopping channel

RBW = in the range of 1% to 5% of the OBW

VBW  $\geq$  RBW

Sweep = auto

Detector function = peak

Trace = max hold

The EUT should be transmitting at its maximum data rate, Allow the trace to stabilize.

### 5.5.4 Test Result

Please refer to ANNEX A.3.

## 5.6 Carrier Frequency Separation

### 5.6.1 Limit

FCC §15.247(a)

Frequency hopping systems shall have hopping channel carrier frequencies separated by a minimum of 25 kHz or the 2/3 of the 20 dB bandwidth of the hopping channel, whichever is greater.

### 5.6.2 Test Setup

See section 4.5.1 for test setup description for the antenna port. The photo of test setup please refer to ANNEX B.

### 5.6.3 Test Procedure

The EUT must have its hopping function enabled. Use the following spectrum analyzer settings:

Span = wide enough to capture the peaks of two adjacent channels

Resolution (or IF) Bandwidth (RBW)  $\geq$  1% of the span

Video (or Average) Bandwidth (VBW)  $\geq$  RBW

Sweep = auto

Detector function = peak

Trace = max hold

Allow the trace to stabilize. Use the marker-delta function to determine the separation between the peaks of the adjacent channels.

### 5.6.4 Test Result

Please refer to ANNEX A.4.

## 5.7 Time of Occupancy (Dwell time)

### 5.7.1 Limit

#### FCC §15.247(a)

Frequency hopping systems in the 2400 MHz - 2483.5 MHz band shall use at least 15 non-overlapping channels. The average time of occupancy on any channel shall not be greater than 0.4 seconds within a period of 0.4 seconds multiplied by the number of hopping channels employed. Frequency hopping systems may avoid or suppress transmissions on a particular hopping frequency provided that a minimum of 15 channels are used.

### 5.7.2 Test Setup

See section 4.5.1 for test setup description for the antenna port. The photo of test setup please refer to ANNEX B.

### 5.7.3 Test Procedure

The EUT shall have its hopping function enabled. Use the following spectrum analyzer settings:

Span: Zero span, centered on a hopping channel

RBW shall be  $\leq$  channel spacing and where possible RBW should be set  $\gg 1 / T$ , where T is the expected dwell time per channel

Sweep: As necessary to capture the entire dwell time per hopping channel; where possible use a video trigger and trigger delay so that the transmitted signal starts a little to the right of the start of the plot. The trigger level might need slight adjustment to prevent triggering when the system hops on an adjacent channel; a second plot might be needed with a longer sweep time to show two successive hops on a channel

Detector function: Peak

Trace: Max hold

Use the marker-delta function to determine the transmit time per hop. If this value varies with different modes of operation (data rate, modulation format, number of hopping channels, etc.), then repeat this test for each variation in transmit time.

The average time of occupancy on any channel within the Period can be calculated with formulas:

For GFSK and 8-DPSK:

For DH1 package type

$$\{\text{Total of Dwell}\} = \{\text{Pulse Time}\} * (1600 / 2) / \{\text{Number of Hopping Frequency}\} * \{\text{Period}\}$$

$$\{\text{Period}\} = 0.4 \text{ s} * \{\text{Number of Hopping Frequency}\}$$

For DH3 package type

$$\{\text{Total of Dwell}\} = \{\text{Pulse Time}\} * (1600 / 4) / \{\text{Number of Hopping Frequency}\} * \{\text{Period}\}$$

$$\{\text{Period}\} = 0.4 \text{ s} * \{\text{Number of Hopping Frequency}\}$$

For DH5 package type

$$\{\text{Total of Dwell}\} = \{\text{Pulse Time}\} * (1600 / 6) / \{\text{Number of Hopping Frequency}\} * \{\text{Period}\}$$

$$\{\text{Period}\} = 0.4 \text{ s} * \{\text{Number of Hopping Frequency}\}$$

For AFH Mode:

For DH1 package type

$$\{\text{Total of Dwell}\} = \{\text{Pulse Time}\} * (800 / 2) / \{\text{Number of Hopping Frequency}\} * \{\text{Period}\}$$

{Period} = 0.4 s \* {Number of Hopping Frequency}

For DH3 package type

{Total of Dwell} = {Pulse Time} \* (800 / 4) / {Number of Hopping Frequency} \* {Period}

{Period} = 0.4 s \* {Number of Hopping Frequency}

For DH5 package type

{Total of Dwell} = {Pulse Time} \* (800 / 6) / {Number of Hopping Frequency} \* {Period}

{Period} = 0.4 s \* {Number of Hopping Frequency}

The lowest, middle and highest channels are selected to perform testing to record the dwell time of each occupation measured in this channel, which is called Pulse Time here.

#### 5.7.4 Test Result

Please refer to ANNEX A.5.

## 5.8 Conducted Spurious Emission & Authorized-band band-edge

### 5.8.1 Limit

#### FCC §15.247(d)

In any 100 kHz bandwidth outside the frequency band in which the spread spectrum or digitally modulated intentional radiator is operating, the radio frequency power that is produced by the intentional radiator shall be at least 20 dB below that in the 100 kHz bandwidth within the band that contains the highest level of the desired power, based on either an RF conducted or a radiated measurement.

### 5.8.2 Test Setup

See section 4.5.1 for test setup description for the antenna port. The photo of test setup please refer to ANNEX B.

### 5.8.3 Test Procedure

Use the following spectrum analyzer settings:

Span = wide enough to capture the peak level of the in-band emission and all spurious emissions (e.g., harmonics) from the lowest frequency generated in the EUT up through the 10th harmonic. Typically, several plots are required to cover this entire span.

RBW = 100 kHz

VBW = 300 kHz

Sweep = auto

Detector function = peak

Trace = max hold

Allow the trace to stabilize

### 5.8.4 Test Result

Please refer to ANNEX A.6.

## 5.9 Conducted Emission

### 5.9.1 Limit

FCC §15.207

For an intentional radiator that is designed to be connected to the public utility (AC) power line, the radio frequency voltage that is conducted back onto the AC power line on any frequency within the band 150 kHz to 30 MHz shall not exceed the limits in the following table, as measured using a 50 $\mu$ H/50 $\Omega$  line impedance stabilization network (LISN).

Frequency range (MHz)	Conducted Limit (dB $\mu$ V)	
	Quai-peak	Average
0.15 - 0.50	66 to 56	56 to 46
0.50 - 5	56	46
0.50 - 30	60	50

### 5.9.2 Test Setup

See section 4.5.2 for test setup description for the AC power supply port. The photo of test setup please refer to ANNEX B.

### 5.9.3 Test Procedure

The maximum conducted interference is searched using Peak (PK), if the emission levels more than the AV and QP limits, and that have narrow margins from the AV and QP limits will be re-measured with AV and QP detectors. Tests for both L phase and N phase lines of the power mains connected to the EUT are performed. Refer to recorded points and plots below.

Devices subject to Part 15 must be tested for all available U.S. voltages and frequencies (such as a nominal 120 VAC, 50/60 Hz and 240 VAC, 50/60 Hz) for which the device is capable of operation. A device rated for 50/60 Hz operation need not be tested at both frequencies provided the radiated and line conducted emissions are the same at both frequencies.

### 5.9.4 Test Result

Please refer to ANNEX A.7.



## 5.10 Radiated Spurious Emission

### 5.10.1 Limit

FCC §15.209&15.247(d)

Radiated emission outside the frequency band attenuation below the general limits specified in FCC section 15.209(a) is not required. In addition, radiated emissions which fall in the restricted bands, as defined in FCC section 15.205(a), must also comply with the radiated emission limits specified in FCC section 15.209(a).

According to FCC section 15.209 (a), except as provided elsewhere in this subpart, the emissions from an intentional radiator shall not exceed the field strength levels specified in the following table:

Frequency (MHz)	Field Strength ( $\mu\text{V}/\text{m}$ )	Measurement Distance (m)
0.009 - 0.490	2400/F(kHz)	300
0.490 - 1.705	24000/F(kHz)	30
1.705 - 30.0	30	30
30 - 88	100	3
88 - 216	150	3
216 - 960	200	3
Above 960	500	3

Note:

1. Field Strength (dB $\mu\text{V}/\text{m}$ ) = 20\*log[Field Strength ( $\mu\text{V}/\text{m}$ )].
2. In the emission tables above, the tighter limit applies at the band edges.
3. For Above 1000 MHz, the emission limit in this paragraph is based on measurement instrumentation employing an average detector, measurement using instrumentation with a peak detector function, corresponding to 20dB above the maximum permitted average limit.
4. For above 1000 MHz, limit field strength of harmonics: 54dBuV/m@3m (AV) and 74dBuV/m@3m (PK).

### 5.10.2 Test Setup

See section 4.5.3 to 4.5.5 for test setup description for the antenna port. The photo of test setup please refer to ANNEX B.

### 5.10.3 Test Procedure

The measurement frequency range is from 9 kHz to the 10th harmonic of the fundamental frequency. The Turn Table is actuated to turn from 0° to 360°, and both horizontal and vertical polarizations of the Test Antenna are used to find the maximum radiated power. Mid channels on all channel bandwidth verified. Only the worst RB size/offset presented.

The power of the EUT transmitting frequency should be ignored.

All Spurious Emission tests were performed in X, Y, Z axis direction. And only the worst axis test condition was recorded in this test report.

Use the following spectrum analyzer settings:

Span = wide enough to fully capture the emission being measured

RBW = 1 MHz for  $f \geq 1$  GHz, 100 kHz for  $f < 1$  GHz

VBW  $\geq$  RBW

Sweep = auto

Detector function = peak

Trace = max hold

For measurement below 1GHz, If the emission level of the EUT measured by the peak detector is 3 dB lower than the applicable limit, the peak emission level will be reported, Otherwise, the emission measurement will be repeated using the quasi-peak detector and reported.

#### 5.10.4 Test Result

Please refer to ANNEX A.8.

## 5.11 Band Edge (Restricted-band band-edge)

### 5.11.1 Limit

FCC §15.209&15.247(d)

Radiated emission outside the frequency band attenuation below the general limits specified in FCC section 15.209(a) is not required. In addition, radiated emissions which fall in the restricted bands, as defined in FCC section 15.205(a), must also comply with the radiated emission limits specified in FCC section 15.209(a).

### 5.11.2 Test Setup

See section 4.5.3 to 4.5.5 for test setup description for the antenna port. The photo of test setup please refer to ANNEX B.

### 5.11.3 Test Procedure

The measurement frequency range is from 9 kHz to the 10th harmonic of the fundamental frequency. The Turn Table is actuated to turn from 0° to 360°, and both horizontal and vertical polarizations of the Test Antenna are used to find the maximum radiated power. Mid channels on all channel bandwidth verified. Only the worst RB size/offset presented.

The power of the EUT transmitting frequency should be ignored.

All Spurious Emission tests were performed in X, Y, Z axis direction. And only the worst axis test condition was recorded in this test report.

Use the following spectrum analyzer settings:

Span = wide enough to fully capture the emission being measured

RBW = 1 MHz for  $f \geq 1$  GHz, 100 kHz for  $f < 1$  GHz

VBW  $\geq$  RBW

Sweep = auto

Detector function = peak

Trace = max hold

For measurement below 1GHz, If the emission level of the EUT measured by the peak detector is 3 dB lower than the applicable limit, the peak emission level will be reported, Otherwise, the emission measurement will be repeated using the quasi-peak detector and reported.

### 5.11.4 Test Result

Please refer to ANNEX A.9.

# ANNEX A TEST RESULT

## A.1 Number of Hopping Frequency

### Test Data

Test Mode	Frequency Block (MHz)	Measured Channel Numbers	Min. Limit	Verdict
GFSK	2400 - 2483.5	79	15	Pass
$\pi/4$ -DQPSK	2400 - 2483.5	79	15	Pass

### Test Plots

GFSK 2.4 GHz ~ 2.4415 GHz

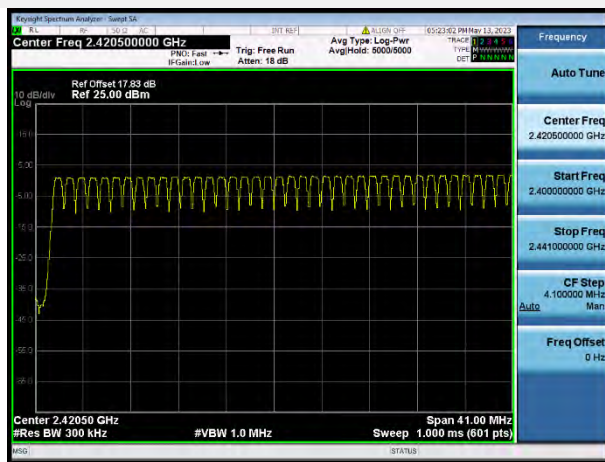

GFSK 2.4415 GHz ~ 2.4835 GHz

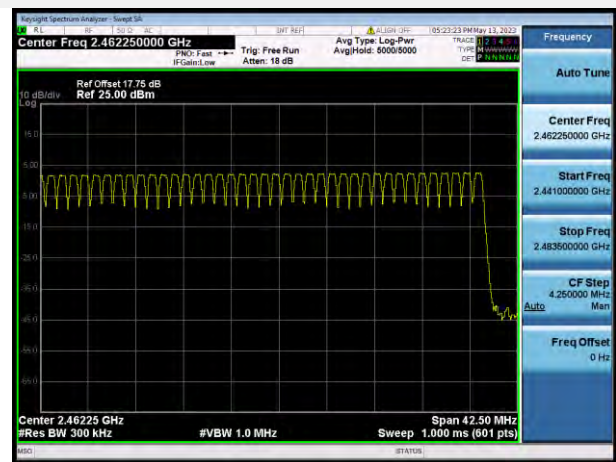

$\pi/4$ -DQPSK 2.4 GHz ~ 2.4415 GHz

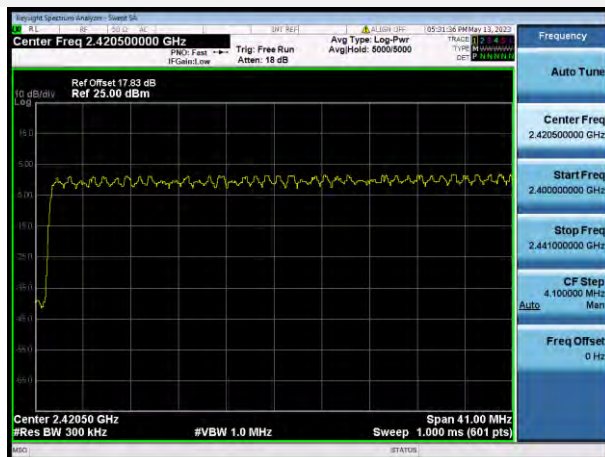

$\pi/4$ -DQPSK 2.4415 GHz ~ 2.4835 GHz

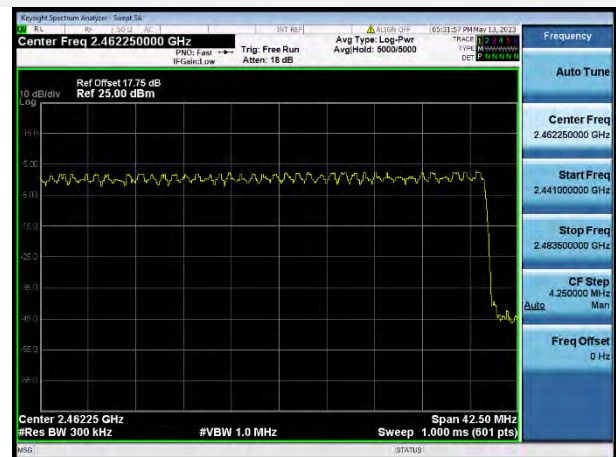

## A.2 Peak Output Power

### Peak Power Test Data

Channel	Measured Output Peak Power				Limit		Verdict
	GFSK		$\pi/4$ -DQPSK		dBm	mW	
	dBm	mW	dBm	mW			
Low	-3.59	0.44	-2.96	0.51	21	125	Pass
Middle	-2.79	0.53	-2.00	0.63			Pass
High	-2.28	0.59	-1.51	0.71			Pass

Test Plots

GFSK LOW CHANNEL

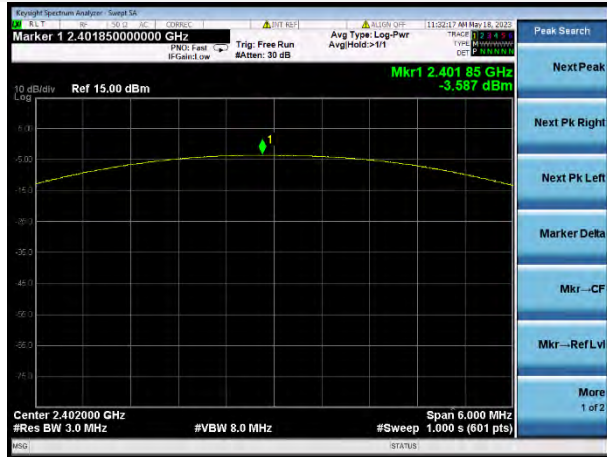

GFSK MIDDLE CHANNEL

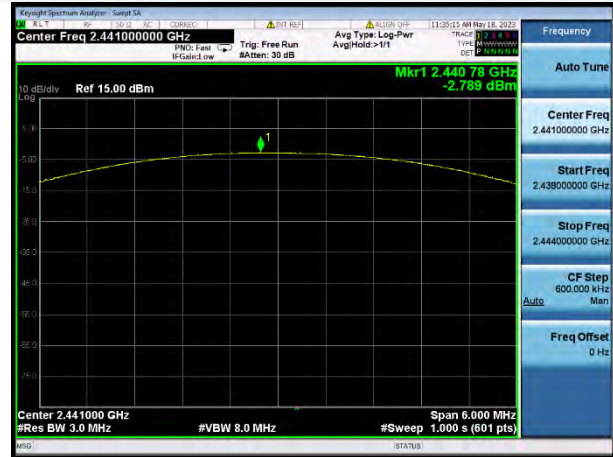

GFSK HIGH CHANNEL

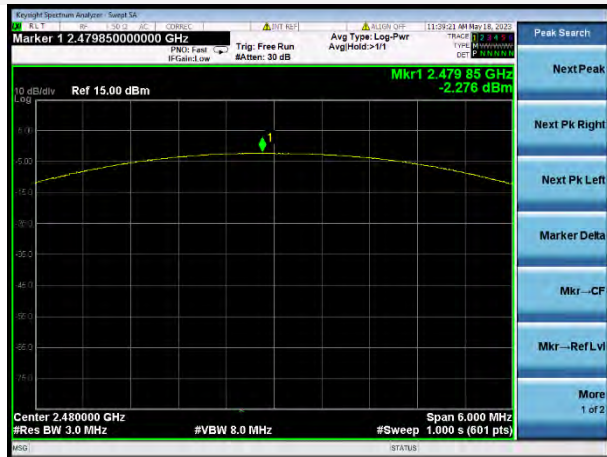

$\pi/4$ -DQPSK LOW CHANNEL

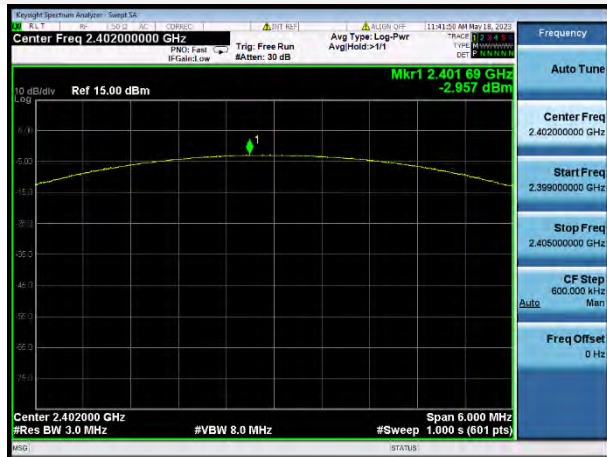

$\pi/4$ -DQPSK MIDDLE CHANNEL

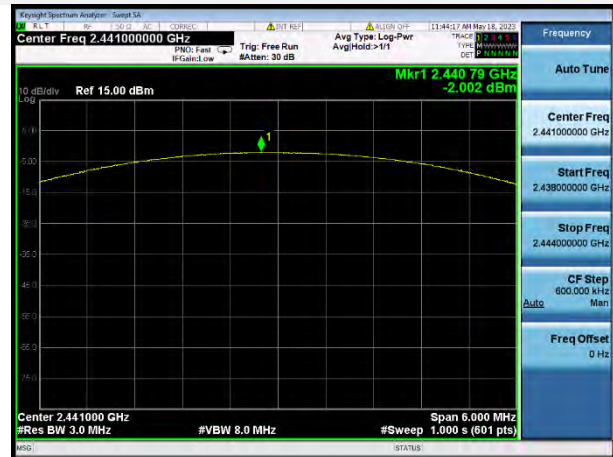

### $\pi/4$ -DQPSK HIGH CHANNEL



### A.3 20 dB and 99% bandwidth

#### Test Data

GFSK		
Channel	20 dB Bandwidth (MHz)	99% Bandwidth (MHz)
Low	0.960000	0.858620
Middle	0.950000	0.858440
High	0.960000	0.860390
$\pi/4$ -DQPSK		
Channel	20 dB Bandwidth (MHz)	99% Bandwidth (MHz)
Low	1.290000	1.170400
Middle	1.285000	1.171700
High	1.285000	1.171300



Test Plots

20 dB Bandwidth

GFSK LOW CHANNEL



GFSK MIDDLE CHANNEL



GFSK HIGH CHANNEL



$\pi/4$ -DQPSK LOW CHANNEL



$\pi/4$ -DQPSK MIDDLE CHANNEL



**π/4-DQPSK HIGH CHANNEL**



**99% Bandwidth**

**GFSK LOW CHANNEL**

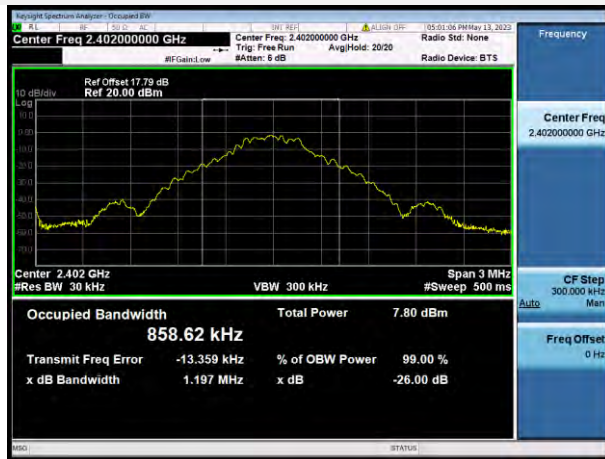

**GFSK MIDDLE CHANNEL**

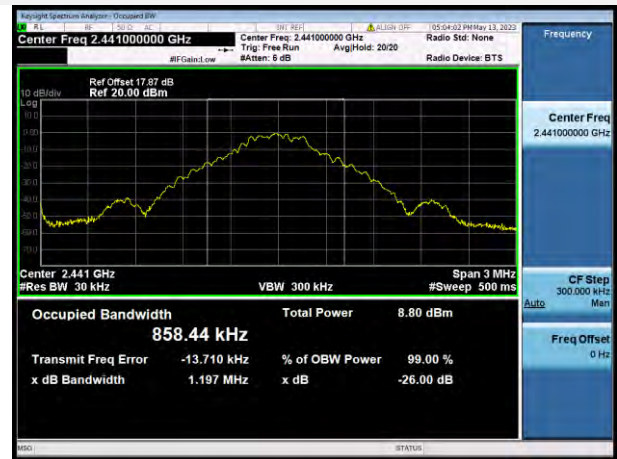

**GFSK HIGH CHANNEL**



**π/4-DQPSK LOW CHANNEL**



**π/4-DQPSK MIDDLE CHANNEL**

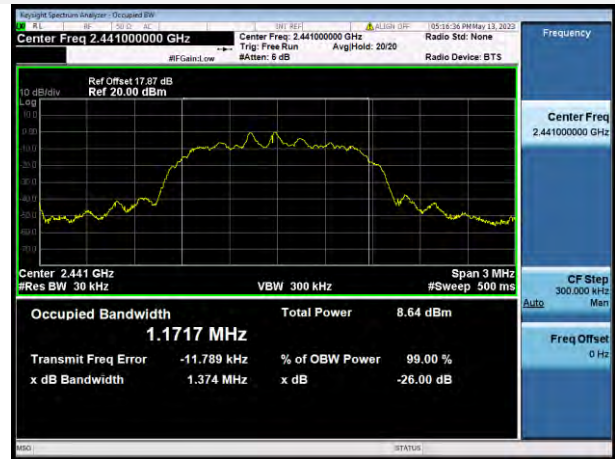

**π/4-DQPSK HIGH CHANNEL**

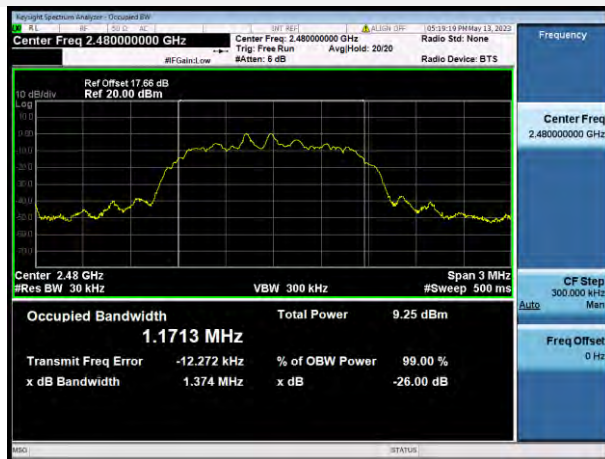



## A.4 Hopping Frequency Separation

### Test Data

Mode	Frequency separation (MHz)	2/3 of the 20 dB Bandwidth (MHz)	Verdict
GFSK	1.000	0.640	Pass
$\pi/4$ -DQPSK	1.000	0.860	Pass

### Test Plots

#### GFSK

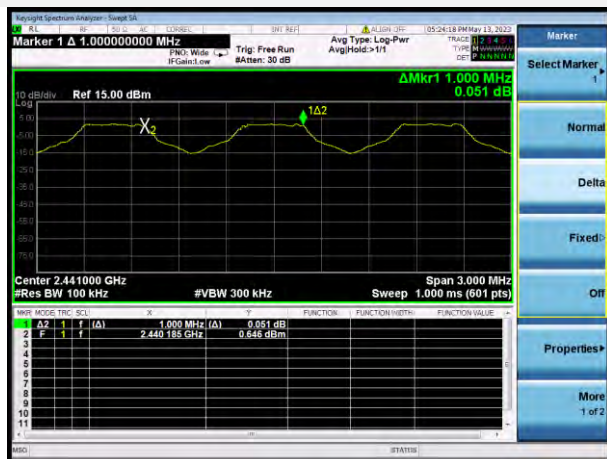

#### $\pi/4$ -DQPSK

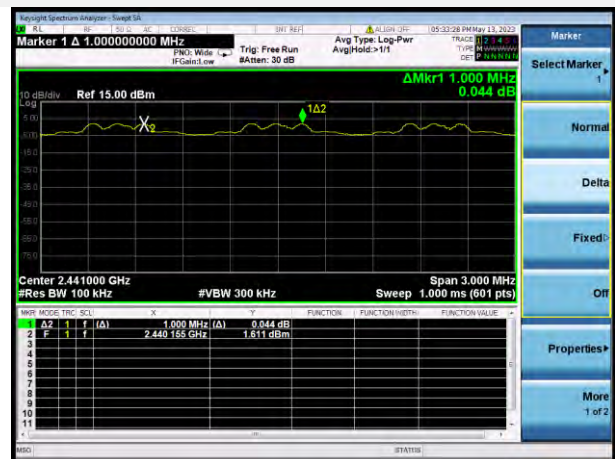

## A.5 Average Time of Occupancy

### Test Data

GFSK				
DH Packet	Pulse Width (ms)	Total of Dwell (ms)	Limit (sec)	Verdict
DH 1	0.38080	121.856	0.4	Pass
DH 3	1.64100	262.560	0.4	Pass
DH 5	2.88800	308.053	0.4	Pass
$\pi/4$ -DQPSK				
DH Packet	Pulse Width (ms)	Total of Dwell (ms)	Limit (sec)	Verdict
DH 1	0.39040	124.928	0.4	Pass
DH 3	1.64100	262.560	0.4	Pass
DH 5	2.88800	308.053	0.4	Pass
AFH Mode				
DH Packet	Pulse Width (ms)	Total of Dwell (ms)	Limit (sec)	Verdict
DH 1	0.38080	60.928	0.4	Pass
DH 3	1.63400	130.720	0.4	Pass
DH 5	2.88800	154.027	0.4	Pass

Test Plots

GFSK DH1

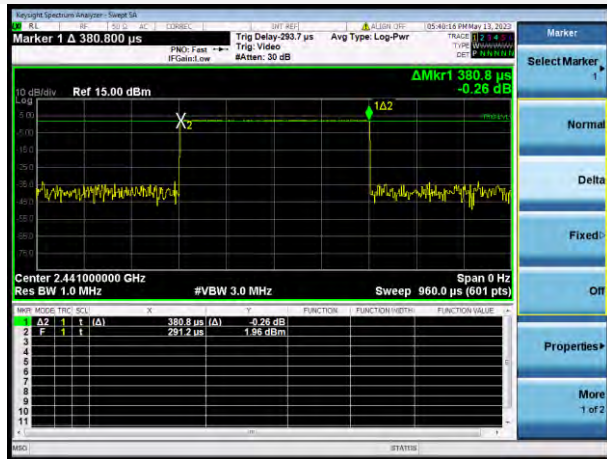

GFSK DH3

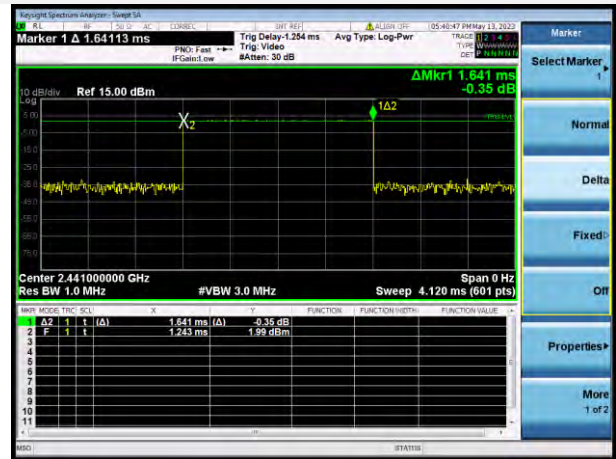

GFSK DH5

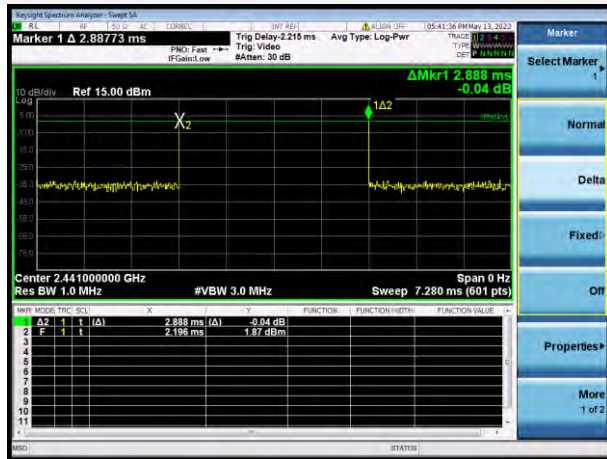

$\pi$ /4-DQPSK DH1

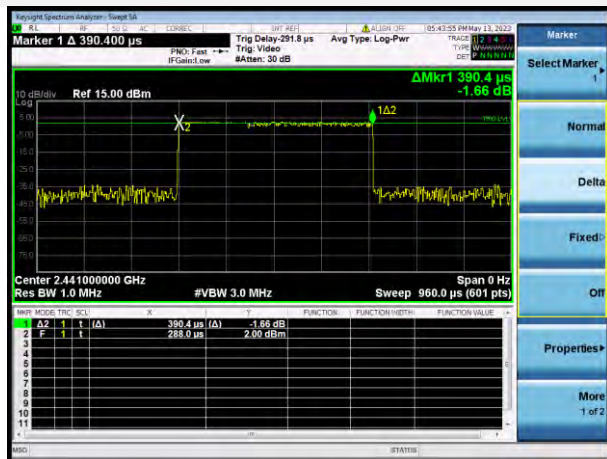

$\pi$ /4-DQPSK DH3

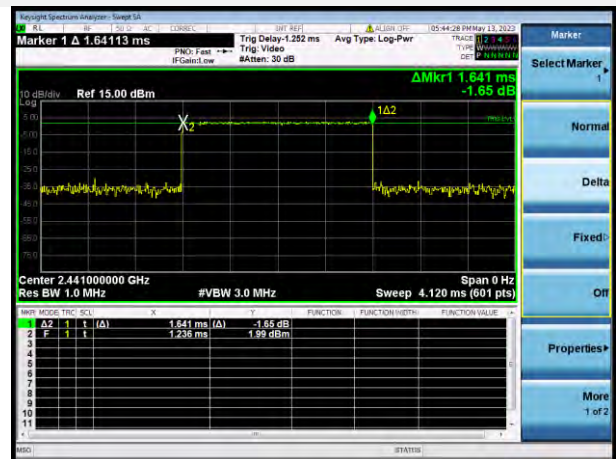

$\pi/4$ -DQPSK DH5

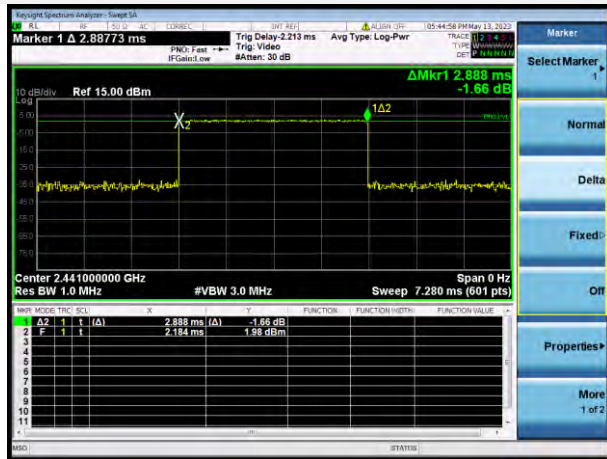

AFH Mode DH1

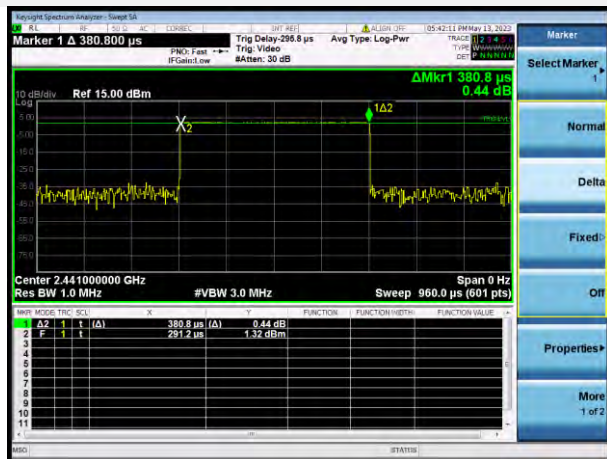

AFH Mode DH3

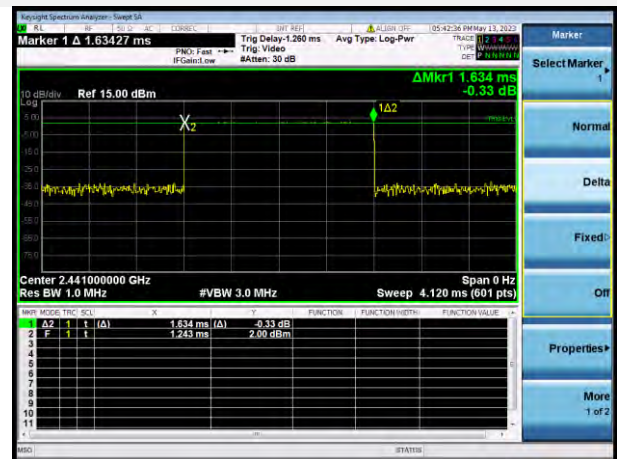

AFH Mode DH5

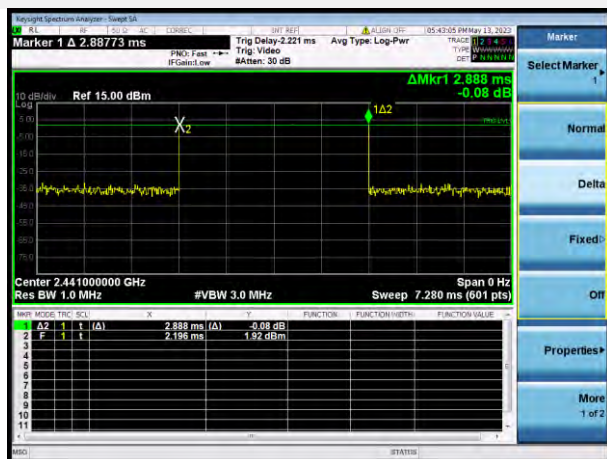

## A.6 Conducted Spurious Emissions & Authorized-band band-edge

### Test Data

GFSK				
Channel	Measured Max. Out of Band Emission (dBm)	Limit (dBm)		Verdict
		Carrier Level	Calculated 20 dBc Limit	
Low	-30.02	-4.36	-24.36	Pass
Middle	-28.78	-3.46	-23.46	Pass
High	-29.84	-2.93	-22.93	Pass
$\pi/4$ -DQPSK				
Channel	Measured Max. Out of Band Emission (dBm)	Limit (dBm)		Verdict
		Carrier Level	Calculated 20 dBc Limit	
Low	-29.54	-4.26	-24.26	Pass
Middle	-30.05	-3.37	-23.37	Pass
High	-30.15	-2.79	-22.79	Pass
Hopping Mode				
Mode	Measured Max. Out of Band Emission (dBm)	Limit (dBm)		Verdict
		Carrier Level	Calculated 20 dBc Limit	
GFSK	-28.05	-2.90	-22.90	Pass
$\pi/4$ -DQPSK	-30.58	-2.93	-22.93	Pass



Test Plots

GFSK LOW CHANNEL, CARRIER LEVEL

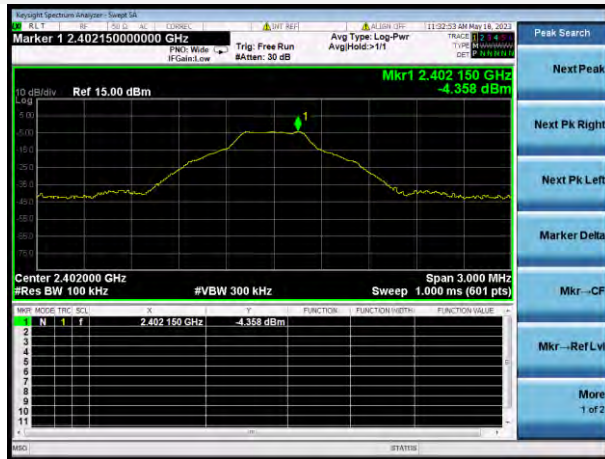

GFSK LOW CHANNEL, BAND EDGE



GFSK LOW CHANNEL, SPURIOUS

30 MHz ~ 3 GHz

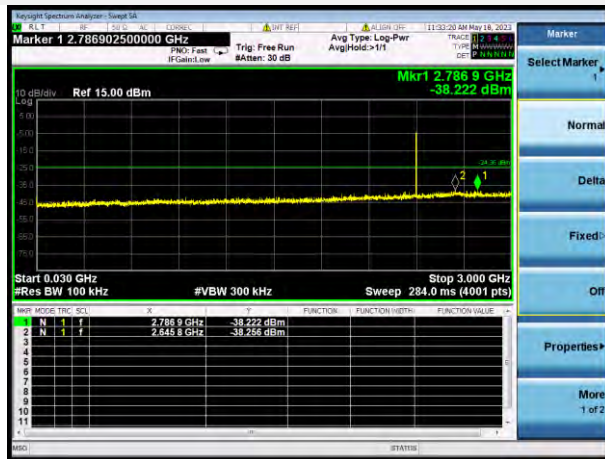

GFSK LOW CHANNEL, SPURIOUS

3 GHz ~ 25 GHz

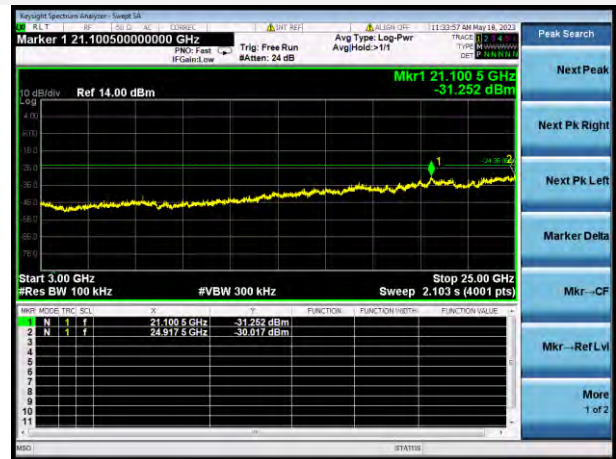

GFSK MIDDLE CHANNEL, CARRIER LEVEL



GFSK MIDDLE CHANNEL, SPURIOUS  
30 MHz ~ 3 GHz

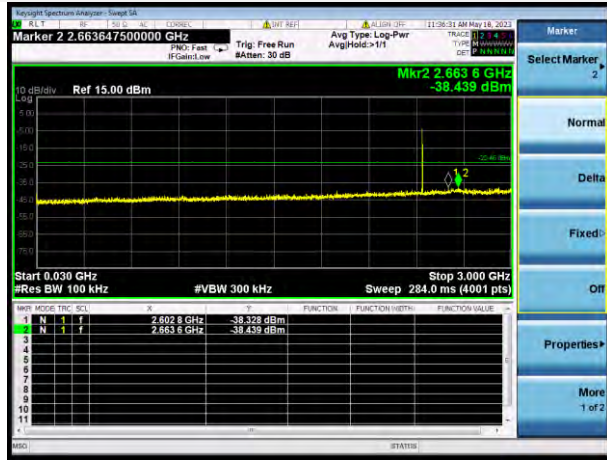

GFSK MIDDLE CHANNEL, SPURIOUS  
3 GHz ~ 25 GHz

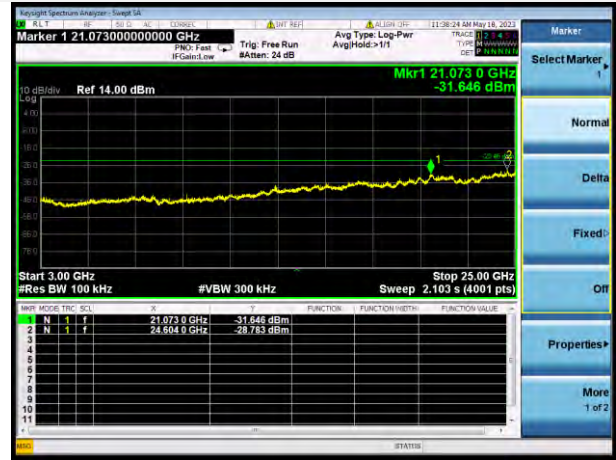

GFSK HIGH CHANNEL, CARRIER LEVEL



GFSK HIGH CHANNEL, BAND EDGE



GFSK HIGH CHANNEL, SPURIOUS  
30 MHz ~ 3 GHz



GFSK HIGH CHANNEL, SPURIOUS  
3 GHz ~ 25 GHz

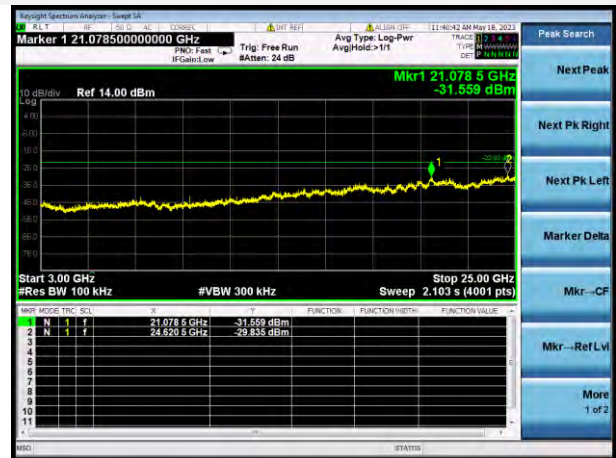



$\pi/4$ -DQPSK LOW CHANNEL, CARRIER LEVEL

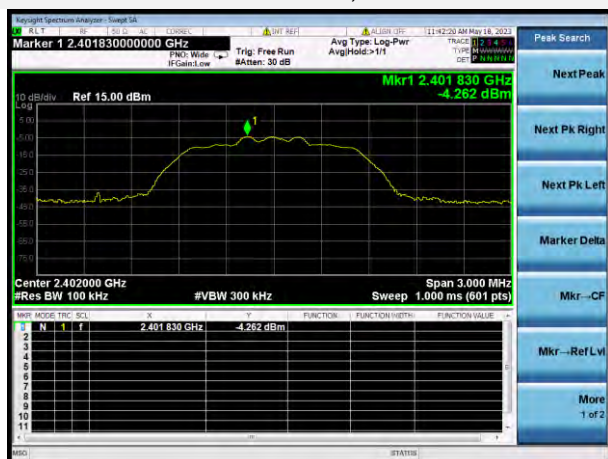

$\pi/4$ -DQPSK LOW CHANNEL, BAND EDGE

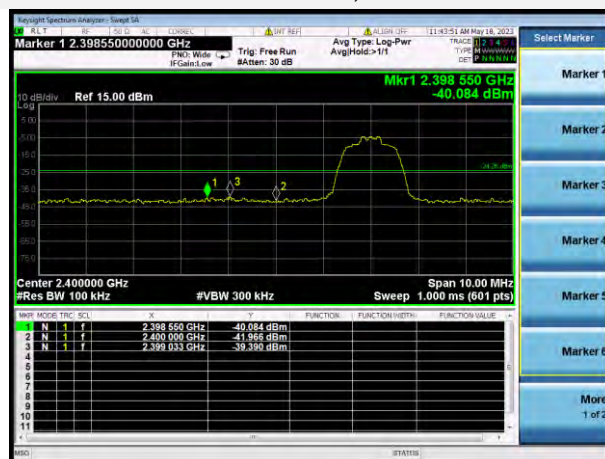

$\pi/4$ -DQPSK LOW CHANNEL, SPURIOUS  
30 MHz ~ 3 GHz

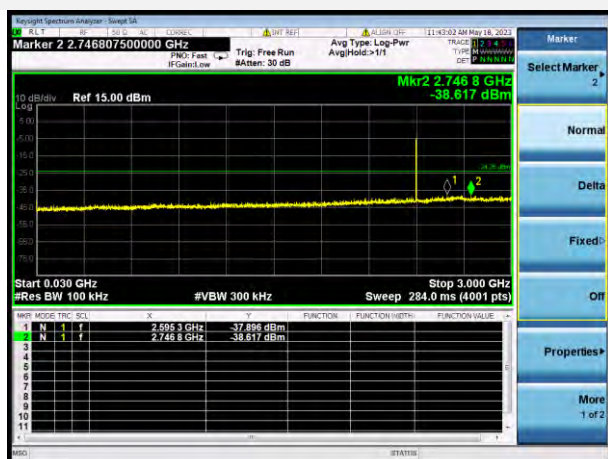

$\pi/4$ -DQPSK LOW CHANNEL, SPURIOUS  
3 GHz ~ 25 GHz

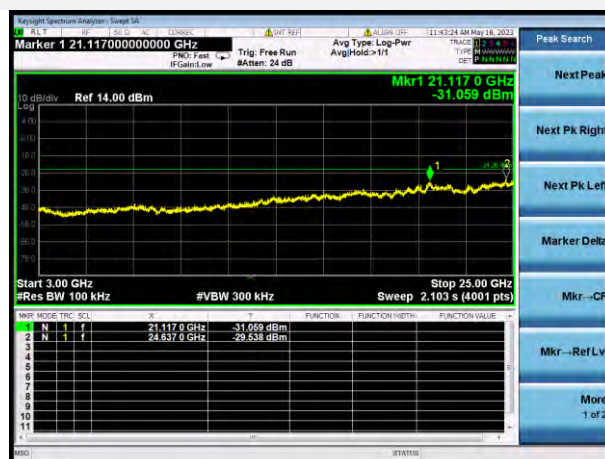

$\pi/4$ -DQPSK MIDDLE CHANNEL, CARRIER LEVEL

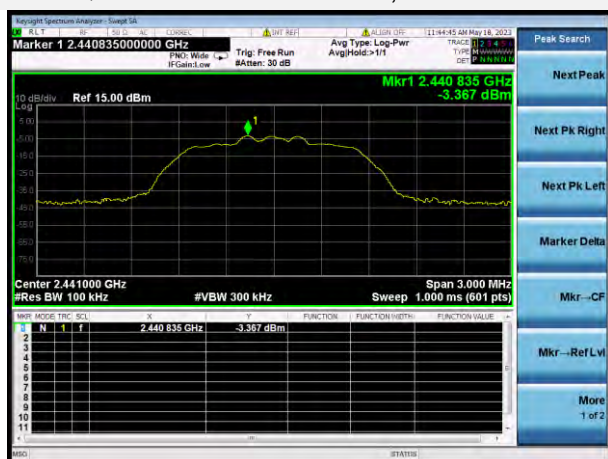

$\pi/4$ -DQPSK MIDDLE CHANNEL, SPURIOUS  
30 MHz ~ 3 GHz

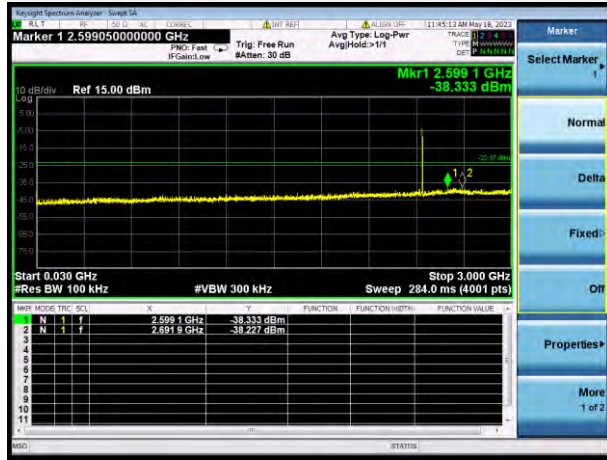

$\pi/4$ -DQPSK MIDDLE CHANNEL, SPURIOUS  
3 GHz ~ 25 GHz

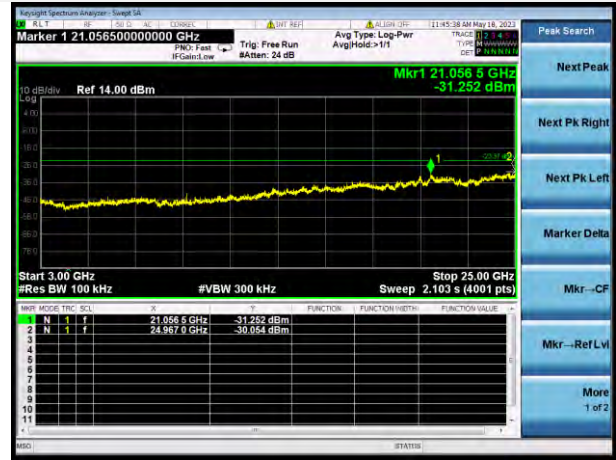

$\pi/4$ -DQPSK HIGH CHANNEL, CARRIER LEVEL

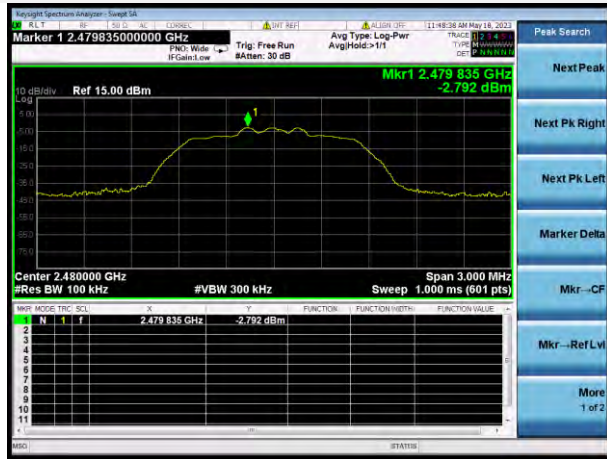

$\pi/4$ -DQPSK HIGH CHANNEL, BAND EDGE

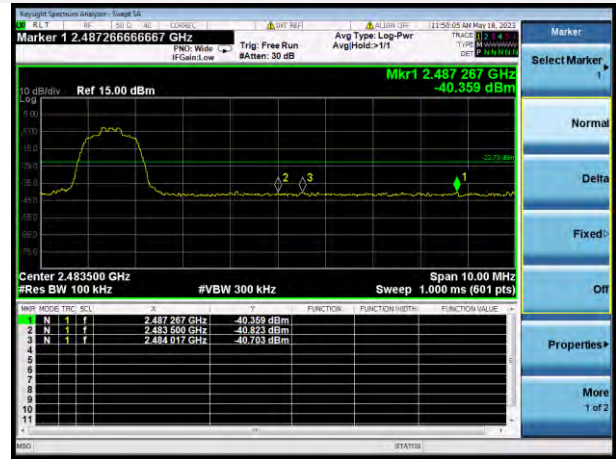

$\pi/4$ -DQPSK HIGH CHANNEL, SPURIOUS  
30 MHz ~ 3 GHz

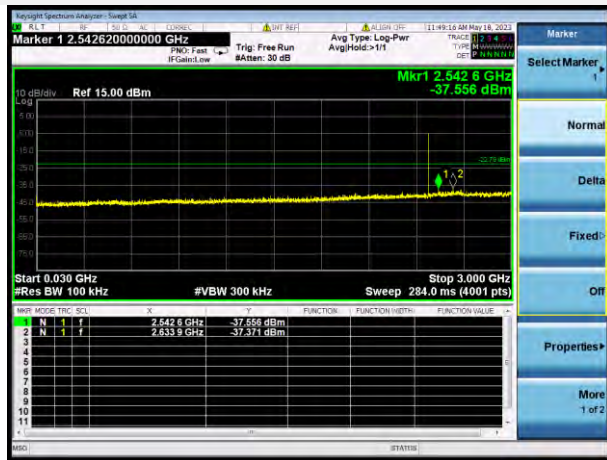

$\pi/4$ -DQPSK HIGH CHANNEL, SPURIOUS  
3 GHz ~ 25 GHz

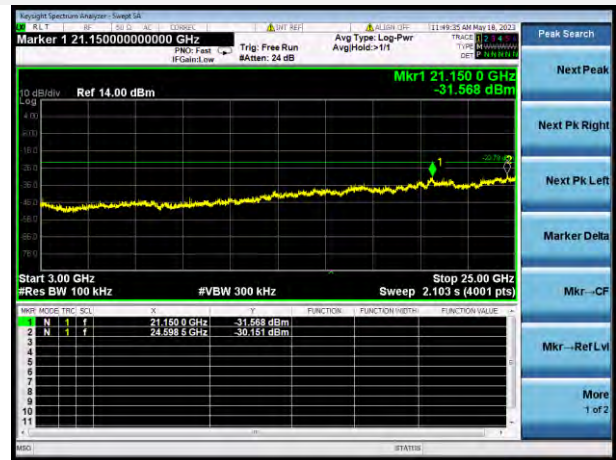



### GFSK HOPPING, CARRIER LEVEL

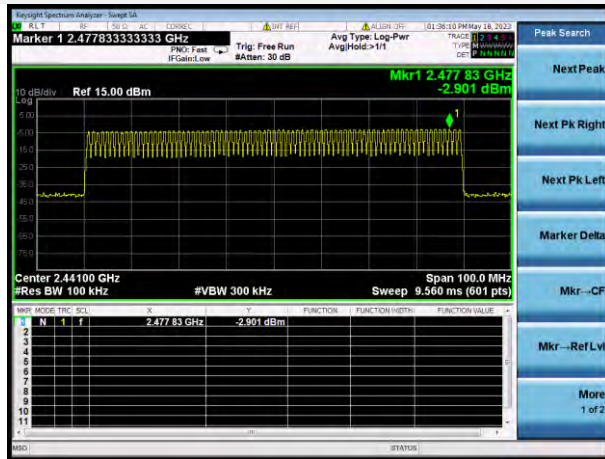

### GFSK HOPPING BAND EDGE (LOW)

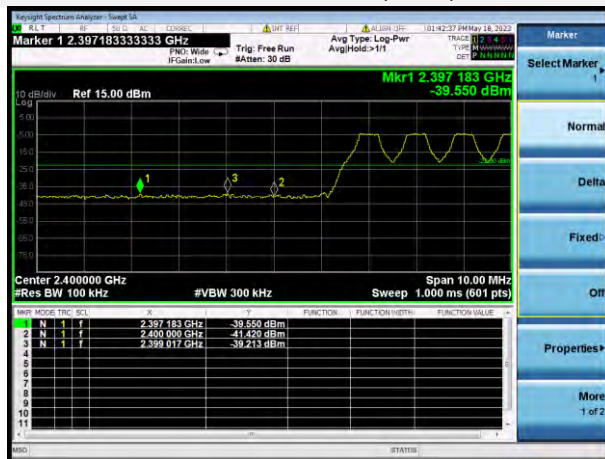

### GFSK HOPPING BAND EDGE (HIGH)

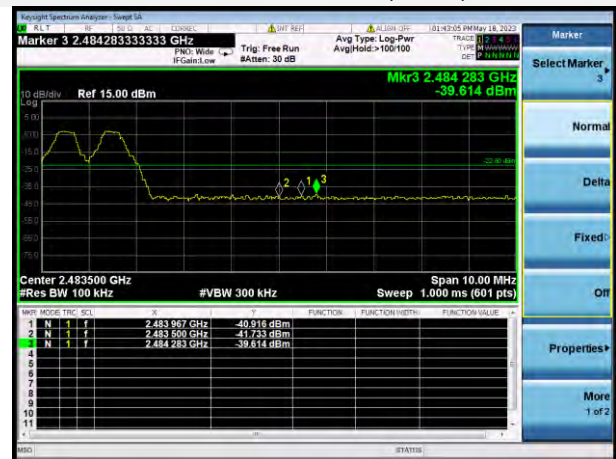

### GFSK Hopping Mode, SPURIOUS 30 MHz ~ 3 GHz

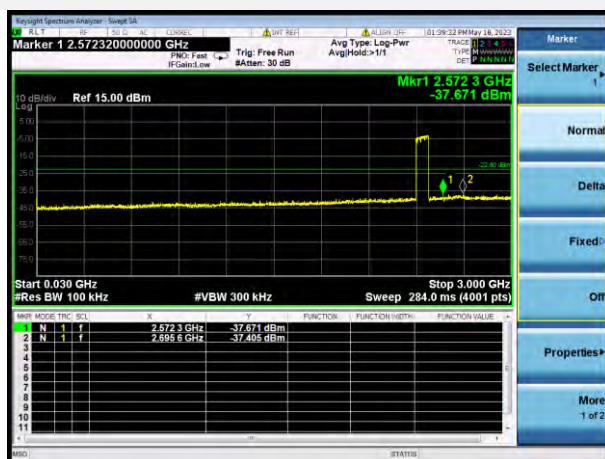

### GFSK Hopping Mode, SPURIOUS 3GHz ~ 25 GHz



$\pi/4$ -DQPSK HOPPING, CARRIER LEVEL

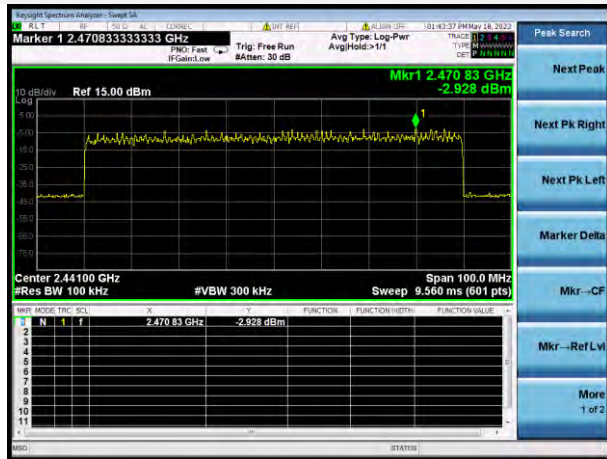

$\pi/4$ -DQPSK Hopping BAND EDGE (LOW)



$\pi/4$ -DQPSK Hopping BAND EDGE (HIGH)



$\pi/4$ -DQPSK Hopping Mode, SPURIOUS  
30 MHz ~ 3 GHz

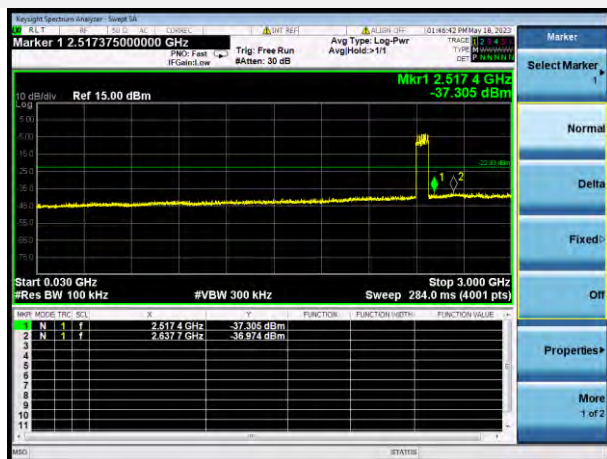

$\pi/4$ -DQPSK Hopping Mode, SPURIOUS  
3GHz ~ 25 GHz

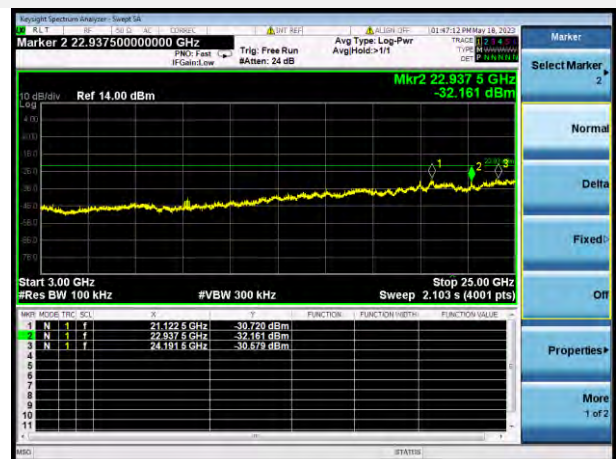

## A.7 Conducted Emissions

Note <sup>1</sup>: The EUT is working in the Normal link mode. All modes have been tested and normal link mode is worst.

Note <sup>2</sup>: Devices subject to Part 15 must be tested for all available U.S. voltages and frequencies (such as a nominal 120 VAC, 60 Hz and 240 VAC, 50 Hz) for which the device is capable of operation. So, The configuration 120 VAC, 60 Hz and 240 VAC, 50 Hz were tested respectively, but only the worst configuration (120 VAC, 60 Hz) shown here.

Note <sup>3</sup>: Results (dBuV) = Original reading level of Spectrum Analyzer (dBuV) + Factor (dB)

### Test Data and Plots

#### PHASE L

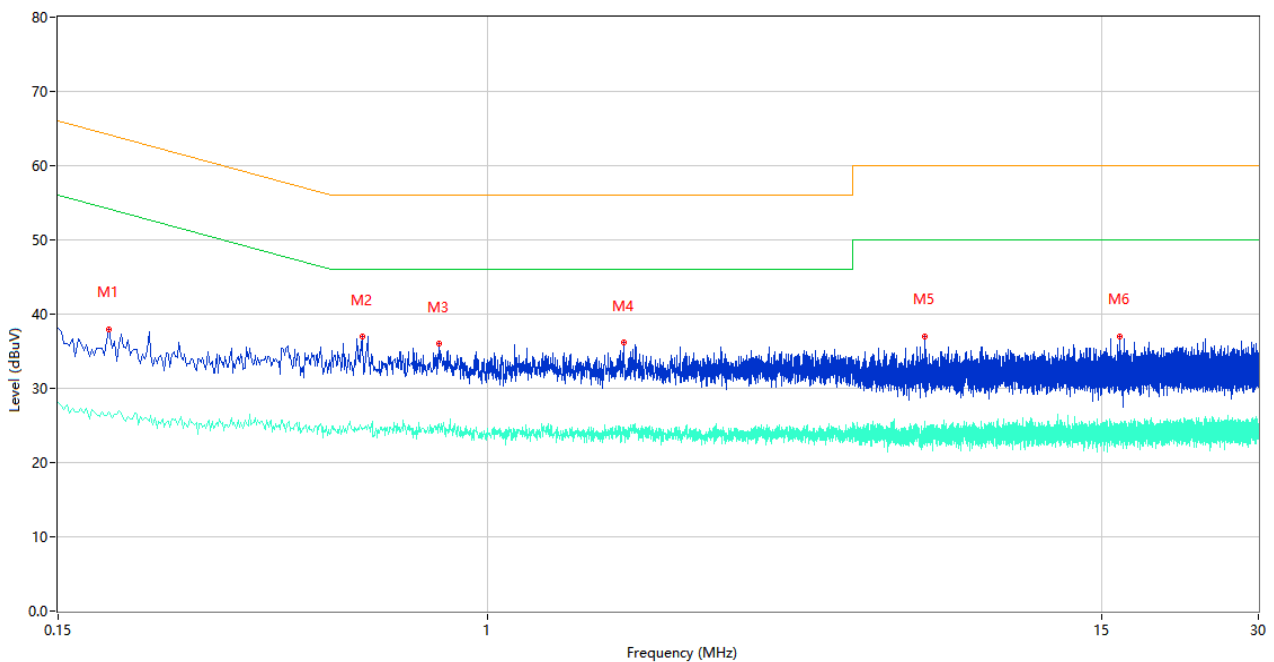

No.	Frequency (MHz)	Results (dBuV)	Factor (dB)	Limit (dBuV)	Margin (dB)	Detector	Line	Verdict
1	0.188	37.97	10.06	64.12	26.15	Peak	L	Pass
1**	0.188	26.89	10.06	54.12	27.23	AV	L	Pass
2	0.576	36.98	10.28	56.00	19.02	Peak	L	Pass
2**	0.576	24.57	10.28	46.00	21.43	AV	L	Pass
3	0.806	36.02	10.68	56.00	19.98	Peak	L	Pass
3**	0.806	25.18	10.68	46.00	20.82	AV	L	Pass
4	1.824	36.19	10.23	56.00	19.81	Peak	L	Pass
4**	1.824	23.62	10.23	46.00	22.38	AV	L	Pass
5	6.872	37.05	10.35	60.00	22.95	Peak	L	Pass
5**	6.872	24.28	10.35	50.00	25.72	AV	L	Pass
6	16.286	37.06	10.36	60.00	22.94	Peak	L	Pass
6**	16.286	25.20	10.36	50.00	24.80	AV	L	Pass

PHASE N

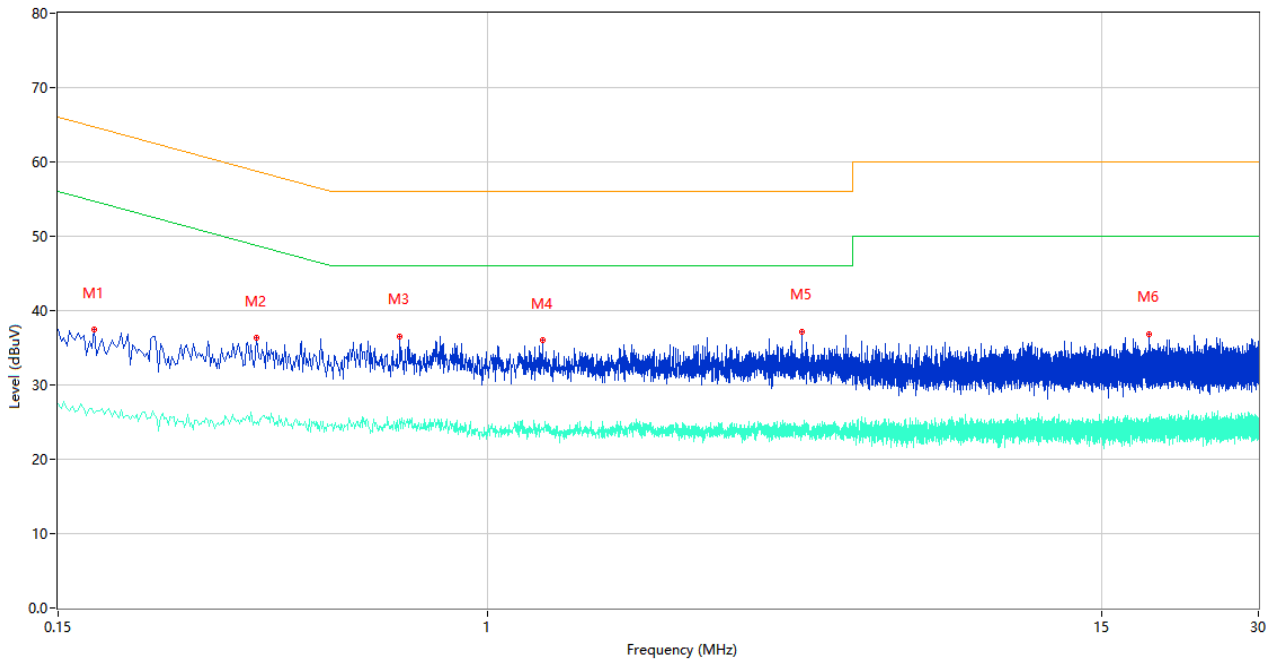

No.	Frequency (MHz)	Results (dBuV)	Factor (dB)	Limit (dBuV)	Margin (dB)	Detector	Line	Verdict
1	0.176	37.41	10.07	64.67	27.26	Peak	N	Pass
1**	0.176	26.12	10.07	54.67	28.55	AV	N	Pass
2	0.360	36.33	10.93	58.73	22.40	Peak	N	Pass
2**	0.360	24.74	10.93	48.73	23.99	AV	N	Pass
3	0.678	36.55	10.63	56.00	19.45	Peak	N	Pass
3**	0.678	24.94	10.63	46.00	21.06	AV	N	Pass
4	1.272	36.01	10.58	56.00	19.99	Peak	N	Pass
4**	1.272	24.01	10.58	46.00	21.99	AV	N	Pass
5	4.006	37.18	10.08	56.00	18.82	Peak	N	Pass
5**	4.006	24.39	10.08	46.00	21.61	AV	N	Pass
6	18.556	36.84	10.39	60.00	23.16	Peak	N	Pass
6**	18.556	25.72	10.39	50.00	24.28	AV	N	Pass



## A.8 Radiated Spurious Emission

Note <sup>1</sup>: The symbol of “--” in the table which means not application.

Note <sup>2</sup>: For the test data above 1 GHz, according the ANSI C63.10-2013, where limits are specified for both average and peak (or quasi-peak) detector functions, if the peak (or quasi-peak) measured value complies with the average limit, it is unnecessary to perform an average measurement.

Note <sup>3</sup>: The EUT is working in the Normal link mode below 1 GHz. All modes have been tested and DH5-Hopping mode is the worst.

Note <sup>4</sup>: Results (dBuV/m) = Original reading level of Spectrum Analyzer (dBuV/m) + Factor (dB)

The low frequency, which started from 9 kHz to 30 MHz, was pre-scanned and the result which was 20 dB lower than the limit line per 15.31(o) was not reported.

### Test Data and Plots

30 MHz to 1 GHz, ANT H

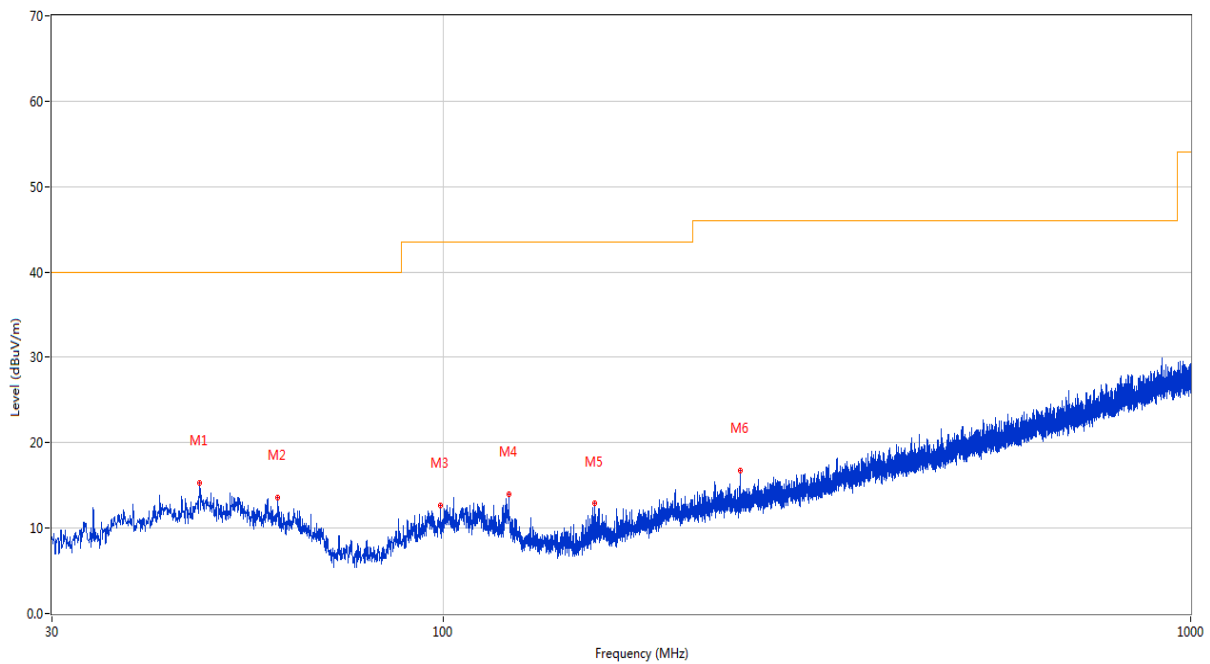

No.	Frequency (MHz)	Results (dBuV/m)	Factor (dB)	Limit (dBuV/m)	Margin (dB)	Detector	Table (Degree)	Height (cm)	Antenna	Verdict
1	47.315	15.31	-22.81	40.0	24.69	Peak	289.70	100	Horizontal	Pass
2	60.167	13.54	-24.06	40.0	26.46	Peak	254.40	100	Horizontal	Pass
3	99.258	12.68	-24.82	43.5	30.82	Peak	94.20	100	Horizontal	Pass
4	122.490	13.94	-26.19	43.5	29.56	Peak	3.20	100	Horizontal	Pass
5	159.446	12.86	-27.43	43.5	30.64	Peak	210.20	200	Horizontal	Pass
6	250.044	16.75	-22.91	46.0	29.25	Peak	346.90	200	Horizontal	Pass

30 MHz to 1 GHz, ANT V

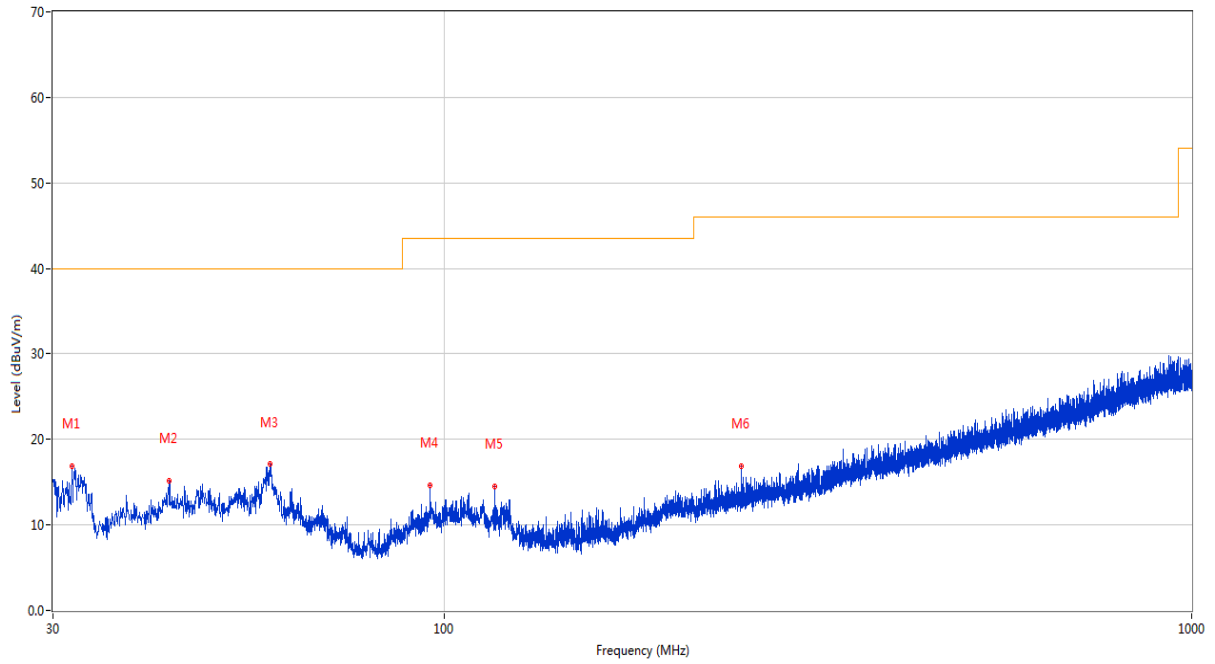

No.	Frequency (MHz)	Results (dBuV/m)	Factor (dB)	Limit (dBuV/m)	Margin (dB)	Detector	Table (Degree)	Height (cm)	Antenna	Verdict
1	31.843	16.89	-26.61	40.0	23.11	Peak	169.30	100	Vertical	Pass
2	42.950	15.18	-23.38	40.0	24.82	Peak	197.20	200	Vertical	Pass
3	58.518	17.08	-24.07	40.0	22.92	Peak	281.50	100	Vertical	Pass
4	95.911	14.63	-24.73	43.5	28.87	Peak	195.00	200	Vertical	Pass
5	116.912	14.56	-25.81	43.5	28.94	Peak	88.20	100	Vertical	Pass
6	249.996	16.85	-22.91	46.0	29.15	Peak	315.10	200	Vertical	Pass

Note 1: The marked spikes near 2400 MHz with circle should be ignored because they are Fundamental signal.

Note 2: The spurious from 18GHz-25GHz is noise only, do not show on the report.

**GFSK LOW CHANNEL 1 GHz to 18 GHz, ANT H**

RE Test case\_FCC Part 15C\_FCC 15.247(2.4G)\_1GHz-18GHz

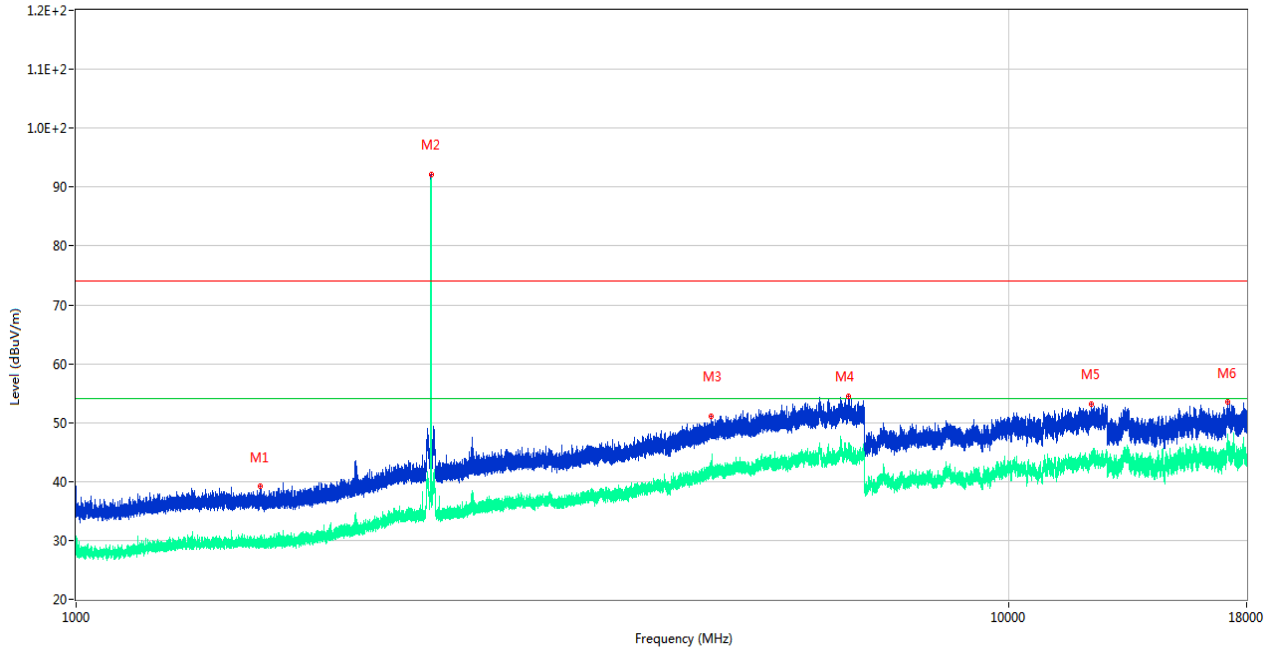

No.	Frequency (MHz)	Results (dBuV/m)	Factor (dB)	Limit (dBuV/m)	Margin (dB)	Detector	Table (Degree)	Height (cm)	Antenna	Verdict
1	1576.400	39.13	-17.48	74.0	34.87	Peak	79.00	400	Horizontal	Pass
1**	1576.400	29.25	-17.48	54.0	24.75	AV	79.00	400	Horizontal	Pass
2	2402.200	92.14	-12.43	74.0	-18.14	Peak	296.00	150	Horizontal	N/A
2**	2402.200	91.94	-12.43	54.0	-37.94	AV	296.00	150	Horizontal	N/A
3	4792.600	51.05	-2.44	74.0	22.95	Peak	28.00	100	Horizontal	Pass
3**	4792.600	41.55	-2.44	54.0	12.45	AV	28.00	100	Horizontal	Pass
4	6738.800	54.39	0.59	74.0	19.61	Peak	263.00	100	Horizontal	Pass
4**	6738.800	46.47	0.59	54.0	7.53	AV	263.00	100	Horizontal	Pass
5	12281.662	53.21	1.79	74.0	20.79	Peak	95.00	400	Horizontal	Pass
5**	12281.662	44.24	1.79	54.0	9.76	AV	95.00	400	Horizontal	Pass
6	17179.162	53.51	2.65	74.0	20.49	Peak	222.00	300	Horizontal	Pass
6**	17179.162	46.03	2.65	54.0	7.97	AV	222.00	300	Horizontal	Pass

GFSK LOW CHANNEL 1 GHz to 18 GHz, ANT V

RE Test case\_FCC Part 15C\_FCC 15.247(2.4G)\_1GHz-18GHz

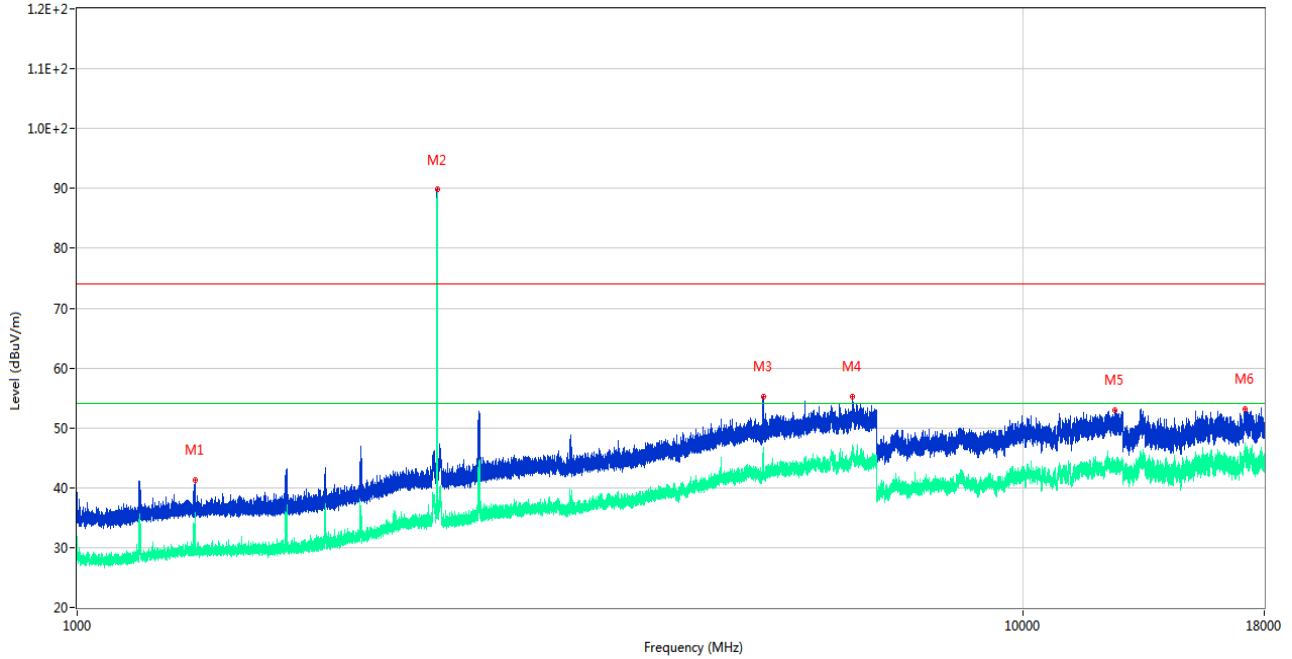

No.	Frequency (MHz)	Results (dBuV/m)	Factor (dB)	Limit (dBuV/m)	Margin (dB)	Detector	Table (Degree)	Height (cm)	Antenna	Verdict
1	1332.900	41.30	-17.52	74.0	32.70	Peak	141.00	100	Vertical	Pass
1**	1332.900	28.84	-17.52	54.0	25.16	AV	141.00	100	Vertical	Pass
2	2402.200	89.83	-12.43	74.0	-15.83	Peak	194.00	200	Vertical	N/A
2**	2402.200	89.69	-12.43	54.0	-35.69	AV	194.00	200	Vertical	N/A
3	5312.800	55.15	-2.71	74.0	18.85	Peak	93.00	150	Vertical	Pass
3**	5312.800	41.95	-2.71	54.0	12.05	AV	93.00	150	Vertical	Pass
4	6608.800	55.22	1.60	74.0	18.78	Peak	115.00	400	Vertical	Pass
4**	6608.800	46.54	1.60	54.0	7.46	AV	115.00	400	Vertical	Pass
5	12499.875	52.96	1.65	74.0	21.04	Peak	231.00	200	Vertical	Pass
5**	12499.875	43.39	1.65	54.0	10.61	AV	231.00	200	Vertical	Pass
6	17189.663	53.16	2.35	74.0	20.84	Peak	73.00	300	Vertical	Pass
6**	17189.663	45.17	2.35	54.0	8.83	AV	73.00	300	Vertical	Pass

GFSK MIDDLE CHANNEL 1 GHz to 18 GHz, ANT H

RE Test case\_FCC Part 15C\_FCC 15.247(2.4G)\_1GHz-18GHz

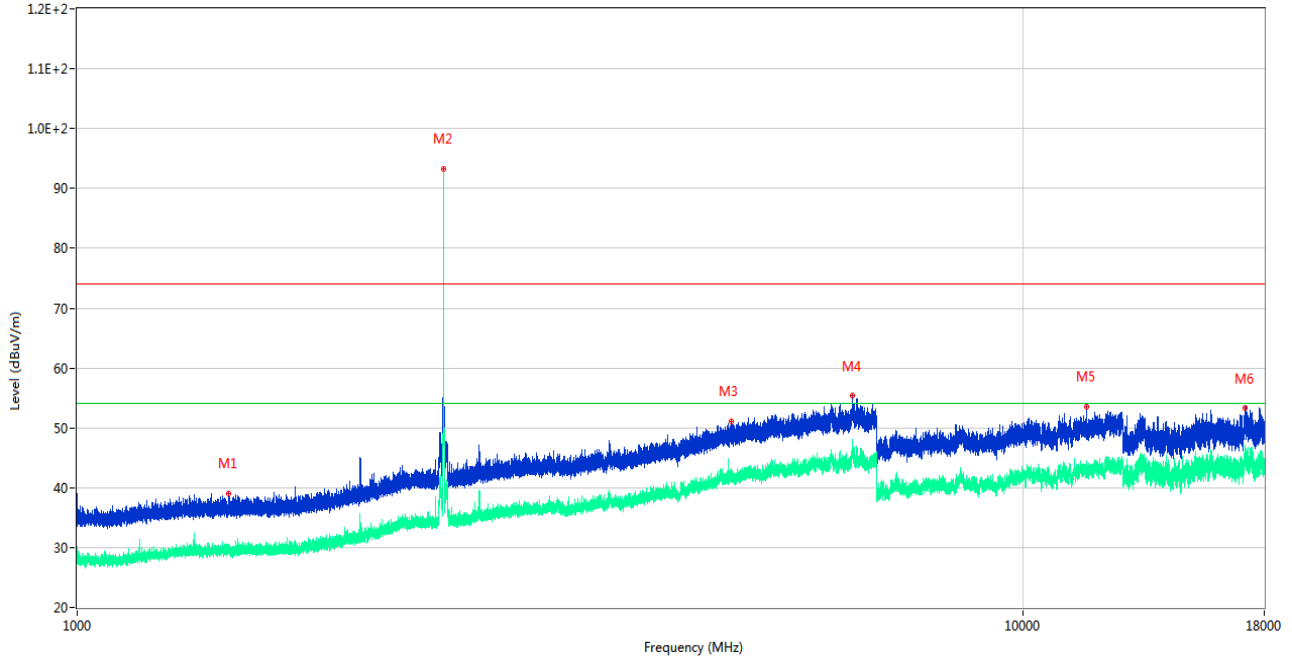

No.	Frequency (MHz)	Results (dBuV/m)	Factor (dB)	Limit (dBuV/m)	Margin (dB)	Detector	Table (Degree)	Height (cm)	Antenna	Verdict
1	1447.300	39.06	-17.27	74.0	34.94	Peak	360.00	400	Horizontal	Pass
1**	1447.300	29.65	-17.27	54.0	24.35	AV	360.00	400	Horizontal	Pass
2	2440.900	93.25	-12.43	74.0	-19.25	Peak	289.00	100	Horizontal	N/A
2**	2440.900	92.87	-12.43	54.0	-38.87	AV	289.00	100	Horizontal	N/A
3	4913.000	51.09	-2.77	74.0	22.91	Peak	322.00	100	Horizontal	Pass
3**	4913.000	41.69	-2.77	54.0	12.31	AV	322.00	100	Horizontal	Pass
4	6609.200	55.43	1.58	74.0	18.57	Peak	262.00	400	Horizontal	Pass
4**	6609.200	45.78	1.58	54.0	8.22	AV	262.00	400	Horizontal	Pass
5	11668.138	53.52	0.21	74.0	20.48	Peak	159.00	400	Horizontal	Pass
5**	11668.138	42.87	0.21	54.0	11.13	AV	159.00	400	Horizontal	Pass
6	17170.500	53.26	2.40	74.0	20.74	Peak	33.00	400	Horizontal	Pass
6**	17170.500	45.04	2.40	54.0	8.96	AV	33.00	400	Horizontal	Pass

GFSK MIDDLE CHANNEL 1 GHz to 18 GHz, ANT V

RE Test case\_FCC Part 15C\_FCC 15.247(2.4G)\_1GHz-18GHz

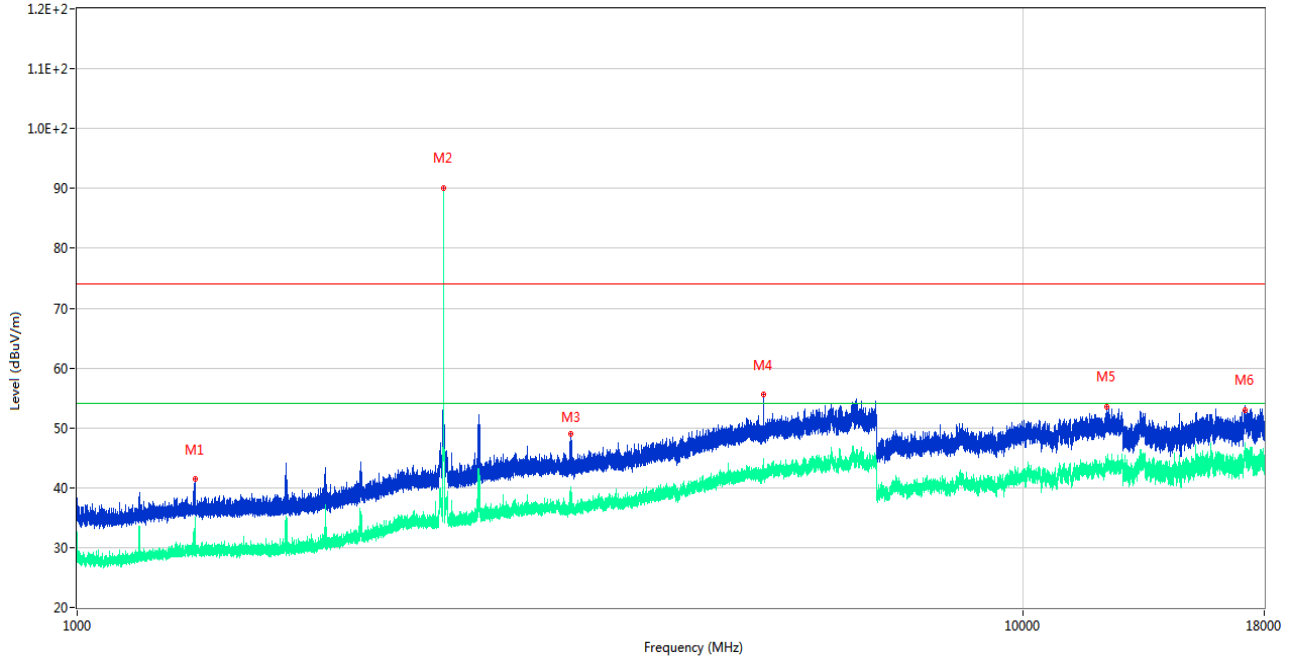

No.	Frequency (MHz)	Results (dBuV/m)	Factor (dB)	Limit (dBuV/m)	Margin (dB)	Detector	Table (Degree)	Height (cm)	Antenna	Verdict
1	1333.700	41.43	-17.50	74.0	32.57	Peak	128.00	300	Vertical	Pass
1**	1333.700	29.19	-17.50	54.0	24.81	AV	128.00	300	Vertical	Pass
2	2440.900	90.11	-12.43	74.0	-16.11	Peak	128.00	100	Vertical	N/A
2**	2440.900	89.72	-12.43	54.0	-35.72	AV	128.00	100	Vertical	N/A
3	3330.000	49.06	-8.42	74.0	24.94	Peak	224.00	100	Vertical	Pass
3**	3330.000	36.47	-8.42	54.0	17.53	AV	224.00	100	Vertical	Pass
4	5322.600	55.56	-2.80	74.0	18.44	Peak	93.00	200	Vertical	Pass
4**	5322.600	41.65	-2.80	54.0	12.35	AV	93.00	200	Vertical	Pass
5	12282.526	53.59	1.79	74.0	20.41	Peak	142.00	100	Vertical	Pass
5**	12282.526	43.48	1.79	54.0	10.52	AV	142.00	100	Vertical	Pass
6	17182.839	53.01	2.59	74.0	20.99	Peak	20.00	100	Vertical	Pass
6**	17182.839	45.75	2.59	54.0	8.25	AV	20.00	100	Vertical	Pass

GFSK HIGH CHANNEL 1 GHz to 18 GHz, ANT H

RE Test case\_FCC Part 15C\_FCC 15.247(2.4G)\_1GHz-18GHz

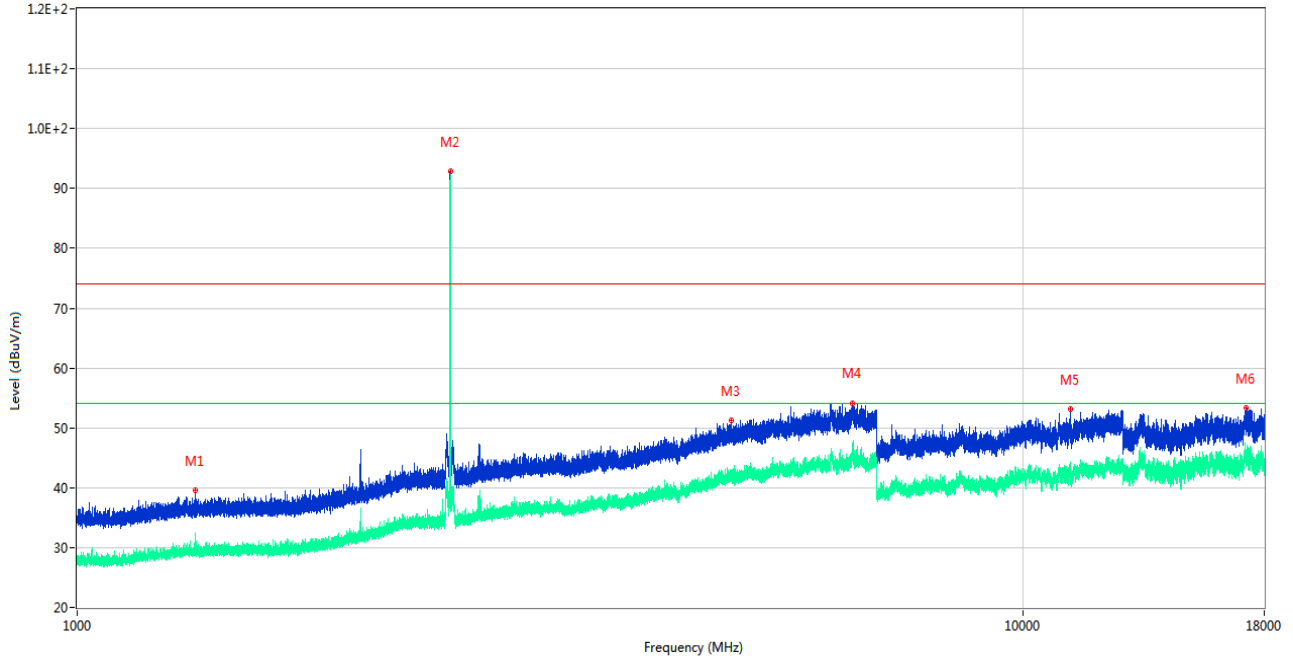

No.	Frequency (MHz)	Results (dBuV/m)	Factor (dB)	Limit (dBuV/m)	Margin (dB)	Detector	Table (Degree)	Height (cm)	Antenna	Verdict
1	1332.100	39.57	-17.51	74.0	34.43	Peak	358.00	200	Horizontal	Pass
1**	1332.100	29.21	-17.51	54.0	24.79	AV	358.00	200	Horizontal	Pass
2	2479.800	92.79	-12.03	74.0	-18.79	Peak	284.00	100	Horizontal	N/A
2**	2479.800	91.85	-12.03	54.0	-37.85	AV	284.00	100	Horizontal	N/A
3	4913.600	51.35	-2.74	74.0	22.65	Peak	28.00	100	Horizontal	Pass
3**	4913.600	41.27	-2.74	54.0	12.73	AV	28.00	100	Horizontal	Pass
4	6601.400	54.18	0.56	74.0	19.82	Peak	360.00	400	Horizontal	Pass
4**	6601.400	46.23	0.56	54.0	7.77	AV	360.00	400	Horizontal	Pass
5	11220.787	53.07	-0.21	74.0	20.93	Peak	235.00	400	Horizontal	Pass
5**	11220.787	44.05	-0.21	54.0	9.95	AV	235.00	400	Horizontal	Pass
6	17204.363	53.29	1.67	74.0	20.71	Peak	125.00	400	Horizontal	Pass
6**	17204.363	44.84	1.67	54.0	9.16	AV	125.00	400	Horizontal	Pass



GFSK HIGH CHANNEL 1 GHz to 18 GHz, ANT V

RE Test case\_FCC Part 15C\_FCC 15.247(2.4G)\_1GHz-18GHz

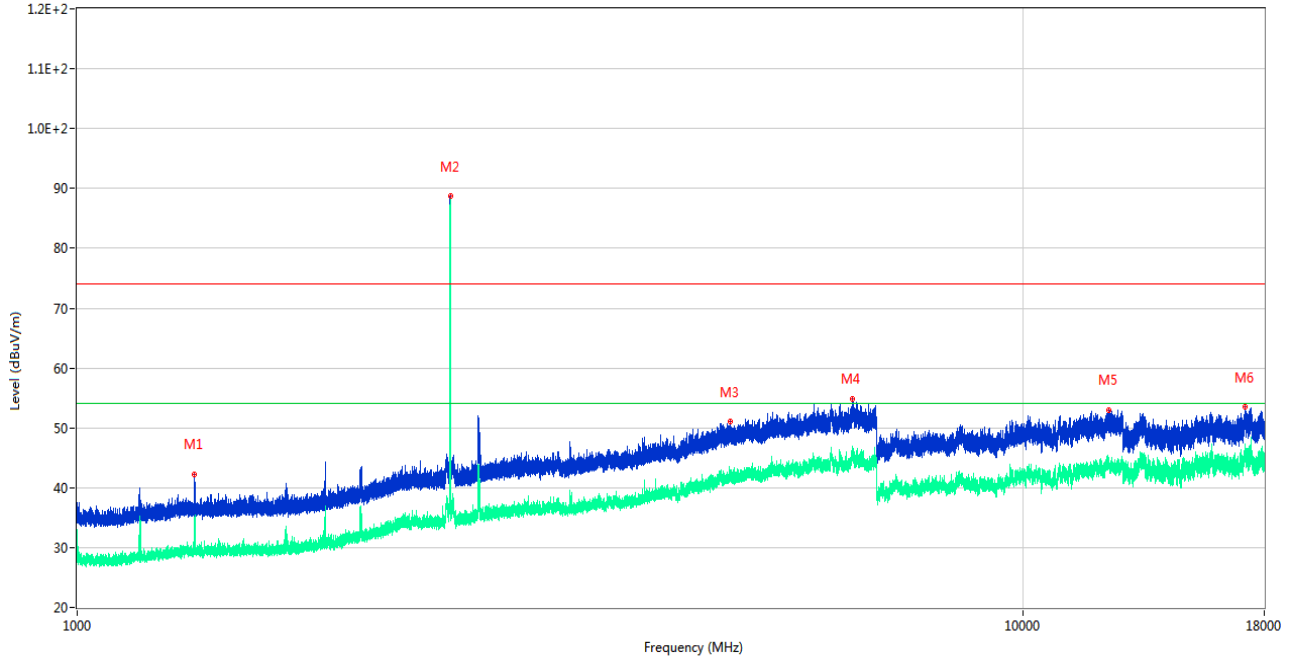

No.	Frequency (MHz)	Results (dBuV/m)	Factor (dB)	Limit (dBuV/m)	Margin (dB)	Detector	Table (Degree)	Height (cm)	Antenna	Verdict
1	1330.300	42.28	-17.49	74.0	31.72	Peak	147.00	100	Vertical	Pass
1**	1330.300	33.78	-17.49	54.0	20.22	AV	147.00	100	Vertical	Pass
2	2479.800	88.68	-12.03	74.0	-14.68	Peak	90.00	100	Vertical	N/A
2**	2479.800	87.54	-12.03	54.0	-33.54	AV	90.00	100	Vertical	N/A
3	4900.200	51.02	-2.62	74.0	22.98	Peak	121.00	100	Vertical	Pass
3**	4900.200	42.20	-2.62	54.0	11.80	AV	121.00	100	Vertical	Pass
4	6607.600	54.89	1.52	74.0	19.11	Peak	132.00	200	Vertical	Pass
4**	6607.600	46.85	1.52	54.0	7.15	AV	132.00	200	Vertical	Pass
5	12335.138	53.02	1.34	74.0	20.98	Peak	360.00	400	Vertical	Pass
5**	12335.138	43.48	1.34	54.0	10.52	AV	360.00	400	Vertical	Pass
6	17182.050	53.43	2.62	74.0	20.57	Peak	180.00	200	Vertical	Pass
6**	17182.050	45.49	2.62	54.0	8.51	AV	180.00	200	Vertical	Pass

$\pi/4$ -DQPSK LOW CHANNEL 1 GHz to 18 GHz, ANT H

RE Test case\_FCC Part 15C\_FCC 15.247(2.4G)\_1GHz-18GHz

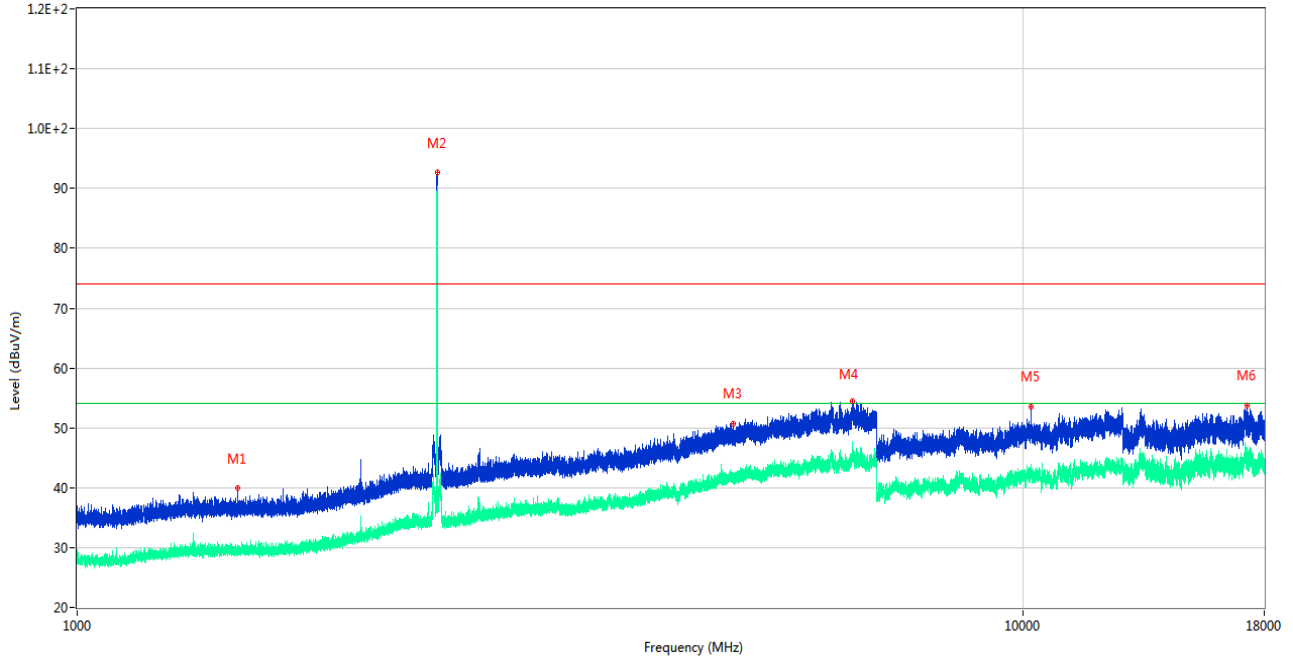

No.	Frequency (MHz)	Results (dBuV/m)	Factor (dB)	Limit (dBuV/m)	Margin (dB)	Detector	Table (Degree)	Height (cm)	Antenna	Verdict
1	1477.600	39.89	-17.56	74.0	34.11	Peak	265.00	400	Horizontal	Pass
1**	1477.600	28.88	-17.56	54.0	25.12	AV	265.00	400	Horizontal	Pass
2	2402.200	92.68	-12.43	74.0	-18.68	Peak	295.00	150	Horizontal	N/A
2**	2402.200	89.54	-12.43	54.0	-35.54	AV	295.00	150	Horizontal	N/A
3	4936.000	50.70	-2.92	74.0	23.30	Peak	38.00	100	Horizontal	Pass
3**	4936.000	41.58	-2.92	54.0	12.42	AV	38.00	100	Horizontal	Pass
4	6604.000	54.45	1.01	74.0	19.55	Peak	201.00	400	Horizontal	Pass
4**	6604.000	45.64	1.01	54.0	8.36	AV	201.00	400	Horizontal	Pass
5	10197.000	53.56	0.45	74.0	20.44	Peak	176.00	400	Horizontal	Pass
5**	10197.000	43.58	0.45	54.0	10.42	AV	176.00	400	Horizontal	Pass
6	17247.150	53.74	1.59	74.0	20.26	Peak	136.00	100	Horizontal	Pass
6**	17247.150	45.33	1.59	54.0	8.67	AV	136.00	100	Horizontal	Pass

$\pi/4$ -DQPSK LOW CHANNEL 1 GHz to 18 GHz, ANT V

RE Test case\_FCC Part 15C\_FCC 15.247(2.4G)\_1GHz-18GHz

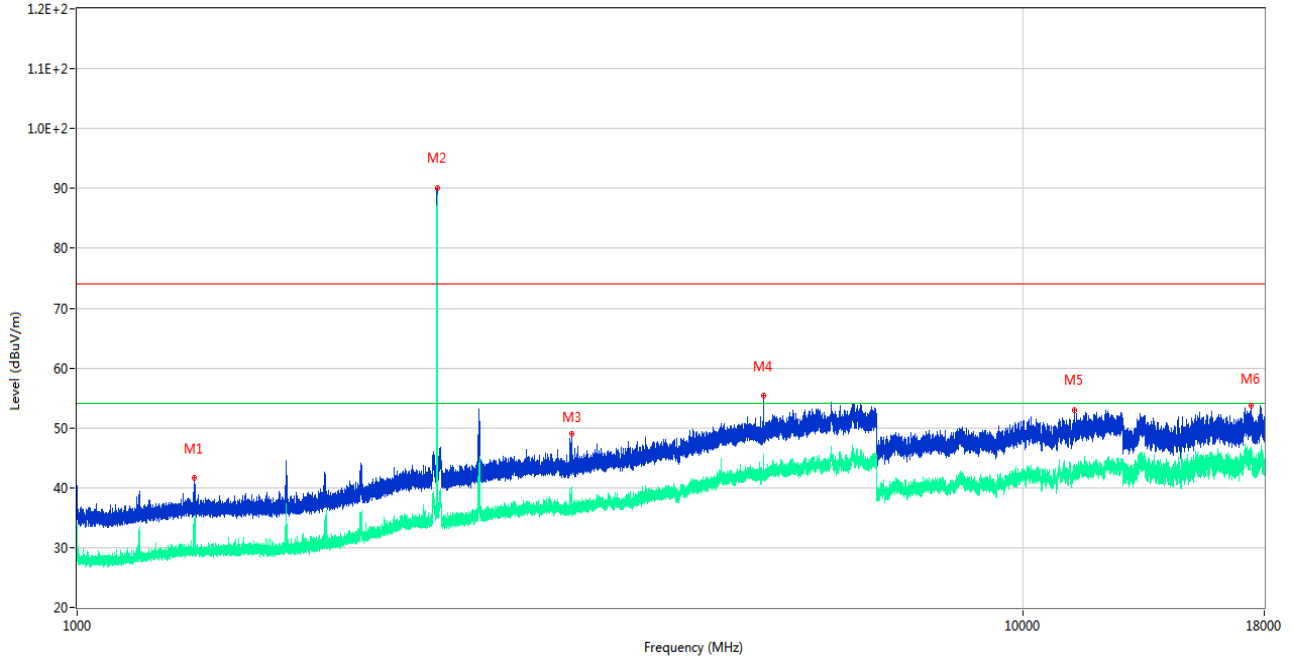

No.	Frequency (MHz)	Results (dBuV/m)	Factor (dB)	Limit (dBuV/m)	Margin (dB)	Detector	Table (Degree)	Height (cm)	Antenna	Verdict
1	1330.300	41.64	-17.49	74.0	32.36	Peak	99.00	200	Vertical	Pass
1**	1330.300	30.65	-17.49	54.0	23.35	AV	99.00	200	Vertical	Pass
2	2402.300	90.10	-12.41	74.0	-16.10	Peak	193.00	200	Vertical	N/A
2**	2402.300	88.11	-12.41	54.0	-34.11	AV	193.00	200	Vertical	N/A
3	3331.400	48.92	-8.52	74.0	25.08	Peak	225.00	100	Vertical	Pass
3**	3331.400	36.73	-8.52	54.0	17.27	AV	225.00	100	Vertical	Pass
4	5321.800	55.39	-2.83	74.0	18.61	Peak	215.00	400	Vertical	Pass
4**	5321.800	42.04	-2.83	54.0	11.96	AV	215.00	400	Vertical	Pass
5	11341.250	53.01	0.23	74.0	20.99	Peak	188.00	200	Vertical	Pass
5**	11341.250	42.96	0.23	54.0	11.04	AV	188.00	200	Vertical	Pass
6	17416.200	53.64	3.67	74.0	20.36	Peak	33.00	200	Vertical	Pass
6**	17416.200	44.92	3.67	54.0	9.08	AV	33.00	200	Vertical	Pass

$\pi/4$ -DQPSK MIDDLE CHANNEL 1 GHz to 18 GHz, ANT H

RE Test case\_FCC Part 15C\_FCC 15.247(2.4G)\_1GHz-18GHz

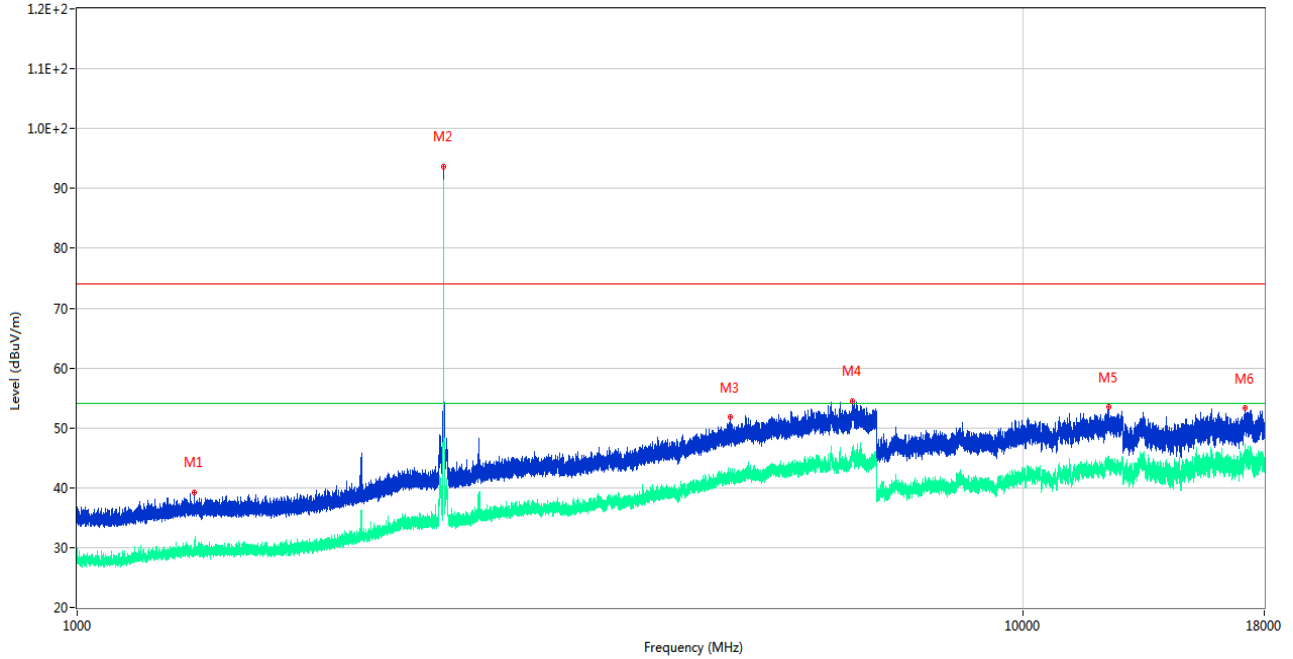

No.	Frequency (MHz)	Results (dBuV/m)	Factor (dB)	Limit (dBuV/m)	Margin (dB)	Detector	Table (Degree)	Height (cm)	Antenna	Verdict
1	1329.800	39.27	-17.55	74.0	34.73	Peak	163.00	300	Horizontal	Pass
1**	1329.800	29.30	-17.55	54.0	24.70	AV	163.00	300	Horizontal	Pass
2	2441.000	93.72	-12.44	74.0	-19.72	Peak	291.00	150	Horizontal	N/A
2**	2441.000	91.29	-12.44	54.0	-37.29	AV	291.00	150	Horizontal	N/A
3	4902.200	51.80	-2.49	74.0	22.20	Peak	253.00	100	Horizontal	Pass
3**	4902.200	41.78	-2.49	54.0	12.22	AV	253.00	100	Horizontal	Pass
4	6611.000	54.51	1.47	74.0	19.49	Peak	263.00	400	Horizontal	Pass
4**	6611.000	46.27	1.47	54.0	7.73	AV	263.00	400	Horizontal	Pass
5	12334.850	53.48	1.35	74.0	20.52	Peak	109.00	300	Horizontal	Pass
5**	12334.850	43.70	1.35	54.0	10.30	AV	109.00	300	Horizontal	Pass
6	17195.700	53.29	2.15	74.0	20.71	Peak	162.00	100	Horizontal	Pass
6**	17195.700	45.36	2.15	54.0	8.64	AV	162.00	100	Horizontal	Pass

$\pi/4$ -DQPSK MIDDLE CHANNEL 1 GHz to 18 GHz, ANT V

RE Test case\_FCC Part 15C\_FCC 15.247(2.4G)\_1GHz-18GHz

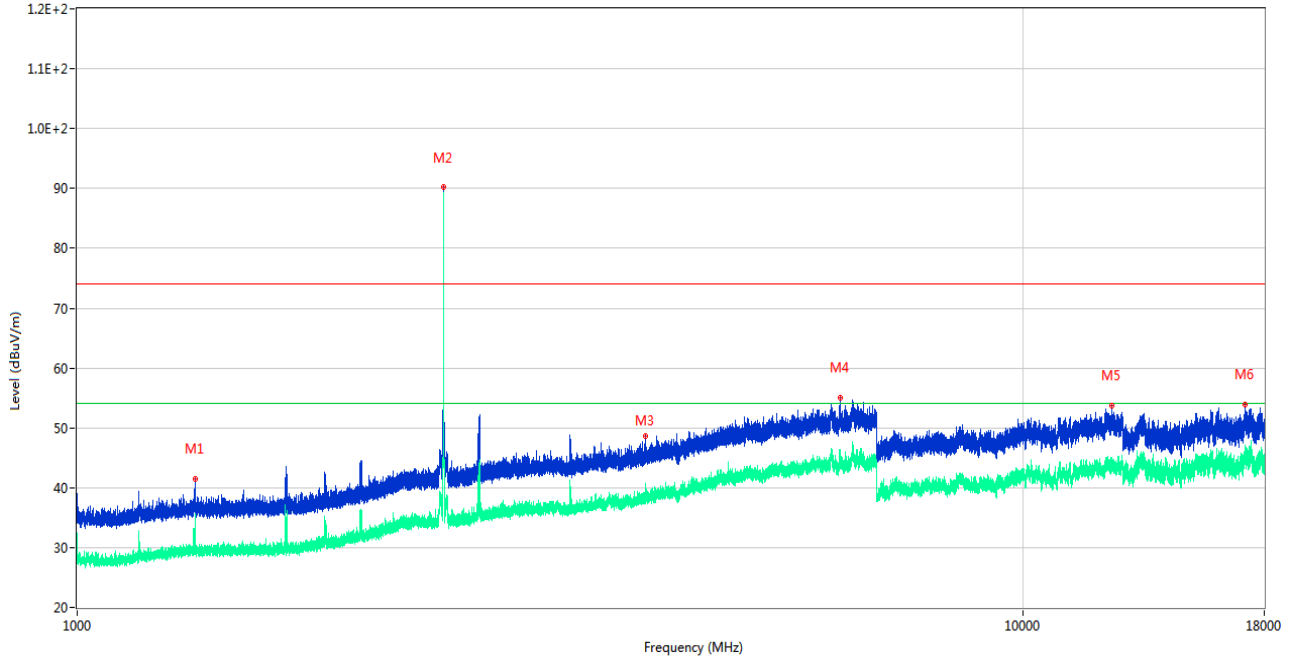

No.	Frequency (MHz)	Results (dBuV/m)	Factor (dB)	Limit (dBuV/m)	Margin (dB)	Detector	Table (Degree)	Height (cm)	Antenna	Verdict
1	1332.000	41.53	-17.51	74.0	32.47	Peak	104.00	200	Vertical	Pass
1**	1332.000	32.00	-17.51	54.0	22.00	AV	104.00	200	Vertical	Pass
2	2440.900	90.19	-12.43	74.0	-16.19	Peak	128.00	150	Vertical	N/A
2**	2440.900	89.34	-12.43	54.0	-35.34	AV	128.00	150	Vertical	N/A
3	3993.400	48.56	-5.39	74.0	25.44	Peak	145.00	100	Vertical	Pass
3**	3993.400	38.97	-5.39	54.0	15.03	AV	145.00	100	Vertical	Pass
4	6404.800	55.06	0.26	74.0	18.94	Peak	219.00	100	Vertical	Pass
4**	6404.800	45.43	0.26	54.0	8.57	AV	219.00	100	Vertical	Pass
5	12417.362	53.74	1.40	74.0	20.26	Peak	231.00	300	Vertical	Pass
5**	12417.362	44.20	1.40	54.0	9.80	AV	231.00	300	Vertical	Pass
6	17185.462	53.90	2.51	74.0	20.10	Peak	168.00	100	Vertical	Pass
6**	17185.462	45.46	2.51	54.0	8.54	AV	168.00	100	Vertical	Pass

$\pi/4$ -DQPSK HIGH CHANNEL 1 GHz to 18 GHz, ANT H

RE Test case\_FCC Part 15C\_FCC 15.247(2.4G)\_1GHz-18GHz

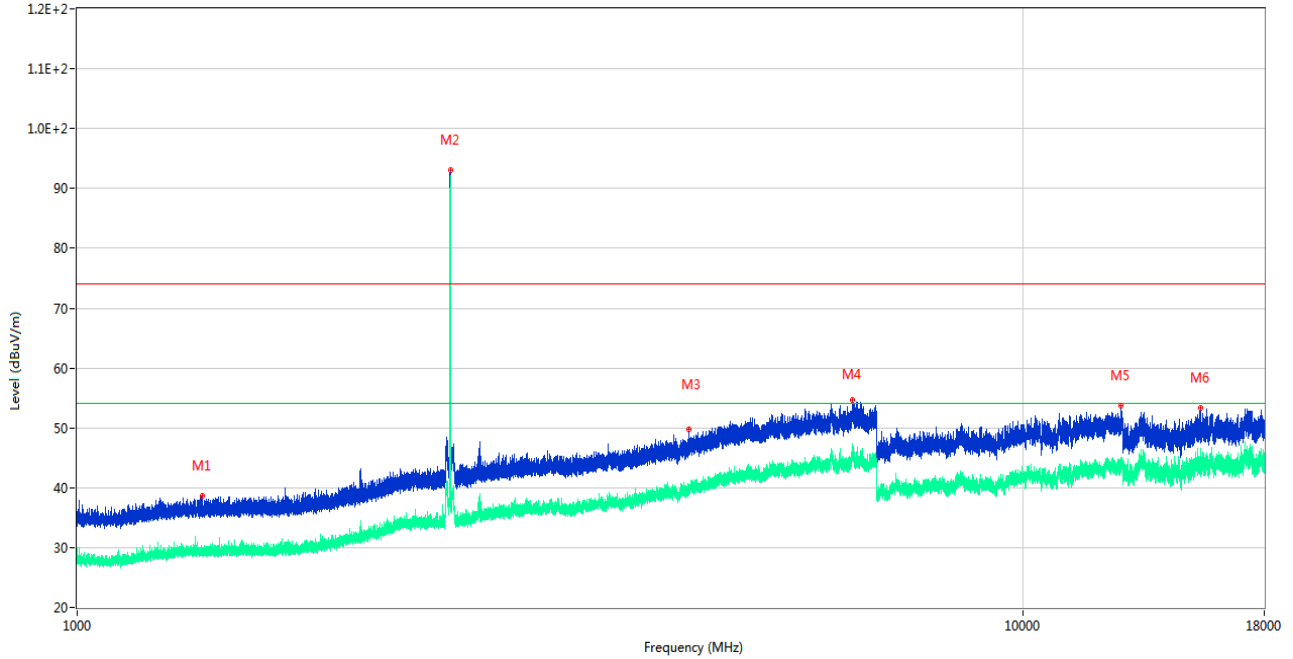

No.	Frequency (MHz)	Results (dBuV/m)	Factor (dB)	Limit (dBuV/m)	Margin (dB)	Detector	Table (Degree)	Height (cm)	Antenna	Verdict
1	1356.600	38.66	-17.56	74.0	35.34	Peak	99.00	100	Horizontal	Pass
1**	1356.600	28.74	-17.56	54.0	25.26	AV	99.00	100	Horizontal	Pass
2	2479.900	93.12	-12.03	74.0	-19.12	Peak	284.00	200	Horizontal	N/A
2**	2479.900	91.89	-12.03	54.0	-37.89	AV	284.00	200	Horizontal	N/A
3	4440.000	49.75	-4.22	74.0	24.25	Peak	182.00	100	Horizontal	Pass
3**	4440.000	39.99	-4.22	54.0	14.01	AV	182.00	100	Horizontal	Pass
4	6605.400	54.66	1.25	74.0	19.34	Peak	312.00	200	Horizontal	Pass
4**	6605.400	46.32	1.25	54.0	7.68	AV	312.00	200	Horizontal	Pass
5	12704.575	53.74	0.89	74.0	20.26	Peak	263.00	300	Horizontal	Pass
5**	12704.575	43.58	0.89	54.0	10.42	AV	263.00	300	Horizontal	Pass
6	15404.137	53.35	0.80	74.0	20.65	Peak	153.00	300	Horizontal	Pass
6**	15404.137	43.58	0.80	54.0	10.42	AV	153.00	300	Horizontal	Pass

$\pi/4$ -DQPSK HIGH CHANNEL 1 GHz to 18 GHz, ANT V

RE Test case\_FCC Part 15C\_FCC 15.247(2.4G)\_1GHz-18GHz

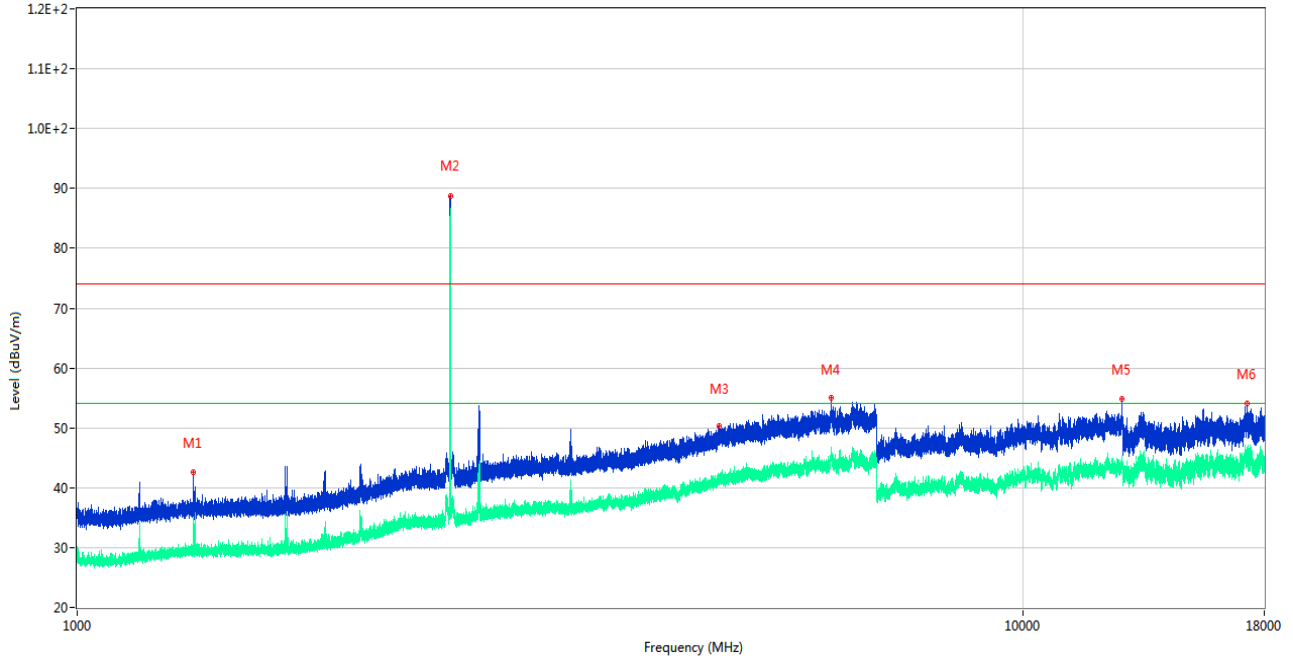

No.	Frequency (MHz)	Results (dBuV/m)	Factor (dB)	Limit (dBuV/m)	Margin (dB)	Detector	Table (Degree)	Height (cm)	Antenna	Verdict
1	1327.700	42.54	-17.62	74.0	31.46	Peak	5.00	300	Vertical	Pass
1**	1327.700	34.12	-17.62	54.0	19.88	AV	5.00	300	Vertical	Pass
2	2479.900	88.81	-12.03	74.0	-14.81	Peak	131.00	200	Vertical	N/A
2**	2479.900	86.39	-12.03	54.0	-32.39	AV	131.00	200	Vertical	N/A
3	4774.400	50.33	-2.82	74.0	23.67	Peak	19.00	100	Vertical	Pass
3**	4774.400	42.26	-2.82	54.0	11.74	AV	19.00	100	Vertical	Pass
4	6266.800	54.97	0.02	74.0	19.03	Peak	259.00	300	Vertical	Pass
4**	6266.800	45.48	0.02	54.0	8.52	AV	259.00	300	Vertical	Pass
5	12716.937	54.76	1.09	74.0	19.24	Peak	253.00	300	Vertical	Pass
5**	12716.937	43.26	1.09	54.0	10.74	AV	253.00	300	Vertical	Pass
6	17249.776	54.02	1.58	74.0	19.98	Peak	17.00	300	Vertical	Pass
6**	17249.776	44.46	1.58	54.0	9.54	AV	17.00	300	Vertical	Pass



## A.9 Band Edge (Restricted-band band-edge)

Note <sup>1</sup>: The lowest and highest channels are tested to verify the band edge emissions. Please refer to the following the plots for emissions values.

Note <sup>2</sup>: The test data all are tested in the vertical and horizontal antenna which the trace is max hold. So these plots have shown the worst case.

Note <sup>3</sup>: According the ANSI C63.10-2013, where limits are specified for both average and peak (or quasi-peak) detector functions, if the peak (or quasi-peak) measured value complies with the average limit, it is unnecessary to perform an average measurement.

Note <sup>4</sup>: The Level (dBuV/m) has been corrected by factor.

### Test Data and Plots

#### GFSK LOW CHANNEL

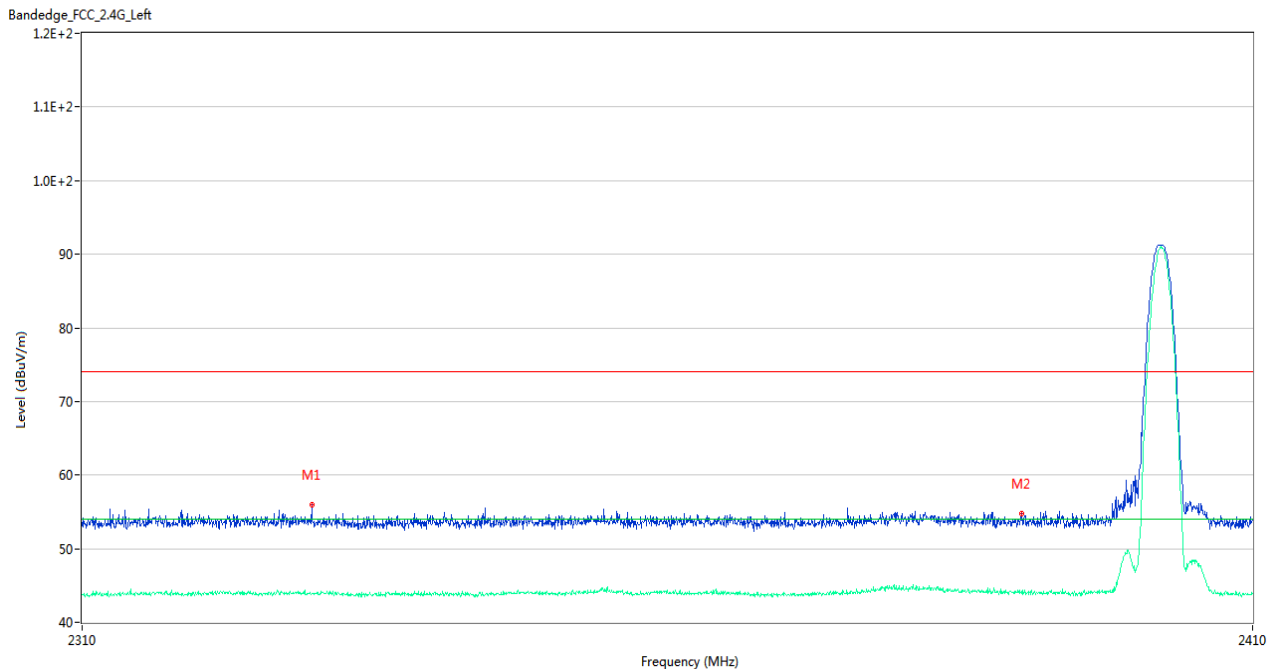

No.	Frequency (MHz)	Results (dBuV/m)	Factor (dB)	Limit (dBuV/m)	Margin (dB)	Detector	Table (Degree)	Height (cm)	Antenna	Verdict
1	2329.300	56.00	-0.62	74.0	18.00	Peak	237.00	200	Horizontal	Pass
1**	2329.300	43.92	-0.62	54.0	10.08	AV	237.00	200	Horizontal	Pass
2	2389.950	54.70	-0.59	74.0	19.30	Peak	247.00	200	Horizontal	Pass
2**	2389.950	44.02	-0.59	54.0	9.98	AV	247.00	200	Horizontal	Pass

**GFSK HIGH CHANNEL**

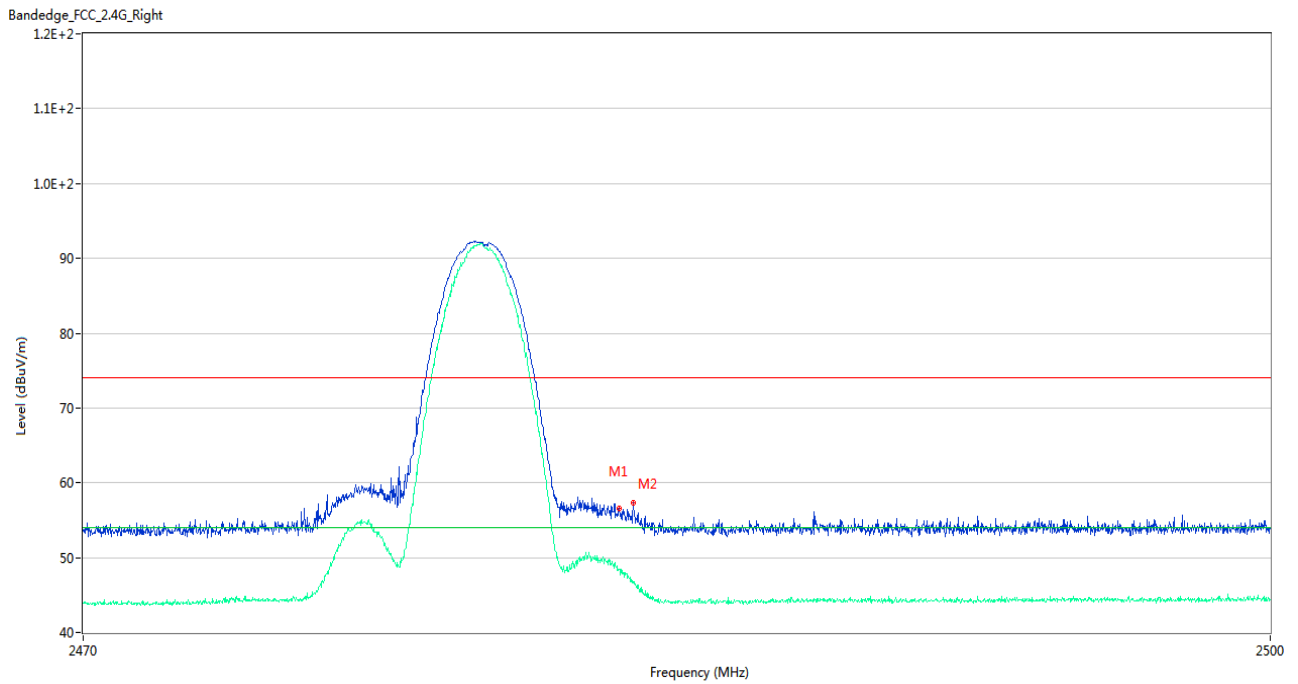

No.	Frequency (MHz)	Results (dBuV/m)	Factor (dB)	Limit (dBuV/m)	Margin (dB)	Detector	Table (Degree)	Height (cm)	Antenna	Verdict
1	2483.500	56.55	-0.05	74.0	17.45	Peak	89.00	100	Horizontal	Pass
1**	2483.500	48.41	-0.05	54.0	5.59	AV	89.00	100	Horizontal	Pass
2	2483.860	57.34	-0.09	74.0	16.66	Peak	283.00	100	Horizontal	Pass
2**	2483.860	46.71	-0.09	54.0	7.29	AV	283.00	100	Horizontal	Pass

**π/4-DQPSK LOW CHANNEL**

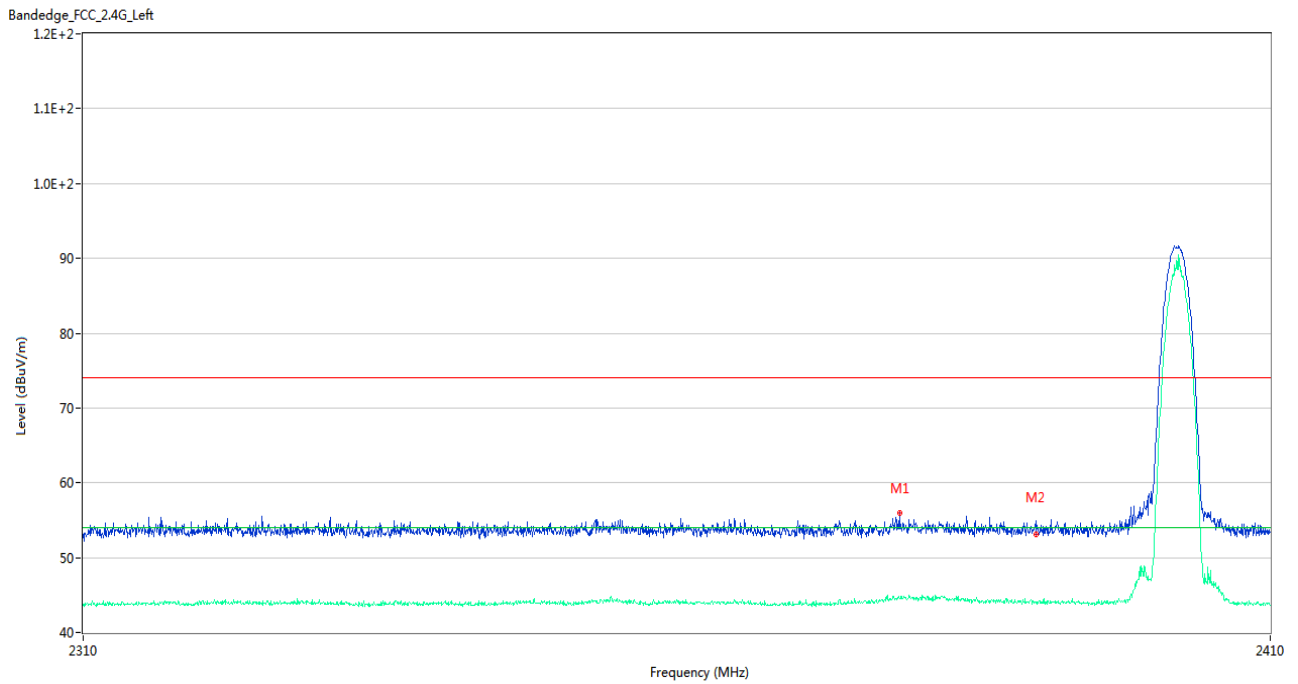

No.	Frequency (MHz)	Results (dBuV/m)	Factor (dB)	Limit (dBuV/m)	Margin (dB)	Detector	Table (Degree)	Height (cm)	Antenna	Verdict
1	2378.300	56.02	-0.50	74.0	17.98	Peak	349.00	200	Horizontal	Pass
1**	2378.300	44.48	-0.50	54.0	9.52	AV	349.00	200	Horizontal	Pass
2	2389.950	53.09	-0.59	74.0	20.91	Peak	57.00	200	Horizontal	Pass
2**	2389.950	44.10	-0.59	54.0	9.90	AV	57.00	200	Horizontal	Pass

**π/4-DQPSK HIGH CHANNEL**

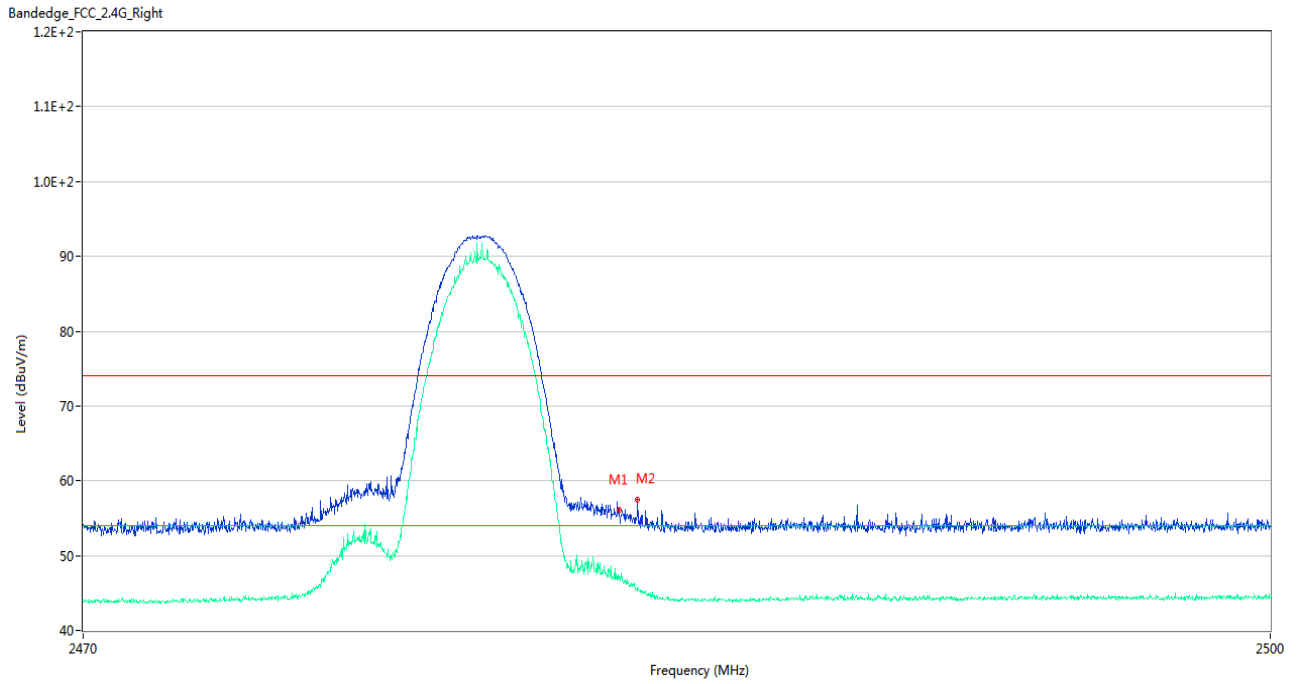

No.	Frequency (MHz)	Results (dBuV/m)	Factor (dB)	Limit (dBuV/m)	Margin (dB)	Detector	Table (Degree)	Height (cm)	Antenna	Verdict
1	2483.500	56.16	-0.05	74.0	17.84	Peak	239.00	100	Horizontal	Pass
1**	2483.500	47.24	-0.05	54.0	6.76	AV	239.00	100	Horizontal	Pass
2	2483.965	57.50	-0.10	74.0	16.50	Peak	237.00	100	Horizontal	Pass
2**	2483.965	45.65	-0.10	54.0	8.35	AV	237.00	100	Horizontal	Pass

## **ANNEX B TEST SETUP PHOTOS**

Please refer the document “BL-SZ2350123-AR.PDF”.

## **ANNEX C EUT EXTERNAL PHOTOS**

Please refer the document “BL-SZ2350123-AW.PDF”.

## **ANNEX D EUT INTERNAL PHOTOS**

Please refer the document “BL-SZ2350123-AI.PDF”.

## Statement

1. The laboratory guarantees the scientificity, accuracy and impartiality of the test, and is responsible for all the information in the report, except the information provided by the customer. The customer is responsible for the impact of the information provided on the validity of the results.
2. The report without China inspection body and laboratory Mandatory Approval (CMA) mark has no effect of proving to the society.
3. For the report with CNAS mark or A2LA mark, the items marked with "☆" are not within the accredited scope.
4. This report is invalid if it is altered, without the signature of the testing and approval personnel, or without the "inspection and testing dedicated stamp" or test report stamp.
5. The test data and results are only valid for the tested samples provided by the customer.
6. This report shall not be partially reproduced without the written permission of the laboratory.
7. Any objection shall be raised to the laboratory within 30 days after receiving the report.

--END OF REPORT--