

Z (mm)	0.00	4.00	9.00	14.00	19.00
SAR (W/Kg)	0.3372	0.2634	0.1926	0.1412	0.1038

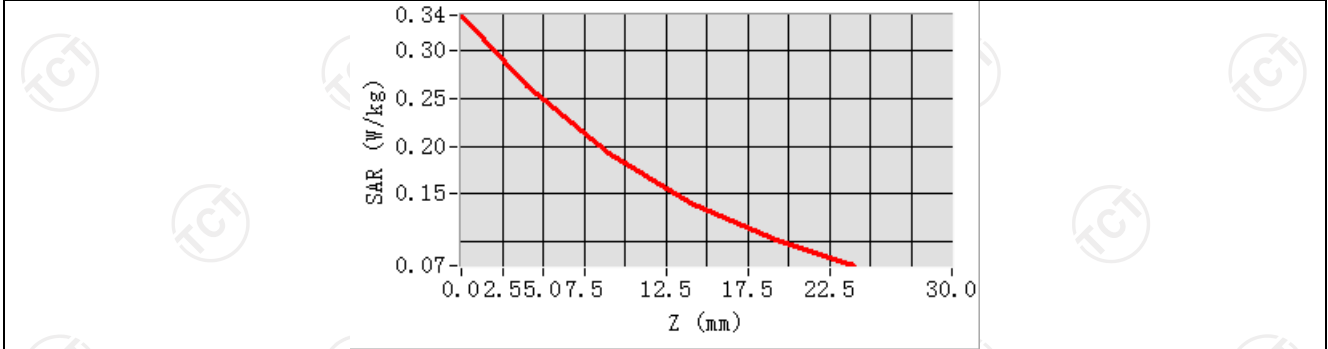

Hot spot position

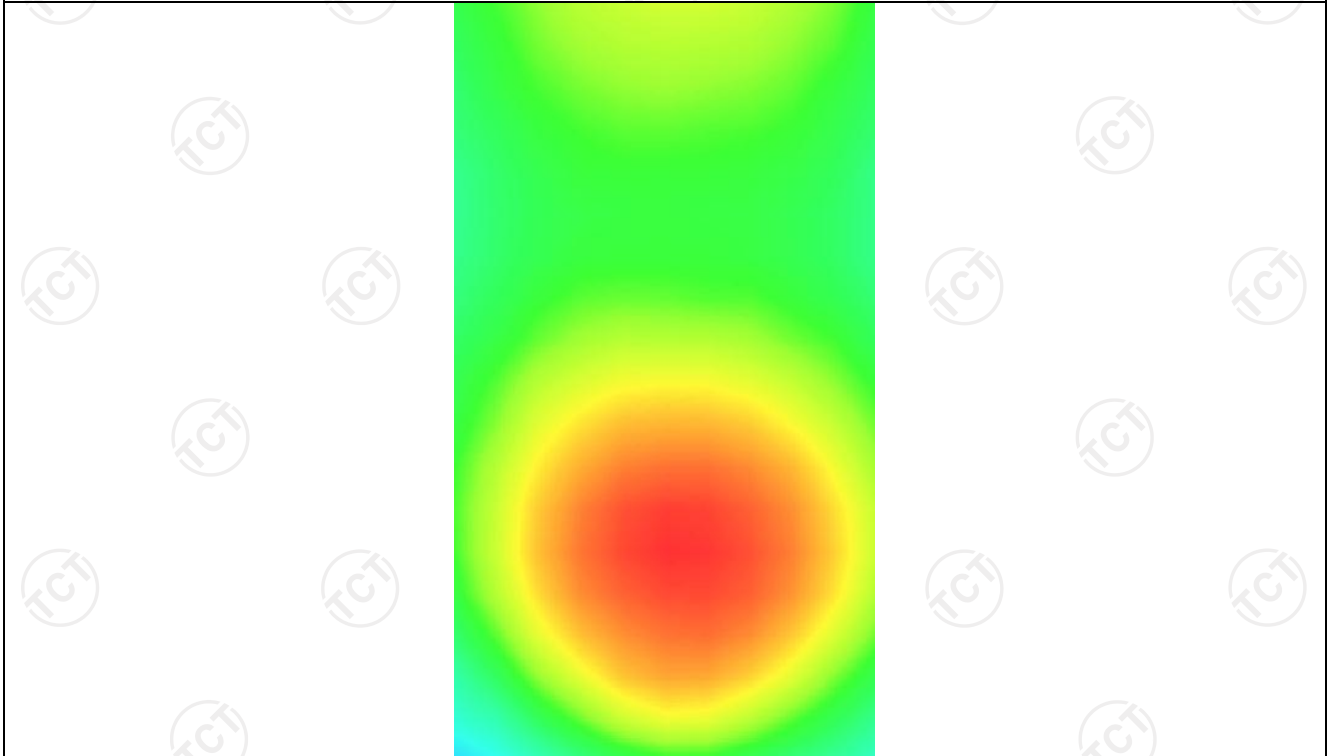

LTE Band 17

MEASUREMENT 1

High Band SAR (Channel 23800):

Date: 11/09/2023

Frequency (MHz)	711.000000
Relative permittivity (real part)	42.113335
Relative permittivity (imaginary part)	23.152000
Conductivity (S/m)	0.913218
Variation (%)	2.450000
Crest Factor	1.0
Probe Conversion factor	1.71
E-Field Probe:	SSE2 (SN 25/22 EPG0375)
Area Scan	<u>dx=8mm dy=8mm, h= 5.00 mm</u>
ZoomScan	<u>5x5x7, dx=8mm dy=8mm</u> <u>dz=5mm, Complete/ndx=8mm dy=8mm, h=</u> <u>5.00 mm</u>
Phantom	<u>Validation plane</u>
Device Position	<u>Body front(10mm)</u>
Band	<u>LTE band 17(1 RB#24)</u>

SURFACE SAR

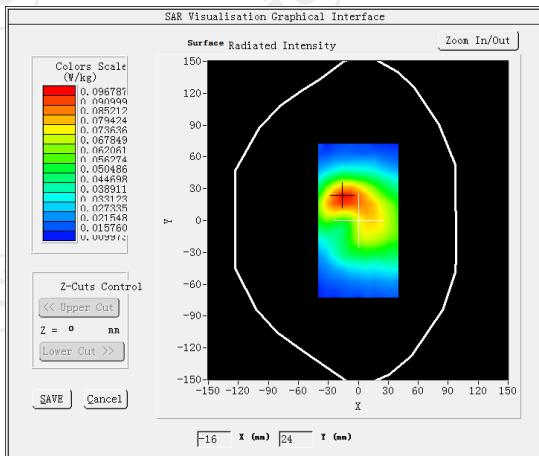

VOLUME SAR

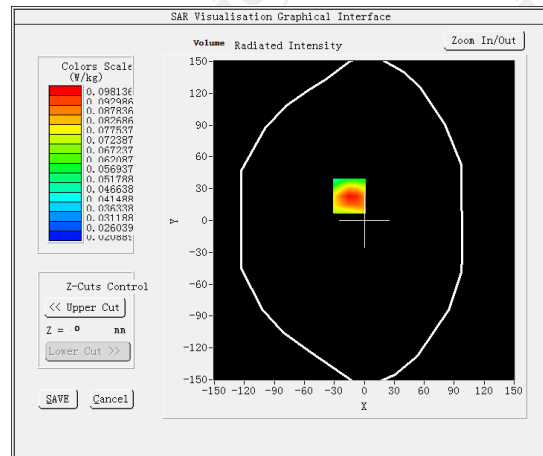

Maximum location: X=-15.00, Y=23.00 SAR Peak: 0.14 W/kg

SAR 10g (W/Kg)

0.063050

SAR 1g (W/Kg)

0.096487

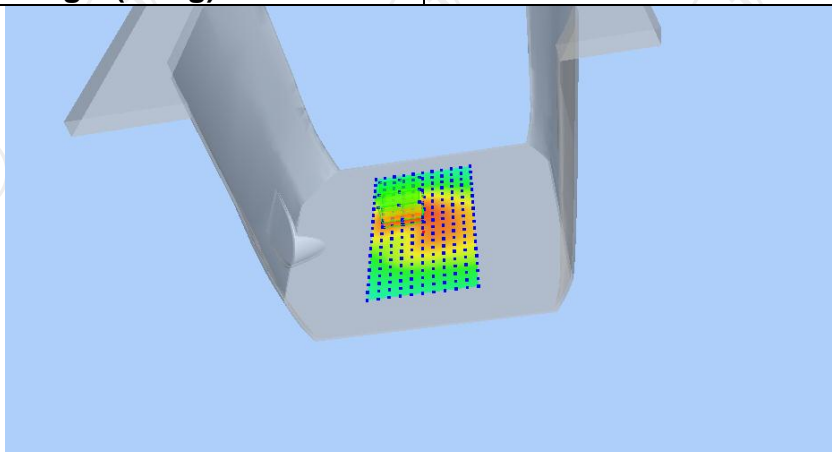

Z (mm)	0.00	4.00	9.00	14.00	19.00
SAR (W/Kg)	0.1355	0.0981	0.0658	0.0455	0.0330

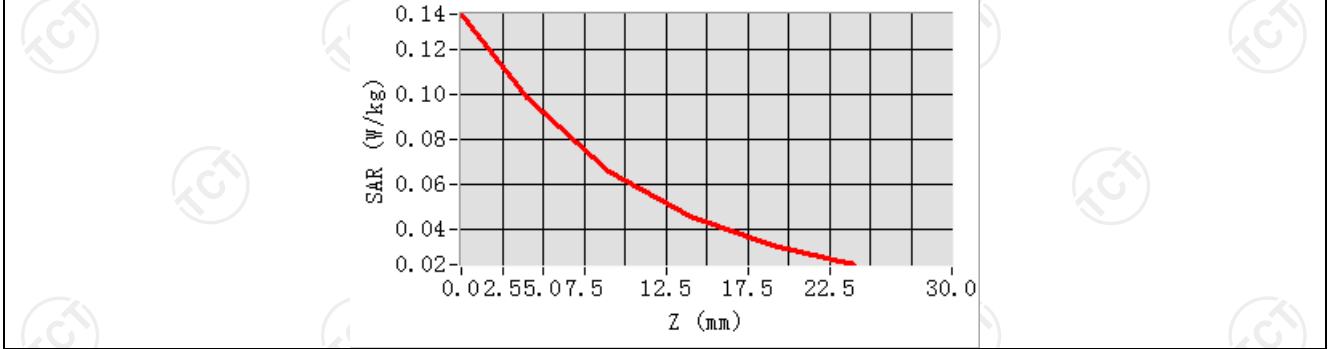

Hot spot position

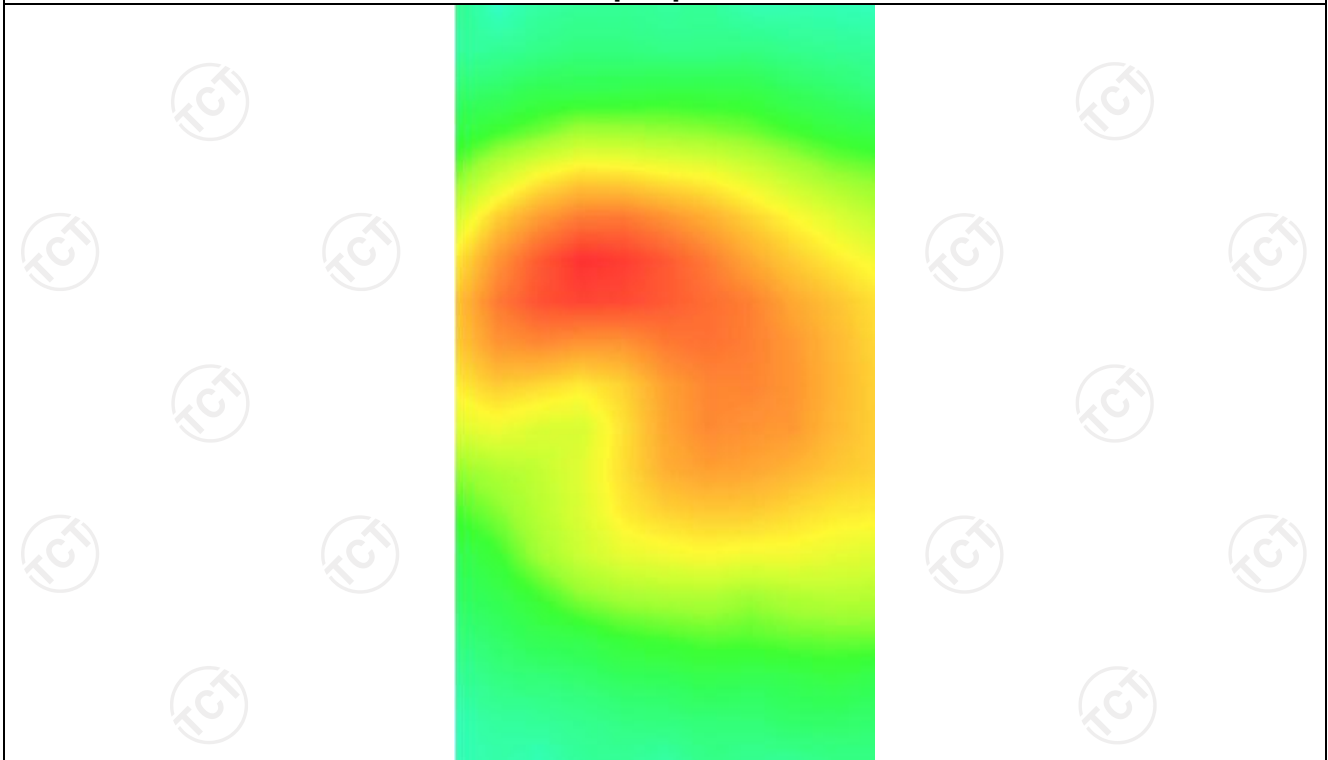

MEASUREMENT 2

High3 Band SAR (Channel 23800):

Date: 11/09/2023

Frequency (MHz)	711.000000
Relative permittivity (real part)	42.113335
Relative permittivity (imaginary part)	23.152000
Conductivity (S/m)	0.913218
Variation (%)	-2.710000
Crest Factor	1.0
Probe Conversion factor	1.71
E-Field Probe:	SSE2 (SN 25/22 EPG0375)
Area Scan	<u>dx=8mm dy=8mm, h= 5.00 mm</u>
ZoomScan	<u>5x5x7,dx=8mm dy=8mm</u> <u>dz=5mm,Complete/ndx=8mm dy=8mm, h=</u> <u>5.00 mm</u>
Phantom	<u>Validation plane</u>
Device Position	<u>Body back(10mm)</u>
Band	<u>LTE band 17(1 RB#24)</u>

SURFACE SAR

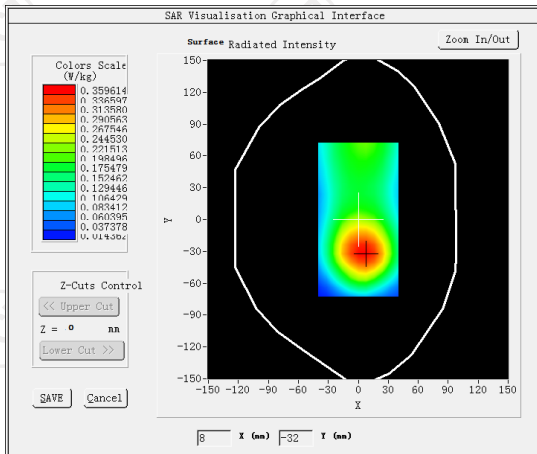

VOLUME SAR

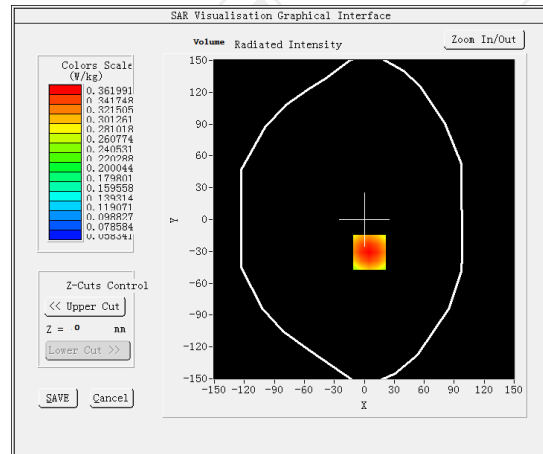

Maximum location: X=5.00, Y=-31.00 SAR Peak: 0.46 W/kg

SAR 10g (W/Kg)

0.247611

SAR 1g (W/Kg)

0.354177

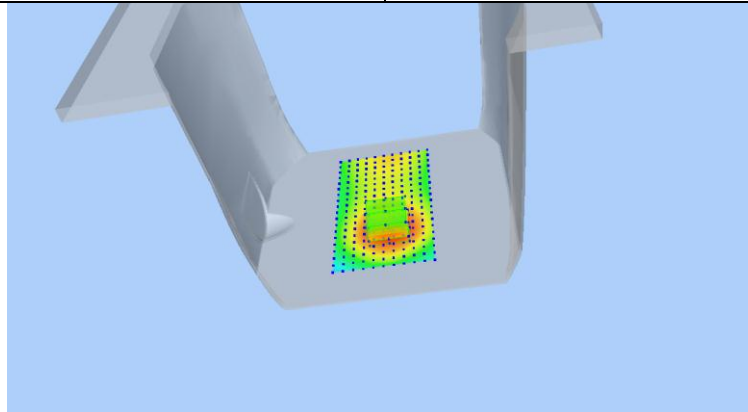

Z (mm)	0.00	4.00	9.00	14.00	19.00
SAR (W/Kg)	0.4643	0.3620	0.2631	0.1905	0.1372

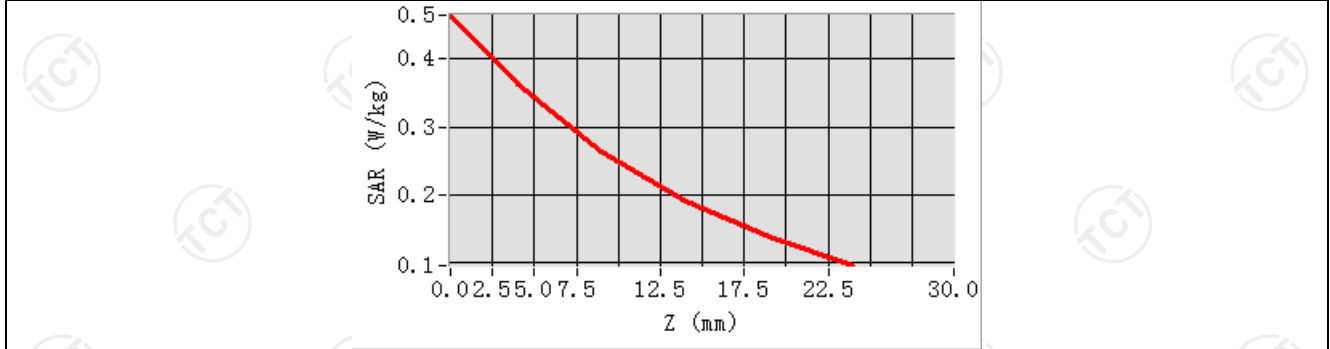

Hot spot position

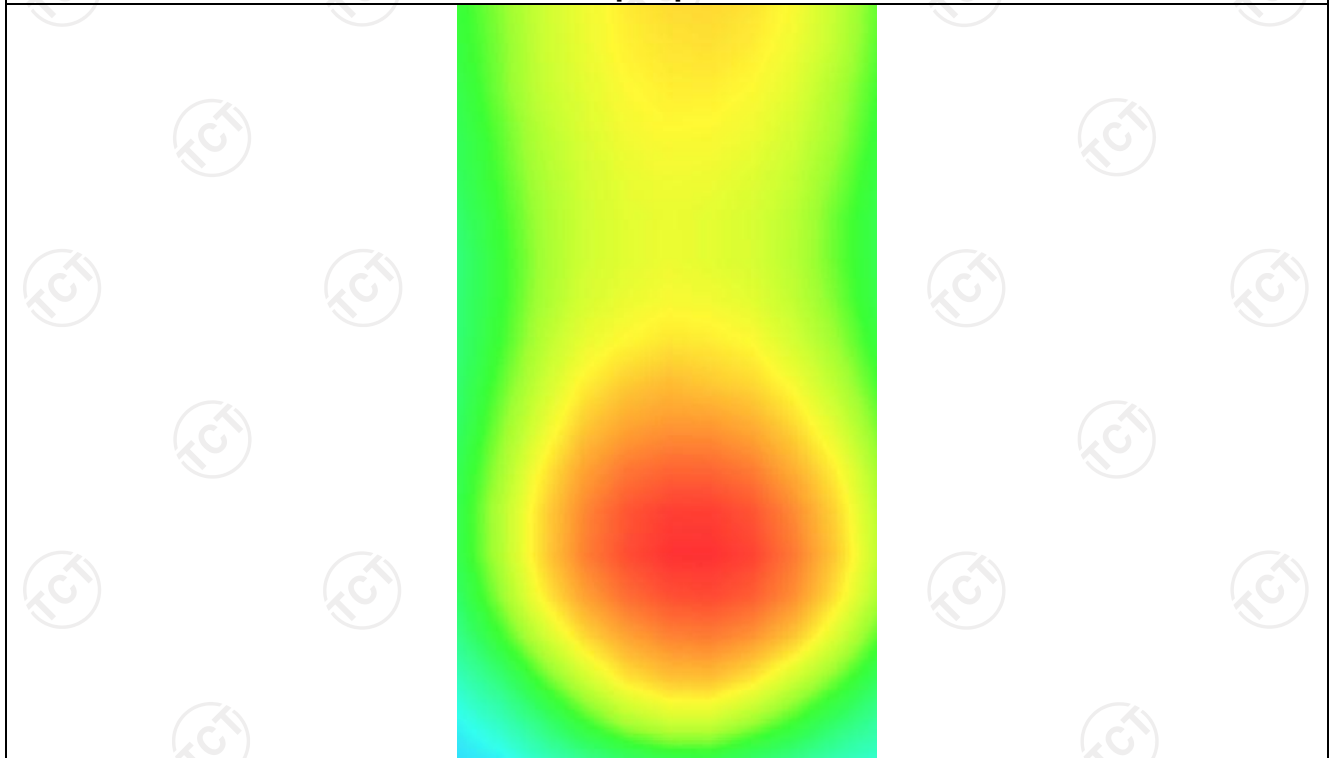

MEASUREMENT 3

High Band SAR (Channel 23800):

Date: 11/09/2023

Frequency (MHz)	711.000000
Relative permittivity (real part)	42.113335
Relative permittivity (imaginary part)	23.152000
Conductivity (S/m)	0.913218
Variation (%)	-2.340000
Crest Factor	1.0
Probe Conversion factor	1.71
E-Field Probe:	SSE2 (SN 25/22 EPG0375)
Area Scan	<u>dx=8mm dy=8mm, h= 5.00 mm</u>
ZoomScan	<u>5x5x7,dx=8mm dy=8mm</u> <u>dz=5mm,Complete/ndx=8mm dy=8mm, h=</u> <u>5.00 mm</u>
Phantom	<u>Validation plane</u>
Device Position	<u>Body back(hotspot 10mm)</u>
Band	<u>LTE band 17(1 RB#24)</u>

SURFACE SAR

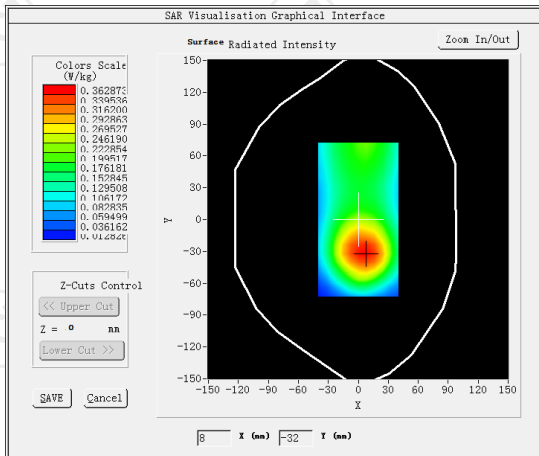

VOLUME SAR

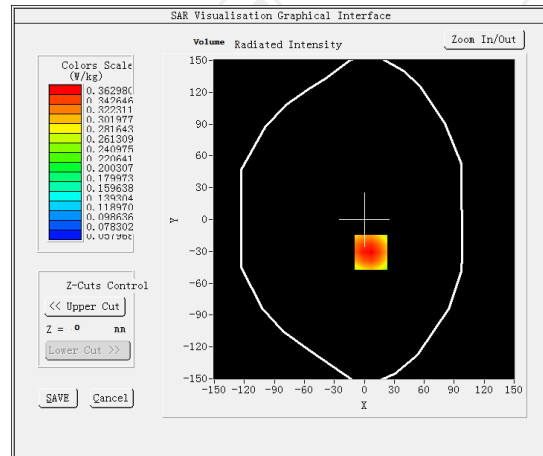

Maximum location: X=7.00, Y=-31.00 SAR Peak: 0.46 W/kg

SAR 10g (W/Kg)

0.249273

SAR 1g (W/Kg)

0.355913

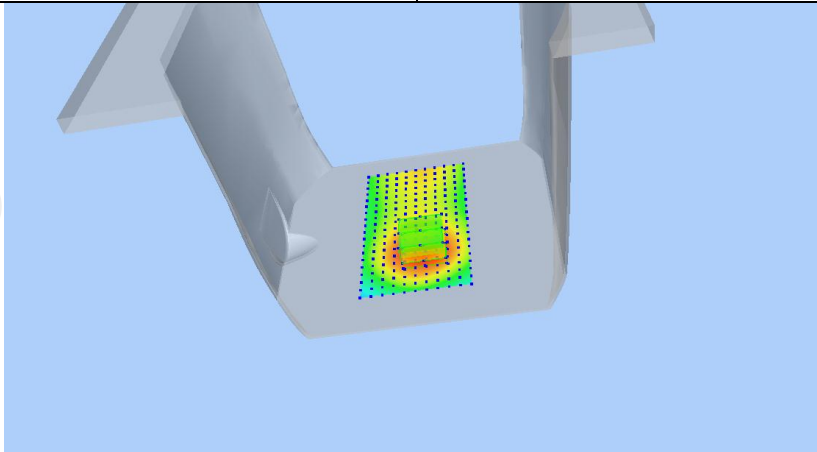

Z (mm)	0.00	4.00	9.00	14.00	19.00
SAR (W/Kg)	0.4625	0.3630	0.2654	0.1924	0.1379

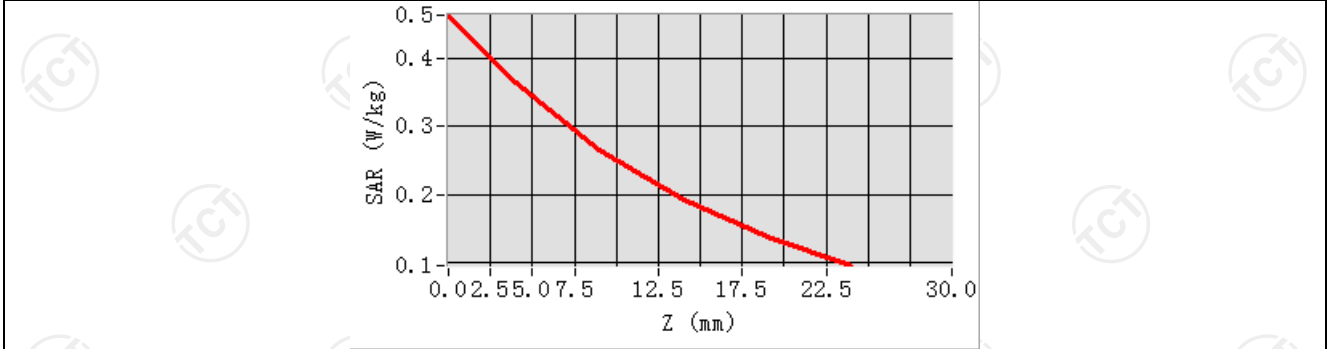

Hot spot position

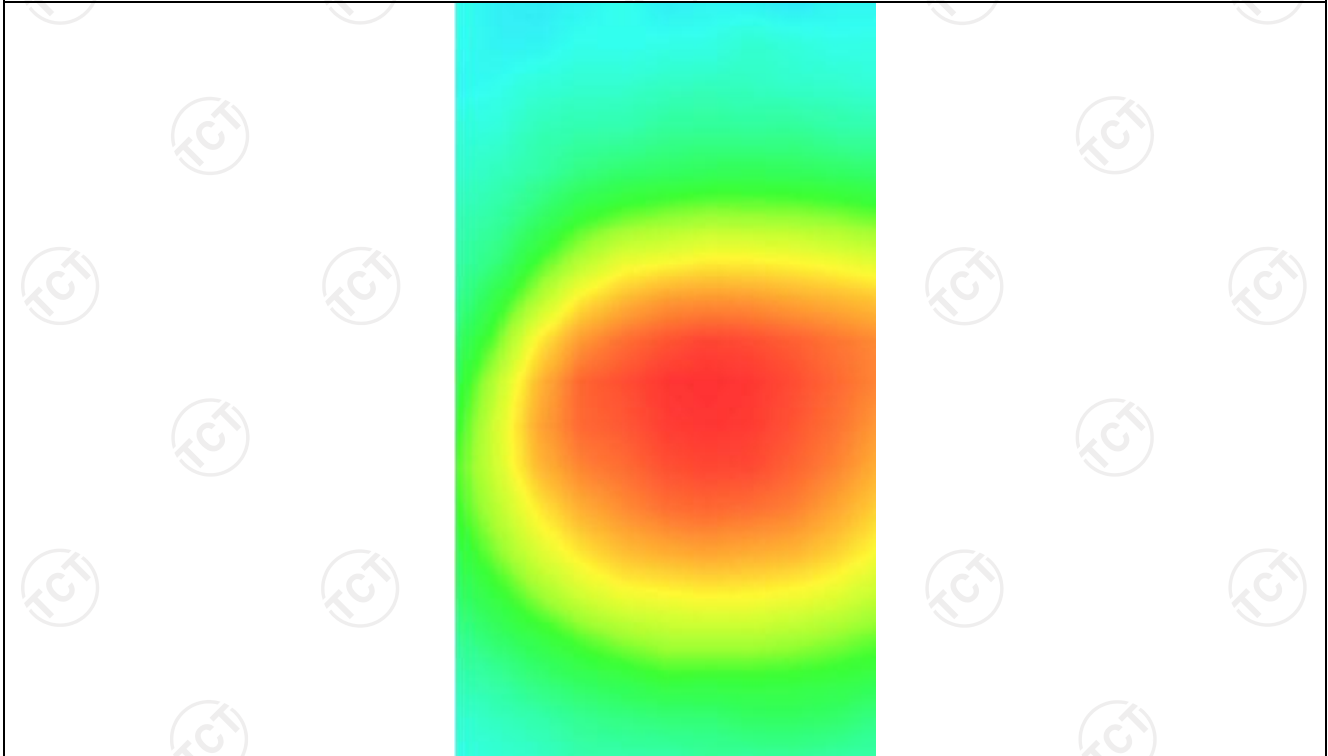

LTE Band 41

MEASUREMENT 1

Low Band SAR (Channel 39750):

Date: 11/30/2023

Frequency (MHz)	2506.000000
Relative permittivity (real part)	39.009335
Relative permittivity (imaginary part)	13.553667
Conductivity (S/m)	1.952481
Variation (%)	0.490000
Crest Factor	1.0
Probe Conversion factor	4.36
E-Field Probe:	SSE2 (SN 25/22 EPGO375)
Area Scan	<u>dx=8mm dy=8mm, h= 5.00 mm</u>
ZoomScan	<u>5x5x7, dx=8mm dy=8mm</u> <u>dz=5mm, Complete/ndx=8mm dy=8mm, h=</u> <u>5.00 mm</u>
Phantom	Validation plane
Device Position	Body Front(10mm)
Band	<u>LTE band 41(1 RB#49)</u>

SURFACE SAR

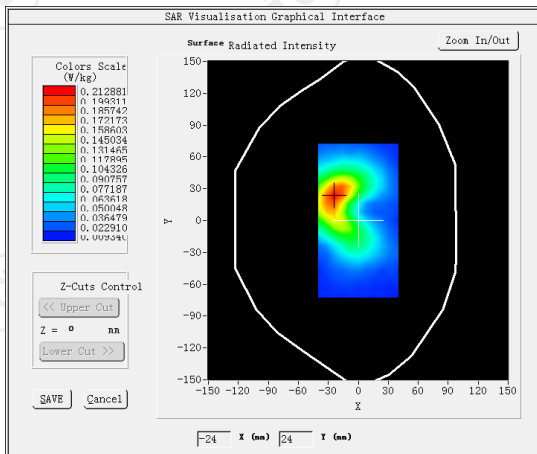

VOLUME SAR

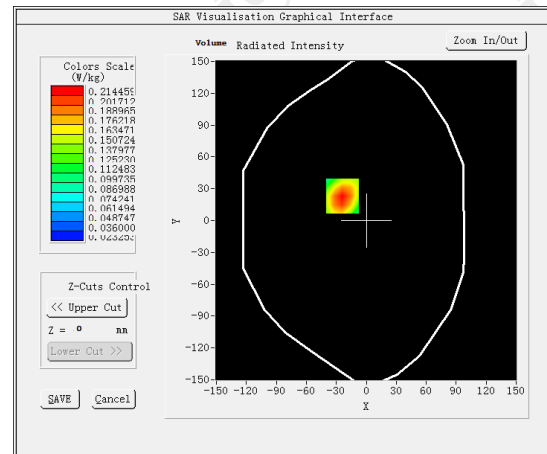

Maximum location: X=-24.00, Y=23.00 SAR Peak: 0.30 W/kg

SAR 10g (W/Kg)

0.128515

SAR 1g (W/Kg)

0.203815

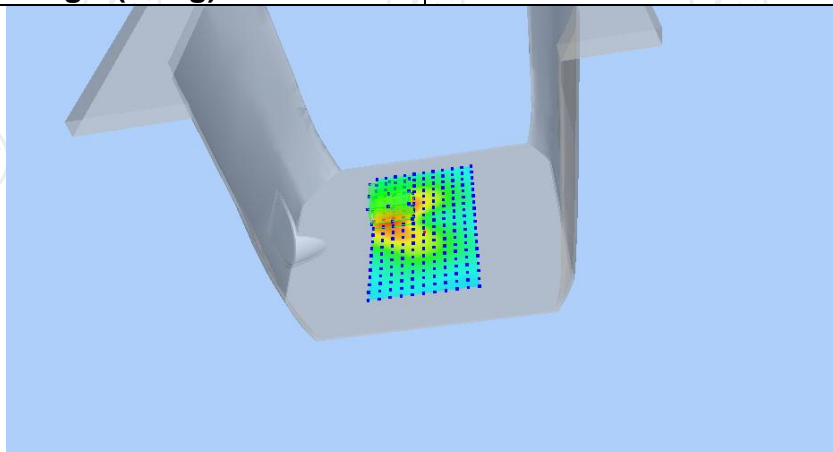

Z (mm)	0.00	4.00	9.00	14.00	19.00
SAR (W/Kg)	0.3017	0.2145	0.1399	0.0936	0.0655

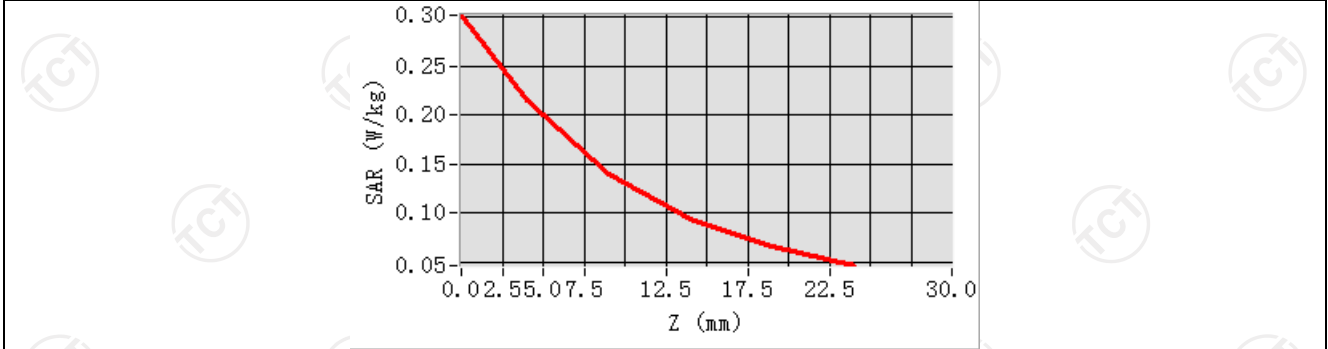

Hot spot position

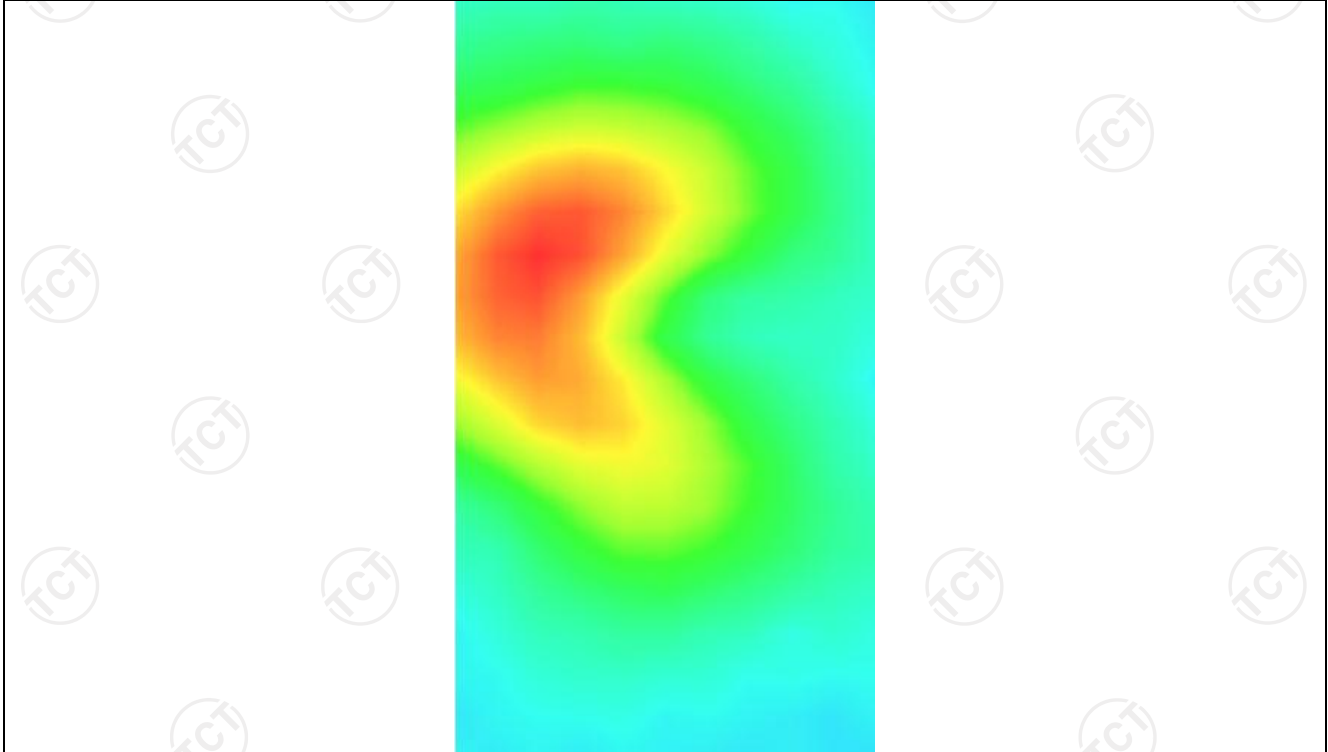

MEASUREMENT 2

Low Band SAR (Channel 39750):

Date: 11/30/2023

Frequency (MHz)	2506.000000
Relative permittivity (real part)	39.009335
Relative permittivity (imaginary part)	13.553667
Conductivity (S/m)	1.952481
Variation (%)	-4.550000
Crest Factor	1.0
Probe Conversion factor	4.36
E-Field Probe:	SSE2 (SN 25/22 EPG0375)
Area Scan	<u>dx=8mm dy=8mm, h= 5.00 mm</u>
ZoomScan	<u>5x5x7, dx=8mm dy=8mm</u> <u>dz=5mm, Complete/ndx=8mm dy=8mm, h=</u> <u>5.00 mm</u>
Phantom	Validation plane
Device Position	Body back(10mm)
Band	<u>LTE band 41(1 RB#49)</u>

SURFACE SAR

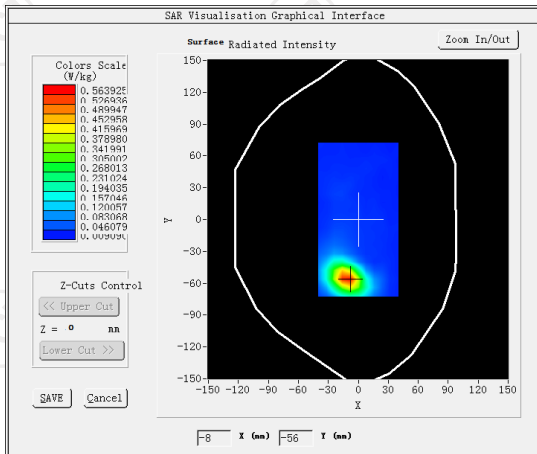

VOLUME SAR

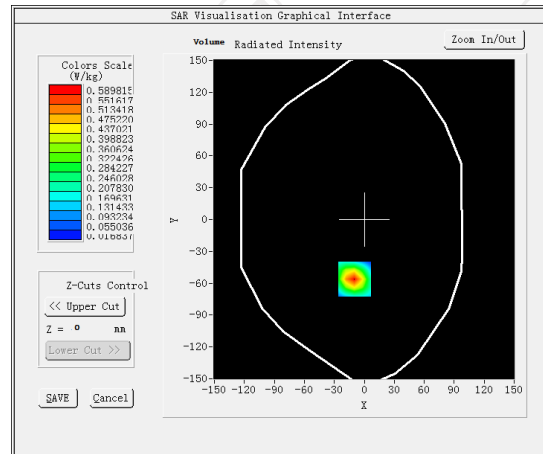

Maximum location: X=-10.00, Y=-56.00 SAR Peak: 0.95 W/kg

SAR 10g (W/Kg)	0.261172
SAR 1g (W/Kg)	0.536813

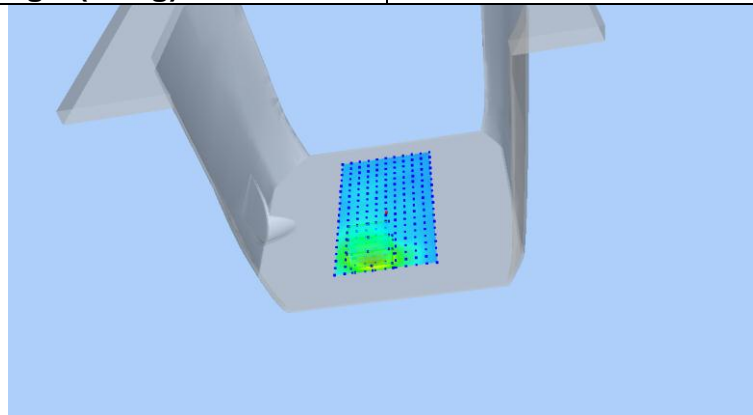

Z (mm)	0.00	4.00	9.00	14.00	19.00
SAR (W/Kg)	0.9465	0.5898	0.3162	0.1700	0.0961

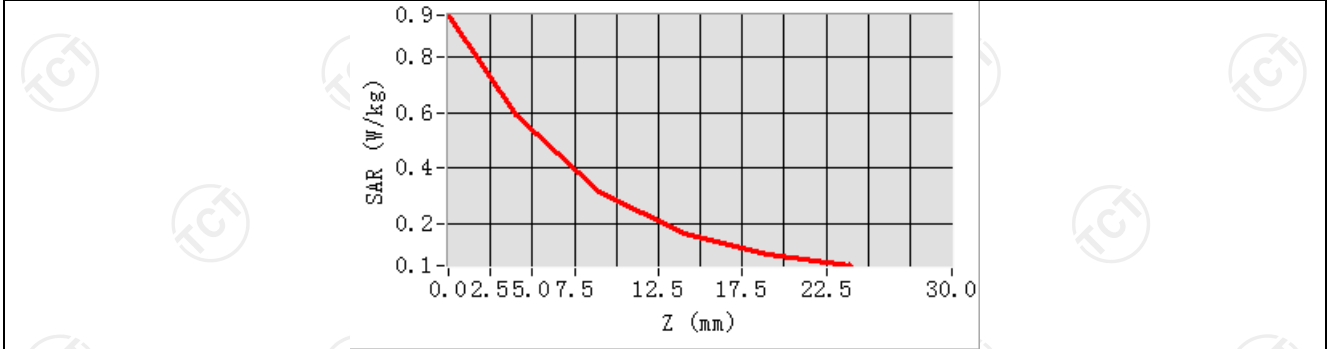

Hot spot position

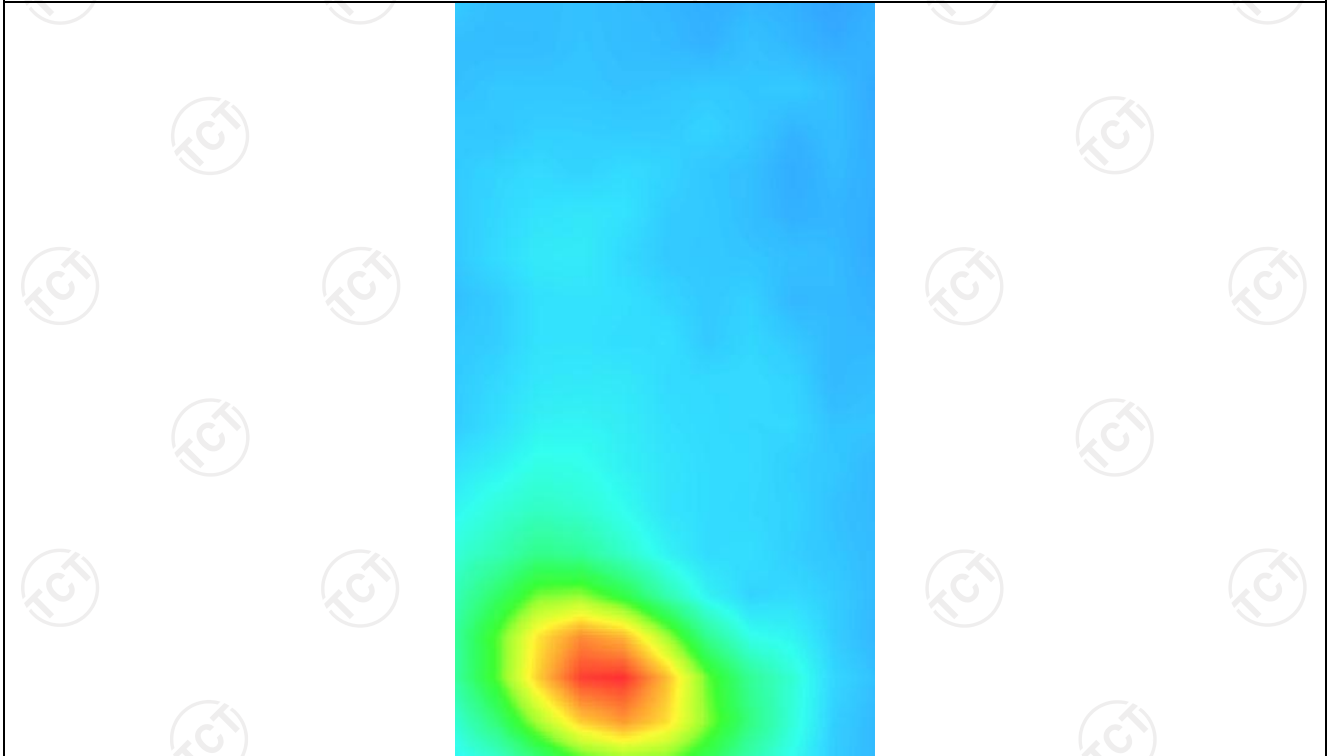

MEASUREMENT 3

Low Band SAR (Channel 39750):

Date: 11/30/2023

Frequency (MHz)	2506.000000
Relative permittivity (real part)	39.009335
Relative permittivity (imaginary part)	13.553667
Conductivity (S/m)	1.952481
Variation (%)	-3.390000
Crest Factor	1.0
Probe Conversion factor	4.36
E-Field Probe:	SSE2 (SN 25/22 EPG0375)
Area Scan	<u>dx=8mm dy=8mm, h= 5.00 mm</u>
ZoomScan	<u>5x5x7,dx=8mm dy=8mm</u> <u>dz=5mm,Complete/ndx=8mm dy=8mm, h=</u> <u>5.00 mm</u>
Phantom	Validation plane
Device Position	Body back(hotspot 10mm)
Band	<u>LTE band 41(1 RB#49)</u>

SURFACE SAR

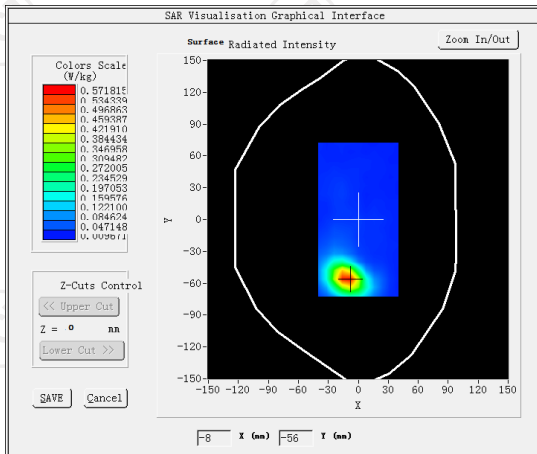

VOLUME SAR

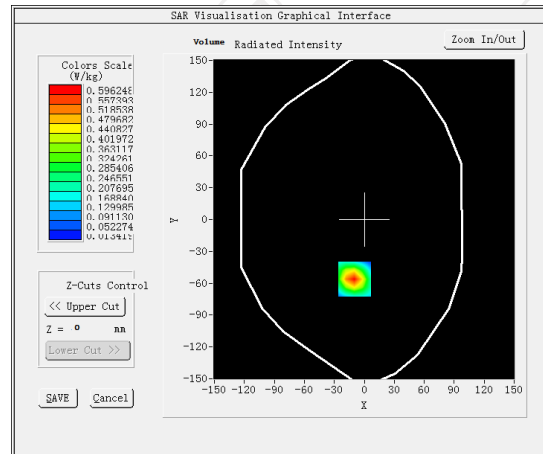

Maximum location: X=-10.00, Y=-56.00 SAR Peak: 0.96 W/kg

SAR 10g (W/Kg)

0.265279

SAR 1g (W/Kg)

0.543186

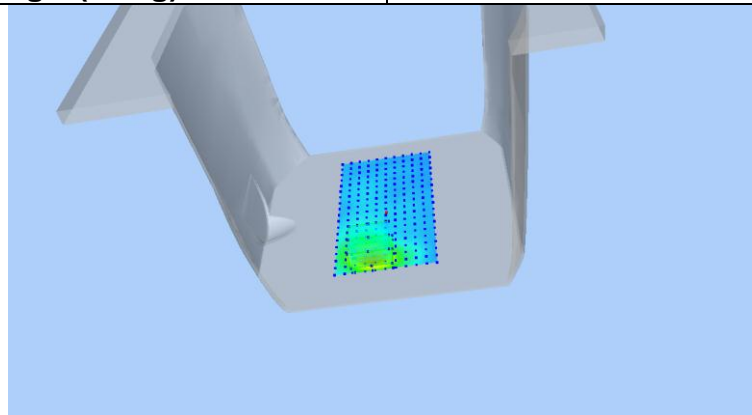

Z (mm)	0.00	4.00	9.00	14.00	19.00
SAR (W/Kg)	0.9537	0.5962	0.3212	0.1735	0.0984

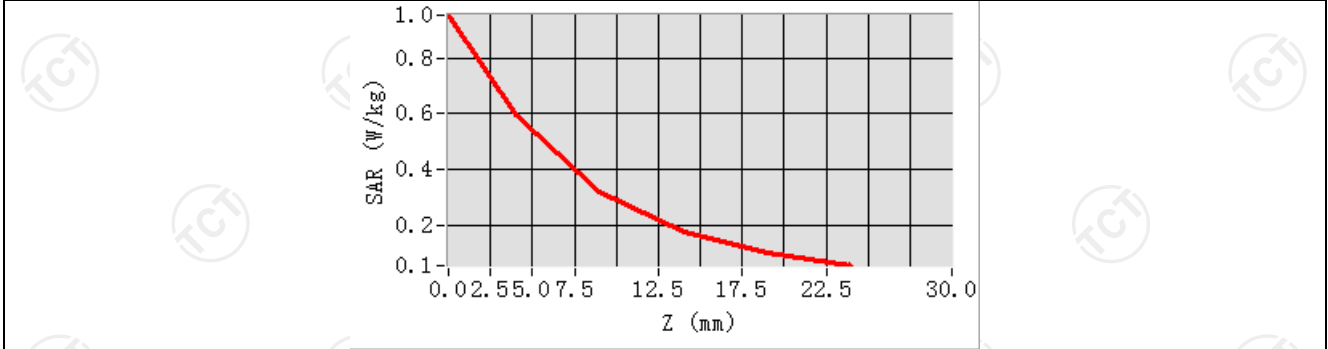

Hot spot position

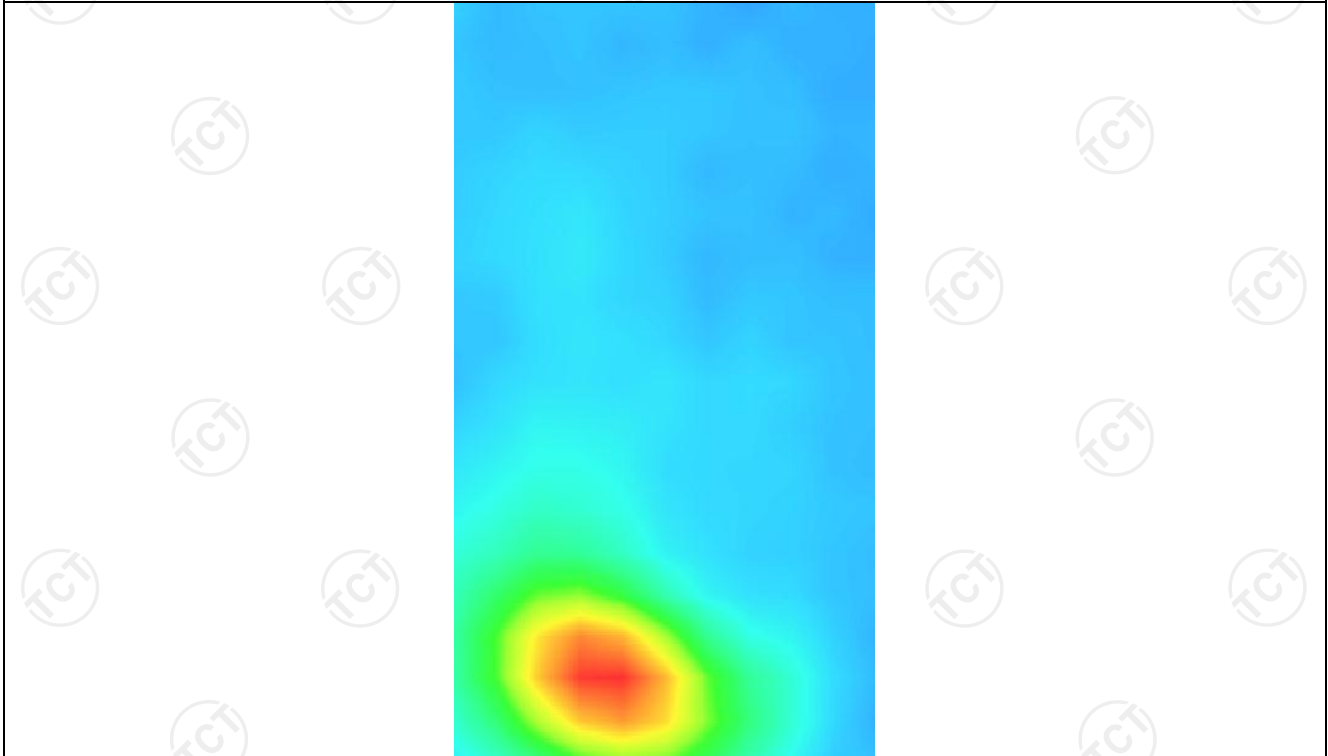

WLAN 2.4G

MEASUREMENT 1

High Band SAR (Channel 11):

Date: 11/27/2023

Frequency (MHz)	2462.000000
Relative permittivity (real part)	37.821613
Relative permittivity (imaginary part)	13.546980
Conductivity (S/m)	1.834111
Variation (%)	1.820000
Crest Factor	1.0
Probe Conversion factor	2.31
E-Field Probe:	SSE2 (SN 25/22 EPGO375)
Area Scan	<u>dx=8mm dy=8mm, h= 5.00 mm</u>
ZoomScan	<u>5x5x7, dx=8mm dy=8mm</u> <u>dz=5mm, Complete/ndx=8mm dy=8mm, h=</u> <u>5.00 mm</u>
Phantom	Validation plane
Device Position	Body front(10mm)
Band	<u>IEEE 802.11b ISM</u>

SURFACE SAR

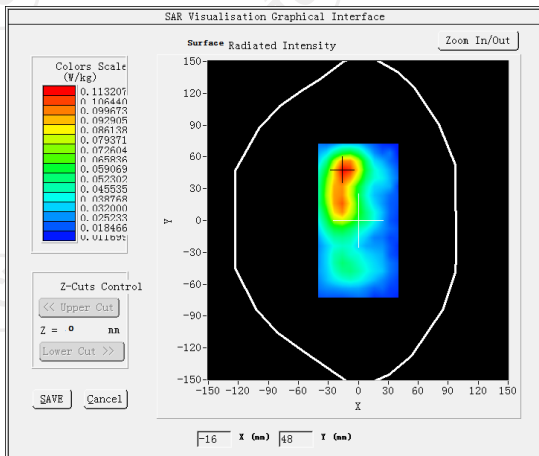

VOLUME SAR

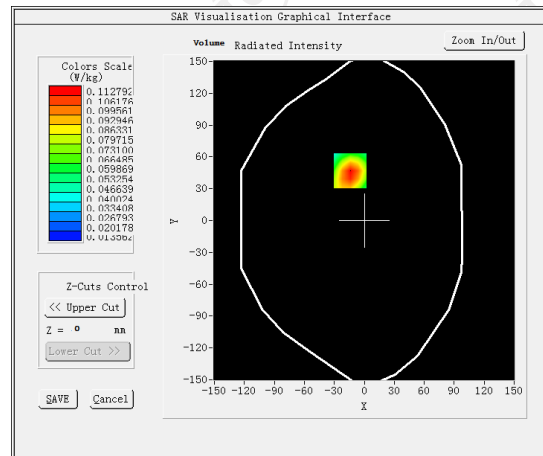

Maximum location: X=-14.00, Y=47.00 SAR Peak: 0.17 W/kg

SAR 10g (W/Kg)

0.072991

SAR 1g (W/Kg)

0.127566

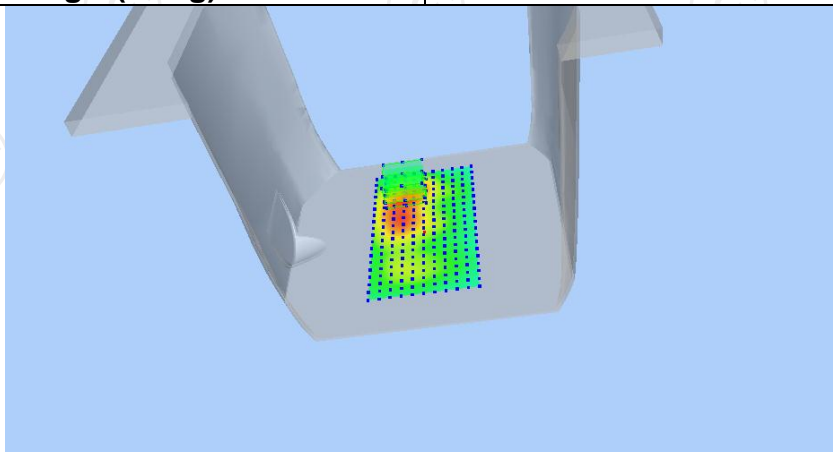

Z (mm)	0.00	4.00	9.00	14.00	19.00
SAR (W/Kg)	0.1726	0.1128	0.0659	0.0401	0.0268

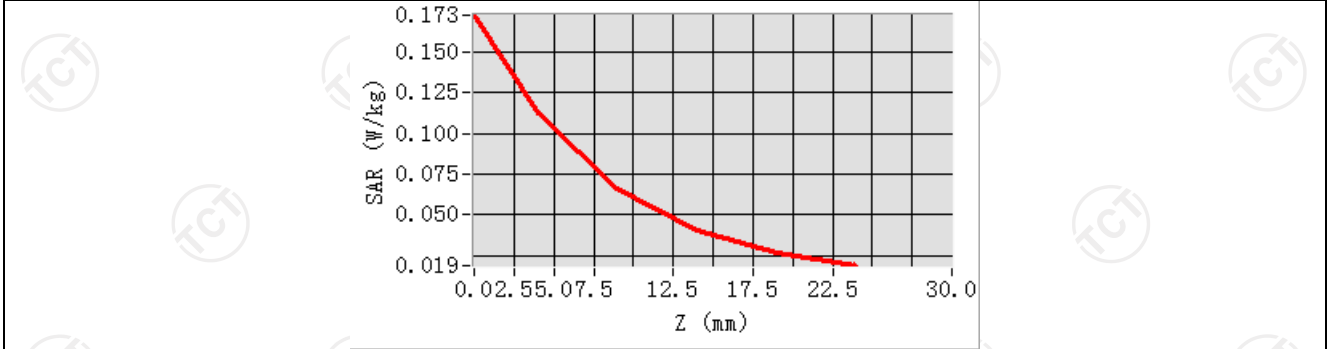

Hot spot position

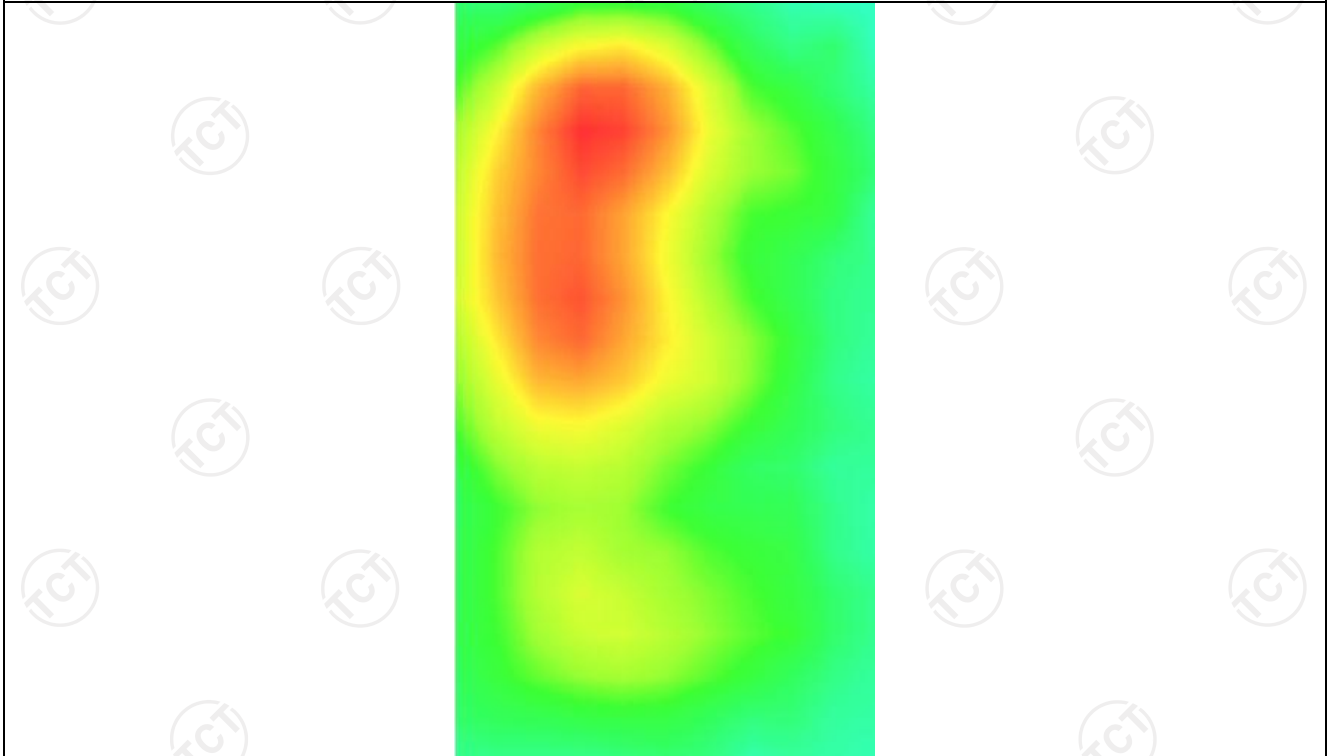

MEASUREMENT 2

High Band SAR (Channel 11):

Date: 11/27/2023

Frequency (MHz)	2462.000000
Relative permittivity (real part)	37.821613
Relative permittivity (imaginary part)	13.546980
Conductivity (S/m)	1.834111
Variation (%)	1.580000
Crest Factor	1.0
Probe Conversion factor	2.31
E-Field Probe:	SSE2 (SN 25/22 EPG0375)
Area Scan	<u>dx=12mm dy=12mm, h= 5.00 mm</u>
ZoomScan	<u>5x5x7,dx=5mm dy=5mm</u> <u>dz=5mm,Complete/ndx=8mm dy=8mm, h=</u> <u>5.00 mm</u>
Phantom	Validation plane
Device Position	Body back(10mm)
Band	IEEE 802.11b ISM

SURFACE SAR

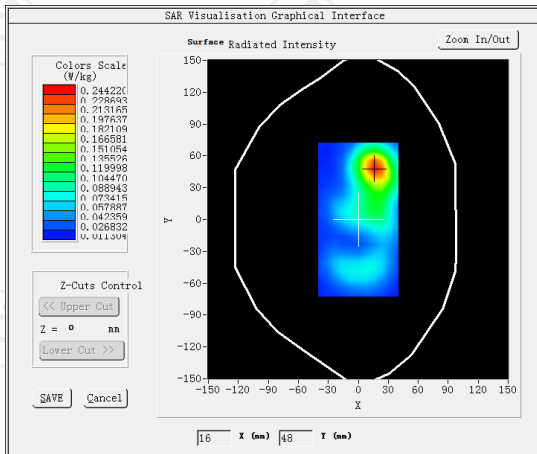

VOLUME SAR

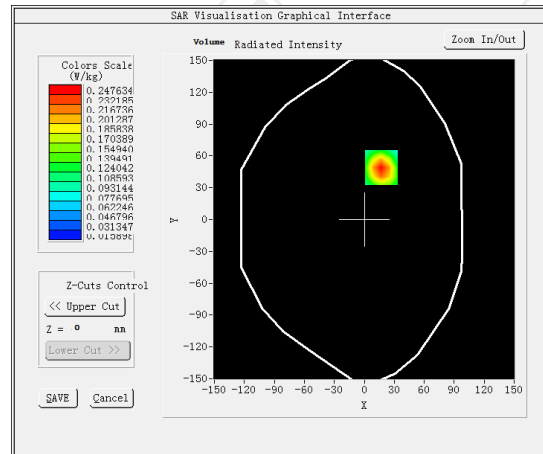

Maximum location: X=17.00, Y=49.00 SAR Peak: 0.39 W/kg

SAR 10g (W/Kg)	0.141003
SAR 1g (W/Kg)	0.310036

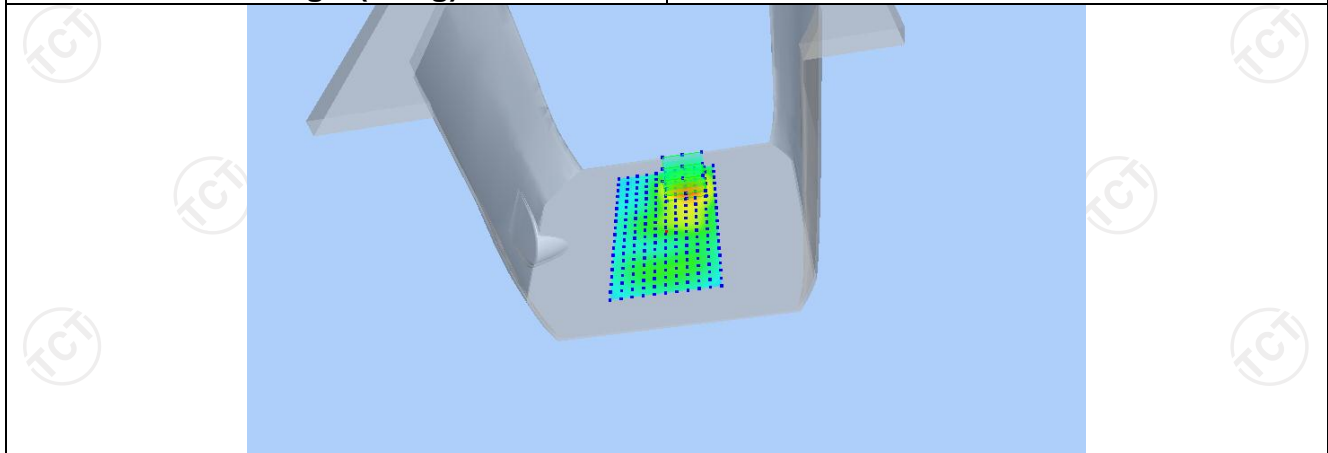

Z (mm)	0.00	4.00	9.00	14.00	19.00
SAR (W/Kg)	0.3901	0.2476	0.1376	0.0785	0.0484

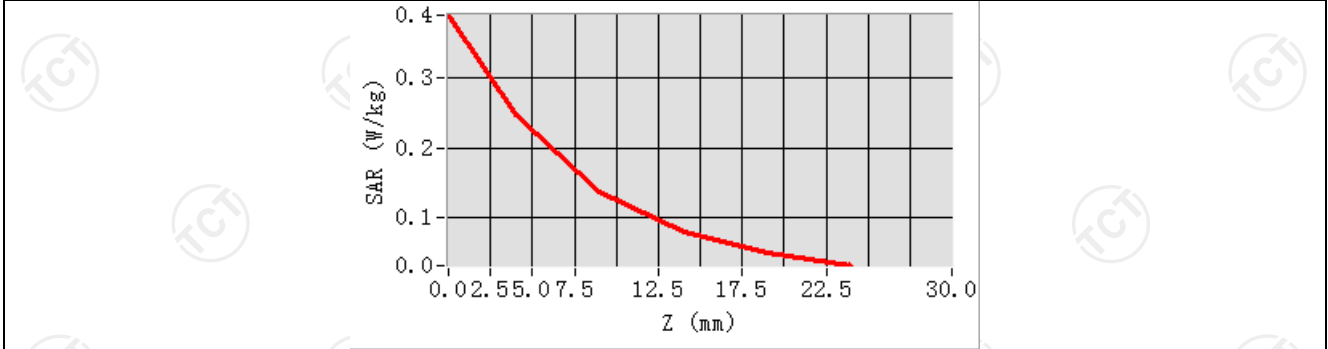

Hot spot position

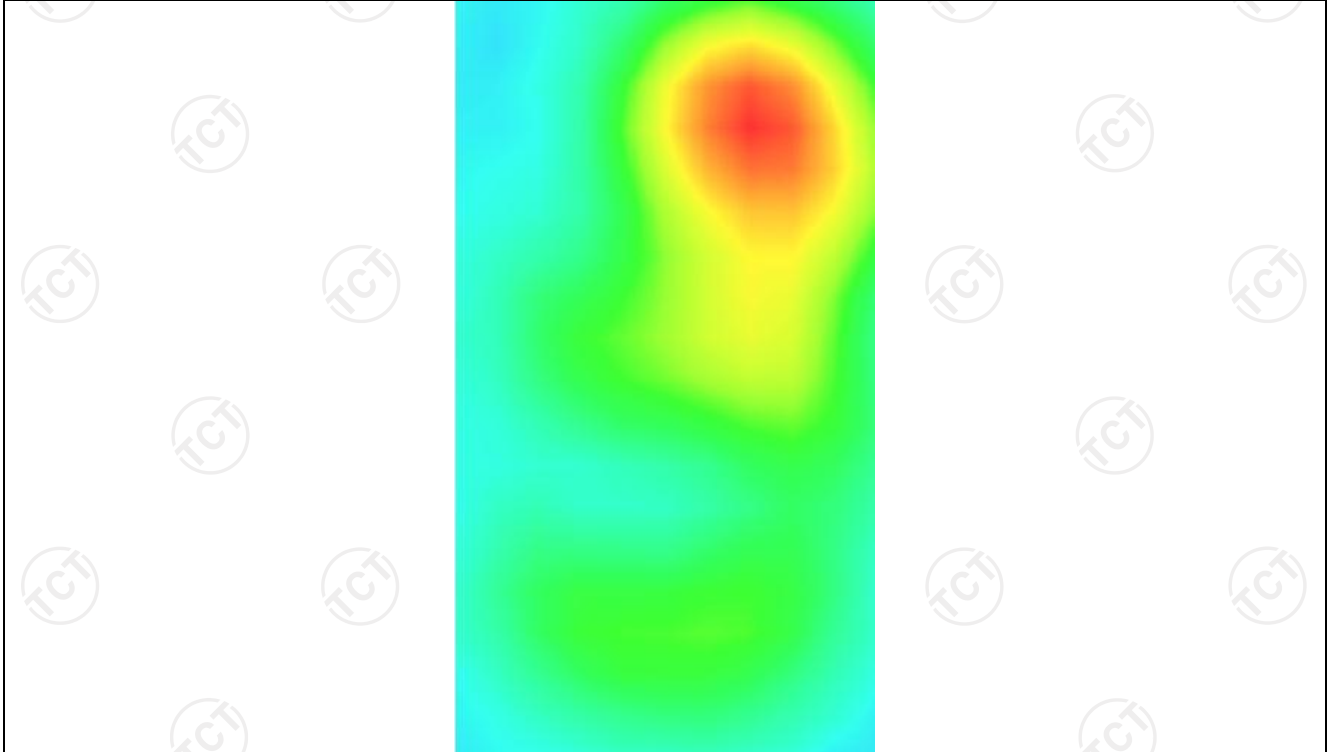

MEASUREMENT 3

High Band SAR (Channel 11):

Date: 11/27/2023

Frequency (MHz)	2462.000000
Relative permittivity (real part)	37.821613
Relative permittivity (imaginary part)	13.546980
Conductivity (S/m)	1.834111
Variation (%)	2.310000
Crest Factor	1.0
Probe Conversion factor	2.31
E-Field Probe:	SSE2 (SN 36/20 EPGO346)
Area Scan	<u>dx=8mm dy=8mm, h= 5.00 mm</u>
ZoomScan	<u>5x5x7,dx=8mm dy=8mm</u> <u>dz=5mm,Complete/ndx=8mm dy=8mm, h=</u> <u>5.00 mm</u>
Phantom	Validation plane
Device Position	Body back(10mm)
Band	<u>IEEE 802.11b ISM(hotspot)</u>

SURFACE SAR

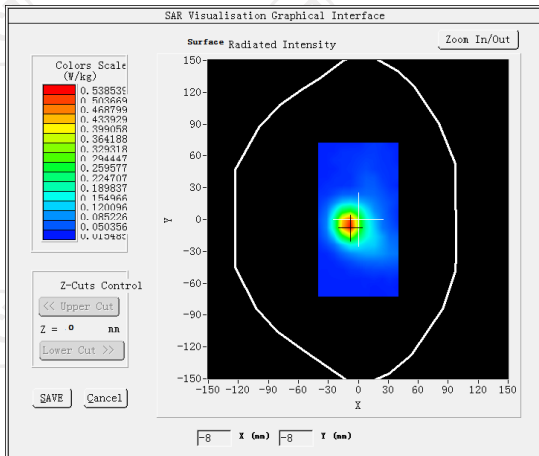

VOLUME SAR

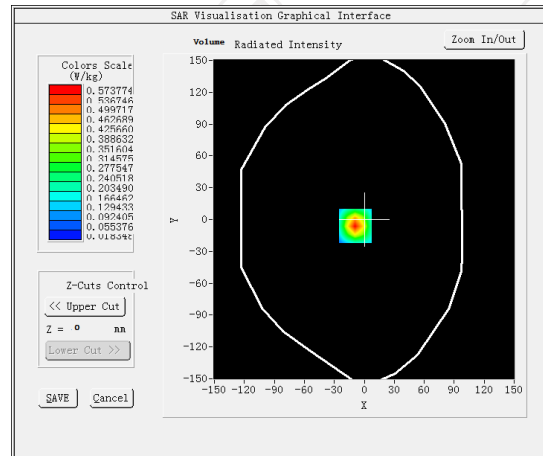

Maximum location: X=-14.00, Y=55.00 SAR Peak: 0.37 W/kg

SAR 10g (W/Kg)	0.135130
SAR 1g (W/Kg)	0.306190

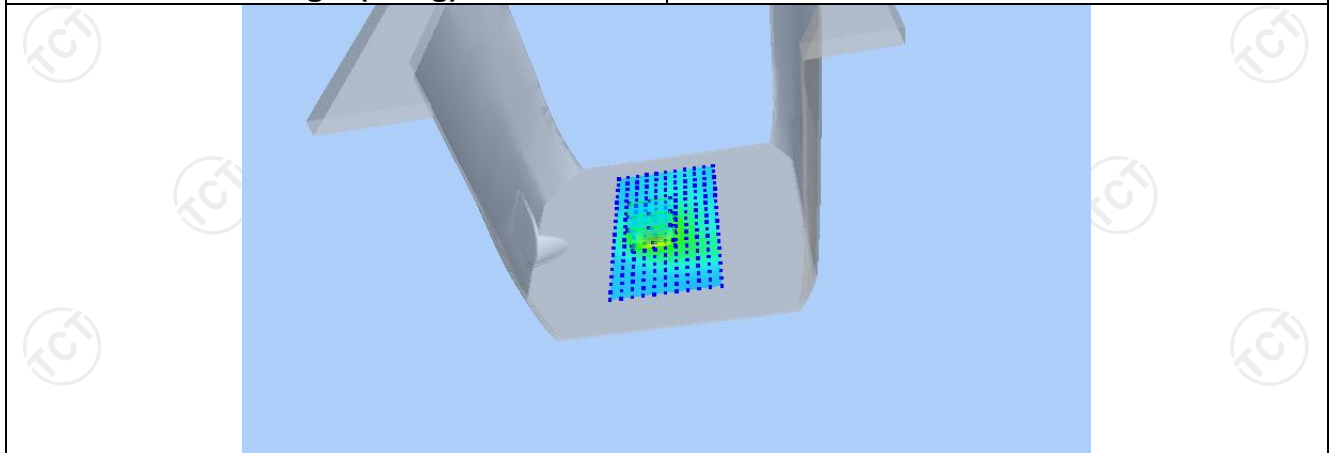

Z (mm)	0.00	4.00	9.00	14.00	19.00
SAR (W/Kg)	1.1857	0.5738	0.2014	0.0679	0.0308

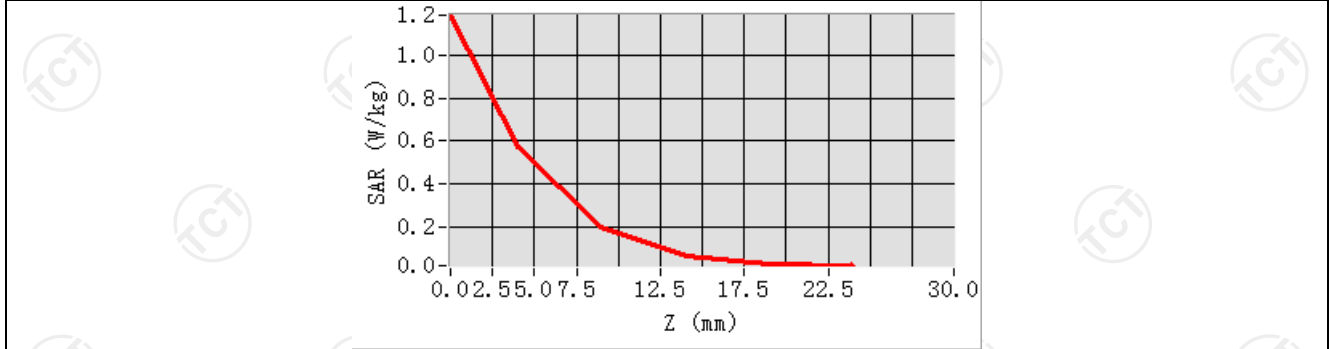

Hot spot position

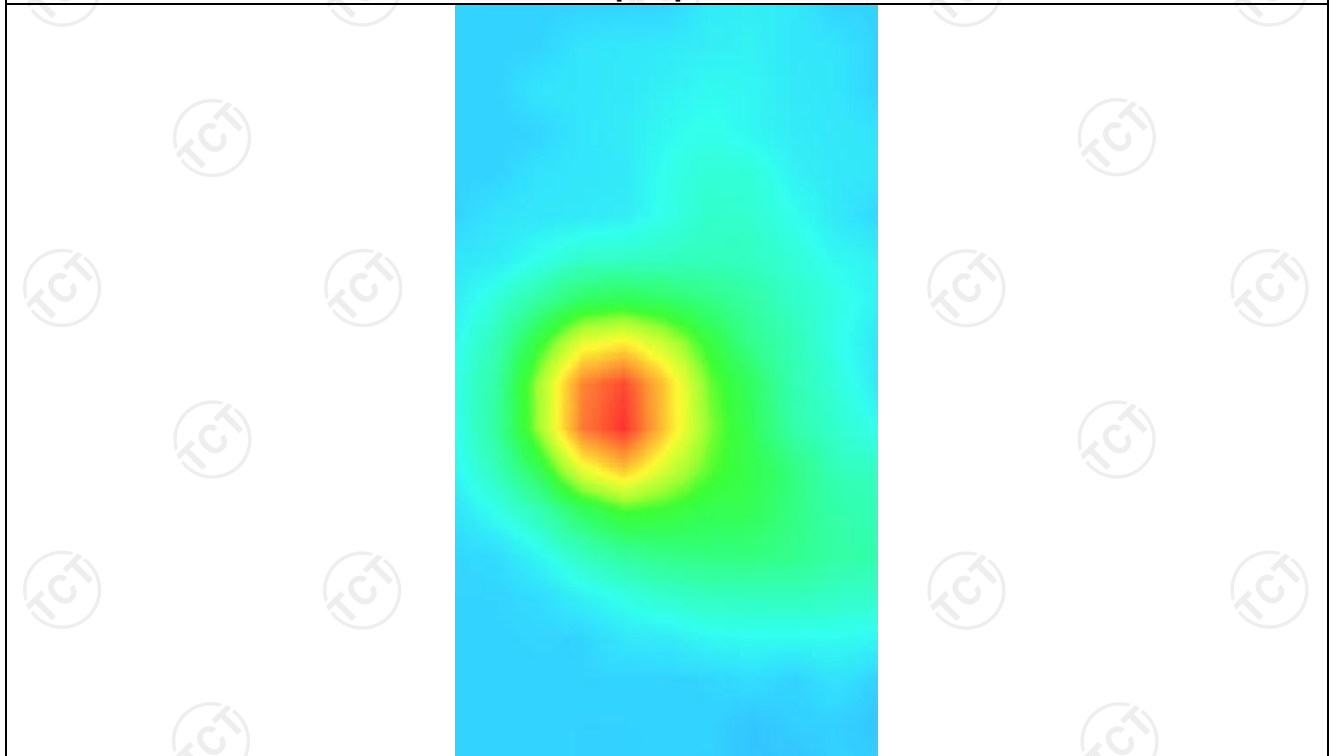

WLAN 5.2G

MEASUREMENT 1

SAR (Channel 46):

Date: 12/01/2023

Frequency (MHz)	5230.000000
Relative permittivity (real part)	35.068832
Relative permittivity (imaginary part)	13.679428
Conductivity (S/m)	5.220788
Variation (%)	-2.100000
Crest Factor	1.0
Probe Conversion factor	2.01
E-Field Probe:	SSE2 (SN 25/22 EPGO375)
Area Scan	<u>dx=10mm dy=10mm, h= 5.00 mm</u>
ZoomScan	<u>5x5x7,dx=4mm dy=4mm</u> <u>dz=2mm,Complete/ndx=8mm dy=8mm, h=</u> <u>5.00 mm</u>
Phantom	Validation plane
Device Position	Body front(10mm)
Band	<u>IEEE 802.11n HT40 ISM</u>

SURFACE SAR

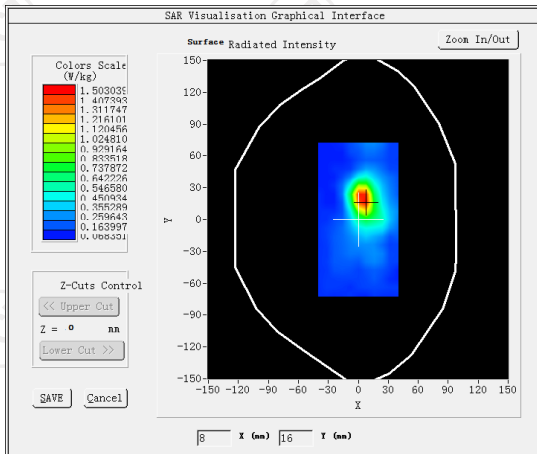

VOLUME SAR

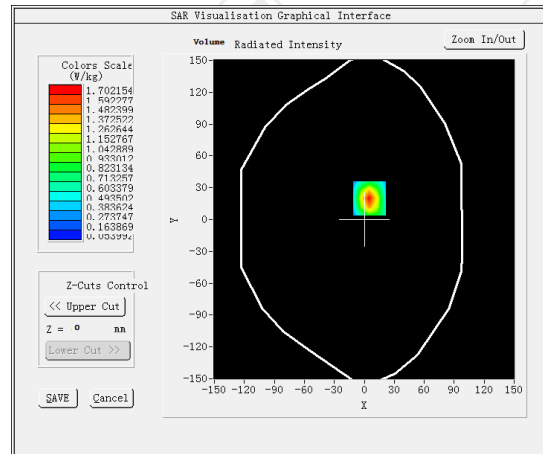

Maximum location: X=15.00, Y=21.00 SAR Peak: 0.93 W/kg

SAR 10g (W/Kg)	0.140821
SAR 1g (W/Kg)	0.161250

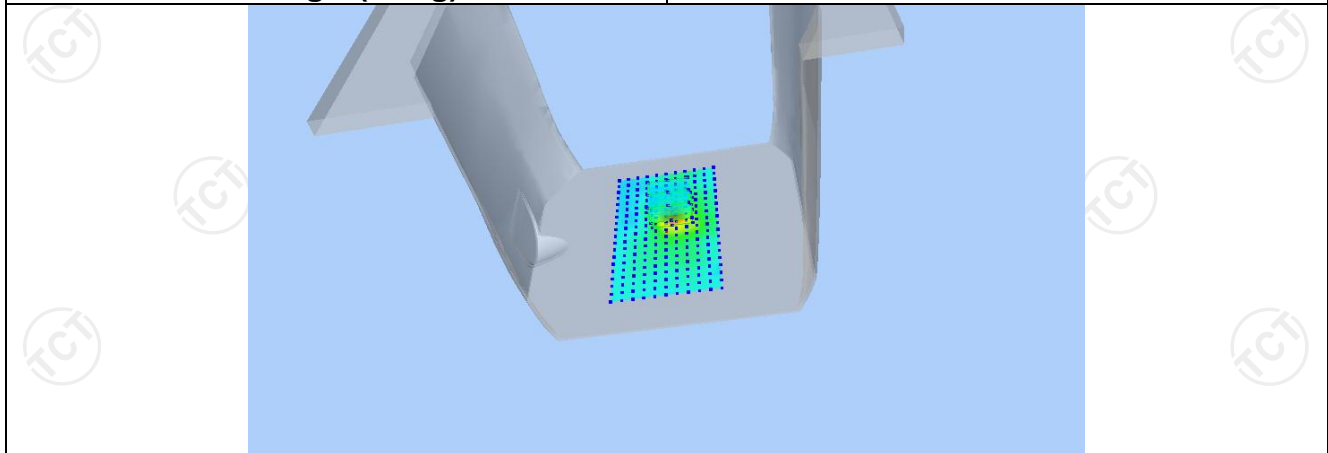

Z (mm)	0.00	2.00	7.00	12.00	17.00
SAR (W/Kg)	0.9068	0.5742	0.1505	0.0398	0.0276

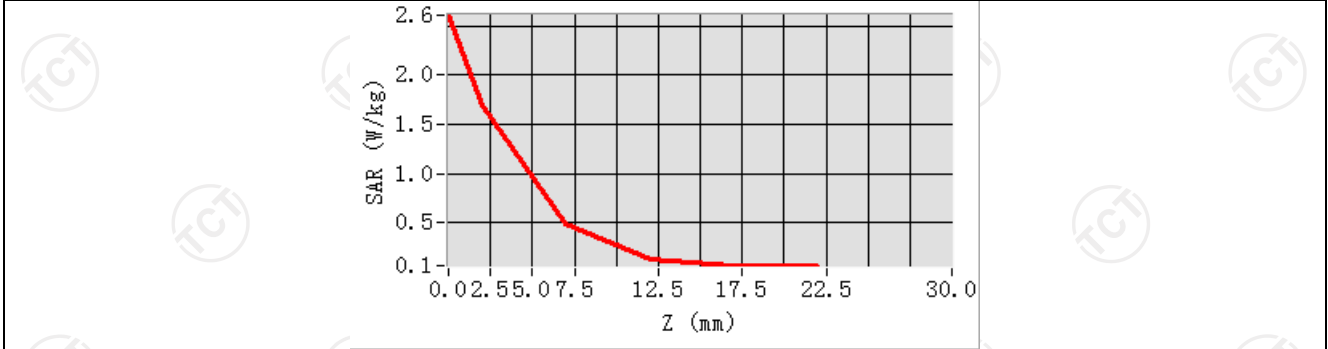

Hot spot position

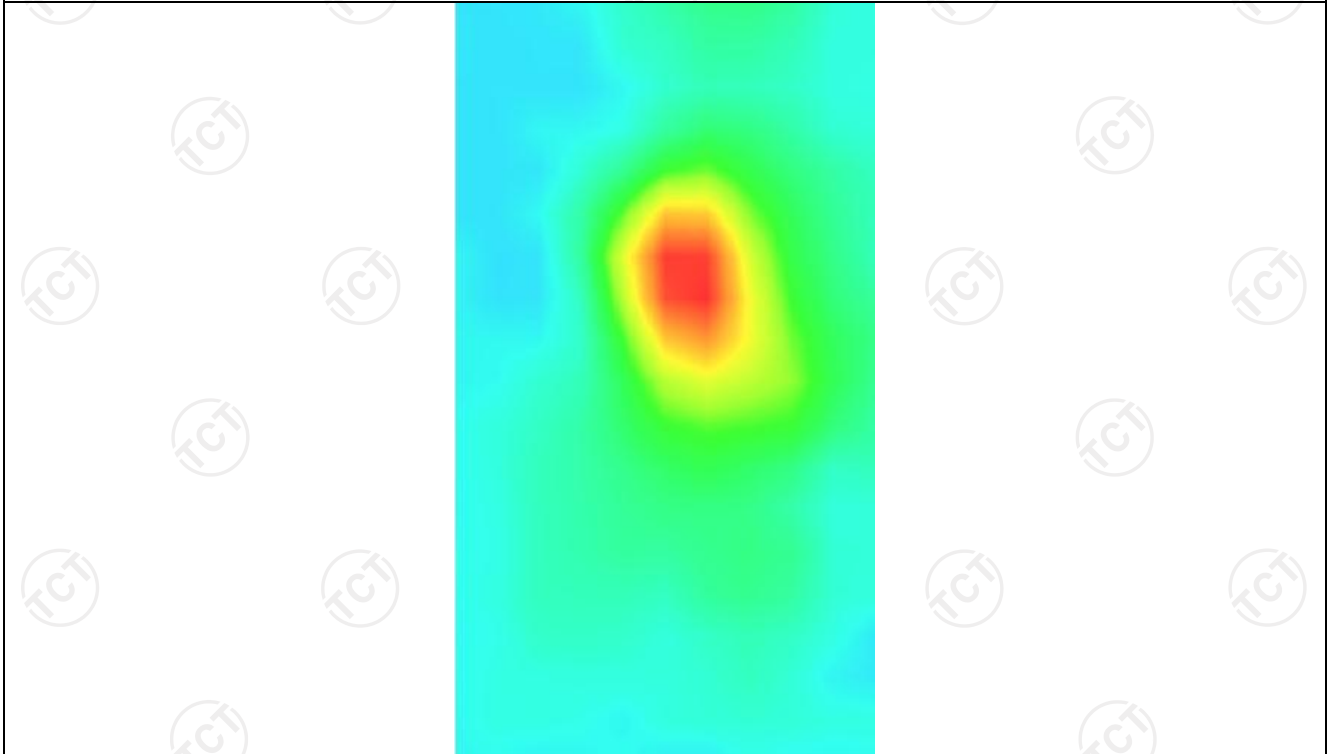

MEASUREMENT 2

SAR (Channel 46):

Date: 12/01/2023

Frequency (MHz)	5230.000000
Relative permittivity (real part)	35.068832
Relative permittivity (imaginary part)	13.679428
Conductivity (S/m)	5.220788
Variation (%)	3.640000
Crest Factor	1.0
Probe Conversion factor	2.01
E-Field Probe:	SSE2 (SN 25/22 EPG0375)
Area Scan	<u>dx=10mm dy=10mm, h= 5.00 mm</u>
ZoomScan	<u>5x5x7,dx=4mm dy=4mm</u> <u>dz=2mm,Complete/ndx=8mm dy=8mm, h=</u> <u>5.00 mm</u>
Phantom	Validation plane
Device Position	Body back(10mm)
Band	<u>IEEE 802.11n HT40 ISM</u>

SURFACE SAR

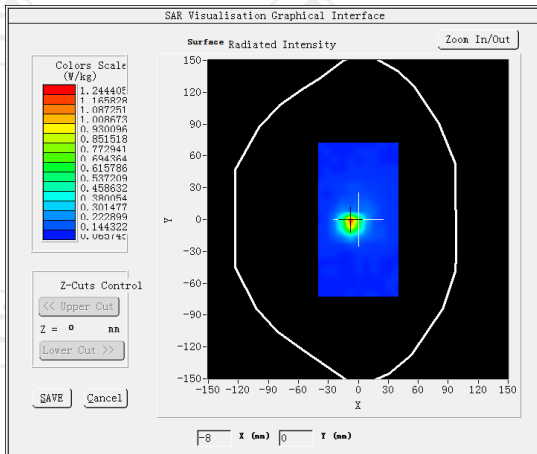

VOLUME SAR

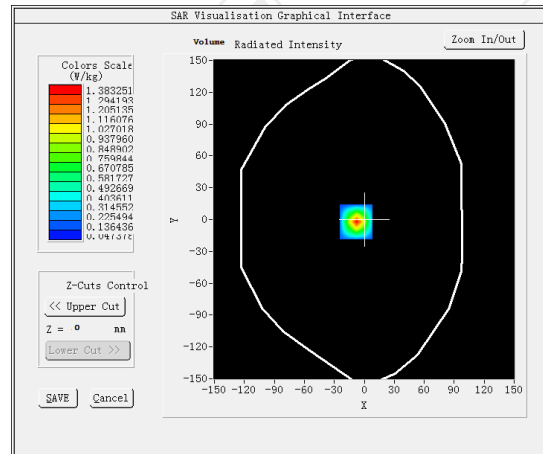

Maximum location: X=-8.00, Y=-2.00 SAR Peak: 2.20 W/kg

SAR 10g (W/Kg)	0.297653
SAR 1g (W/Kg)	0.441245

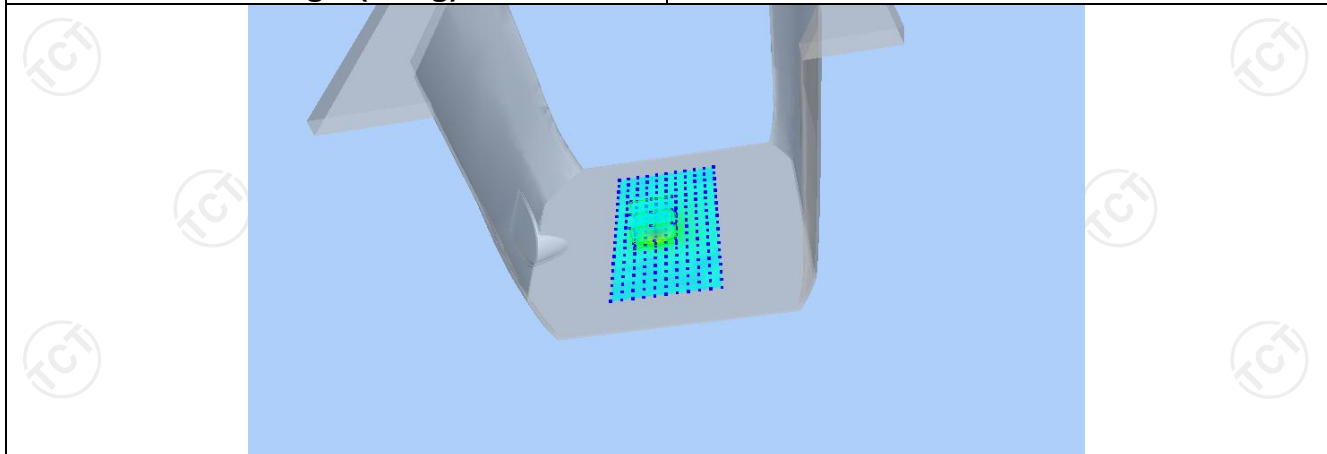

Z (mm)	0.00	2.00	7.00	12.00	17.00
SAR (W/Kg)	2.2442	1.3830	0.3180	0.0671	0.0475

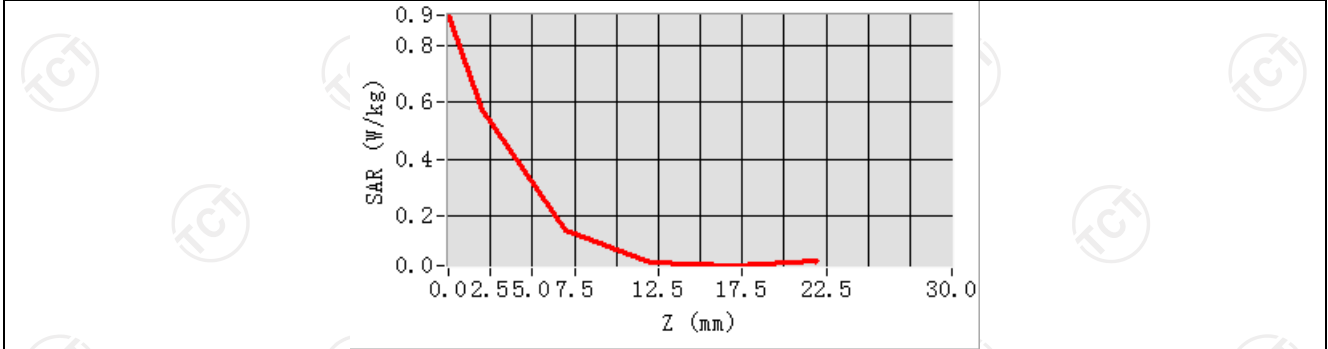

Hot spot position

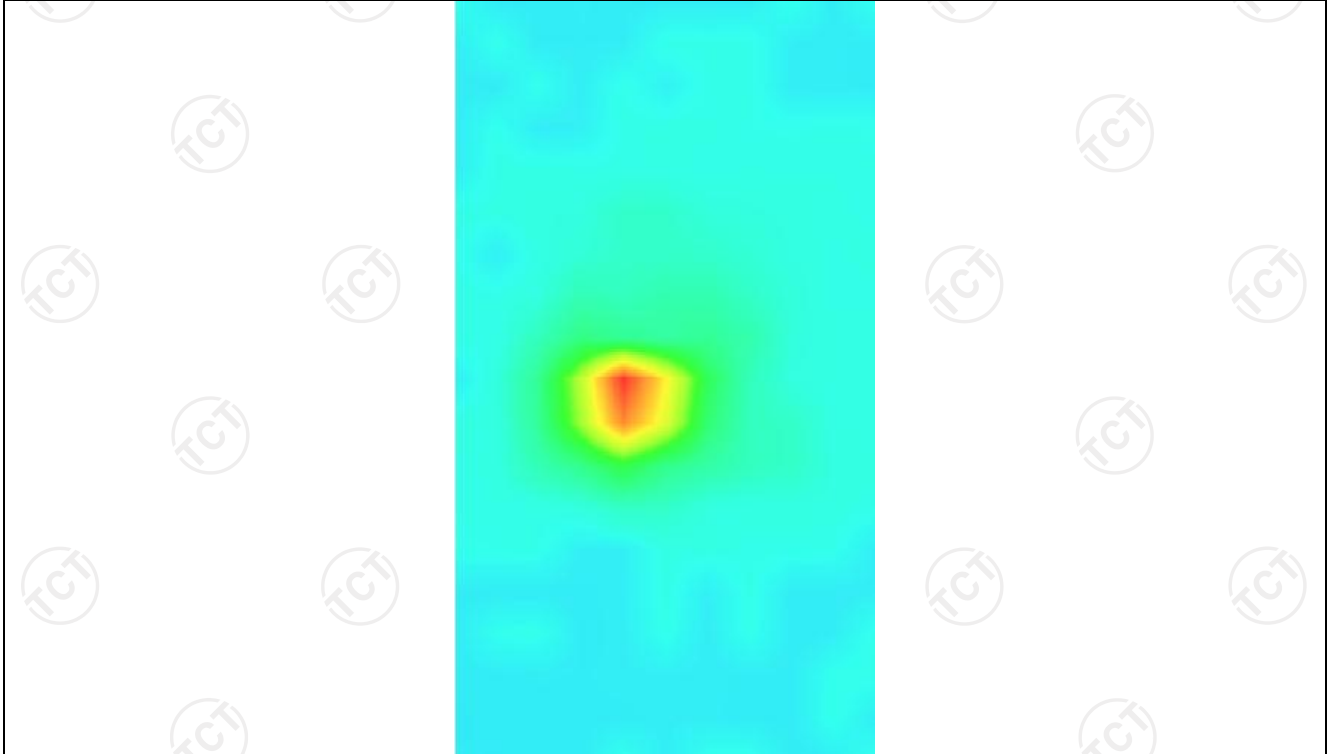

MEASUREMENT 3

SAR (Channel 46):

Date: 12/01/2023

Frequency (MHz)	5230.000000
Relative permittivity (real part)	35.068832
Relative permittivity (imaginary part)	13.679428
Conductivity (S/m)	5.220788
Variation (%)	2.610000
Crest Factor	1.0
Probe Conversion factor	2.01
E-Field Probe:	SSE2 (SN 25/22 EPG0375)
Area Scan	<u>dx=10mm dy=10mm, h= 5.00 mm</u>
ZoomScan	<u>5x5x7,dx=4mm dy=4mm</u> <u>dz=2mm,Complete/ndx=8mm dy=8mm, h=</u> <u>5.00 mm</u>
Phantom	Validation plane
Device Position	Body back(10mm)
Band	<u>IEEE 802.11n HT40 ISM(hotspot)</u>

SURFACE SAR

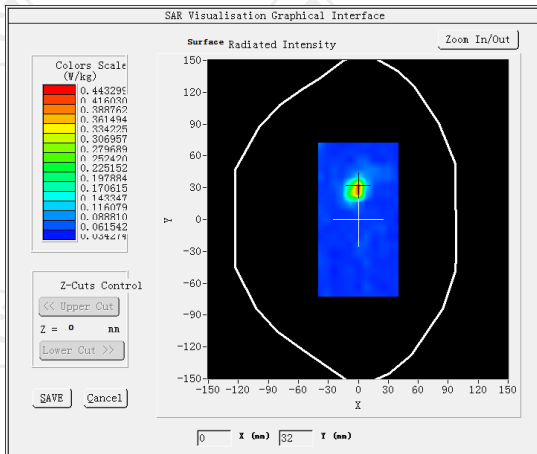

VOLUME SAR

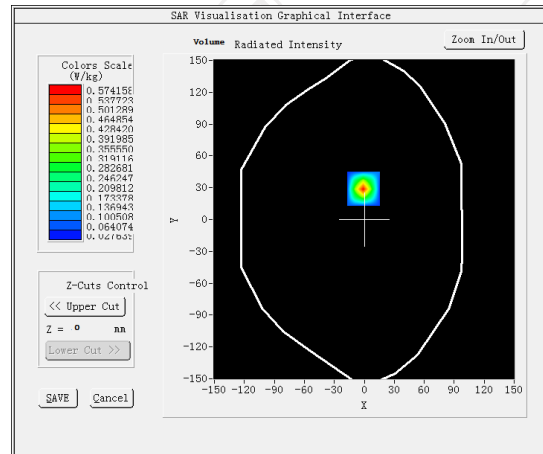

Maximum location: X=-1.00, Y=29.00 SAR Peak: 2.60 W/kg

SAR 10g (W/Kg)	0.229168
SAR 1g (W/Kg)	0.457520

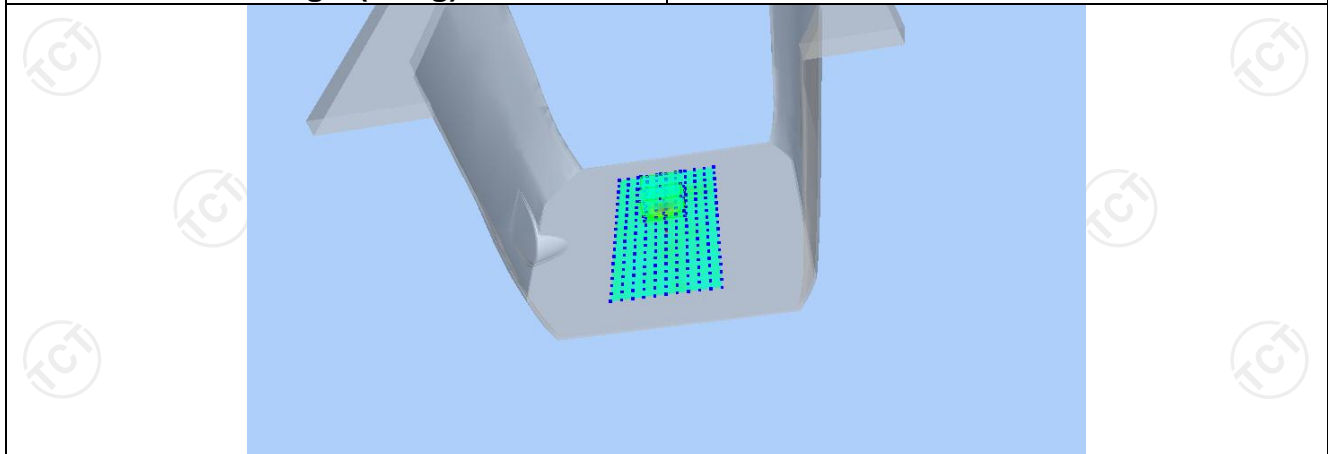

Z (mm)	0.00	2.00	7.00	12.00	17.00
SAR (W/Kg)	2.6015	1.7021	0.4950	0.1380	0.0691

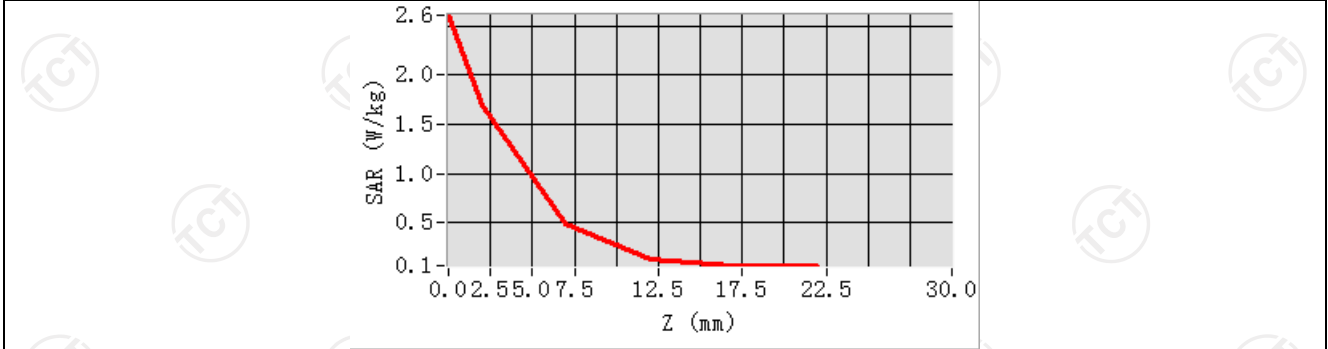

Hot spot position

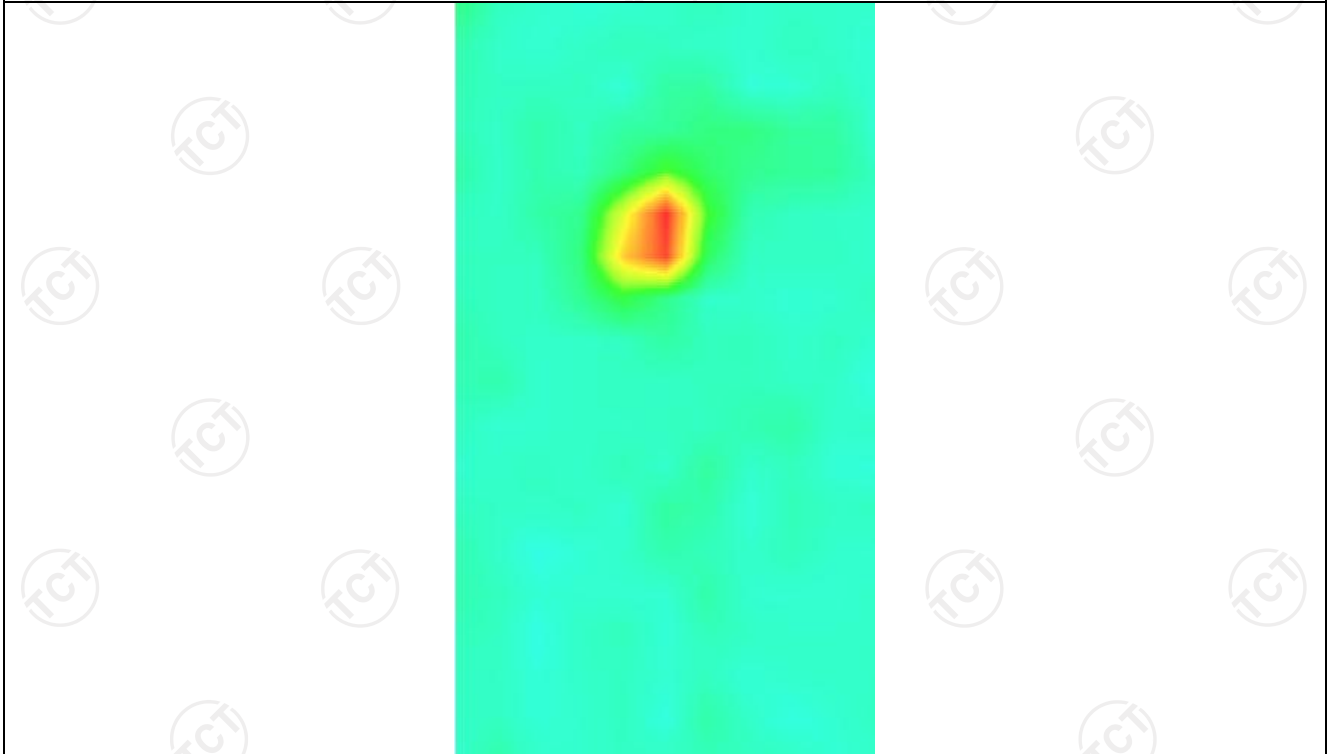

WLAN 5.3G

MEASUREMENT 1

SAR (Channel 52):

Date: 12/05/2023

Frequency (MHz)	5290.000000
Relative permittivity (real part)	36.068832
Relative permittivity (imaginary part)	13.680430
Conductivity (S/m)	4.690788
Variation (%)	2.490000
Crest Factor	1.0
Probe Conversion factor	1.94
E-Field Probe:	SSE2 (SN 25/22 EPGO375)
Area Scan	<u>dx=10mm dy=10mm, h= 5.00 mm</u>
ZoomScan	<u>5x5x7, dx=4mm dy=4mm</u> <u>dz=2mm, Complete/ndx=8mm dy=8mm, h=</u> <u>5.00 mm</u>
Phantom	Validation plane
Device Position	Body front(10mm)
Band	<u>IEEE 802.11n HT20 ISM</u>

SURFACE SAR

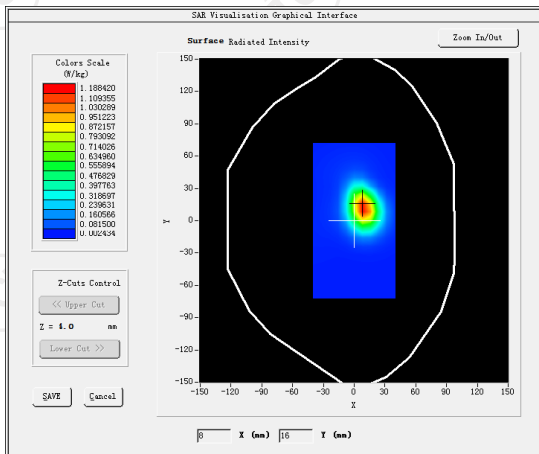

VOLUME SAR

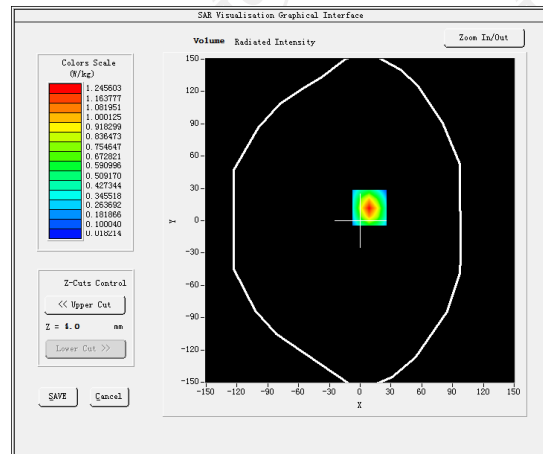

Maximum location: X=18.00, Y=35.00 SAR Peak: 0.36 W/kg

SAR 10g (W/Kg)

0.067955

SAR 1g (W/Kg)

0.116047

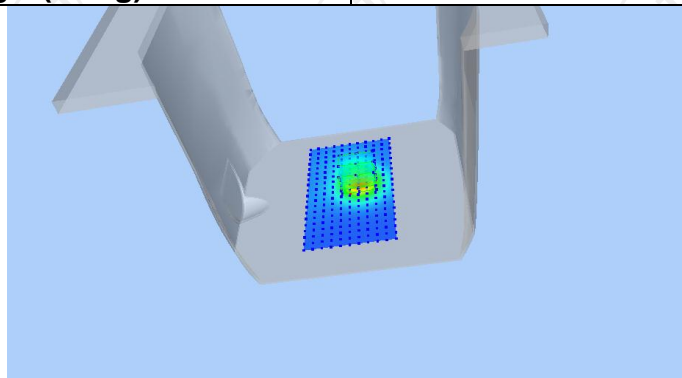

Z (mm)	0.00	4.00	9.00	14.00	19.00
SAR (W/Kg)	0.3521	0.2840	0.2161	0.1657	0.1324

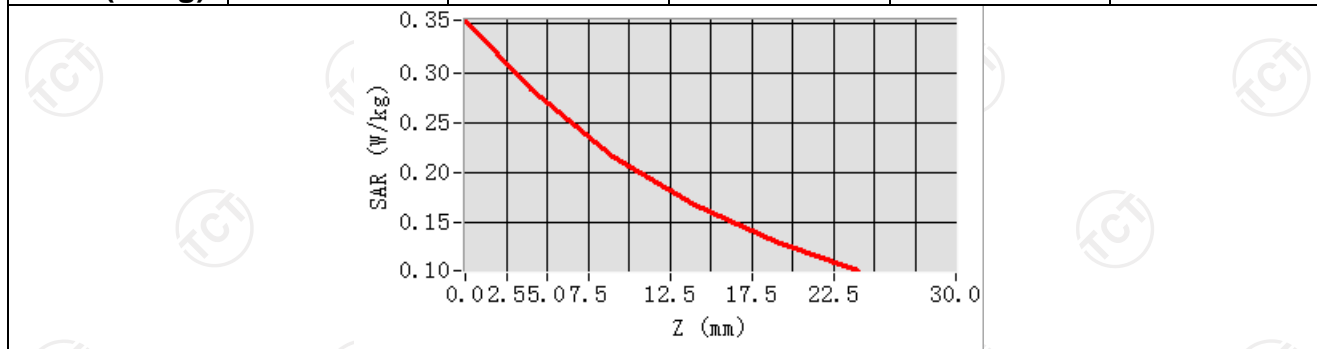

Hot spot position

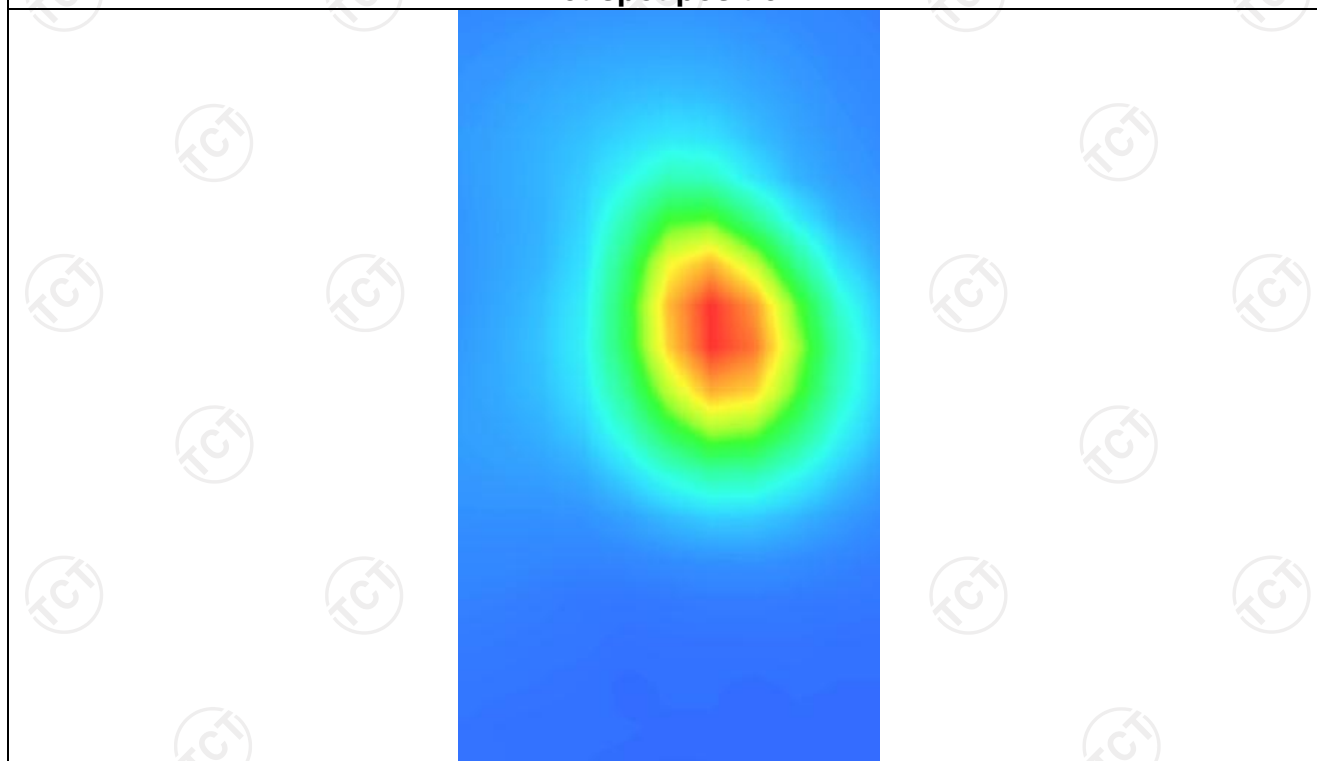

MEASUREMENT 2

SAR (Channel 52):

Date: 12/05/2023

Frequency (MHz)	5290.000000
Relative permittivity (real part)	36.068832
Relative permittivity (imaginary part)	13.680430
Conductivity (S/m)	4.690788
Variation (%)	1.380000
Crest Factor	1.0
Probe Conversion factor	1.94
E-Field Probe:	SSE2 (SN 25/22 EPGO375)
Area Scan	<u>dx=10mm dy=10mm, h= 5.00 mm</u>
ZoomScan	<u>5x5x7,dx=4mm dy=4mm</u> <u>dz=2mm,Complete/ndx=8mm dy=8mm, h=</u> <u>5.00 mm</u>
Phantom	<u>Validation plane</u>
Device Position	<u>Body back(10mm)</u>
Band	<u>IEEE 802.11n HT20 ISM</u>

SURFACE SAR

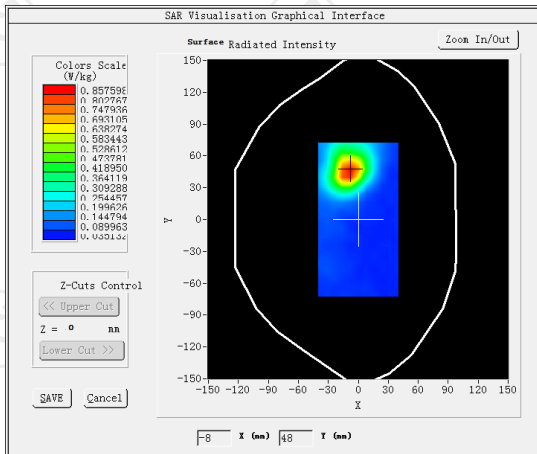

VOLUME SAR

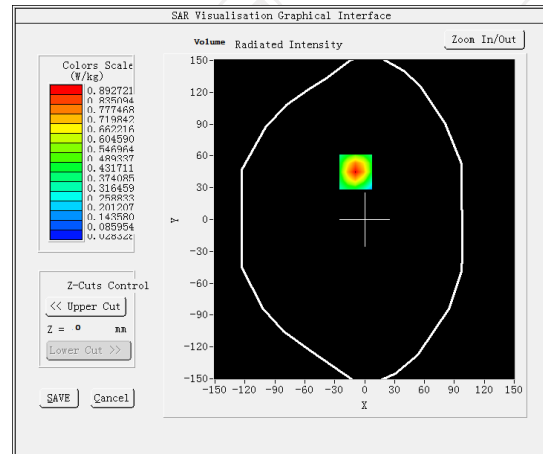

Maximum location: X=-9.00, Y=45.00 SAR Peak: 0.35 W/kg

SAR 10g (W/Kg)	0.146515
SAR 1g (W/Kg)	0.231682

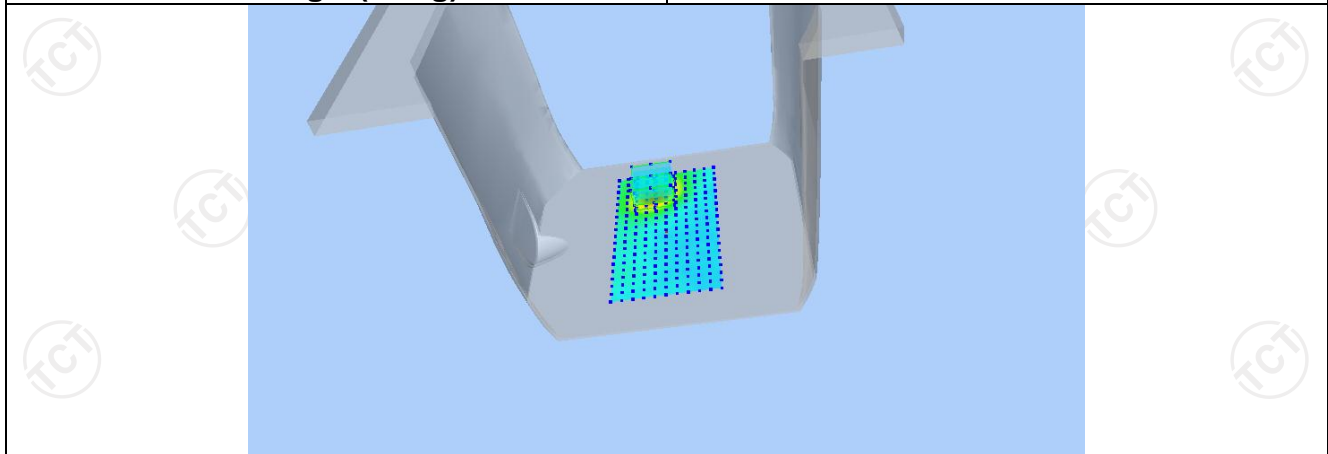

Z (mm)	0.00	2.00	7.00	12.00	17.00
SAR (W/Kg)	0.3521	0.2840	0.2161	0.1657	0.1324

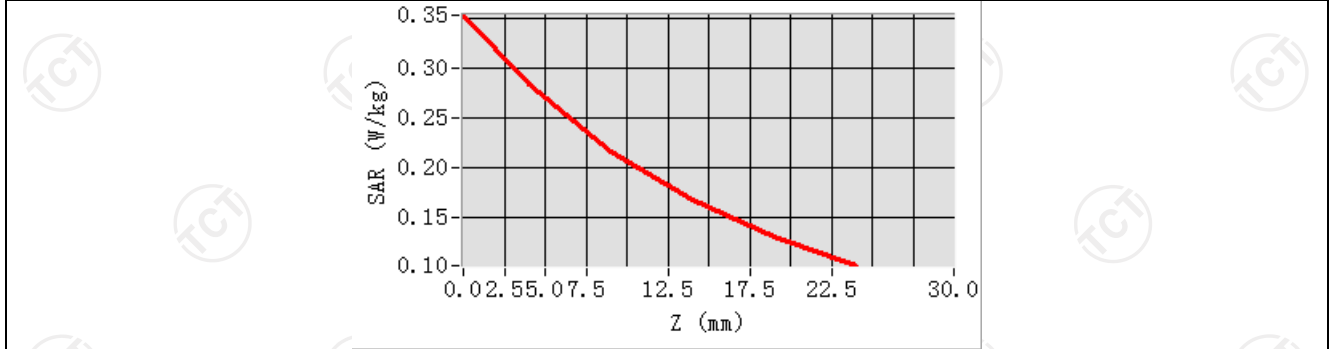

Hot spot position



MEASUREMENT 3

SAR (Channel 52):

Date: 12/05/2023

Frequency (MHz)	5290.000000
Relative permittivity (real part)	36.068832
Relative permittivity (imaginary part)	13.680430
Conductivity (S/m)	4.690788
Variation (%)	1.520000
Crest Factor	1.0
Probe Conversion factor	1.94
E-Field Probe:	SSE2 (SN 25/22 EPG0375)
Area Scan	<u>dx=10mm dy=10mm, h= 5.00 mm</u>
ZoomScan	<u>5x5x7,dx=4mm dy=4mm</u> <u>dz=2mm,Complete/ndx=8mm dy=8mm, h=</u> <u>5.00 mm</u>
Phantom	<u>Validation plane</u>
Device Position	<u>Body back(10mm)</u>
Band	<u>IEEE 802.11n HT20 ISM(hotspot)</u>

SURFACE SAR

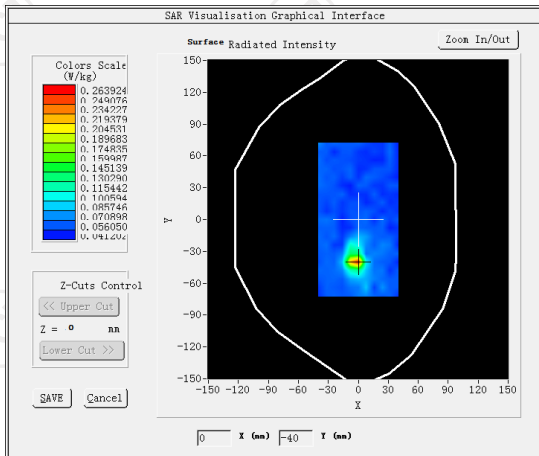

VOLUME SAR

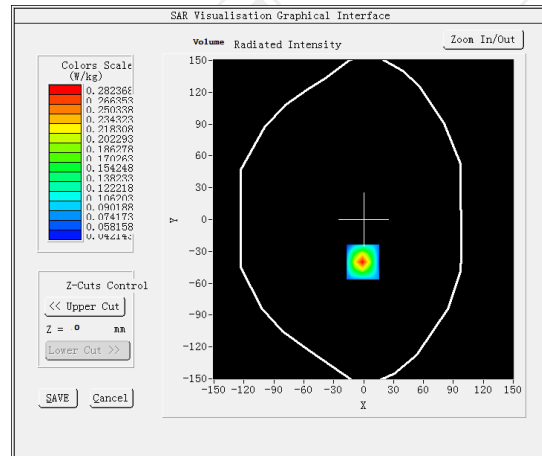

Maximum location: X=-1.00, Y=-40.00 SAR Peak: 0.41 W/kg

SAR 10g (W/Kg)

0.138038

SAR 1g (W/Kg)

0.252432

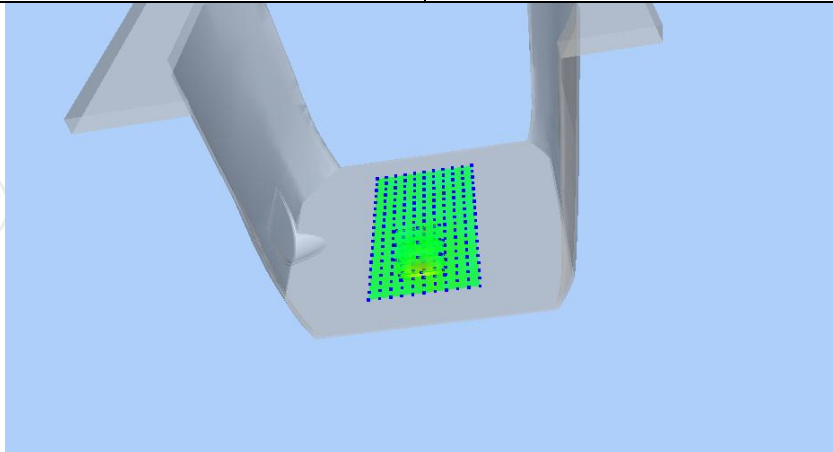

Z (mm)	0.00	2.00	7.00	12.00	17.00
SAR (W/Kg)	0.4047	0.2824	0.1112	0.0558	0.0508

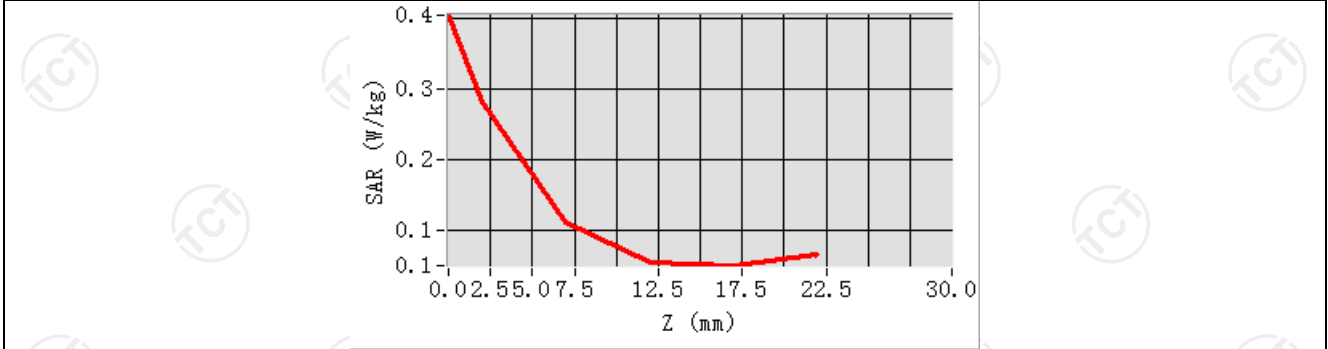

Hot spot position

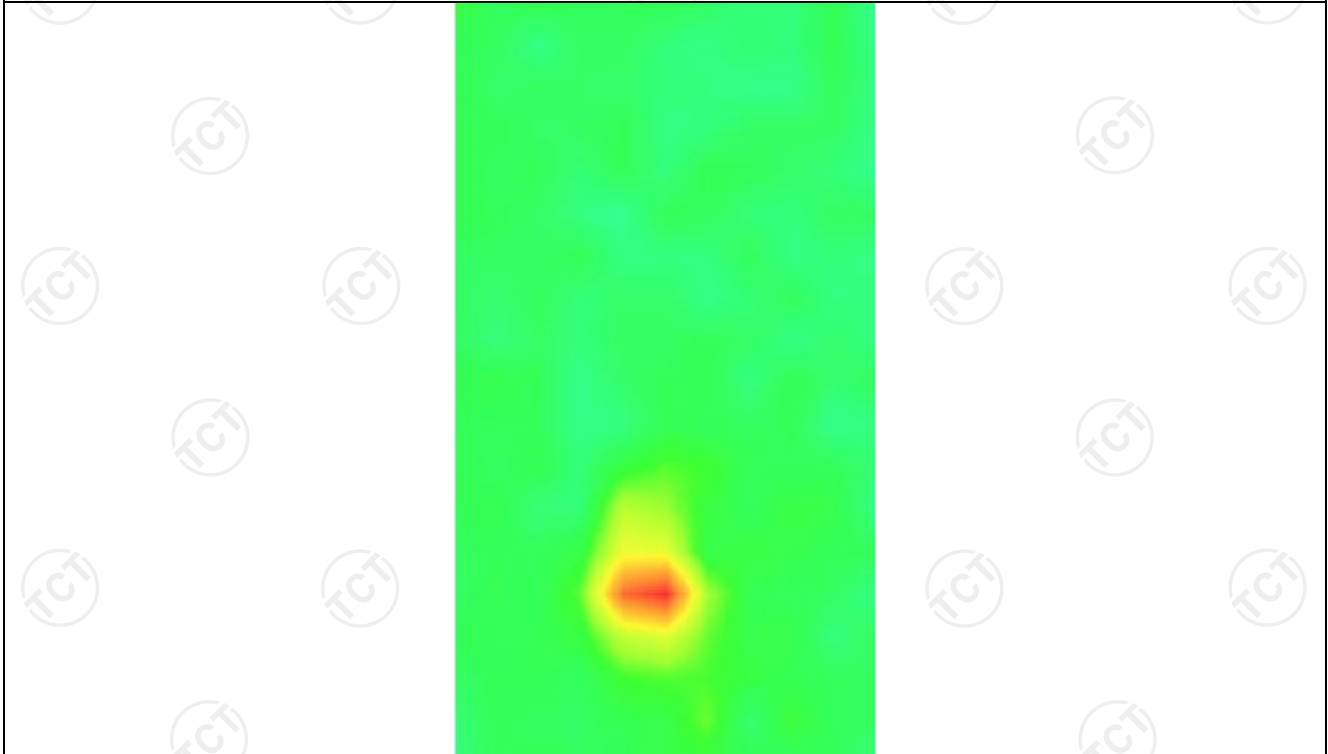

WLAN 5.8G

MEASUREMENT 1

SAR (Channel 155):

Date: 12/08/2023

Frequency (MHz)	5775.000000
Relative permittivity (real part)	38.352823
Relative permittivity (imaginary part)	13.671675
Conductivity (S/m)	5.430828
Variation (%)	2.420000
Crest Factor	1.0
Probe Conversion factor	2.06
E-Field Probe:	SSE2 (SN 25/22 EPGO375)
Area Scan	<u>dx=10mm dy=10mm, h= 5.00 mm</u>
ZoomScan	<u>5x5x7, dx=4mm dy=4mm</u> <u>dz=2mm, Complete/ndx=8mm dy=8mm, h=</u> <u>5.00 mm</u>
Phantom	Validation plane
Device Position	Body front(10mm)
Band	<u>IEEE 802.11ac HT80 ISM</u>

SURFACE SAR

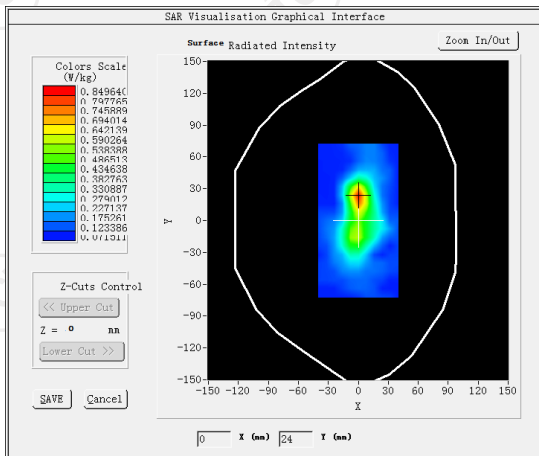

VOLUME SAR

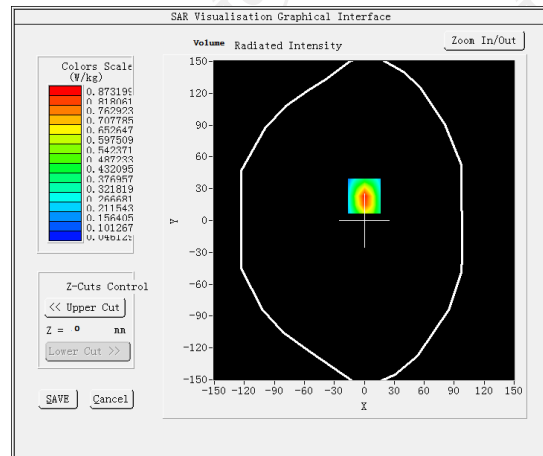

Maximum location: X=0.00, Y=23.00 SAR Peak: 0.97 W/kg

SAR 10g (W/Kg)

0.096070

SAR 1g (W/Kg)

0.144200

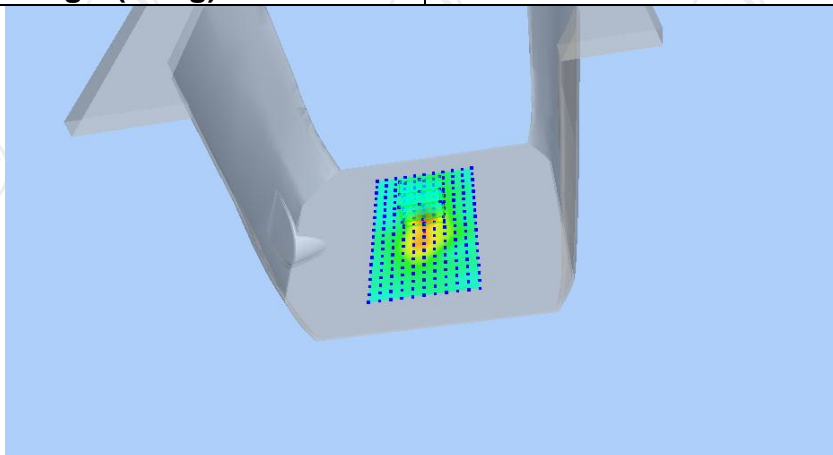

Z (mm)	0.00	2.00	7.00	12.00	17.00
SAR (W/Kg)	0.9300	0.5823	0.1459	0.0373	0.0285

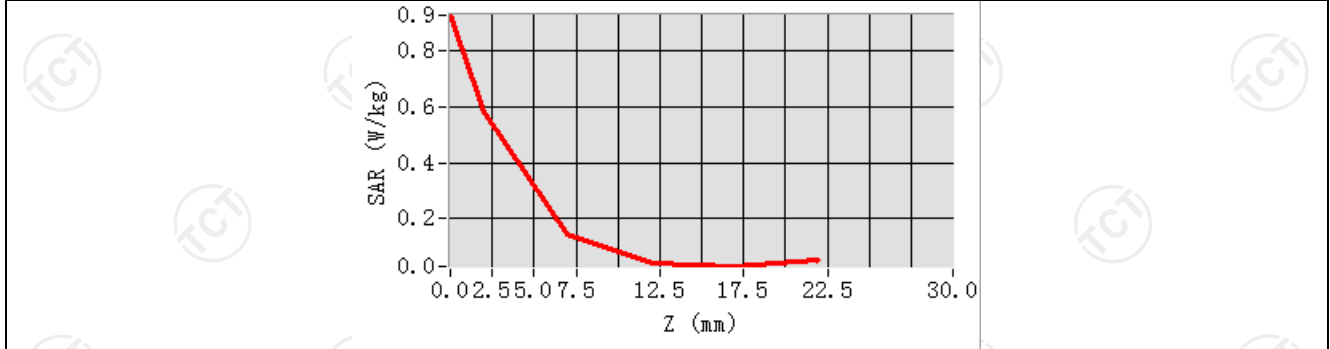

Hot spot position

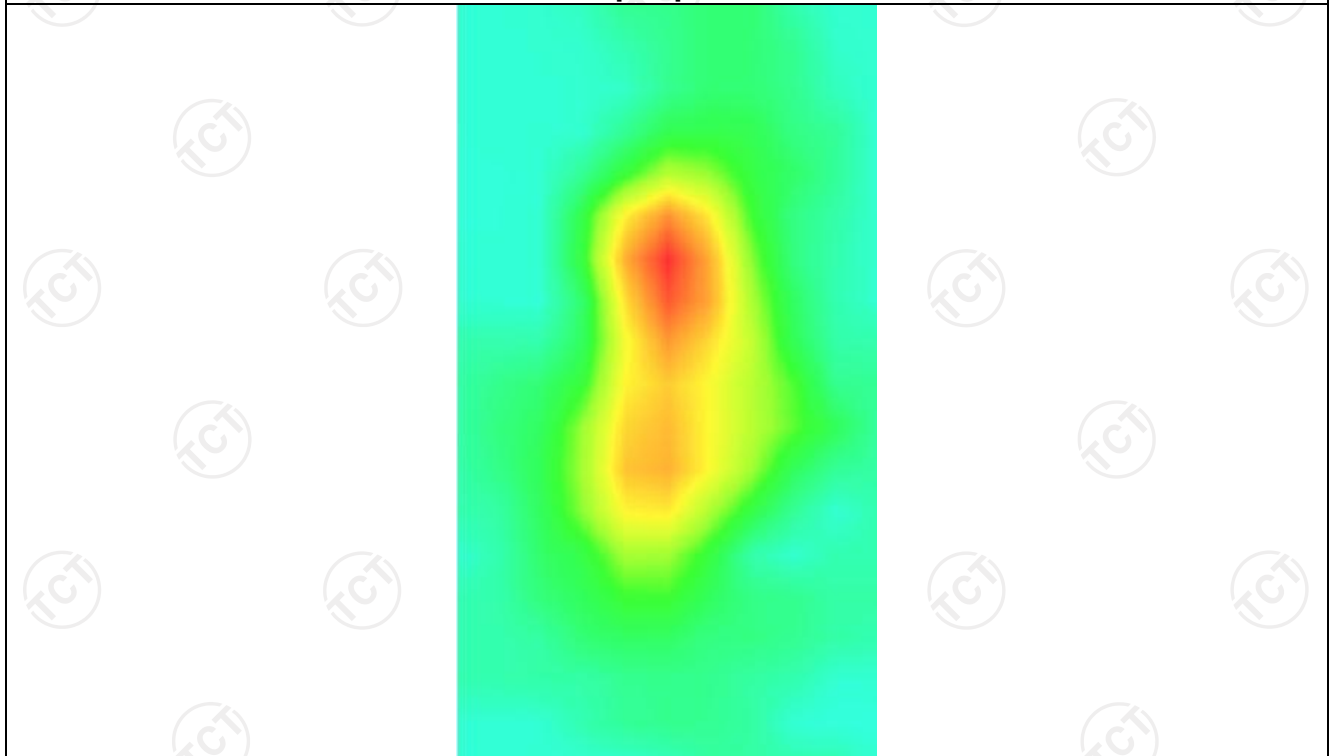

MEASUREMENT 2

SAR (Channel 155):

Date: 12/08/2023

Frequency (MHz)	5775.000000
Relative permittivity (real part)	38.352823
Relative permittivity (imaginary part)	13.671675
Conductivity (S/m)	5.430828
Variation (%)	0.790000
Crest Factor	1.0
Probe Conversion factor	2.06
E-Field Probe:	SSE2 (SN 25/22 EPGO3475)
Area Scan	<u>dx=10mm dy=10mm, h= 5.00 mm</u>
ZoomScan	<u>5x5x7,dx=4mm dy=4mm</u> <u>dz=2mm,Complete/ndx=8mm dy=8mm, h=</u> <u>5.00 mm</u>
Phantom	Validation plane
Device Position	Body back(10mm)
Band	<u>IEEE 802.11ac HT80 ISM</u>

SURFACE SAR

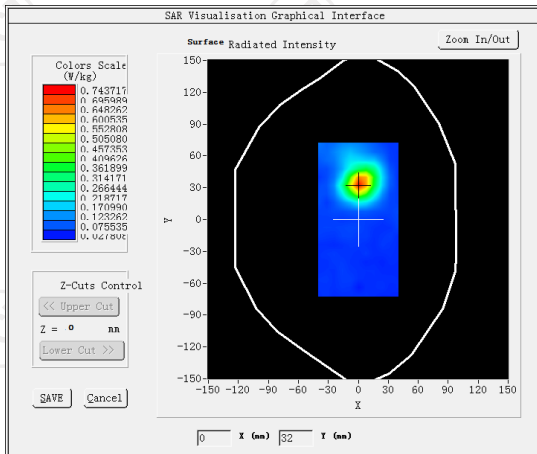

VOLUME SAR

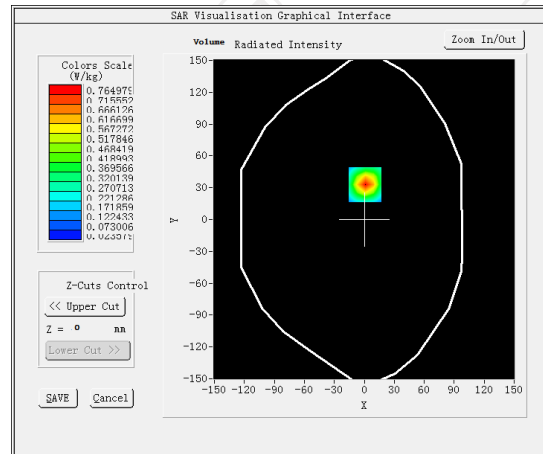

Maximum location: X=1.00, Y=33.00 SAR Peak: 1.26 W/kg

SAR 10g (W/Kg)	0.250904
SAR 1g (W/Kg)	0.402019

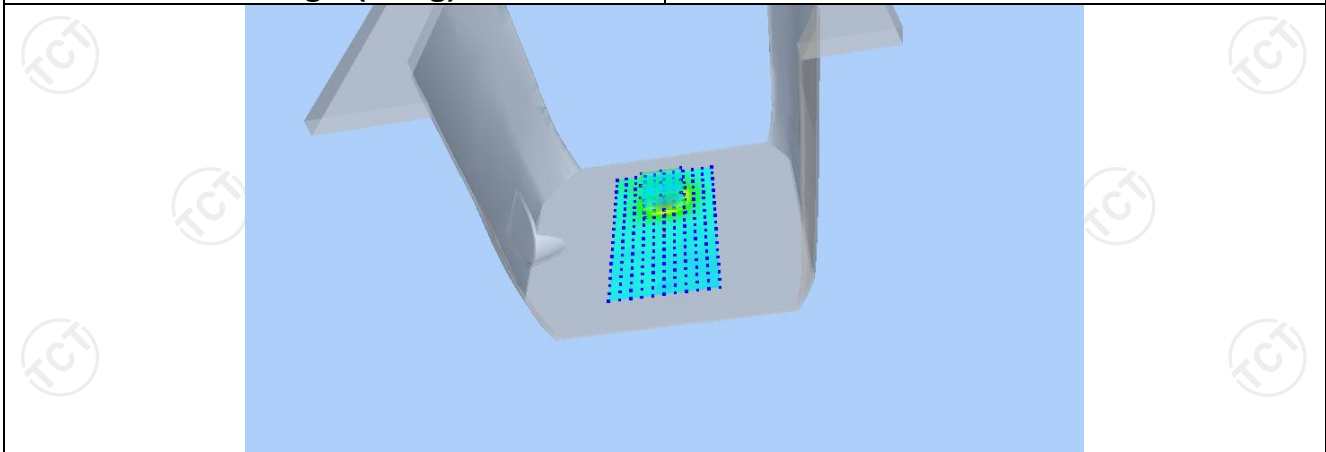

Z (mm)	0.00	2.00	7.00	12.00	17.00
SAR (W/Kg)	1.2251	0.7650	0.1866	0.0408	0.0239

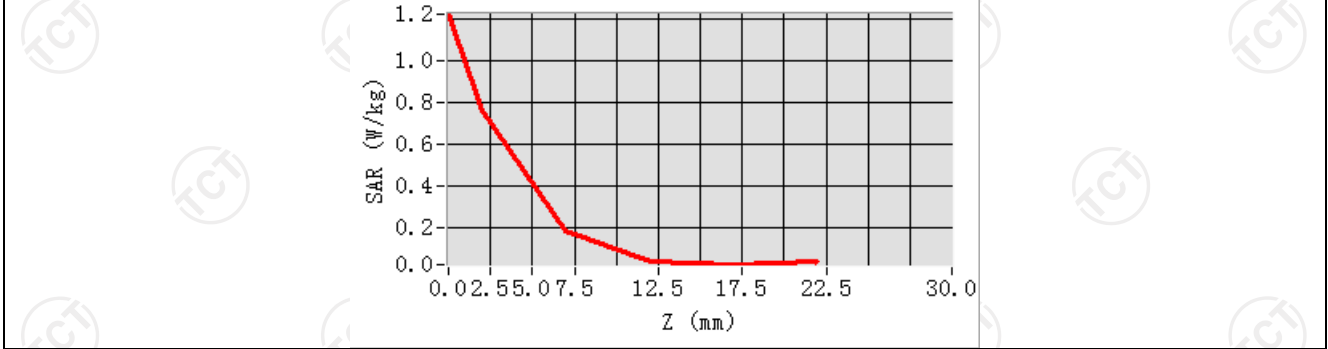

Hot spot position

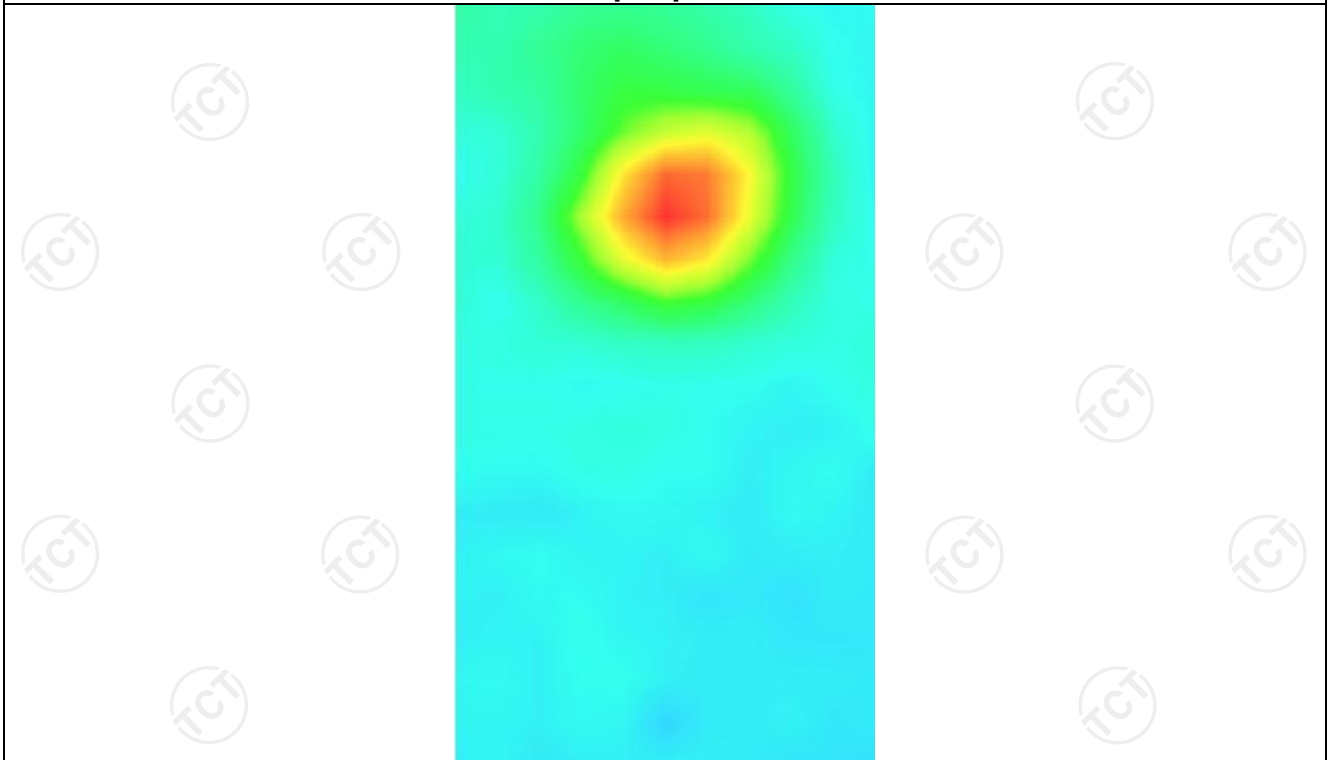

MEASUREMENT 3

SAR (Channel 155):

Date: 12/08/2023

Frequency (MHz)	5775.000000
Relative permittivity (real part)	38.352823
Relative permittivity (imaginary part)	13.671675
Conductivity (S/m)	5.430828
Variation (%)	2.840000
Crest Factor	1.0
Probe Conversion factor	2.06
E-Field Probe:	SSE2 (SN 25/22 EPG0375)
Area Scan	<u>dx=10mm dy=10mm, h= 5.00 mm</u>
ZoomScan	<u>5x5x7,dx=4mm dy=4mm</u> <u>dz=2mm,Complete/ndx=8mm dy=8mm, h=</u> <u>5.00 mm</u>
Phantom	Validation plane
Device Position	Body back(10mm)
Band	<u>IEEE 802.11ac HT80 ISM(hotspot)</u>

SURFACE SAR

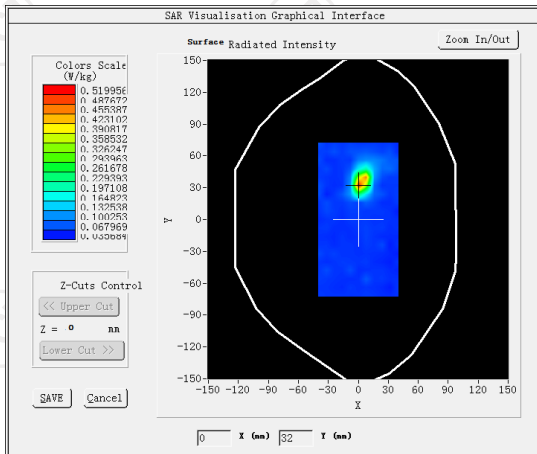

VOLUME SAR

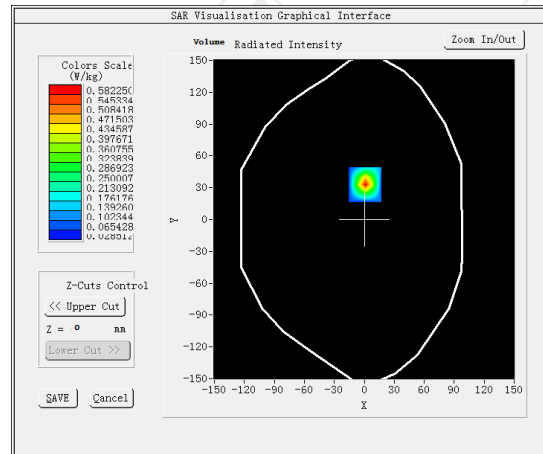

Maximum location: X=1.00, Y=33.00 SAR Peak: 1.30 W/kg

SAR 10g (W/Kg)	0.236442
SAR 1g (W/Kg)	0.415897

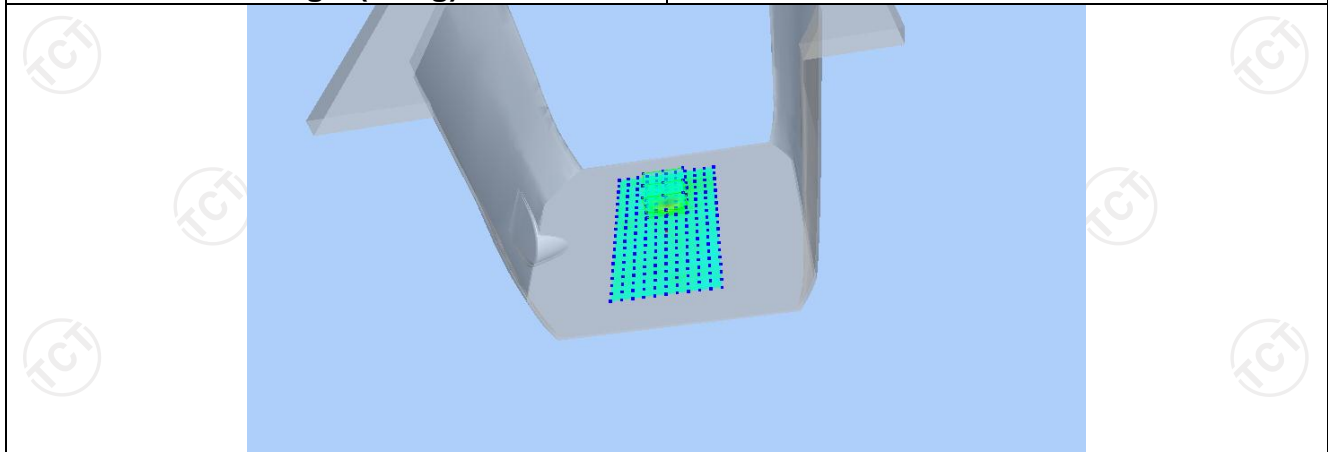

Z (mm)	0.00	2.00	7.00	12.00	17.00
SAR (W/Kg)	1.3015	0.8730	0.2610	0.0821	0.0550

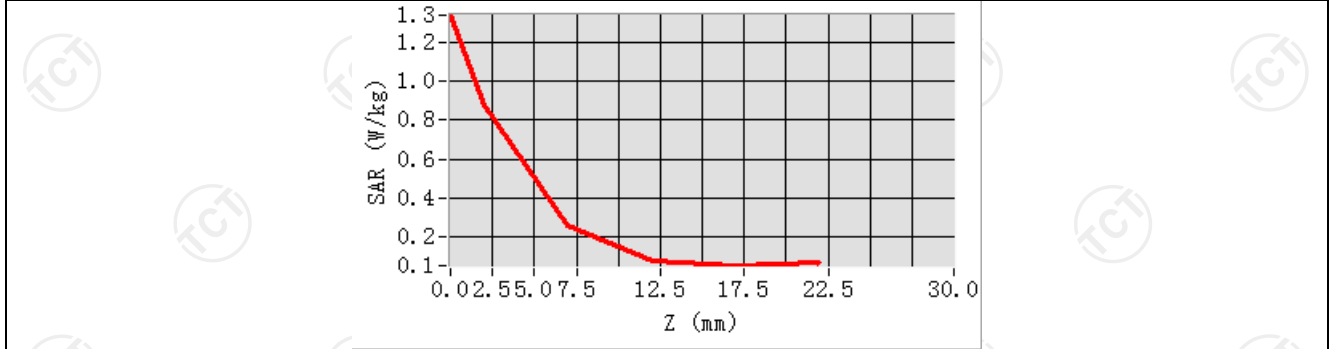

Hot spot position

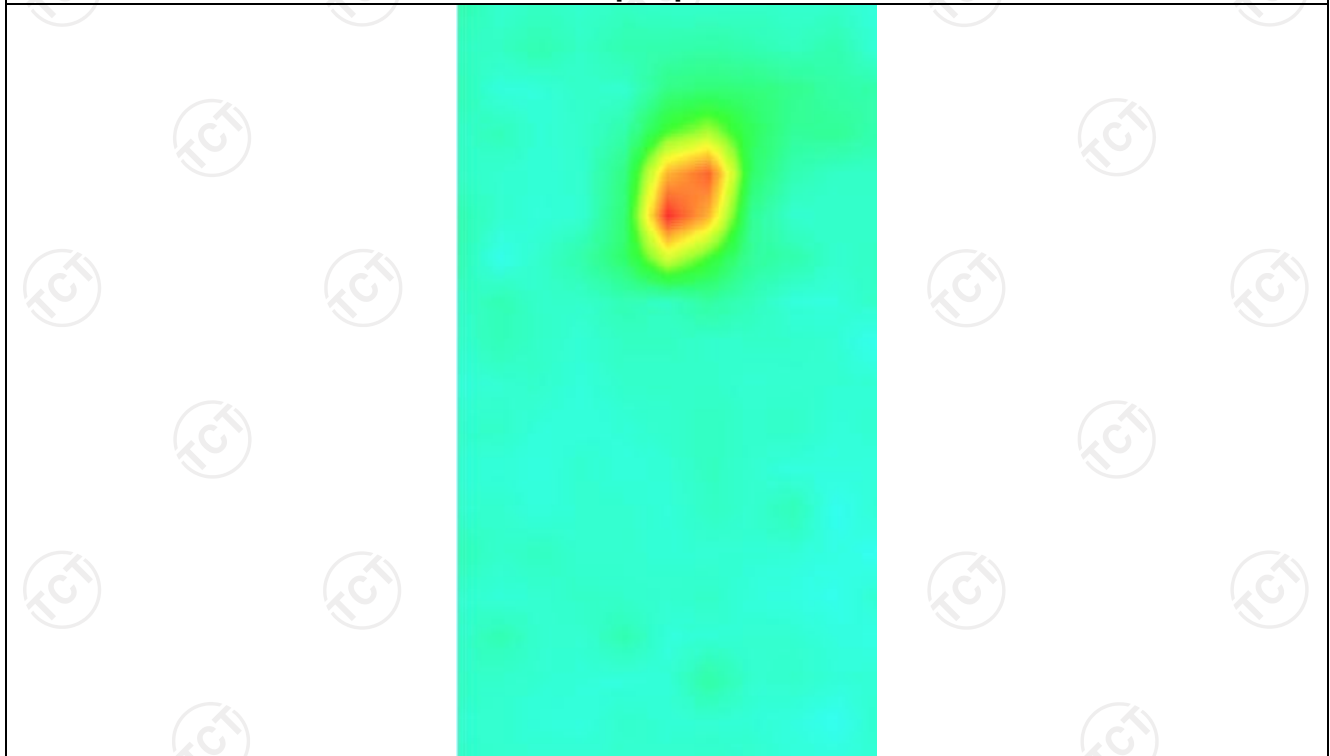

BT

MEASUREMENT 1

Low Band SAR (Channel 0):

Date: 11/27/2023

Frequency (MHz)	2402.000000
Relative permittivity (real part)	37.821613
Relative permittivity (imaginary part)	13.546980
Conductivity (S/m)	1.834111
Variation (%)	-0.240000
Crest Factor	1.0
Probe Conversion factor	2.31
E-Field Probe:	SSE2 (SN 25/22 EPG0375)
Area Scan	<u>dx=8mm dy=8mm, h= 5.00 mm</u>
ZoomScan	<u>5x5x7,dx=8mm dy=8mm</u> <u>dz=5mm,Complete/ndx=8mm dy=8mm, h=</u> <u>5.00 mm</u>
Phantom	Validation plane
Device Position	Body front(10mm)
Band	<u>GFSK</u>

SURFACE SAR

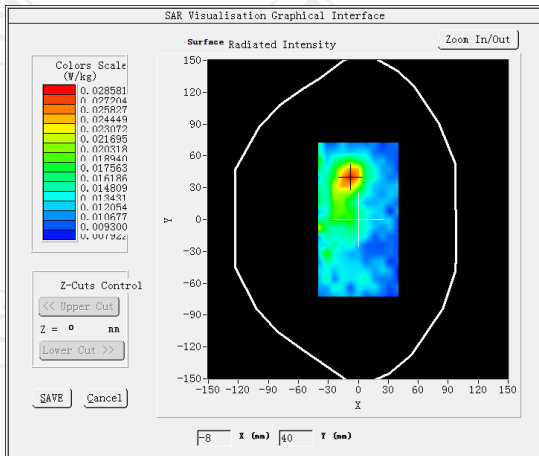

VOLUME SAR

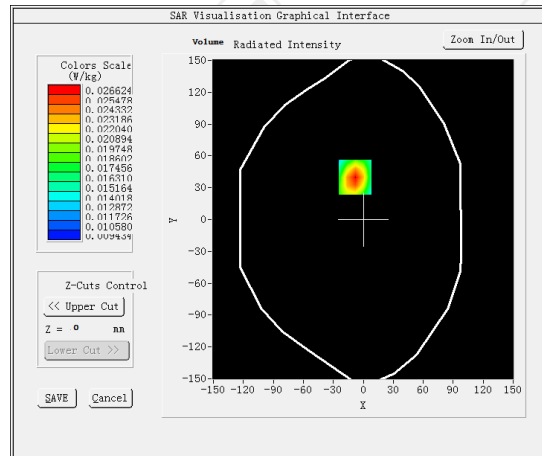

Maximum location: X=-8.00, Y=40.00 SAR Peak: 0.03 W/kg

SAR 10g (W/Kg)

0.019369

SAR 1g (W/Kg)

0.025577

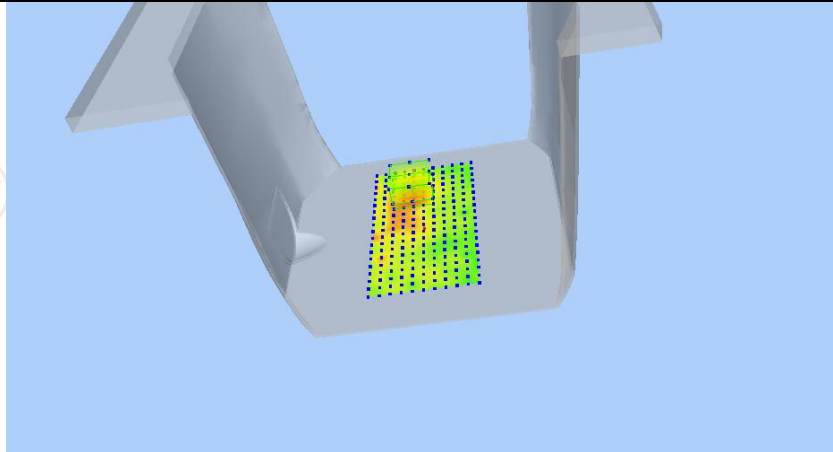

Z (mm)	0.00	4.00	9.00	14.00	19.00
SAR (W/Kg)	0.0319	0.0266	0.0216	0.0182	0.0158

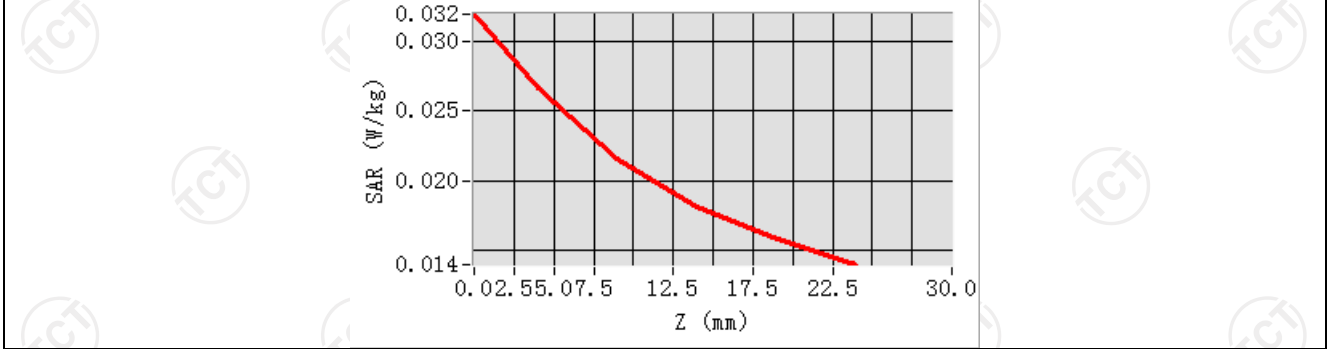

Hot spot position

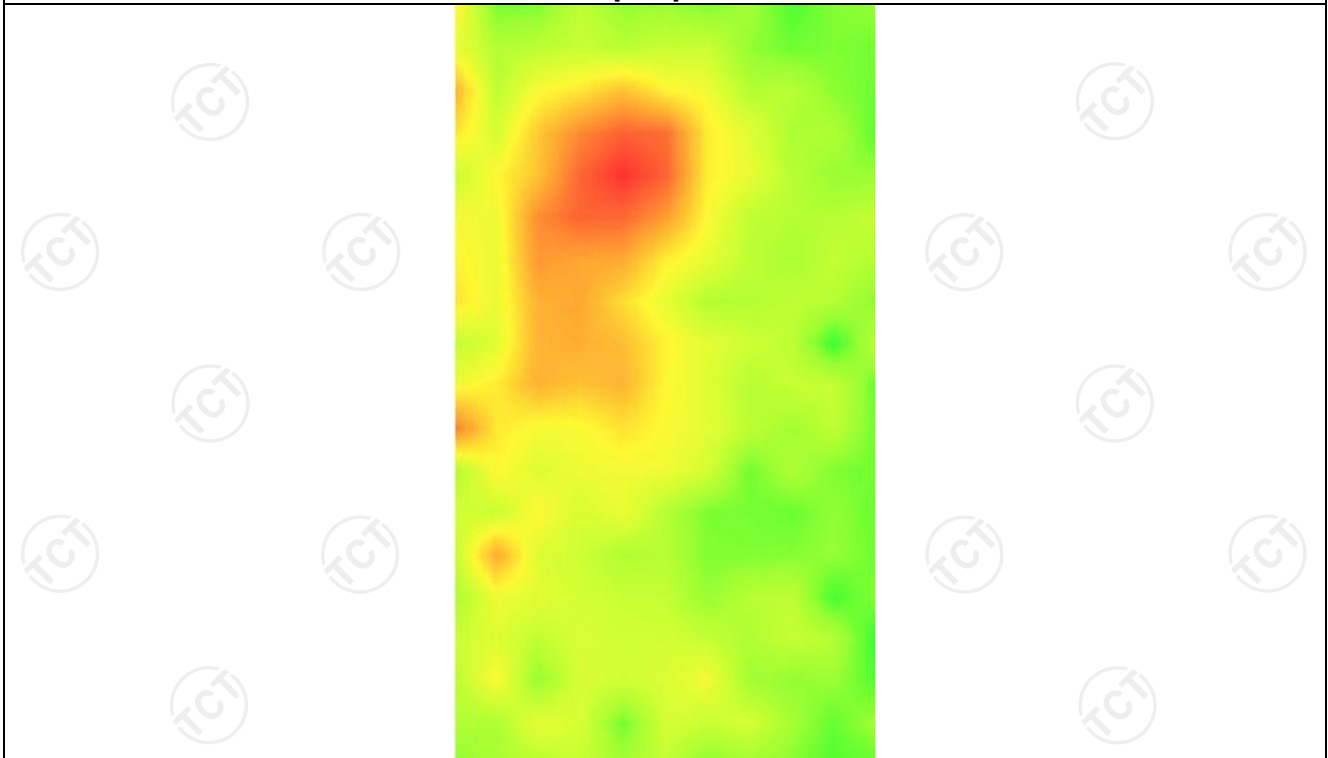

MEASUREMENT 2

Low Band SAR (Channel 0):

Date: 11/27/2023

Frequency (MHz)	2402.000000
Relative permittivity (real part)	37.821613
Relative permittivity (imaginary part)	13.546980
Conductivity (S/m)	1.834111
Variation (%)	1.930000
Crest Factor	1.0
Probe Conversion factor	2.31
E-Field Probe:	SSE2 (SN 25/22 EPG0375)
Area Scan	<u>dx=8mm dy=8mm, h= 5.00 mm</u>
ZoomScan	<u>5x5x7,dx=8mm dy=8mm</u> <u>dz=5mm,Complete/ndx=8mm dy=8mm, h=</u> <u>5.00 mm</u>
Phantom	Validation plane
Device Position	Body back(10mm)
Band	<u>GFSK</u>

SURFACE SAR

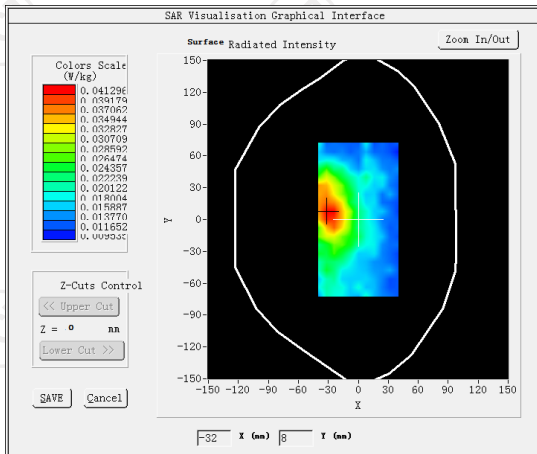

VOLUME SAR

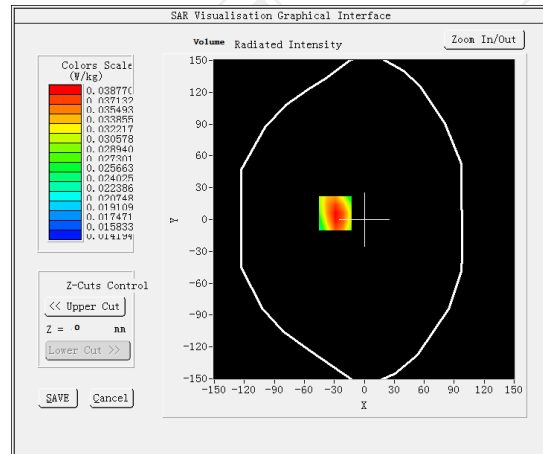

Maximum location: X=-29.00, Y=6.00 SAR Peak: 0.05 W/kg

SAR 10g (W/Kg)

0.028107

SAR 1g (W/Kg)

0.037717

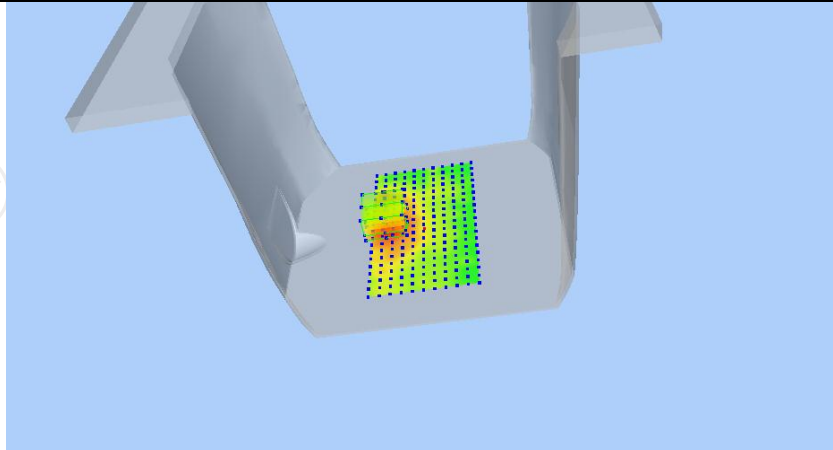

Z (mm)	0.00	4.00	9.00	14.00	19.00
SAR (W/Kg)	0.0515	0.0388	0.0280	0.0215	0.0180

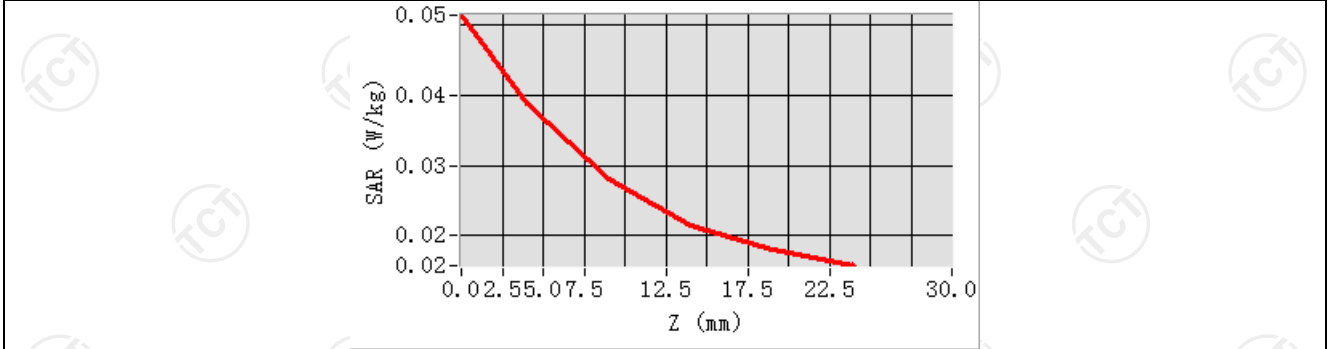

Hot spot position

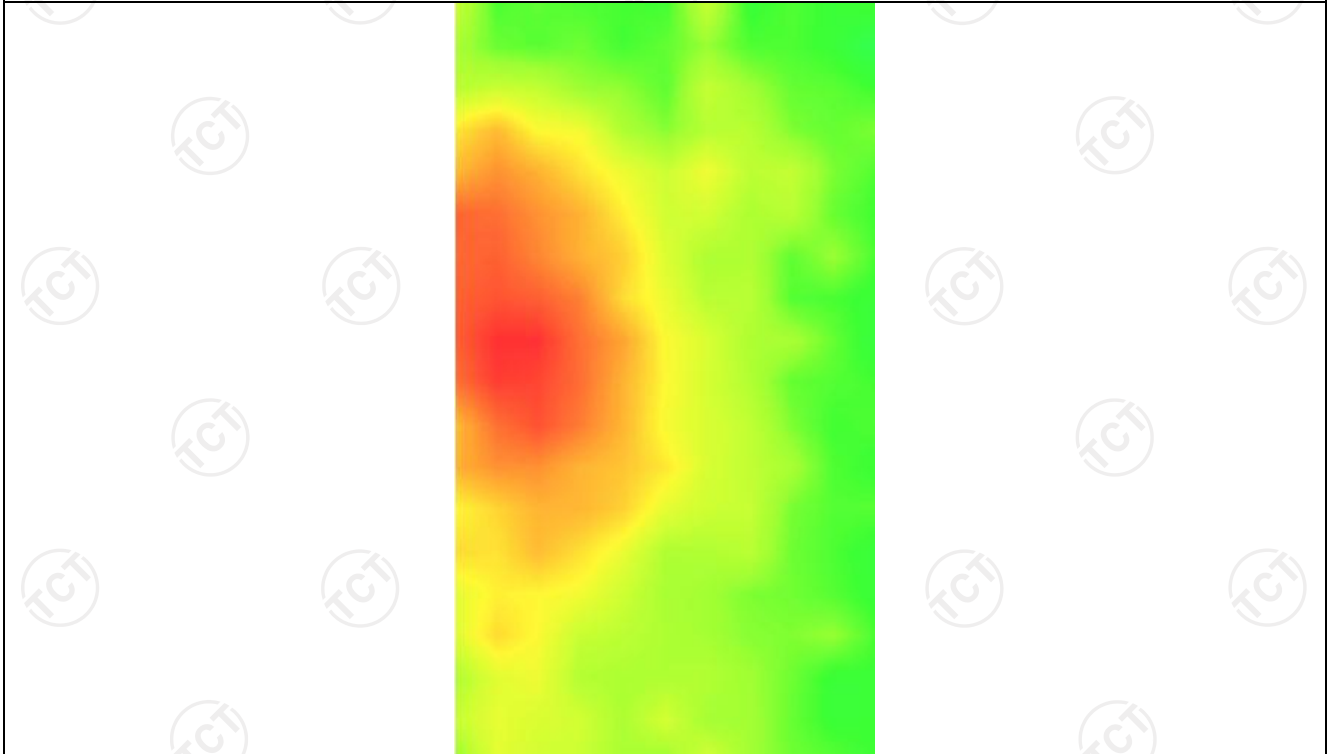

Appendix A: EUT Photos

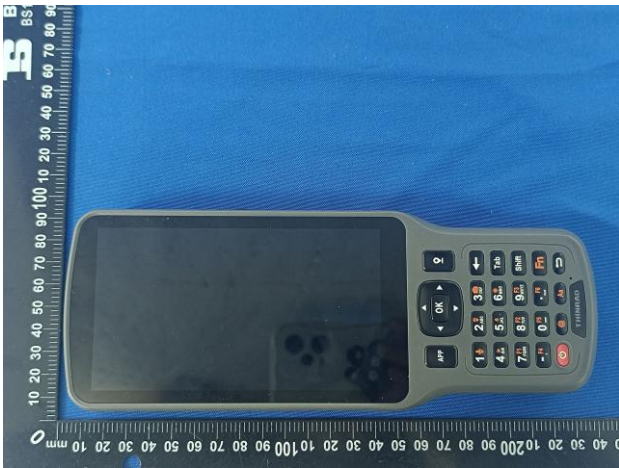

Liquid depth



The Body Liquid of 835MHz (15.4cm)



The Body Liquid of 1800MHz (15.2 cm)



The Body Liquid of 1900MHz (16.4 cm)



The Body Liquid of 2450MHz (15.3cm)



The Body Liquid of 2600MHz (16.5cm)



The Body Liquid of 5000-6000MHz (16.5cm)





The Head Liquid of 1900MHz (15.5cm)



The Head Liquid of 2450MHz (15.6cm)

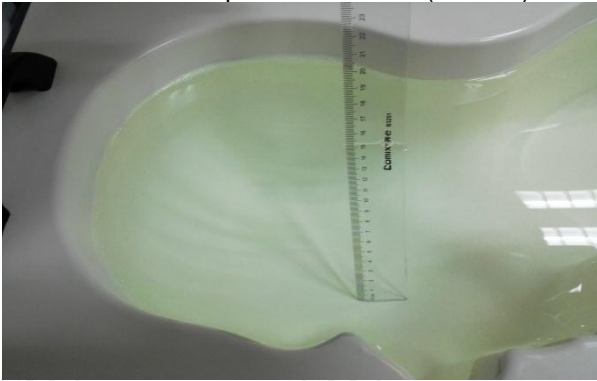

The Head Liquid of 835MHz (15.3cm)

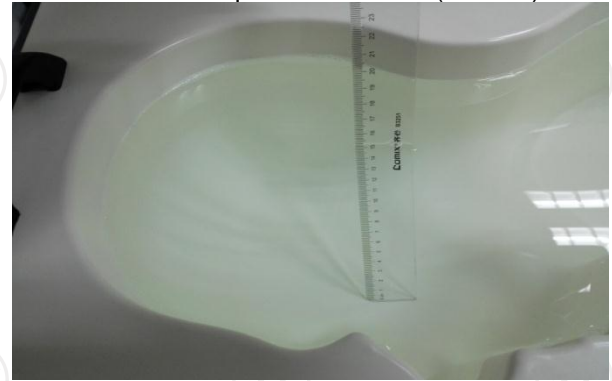

The Head Liquid of 1800MHz (15.2cm)

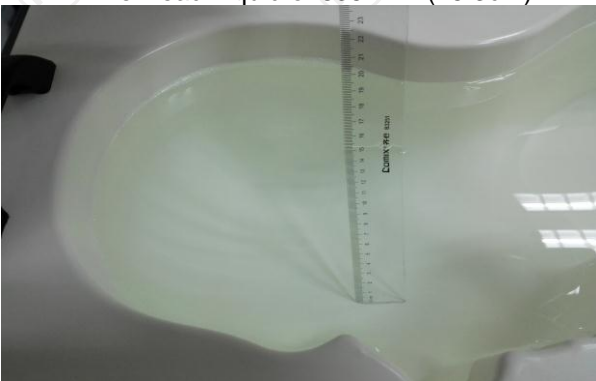

The Head Liquid of 2600MHz (15.1cm)

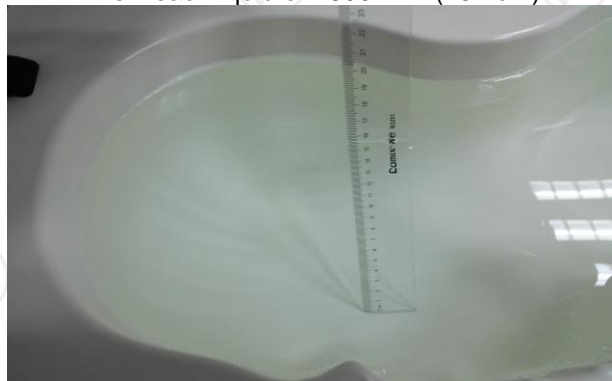

The Body Liquid of 5000-6000MHz MHz (15.8cm)



Appendix B: Test Setup Photos

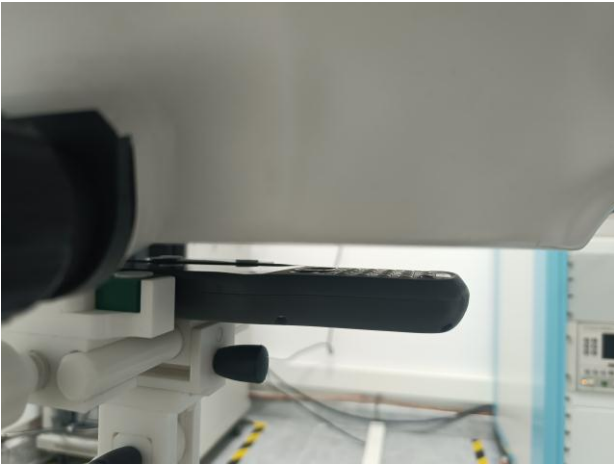

Head – Front (10mm)



Head –Bottom (10mm)

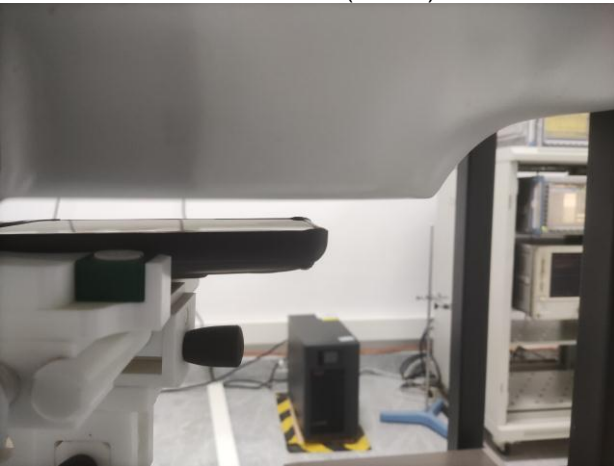

Body worn – Front (10mm)



Body worn – Back (10mm)

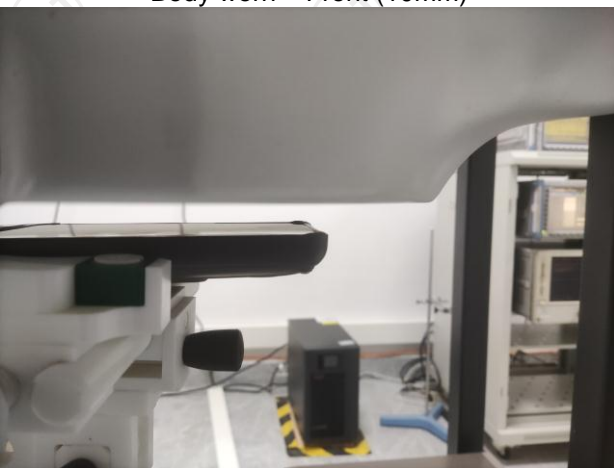

Hotspo Front (10mm)



Hotspo Back (10mm)



Hotspot Top (10mm)



Hotspot Right (10mm)



Hotspot Bottom (10mm)



Hotspot Left (10mm)



Appendix C: Probe Calibration Certificate

COMOSAR E-FIELD Probe



COMOSAR E-Field Probe Calibration Report

Ref : ACR.180.7.22.BES.B

SHENZHEN TONGCE TESTING LAB

2101 & 2201, ZHENCHANG FACTORY RENSHAN INDUSTRIAL ZONE, FUHAI SUBDISTRICT, BAO'AN DISTRICT SHENZHEN, GUANGDONG, 518103, PEOPLE'S REPUBLIC OF CHINA

MVG COMOSAR DOSIMETRIC E-FIELD PROBE

SERIAL NO.: SN 25/22 EPGO375

Calibrated at MVG

Z.I. de la pointe du diable

Technopôle Brest Iroise – 295 avenue Alexis de Rochon

29280 PLOUZANE - FRANCE

Calibration date: 06/29/2023



Accreditations #2-6789
Scope available on www.cofrac.fr

The use of the Cofrac brand and the accreditation references is prohibited from any reproduction.

Summary:

This document presents the method and results from an accredited COMOSAR Dosimetric E-Field Probe calibration performed at MVG, using the CALIPROBE test bench, for use with a MVG COMOSAR system only. The test results covered by accreditation are traceable to the International System of Units (SI).



COMOSAR E-FIELD PROBE CALIBRATION REPORT

Ref: ACR.180.7.22.BES.B

	<i>Name</i>	<i>Function</i>	<i>Date</i>	<i>Signature</i>
<i>Prepared by :</i>	Jérôme Le Gall	Measurement Responsible	6/30/2023	
<i>Checked & approved by:</i>	Jérôme Luc	Technical Manager	6/30/2023	
<i>Authorized by:</i>	Yann Toutain	Laboratory Director	7/05/2023	

	<i>Customer Name</i>
<i>Distribution :</i>	Shenzhen Tongce Testing Lab

<i>Issue</i>	<i>Name</i>	<i>Date</i>	<i>Modifications</i>
A	Jérôme Le Gall	6/30/2023	Initial release



TABLE OF CONTENTS

1	Device Under Test	4
2	Product Description	4
2.1	General Information	4
3	Measurement Method	4
3.1	Linearity	4
3.2	Sensitivity	4
3.3	Lower Detection Limit	5
3.4	Isotropy	5
3.1	Boundary Effect	5
4	Measurement Uncertainty	6
5	Calibration Measurement Results	6
5.1	Sensitivity in air	6
5.2	Linearity	7
5.3	Sensitivity in liquid	8
5.4	Isotropy	9
6	List of Equipment	10



1 DEVICE UNDER TEST

Device Under Test	
Device Type	COMOSAR DOSIMETRIC E FIELD PROBE
Manufacturer	MVG
Model	SSE2
Serial Number	SN 25/22 EPGO375
Product Condition (new / used)	New
Frequency Range of Probe	0.15 GHz-6GHz
Resistance of Three Dipoles at Connector	Dipole 1: R1=0.197 MΩ Dipole 2: R2=0.230 MΩ Dipole 3: R3=0.208 MΩ

2 PRODUCT DESCRIPTION

2.1 GENERAL INFORMATION

MVG’s COMOSAR E field Probes are built in accordance to the IEC/IEEE 62209-1528 and FCC KDB865664 D01 standards.



Figure 1 – MVG COMOSAR Dosimetric E field Probe

Probe Length	330 mm
Length of Individual Dipoles	2 mm
Maximum external diameter	8 mm
Probe Tip External Diameter	2.5 mm
Distance between dipoles / probe extremity	1 mm

3 MEASUREMENT METHOD

The IEC/IEEE 62209-1528 and FCC KDB865664 D01 standards provide recommended practices for the probe calibrations, including the performance characteristics of interest and methods by which to assess their affect. All calibrations / measurements performed meet the fore mentioned standards.

3.1 LINEARITY

The evaluation of the linearity was done in free space using the waveguide, performing a power sweep to cover the SAR range 0.01W/kg to 100W/kg.

3.2 SENSITIVITY

The sensitivity factors of the three dipoles were determined using a two step calibration method (air and tissue simulating liquid) using waveguides as outlined in the standards.

Page: 4/11

Template_ACR.DDD.N.YY.MVGB.ISSUE_COMOSAR Probe vK

This document shall not be reproduced, except in full or in part, without the written approval of MVG. The information contained herein is to be used only for the purpose for which it is submitted and is not to be released in whole or part without written approval of MVG.



3.3 LOWER DETECTION LIMIT

The lower detection limit was assessed using the same measurement set up as used for the linearity measurement. The required lower detection limit is 10 mW/kg.

3.4 ISOTROPY

The axial isotropy was evaluated by exposing the probe to a reference wave from a standard dipole with the dipole mounted under the flat phantom in the test configuration suggested for system validations and checks. The probe was rotated along its main axis from 0 to 360 degrees in 15-degree steps. The hemispherical isotropy is determined by inserting the probe in a thin plastic box filled with tissue-equivalent liquid, with the plastic box illuminated with the fields from a half wave dipole. The dipole is rotated about its axis (0°–180°) in 15° increments. At each step the probe is rotated about its axis (0°–360°).

3.1 BOUNDARY EFFECT

The boundary effect is defined as the deviation between the SAR measured data and the expected exponential decay in the liquid when the probe is oriented normal to the interface. To evaluate this effect, the liquid filled flat phantom is exposed to fields from either a reference dipole or waveguide. With the probe normal to the phantom surface, the peak spatial average SAR is measured and compared to the analytical value at the surface.

The boundary effect uncertainty can be estimated according to the following uncertainty approximation formula based on linear and exponential extrapolations between the surface and $d_{be} + d_{step}$ along lines that are approximately normal to the surface:

$$SAR_{uncertainty} [\%] = \Delta SAR_{be} \frac{(d_{be} + d_{step})^2}{2d_{step}} \frac{(e^{-d_{be}/\delta})^2}{\delta/2} \quad \text{for } (d_{be} + d_{step}) < 10 \text{ mm}$$

where

$SAR_{uncertainty}$ is the uncertainty in percent of the probe boundary effect

d_{be} is the distance between the surface and the closest *zoom-scan* measurement point, in millimetre

Δ_{step} is the separation distance between the first and second measurement points that are closest to the phantom surface, in millimetre, assuming the boundary effect at the second location is negligible

δ is the minimum penetration depth in millimetres of the head tissue-equivalent liquids defined in this standard, i.e., $\delta \approx 14$ mm at 3 GHz;

ΔSAR_{be} in percent of SAR is the deviation between the measured SAR value, at the distance d_{be} from the boundary, and the analytical SAR value.

The measured worst case boundary effect SAR uncertainty[%] for scanning distances larger than 4mm is 1.0% Limit ,2%).



4 MEASUREMENT UNCERTAINTY

The guidelines outlined in the IEC/IEEE 62209-1528 and FCC KDB865664 D01 standards were followed to generate the measurement uncertainty associated with an E-field probe calibration using the waveguide technique. All uncertainties listed below represent an expanded uncertainty expressed at approximately the 95% confidence level using a coverage factor of k=2, traceable to the Internationally Accepted Guides to Measurement Uncertainty.

Uncertainty analysis of the probe calibration in waveguide					
ERROR SOURCES	Uncertainty value (%)	Probability Distribution	Divisor	ci	Standard Uncertainty (%)
Expanded uncertainty 95 % confidence level k = 2					14 %

5 CALIBRATION MEASUREMENT RESULTS

Calibration Parameters	
Liquid Temperature	20 +/- 1 °C
Lab Temperature	20 +/- 1 °C
Lab Humidity	30-70 %

5.1 SENSITIVITY IN AIR

Normx dipole 1 (µV/(V/m) ²)	Normy dipole 2 (µV/(V/m) ²)	Normz dipole 3 (µV/(V/m) ²)
0.64	0.53	0.44

DCP dipole 1 (mV)	DCP dipole 2 (mV)	DCP dipole 3 (mV)
106	108	109

Calibration curves $e_i=f(V)$ (i=1,2,3) allow to obtain E-field value using the formula:

$$E = \sqrt{E_1^2 + E_2^2 + E_3^2}$$



COMOSAR E-FIELD PROBE CALIBRATION REPORT

Ref: ACR.180.7.22.BES.B

Calibration curves

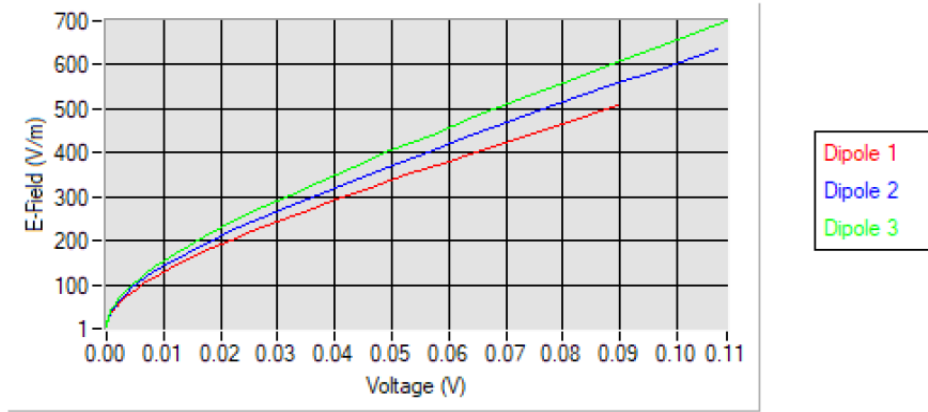

5.2 LINEARITY

Linearity

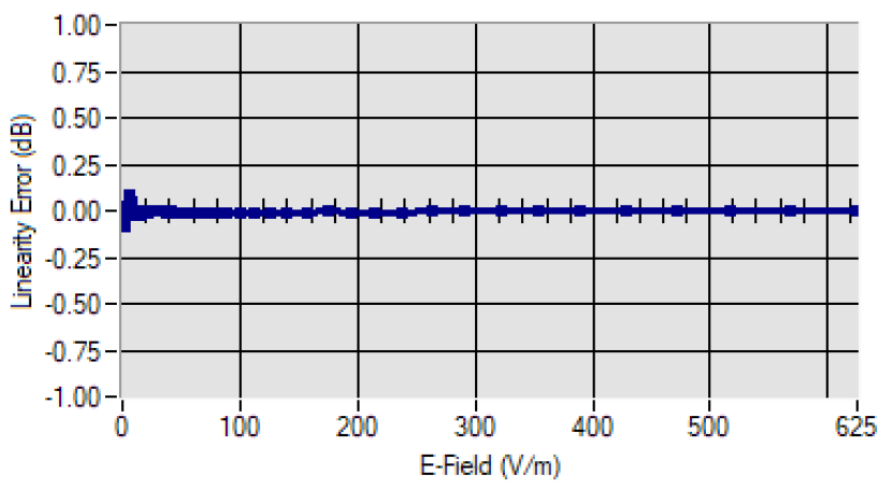

Linearity: $\pm 1.94\%$ ($\pm 0.09\text{dB}$)



5.3 SENSITIVITY IN LIQUID

Liquid	Frequency (MHz +/- 100MHz)	ConvF
HL750	750	1.71
BL750	750	1.78
HL900	900	1.91
BL900	900	1.96
HL1800	1800	2.08
BL1800	1800	2.16
HL2000	2000	2.03
BL2000	2000	2.10
HL2450	2450	2.31
BL2450	2450	2.37
HL2600	2600	2.16
BL2600	2600	2.23
HL3500	3500	2.21
BL3500	3500	2.28
HL3700	3700	3.45
BL3700	3700	3.15
HL4600	4600	3.30
BL4600	4600	3.70
HL5200	5200	2.01
BL5200	5200	2.08
HL5600	5600	2.07
BL5600	5600	2.12
HL5800	5800	2.06
BL5800	5800	2.13

LOWER DETECTION LIMIT: 7mW/kg



5.4 ISOTROPY

HL1800 MHz

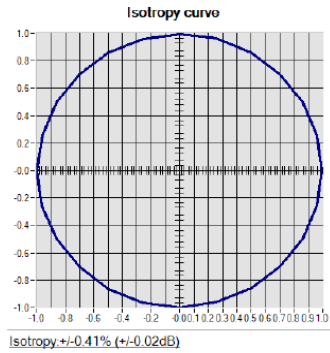



6 LIST OF EQUIPMENT

Equipment Summary Sheet				
Equipment Description	Manufacturer / Model	Identification No.	Current Calibration Date	Next Calibration Date
CALIPROBE Test Bench	Version 2	NA	Validated. No cal required.	Validated. No cal required.
Network Analyzer	Rohde & Schwarz ZVM	100203	08/2021	08/2024
Network Analyzer	Agilent 8753ES	MY40003210	10/2023	10/2026
Network Analyzer – Calibration kit	HP 85033D	3423A08186	06/2021	06/2027
Multimeter	Keithley 2000	1160271	02/2023	02/2026
Signal Generator	Rohde & Schwarz SMB	106589	03/2022	03/2025
Amplifier	MVG	MODU-023-C-0002	Characterized prior to test. No cal required.	Characterized prior to test. No cal required.
Power Meter	NI-USB 5680	170100013	06/2021	06/2024
Power Meter	Rohde & Schwarz NRVD	832839-056	11/2023	11/2026
Directional Coupler	Krytar 158020	131467	Characterized prior to test. No cal required.	Characterized prior to test. No cal required.
Waveguide	MVG	SN 32/16 WG4_1	Validated. No cal required.	Validated. No cal required.
Liquid transition	MVG	SN 32/16 WGLIQ_0G900_1	Validated. No cal required.	Validated. No cal required.
Waveguide	MVG	SN 32/16 WG6_1	Validated. No cal required.	Validated. No cal required.
Liquid transition	MVG	SN 32/16 WGLIQ_1G500_1	Validated. No cal required.	Validated. No cal required.
Waveguide	MVG	SN 32/16 WG8_1	Validated. No cal required.	Validated. No cal required.
Liquid transition	MVG	SN 32/16 WGLIQ_1G800B_1	Validated. No cal required.	Validated. No cal required.
Liquid transition	MVG	SN 32/16 WGLIQ_1G800H_1	Validated. No cal required.	Validated. No cal required.
Waveguide	MVG	SN 32/16 WG10_1	Validated. No cal required.	Validated. No cal required.
Liquid transition	MVG	SN 32/16 WGLIQ_3G500_1	Validated. No cal required.	Validated. No cal required.
Waveguide	MVG	SN 32/16 WG12_1	Validated. No cal required.	Validated. No cal required.

Page: 10/11

Template_ACR.DDD.N.YY.MVGB.ISSUE_COMOSAR Probe vK

This document shall not be reproduced, except in full or in part, without the written approval of MVG. The information contained herein is to be used only for the purpose for which it is submitted and is not to be released in whole or part without written approval of MVG.



COMOSAR E-FIELD PROBE CALIBRATION REPORT

Ref: ACR.180.7.22.BES.B

Liquid transition	MVG	SN 32/16 WGLIQ_5G000_1	Validated. No cal required.	Validated. No cal required.
Temperature / Humidity Sensor	Testo 184 H1	44225320	06/2021	06/2024



Dielectric Probe Calibration Report

Ref : ACR.138.4.33.SATU.A

SHENZHEN TONGCE TESTING LAB
2101&2201, ZHENCHANG FACTORY, RENSHAN
INDUSTRIAL ZONE, FUHAI SUBDISTRICT, BAOAN
DISTRICT, SHENZHEN, GUANGDONG, 518103,
PEOPLES REPUBLIC OF CHINA
MVG COMOSAR DOSIMETRIC E-FIELD PROBE

FREQUENCY: 0.3-6 GHZ
SERIAL NO.: SN 19/15 OCPG 71

Calibrated at MVG US
2105 Barrett Park Dr. - Kennesaw, GA 30144



Calibration Date: 06/05/2021

Summary:

This document presents the method and results from an accredited Dielectric Probe calibration performed in MVG USA using the LIMESAR test bench. All calibration results are traceable to national metrology institutions.



SAR DIELECTRIC PROBE CALIBRATION REPORT

Ref: ACR.138.4.33.SATUA

	Name	Function	Date	Signature
Prepared by :	Jérôme LUC	Product Manager	06/05/2021	<i>JS</i>
Checked by :	Jérôme LUC	Product Manager	06/05/2021	<i>JS</i>
Approved by :	Kim RUTKOWSKI	Quality Manager	06/05/2021	<i>Kim Rutkowski</i>

	Customer Name
Distribution :	SHENZHEN TONGCE TESTING LAB

Issue	Date	Modifications
A	06/05/2021	Initial release



TABLE OF CONTENTS

1 Introduction..... 4

2 Device Under Test 4

3 Product Description 4

 3.1 General Information 4

4 Measurement Method 5

 4.1 Liquid Permittivity Measurements 5

5 Measurement Uncertainty..... 5

 5.1 Dielectric Permittivity Measurement 5

6 Calibration Measurement Results..... 6

 6.1 Liquid Permittivity Measurement 6

7 List of Equipment 7



1 INTRODUCTION

This document contains a summary of the suggested methods and requirements set forth by the IEEE 1528 and CEI/IEC 62209 standards for liquid permittivity measurements and the measurements that were performed to verify that the product complies with the fore mentioned standards.

2 DEVICE UNDER TEST

Device Under Test	
Device Type	LIMESAR DIELECTRIC PROBE
Manufacturer	MVG
Model	SCLMP
Serial Number	SN 19/15 OCPG 71
Product Condition (new / used)	Used

A yearly calibration interval is recommended.

3 PRODUCT DESCRIPTION

3.1 GENERAL INFORMATION

MVG’s Dielectric Probes are built in accordance to the IEEE 1528 and CEI/IEC 62209 standards. The product is designed for use with the LIMESAR test bench only.



Figure 1 – MVG LIMESAR Dielectric Probe



4 MEASUREMENT METHOD

The IEEE 1528, OET 65 Bulletin C and CEI/IEC 62209-1 & 2 standards outline techniques for dielectric property measurements. The LIMESAR test bench employs one of the methods outlined in the standards, using a contact probe or open-ended coaxial transmission-line probe and vector network analyzer. The standards recommend the measurement of two reference materials that have well established and stable dielectric properties to validate the system, one for the calibration and one for checking the calibration. The LIMESAR test bench uses De-ionized water as the reference for the calibration and either DMS or Methanol as the reference for checking the calibration. The following measurements were performed to verify that the product complies with the fore mentioned standards.

4.1 LIQUID PERMITTIVITY MEASUREMENTS

The permittivity of a liquid with well established dielectric properties was measured and the measurement results compared to the values provided in the fore mentioned standards.

5 MEASUREMENT UNCERTAINTY

All uncertainties listed below represent an expanded uncertainty expressed at approximately the 95% confidence level using a coverage factor of k=2, traceable to the Internationally Accepted Guides to Measurement Uncertainty.

5.1 DIELECTRIC PERMITTIVITY MEASUREMENT

The following uncertainties apply to the Dielectric Permittivity measurement:

Uncertainty analysis of Permittivity Measurement					
ERROR SOURCES	Uncertainty value (+/-%)	Probability Distribution	Divisor	ci	Standard Uncertainty (+/-%)
Repeatability (n repeats, mid-band)	4.00%	N	1	1	4.000%
Deviation from reference liquid	5.00%	R	√3	1	2.887%
Network analyser-drift, linearity	2.00%	R	√3	1	1.155%
Test-port cable variations	0.00%	U	√2	1	0.000%
Combined standard uncertainty					5.066%
Expanded uncertainty (confidence level of 95%, k = 2)					10.0%

Uncertainty analysis of Conductivity Measurement					
ERROR SOURCES	Uncertainty value (+/-%)	Probability Distribution	Divisor	ci	Standard Uncertainty (+/-%)
Repeatability (n repeats, mid-band)	3.50%	N	1	1	3.500%
Deviation from reference liquid	3.00%	R	√3	1	1.732%
Network analyser-drift, linearity	2.00%	R	√3	1	1.155%
Test-port cable variations	0.00%	U	√2	1	0.000%
Combined standard uncertainty					4.072%
Expanded uncertainty (confidence level of 95%, k = 2)					8.1%



SAR DIELECTRIC PROBE CALIBRATION REPORT

Ref. ACR.138.4.33..SATU.A

6 CALIBRATION MEASUREMENT RESULTS

Measurement Condition

Software	LIMESAR
Liquid Temperature	21°C
Lab Temperature	21°C
Lab Humidity	44%

6.1 LIQUID PERMITTIVITY MEASUREMENT

A liquid of known characteristics (methanol at 20°C) is measured with the probe and the results (complex permittivity $\epsilon' + j\epsilon''$) are compared with the well-known theoretical values for this liquid.

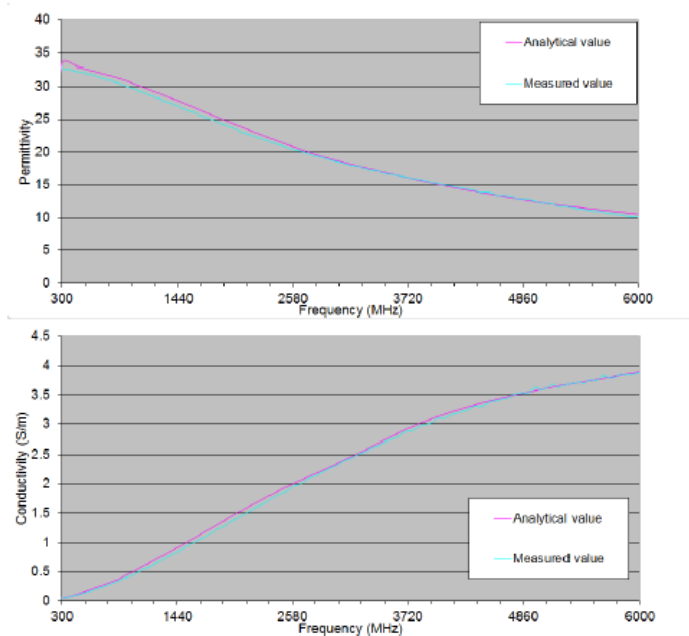



SAR DIELECTRIC PROBE CALIBRATION REPORT

Ref: ACR.138.4.33..SATU.A

7 LIST OF EQUIPMENT

Equipment Summary Sheet				
Equipment Description	Manufacturer / Model	Identification No.	Current Calibration Date	Next Calibration Date
LIMESAR Test Bench	Version 3	NA	Validated. No cal required.	Validated. No cal required.
Network Analyzer	Rhode & Schwarz ZVA	SN100132	02/2021	02/2024
Methanol CAS 67-56-1	Alpha Aesar	Lot D13W011	Validated. No cal required.	Validated. No cal required.
Temperature and Humidity Sensor	Control Company	11-661-9	09/2023	09/2024

Page: 7/7

*This document shall not be reproduced, except in full or in part, without the written approval of MVG.
The information contained herein is to be used only for the purpose for which it is submitted and is not to be released in whole or part without written approval of MVG.*

Appendix D: Dipole Calibration Report

SID 750



SAR Reference Dipole Calibration Report

Ref : ACR.156.3.15.SATU.A

SHENZHEN TONGCE TESTING LAB
2101&2201, ZHENCHANG FACTORY, RENSHAN
INDUSTRIAL ZONE, FUHAI SUBDISTRICT, BAOAN
DISTRICT, SHENZHEN, GUANGDONG, 518103,
PEOPLES REPUBLIC OF CHINA

COMOSAR REFERENCE DIPOLE
FREQUENCY: 750 MHZ
SERIAL NO.: SN 16/15 DIP 0G750-368

Calibrated at MVG US
2105 Barrett Park Dr. - Kennesaw, GA 30144



Calibration Date: 06/05/2021

Summary:

This document presents the method and results from an accredited SAR reference dipole calibration performed in MVG USA using the COMOSAR test bench. All calibration results are traceable to national metrology institutions.



SAR REFERENCE DIPOLE CALIBRATION REPORT

Ref. ACR.156.3.15.SATU.A

	<i>Name</i>	<i>Function</i>	<i>Date</i>	<i>Signature</i>
<i>Prepared by :</i>	Jérôme LUC	Product Manager	06/05/2021	<i>JLS</i>
<i>Checked by :</i>	Jérôme LUC	Product Manager	06/05/2021	<i>JLS</i>
<i>Approved by :</i>	Kim RUTKOWSKI	Quality Manager	06/05/2021	<i>Kim Rutkowski</i>

	<i>Customer Name</i>
<i>Distribution :</i>	SHENZHEN TONGC TESTING LAB

<i>Issue</i>	<i>Date</i>	<i>Modifications</i>
A	06/05/2021	Initial release



TABLE OF CONTENTS

1	Introduction.....	4
2	Device Under Test	4
3	Product Description	4
3.1	General Information	4
4	Measurement Method	5
4.1	Return Loss Requirements	5
4.2	Mechanical Requirements	5
5	Measurement Uncertainty	5
5.1	Return Loss	5
5.2	Dimension Measurement	5
5.3	Validation Measurement	5
6	Calibration Measurement Results	6
6.1	Return Loss and Impedance In Head Liquid	6
6.2	Return Loss and Impedance In Body Liquid	6
6.3	Mechanical Dimensions	6
7	Validation measurement	7
7.1	Head Liquid Measurement	7
7.2	SAR Measurement Result With Head Liquid	8
7.3	Body Liquid Measurement	9
7.4	SAR Measurement Result With Body Liquid	10
8	List of Equipment	11