



FCC&IC TEST REPORT

FCC ID: 2BA3P-P3

IC: 30492-P3

On Behalf of

GUANGZHOU MERCURY NAVIGATION TECHNOLOGY CO., LTD

P3 Handheld

Model No.: P3, P31, C3, C4, C5, C6, C7, C8, C9

Prepared for : GUANGZHOU MERCURY NAVIGATION TECHNOLOGY CO., LTD
Address : Room C401-403, TOPS Beidou Innovation Base, No.83, Kaiyuan
Avenue, Huangpu, Guangzhou, Guangdong, China

Prepared By : Shenzhen Alpha Product Testing Co., Ltd.
Address : Building i, No.2, Lixin Road, Fuyong Street, Bao'an District, 518103,
Shenzhen, Guangdong, China

Report Number : A2310171-C01-R16
Date of Receipt : October 27, 2023
Date of Test : October 27, 2023-December 12, 2023
Date of Report : December 15, 2023
Version Number : V0
Test Result : Pass

TABLE OF CONTENTS

Description	Page
1. Summary of Standards And Results	6
1.1. Description of Standards and Results	6
2. General Information	7
2.1. Description of Device (EUT)	7
2.2. Accessories of Device (EUT)	8
2.3. Tested Supporting System Details	8
2.4. Block Diagram of connection between EUT and simulators	8
2.5. Test Mode Description	8
2.6. Test Conditions	9
2.7. Test Facility	9
2.8. Measurement Uncertainty	9
2.9. Test Equipment List	10
3. Maximum Peak Output power	12
3.1. Limit	12
3.2. Test Procedure	12
3.3. Test Setup	12
3.4. Test Result	12
4. Bandwidth	13
4.1. Limit	13
4.2. Test Procedure	13
4.3. Test Result	13
5. Carrier Frequency Separation	24
5.1. Limit	24
5.2. Test Procedure	24
5.3. Test Result	24
6. Number Of Hopping Channel	26
6.1. Limit	26
6.2. Test Procedure	26
6.3. Test Result	26
7. Dwell Time	28
7.1. Test limit	28
7.2. Test Procedure	28
7.3. Test Result	28
8. Radiated emissions	38
8.1. Limit	38
8.2. Block Diagram of Test setup	41
8.3. Test Procedure	42
8.4. Test Result	42
9. Band Edge Compliance	53
9.1. Block Diagram of Test Setup	53

9.2. Limit	53
9.3. Test Procedure	53
9.4. Test Result.....	53
10. Power Line Conducted Emissions	60
10.1. Block Diagram of Test Setup	60
10.2. Limit	60
10.3. Test Procedure	60
10.4. Test Result.....	60
11. Frequency stability	64
11.1. Test limit.....	64
11.2. Test Procedure	64
11.3. Test Setup.....	64
11.4. Test Results	64
12. Antenna Requirements.....	66
12.1. Limit	66
12.2. Result	66
13. Test setup photo	67
13.1. Photo of Radiated Emission test	67
13.2. Photo of Conducted Emission test	68
14. EUT Photo.....	69

TEST REPORT DECLARATION

Applicant : GUANGZHOU MERCURY NAVIGATION TECHNOLOGY CO., LTD
 Address : Room C401-403, TOPS Beidou Innovation Base, No.83, Kaiyuan Avenue,
 Huangpu, Guangzhou, Guangdong, China
 Manufacturer : GUANGZHOU MERCURY NAVIGATION TECHNOLOGY CO., LTD
 Address : Room C401-403, TOPS Beidou Innovation Base, No.83, Kaiyuan Avenue,
 Huangpu, Guangzhou, Guangdong, China
 EUT Description : P3 Handheld
 (A) Model No. : P3, P31, C3, C4, C5, C6, C7, C8, C9
 (B) Trademark : N/A

Measurement Standard Used:

FCC Rules and Regulations Part 15 Subpart C Section 15.247

RSS-247 Issue 2, RSS-Gen Issue 5, ANSI C63.10:2013, CISPR 16-1-4:2010

The device described above is tested by Shenzhen Alpha Product Testing Co., Ltd. to determine the maximum emission levels emanating from the device. The maximum emission levels are compared to the FCC Part 15 Subpart C limits both conducted and radiated emissions. The test results are contained in this test report and Shenzhen Alpha Product Testing Co., Ltd. is assumed of full responsibility for the accuracy and completeness of these tests.

After the test, our opinion is that EUT compliance with the requirement of the above standards.

This report applies to above tested sample only. This report shall not be reproduced in parts without written approval of Shenzhen Alpha Product Testing Co., Ltd.

Tested by (name + signature).....: Yannis Wen
 Project Engineer 

Approved by (name + signature).....: Reak Yang
 Project Manager 

Date of issue.....: December 15, 2023

Revision History

Revision	Issue Date	Revisions	Revised By
V0	December 15, 2023	Initial released Issue	Yannis Wen

1. SUMMARY OF STANDARDS AND RESULTS

1.1. Description of Standards and Results

The EUT have been tested according to the applicable standards as referenced below:

Test Item	Standards Paragraph	Result
Maximum Peak Output Power	FCC Part 15: 15.247(b)(1) RSS-247(5.4 b), ANSI C63.10 :2013	P
Bandwidth	FCC Part 15: 15.215 RSS-247(5.1 a), ANSI C63.10 :2013	P
Carrier Frequency Separation	FCC Part 15: 15.247(a)(1) RSS-247(5.1 b), ANSI C63.10 :2013	P
Number Of Hopping Channel	FCC Part 15: 15.247(a)(1) RSS-247(5.1 d), ANSI C63.10 :2013	P
Dwell Time	FCC Part 15: 15.247(a)(1) RSS-247(5.1 d), ANSI C63.10 :2013	P
Radiated Emission	FCC Part 15: 15.209, FCC Part 15: 15.247(d) RSS-Gen(8.9), RSS-247(5.5), ANSI C63.10 :2013	P
Band Edge Compliance	FCC Part 15: 15.247(d), RSS-Gen(8.9), RSS-247(5.5) ANSI C63.10 :2013	P
Power Line Conducted Emissions	FCC Part 15: 15.207 RSS-GEN(8.8), ANSI C63.10 :2013	P
Frequency stability	RSS-GEN(6.11)	P
Antenna requirement	FCC Part 15: 15.203 RSS-GEN(6.8)	P
Note:	1. P is an abbreviation for Pass. 2. F is an abbreviation for Fail. 3. N/A is an abbreviation for Not Applicable.	

1. Pass: The EUT complies with the essential requirements in the standard.
2. Frequency Stability: The manufacturer stated in the user's manual.
3. The conclusion of this test report is judged by actual test data without considering measurement uncertainty.

2. GENERAL INFORMATION

2.1. Description of Device (EUT)

Description	:	P3 Handheld
Model Number	:	P3, P31, C3, C4, C5, C6, C7, C8, C9
Diff	:	There is no difference except the name of the model. All tests are made with the P3 model.
Power supply	:	DC 5V/9V from adapter with AC 120V/60Hz, DC 3.8V from battery
Radio Technology	:	Bluetooth V5.0 EDR
Operation frequency	:	2402-2480MHz
Channel No.	:	79 Channels
Channel spacing	:	1MHz
Modulation type	:	GFSK, $\pi/4$ DQPSK, 8DPSK
Antenna Type	:	Internal antenna, Maximum Gain is 1.75dBi. Antenna information is provided by applicant.
Software version	:	P3B_080
Hardware version	:	P3 MB V2.0
Connector cable loss	:	N/A
Intend use environment	:	Residential, commercial and light industrial environment

2.2. Accessories of Device (EUT)

Accessories	: Switching Adapter
Manufacturer	: DEE VAN ENTERPRISE CO., LTD.
Model	: DSA-45PDH
INPUT	: 100-240V~50/60Hz 1.5A
OUTPUT	: +5.0V = 3.0A, 15.0W; +9.0V = 3.0A, 27W; +12.0V = 3.0A, 36.0W; +15.0V = 3.0A, 45.0W; +20V = 2.25A, 45.0W

2.3. Tested Supporting System Details

No.	Description	Manufacturer	Model	Serial Number	Certification or SDoC
1.	--	--	--	--	--

2.4. Block Diagram of connection between EUT and simulators

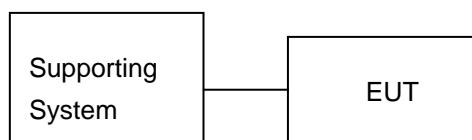

2.5. Test Mode Description

Tested mode, channel information		
Mode	Channel	Frequency (MHz)
GFSK	Low :CH1	2402
	Middle: CH40	2441
	High: CH79	2480
$\pi/4$ DQPSK	Low :CH1	2402
	Middle: CH40	2441
	High: CH79	2480
8DPSK	Low :CH1	2402
	Middle: CH40	2441
	High: CH79	2480

2.6. Test Conditions

Items	Required	Actual
Temperature range:	15-35°C	24°C
Humidity range:	25-75%	56%
Pressure range:	86-106kPa	980kPa

2.7. Test Facility

Shenzhen Alpha Product Testing Co., Ltd
 Building i, No.2, Lixin Road, Fuyong Street, Bao'an District, 518103,
 Shenzhen, Guangdong, China

June 21, 2018 File on Federal Communication Commission
 Registration Number: 293961

September 15, 2019 Certificated by IC
 Registration Number: CN0085

2.8. Measurement Uncertainty

(95% confidence levels, k=2)

Item	Uncertainty
Uncertainty for Power point Conducted Emissions Test	1.63dB
Uncertainty for Radiation Emission test in 3m chamber (below 30MHz)	3.5dB
Uncertainty for Radiation Emission test in 3m chamber (30MHz to 1GHz)	3.74dB(Polarize: V)
	3.76dB(Polarize: H)
Uncertainty for Radiation Emission test in 3m chamber (1GHz to 25GHz)	3.77dB(Polarize: V)
	3.80dB(Polarize: H)
Uncertainty for Radiation Emission test in 3m chamber (18GHz to 40GHz)	4.31 dB(Polarize: V)
	4.30 dB(Polarize: H)
Uncertainty for radio frequency	5.06×10^{-8} GHz
Uncertainty for conducted RF Power	0.40dB
Uncertainty for temperature	0.2°C
Uncertainty for humidity	1%
Uncertainty for DC and low frequency voltages	0.06%

2.9. Test Equipment List

Equipment	Manufacture	Model No.	Firmware version	Serial No.	Last cal.	Cal Interval
9*6*6 anechoic chamber	CHENYU	9*6*6	/	N/A	2022.05.17	3Year
Spectrum analyzer	ROHDE&SCHWARZ	FSV40-N	2.3	102137	2023.08.16	1Year
Spectrum analyzer	Agilent	N9020A	A.14.16	MY499100060	2023.08.16	1Year
Receiver	ROHDE&SCHWARZ	ESR	2.28 SP1	1316.3003K03-10 2082-Wa	2023.08.16	1Year
Receiver	R&S	ESCI	4.42 SP1	101165	2023.08.16	1Year
Bilog Antenna	Schwarzbeck	VULB 9168	/	VULB 9168#627	2023.08.28	1Year
Horn Antenna	SCHWARZBECK	BBHA 9120 D	/	2106	2023.08.19	1Year
Loop Antenna	SCHWARZBECK	FMZB 1519B	/	00128	2023.08.19	1Year
RF Cable	Resenberger	Cable 1	/	RE1	2023.08.16	1Year
RF Cable	Resenberger	Cable 2	/	RE2	2023.08.16	1Year
RF Cable	Resenberger	Cable 3	/	CE1	2023.08.16	1Year
Pre-amplifier	HP	HP8347A	/	2834A00455	2023.08.16	1Year
Pre-amplifier	Agilent	8449B	/	3008A02664	2023.08.16	1Year
L.I.S.N.#1	Schwarzbeck	NSLK8126	/	8126-466	2023.08.16	1Year
L.I.S.N.#2	ROHDE&SCHWARZ	ENV216	/	101043	2023.08.16	1Year
Horn Antenna	SCHWARZBECK	BBHA 9170	/	00946	2023.08.19	1Year
Preamplifier	SKET	LNPA_1840 -50	/	SK2018101801	2023.08.16	1 Year
Power Meter	Agilent	E9300A	/	MY41496628	2023.08.16	1 Year
Power Sensor	DARE	RPR3006W	/	15100041SNO91	2023.08.16	1 Year
Temp. & Humid. Chamber	Teelong	TL-HW408S	/	TL-20191205-01	2023.07.25	1 Year
Switching Mode Power Supply	JUNKE	JK12010S	/	20140927-6	2023.08.16	1 Year
Adjustable attenuator	MWRFtest	N/A	/	N/A	N/A	N/A
10dB Attenuator	Mini-Circuits	DC-6G	/	N/A	N/A	N/A

Software Information			
Test Item	Software Name	Manufacturer	Version
RE	EZ-EMC	EZ	Alpha-3A1
CE	EZ-EMC	EZ	Alpha-3A1
RF-CE	MTS 8310	MW	V2.0.0.0

3. MAXIMUM PEAK OUTPUT POWER

3.1. Limit

Please refer section 15.247 & RSS-247

For frequency hopping systems operating in the 2400-2483.5 MHz band employing at least 75 non-overlapping hopping channels, and all frequency hopping systems in the 5725-5850 MHz band: 1 watt. For all other frequency hopping systems in the 2400-2483.5 MHz band: 0.125 watts, the e.i.r.p shall not exceed 4W

3.2. Test Procedure

The transmitter output is connected to the RF Power Meter. The RF Power Meter is set to the peak power detection.

3.3. Test Setup

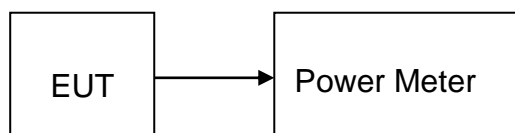

3.4. Test Result

Condition	Mode	Frequency (MHz)	Antenna	Conducted Power (dBm)	Duty Factor (dB)	EIRP (dBm)	Limit (dBm)	Verdict
NVNT	1-DH1	2402	Ant1	5.917	0	7.667	21	Pass
NVNT	1-DH1	2441	Ant1	5.545	0	7.295	21	Pass
NVNT	1-DH1	2480	Ant1	3.917	0	5.667	21	Pass
NVNT	1-DH3	2441	Ant1	5.506	0	7.256	21	Pass
NVNT	1-DH5	2441	Ant1	5.447	0	7.197	21	Pass
NVNT	2-DH1	2402	Ant1	4.908	0	6.658	21	Pass
NVNT	2-DH1	2441	Ant1	4.75	0	6.5	21	Pass
NVNT	2-DH1	2480	Ant1	3.586	0	5.336	21	Pass
NVNT	2-DH3	2441	Ant1	4.82	0	6.57	21	Pass
NVNT	2-DH5	2441	Ant1	4.736	0	6.486	21	Pass
NVNT	3-DH1	2402	Ant1	5.376	0	7.126	21	Pass
NVNT	3-DH1	2441	Ant1	4.902	0	6.652	21	Pass
NVNT	3-DH1	2480	Ant1	3.615	0	5.365	21	Pass
NVNT	3-DH3	2441	Ant1	4.631	0	6.381	21	Pass
NVNT	3-DH5	2441	Ant1	4.725	0	6.475	21	Pass

4. BANDWIDTH

4.1. Limit

Intentional radiators operating under the alternative provisions to the general emission limits, as contained in RSS-GEN, FCC Section 15.247(a)(1), must be designed to ensure that the 20 dB bandwidth of the emission, or whatever bandwidth may otherwise be specified in the specific rule section under which the equipment operates, is contained within the frequency band designated in the rule section under which the equipment is operated..

4.2. Test Procedure

The RF output of EUT was connected to the spectrum analyzer by RF cable and attenuator. The bandwidth of the fundamental frequency was measured by spectrum analyzer with 30kHz RBW and 100kHz VBW. The 20dB bandwidth is defined as the total spectrum the power of which is higher than peak power minus 20dB.

4.3. Test Result

-20dB Bandwidth

Condition	Mode	Frequency (MHz)	Antenna	-20 dB Bandwidth (MHz)	Limit -20 dB Bandwidth (MHz)	Verdict
NVNT	1-DH1	2402	Ant1	0.752	/	Pass
NVNT	1-DH1	2441	Ant1	0.842	/	Pass
NVNT	1-DH1	2480	Ant1	0.782	/	Pass
NVNT	2-DH1	2402	Ant1	1.206	/	Pass
NVNT	2-DH1	2441	Ant1	1.234	/	Pass
NVNT	2-DH1	2480	Ant1	1.19	/	Pass
NVNT	3-DH1	2402	Ant1	1.214	/	Pass
NVNT	3-DH1	2441	Ant1	1.212	/	Pass
NVNT	3-DH1	2480	Ant1	1.214	/	Pass

-20dB Bandwidth NVNT 1-DH1 2402MHz Ant1

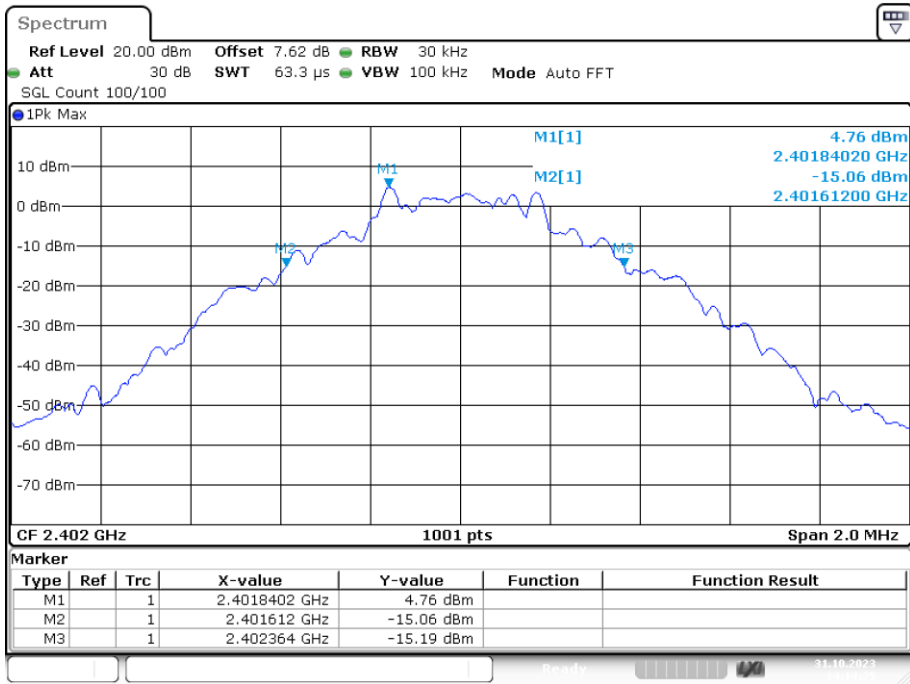

Date: 31.OCT.2023 14:14:25

-20dB Bandwidth NVNT 1-DH1 2441MHz Ant1

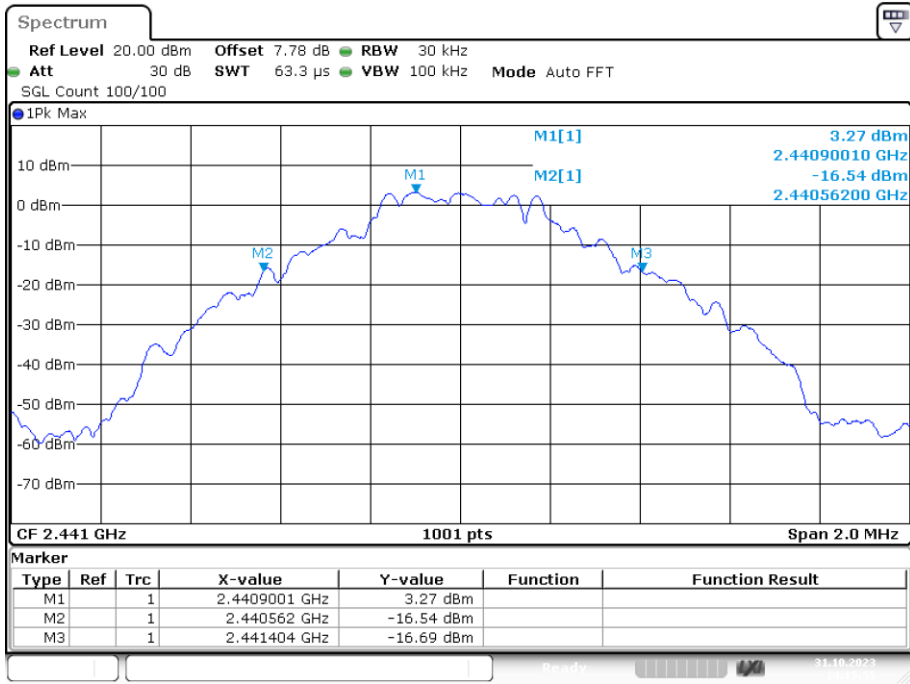

Date: 31.OCT.2023 14:15:55

-20dB Bandwidth NVNT 1-DH1 2480MHz Ant1

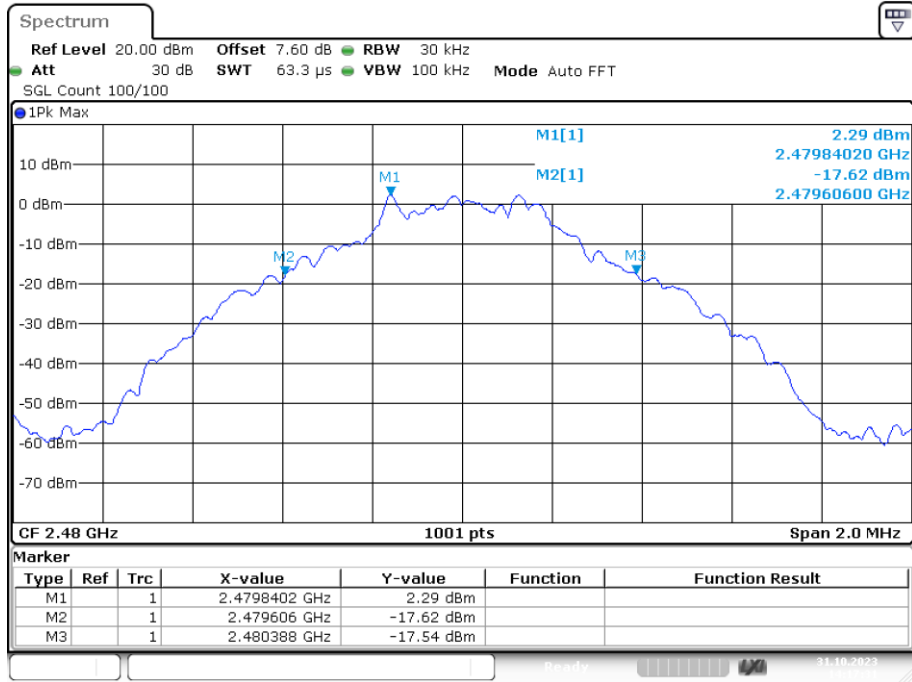

Date: 31.OCT.2023 14:17:31

-20dB Bandwidth NVNT 2-DH1 2402MHz Ant1

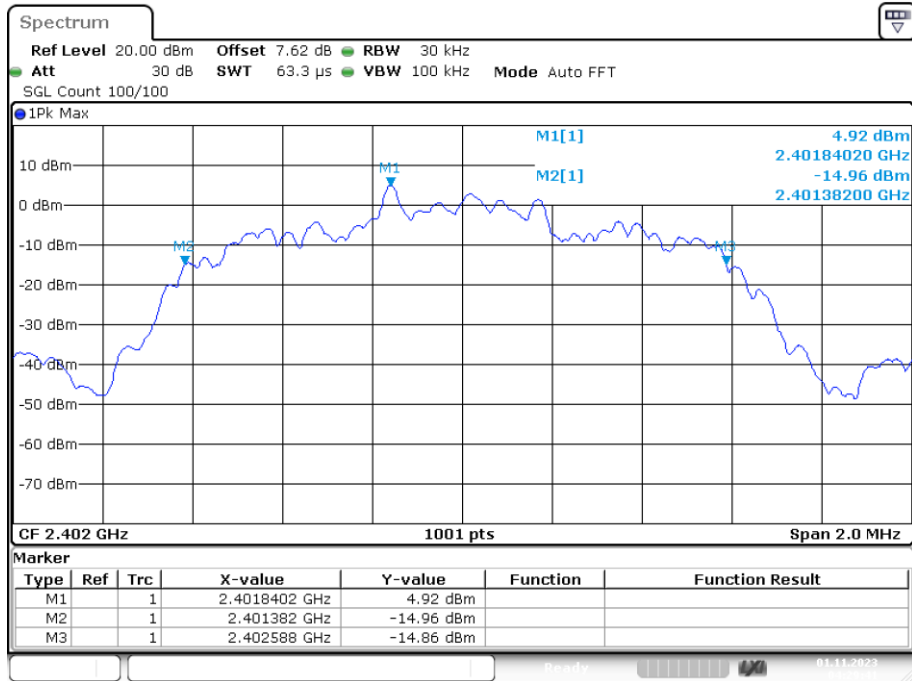

Date: 1.NOV.2023 04:29:40

-20dB Bandwidth NVNT 2-DH1 2441MHz Ant1

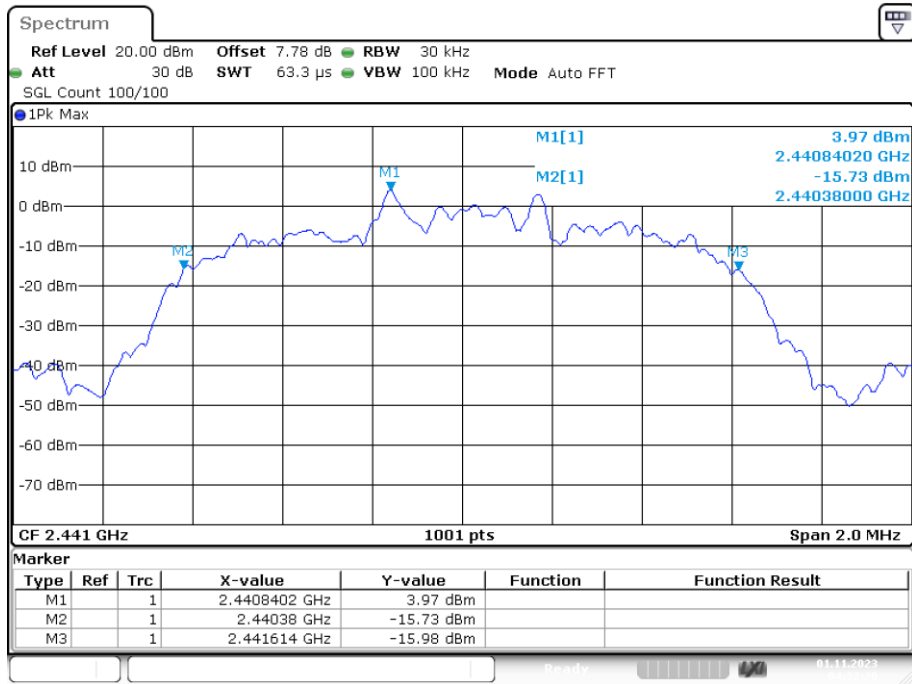

Date: 1.NOV.2023 04:32:19

-20dB Bandwidth NVNT 2-DH1 2480MHz Ant1

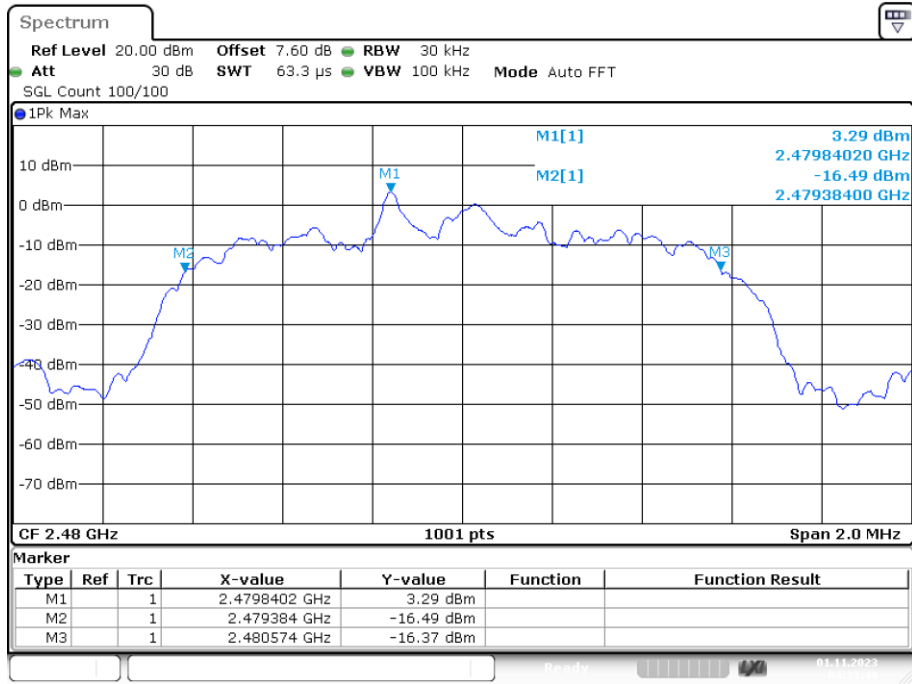

Date: 1.NOV.2023 04:33:49

-20dB Bandwidth NVNT 3-DH1 2402MHz Ant1

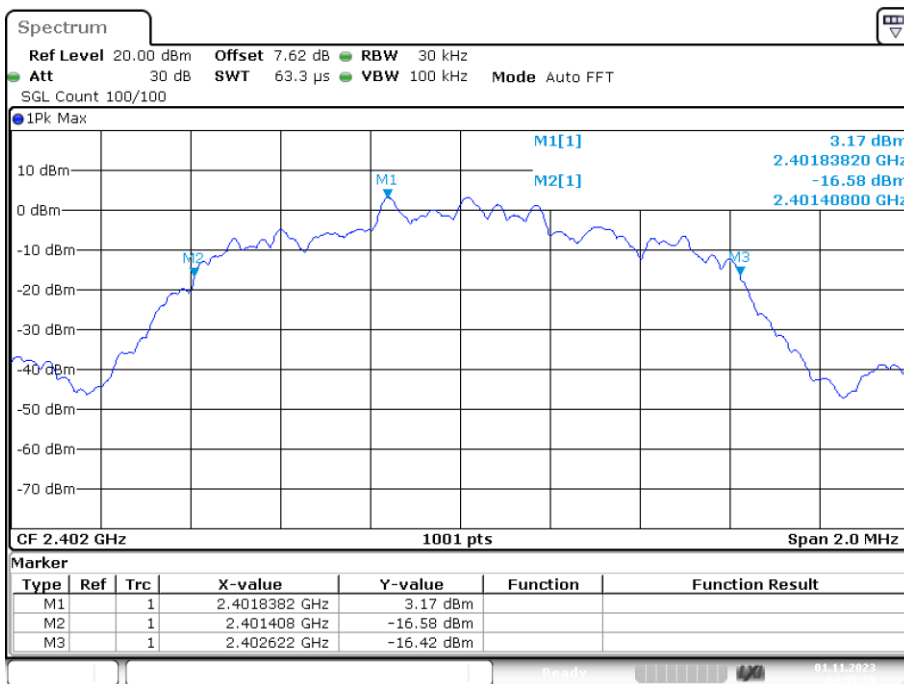

Date: 1.NOV.2023 04:59:58

-20dB Bandwidth NVNT 3-DH1 2441MHz Ant1

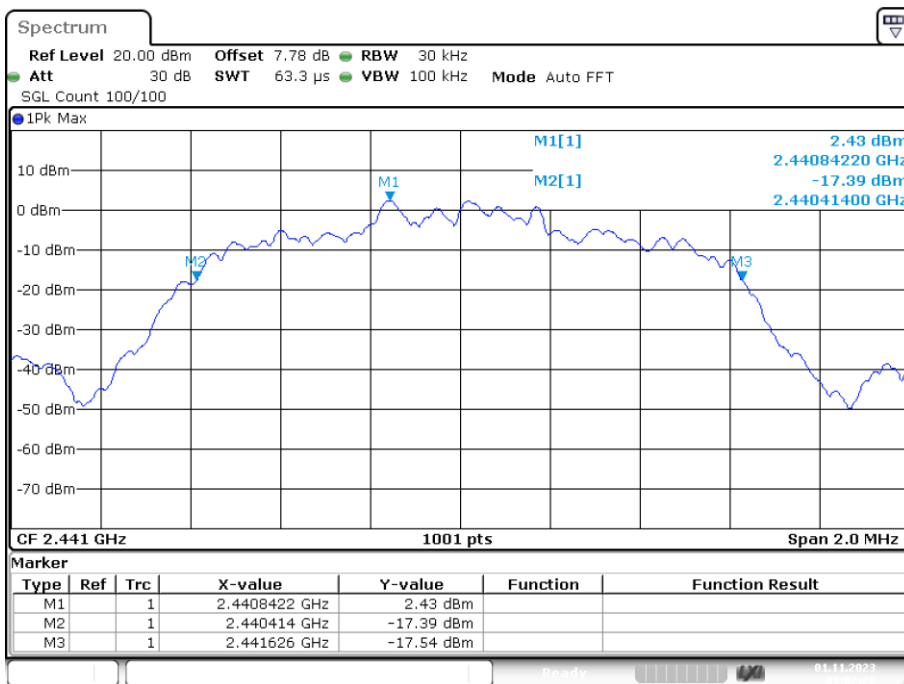

Date: 1.NOV.2023 05:02:20

-20dB Bandwidth NVNT 3-DH1 2480MHz Ant1

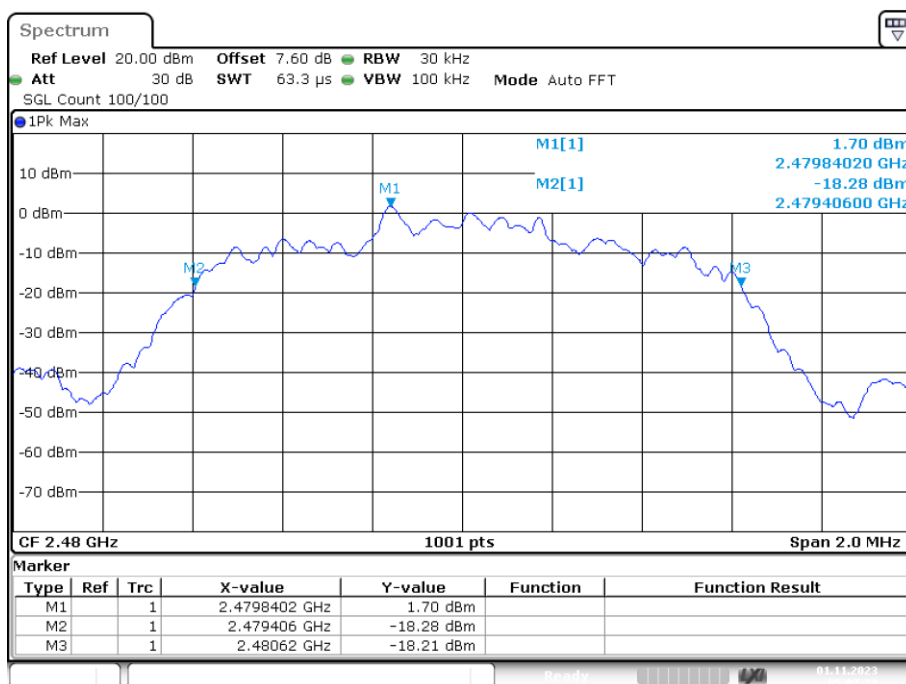

Date: 1.NOV.2023 05:07:24

Occupied Channel Bandwidth

Condition	Mode	Frequency (MHz)	Antenna	99% OBW (MHz)
NVNT	1-DH1	2402	Ant1	0.729
NVNT	1-DH1	2441	Ant1	0.737
NVNT	1-DH1	2480	Ant1	0.731
NVNT	2-DH1	2402	Ant1	1.137
NVNT	2-DH1	2441	Ant1	1.117
NVNT	2-DH1	2480	Ant1	1.117
NVNT	3-DH1	2402	Ant1	1.135
NVNT	3-DH1	2441	Ant1	1.123
NVNT	3-DH1	2480	Ant1	1.123

OBW NVNT 1-DH1 2402MHz Ant1

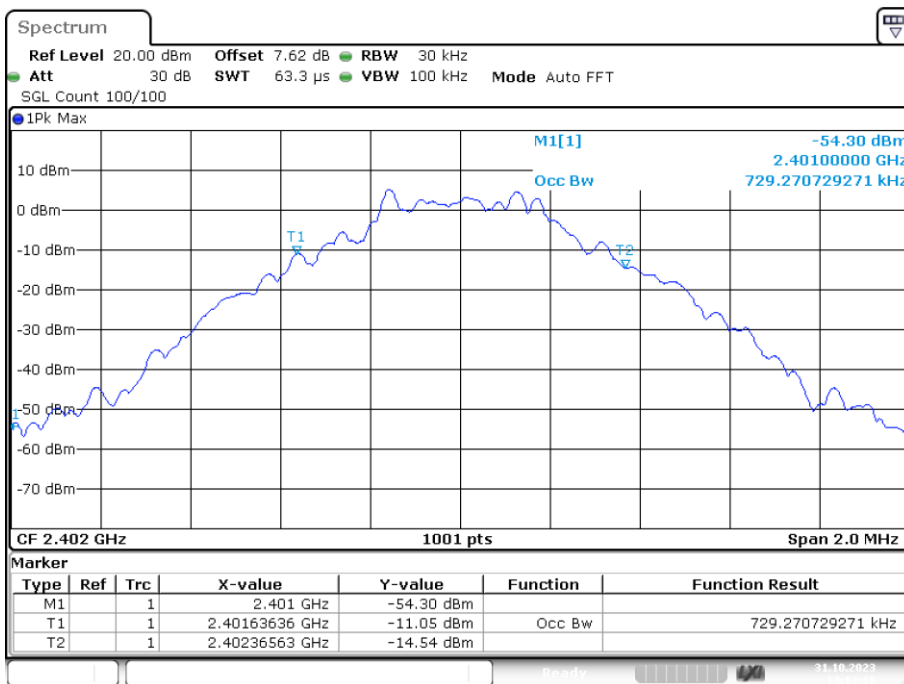

Date: 31.OCT.2023 14:14:17

OBW NVNT 1-DH1 2441MHz Ant1

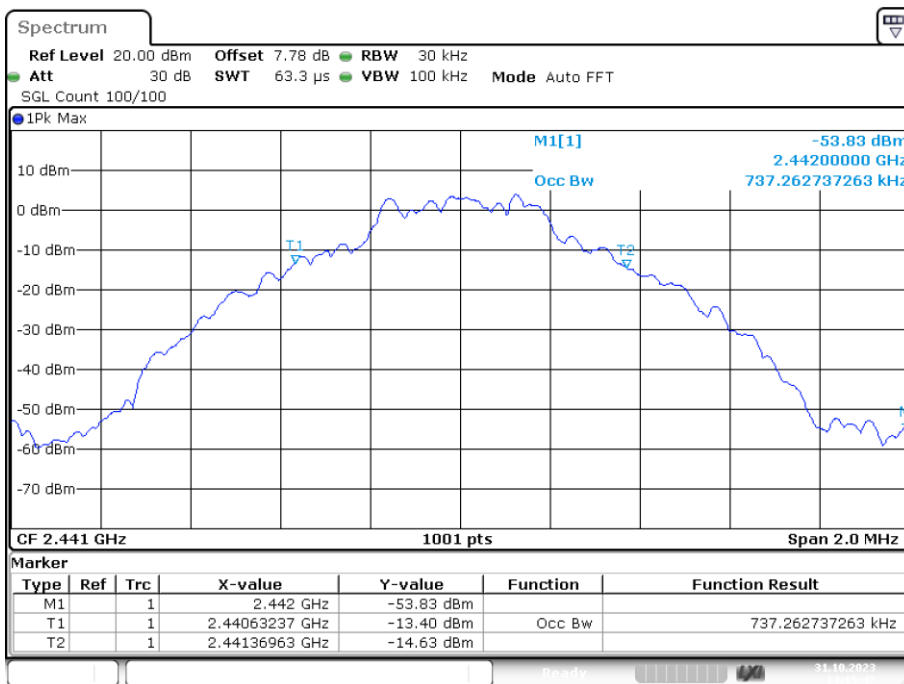

Date: 31.OCT.2023 14:15:47

OBW NVNT 1-DH1 2480MHz Ant1

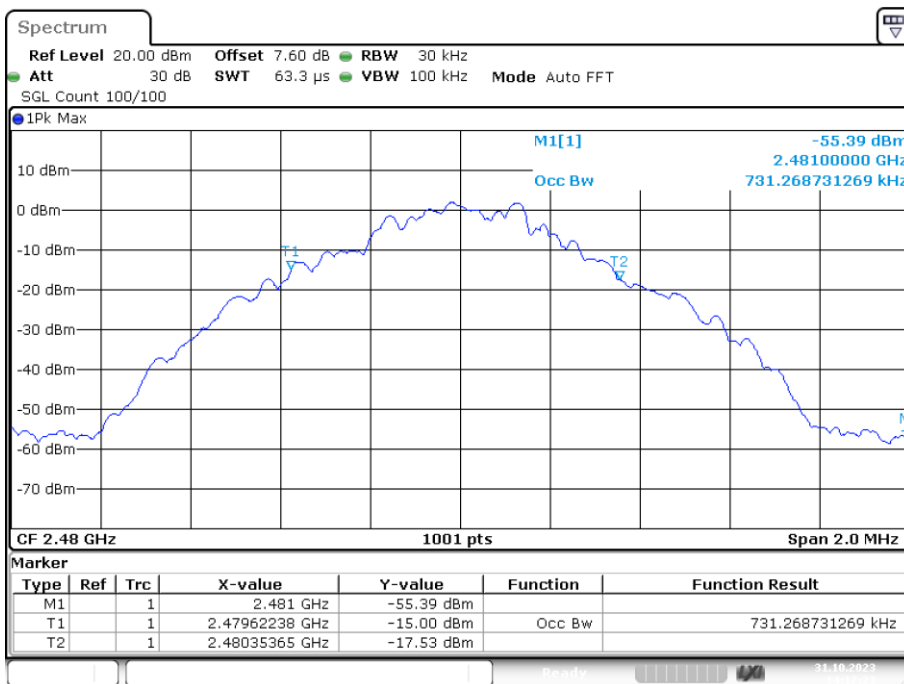

Date: 31.OCT.2023 14:17:22

OBW NVNT 2-DH1 2402MHz Ant1

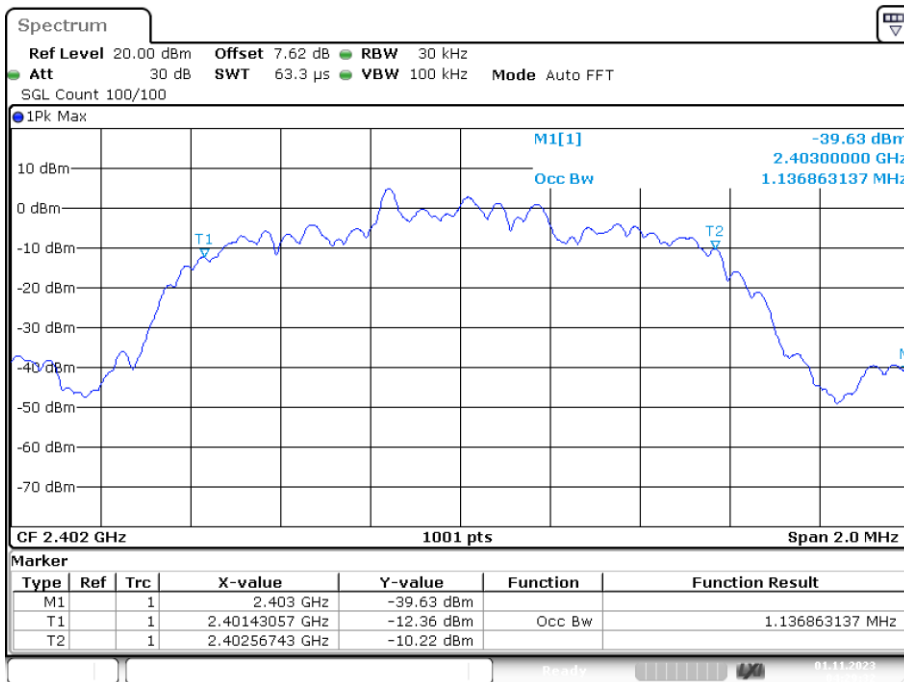

Date: 1.NOV.2023 04:29:32

OBW NVNT 2-DH1 2441MHz Ant1

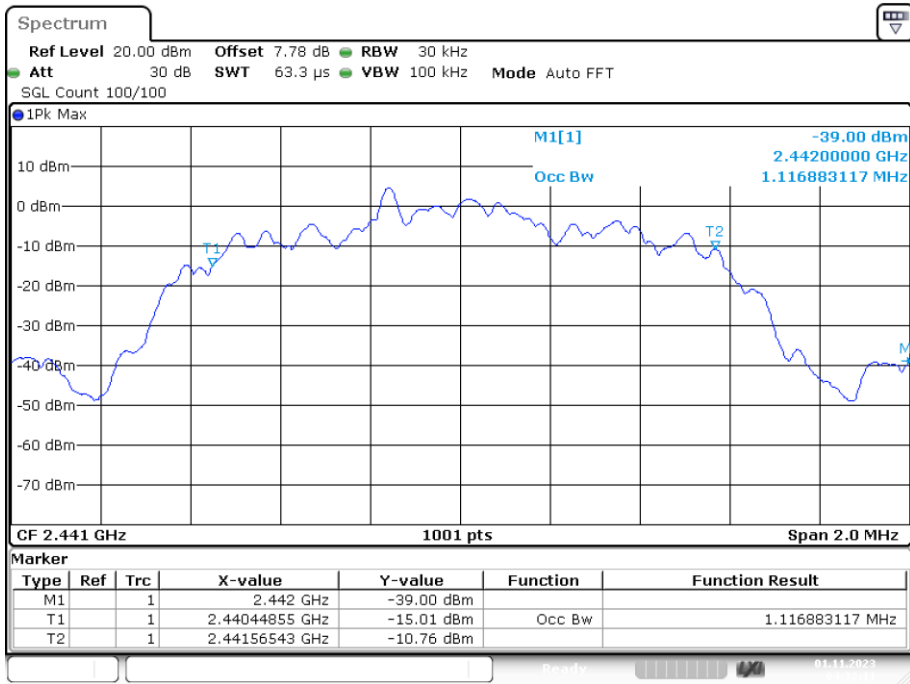

Date: 1.NOV.2023 04:32:11

OBW NVNT 2-DH1 2480MHz Ant1

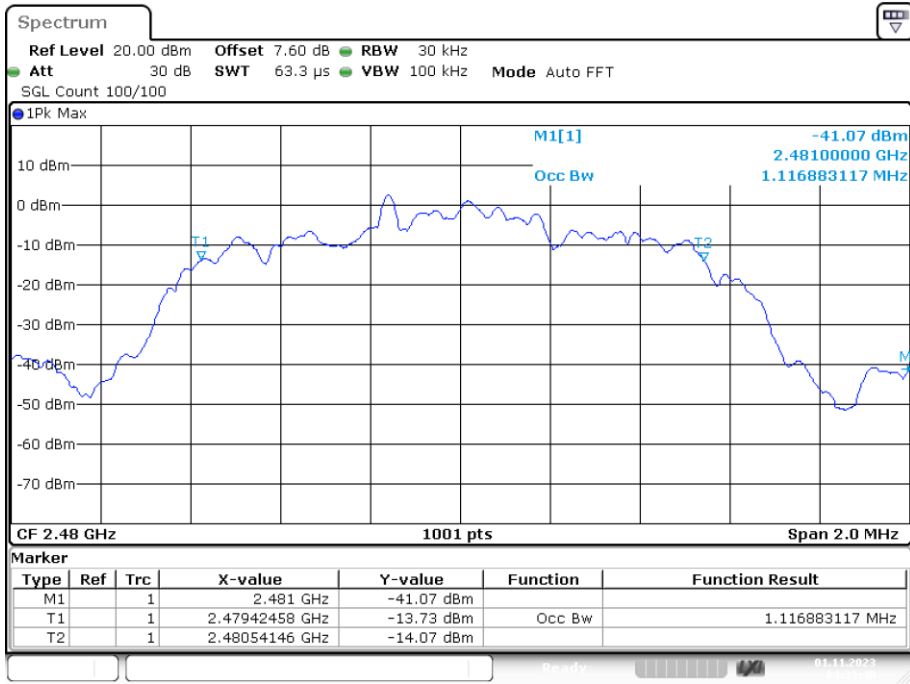

Date: 1.NOV.2023 04:33:40

OBW NVNT 3-DH1 2402MHz Ant1

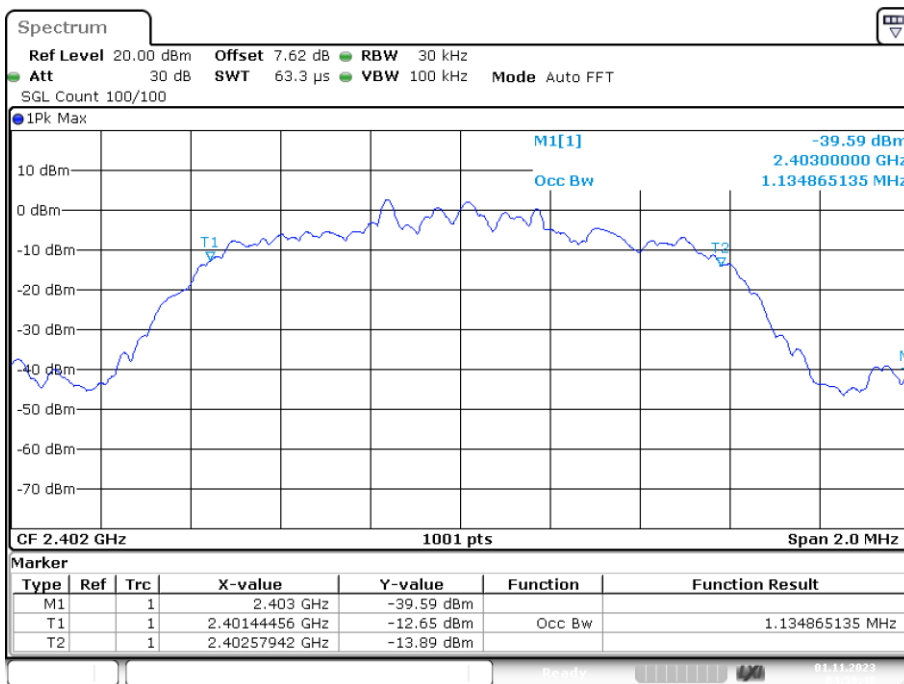

Date: 1.NOV.2023 04:59:48

OBW NVNT 3-DH1 2441MHz Ant1

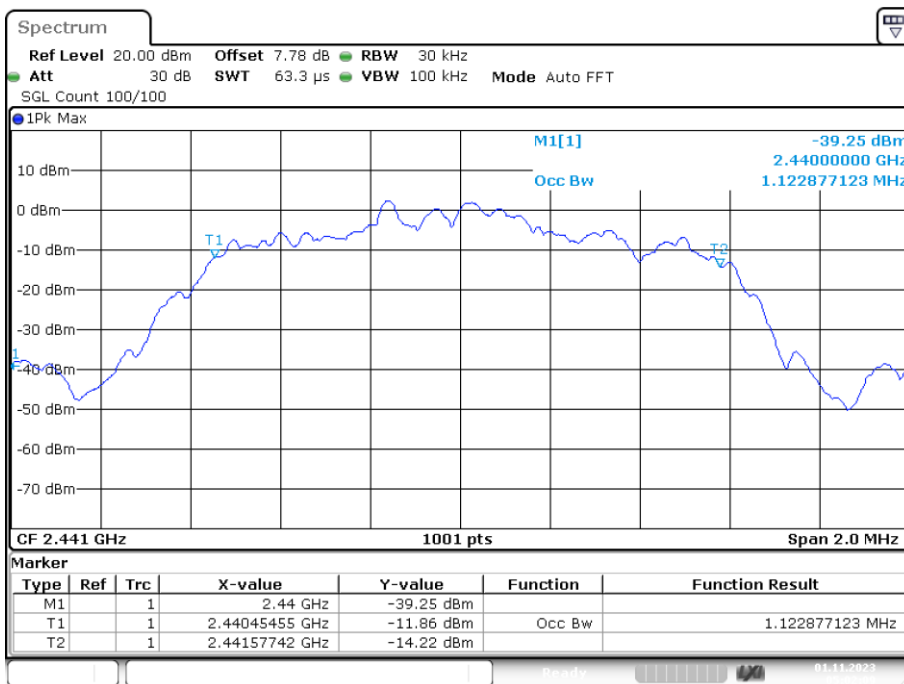

Date: 1.NOV.2023 05:02:08

OBW NVNT 3-DH1 2480MHz Ant1

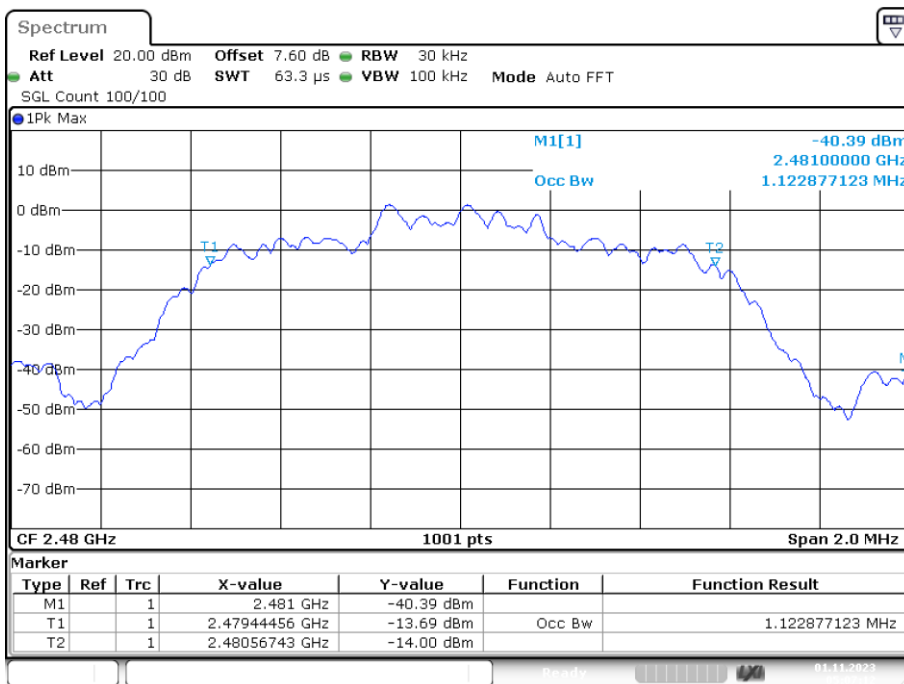

Date: 1.NOV.2023 05:07:12

5. CARRIER FREQUENCY SEPARATION

5.1. Limit

Frequency hopping systems shall have hopping channel carrier frequencies separated by a minimum of 25 kHz or the 20 dB bandwidth of the hopping channel, whichever is greater. Alternatively, frequency hopping systems operating in the 2400-2483.5 MHz band may have hopping channel carrier frequencies that are separated by 25 kHz or two-thirds of the 20 dB bandwidth of the hopping channel, whichever is greater, provided the systems operate with an output power no greater than 125 mW

5.2. Test Procedure

The RF output of EUT was connected to the spectrum analyzer by RF cable and attenuator. The carrier frequency was measured by spectrum analyzer with 30kHz RBW and 100kHz VBW.

5.3. Test Result

Condition	Mode	Antenna	Hopping Freq1 (MHz)	Hopping Freq2 (MHz)	HFS (MHz)	Limit (MHz)	Verdict
NVNT	1-DH1	Ant1	2440.842	2441.842	1	0.842	Pass
NVNT	2-DH1	Ant1	2440.84	2441.84	1	0.823	Pass
NVNT	3-DH1	Ant1	2440.84	2441.84	1	0.808	Pass

CFS NVNT 1-DH1 2441MHz Ant1

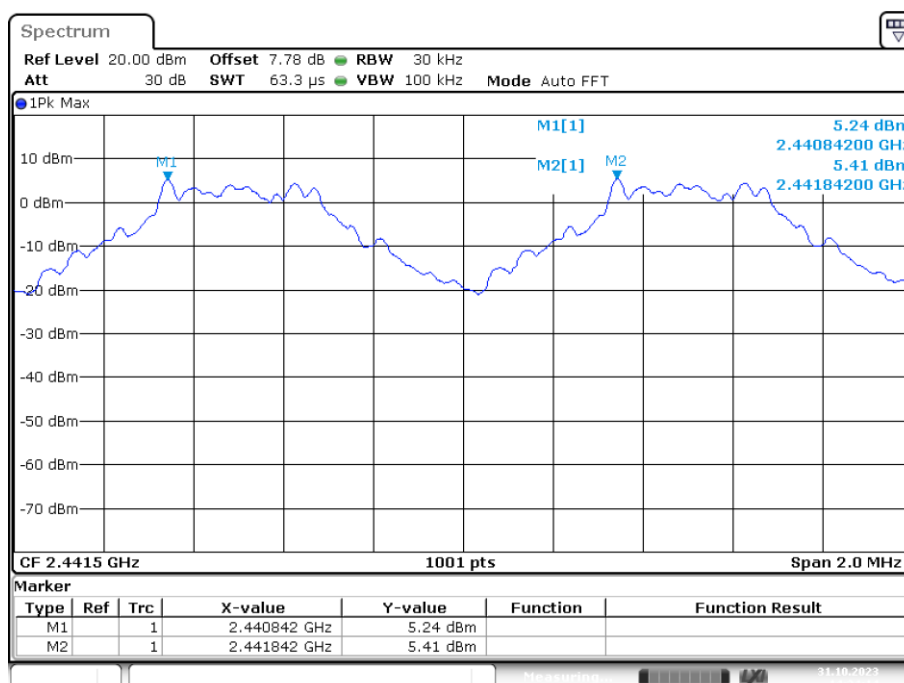

Date: 31.OCT.2023 14:24:14

CFS NVNT 2-DH1 2441MHz Ant1

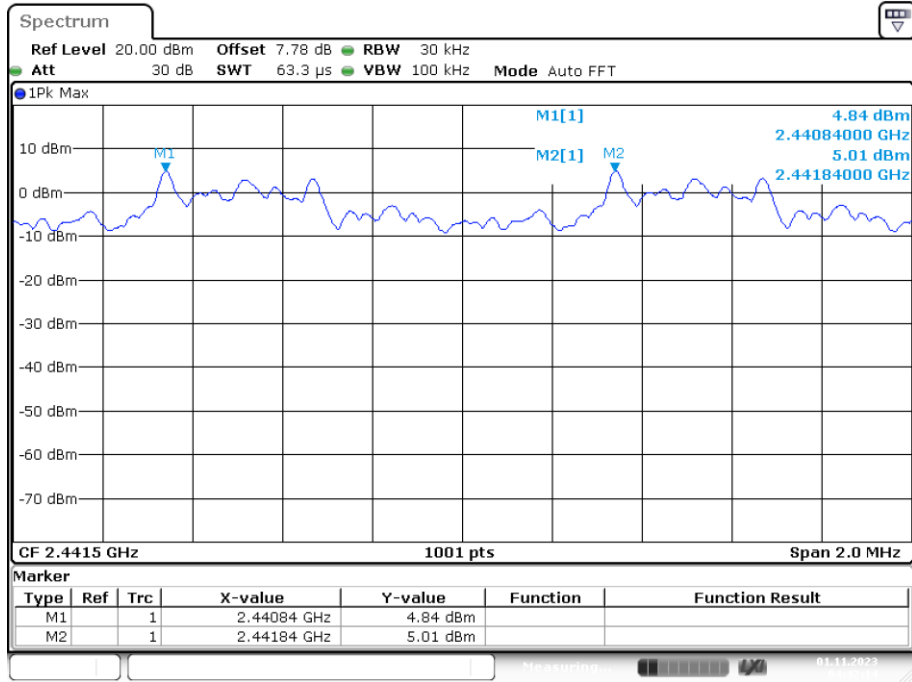

Date: 1.NOV.2023 04:42:14

CFS NVNT 3-DH1 2441MHz Ant1

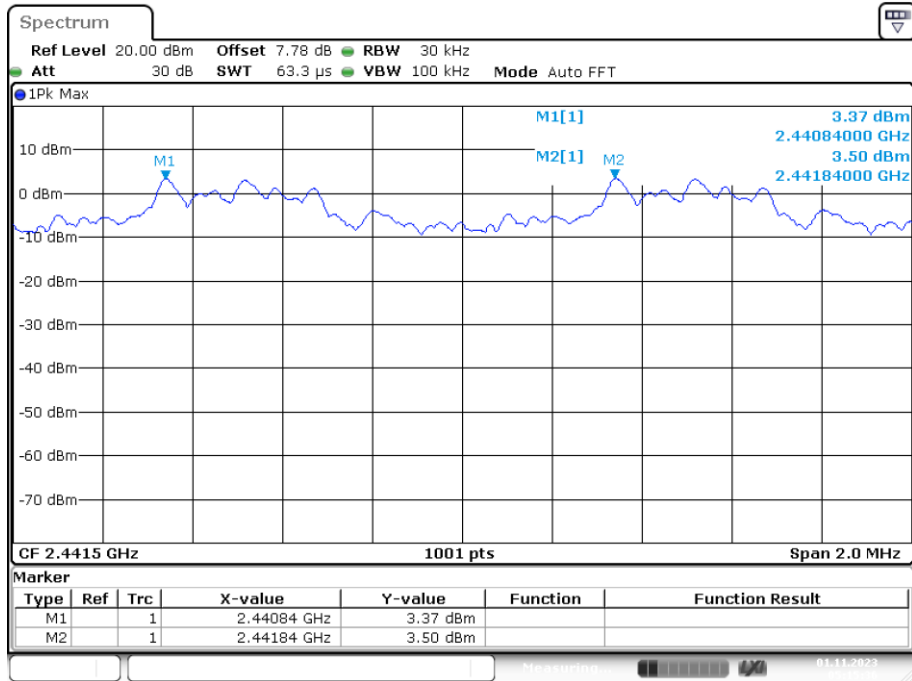

Date: 1.NOV.2023 05:15:35

6. NUMBER OF HOPPING CHANNEL

6.1. Limit

Frequency hopping systems in the 2400-2483.5 MHz band shall use at least 15 channels

6.2. Test Procedure

The RF output of EUT was connected to the spectrum analyzer by RF cable and attenuator. The number of hopping channel was measured by spectrum analyzer with 100kHz RBW and 300KHz VBW.

6.3. Test Result

Condition	Mode	Hopping Number	Limit	Verdict
NVNT	1-DH1	79	15	Pass
NVNT	2-DH1	79	15	Pass
NVNT	3-DH1	79	15	Pass

Hopping No. NVNT 1-DH1 2441MHz Ant1

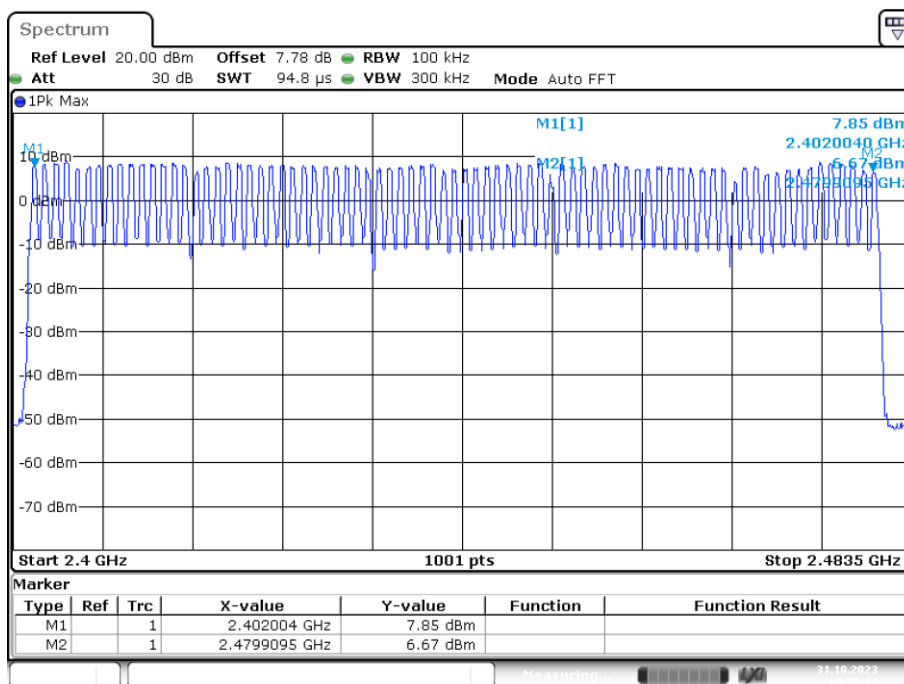

Date: 31.OCT.2023 14:30:12

Hopping No. NVNT 2-DH1 2441MHz Ant1

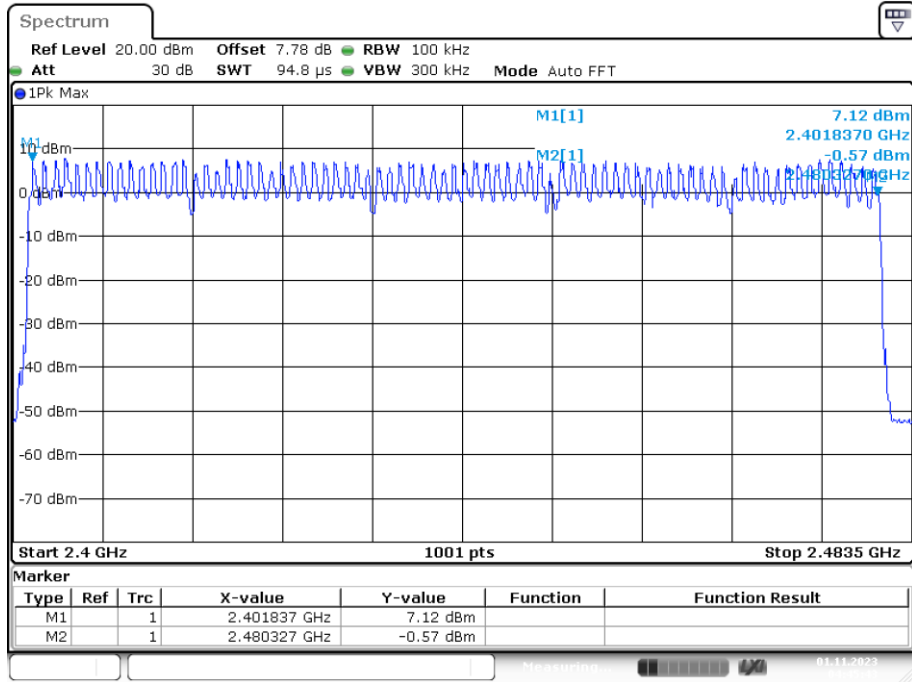

Date: 1.NOV.2023 04:45:43

Hopping No. NVNT 3-DH1 2441MHz Ant1

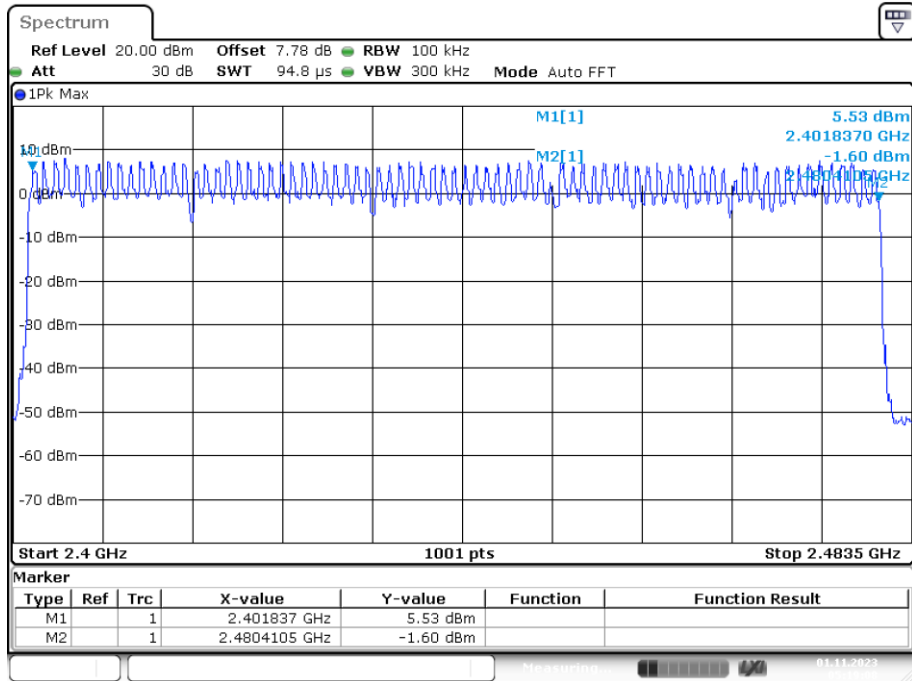

Date: 1.NOV.2023 05:19:08

7. DWELL TIME

7.1. Test limit

Please refer section 15.247 & RSS-247.

According to §15.247(a)(1)(iii), Frequency hopping systems operating in the 2400MHz-2483.5 MHz. The average time of occupancy on any frequency shall not greater than 0.4 s within period of 0.4 seconds multiplied by the number of hopping channel employed.

7.2. Test Procedure

- 7.2.1. Place the EUT on the table and set it in transmitting mode.
- 7.2.2. Remove the antenna from the EUT and then connect a low loss RF cable from the antenna port to the spectrum analyzer.
- 7.2.3. Set center frequency of spectrum analyzer = operating frequency.
- 7.2.4. Set the spectrum analyzer as RBW=1MHz, VBW=1MHz, Span = 0Hz, Sweep = auto.
- 7.2.5. Repeat above procedures until all frequency measured were complete.

7.3. Test Result

Condition	Mode	Frequency (MHz)	Antenna	Pulse Time (ms)	Total Dwell Time (ms)	Burst Count	Period Time (ms)	Limit (ms)	Verdict
NVNT	1-DH1	2441	Ant1	0.377	120.640	313	31600	400	Pass
NVNT	1-DH3	2441	Ant1	1.634	261.440	161	31600	400	Pass
NVNT	1-DH5	2441	Ant1	2.88	307.200	103	31600	400	Pass
NVNT	2-DH1	2441	Ant1	0.384	122.880	319	31600	400	Pass
NVNT	2-DH3	2441	Ant1	1.635	261.600	159	31600	400	Pass
NVNT	2-DH5	2441	Ant1	2.88	307.200	103	31600	400	Pass
NVNT	3-DH1	2441	Ant1	0.386	123.520	316	31600	400	Pass
NVNT	3-DH3	2441	Ant1	1.635	261.600	158	31600	400	Pass
NVNT	3-DH5	2441	Ant1	2.885	307.733	113	31600	400	Pass

Note: Total Dwell Time= Pulse Time* Burst Count

Dwell NVNT 1-DH1 2441MHz Ant1 One Burst

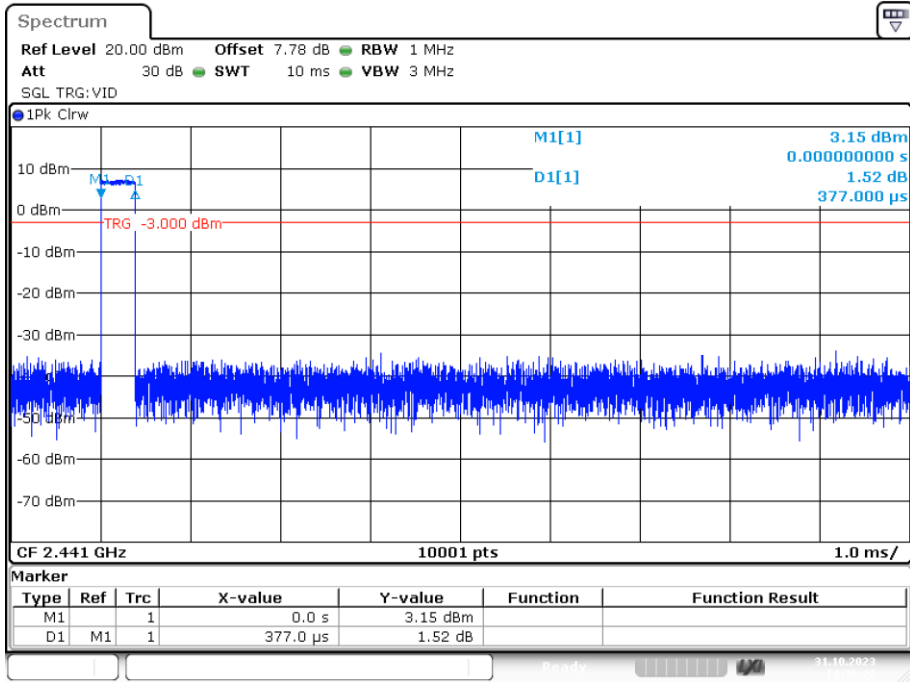

Date: 31.OCT.2023 14:30:22

Dwell NVNT 1-DH1 2441MHz Ant1 Accumulated

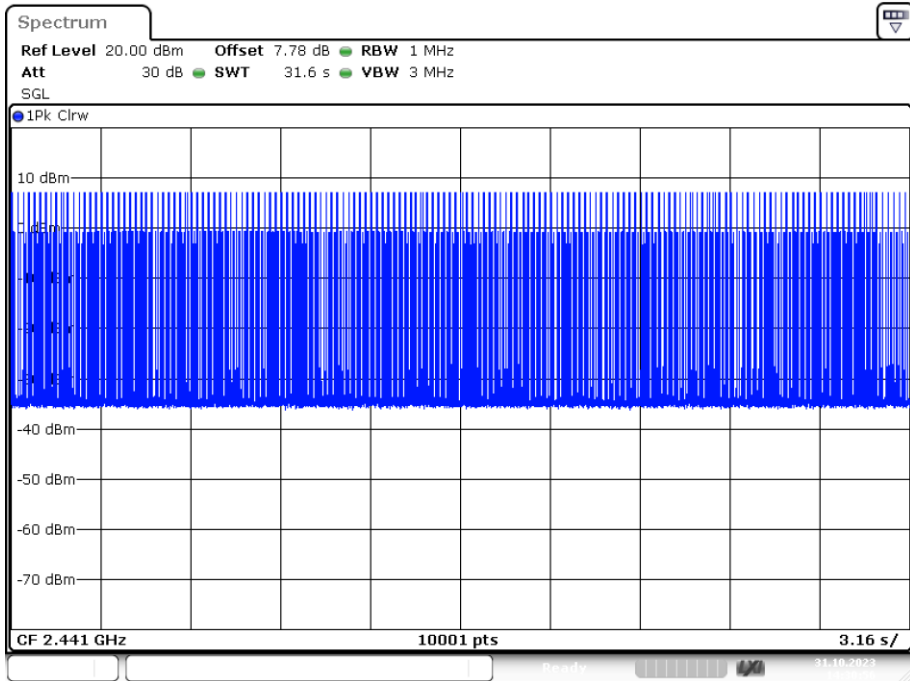

Date: 31.OCT.2023 14:30:56

Dwell NVNT 1-DH3 2441MHz Ant1 One Burst

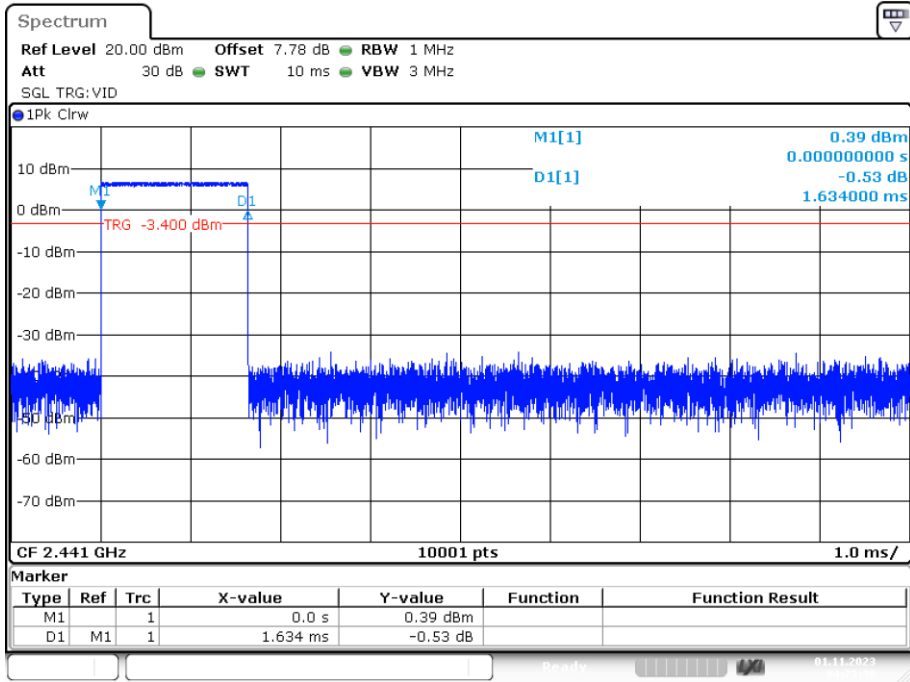

Date: 1.NOV.2023 04:23:37

Dwell NVNT 1-DH3 2441MHz Ant1 Accumulated

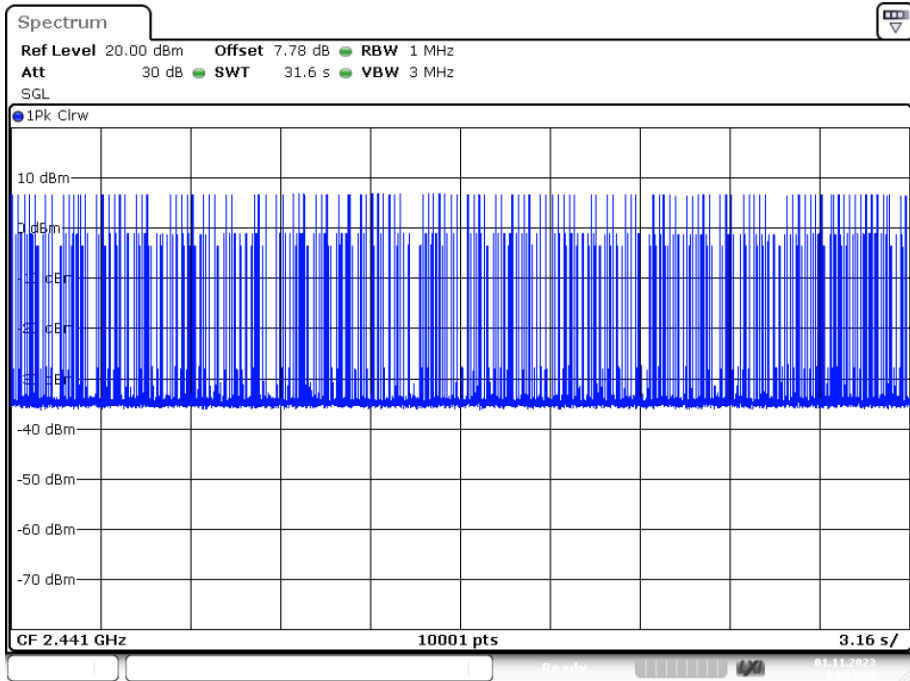

Date: 1.NOV.2023 04:24:12

Dwell NVNT 1-DH5 2441MHz Ant1 One Burst

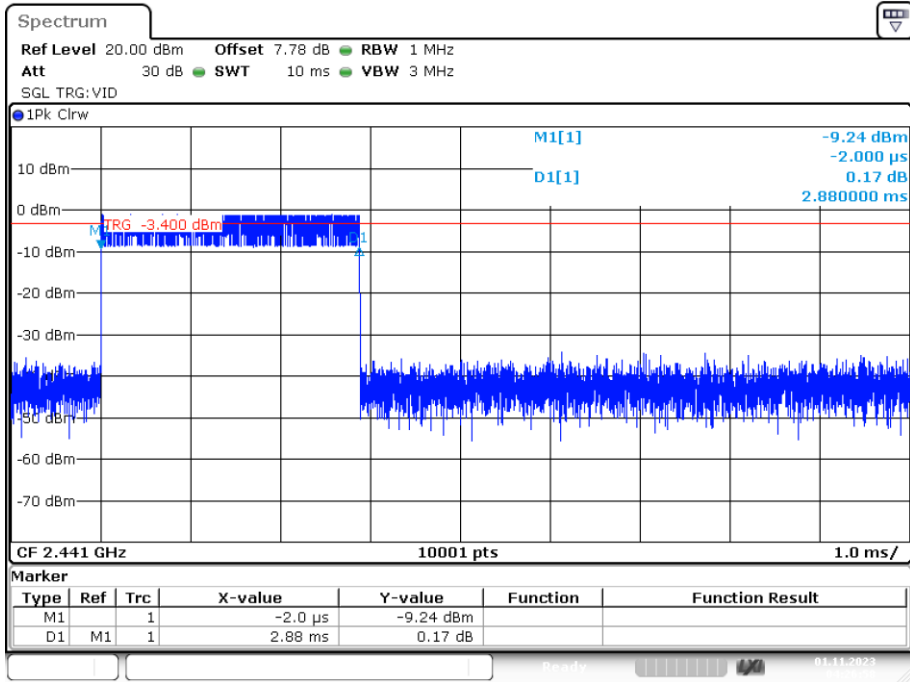

Date: 1.NOV.2023 04:26:57

Dwell NVNT 1-DH5 2441MHz Ant1 Accumulated

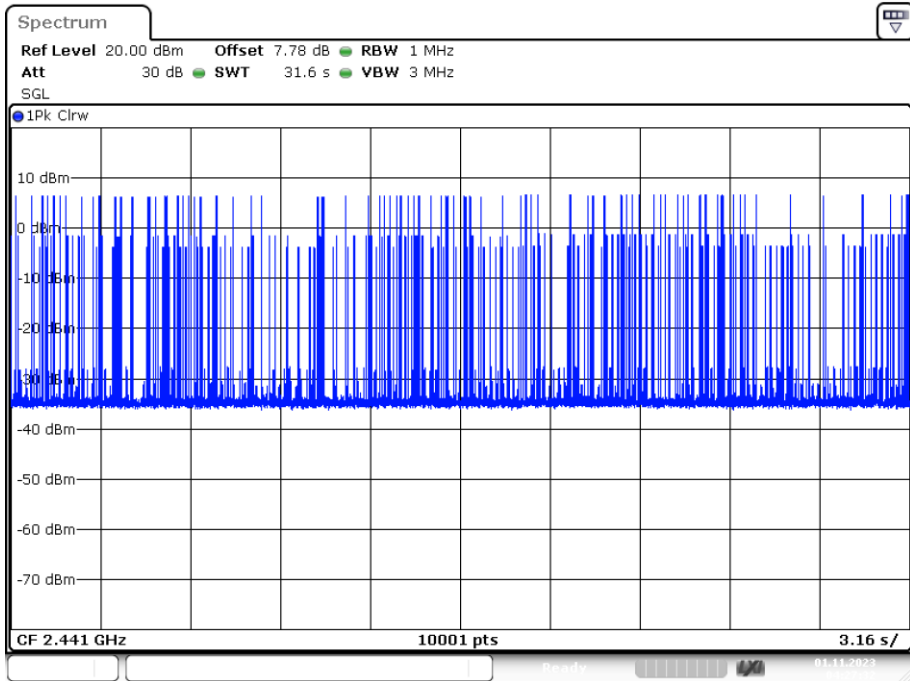

Date: 1.NOV.2023 04:27:32

Dwell NVNT 2-DH1 2441MHz Ant1 One Burst

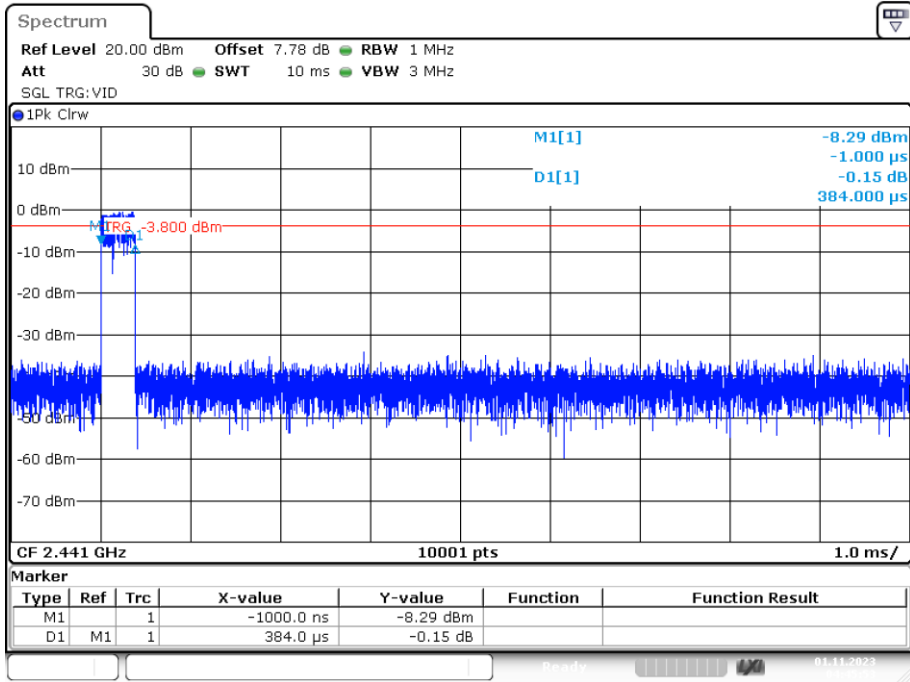

Date: 1.NOV.2023 04:45:53

Dwell NVNT 2-DH1 2441MHz Ant1 Accumulated

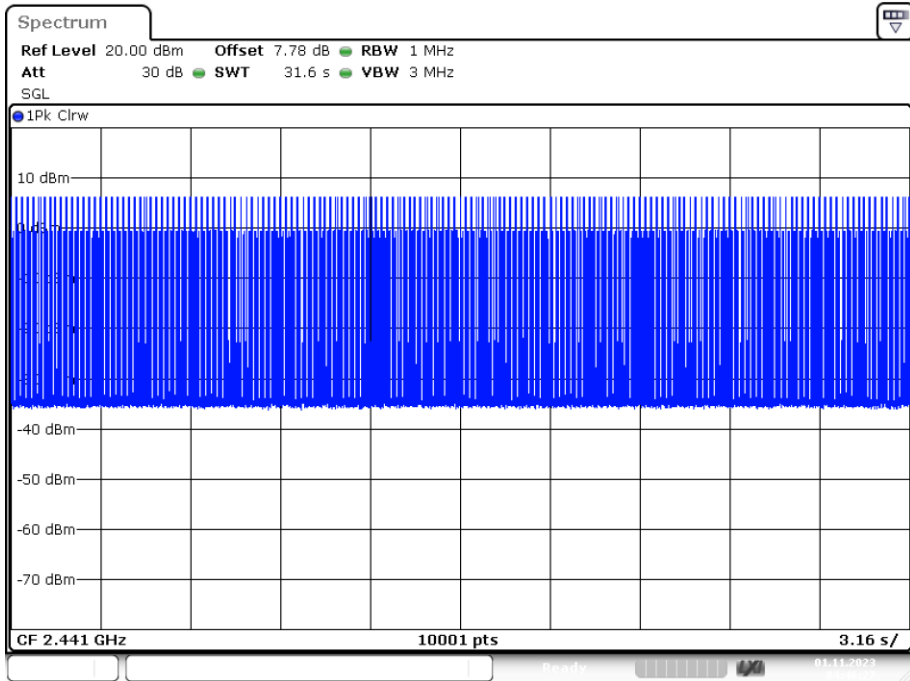

Date: 1.NOV.2023 04:46:27

Dwell NVNT 2-DH3 2441MHz Ant1 One Burst

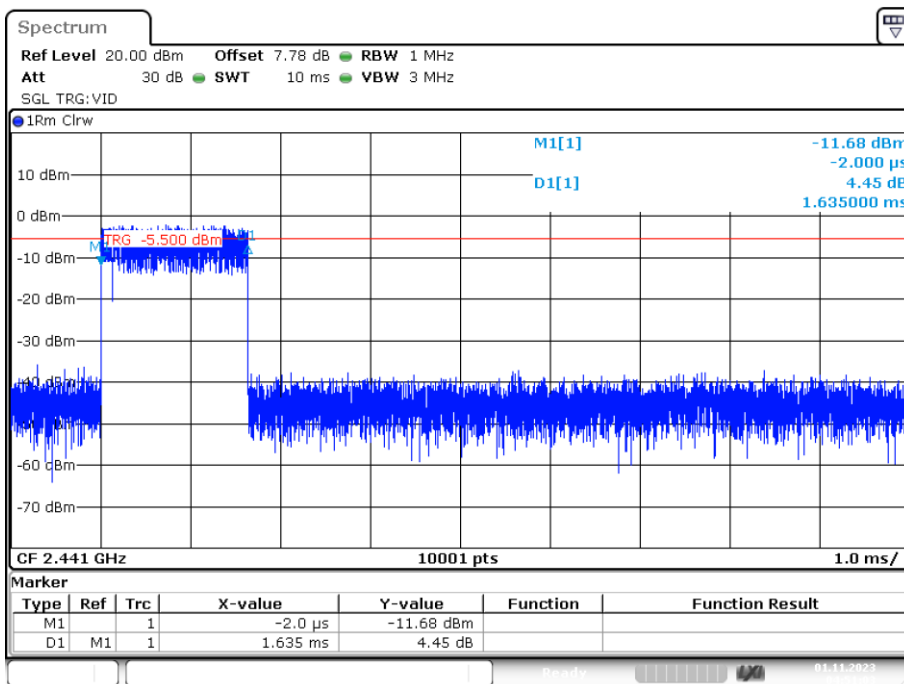

Date: 1.NOV.2023 04:51:03

Dwell NVNT 2-DH3 2441MHz Ant1 Accumulated

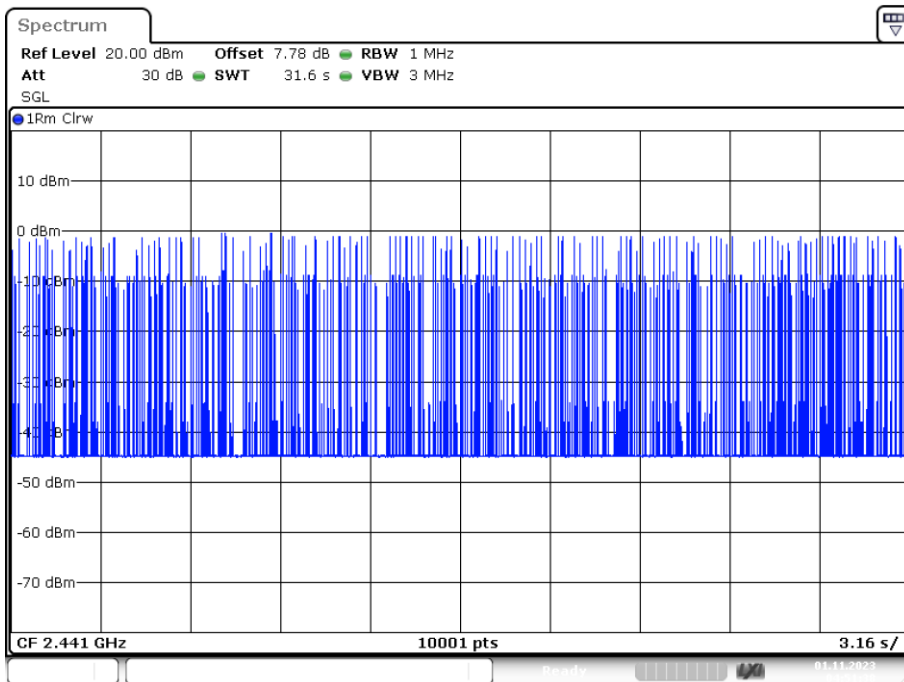

Date: 1.NOV.2023 04:51:38

Dwell NVNT 2-DH5 2441MHz Ant1 One Burst

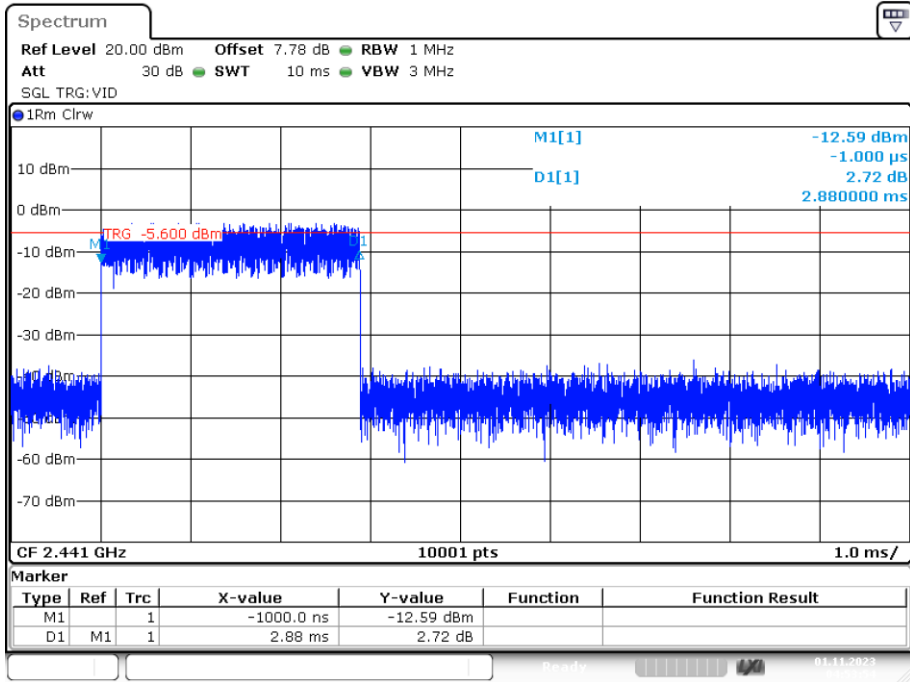

Date: 1.NOV.2023 04:53:54

Dwell NVNT 2-DH5 2441MHz Ant1 Accumulated

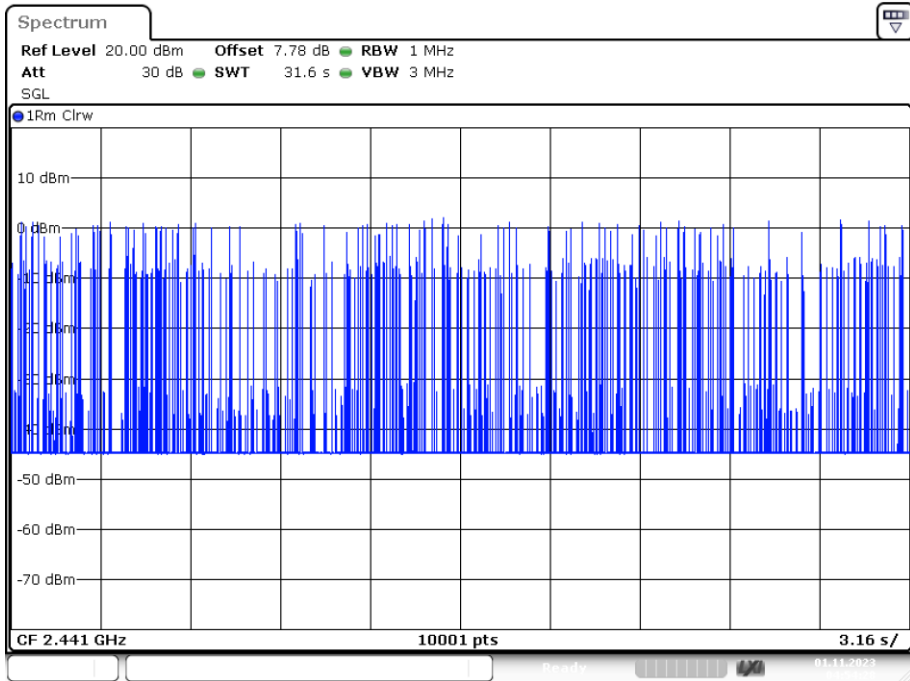

Date: 1.NOV.2023 04:54:28

Dwell NVNT 3-DH1 2441MHz Ant1 One Burst

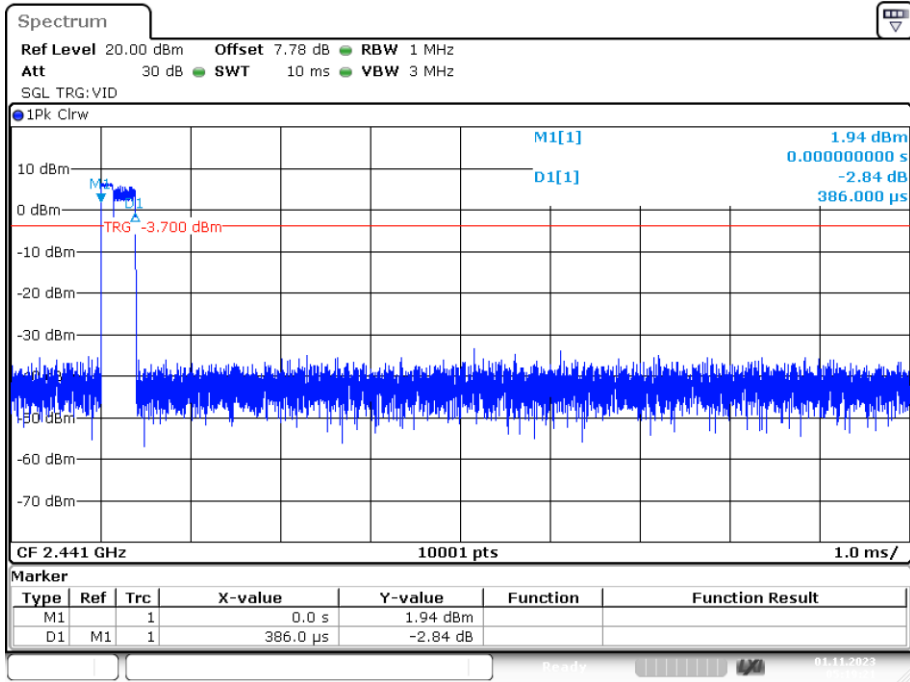

Date: 1.NOV.2023 05:19:21

Dwell NVNT 3-DH1 2441MHz Ant1 Accumulated

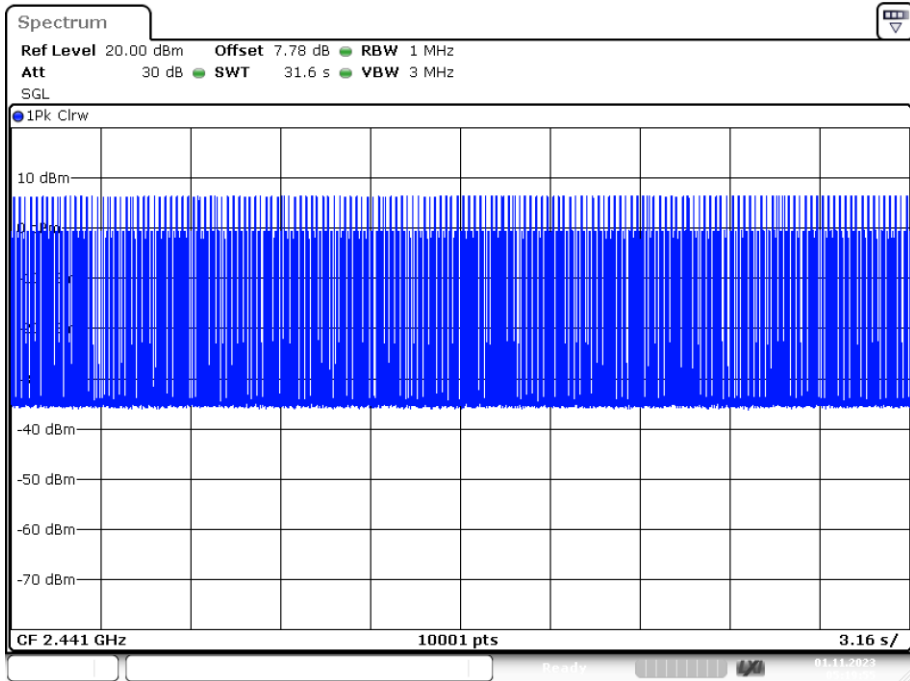

Date: 1.NOV.2023 05:19:55

Dwell NVNT 3-DH3 2441MHz Ant1 One Burst

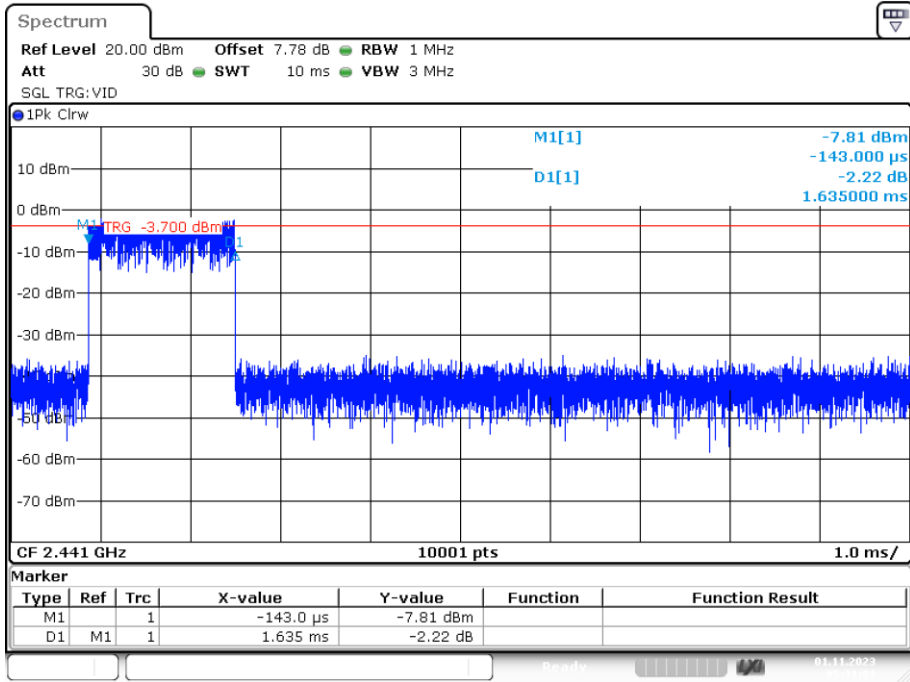

Date: 1.NOV.2023 05:31:01

Dwell NVNT 3-DH3 2441MHz Ant1 Accumulated

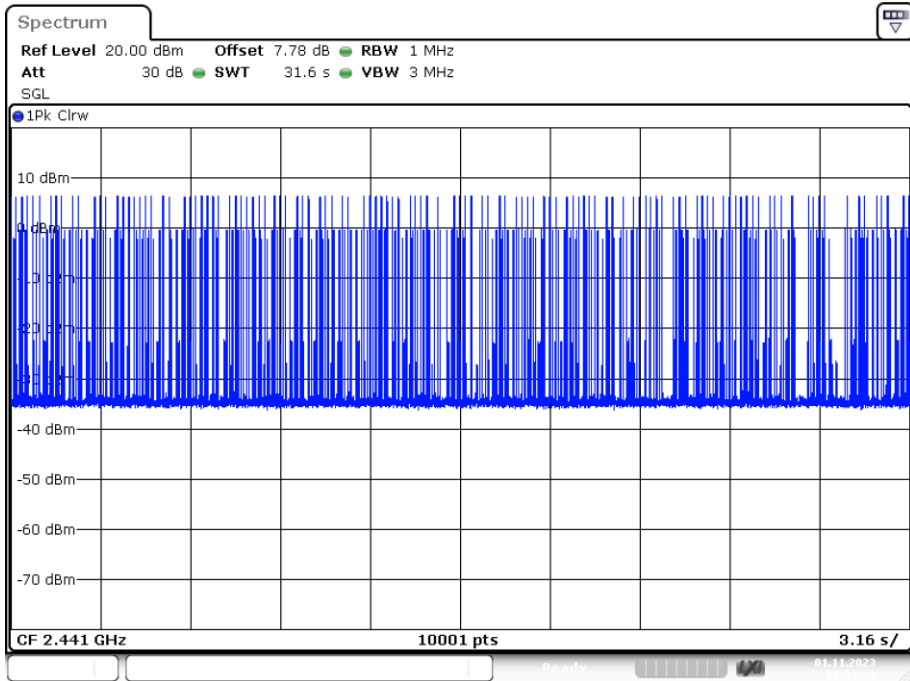

Date: 1.NOV.2023 05:31:36

Dwell NVNT 3-DH5 2441MHz Ant1 One Burst

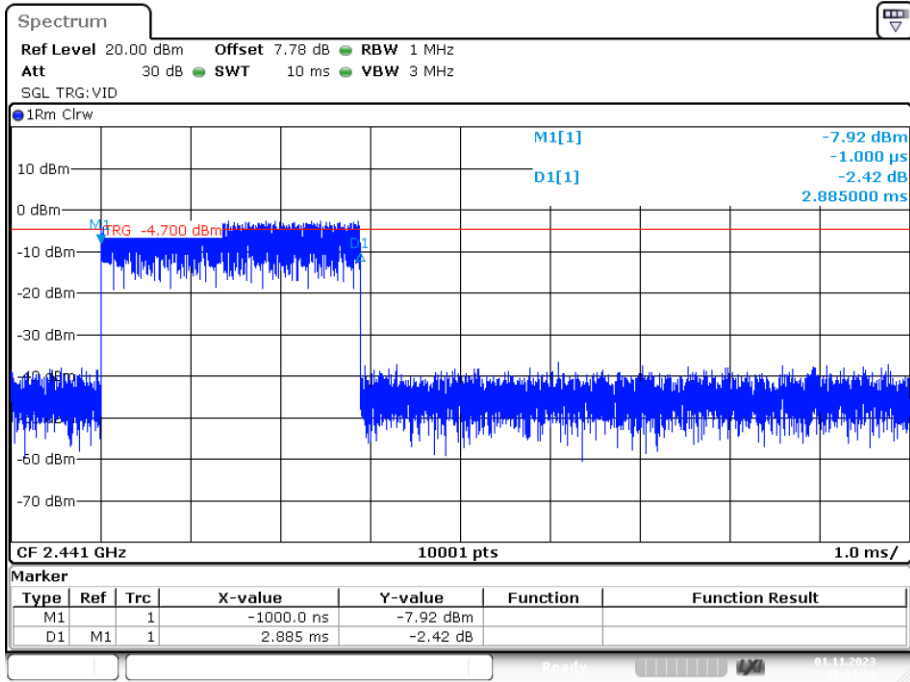

Dwell NVNT 3-DH5 2441MHz Ant1 Accumulated

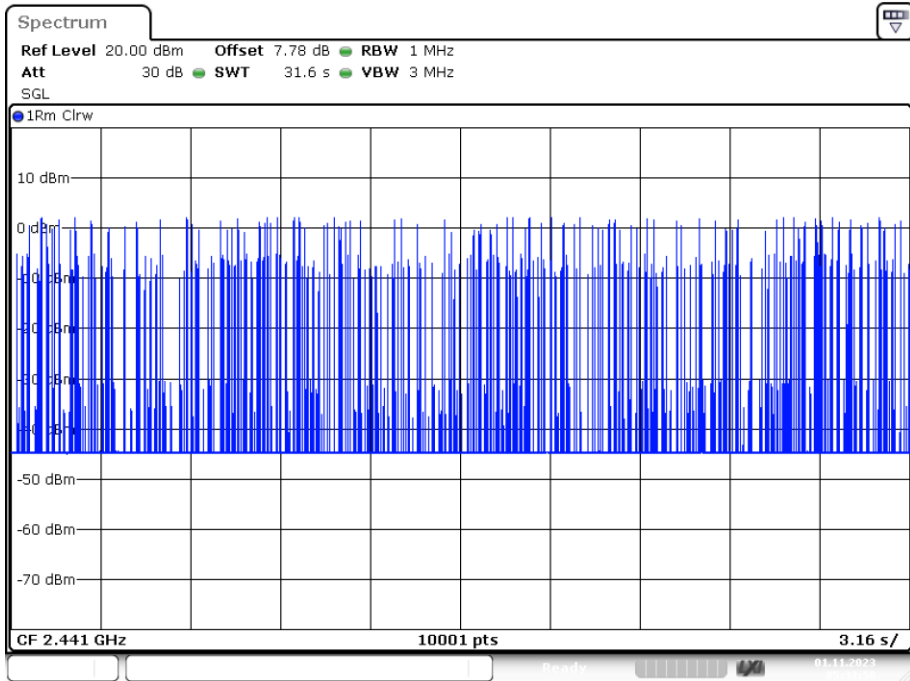

8. RADIATED EMISSIONS

8.1. Limit

All the emissions appearing within 15.205 restricted frequency bands shall not exceed the limits shown in 15.209, all the other emissions shall be at least 20dB below the fundamental emissions, or comply with 15.209 limits.

15.205 Restricted frequency band

MHz	MHz	MHz	GHz
0.090 - 0.110	16.42 - 16.423	399.9 - 410	4.5 - 5.15
¹ 0.495 - 0.505	16.69475 - 16.69525	608 - 614	5.35 - 5.46
2.1735 - 2.1905	16.80425 - 16.80475	960 - 1240	7.25 - 7.75
4.125 - 4.128	25.5 - 25.67	1300 - 1427	8.025 - 8.5
4.17725 - 4.17775	37.5 - 38.25	1435 - 1626.5	9.0 - 9.2
4.20725 - 4.20775	73 - 74.6	1645.5 - 1646.5	9.3 - 9.5
6.215 - 6.218	74.8 - 75.2	1660 - 1710	10.6 - 12.7
6.26775 - 6.26825	108 - 121.94	1718.8 - 1722.2	13.25 - 13.4
6.31175 - 6.31225	123 - 138	2200 - 2300	14.47 - 14.5
8.291 - 8.294	149.9 - 150.05	2310 - 2390	15.35 - 16.2
8.362 - 8.366	156.52475 - 156.52525	2483.5 - 2500	17.7 - 21.4
8.37625 - 8.38675	156.7 - 156.9	2690 - 2900	22.01 - 23.12
8.41425 - 8.41475	162.0125 - 167.17	3260 - 3267	23.6 - 24.0
12.29 - 12.293	167.72 - 173.2	3332 - 3339	31.2 - 31.8
12.51975 - 12.52025	240 - 285	3345.8 - 3358	36.43 - 36.5
12.57675 - 12.57725	322 - 335.4	3600 - 4400	(²)

RSS-GEN Restricted frequency band

Table 7 – Restricted frequency bands ^{Note 1}

MHz	MHz	GHz
0.090 - 0.110	149.9 - 150.05	9.0 - 9.2
0.495 - 0.505	156.52475 - 156.52525	9.3 - 9.5
2.1735 - 2.1905	156.7 - 156.9	10.6 - 12.7
3.020 - 3.026	162.0125 - 167.17	13.25 - 13.4
4.125 - 4.128	167.72 - 173.2	14.47 - 14.5
4.17725 - 4.17775	240 – 285	15.35 - 16.2
4.20725 - 4.20775	322 - 335.4	17.7 - 21.4
5.677 - 5.683	399.9 - 410	22.01 - 23.12
6.215 - 6.218	608 - 614	23.6 - 24.0

6.26775 - 6.26825	960 - 1427	31.2 - 31.8
6.31175 - 6.31225	1435 - 1626.5	36.43 - 36.5
8.291 - 8.294	1645.5 - 1646.5	Above 38.6
8.362 - 8.366	1660 - 1710	
8.37625 - 8.38675	1718.8 - 1722.2	
8.41425 - 8.41475	2200 - 2300	
12.29 - 12.293	2310 - 2390	
12.51975 - 12.52025	2483.5 - 2500	
12.57675 - 12.57725	2655 - 2900	
13.36 - 13.41	3260 – 3267	
16.42 - 16.423	3332 - 3339	
16.69475 - 16.69525	3345.8 - 3358	
16.80425 - 16.80475	3500 - 4400	
25.5 - 25.67	4500 - 5150	
37.5 - 38.25	5350 - 5460	
73 - 74.6	7250 - 7750	
74.8 - 75.2	8025 – 8500	
108 – 138		

Note 1: Certain frequency bands listed in table 7 and in bands above 38.6 GHz are designated for licence-exempt applications. These frequency bands and the requirements that apply to related devices are set out in the 200 and 300 series of RSSs.

15.209 Limit

FREQUENCY MHz	DISTANCE Meters	FIELD STRENGTHS LIMIT	
		$\mu\text{V}/\text{m}$	$\text{dB}(\mu\text{V})/\text{m}$
0.009-0.490	300	2400/F(KHz)	/
0.490-1.705	30	24000/F(KHz)	/
1.705-30	30	30	29.5
30 ~ 88	3	100	40.0
88 ~ 216	3	150	43.5
216 ~ 960	3	200	46.0
960 ~ 1000	3	500	54.0
Above 1000	3	74.0 $\text{dB}(\mu\text{V})/\text{m}$ (Peak) 54.0 $\text{dB}(\mu\text{V})/\text{m}$ (Average)	

Note: The peak limit is 20 dB higher than the average limit

Table 5 – General field strength limits at frequencies above 30 MHz

Frequency (MHz)	Field strength ($\mu\text{V}/\text{m}$ at 3 m)
30 – 88	100
88 – 216	150
216 – 960	200
Above 960	500

Table 6 – General field strength limits at frequencies below 30 MHz

Frequency	Magnetic field strength (H-Field) ($\mu\text{A}/\text{m}$)	Measurement distance (m)
9 - 490 kHz ^{Note 1}	6.37/F (F in kHz)	300
490 - 1705 kHz	63.7/F (F in kHz)	30
1.705 - 30 MHz	0.08	30

Note 1: The emission limits for the ranges 9-90 kHz and 110-490 kHz are based on measurements employing a linear average detector.

8.2. Block Diagram of Test setup

8.2.1 In 3m Anechoic Chamber Test Setup Diagram for below 30MHz

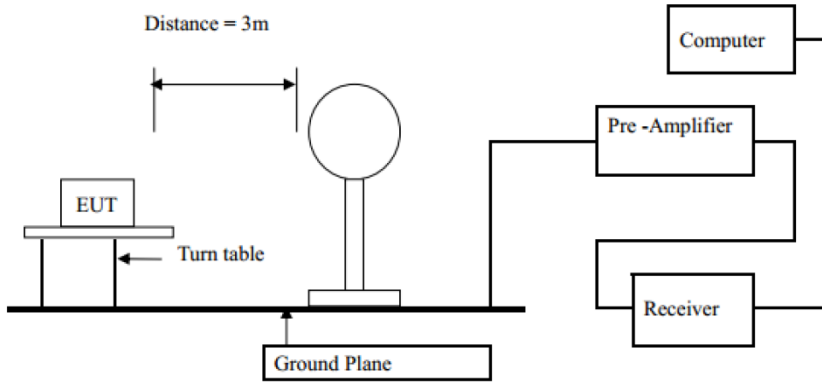

8.2.1 In 3m Anechoic Chamber Test Setup Diagram for below 1GHz

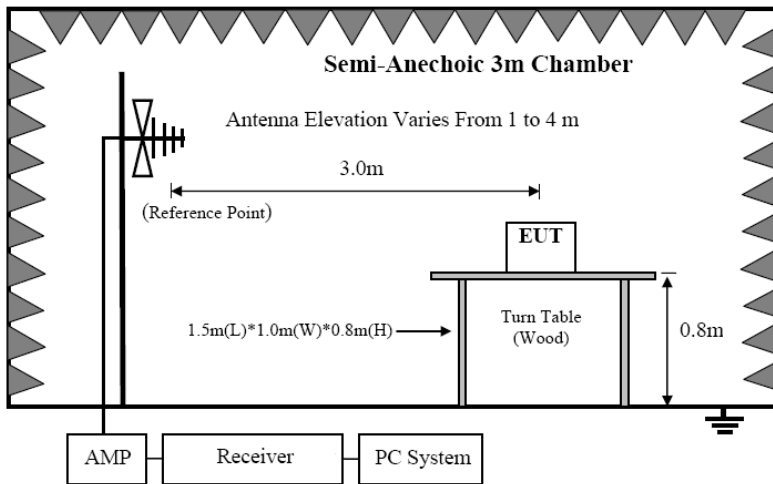

8.2.2 In 3m Anechoic Chamber Test Setup Diagram for frequency above 1GHz

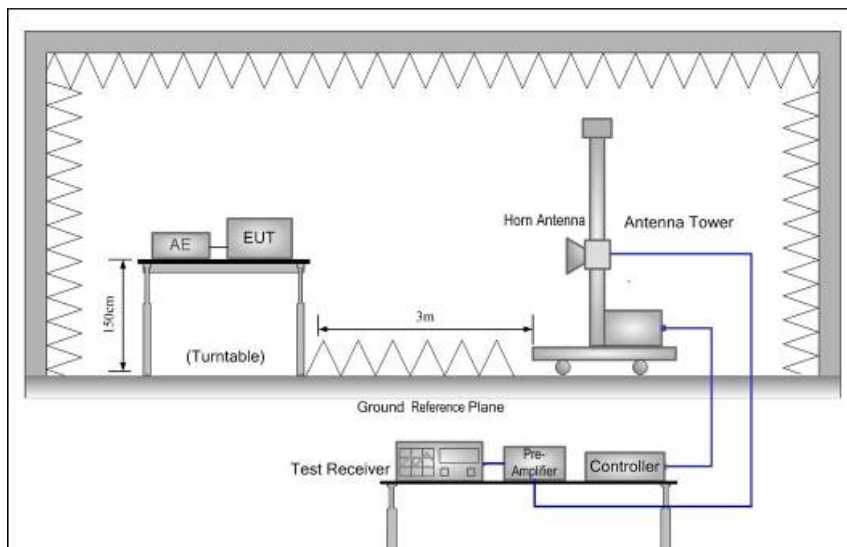

Note: For harmonic emissions test a appropriate high pass filter was inserted in the input port of AMP.

8.3. Test Procedure

- (1) EUT was placed on a non-metallic table, 80 cm above the ground plane inside a semi-anechoic chamber.
- (2) Setup EUT and simulator as shown in section 1.4 and 6.1
- (3) Test antenna was located 3m from the EUT on an adjustable mast. Below pre-scan procedure was first performed in order to find prominent radiated emissions.
 - (a) Change work frequency or channel of device if practicable.
 - (b) Change modulation type of device if practicable.
 - (c) Rotated EUT though three orthogonal axes to determine the attitude of EUT arrangement produces highest emissions
- (4) Spectrum frequency from 9KHz to 25GHz (tenth harmonic of fundamental frequency) was investigated
- (5) For final emissions measurements at each frequency of interest, the EUT were rotated and the antenna height was varied between 1m and 4m in order to maximize the emission. Measurements in both horizontal and vertical polarities were made and the data was recorded. In order to find the maximum emission, the relative positions of equipments and all of the interface cables were changed according to ANSI C63.10:2013on Radiated Emission test.
- (6) For emissions above 1GHz, both Peak and Average level were measured with Spectrum Analyzer, and the RBW is set at 1MHz, VBW is set at 3MHz for Peak measure; RBW is set at 1MHz, VBW is set at 10Hz for Average measure.

8.4. Test Result

We have scanned the 10th harmonic from 9KHz to the EUT's highest frequency.
Detailed information please see the following page.

From 9KHz to 30MHz: Conclusion: PASS

Note: The amplitude of spurious emissions which are attenuated by more than 20dB below the permissible value has no need to be reported.

From 30MHz to 1000MHz: Conclusion: PASS

Vertical:

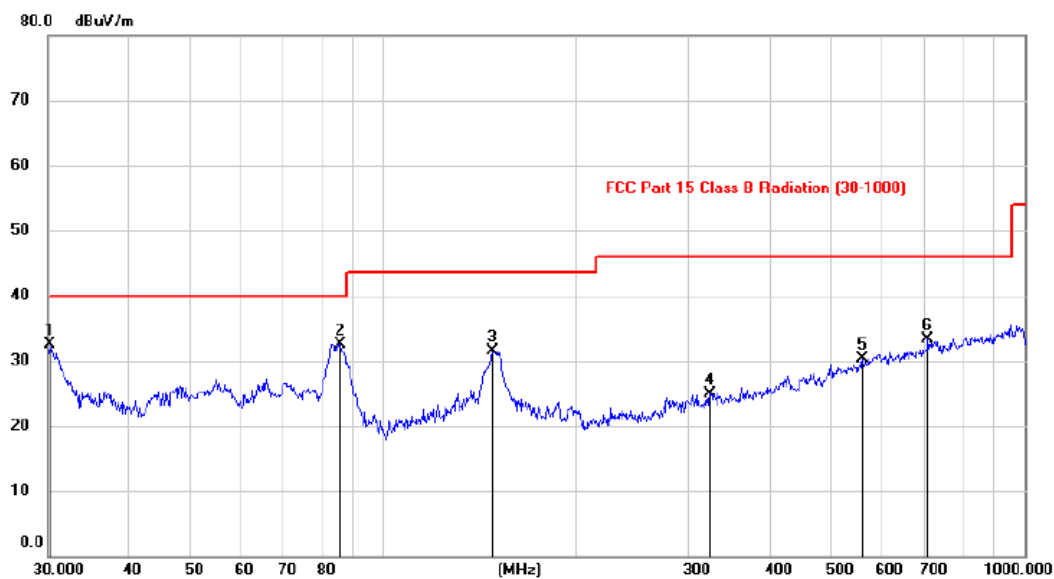

No.	Mk.	Freq.	Reading Level	Correct Factor	Measurement	Limit	Margin	Antenna Height	Table Degree
		MHz	dBuV	dB	dBuV/m	dBuV/m	dB	cm	degree
1	*	30.2783	18.98	13.54	32.52	40.00	-7.48	peak	
2		85.6776	22.49	9.98	32.47	40.00	-7.53	peak	
3		148.3889	16.50	14.94	31.44	43.50	-12.06	peak	
4		323.4714	10.15	14.70	24.85	46.00	-21.15	peak	
5		558.9913	10.94	19.35	30.29	46.00	-15.71	peak	
6		707.0303	11.41	21.83	33.24	46.00	-12.76	peak	

Note: 1. *:Maximum data; x:Over limit; !:over margin.

2.Measurement=Reading Level+Correct Factor; Correct Factor=Antenna Factor+Cable Loss.

Horizontal:

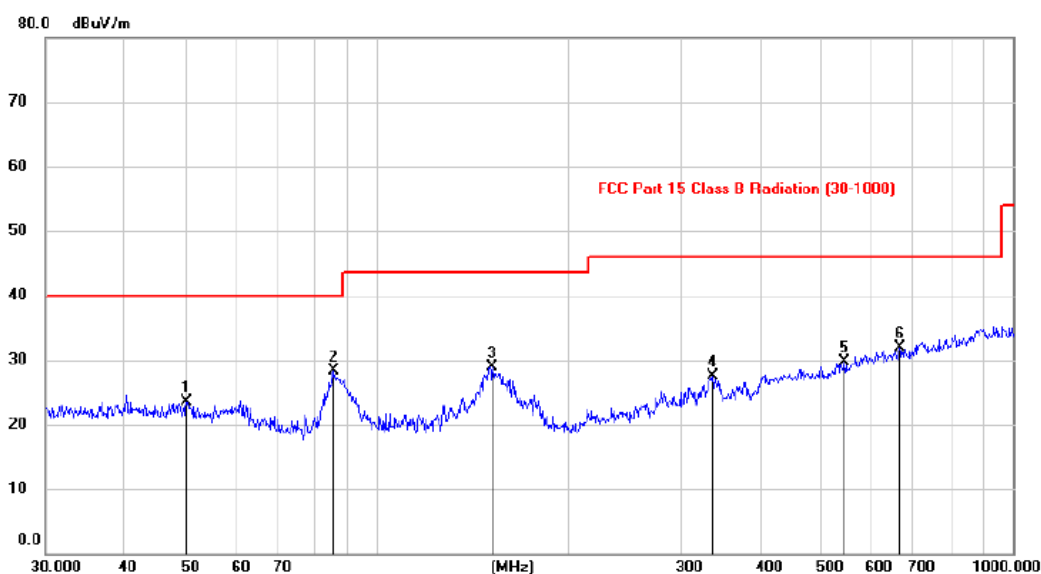

No.	Mk.	Freq.	Reading Level	Correct Factor	Measurement	Limit	Margin	Antenna Height	Table Degree	
		MHz	dBuV	dB	dBuV/m	dBuV/m	dB	cm	degree	Comment
1		50.0917	9.55	14.02	23.57	40.00	-16.43	peak		
2	*	85.4676	18.32	9.98	28.30	40.00	-11.70	peak		
3		151.7922	13.92	15.06	28.98	43.50	-14.52	peak		
4		337.2155	12.47	15.01	27.48	46.00	-18.52	peak		
5		543.9094	10.68	19.09	29.77	46.00	-16.23	peak		
6		663.6280	10.70	21.25	31.95	46.00	-14.05	peak		

Note: 1. *:Maximum data; x:Over limit; !:over margin.

2.Measurement=Reading Level+Correct Factor; Correct Factor=Antenna Factor+Cable Loss.

Remark: All modes have been tested, and only worst data of GFSK 2402MHz was listed in this report.

From 1G-25GHz

Test Mode: GFSK TX Low									
Freq (MHz)	Read Level (dBuV/m)	Polar (H/V)	Antenna Factor (dB/m)	Cable loss(dB)	Amp Factor (dB)	Result (dBuV/m)	Limit (dBuV/m)	Margin (dB)	Remark
4804	45.19	V	33.95	10.18	34.26	55.06	74	-18.94	PK
4804	36.04	V	33.95	10.18	34.26	45.91	54	-8.09	AV
7206	/	/	/	/	/	/	/	/	/
9608	/	/	/	/	/	/	/	/	/
4804	47.95	H	33.95	10.18	34.26	57.82	74	-16.18	PK
4804	37.13	H	33.95	10.18	34.26	47.00	54	-7.00	AV
7206	/	/	/	/	/	/	/	/	/
9608	/	/	/	/	/	/	/	/	/
Test Mode: GFSK TX Mid									
4882	44.16	V	33.93	10.2	34.29	54.00	74	-20.00	PK
4882	35.85	V	33.93	10.2	34.29	45.69	54	-8.31	AV
7323	/	/	/	/	/	/	/	/	/
9764	/	/	/	/	/	/	/	/	/
4882	42.70	H	33.93	10.2	34.29	52.54	74	-21.46	PK
4882	34.10	H	33.93	10.2	34.29	43.94	54	-10.06	AV
7323	/	/	/	/	/	/	/	/	/
9764	/	/	/	/	/	/	/	/	/
Test Mode: GFSK TX High									
4960	44.27	V	33.93	10.2	34.29	54.11	74	-19.89	PK
4960	36.50	V	33.93	10.2	34.29	46.34	54	-7.66	AV
7440	/	/	/	/	/	/	/	/	/
9920	/	/	/	/	/	/	/	/	/
4960	42.43	H	33.93	10.2	34.29	52.27	74	-21.73	PK
4960	32.39	H	33.93	10.2	34.29	42.23	54	-11.77	AV
7440	/	/	/	/	/	/	/	/	/
9920	/	/	/	/	/	/	/	/	/
Note:									
1, Result = Read level + Antenna factor + cable loss-Amp factor									
2, All the other emissions not reported were too low to read and deemed to comply with FCC limit.									

Test Mode: $\pi/4$ DQPSK TX Low									
Freq (MHz)	Read Level (dBuV/m)	Polar (H/V)	Antenna Factor (dB/m)	Cable loss(dB)	Amp Factor (dB)	Result (dBuV/m)	Limit (dBuV/m)	Margin (dB)	Remark
4804	47.21	V	33.95	10.18	34.26	57.08	74	-16.92	PK
4804	37.48	V	33.95	10.18	34.26	47.35	54	-6.65	AV
7206	/	/	/	/	/	/	/	/	/
9608	/	/	/	/	/	/	/	/	/
4804	44.68	H	33.95	10.18	34.26	54.55	74	-19.45	PK
4804	38.37	H	33.95	10.18	34.26	48.24	54	-5.76	AV
7206	/	/	/	/	/	/	/	/	/
9608	/	/	/	/	/	/	/	/	/
Test Mode: $\pi/4$ DQPSK TX Mid									
4882	43.47	V	33.93	10.2	34.29	53.31	74	-20.69	PK
4882	36.94	V	33.93	10.2	34.29	46.78	54	-7.22	AV
7323	/	/	/	/	/	/	/	/	/
9764	/	/	/	/	/	/	/	/	/
4882	44.81	H	33.93	10.2	34.29	54.65	74	-19.35	PK
4882	35.84	H	33.93	10.2	34.29	45.68	54	-8.32	AV
7323	/	/	/	/	/	/	/	/	/
9764	/	/	/	/	/	/	/	/	/
Test Mode: $\pi/4$ DQPSK TX High									
4960	43.30	V	33.93	10.2	34.29	53.14	74	-20.86	PK
4960	34.09	V	33.93	10.2	34.29	43.93	54	-10.07	AV
7440	/	/	/	/	/	/	/	/	/
9920	/	/	/	/	/	/	/	/	/
4960	44.98	H	33.93	10.2	34.29	54.82	74	-19.18	PK
4960	34.31	H	33.93	10.2	34.29	44.15	54	-9.85	AV
7440	/	/	/	/	/	/	/	/	/
9920	/	/	/	/	/	/	/	/	/
Note:									
1, Result = Read level + Antenna factor + cable loss-Amp factor									
2, All the other emissions not reported were too low to read and deemed to comply with FCC limit.									

Test Mode: 8DPSK TX Low									
Freq (MHz)	Read Level (dBuV/m)	Polar (H/V)	Antenna Factor (dB/m)	Cable loss(dB)	Amp Factor (dB)	Result (dBuV/m)	Limit (dBuV/m)	Margin (dB)	Remark
4804	47.78	V	33.95	10.18	34.26	57.65	74	-16.35	PK
4804	36.73	V	33.95	10.18	34.26	46.60	54	-7.40	AV
7206	/	/	/	/	/	/	/	/	/
9608	/	/	/	/	/	/	/	/	/
4804	44.28	H	33.95	10.18	34.26	54.15	74	-19.85	PK
4804	35.85	H	33.95	10.18	34.26	45.72	54	-8.28	AV
7206	/	/	/	/	/	/	/	/	/
9608	/	/	/	/	/	/	/	/	/
Test Mode: 8DPSK TX Mid									
4882	42.98	V	33.93	10.2	34.29	52.82	74	-21.18	PK
4882	33.71	V	33.93	10.2	34.29	43.55	54	-10.45	AV
7323	/	/	/	/	/	/	/	/	/
9764	/	/	/	/	/	/	/	/	/
4882	44.39	H	33.93	10.2	34.29	54.23	74	-19.77	PK
4882	34.16	H	33.93	10.2	34.29	44.00	54	-10.00	AV
7323	/	/	/	/	/	/	/	/	/
9764	/	/	/	/	/	/	/	/	/
Test Mode: 8DPSK TX High									
4960	45.15	V	33.93	10.2	34.29	54.99	74	-19.01	PK
4960	33.17	V	33.93	10.2	34.29	43.01	54	-10.99	AV
7440	/	/	/	/	/	/	/	/	/
9920	/	/	/	/	/	/	/	/	/
4960	43.74	H	33.93	10.2	34.29	53.58	74	-20.42	PK
4960	35.05	H	33.93	10.2	34.29	44.89	54	-9.11	AV
7440	/	/	/	/	/	/	/	/	/
9920	/	/	/	/	/	/	/	/	/
Note:									
1, Result = Read level + Antenna factor + cable loss-Amp factor									
2, All the other emissions not reported were too low to read and deemed to comply with FCC limit.									

Conducted RF Spurious Emission

Tx. Spurious NVNT 1-DH1 2402MHz Ant1 Emission

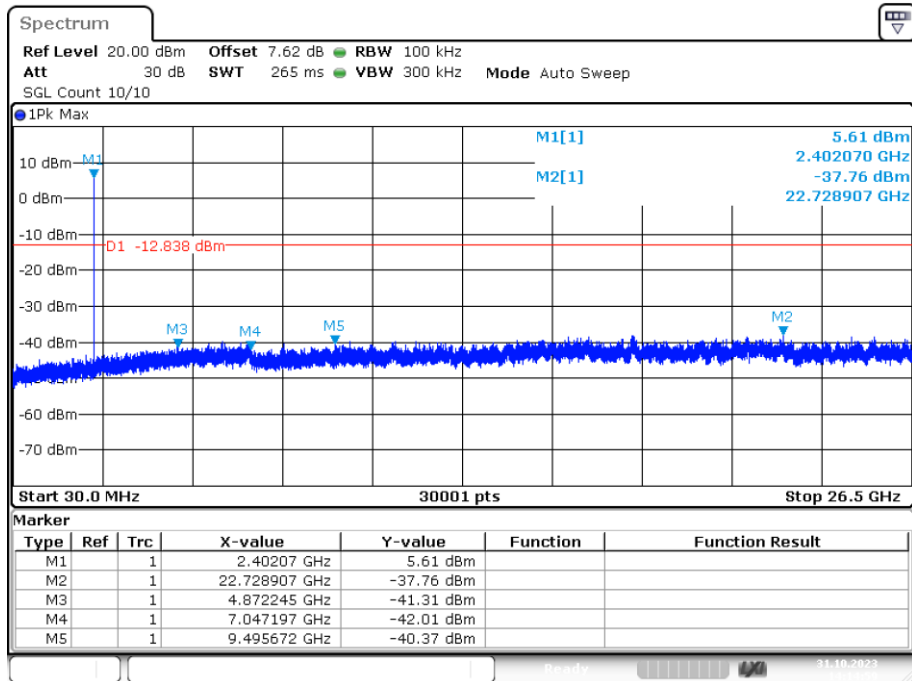

Tx. Spurious NVNT 1-DH1 2441MHz Ant1 Emission

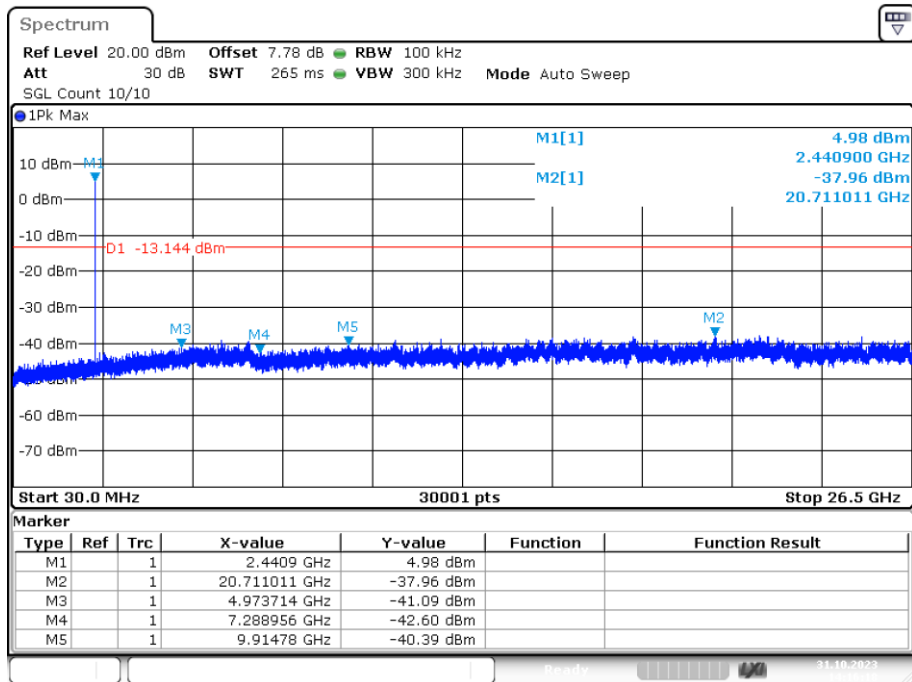

Tx. Spurious NVNT 1-DH1 2480MHz Ant1 Emission

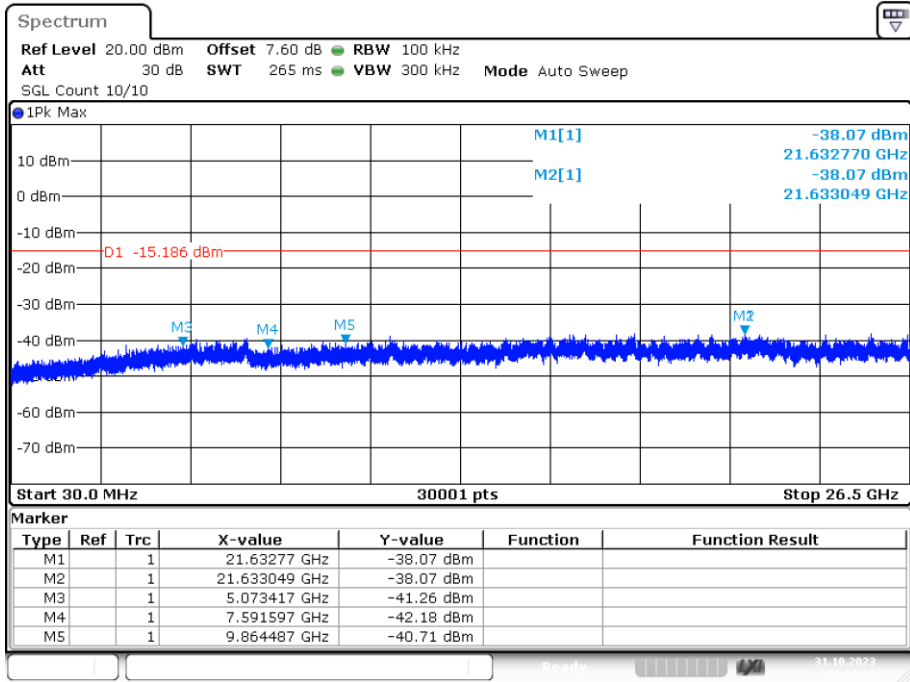

Date: 31.OCT.2023 14:18:08

Tx. Spurious NVNT 2-DH1 2402MHz Ant1 Emission

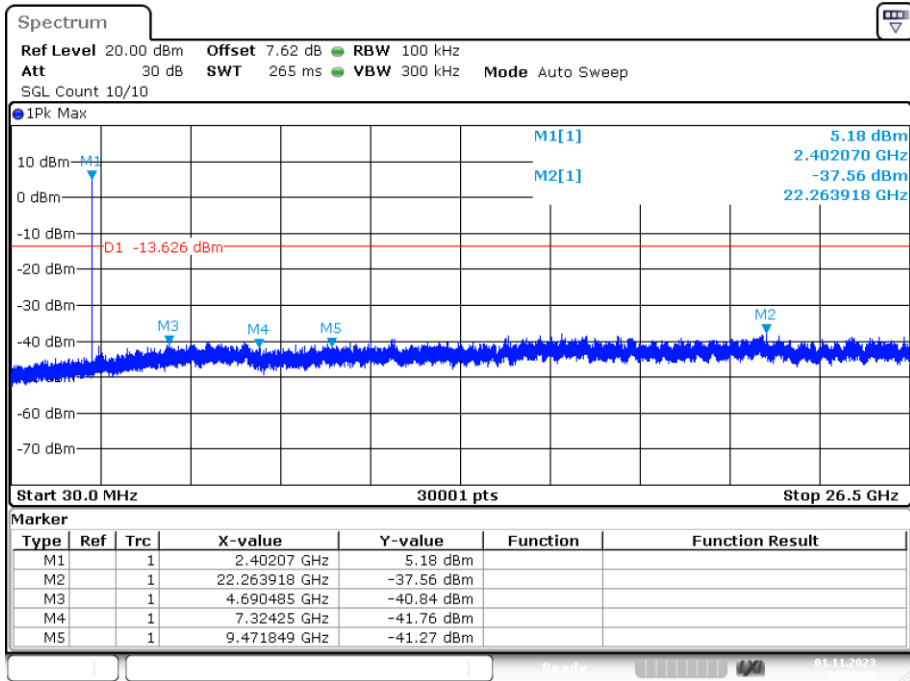

Date: 1.NOV.2023 04:30:17

Tx. Spurious NVNT 2-DH1 2441MHz Ant1 Emission

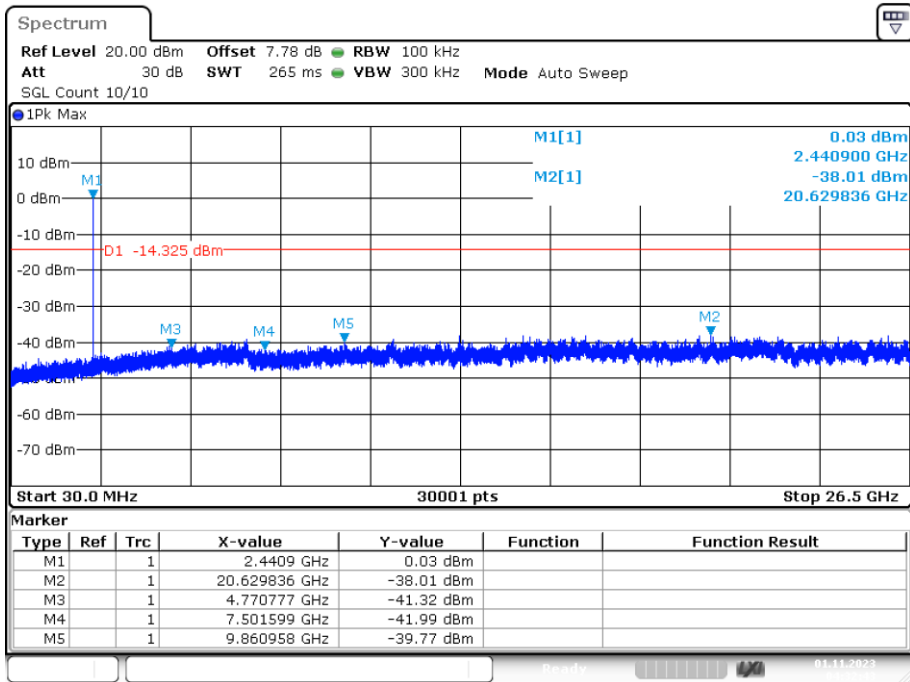

Date: 1.NOV.2023 04:32:43

Tx. Spurious NVNT 2-DH1 2480MHz Ant1 Emission

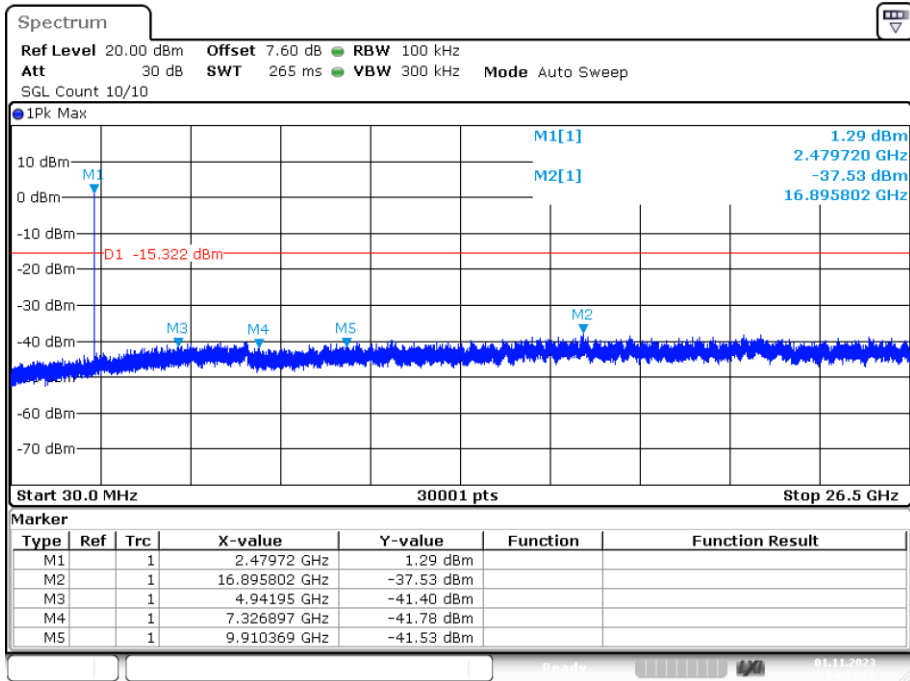

Date: 1.NOV.2023 04:34:27

Tx. Spurious NVNT 3-DH1 2402MHz Ant1 Emission

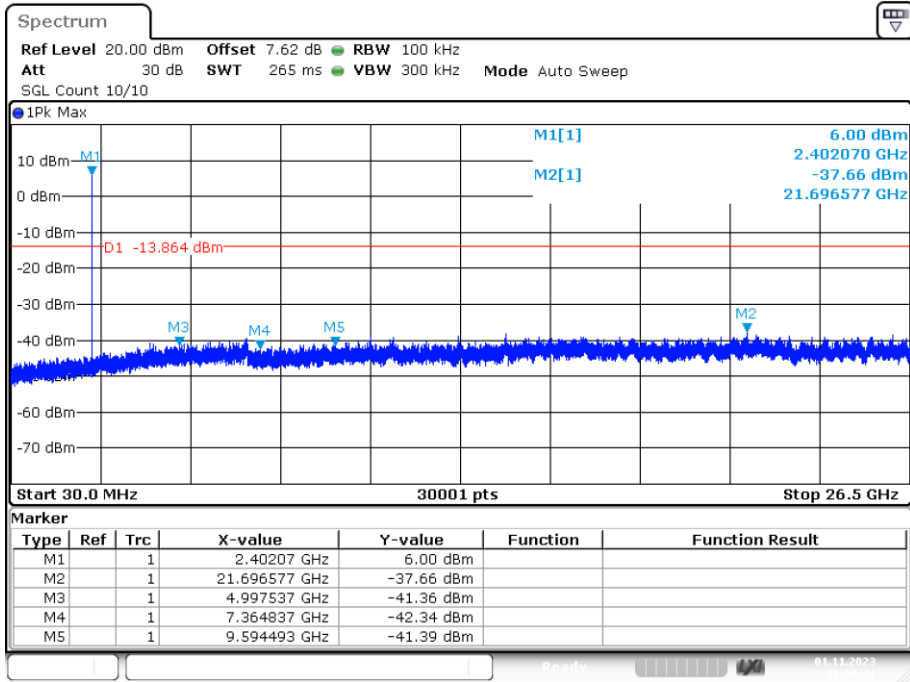

Tx. Spurious NVNT 3-DH1 2441MHz Ant1 Emission

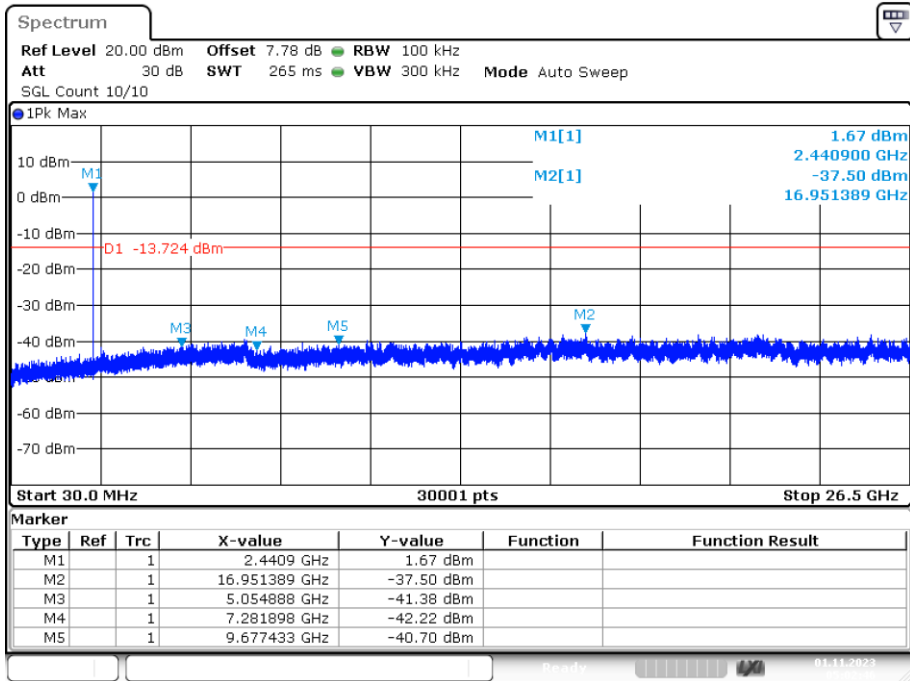

Tx. Spurious NVNT 3-DH1 2480MHz Ant1 Emission

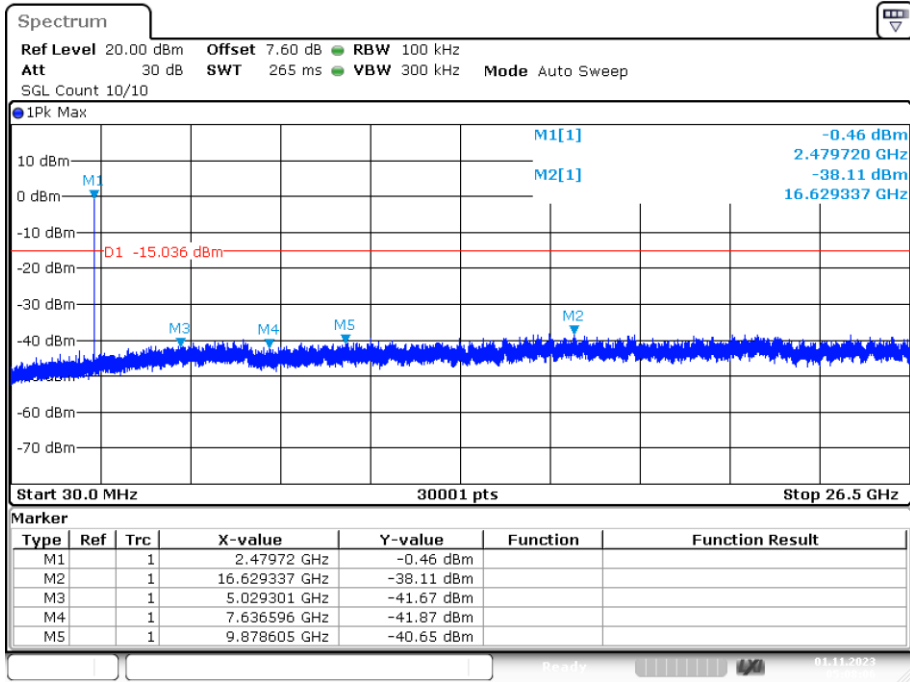

Date: 1.NOV.2023 05:08:07

9. BAND EDGE COMPLIANCE

9.1. Block Diagram of Test Setup

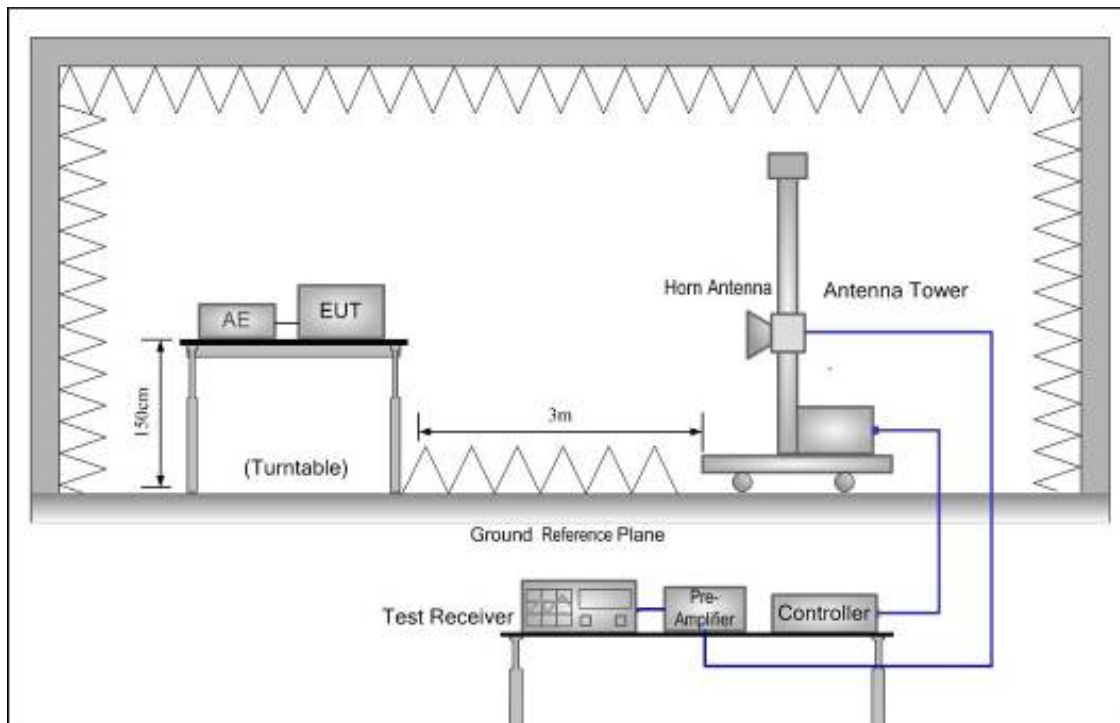

9.2. Limit

All the lower and upper band-edges emissions appearing within restricted frequency bands shall not exceed the limits shown in 15.209, all the other emissions outside operation shall be at least 20dB below the fundamental emissions, or comply with 15.209 and RSS-GEN limits.

9.3. Test Procedure

All restriction band and non- restriction band have been tested , only worse case is reported.

9.4. Test Result

PASS. (See below detailed test data)

Test Mode: GFSK-Low Hopping-off

Test Mode: GFSK-High Hopping-off

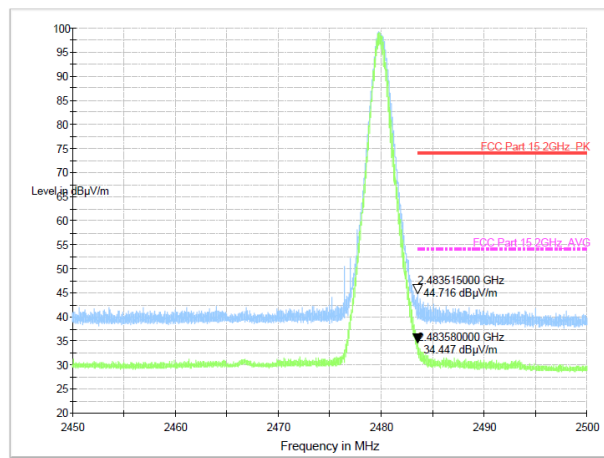
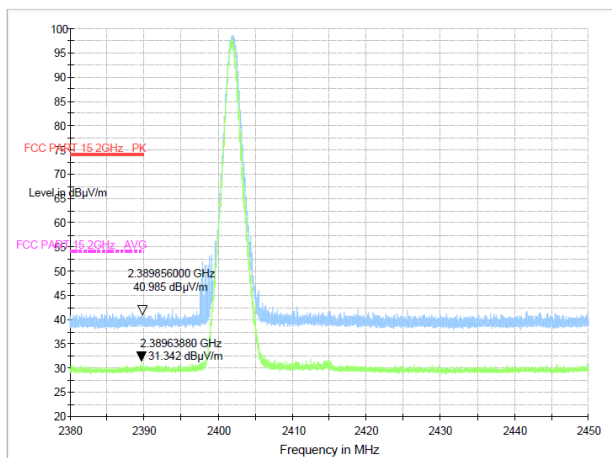

Test Mode: GFSK-Low Hopping-on

Test Mode: GFSK-High Hopping-on

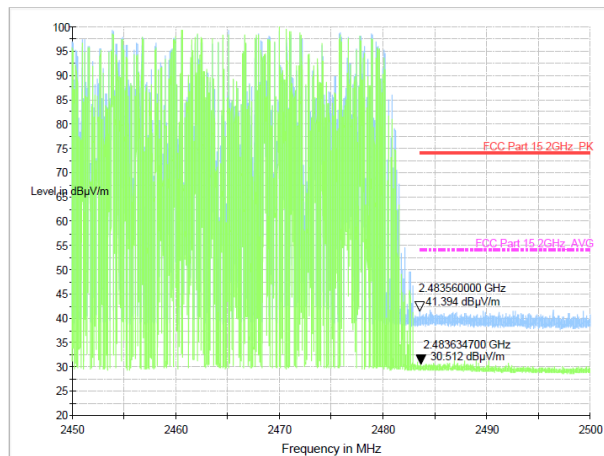
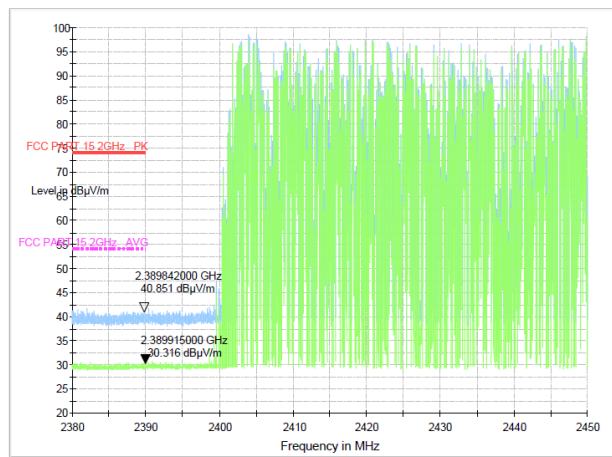

Note: 1. *:Maximum data; x:Over limit; !:over margin.

2.Measurement=Reading Level+Correct Factor; Correct Factor=Antenna Factor+Cable Loss.