

3.2 x 1.6 x 0.5 (mm) WiFi/Bluetooth Ceramic Chip Antenna (AA055U) Engineering Specification

1. Product Number

H 2 U 3 4 W I H I Z 0 7 0 0



2. Features

- *Stable and reliable in performances
- *Low profile, compact size
- *RoHS 2.0 compliance
- *SMT processes compatible

3. Applications

- *ISM 2.4 GHz applications
- *ZigBee/BLE applications
- *Bluetooth earphone systems
- *Hand-held devices when WiFi / Bluetooth functions are needed, e.g., Smart phones
- *IEEE802.11 b/g/n
- *Wireless PCMCIA cards or USB dongles

4. Description

Unictron's AA055U ceramic chip antenna is designed for ISM 2.4GHz applications, covering frequencies 2400~2500MHz. Fabricated with proprietary design and processes, AA055U shows excellent performance and is fully compatible with SMT processes which can decrease the assembly cost and improve device's quality and consistency.

深圳市组创微电子有限公司

THIS DRAWINGS AND SPECIFICATIONS ARE THE PROPERTY OF UNICTRON TECHNOLOGIES CORPORATION AND SHALL NOT BE REPRODUCED OR USED AS THE BASIS FOR THE MANUFACTURE OR SALE OF APPARATUS OR DEVICES WITHOUT PERMISSION

prepared by: 刘荣昌

designed by: 刘荣昌

Checked by: 刘正大

Approved by: 刘正大

TITLE : 3.2 x 1.6 x 0.5(mm) WiFi/Bluetooth Ceramic Chip Antenna (AA055U) Engineering Specification

DOCUMENT NO.

AA055U

REV.

C

5. Layout Guide & Electrical Specifications

5-1. Layout Guide (unit:mm)

Solder Land Pattern:

The solder land pattern (gold marking areas) is shown below. Recommendation on matching circuit will be provided according to customer's installation conditions.

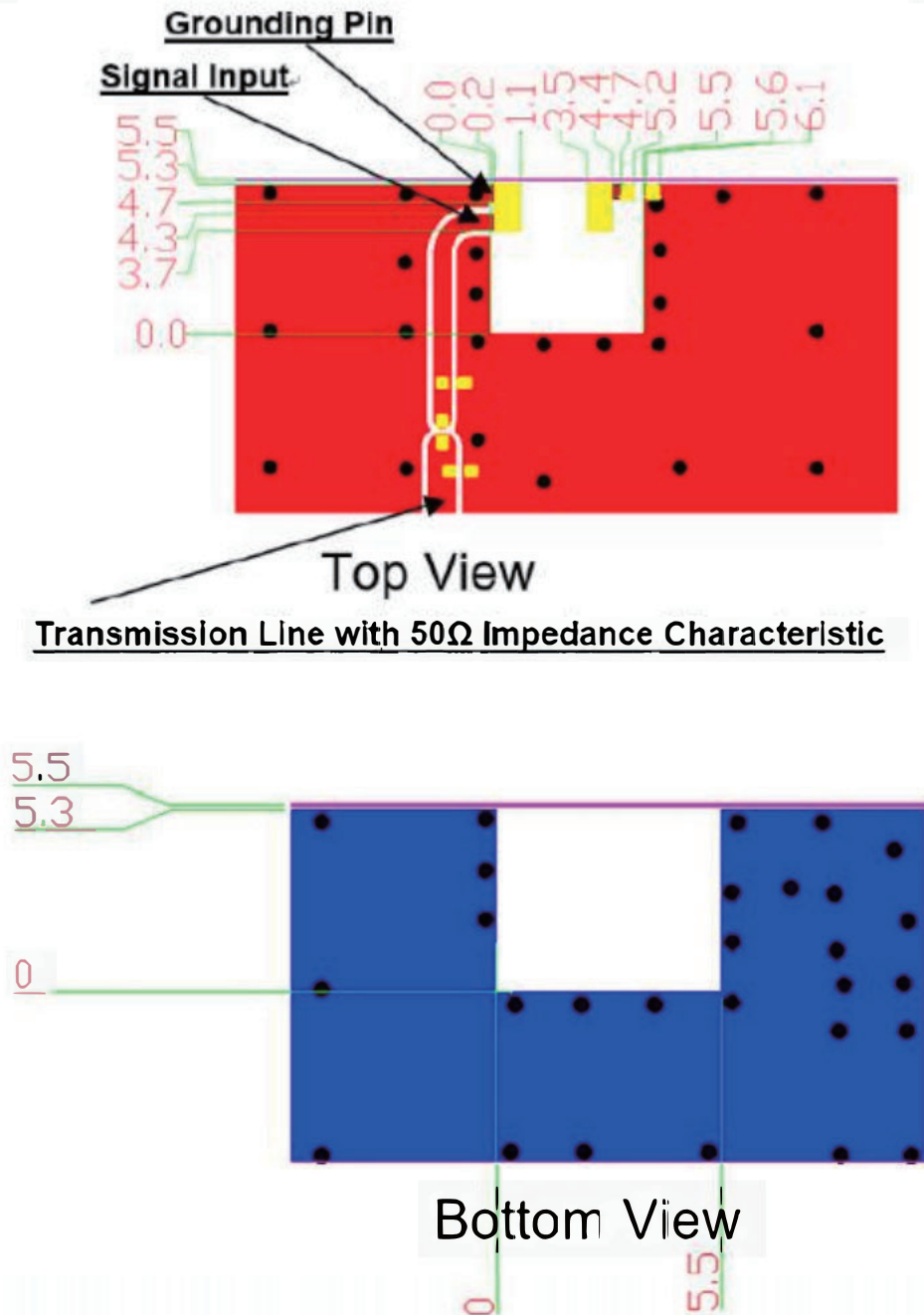

深圳市组创微电子有限公司

THIS DRAWINGS AND SPECIFICATIONS ARE THE PROPERTY OF UNICTRON TECHNOLOGIES CORPORATION AND SHALL NOT BE REPRODUCED OR USED AS THE BASIS FOR THE MANUFACTURE OR SALE OF APPARATUS OR DEVICES WITHOUT PERMISSION

prepared by: 刘荣昌

designed by: 刘荣昌

Checked by: 刘正大

Approved by: 刘正大

TITLE : 3.2 x 1.6 x 0.5(mm) WiFi/Bluetooth Ceramic Chip Antenna (AA055U) Engineering Specification

DOCUMENT NO.

AA055U

REV.

C

5-2. Electrical Specifications (Evaluation Board Dimensions: 80 x 40 mm²)

5-2-1. Electrical Table

Characteristics		Specifications	Unit
Outline Dimensions		3.2 x 1.6 x 0.5	mm
Ground Plane Dimensions		80 x 40	mm
Working Frequency		2400~2500	MHz
VSWR (@ center frequency)*		2 Max.	
Characteristic Impedance		50	Ω
Polarization		Linear Polarization	
Peak Gain	(@2442 MHz)	1.8 (typical**)	dBi
Efficiency		76.3 (typical**)	%

*Center frequency means the frequency with the lowest value in return loss of the chip antenna on the evaluation board.

**A typical value is for reference only, not guaranteed.

5-2-2. Frequency vs. V.S.W.R. and Total Radiation Gain

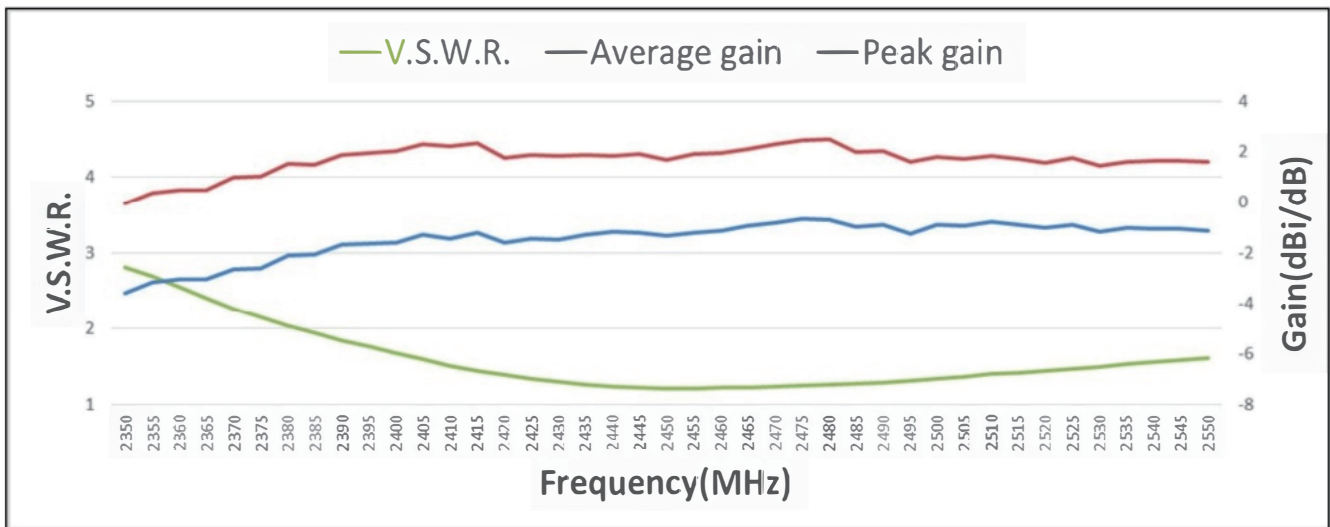

THIS DRAWINGS AND SPECIFICATIONS ARE THE PROPERTY OF UNICTRON TECHNOLOGIES CORPORATION AND SHALL NOT BE REPRODUCED OR USED AS THE BASIS FOR THE MANUFACTURE OR SALE OF APPARATUS OR DEVICES WITHOUT PERMISSION

prepared by: 刘荣昌

designed by: 刘荣昌

Checked by: 刘正大

Approved by: 刘正大

TITLE : 3.2 x 1.6 x 0.5(mm) WiFi/Bluetooth Ceramic Chip Antenna (AA055U) Engineering Specification

DOCUMENT NO.

REV. C

6. Outline Dimensions of Antenna & Evaluation Board (unit: mm)

6-1. Antenna Dimensions

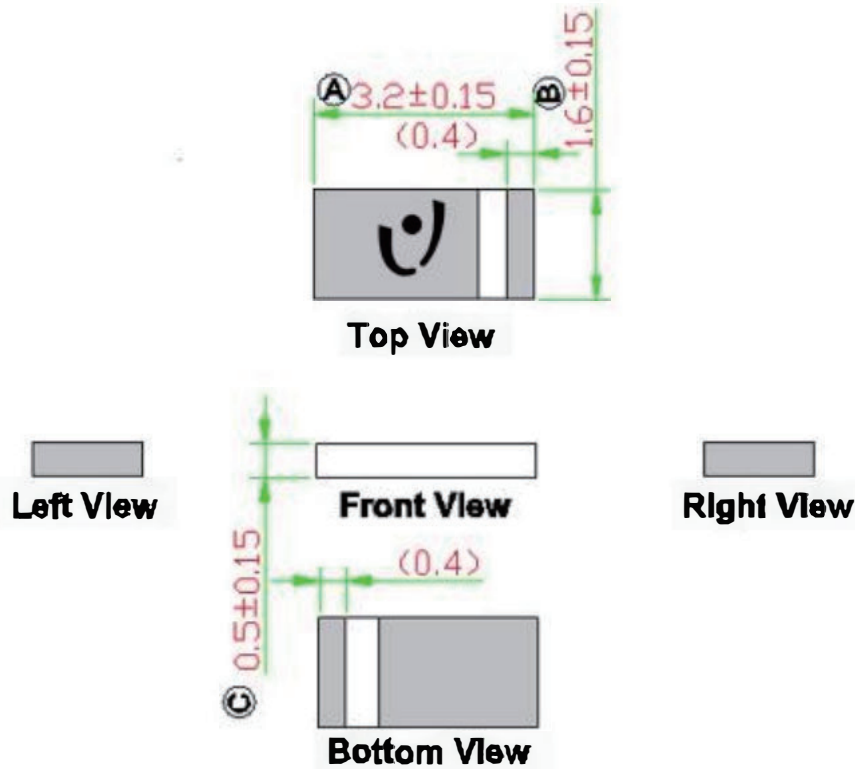

NOTE:

1. All materials are RoHS 2.0 compliant.
2. "A~C" Critical Dimensions.
3. "()" Reference Dimensions.

PIN Definition

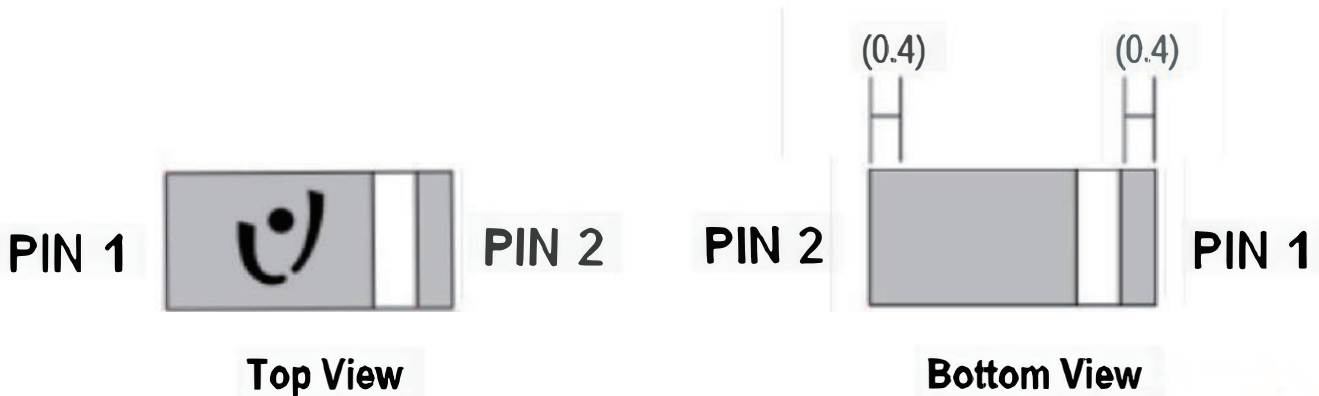

PIN	1	2
Soldering PAD	Signal	Tuning / Ground

深圳市组创微电子有限公司

THIS DRAWINGS AND SPECIFICATIONS ARE THE PROPERTY OF UNICTRON TECHNOLOGIES CORPORATION AND SHALL NOT BE REPRODUCED OR USED AS THE BASIS FOR THE MANUFACTURE OR SALE OF APPARATUS OR DEVICES WITHOUT PERMISSION

prepared by: 刘荣昌

designed by: 刘荣昌

Checked by: 刘正大

Approved by: 刘正大

TITLE : 3.2 x 1.6 x 0.5(mm) WiFi/Bluetooth Ceramic Chip
Antenna (AA055U) Engineering Specification

DOCUMENT
NO.

AA055U

REV.

C

6-2. Evaluation Board with Antenna

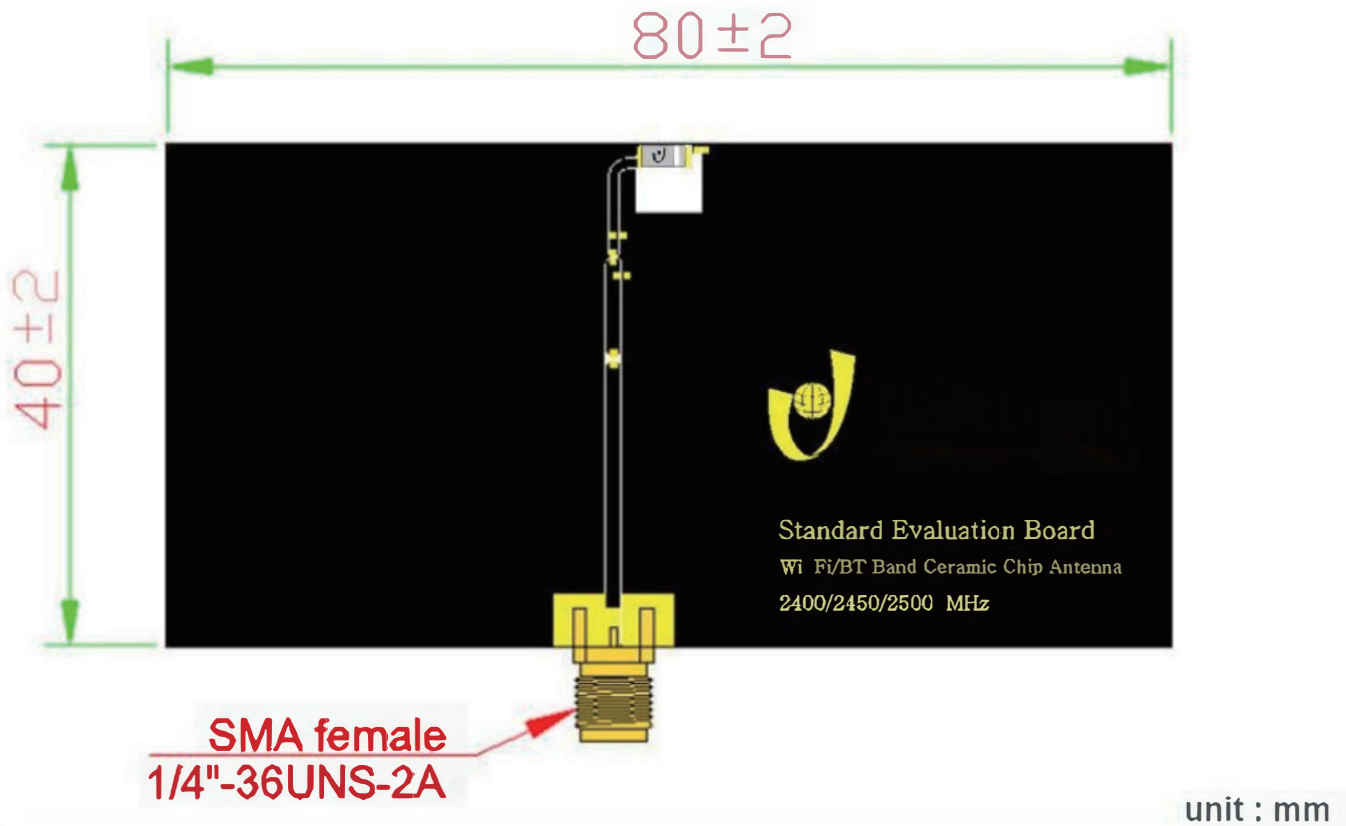

深圳市组创微电子有限公司

THIS DRAWINGS AND SPECIFICATIONS ARE THE PROPERTY OF UNICTRON TECHNOLOGIES CORPORATION AND SHALL NOT BE REPRODUCED OR USED AS THE BASIS FOR THE MANUFACTURE OR SALE OF APPARATUS OR DEVICES WITHOUT PERMISSION

prepared by: 刘荣昌

designed by: 刘荣昌

Checked by: 刘正大

Approved by: 刘正大

TITLE : 3.2 x 1.6 x 0.5(mm) WiFi/Bluetooth Ceramic Chip Antenna (AA055U) Engineering Specification

DOCUMENT NO.

AA055U

REV.

C

7. 3D Radiation Gain Pattern (with 80 x 40 mm² Evaluation Board)

3D Radiation Gain Pattern @ 2442 MHz (unit: dBi)

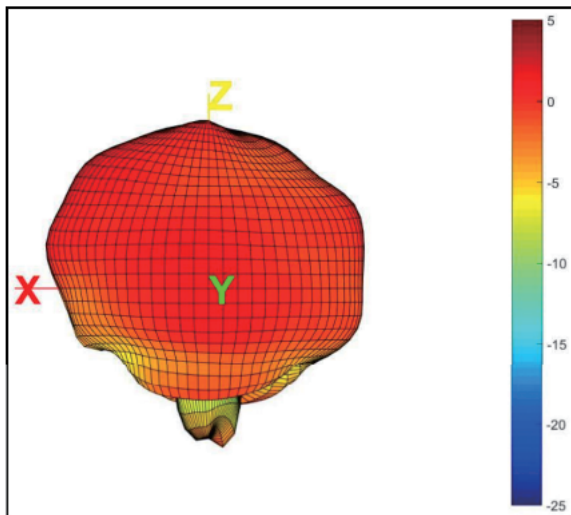
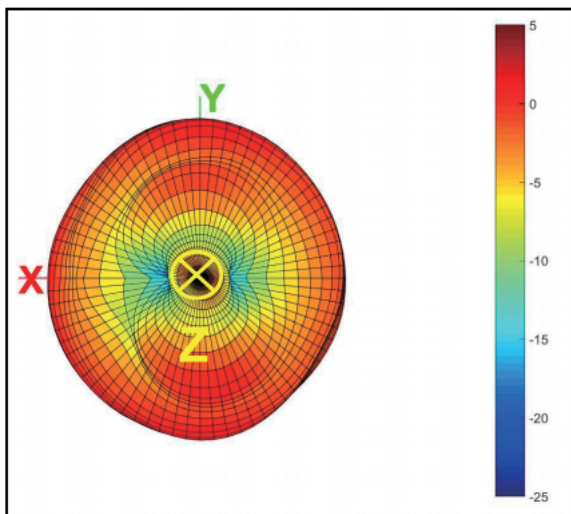
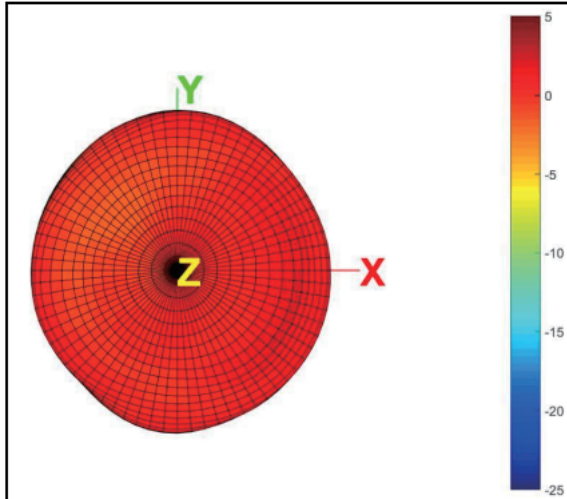

深圳市组创微电子有限公司

THIS DRAWINGS AND SPECIFICATIONS ARE THE PROPERTY OF UNICTRON TECHNOLOGIES CORPORATION AND SHALL NOT BE REPRODUCED OR USED AS THE BASIS FOR THE MANUFACTURE OR SALE OF APPARATUS OR DEVICES WITHOUT PERMISSION

prepared by: 刘荣昌

designed by: 刘荣昌

Checked by: 刘正大

Approved by: 刘正大

TITLE : 3.2 x 1.6 x 0.5(mm) WiFi/Bluetooth Ceramic Chip Antenna (AA055U) Engineering Specification

DOCUMENT NO.

AA055U

REV.

C

8. Frequency tuning and Matching circuit

8-1. Chip antenna tuning scenario :

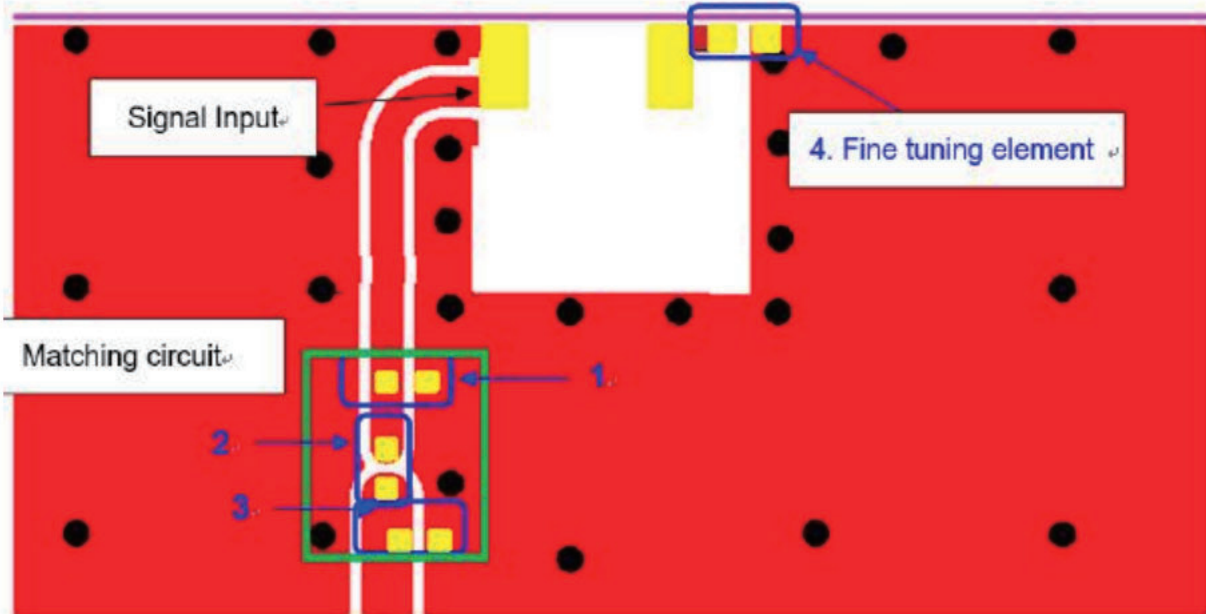

8-2. Matching circuit :

With the following recommended values of matching and tuning components the center frequencies will be about 2442 MHz at our standard 80x40 mm² evaluation board. However, these are typical reference values which may need to be changed when circuit boards or part vendors are different.

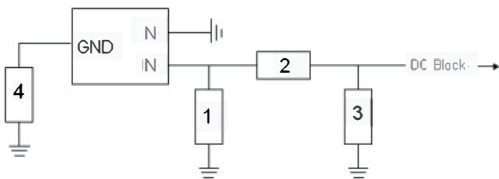

System Matching Circuit Component			
Location	Description	Vendor	Tolerance
1	1.2pF, (0402)	MURATA	±0.05 pF
2	3.3nH, (0402)	MURATA	±0.1 nH
3	NA		
Fine tuning element 4	1.2pF, (0402)	MURATA	±0.05 pF

*Typical reference values which may need to be changed when circuit boards or part vendors are different.

深圳市组创微电子有限公司

THIS DRAWINGS AND SPECIFICATIONS ARE THE PROPERTY OF UNICTRON TECHNOLOGIES CORPORATION AND SHALL NOT BE REPRODUCED OR USED AS THE BASIS FOR THE MANUFACTURE OR SALE OF APPARATUS OR DEVICES WITHOUT PERMISSION

prepared by: 刘荣昌

designed by: 刘荣昌

Checked by: 刘正大

Approved by: 刘正大

TITLE : 3.2 x 1.6 x 0.5(mm) WiFi/Bluetooth Ceramic Chip Antenna (AA055U) Engineering Specification

DOCUMENT NO.

AA055U

REV.

C

8-3.Reference for the frequency tuning element

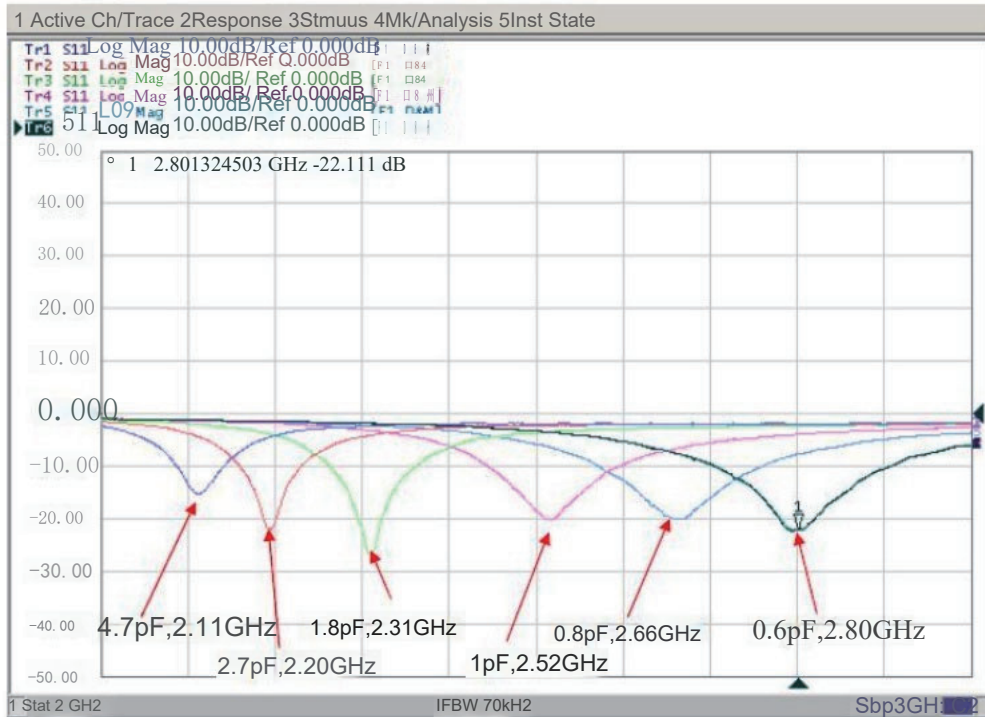
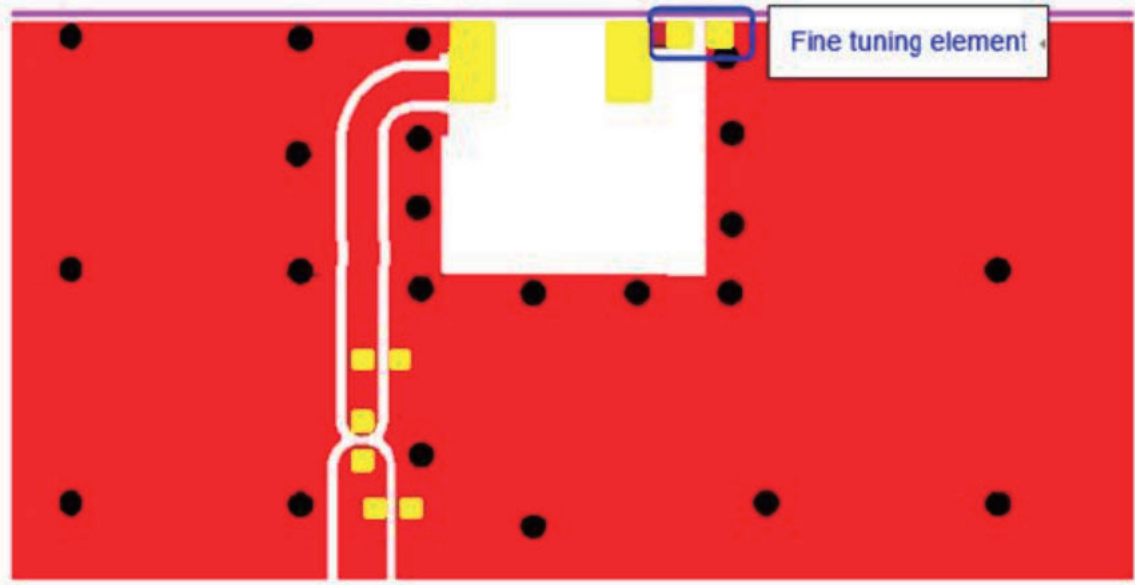

深圳市组创微电子有限公司

THIS DRAWINGS AND SPECIFICATIONS ARE THE PROPERTY OF UNICTRON TECHNOLOGIES CORPORATION AND SHALL NOT BE REPRODUCED OR USED AS THE BASIS FOR THE MANUFACTURE OR SALE OF APPARATUS OR DEVICES WITHOUT PERMISSION

prepared by :刘荣昌

designed by:刘荣昌

Checked by:刘正大

Approved by:刘正大

TITLE:3.2×1.6×0.5(mm) WiFi/Bluetooth Ceramic Chip Antenna(AA055U) Engineering Specification

DOCUMENT NO.

AA055U

REV.

C

9. Soldering Condition

Solder paste alloy: SAC305 (Sn96.5/Ag3/Cu0.5) Lead Free solder paste

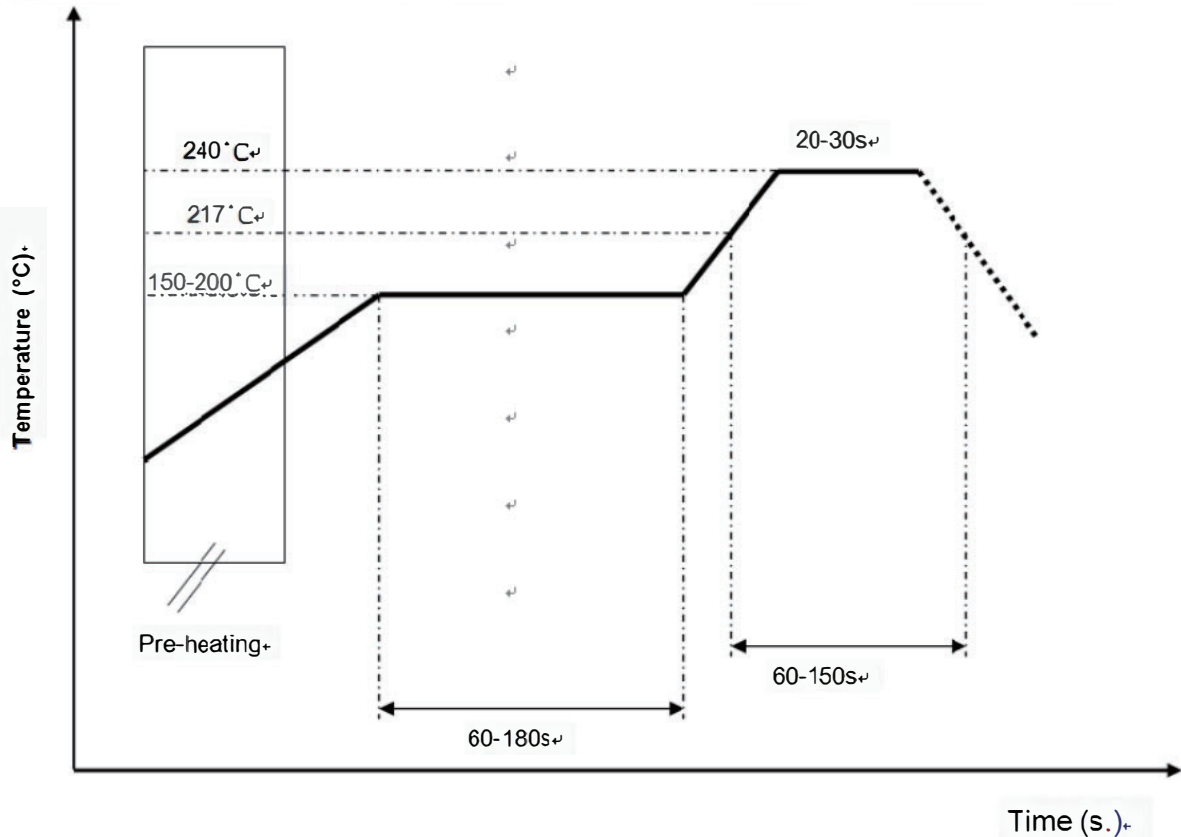

*Recommended solder paste alloy: SAC305 (Sn96.5 /Ag3 /Cu0.5) Lead Free solder paste.

10. Reminders for users of Unictron's AA055U ceramic chip antennas

- 10-1. This chip antenna is made of ceramic materials which are relatively more rigid and brittle compared to printed circuit board materials. Bending of circuit board at the locations where chip antenna is mounted may cause the cracking of solder joints or antenna itself.
- 10-2. Punching/cutting of the break-off tab of PCB panel may cause severe bending of the circuit board which may result in cracking of solder joints or chip antenna itself. Therefore break-off tab shall be located away from the installation site of chip antenna.
- 10-3. Be cautious when ultrasonic welding process needs to be used near the locations where chip antennas are installed. Strong ultrasonic vibration may cause the cracking of chip antenna solder joints.

深圳市组创微电子有限公司

THIS DRAWINGS AND SPECIFICATIONS ARE THE PROPERTY OF UNICTRON TECHNOLOGIES CORPORATION AND SHALL NOT BE REPRODUCED OR USED AS THE BASIS FOR THE MANUFACTURE OR SALE OF APPARATUS OR DEVICES WITHOUT PERMISSION

prepared by : 刘荣昌

designed by: 刘荣昌

Checked by: 刘正大

Approved by: 刘正大

TITLE : 3.2 x 1.6 x 0.5(mm) WiFi/Bluetooth Ceramic Chip Antenna (AA055U) Engineering Specification

DOCUMENT NO.

1

REV.

C

11. Packing

- (1) Packaging method is implemented according to "MSL 2a 包装作业指导书"
- (2) Quantity/Reel: 5000 pcs/Reel
- (3) Plastic tape: Black conductive polystyrene.

a. Tape Drawing

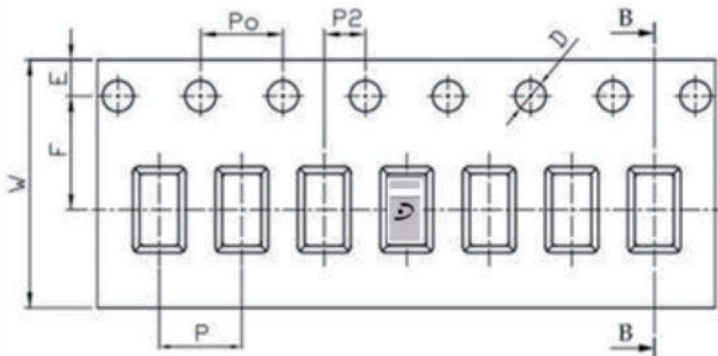

b. Tape Dimensions (unit: mm)

Feature	Specifications	Tolerances
W	12.00	±0.30
P	4.00	±0.10
E	1.75	±0.10
F	5.50	±0.10
P2	2.00	±0.10
D	1.50	+0.10 -0.00
Po	4.00	±0.10
10Po	40.00	±0.20

c. Reel Drawing

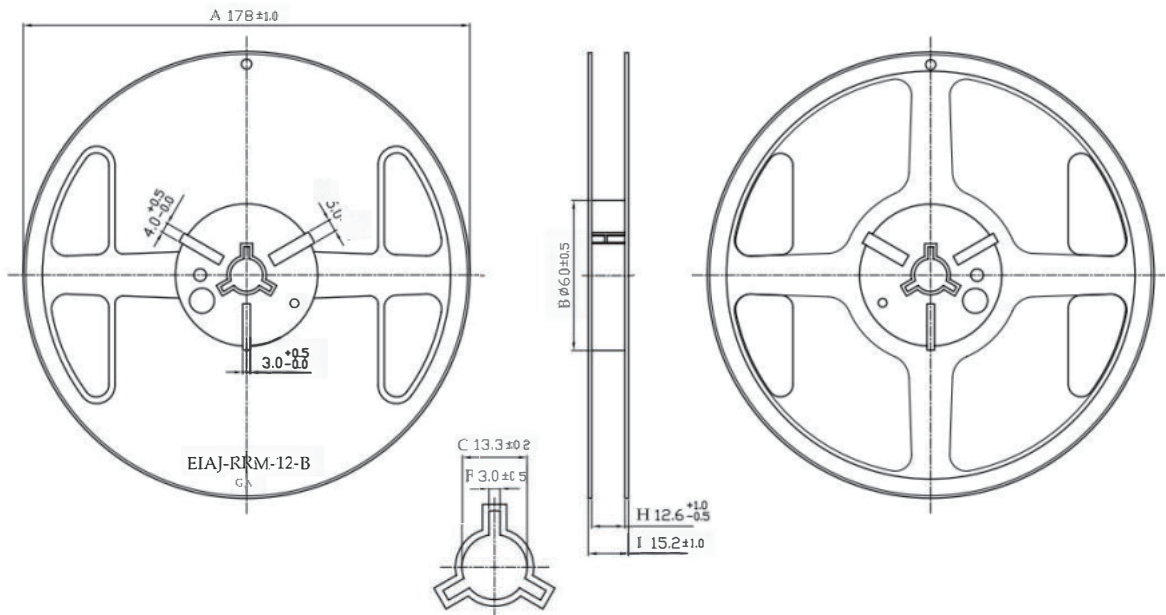

深圳市组创微电子有限公司

THIS DRAWINGS AND SPECIFICATIONS ARE THE PROPERTY OF UNICTRON TECHNOLOGIES CORPORATION AND SHALL NOT BE REPRODUCED OR USED AS THE BASIS FOR THE MANUFACTURE OR SALE OF APPARATUS OR DEVICES WITHOUT PERMISSION

prepared by: 刘荣昌

designed by: 刘荣昌

Checked by: 刘正大

Approved by: 刘正大

TITLE : 3.2 x 1.6 x 0.5(mm) WiFi/Bluetooth Ceramic Chip Antenna (AA055U) Engineering Specification

DOCUMENT NO.

AA055U

REV.

C

12. Operating & Storage Conditions

12-1. Operating

- (1) Maximum Input Power: 2 W
- (2) Operating Temperature: -40°C to 85°C
- (3) Relative Humidity: 10% to 70%

12-2. Storage (sealed)

- (1) Storage Temperature: -5°C to 40°C
- (2) Relative Humidity: 20% to 70%
- (3) Shelf Life: 1 year

12-3. Storage (unsealed)

Meet the criteria of J-STD-033 MSL2a

12-4. Storage (After mounted on customer's PCB with SMT process)

- (1) Storage Temperature: -40°C to 85°C
- (2) Relative Humidity: 10% to 70%

13. Notice

(1) Installation Guide:

Please refer to Unictron's application note "General guidelines for the installation of Unictron's chip antennas" for further information.

(2) All specifications are subject to change without notice.

深圳市组创微电子有限公司

THIS DRAWINGS AND SPECIFICATIONS ARE THE PROPERTY OF UNICTRON TECHNOLOGIES CORPORATION AND SHALL NOT BE REPRODUCED OR USED AS THE BASIS FOR THE MANUFACTURE OR SALE OF APPARATUS OR DEVICES WITHOUT PERMISSION

prepared by: 刘荣昌

designed by: 刘荣昌

Checked by: 刘正大

Approved by: 刘正大

TITLE : 3.2 x 1.6 x 0.5(mm) WiFi/Bluetooth Ceramic Chip Antenna (AA055U) Engineering Specification

DOCUMENT NO.

AA055U

REV.

C