



TEST REPORT

For WiFi-5GHz Band

Report No. : **CHTEW2306002101** Report Verification: 

Project No...... : **SHT2303063702EW**

FCC ID..... : **2BA2M-ICB-808**

Applicant's name..... : **Guangzhou CHUANG ZAO MEI Technology Co.,Ltd.**

Address..... : Dehe international A505,No.2,Qixinggang Industrial Road,
JUNHE street,Baiyun District,Guangzhou

Product Name : **Diode Laser Hair Removal Device**

Trade Mark : -

Model No. : EVOLUTION MEDICAL

Listed Model(s) : M-I-X MEDICAL

Standard : **FCC CFR Title 47 Part 15 Subpart E § 15.407**

Date of receipt of test sample..... : Apr.26, 2023

Date of testing..... : Apr.26, 2023-Jun.12, 2023

Date of issue..... : Jun.13, 2023

Result..... : **PASS**

Compiled by
 (Position+Printed name+Signature): File administrator Fanghui Zhu

Fanghui Zhu

Supervised by
 (Position+Printed name+Signature): Project Engineer Caspar Chen

Caspar Chen

Approved by
 (Position+Printed name+Signature): RF Manager Hans Hu

Hans Hu

Testing Laboratory Name : **Shenzhen Huatongwei International Inspection Co., Ltd.**

Address..... : 1/F, Bldg 3, Hongfa Hi-tech Industrial Park, Genyu Road,
Tianliao, Gongming, Shenzhen, China

Shenzhen Huatongwei International Inspection Co., Ltd. All rights reserved.

This publication may be reproduced in whole or in part for non-commercial purposes as long as the Shenzhen Huatongwei International Inspection Co., Ltd. is acknowledged as copyright owner and source of the material. Shenzhen Huatongwei International Inspection Co., Ltd. takes no responsibility for and will not assume liability for damages resulting from the reader's interpretation of the reproduced material due to its placement and context.

The test report merely correspond to the test sample.

Contents

1.	<u>TEST STANDARDS AND REPORT VERSION</u>	<u>3</u>
1.1.	Test Standards	3
1.2.	Report version	3
2.	<u>TEST DESCRIPTION</u>	<u>4</u>
3.	<u>SUMMARY</u>	<u>5</u>
3.1.	Client Information	5
3.2.	Product Description	5
3.3.	Radio Specification Description	5
3.4.	Testing Laboratory Information	6
4.	<u>TEST CONFIGURATION</u>	<u>7</u>
4.1.	Test frequency list	7
4.2.	Descriptions of Test mode	7
4.3.	Test mode	7
4.4.	Test sample information	8
4.5.	Support unit used in test configuration and system	8
4.6.	Testing environmental condition	8
4.7.	Statement of the measurement uncertainty	9
4.8.	Equipment Used during the Test	10
5.	<u>TEST CONDITIONS AND RESULTS</u>	<u>11</u>
5.1.	Antenna Requirement	11
5.2.	AC Conducted Emission	12
5.3.	Maximum Conducted Output Power	14
5.4.	Power Spectral Density	16
5.5.	26dB bandwidth and 99% Occupy bandwidth	18
5.6.	6dB Bandwidth	19
5.7.	Band edge	20
5.8.	Radiated Spurious Emissions	30
5.9.	Frequency stability	44
6.	<u>TEST SETUP PHOTOS.....</u>	<u>45</u>
7.	<u>EXTERNAL AND INTERNAL PHOTOS.....</u>	<u>47</u>
8.	<u>APPENDIX REPORT</u>	<u>47</u>

1. TEST STANDARDS AND REPORT VERSION

1.1. Test Standards

The tests were performed according to following standards:

- [FCC CFR Title 47 Part 15 Subpart E § 15.407](#): General technical requirements
- [ANSI C63.10:2013](#): American National Standard for Testing Unlicensed Wireless Devices
- [KDB789033 D02 v02r01](#): GUIDELINES FOR COMPLIANCE TESTING OF UNLICENSED NATIONAL INFORMATION INFRASTRUCTURE (U-NII) DEVICES PART 15, SUBPART E

1.2. Report version

Revision No.	Date of issue	Description
N/A	2023-07-13	Original

2. TEST DESCRIPTION

Report clause	Test Items	Standard Requirement	Result	Test Engineer
5.1	Antenna Requirement	15.203/15.247(c)	PASS	Xiaoqin Li
5.2	AC Conducted Emission	15.207	PASS	Yongjin Lin
5.3	Maximum Conducted Output Power	15.407(a)	PASS	Xiaoqin Li
5.4	Maximum Power Spectral Density	15.407(a)	PASS	Xiaoqin Li
5.5	26dB Bandwidth and 99% Occupancy bandwidth	15.407(a)	PASS	Xiaoqin Li
5.6	6dB Bandwidth	15.407(a)	PASS	Xiaoqin Li
5.7	Band edge	15.407(b)	PASS	Quanhai Deng
5.8	Radiated Spurious Emissions	15.209	PASS	Junman Wang
5.9	Frequency Stability	15.407(g)	PASS	Xiaoqin Li

Note:

- The measurement uncertainty is not included in the test result.

3. SUMMARY

3.1. Client Information

Applicant:	Guangzhou CHUANG ZAO MEI Technology Co.,Ltd.
Address:	Dehe international A505,No.2,Qixinggang Industrial Road, JUNHE street,Baiyun District,Guangzhou
Manufacturer:	Guangzhou CHUANG ZAO MEI Technology Co.,Ltd.
Address:	Dehe international A505,No.2,Qixinggang Industrial Road, JUNHE street,Baiyun District,Guangzhou

3.2. Product Description

Main unit information:	
Product Name:	Diode Laser Hair Removal Device
Trade Mark:	-
Model No.:	EVOLUTION MEDICAL
Listed Model(s):	M-I-X MEDICAL
Power supply:	AC 110V
Hardware version:	JWS3288-I_V1.4
Software version:	8.92 (Datolite)

3.3. Radio Specification Description

Support type ^{*1}	<input checked="" type="checkbox"/> 802.11a	<input checked="" type="checkbox"/> 802.11n	<input checked="" type="checkbox"/> 802.11ac
Support Bandwidth	20MHz:	802.11n, 802.11a, 802.11ac	
	40MHz:	802.11n, 802.11ac	
	80MHz:	802.11ac	
Operation frequency:	<input checked="" type="checkbox"/> U-NII-1 Band:	5150MHz~5250MHz	
	<input checked="" type="checkbox"/> U-NII-2A Band:	5250MHz~5350MHz	
	<input checked="" type="checkbox"/> U-NII-2C Band:	5470MHz~5725MHz	
	<input checked="" type="checkbox"/> U-NII-3 Band:	5725MHz~5850MHz	
Modulation:	BPSK, QPSK, 16QAM, 64QAM		
Function:	<input type="checkbox"/> Outdoor AP	<input type="checkbox"/> Indoor AP	<input type="checkbox"/> Fixed P2P
	<input checked="" type="checkbox"/> Client		
DFS type:	<input type="checkbox"/> Master devices	<input type="checkbox"/> Slave devices with radar detection	<input checked="" type="checkbox"/> Slave devices without radar detection
Antenna technology:	<input checked="" type="checkbox"/> SISO	<input type="checkbox"/> MIMO	
Antenna type:	FPC Antenna		
Antenna gain:	0 dBi		

Note:

*1: only show the RF function associated with this report.

3.4. Testing Laboratory Information

Laboratory Name	Shenzhen Huatongwei International Inspection Co., Ltd.	
Laboratory Location	1/F, Bldg 3, Hongfa Hi-tech Industrial Park, Genyu Road, Tianliao, Gongming, Shenzhen, China	
Contact information:	Phone: 86-755-26715499 E-mail: cs@szhtw.com.cn http://www.szhtw.com.cn	
Qualifications	Type	Accreditation Number
	FCC	762235

4. TEST CONFIGURATION

4.1. Test frequency list

According to section 15.31(m), regards to the operating frequency range over 10 MHz, must select three channels which were tested. The Lowest frequency, the middle frequency, and the highest frequency of channel were selected to perform the test, please see the below .

Band	Test Channel	20MHz		40MHz		80MHz	
		Channel	Frequency (MHz)	Channel	Frequency (MHz)	Channel	Frequency (MHz)
U-NII-1	CH _L	36	5180	38	5190	-	-
	CH _M	44	5220	-	-	42	5210
	CH _H	48	5240	46	5230	-	-
U-NII-2A	CH _L	52	5260	54	5270	-	-
	CH _M	56	5280	-	-	58	5290
	CH _H	64	5320	62	5310	-	-
U-NII-2C	CH _L	100	5500	102	5510	106	5530
	CH _M	116	5580	110	5550	122	5610
	CH _H	140	5700	134	5670	138	5690
	CH _{H1}	144	5720	142	5710		
U-NII-3	CH _L	149	5745	151	5755	-	-
	CH _M	157	5785	-	-	155	5775
	CH _H	165	5825	159	5795	-	-

4.2. Descriptions of Test mode

Preliminary tests were performed in different data rates, final test modes are considering the modulation and worse data rates as below table.

Modulation	Data rate
802.11a	6Mbps
802.11n(HT20)/ 802.11ac(HT20)	MCS0
802.11n(HT40)/ 802.11ac(HT40)	MCS0
802.11ac(HT80)	MCS0

4.3. Test mode

For RF test items
The engineering test program was provided and enabled to make EUT continuous transmit.
For AC power line conducted emissions:
The EUT was set to connect with the WLAN AP under large package sizes transmission.
For Radiated spurious emissions test item:
The engineering test program was provided and enabled to make EUT continuous transmit. The EUT in each of three orthogonal axis emissions had been tested, but only the worst case (X axis) data Recorded in the report.

4.4. Test sample information

Test item	HTW sample no.
RF Conducted test items	Please refer to the description in the appendix report
RF Radiated test items	YPHT23030637001
EMI test items	YPHT23030637001

Note:

RF Conducted test items: Maximum Conducted Output Power, Maximum Power Spectral Density , 26dB Bandwidth and 99% Occupancy bandwidth , 6dB Bandwidth ,Frequency Stability

RF Radiated test items: Band edge, Radiated Spurious Emission

EMI test items: AC Conducted Emission

4.5. Support unit used in test configuration and system

The EUT has been associated with peripherals and configuration operated in a manner tended to maximize its emission characteristics in a typical application.

The following peripheral devices and interface cables were connected during the measurement:

Whether support unit is used?			
✓ No			
Item	Equipment	Trade Name	Model No.
1			
2			

4.6. Testing environmental condition

Type	Requirement	Actual
Temperature:	15~35°C	25°C
Relative Humidity:	25~75%	50%
Air Pressure:	860~1060mbar	1000mbar

4.7. Statement of the measurement uncertainty

No.	Test Items	Measurement Uncertainty
1	AC Conducted Emission	3.21dB
2	Maximum Conducted Output Power	1.07
3	Maximum Power Spectral Density	1.07
4	26dB Bandwidth and 99% Occupancy bandwidth	0.002%
5	6dB Bandwidth	0.002%
6	Radiated Band Edge Emission	4.54dB for 30MHz-1GHz 5.10dB for above 1GHz
7	Radiated Spurious Emission	4.54dB for 30MHz-1GHz 5.10dB for above 1GHz
8	Frequency Stability	0.05ppm

This uncertainty represents an expanded uncertainty expressed at approximately the 95% confidence level using a coverage factor of $k=1.96$.

4.8. Equipment Used during the Test

● Conducted test item							
Used	Test Equipment	Manufacturer	Equipment No.	Model No.	Serial No.	Last Cal. Date (YY-MM-DD)	Next Cal. Date (YY-MM-DD)
●	Signal and spectrum Analyzer	R&S	HTWE0242	FSV40	100048	2022/08/25	2023/08/24
●	Signal & Spectrum Analyzer	R&S	HTWE0262	FSW26	103440	2022/08/25	2023/08/24
●	Vector signal generator	R&S	HTWE0244	SMBV100A	260790	2023/05/23	2024/05/22
●	Test software	Tonscend	N/A	JS1120	N/A	N/A	N/A

● Radiated emission- Below 1GHz							
Used	Test Equipment	Manufacturer	Equipment No.	Model No.	Serial No.	Last Cal. Date (YY-MM-DD)	Next Cal. Date (YY-MM-DD)
●	Semi-Anechoic Chamber	Albatross projects	HTWE0127	SAC-3m-02	C11121	2018/09/30	2023/09/29
●	EMI Test Receiver	R&S	HTWE0099	ESCI	100900	2022/08/30	2023/08/29
●	Loop Antenna	R&S	HTWE0546	HFH2-Z2E	101073	2021/05/25	2024/05/24
●	Ultra-Broadband Antenna	SCHWARZBECK	HTWE0547	VULB9163	945	2022/05/23	2025/05/22
●	Pre-Amplifier	SCHWARZBECK	HTWE0295	BBV 9742	N/A	2022/11/04	2023/11/03
●	RF Connection Cable	HUBER+SUHNER	HTWE0062-01	N/A	N/A	2023/02/24	2024/02/23
●	RF Connection Cable	HUBER+SUHNER	HTWE0062-02	SUCOFLEX104	501184/4	2023/02/24	2024/02/23
●	Test Software	R&S	N/A	ES-K1	N/A	N/A	N/A

● Radiated emission- Above 1GHz							
Used	Test Equipment	Manufacturer	Equipment No.	Model No.	Serial No.	Last Cal. Date (YY-MM-DD)	Next Cal. Date (YY-MM-DD)
●	Semi-Anechoic Chamber	Albatross projects	HTWE0122	SAC-3m-01	C11121	2018/09/27	2023/09/26
●	Spectrum Analyzer	R&S	HTWE0098	FSP40	100597	2022/08/25	2023/08/24
●	Horn Antenna	ETS	HTWE0548	3117	240120	2022/05/20	2025/05/19
●	Horn Antenna	STEATITE	HTWE0549	QMS-00880	25661	2022/05/20	2025/05/19
●	Pre-amplifier	CD	HTWE0071	PAP-0102	12004	2022/11/04	2023/11/03
●	Broadband Pre-amplifier	SCHWARZBECK	HTWE0201	BBV 9718	9718-248	2023/02/27	2024/02/26
●	RF Connection Cable	HUBER+SUHNER	HTWE0120-01	6m 18GHz S Serisa	N/A	2023/02/24	2024/02/23
●	RF Connection Cable	HUBER+SUHNER	HTWE0120-02	6m 3GHz RG Serisa	N/A	2023/02/24	2024/02/23
●	RF Connection Cable	HUBER+SUHNER	HTWE0119-05	6m 3GHz RG Serisa	N/A	2023/02/24	2024/02/23
●	RF Connection Cable	HUBER+SUHNER	HTWE0120-04	6m 3GHz RG Serisa	N/A	2023/02/24	2024/02/23
●	Test Software	Audix	N/A	E3	N/A	N/A	N/A

5. TEST CONDITIONS AND RESULTS

5.1. Antenna Requirement

Requirement

FCC CFR Title 47 Part 15 Subpart C Section 15.203:

An intentional radiator shall be designed to ensure that no antenna other than that furnished by the responsible party shall be used with the device. The use of a permanently attached antenna or of an antenna that uses a unique coupling to the intentional radiator, the manufacturer may design the unit so that a broken antenna can be replaced by the user, but the use of a standard antenna jack or electrical connector is prohibited.

TEST RESULT

Passed **Not Applicable**

The antenna type is a FPC antenna, please refer to the below antenna photo.

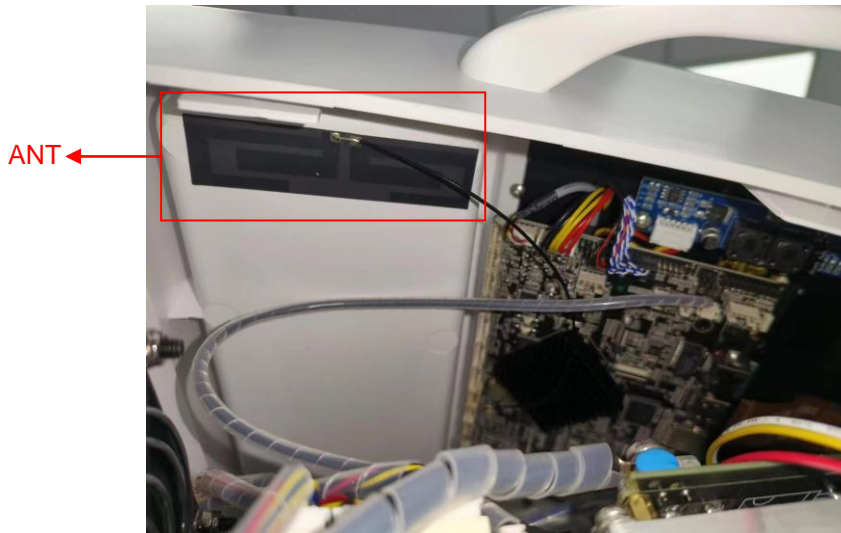

5.2. AC Conducted Emission

LIMIT

FCC CFR Title 47 Part 15 Subpart C Section 15.207

Frequency range (MHz)	Limit (dBuV)	
	Quasi-peak	Average
0.15-0.5	66 to 56*	56 to 46*
0.5-5	56	46
5-30	60	50

* Decreases with the logarithm of the frequency.

TEST CONFIGURATION

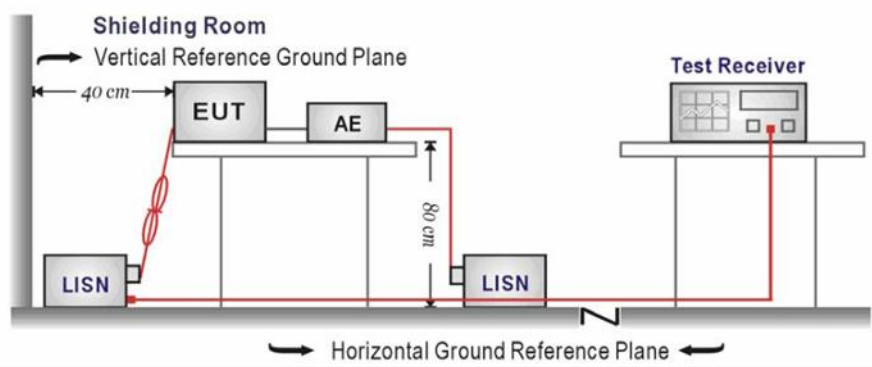

TEST PROCEDURE

1. The EUT was setup according to ANSI C63.10 requirements.
2. The EUT was placed on a platform of nominal size, 1 m by 1.5 m, raised 80 cm above the conducting ground plane. The vertical conducting plane was located 40 cm to the rear of the EUT. All other surfaces of EUT were at least 80 cm from any other grounded conducting surface.
3. The EUT and simulators are connected to the main power through a line impedances stabilization network (LISN). The LISN provides a 50 ohm /50uH coupling impedance for the measuring equipment.
4. The peripheral devices are also connected to the main power through a LISN. (Please refer to the block diagram of the test setup and photographs)
5. Each current-carrying conductor of the EUT power cord, except the ground (safety) conductor, was individually connected through a LISN to the input power source.
6. The excess length of the power cord between the EUT and the LISN receptacle were folded back and forth at the center of the lead to form a bundle not exceeding 40 cm in length.
7. Conducted emissions were investigated over the frequency range from 0.15MHz to 30MHz using a receiver bandwidth of 9 kHz.
8. During the above scans, the emissions were maximized by cable manipulation.

TEST MODE:

Please refer to the clause 4.3

TEST RESULT

Passed Not Applicable

Test Line:

L

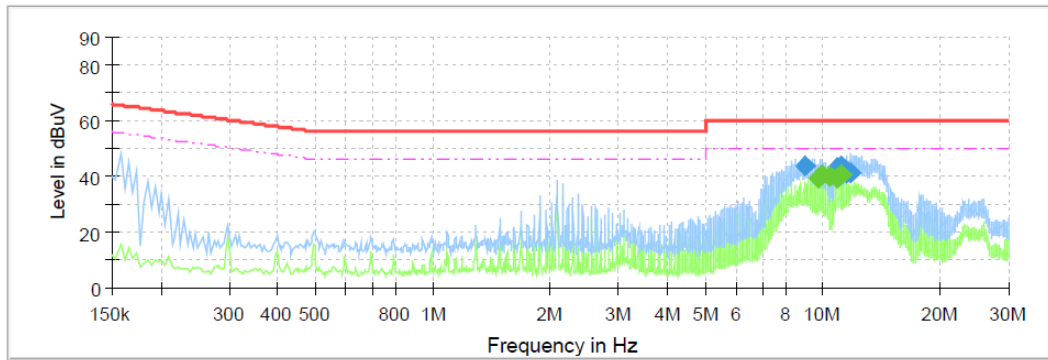

Final Result

Frequency (MHz)	QuasiPeak (dBuV)	CAverage (dBuV)	Limit (dBuV)	Margin (dB)	Line	Corr. (dB)
9.023500	43.58	---	60.00	16.42	L1	10.2
9.695500	---	39.59	50.00	10.41	L1	10.3
9.967500	---	40.44	50.00	9.56	L1	10.3
10.371500	---	40.16	50.00	9.84	L1	10.3
10.439500	---	39.82	50.00	10.18	L1	10.3
10.843500	43.15	---	60.00	16.85	L1	10.3
10.843500	---	39.55	50.00	10.45	L1	10.3
10.907500	43.17	---	60.00	16.83	L1	10.3
11.111500	43.93	---	60.00	16.07	L1	10.3
11.111500	---	40.68	50.00	9.32	L1	10.3
11.587500	41.16	---	60.00	18.84	L1	10.3
11.835500	41.20	---	60.00	18.80	L1	10.3

Test Line:

N

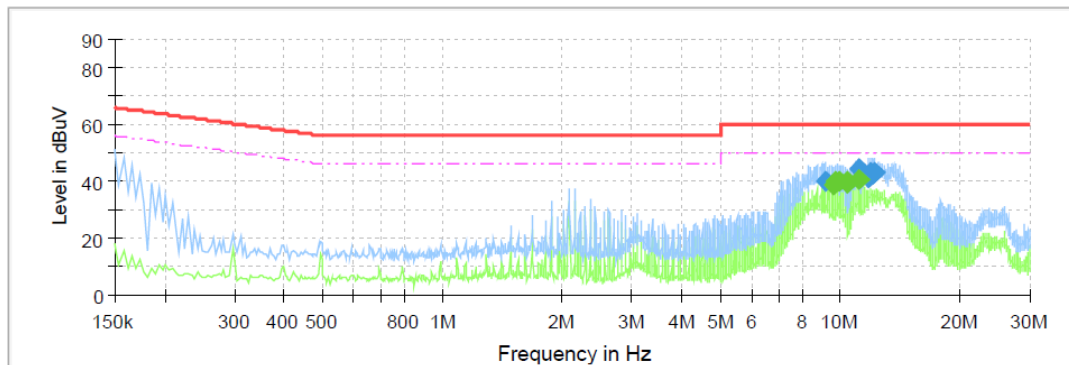

Final Result

Frequency (MHz)	QuasiPeak (dBuV)	CAverage (dBuV)	Limit (dBuV)	Margin (dB)	Line	Corr. (dB)
9.219500	39.85	---	60.00	20.15	N	10.2
9.631500	---	39.01	50.00	10.99	N	10.3
9.763500	---	40.03	50.00	9.97	N	10.3
9.967500	---	40.24	50.00	9.76	N	10.3
10.371500	---	40.27	50.00	9.73	N	10.3
10.439500	---	39.63	50.00	10.37	N	10.3
11.111500	44.09	---	60.00	15.91	N	10.3
11.111500	---	40.42	50.00	9.58	N	10.3
11.839500	41.34	---	60.00	18.66	N	10.3
11.923500	42.93	---	60.00	17.07	N	10.3
12.087500	42.19	---	60.00	17.81	N	10.3
12.143500	42.83	---	60.00	17.17	N	10.3

5.3. Maximum Conducted Output Power

LIMIT

FCC CFR Title 47 Part 15 Subpart E Section 15.407(a):

For the 5.15~5.25GHz band:

- Outdoor AP
The maximum conducted output power (P_{out}) shall not exceed the lesser of 1W (30dBm).
if $G_{TX} > 6\text{dBi}$, then $P_{out} = 30 - (G_{TX} - 6)$. e.i.r.p. at any elevation angle above 30 degrees $\leq 125\text{mW}$ (21dBm)
- Indoor AP
The maximum conducted output power (P_{out}) shall not exceed the lesser of 1W (30dBm).
if $G_{TX} > 6\text{dBi}$, then $P_{out} = 30 - (G_{TX} - 6)$.
- Point-to-point AP
The maximum conducted output power (P_{out}) shall not exceed the lesser of 1W (30dBm).
if $G_{TX} > 23\text{dBi}$, then $P_{out} = 30 - (G_{TX} - 23)$.
- Client devices
The maximum conducted output power (P_{out}) shall not exceed the lesser of 250W (24dBm).
if $G_{TX} > 6\text{dBi}$, then $P_{out} = 24 - (G_{TX} - 6)$.

For the 5.25~5.35GHz band:

The maximum conducted output power (P_{out}) shall not exceed the lesser of 250mW (24dBm) or 11dBm+10 log B, where B is the 26dB emission bandwidth in MHz.
if $G_{TX} > 6\text{dBi}$, then $P_{out} = 24 - (G_{TX} - 6)$.

For the 5.47~5.725GHz band:

The maximum conducted output power (P_{out}) shall not exceed the lesser of 250mW (24dBm) or 11dBm+10 log B, where B is the 26dB emission bandwidth in MHz.
if $G_{TX} > 6\text{dBi}$, then $P_{out} = 24 - (G_{TX} - 6)$.

For the 5.725~5.85GHz band:

- Point-to-multipoint systems (P2M)
The maximum conducted output power (P_{out}) shall not exceed the lesser of 1W (30dBm).
if $G_{TX} > 6\text{dBi}$, then $P_{out} = 30 - (G_{TX} - 6)$.
- Point-to-point systems (P2P)
The maximum conducted output power (P_{out}) shall not exceed the lesser of 1W (30dBm).

TEST CONFIGURATION

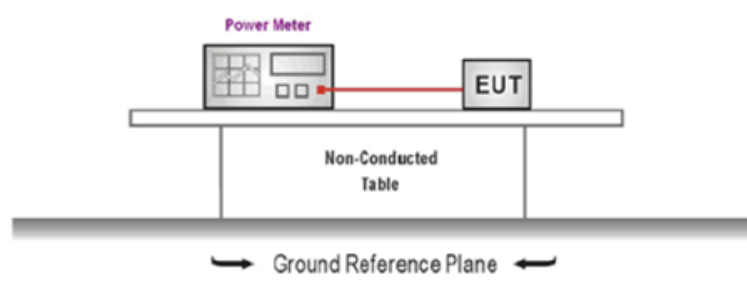

TEST PROCEDURE

1. The EUT was tested according to KDB789033 Section E-3-b)
2. The maximum conducted output power may be measured using a broadband AVG RF power meter.
3. Average power measurements were performed only when the EUT was transmitting at its maximum power control level using a broadband power meter with a pulse sensor.
4. The power meter implemented triggering and gating capabilities which were set up such that power measurements were recorded only during the ON time of the transmitter.
5. Record the measurement data.

6. TEST MODE:

Please refer to the clause 4.3

TEST RESULT

Passed **Not Applicable**

TEST DATA

Refer to the appendix report on the section 8

5.4. Power Spectral Density

LIMIT

FCC CFR Title 47 Part 15 Subpart E Section 15.407(a):

For the 5.15~5.25GHz band:

- Outdoor AP
The peak power spectral density (PSD) shall not exceed the lesser of 17dBm/MHz.
if $G_{TX} > 6\text{dBi}$, then $\text{PSD} = 17 - (G_{TX} - 6)$.
- Indoor AP
The peak power spectral density (PSD) shall not exceed the lesser of 17dBm/MHz.
if $G_{TX} > 6\text{dBi}$, then $\text{PSD} = 17 - (G_{TX} - 6)$.
- Point-to-point AP
The peak power spectral density (PSD) shall not exceed the lesser of 17dBm/MHz.
if $G_{TX} > 23\text{dBi}$, then $\text{PSD} = 17 - (G_{TX} - 23)$.
- Client devices
The peak power spectral density (PSD) shall not exceed the lesser of 11dBm/MHz.
if $G_{TX} > 6\text{dBi}$, then $\text{PSD} = 11 - (G_{TX} - 6)$.

For the 5.25~5.35GHz band:

The peak power spectral density (PSD) shall not exceed the lesser of 11dBm/MHz.
if $G_{TX} > 6\text{dBi}$, then $\text{PSD} = 11 - (G_{TX} - 6)$.

For the 5.47~5.725GHz band:

The peak power spectral density (PSD) shall not exceed the lesser of 11dBm/MHz.
if $G_{TX} > 6\text{dBi}$, then $\text{PSD} = 11 - (G_{TX} - 6)$.

For the 5.725~5.85GHz band:

- Point-to-multipoint systems (P2M)
The peak power spectral density (PSD) shall not exceed the lesser of 30dBm/500kHz.
if $G_{TX} > 6\text{dBi}$, then $\text{PSD} = 30 - (G_{TX} - 6)$.
- Point-to-point systems (P2P)
The peak power spectral density (PSD) shall not exceed the lesser of 30dBm/500kHz.

TEST CONFIGURATION

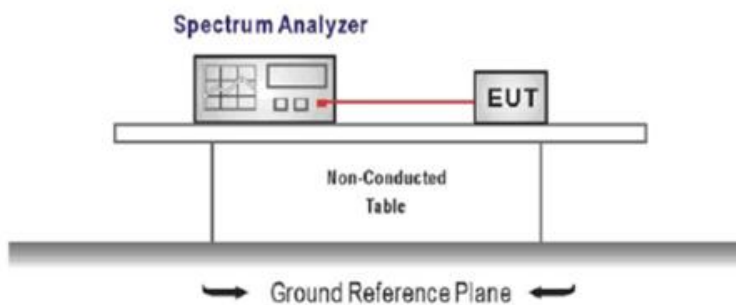

TEST PROCEDURE

1. According KDB 789033 D02 – Section F
2. Analyzer was setting as follow:
Center frequency: test channel
Span was set to encompass the entire emission bandwidth of the signal
RBW=1MHz for devices operating in the bands 5.15-5.25 GHz, 5.25-5.35 GHz, and 5.47-5.725 GHz
RBW=500kHz for devices operating in the band 5.725-5.85 GHz
VBW \geq 3 RBW
Number of sweep points $>$ 2 x (span/RBW)
Sweep time = auto
Detector = Peak
Trigger was set to free run for all modes, trace was averaged over 100 sweeps
3. The peak search function of the spectrum analyzer was used to find the peak of the spectrum.

TEST MODE:

Please refer to the clause 4.3

TEST RESULT

Passed **Not Applicable**

TEST DATA

Refer to the appendix report on the section 8

5.5. 26dB bandwidth and 99% Occupancy bandwidth

LIMIT

The bandwidth at 26dB down from the highest in-band spectral density is measured with a spectrum analyzer connected to the antenna terminal while the EUT is operating at its maximum duty cycle, at its maximum power control level, as defined in KDB 789033 D02 , and at the appropriate frequencies. The spectrum analyzer's bandwidth measurement function is configured to measure the 26dB bandwidth.

TEST CONFIGURATION

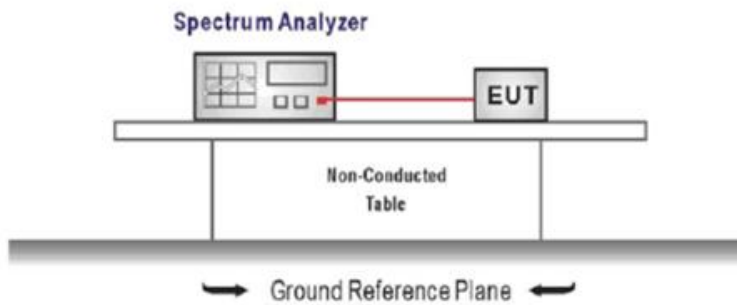

TEST PROCEDURE

1. According KDB 789033 D02 – Section C, 26dB bandwidth test as follow
 - a) Set RBW = approximately 1% of the emission bandwidth.
 - b) Set the VBW > RBW.
 - c) Detector = Peak.
 - d) Trace mode = max hold.
 - e) Measure the maximum width of the emission that is 26 dB down from the maximum of the emission. Compare this with the RBW setting of the analyzer. Readjust RBW and repeat measurement as needed until the RBW/EBW ratio is approximately 1%.
2. According KDB 789033 D02 – Section D, 99% bandwidth test as follow
 - a). Set center frequency to the nominal EUT channel center frequency.
 - b). Set span = 1.5 times to 5.0 times the OBW.
 - c). Set RBW = 1% to 5% of the OBW
 - d). Set VBW ≥ 3 RBW
 - e). Video averaging is not permitted. Where practical, a sample detection and single sweep mode shall be used. Otherwise, peak detection and max hold mode (until the trace stabilizes) shall be used.
 - f). Use the 99% power bandwidth function of the instrument

TEST MODE:

Please refer to the clause 4.3

TEST RESULT

Passed Not Applicable

TEST DATA

Refer to the appendix report on the section 8

5.6. 6dB Bandwidth

LIMIT

FCC CFR Title 47 Part 15 Subpart E Section 15.407(e)

Within the 5.725-5.85 GHz band, the minimum 6 dB bandwidth of U-NII devices shall be at least 500 kHz

TEST CONFIGURATION

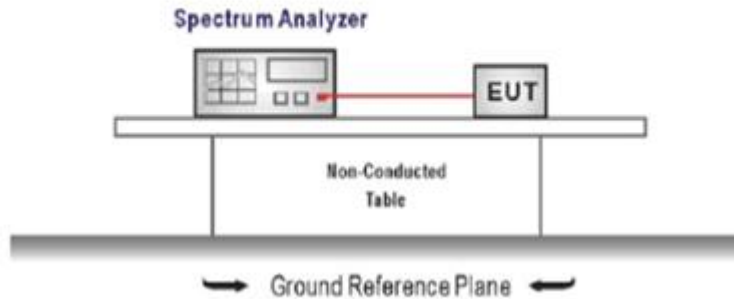

TEST PROCEDURE

1. Connect the antenna port(s) to the spectrum analyzer input.
2. Configure the spectrum analyzer as shown below (enter all losses between the transmitter output and the spectrum analyzer).
Center Frequency = test channel center frequency
Span = 2 x emission bandwidth
RBW = 100 kHz, VBW \geq 3 x RBW
Sweep time = auto couple
Detector = Peak
Trace mode = max hold
3. Place the radio in continuous transmit mode, allow the trace to stabilize, view the transmitter wave form on the spectrum analyzer.
4. Measure the maximum width of the emission that is constrained by the frequencies associated with the two outermost amplitude points (upper and lower frequencies) that are attenuated by 6 dB relative to the maximum level measured in the fundamental emission, and record the pertinent measurements.

TEST MODE:

Please refer to the clause 4.3

TEST RESULT

Passed Not Applicable

TEST DATA

Refer to the appendix report on the section 8

5.7. Band edge

LIMIT

FCC CFR Title 47 Part 15 Subpart E Section 15.407(b)

Un-restricted band emissions above 1GHz			
Operating Band	Frequency	EIRP Limit	Value
5150-5250MHz	Above 1GHz	-27dBm/MHz(68.2dBuV/m)@3m	Peak
5250-5350MHz	Above 1GHz	-27dBm/MHz(68.2dBuV/m)@3m	Peak
5470-5725MHz	Above 1GHz	-27dBm/MHz(68.2dBuV/m)@3m	Peak
5725-5850 MHz	1GHz-5.65GHz	-27 dBm/MHz(68.2dBuV/m)@3m	Peak
	5.65GHz-5.7GHz	-27*dBm/MHz to 10dBm/MHz (68.2* dBuV/m to 105.6dBuV/m)	Peak
	5.7GHz-5.72GHz	10*dBm/MHz to 15.6dBm/MHz (105.6*dBuV/m to 110.8dBuV/m)	Peak
	5.72GHz-5.725GHz	15.6*dBm/MHz to 27dBm/MHz (110.8dBuV/m to* 122.2dBuV/m)	Peak
	5.85GHz-5.855GHz	27dBm/MHz to 15.6*dBm/MHz (122.2dBuV/m to110.8* dBuV/m)	Peak
	5.855GHz-5.875GHz	15.6dBm/MHz to 10*dBm/MHz (110.8dBuV/m to 105.6* dBuV/m)	Peak
	5.875GHz-5.925GHz	10dBm/MHz to -27*dBm/MHz (105.6dBuV/m to 68.2* dBuV/m)	Peak
	Above 5.925GHz	-27 dBm/MHz(68.2dBuV/m)@3m	Peak

* Increase/Decreases with the linearly of the frequency.

For emission above 1GHz and in restricted band, according to FCC KDB 789033 D02 General UNII Test Procedure, all emission that complies with both the average and peak limits of Section 15.209 is not required to satisfy the -27 dBm/MHz peak emission limit. $E[dBuV/m] = EIRP[dBm] + 95.2$, for $d = 3$ meters.

TEST CONFIGURATION

Radiated:

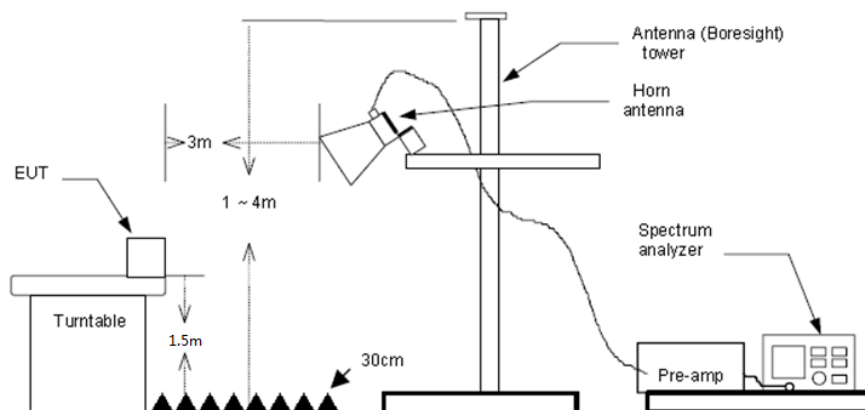

TEST PROCEDURE

1. The EUT was setup and tested according to ANSI C63.10:2013 requirements.
2. The EUT is placed on a turn table which is 1.5 meter above ground. The turn table is rotated 360 degrees to determine the position of the maximum emission level.
3. The EUT was positioned such that the distance from antenna to the EUT was 3 meters.
4. The antenna is scanned from 1 meter to 4 meters to find out the maximum emission level. This is repeated for both horizontal and vertical polarization of the antenna. In order to find the maximum emission, all of the interface cables were manipulated according to ANSI C63.10:2013 on radiated measurement.
5. The receiver set as follow:
RBW=1MHz, VBW=3MHz PEAK detector for Peak value.
RBW=1MHz, VBW=3MHz RMS detector for Average value.

TEST MODE:

Please refer to the clause 4.3

TEST RESULTS

Passed **Not Applicable**

TEST DATA

U-NII-1 & U-NII-2A		Worst mode: 802.11a					Test channel: CH _L				
Polarization:						Horizontal					
Mark	Frequency MHz	Reading dBuV/m	Antenna dB	Cable dB	Preamp dB	Aux dB	Level dBuV/m	Limit dBuV/m	Over limit	Remark	
1	5085.04	41.07	34.20	5.80	40.83	10.00	50.24	68.20	-17.96	Peak	
2	5149.46	50.64	34.20	5.84	40.78	10.00	59.90	68.20	-8.30	Peak	
3	5150.07	49.44	34.20	5.84	40.78	10.00	58.70	68.20	-9.50	Peak	
Mark	Frequency MHz	Reading dBuV/m	Antenna dB	Cable dB	Preamp dB	Aux dB	Level dBuV/m	Limit dBuV/m	Over limit	Remark	
1	5074.08	28.47	34.20	5.79	40.84	10.00	37.62	54.00	-16.38	Average	
2	5150.07	33.12	34.20	5.84	40.78	10.00	42.38	54.00	-11.62	Average	
Polarization:						Vertical					
Mark	Frequency MHz	Reading dBuV/m	Antenna dB	Cable dB	Preamp dB	Aux dB	Level dBuV/m	Limit dBuV/m	Over limit	Remark	
1	5086.44	40.11	34.20	5.80	40.83	10.00	49.28	68.20	-18.92	Peak	
2	5149.67	50.78	34.20	5.84	40.78	10.00	60.04	68.20	-8.16	Peak	
3	5150.07	47.84	34.20	5.84	40.78	10.00	57.10	68.20	-11.10	Peak	
Mark	Frequency MHz	Reading dBuV/m	Antenna dB	Cable dB	Preamp dB	Aux dB	Level dBuV/m	Limit dBuV/m	Over limit	Remark	
1	5092.03	28.51	34.20	5.81	40.83	10.00	37.69	54.00	-16.31	Average	
2	5150.07	33.13	34.20	5.84	40.78	10.00	42.39	54.00	-11.61	Average	

U-NII-1 & U-NII-2A		Worst mode: 802.11a					Test channel: CH _H				
Polarization:						Horizontal					
Mark	Frequency MHz	Reading dBuV/m	Antenna dB	Cable dB	Preamp dB	Aux dB	Level dBuV/m	Limit dBuV/m	Over limit	Remark	
1	5349.93	38.51	34.40	5.97	40.63	10.00	48.25	68.20	-19.95	Peak	
2	5459.99	38.36	34.52	6.04	40.54	10.00	48.38	68.20	-19.82	Peak	
Mark	Frequency MHz	Reading dBuV/m	Antenna dB	Cable dB	Preamp dB	Aux dB	Level dBuV/m	Limit dBuV/m	Over limit	Remark	
1	5349.93	27.37	34.40	5.97	40.63	10.00	37.11	54.00	-16.89	Average	
2	5459.99	27.40	34.52	6.04	40.54	10.00	37.42	54.00	-16.58	Average	
Polarization:						Vertical					
Mark	Frequency MHz	Reading dBuV/m	Antenna dB	Cable dB	Preamp dB	Aux dB	Level dBuV/m	Limit dBuV/m	Over limit	Remark	
1	5349.93	38.28	34.40	5.97	40.63	10.00	48.02	68.20	-20.18	Peak	
2	5459.99	39.09	34.52	6.04	40.54	10.00	49.11	68.20	-19.09	Peak	
Mark	Frequency MHz	Reading dBuV/m	Antenna dB	Cable dB	Preamp dB	Aux dB	Level dBuV/m	Limit dBuV/m	Over limit	Remark	
1	5349.93	27.13	34.40	5.97	40.63	10.00	36.87	54.00	-17.13	Average	
2	5459.99	27.29	34.52	6.04	40.54	10.00	37.31	54.00	-16.69	Average	

U-NII-2C		Worst mode: 802.11a					Test channel: CH _L				
Polarization:						Horizontal					
Mark	Frequency MHz	Reading dBuV/m	Antenna dB	Cable dB	Preamp dB	Aux dB	Level dBuV/m	Limit dBuV/m	Over limit	Remark	
1	5460.09	39.93	34.52	6.04	40.54	10.00	49.95	68.20	-18.25	Peak	
2	5469.92	45.21	34.54	6.05	40.54	10.00	55.26	68.20	-12.94	Peak	
Mark	Frequency MHz	Reading dBuV/m	Antenna dB	Cable dB	Preamp dB	Aux dB	Level dBuV/m	Limit dBuV/m	Over limit	Remark	
1	5460.09	28.42	34.52	6.04	40.54	10.00	38.44	54.00	-15.56	Average	
2	5469.92	31.48	34.54	6.05	40.54	10.00	41.53	54.00	-12.47	Average	
Polarization:						Vertical					
Mark	Frequency MHz	Reading dBuV/m	Antenna dB	Cable dB	Preamp dB	Aux dB	Level dBuV/m	Limit dBuV/m	Over limit	Remark	
1	5460.09	41.62	34.52	6.04	40.54	10.00	51.64	68.20	-16.56	Peak	
2	5469.92	47.37	34.54	6.05	40.54	10.00	57.42	68.20	-10.78	Peak	
Mark	Frequency MHz	Reading dBuV/m	Antenna dB	Cable dB	Preamp dB	Aux dB	Level dBuV/m	Limit dBuV/m	Over limit	Remark	
1	5460.09	29.08	34.52	6.04	40.54	10.00	39.10	54.00	-14.90	Average	
2	5469.92	33.65	34.54	6.05	40.54	10.00	43.70	54.00	-10.30	Average	

U-NII-2C		Worst mode: 802.11a					Test channel: CH _H				
Polarization:						Horizontal					
Mark	Frequency MHz	Reading dBuV/m	Antenna dB	Cable dB	Preamp dB	Aux dB	Level dBuV/m	Limit dBuV/m	Over limit	Remark	
1	5725.04	39.07	34.54	6.20	40.50	10.00	49.31	68.20	-18.89	Peak	
Mark	Frequency MHz	Reading dBuV/m	Antenna dB	Cable dB	Preamp dB	Aux dB	Level dBuV/m	Limit dBuV/m	Over limit	Remark	
1	5725.04	28.57	34.54	6.20	40.50	10.00	38.81	54.00	-15.19	Average	
Polarization:						Vertical					
Mark	Frequency MHz	Reading dBuV/m	Antenna dB	Cable dB	Preamp dB	Aux dB	Level dBuV/m	Limit dBuV/m	Over limit	Remark	
1	5725.04	41.52	34.54	6.20	40.50	10.00	51.76	68.20	-16.44	Peak	
Mark	Frequency MHz	Reading dBuV/m	Antenna dB	Cable dB	Preamp dB	Aux dB	Level dBuV/m	Limit dBuV/m	Over limit	Remark	
1	5725.04	29.23	34.54	6.20	40.50	10.00	39.47	54.00	-14.53	Average	

U-NII-1 & U-NII-2A		Worst mode: 802.11ac(HT40)					Test channel: CH _L				
Polarization:						Horizontal					
Mark	Frequency MHz	Reading dBuV/m	Antenna dB	Cable dB	Preamp dB	Aux dB	Level dBuV/m	Limit dBuV/m	Over limit	Remark	
1	5127.70	48.85	32.09	5.83	35.46	10.00	61.31	68.20	-6.89	Peak	
2	5149.67	52.48	32.00	5.84	35.45	10.00	64.87	68.20	-3.33	Peak	
3	5150.07	50.52	32.00	5.84	35.44	10.00	62.92	68.20	-5.28	Peak	
Mark	Frequency MHz	Reading dBuV/m	Antenna dB	Cable dB	Preamp dB	Aux dB	Level dBuV/m	Limit dBuV/m	Over limit	Remark	
1	5150.07	33.16	32.00	5.84	35.44	10.00	45.56	54.00	-8.44	Average	
Polarization:						Vertical					
Mark	Frequency MHz	Reading dBuV/m	Antenna dB	Cable dB	Preamp dB	Aux dB	Level dBuV/m	Limit dBuV/m	Over limit	Remark	
1	5126.29	51.81	32.09	5.83	35.46	10.00	64.27	68.20	-3.93	Peak	
2	5149.67	52.76	32.00	5.84	35.45	10.00	65.15	68.20	-3.05	Peak	
3	5150.07	48.17	32.00	5.84	35.44	10.00	60.57	68.20	-7.63	Peak	
Mark	Frequency MHz	Reading dBuV/m	Antenna dB	Cable dB	Preamp dB	Aux dB	Level dBuV/m	Limit dBuV/m	Over limit	Remark	
1	5102.22	32.52	32.19	5.81	35.48	10.00	45.04	54.00	-8.96	Average	
2	5150.07	35.80	32.00	5.84	35.44	10.00	48.20	54.00	-5.80	Average	

U-NII-1 & U-NII-2A		Worst mode: 802.11ac(HT40)					Test channel: CH _H				
Polarization:						Horizontal					
Mark	Frequency MHz	Reading dBuV/m	Antenna dB	Cable dB	Preamp dB	Aux dB	Level dBuV/m	Limit dBuV/m	Over limit	Remark	
1	5349.93	48.32	31.50	5.97	35.37	10.00	60.42	68.20	-7.78	Peak	
2	5459.99	41.97	31.74	6.04	35.39	10.00	54.36	68.20	-13.84	Peak	
Mark	Frequency MHz	Reading dBuV/m	Antenna dB	Cable dB	Preamp dB	Aux dB	Level dBuV/m	Limit dBuV/m	Over limit	Remark	
1	5349.93	37.04	31.50	5.97	35.37	10.00	49.14	54.00	-4.86	Average	
2	5459.99	32.91	31.74	6.04	35.39	10.00	45.30	54.00	-8.70	Average	
Polarization:						Vertical					
Mark	Frequency MHz	Reading dBuV/m	Antenna dB	Cable dB	Preamp dB	Aux dB	Level dBuV/m	Limit dBuV/m	Over limit	Remark	
1	5349.93	51.00	31.50	5.97	35.37	10.00	63.10	68.20	-5.10	Peak	
2	5459.99	44.36	31.74	6.04	35.39	10.00	56.75	68.20	-11.45	Peak	
Mark	Frequency MHz	Reading dBuV/m	Antenna dB	Cable dB	Preamp dB	Aux dB	Level dBuV/m	Limit dBuV/m	Over limit	Remark	
1	5349.93	37.63	31.50	5.97	35.37	10.00	49.73	54.00	-4.27	Average	
2	5459.99	32.94	31.74	6.04	35.39	10.00	45.33	54.00	-8.67	Average	

U-NII-2C		Worst mode: 802.11ac(HT40)					Test channel: CH _L			
Polarization:						Horizontal				
Mark	Frequency MHz	Reading dBuV/m	Antenna dB	Cable dB	Preamp dB	Aux dB	Level dBuV/m	Limit dBuV/m	Over limit	Remark
1	5460.09	38.81	31.74	6.04	35.39	10.00	51.20	68.20	-17.00	Peak
2	5469.92	40.59	31.78	6.05	35.37	10.00	53.05	68.20	-15.15	Peak
Mark	Frequency MHz	Reading dBuV/m	Antenna dB	Cable dB	Preamp dB	Aux dB	Level dBuV/m	Limit dBuV/m	Over limit	Remark
1	5460.09	27.02	31.74	6.04	35.39	10.00	39.41	54.00	-14.59	Average
2	5469.92	28.20	31.78	6.05	35.37	10.00	40.66	54.00	-13.34	Average
Polarization:						Vertical				
Mark	Frequency MHz	Reading dBuV/m	Antenna dB	Cable dB	Preamp dB	Aux dB	Level dBuV/m	Limit dBuV/m	Over limit	Remark
1	5460.09	38.84	31.74	6.04	35.39	10.00	51.23	68.20	-16.97	Peak
2	5469.92	42.00	31.78	6.05	35.37	10.00	54.46	68.20	-13.74	Peak
Mark	Frequency MHz	Reading dBuV/m	Antenna dB	Cable dB	Preamp dB	Aux dB	Level dBuV/m	Limit dBuV/m	Over limit	Remark
1	5460.09	27.67	31.74	6.04	35.39	10.00	40.06	54.00	-13.94	Average
2	5469.92	29.42	31.78	6.05	35.37	10.00	41.88	54.00	-12.12	Average

U-NII-2C		Worst mode: 802.11ac(HT40)					Test channel: CH _H			
Polarization:						Horizontal				
Mark	Frequency MHz	Reading dBuV/m	Antenna dB	Cable dB	Preamp dB	Aux dB	Level dBuV/m	Limit dBuV/m	Over limit	Remark
1	5725.00	41.11	31.90	6.20	34.87	10.00	54.34	68.20	-13.86	Peak
Mark	Frequency MHz	Reading dBuV/m	Antenna dB	Cable dB	Preamp dB	Aux dB	Level dBuV/m	Limit dBuV/m	Over limit	Remark
1	5725.00	27.94	31.90	6.20	34.87	10.00	41.17	54.00	-12.83	Average
Polarization:						Vertical				
Mark	Frequency MHz	Reading dBuV/m	Antenna dB	Cable dB	Preamp dB	Aux dB	Level dBuV/m	Limit dBuV/m	Over limit	Remark
1	5725.00	48.01	31.90	6.20	34.87	10.00	61.24	68.20	-6.96	Peak
Mark	Frequency MHz	Reading dBuV/m	Antenna dB	Cable dB	Preamp dB	Aux dB	Level dBuV/m	Limit dBuV/m	Over limit	Remark
1	5725.00	33.40	31.90	6.20	34.87	10.00	46.63	54.00	-7.37	Average

U-NII-1 & U-NII-2A		Worst mode: 802.11n(HT80)					Test channel: CH _M				
Polarization:						Horizontal					
Mark	Frequency MHz	Reading dBuV/m	Antenna dB	Cable dB	Preamp dB	Aux dB	Level dBuV/m	Limit dBuV/m	Over limit	Remark	
1	5118.25	49.51	32.13	5.82	35.47	10.00	61.99	68.20	-6.21	Peak	
2	5150.07	45.58	32.00	5.84	35.44	10.00	57.98	68.20	-10.22	Peak	
Mark	Frequency MHz	Reading dBuV/m	Antenna dB	Cable dB	Preamp dB	Aux dB	Level dBuV/m	Limit dBuV/m	Over limit	Remark	
1	5141.19	38.20	32.04	5.84	35.45	10.00	50.63	54.00	-3.37	Average	
2	5150.07	37.60	32.00	5.84	35.44	10.00	50.00	54.00	-4.00	Average	
Polarization:						Vertical					
Mark	Frequency MHz	Reading dBuV/m	Antenna dB	Cable dB	Preamp dB	Aux dB	Level dBuV/m	Limit dBuV/m	Over limit	Remark	
1	5079.66	50.29	32.20	5.80	35.44	10.00	62.85	68.20	-5.35	Peak	
2	5150.07	50.45	32.00	5.84	35.44	10.00	62.85	68.20	-5.35	Peak	
Mark	Frequency MHz	Reading dBuV/m	Antenna dB	Cable dB	Preamp dB	Aux dB	Level dBuV/m	Limit dBuV/m	Over limit	Remark	
1	5126.89	37.32	32.09	5.83	35.46	10.00	49.78	54.00	-4.22	Average	
2	5150.07	37.15	32.00	5.84	35.44	10.00	49.55	54.00	-4.45	Average	

U-NII-1 & U-NII-2A		Worst mode: 802.11n(HT80)					Test channel: CH _M				
Polarization:						Horizontal					
Mark	Frequency MHz	Reading dBuV/m	Antenna dB	Cable dB	Preamp dB	Aux dB	Level dBuV/m	Limit dBuV/m	Over limit	Remark	
1	5349.93	50.33	31.50	5.97	35.37	10.00	62.43	68.20	-5.77	Peak	
2	5459.99	42.84	31.74	6.04	35.39	10.00	55.23	68.20	-12.97	Peak	
Mark	Frequency MHz	Reading dBuV/m	Antenna dB	Cable dB	Preamp dB	Aux dB	Level dBuV/m	Limit dBuV/m	Over limit	Remark	
1	5349.93	37.08	31.50	5.97	35.37	10.00	49.18	54.00	-4.82	Average	
2	5459.99	31.07	31.74	6.04	35.39	10.00	43.46	54.00	-10.54	Average	
Polarization:						Vertical					
Mark	Frequency MHz	Reading dBuV/m	Antenna dB	Cable dB	Preamp dB	Aux dB	Level dBuV/m	Limit dBuV/m	Over limit	Remark	
1	5349.93	47.14	31.50	5.97	35.37	10.00	59.24	68.20	-8.96	Peak	
2	5459.99	47.81	31.74	6.04	35.39	10.00	60.20	68.20	-8.00	Peak	
Mark	Frequency MHz	Reading dBuV/m	Antenna dB	Cable dB	Preamp dB	Aux dB	Level dBuV/m	Limit dBuV/m	Over limit	Remark	
1	5349.93	36.39	31.50	5.97	35.37	10.00	48.49	54.00	-5.51	Average	
2	5459.99	31.94	31.74	6.04	35.39	10.00	44.33	54.00	-9.67	Average	

U-NII-2C		Worst mode: 802.11ac(HT80)					Test channel: CH _L				
Polarization:						Horizontal					
Mark	Frequency MHz	Reading dBuV/m	Antenna dB	Cable dB	Preamp dB	Aux dB	Level dBuV/m	Limit dBuV/m	Over limit	Remark	
1	5460.09	47.51	31.74	6.04	35.39	10.00	59.90	68.20	-8.30	Peak	
2	5469.92	44.98	31.78	6.05	35.37	10.00	57.44	68.20	-10.76	Peak	

Mark	Frequency MHz	Reading dBuV/m	Antenna dB	Cable dB	Preamp dB	Aux dB	Level dBuV/m	Limit dBuV/m	Over limit	Remark	
1	5460.09	31.05	31.74	6.04	35.39	10.00	43.44	54.00	-10.56	Average	
2	5469.92	30.97	31.78	6.05	35.37	10.00	43.43	54.00	-10.57	Average	
Polarization:						Vertical					
Mark	Frequency MHz	Reading dBuV/m	Antenna dB	Cable dB	Preamp dB	Aux dB	Level dBuV/m	Limit dBuV/m	Over limit	Remark	
1	5460.09	46.87	31.74	6.04	35.39	10.00	59.26	68.20	-8.94	Peak	
2	5469.92	46.83	31.78	6.05	35.37	10.00	59.29	68.20	-8.91	Peak	

Mark	Frequency MHz	Reading dBuV/m	Antenna dB	Cable dB	Preamp dB	Aux dB	Level dBuV/m	Limit dBuV/m	Over limit	Remark	
1	5460.09	34.26	31.74	6.04	35.39	10.00	46.65	54.00	-7.35	Average	
2	5469.92	34.17	31.78	6.05	35.37	10.00	46.63	54.00	-7.37	Average	

U-NII-2C		Worst mode: 802.11ac(HT80)					Test channel: CH _M				
Polarization:						Horizontal					
Mark	Frequency MHz	Reading dBuV/m	Antenna dB	Cable dB	Preamp dB	Aux dB	Level dBuV/m	Limit dBuV/m	Over limit	Remark	
1	5725.00	44.67	31.90	6.20	34.87	10.00	57.90	68.20	-10.30	Peak	
Polarization:						Vertical					
Mark	Frequency MHz	Reading dBuV/m	Antenna dB	Cable dB	Preamp dB	Aux dB	Level dBuV/m	Limit dBuV/m	Over limit	Remark	
1	5725.00	45.30	31.90	6.20	34.87	10.00	58.53	68.20	-9.67	Peak	

U-NII-3 Worst mode: 802.11a Test channel: CH _L										
Frequency (MHz)	Read Level (dBuV)	Antenna Factor (dB/m)	Cable Loss (dB)	Aux Factor (dB)	Preamp Factor (dB)	Level (dBuV/m)	Limit Line (dBuV/m)	Over Limit (dB)	Test value	Polarization
5650.00	37.67	34.50	6.16	10.00	40.50	47.83	68.20	-20.37	Vertical	Peak
5700.01	38.21	34.50	6.19	10.00	40.50	48.40	68.20	-19.80	Vertical	Peak
5720.05	45.73	34.53	6.20	10.00	40.50	55.96	68.20	-12.24	Vertical	Peak
5650.00	37.89	34.50	6.16	10.00	40.50	48.05	68.20	-20.15	Horizontal	Peak
5700.01	38.85	34.50	6.19	10.00	40.50	49.04	68.20	-19.16	Horizontal	Peak
5720.05	46.91	34.53	6.20	10.00	40.50	57.14	68.20	-11.06	Horizontal	Peak
U-NII-3 Worst mode: 802.11a Test channel: CH _H										
Frequency (MHz)	Read Level (dBuV)	Antenna Factor (dB/m)	Cable Loss (dB)	Aux Factor (dB)	Preamp Factor (dB)	Level (dBuV/m)	Limit Line (dBuV/m)	Over Limit (dB)	Test value	Polarization
5849.96	55.30	34.80	6.28	10.00	40.26	66.12	68.20	-2.08	Vertical	Peak
5875.00	38.22	34.85	6.29	10.00	40.16	49.20	68.20	-19.00	Vertical	Peak
5925.01	38.49	35.00	6.32	10.00	39.95	49.86	68.20	-18.34	Vertical	Peak
5849.96	50.63	34.80	6.28	10.00	40.26	61.45	68.20	-6.75	Horizontal	Peak
5875.00	37.65	34.85	6.29	10.00	40.16	48.63	68.20	-19.57	Horizontal	Peak
5925.01	38.32	35.00	6.32	10.00	39.95	49.69	68.20	-18.51	Horizontal	Peak
U-NII-3 Worst mode: 802.11ac(HT40) Test channel: CH _L										
Frequency (MHz)	Read Level (dBuV)	Antenna Factor (dB/m)	Cable Loss (dB)	Aux Factor (dB)	Preamp Factor (dB)	Level (dBuV/m)	Limit Line (dBuV/m)	Over Limit (dB)	Test value	Polarization
5650.12	37.77	34.50	6.16	10.00	40.50	47.93	68.20	-20.27	Vertical	Peak
5699.92	42.33	34.50	6.19	10.00	40.50	52.52	68.20	-15.68	Vertical	Peak
5719.97	49.01	34.53	6.20	10.00	40.50	59.24	68.20	-8.96	Vertical	Peak
5650.12	37.84	34.50	6.16	10.00	40.50	48.00	68.20	-20.20	Horizontal	Peak
5699.92	40.60	34.50	6.19	10.00	40.50	50.79	68.20	-17.41	Horizontal	Peak
5719.97	49.67	34.53	6.20	10.00	40.50	59.90	68.20	-8.30	Horizontal	Peak
U-NII-3 Worst mode: 802.11ac(HT40) Test channel: CH _H										
Frequency (MHz)	Read Level (dBuV)	Antenna Factor (dB/m)	Cable Loss (dB)	Aux Factor (dB)	Preamp Factor (dB)	Level (dBuV/m)	Limit Line (dBuV/m)	Over Limit (dB)	Test value	Polarization
5849.88	49.18	34.80	6.28	10.00	40.26	60.00	68.20	-8.20	Vertical	Peak
5875.14	41.59	34.85	6.29	10.00	40.15	52.58	68.20	-15.62	Vertical	Peak
5925.07	37.88	35.00	6.32	10.00	39.95	49.25	68.20	-18.95	Vertical	Peak
5849.88	47.35	34.80	6.28	10.00	40.26	58.17	68.20	-10.03	Horizontal	Peak
5875.14	39.28	34.85	6.29	10.00	40.15	50.27	68.20	-17.93	Horizontal	Peak
5925.07	38.38	35.00	6.32	10.00	39.95	49.75	68.20	-18.45	Horizontal	Peak

U-NII-3 Worst mode: 802.11ac(HT80) Test channel: CH _M										
Frequency (MHz)	Read Level (dBuV)	Antenna Factor (dB/m)	Cable Loss (dB)	Aux Factor (dB)	Preamplifier Factor (dB)	Level (dBuV/m)	Limit Line (dBuV/m)	Over Limit (dB)	Test value	Polarization
5650.00	39.23	34.50	6.16	10.00	40.50	49.39	68.20	-18.81	Vertical	Peak
5700.01	45.74	34.50	6.19	10.00	40.50	55.93	68.20	-12.27	Vertical	Peak
5720.05	51.31	34.53	6.20	10.00	40.50	61.54	68.20	-6.66	Vertical	Peak
5650.00	37.91	34.50	6.16	10.00	40.50	48.07	68.20	-20.13	Horizontal	Peak
5700.01	47.14	34.50	6.19	10.00	40.50	57.33	68.20	-10.87	Horizontal	Peak
5720.05	49.86	34.53	6.20	10.00	40.50	60.09	68.20	-8.11	Horizontal	Peak
U-NII-3 Worst mode: 802.11ac(HT80) Test channel: CH _M										
Frequency (MHz)	Read Level (dBuV)	Antenna Factor (dB/m)	Cable Loss (dB)	Aux Factor (dB)	Preamplifier Factor (dB)	Level (dBuV/m)	Limit Line (dBuV/m)	Over Limit (dB)	Test value	Polarization
5849.96	52.60	34.80	6.28	10.00	40.26	63.42	68.20	-4.78	Vertical	Peak
5875.00	47.62	34.85	6.29	10.00	40.16	58.60	68.20	-9.60	Vertical	Peak
5925.01	39.01	35.00	6.32	10.00	39.95	50.38	68.20	-17.82	Vertical	Peak
5849.96	48.01	34.80	6.28	10.00	40.26	58.83	68.20	-9.37	Horizontal	Peak
5875.00	45.78	34.85	6.29	10.00	40.16	56.76	68.20	-11.44	Horizontal	Peak
5925.01	39.32	35.00	6.32	10.00	39.95	50.69	68.20	-17.51	Horizontal	Peak

Remark:

1. Final Level = Receiver Read level + Factor
2. The emission levels of other frequencies are very lower than the limit and not show in test report.
3. Test 802.11a, 802.11n, 802.11ac mode, all modulations have been tested, only worst case is reported

5.8. Radiated Spurious Emissions

LIMIT

FCC CFR Title 47 Part 15 Subpart C Section 15.209 and Part 15 Subpart E Section 15.407

Frequency	Limit (dBuV/m)	Value
0.009 MHz ~0.49 MHz	2400/F(kHz) @300m	Quasi-peak
0.49 MHz ~ 1.705 MHz	24000/F(kHz) @30m	Quasi-peak
1.705 MHz ~30 MHz	30 @30m	Quasi-peak

Note: Limit dBuV/m @3m = Limit dBuV/m @300m + 40*log(300/3)= Limit dBuV/m @300m +80,

Limit dBuV/m @3m = Limit dBuV/m @30m +40*log(30/3)= Limit dBuV/m @30m + 40.

Unwanted emissions below 1GHz and Restricted band emissions above 1GHz		
Frequency	Limit (dBuV/m @3m)	Value
30MHz-88MHz	40.00	Quasi-peak
88MHz-216MHz	43.50	Quasi-peak
216MHz-960MHz	46.00	Quasi-peak
960MHz-1GHz	54.00	Quasi-peak
Above 1GHz	54.00	Average
	74.00	Peak

TEST CONFIGURATION

- 9KHz ~30MHz

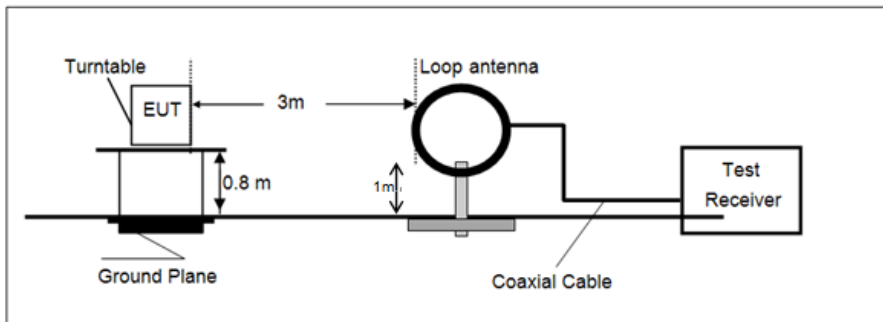

- 30MHz ~ 1GHz

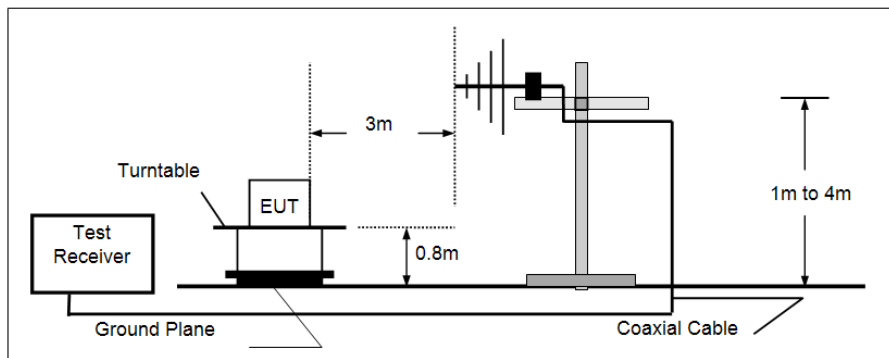

➤ Above 1GHz

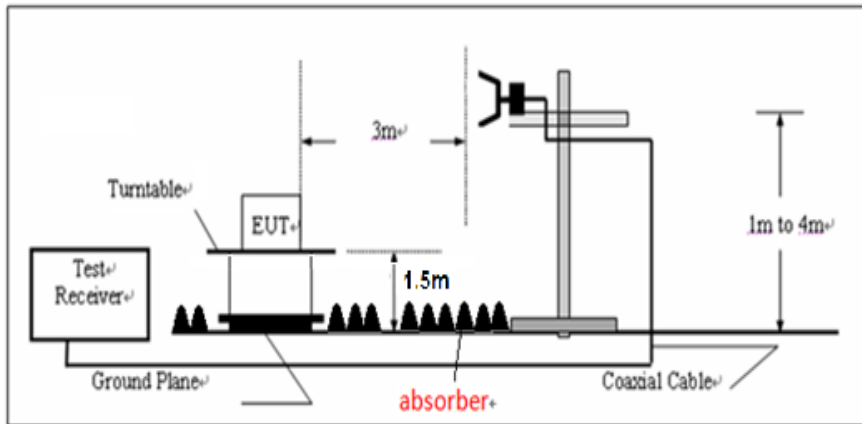
**TEST PROCEDURE**

1. The EUT was setup and tested according to ANSI C63.10:2013
2. The EUT is placed on a turn table which is 0.8 meter above ground for below 1 GHz, and 1.5 m for above 1 GHz. The turn table is rotated 360 degrees to determine the position of the maximum emission level.
3. The EUT was set 3 meters from the receiving antenna, which was mounted on the top of a variable height antenna tower.
4. For each suspected emission, the EUT was arranged to its worst case and then tune the Antenna tower (from 1 m to 4 m) and turntable (from 0 degree to 360 degrees) to find the maximum reading. A pre-amp and a high pass filter are used for the test in order to get better signal level to comply with the guidelines.
5. Set to the maximum power setting and enable the EUT transmit continuously.
6. Use the following spectrum analyzer settings
 - a) Span shall wide enough to fully capture the emission being measured;
 - b) Below 1 GHz:
RBW=120 kHz, VBW=300 kHz, Sweep=auto, Detector function=peak, Trace=max hold;
If the emission level of the EUT measured by the peak detector is 3 dB lower than the applicable limit, the peak emission level will be reported. Otherwise, the emission measurement will be repeated using the quasi-peak detector and reported.
 - c) From 1 GHz to 10th harmonic:
RBW=1MHz, VBW=3MHz Peak detector for Peak value.
RBW=1MHz, VBW=3MHz RMS detector for Average value.

TEST MODE:

Please refer to the clause 4.3

TEST RESULT

Passed Not Applicable

TEST DATA**FOR 9 kHz ~ 30 MHz**

The low frequency, which started from 9 kHz to 30MHz, was pre-scanned and the result which was 20dB lower than the limit line per 15.31(o) was not reported.

FOR 30MHz-1GHz

Polarization:

Horizontal

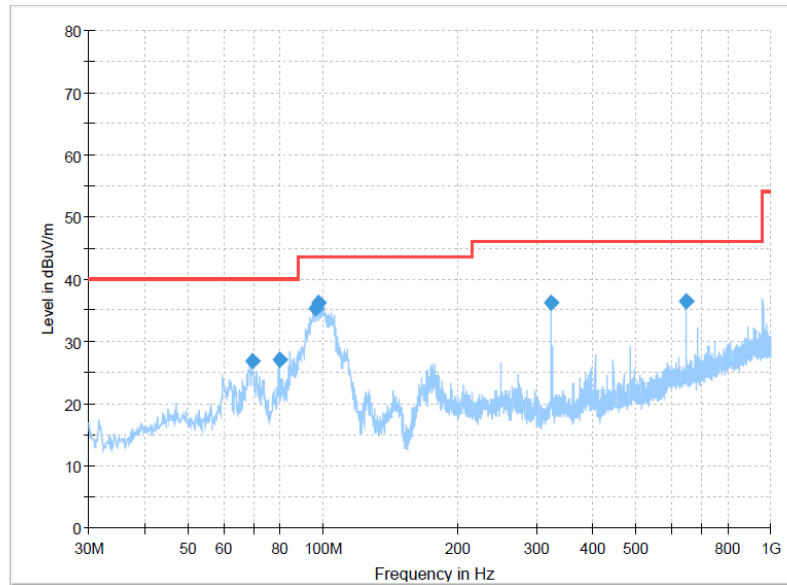

Final Result

Frequency (MHz)	MaxPeak (dBuV/m)	Limit (dBuV/m)	Margin (dB)	Height (cm)	Pol	Azimuth (deg)	Corr. (dB/m)
69.527500	26.84	40.00	13.16	300.0	H	309.0	-13.0
79.833750	26.95	40.00	13.05	300.0	H	309.0	-15.8
96.202500	35.36	43.50	8.14	300.0	H	255.0	-11.3
97.900000	36.23	43.50	7.27	300.0	H	255.0	-11.0
324.031250	36.23	46.00	9.77	300.0	H	318.0	-6.7
648.011250	36.36	46.00	9.64	100.0	H	355.0	1.5

Polarization:

Vertical

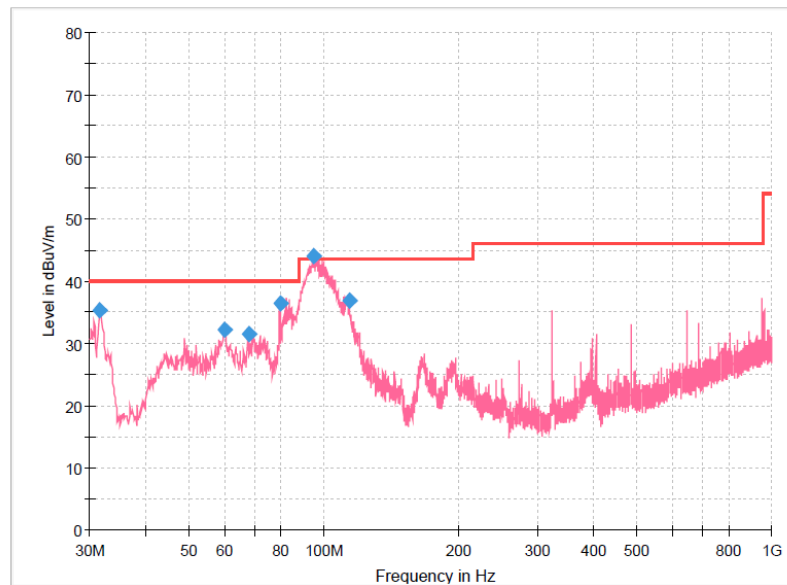

Final Result

Frequency (MHz)	MaxPeak (dBuV/m)	Limit (dBuV/m)	Margin (dB)	Height (cm)	Pol	Azimuth (deg)	Corr. (dB/m)
31.697500	35.29	40.00	4.71	100.0	V	311.0	-13.0
60.191250	32.21	40.00	7.79	100.0	V	347.0	-10.0
68.072500	31.60	40.00	8.40	100.0	V	257.0	-12.5
79.833750	36.48	40.00	3.52	100.0	V	320.0	-15.8
94.990000	44.02	43.50	-0.52	100.0	V	233.0	-11.4
113.905000	36.85	43.50	6.65	100.0	V	233.0	-11.7

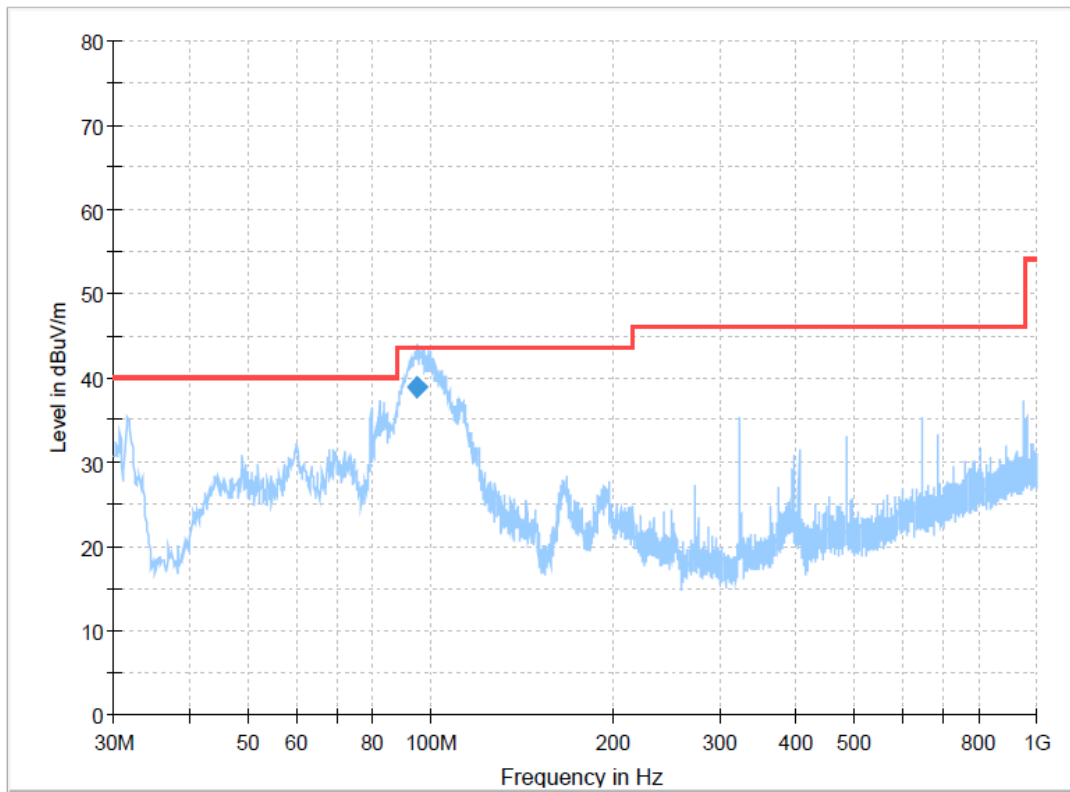

Final Result

Frequency (MHz)	QuasiPeak (dBuV/m)	Limit (dBuV/m)	Margin (dB)	Height (cm)	Pol	Azimuth (deg)	Corr. (dB/m)
95.250000	38.79	43.50	4.71	113.0	V	250.0	-11.3

Remark:

Transd=Cable lose+ Antenna factor- Pre-amplifier; Margin=Limit -Level

FOR Above 1GHz

U-NII-1		Worst mode: 802.11a					Test channel: CH _L			
Polarization:						Horizontal				
Mark	Frequency MHz	Reading dBuV/m	Antenna dB	Cable dB	Preamp dB	Level dBuV/m	Limit dBuV/m	Over limit	Remark	
1	2039.59	43.76	31.60	3.65	42.37	36.64	68.20	-31.56	Peak	
2	3200.50	40.64	34.39	4.59	41.87	37.75	68.20	-30.45	Peak	
3	7547.01	39.00	35.91	7.31	40.96	41.26	68.20	-26.94	Peak	
4	11603.96	36.24	38.31	8.99	40.20	43.34	68.20	-24.86	Peak	
Polarization:						Vertical				
Mark	Frequency MHz	Reading dBuV/m	Antenna dB	Cable dB	Preamp dB	Level dBuV/m	Limit dBuV/m	Over limit	Remark	
1	2050.00	42.92	31.60	3.66	42.37	35.81	68.20	-32.39	Peak	
2	3570.71	42.51	32.94	4.81	41.79	38.47	68.20	-29.73	Peak	
3	7413.73	39.75	36.00	7.23	40.99	41.99	68.20	-26.21	Peak	
4	10374.42	41.30	37.43	8.51	39.53	47.71	68.20	-20.49	Peak	

U-NII-1		Worst mode: 802.11a					Test channel: CH _M			
Polarization:						Horizontal				
Mark	Frequency MHz	Reading dBuV/m	Antenna dB	Cable dB	Preamp dB	Level dBuV/m	Limit dBuV/m	Over limit	Remark	
1	2050.00	42.97	31.60	3.66	42.37	35.86	68.20	-32.34	Peak	
2	3359.10	42.15	32.88	4.70	41.84	37.89	68.20	-30.31	Peak	
3	7921.00	38.56	35.80	7.50	40.45	41.41	68.20	-26.79	Peak	
4	10453.95	38.61	37.47	8.52	39.67	44.93	68.20	-23.27	Peak	
Polarization:						Vertical				
Mark	Frequency MHz	Reading dBuV/m	Antenna dB	Cable dB	Preamp dB	Level dBuV/m	Limit dBuV/m	Over limit	Remark	
1	2070.98	42.82	31.39	3.68	42.36	35.53	68.20	-32.67	Peak	
2	3943.39	41.62	33.27	5.12	41.59	38.42	68.20	-29.78	Peak	
3	6283.16	38.97	35.50	6.55	40.67	40.35	68.20	-27.85	Peak	
4	11633.54	36.72	38.34	9.01	40.22	43.85	68.20	-24.35	Peak	

U-NII-1		Worst mode: 802.11a					Test channel: CH _H			
Polarization:						Horizontal				
Mark	Frequency MHz	Reading dBuV/m	Antenna dB	Cable dB	Preamp dB	Level dBuV/m	Limit dBuV/m	Over limit	Remark	
1	2060.46	43.60	31.49	3.67	42.36	36.40	68.20	-31.80	Peak	
2	3579.82	41.81	32.96	4.83	41.79	37.81	68.20	-30.39	Peak	
3	8042.90	38.03	35.84	7.55	40.10	41.32	68.20	-26.88	Peak	
4	11545.04	36.07	38.25	8.98	40.15	43.15	68.20	-25.05	Peak	
Polarization:						Vertical				
Mark	Frequency MHz	Reading dBuV/m	Antenna dB	Cable dB	Preamp dB	Level dBuV/m	Limit dBuV/m	Over limit	Remark	
1	1385.18	43.59	28.67	3.05	42.63	32.68	68.20	-35.52	Peak	
2	2624.15	41.44	32.85	4.16	42.08	36.37	68.20	-31.83	Peak	
3	8002.06	39.97	35.80	7.53	40.22	43.08	68.20	-25.12	Peak	
4	11603.96	35.68	38.31	8.99	40.20	42.78	68.20	-25.42	Peak	

U-NII Band 2A			Worst mode: 802.11a				Test channel: CH _L			
Polarization:						Horizontal				
Mark	Frequency MHz	Reading dBuV/m	Antenna dB	Cable dB	Preamp dB	Level dBuV/m	Limit dBuV/m	Over limit	Remark	
1	2044.79	42.51	31.60	3.66	42.37	35.40	68.20	-32.80	Peak	
2	3208.66	40.73	34.16	4.59	41.87	37.61	68.20	-30.59	Peak	
3	7508.69	38.25	35.98	7.29	40.97	40.55	68.20	-27.65	Peak	
4	11574.46	36.49	38.28	8.98	40.17	43.58	68.20	-24.62	Peak	
Polarization:						Vertical				
Mark	Frequency MHz	Reading dBuV/m	Antenna dB	Cable dB	Preamp dB	Level dBuV/m	Limit dBuV/m	Over limit	Remark	
1	2060.46	42.47	31.49	3.67	42.36	35.27	68.20	-32.93	Peak	
2	3241.50	41.10	33.24	4.62	41.86	37.10	68.20	-31.10	Peak	
3	7981.72	40.39	35.80	7.53	40.28	43.44	68.20	-24.76	Peak	
4	12588.75	36.43	38.84	9.38	39.50	45.15	68.20	-23.05	Peak	

U-NII Band 2A			Worst mode: 802.11a				Test channel: CH _M			
Polarization:						Horizontal				
Mark	Frequency MHz	Reading dBuV/m	Antenna dB	Cable dB	Preamp dB	Level dBuV/m	Limit dBuV/m	Over limit	Remark	
1	3216.84	41.05	33.93	4.60	41.87	37.71	68.20	-30.49	Peak	
2	8002.06	38.52	35.80	7.53	40.22	41.63	68.20	-26.57	Peak	
3	9538.54	36.56	36.74	8.09	39.48	41.91	68.20	-26.29	Peak	
4	11603.96	36.61	38.31	8.99	40.20	43.71	68.20	-24.49	Peak	
Polarization:						Vertical				
Mark	Frequency MHz	Reading dBuV/m	Antenna dB	Cable dB	Preamp dB	Level dBuV/m	Limit dBuV/m	Over limit	Remark	
1	2034.41	43.01	31.60	3.65	42.37	35.89	68.20	-32.31	Peak	
2	3192.37	41.55	34.19	4.58	41.88	38.44	68.20	-29.76	Peak	
3	8002.06	40.41	35.80	7.53	40.22	43.52	68.20	-24.68	Peak	
4	10669.02	37.44	37.60	8.55	40.38	43.21	68.20	-24.99	Peak	

U-NII Band 2A			Worst mode: 802.11a				Test channel: CH _H			
Polarization:						Horizontal				
Mark	Frequency MHz	Reading dBuV/m	Antenna dB	Cable dB	Preamp dB	Level dBuV/m	Limit dBuV/m	Over limit	Remark	
1	3208.66	41.46	34.16	4.59	41.87	38.34	68.20	-29.86	Peak	
2	6299.18	39.37	35.50	6.58	40.67	40.78	68.20	-27.42	Peak	
3	8083.96	38.48	35.88	7.57	39.99	41.94	68.20	-26.26	Peak	
4	11994.38	37.03	38.69	9.30	40.47	44.55	68.20	-23.65	Peak	
Polarization:						Vertical				
Mark	Frequency MHz	Reading dBuV/m	Antenna dB	Cable dB	Preamp dB	Level dBuV/m	Limit dBuV/m	Over limit	Remark	
1	3266.35	42.04	32.93	4.63	41.86	37.74	68.20	-30.46	Peak	
2	7981.72	39.91	35.80	7.53	40.28	42.96	68.20	-25.24	Peak	
3	10480.59	37.15	37.49	8.52	39.76	43.40	68.20	-24.80	Peak	
4	12620.84	35.87	38.85	9.39	39.44	44.67	68.20	-23.53	Peak	