



Antenna Test Report

Heyuan Xunwei Communication Technology Co., Ltd

RF: Chenchuanming

Date: 2023.07.14

Office address: Zone M, 8/F, Building 1, Baisha Xinxing Industrial Park, No. 3011,
Shahe West Road, Nanshan District, Shenzhen

Contents:

Test equipment

Modal information

Matching circuit

Active performance

test data

Test equipment

Wireless communications test set: CMW500

Network Analyzer: Agilent 5071B

Anechoic Chamber : SATIMO SG24



Antenna information

Customer	Boat of wealth
Antenna model	FPC
Antenna type	PIFA
Antenna band	GSM900/1800/850/1900 WCDMA-B1/B2/B4/B5/B8 LTE-B1/2/3/4/5/7/8/12/13/17/28/66/38/40/41

frequency range (MHz)	703–960	1710–2170	2300–2690
VSWR	<3.5	<3.5	<3.5

Matching circuit (No modification)

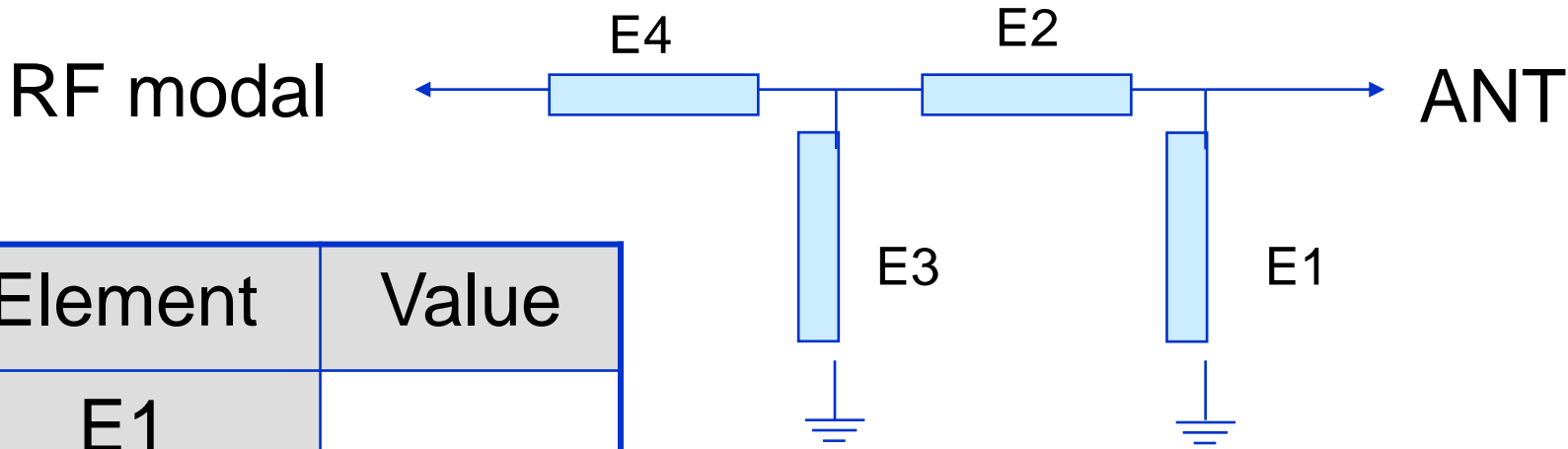

Element	Value
E1	
E2	
E3	
E4	

4G Diversity antenna(PIFA)

GPS/WIFI/BT (PIFA)

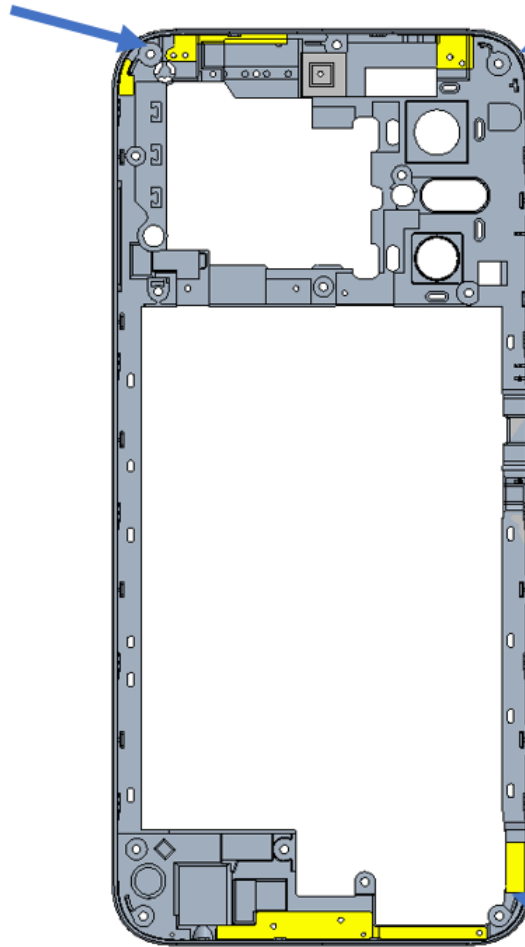

2G/3G/4G Main Antenna(PIFA)

LTE Antenna gain

All of Implementation antenna

Main antenna(Antenna Label:A):

LTE B5/B7/B8/B12/B13/B17/B28/B38/B41 RX&TX

WCDMA B5/B8 RX&TX

GSM B5/B8 RX&TX

DIV antenna(Antenna Label:B):

LTE B1/B2/B3/B4/B40/B66 RX&TX

LTE B7/B38/B41 RX

WCDMA B1/B2/B3/B4 RX&TX

GSM B2/B3 RX&TX

WiFi/BT 2.4~2.5G/5.1~5.8G/2412MHz~2472MHz&/5100MHz~5800MHz

GPS: 1575.42 MHz

Antenna Max. Peak Gain:

EGSM900 (880-960MHz) :-1.22dBi

GSM850 (824-894MHz) :-0.98dBi

DCS1800 (1710-1880MHz) :-0.64dBi

PCS1900 (1850-1990MHz) :-0.66dBi

WCDMA-B1 (1920-2170MHz) :-0.82dBi

WCDMA-B2 (1850-1990MHz) :-0.64dBi

WCDMA-B4 (1710-2155MHz) :-0.68dBi

WCDMA-B5 (824-894MHz) :-0.97dBi

WCDMA-B8 (880-960MHz) :-1.22dBi

LTE-B1 (1920-2170MHz) :-0.82dBi

LTE-B2 (1850-1990MHz) :-0.64dBi

LTE-B3 (1710-1880MHz) :-0.62dBi

LTE-B4 (1710-2155MHz) :-0.69dBi

LTE-B5 (824-894MHz) :-0.98dBi

LTE-B7 (2500-2690MHz) :-1.22dBi

LTE-B8 (880-960MHz) :-1.22dBi

LTE-B12 (699-746MHz) :-1.35dBi

LTE-B13 (777-756MHz) :-1.11dBi

LTE-B17 (880-746MHz) :-1.4dBi

LTE-B28 (703-803MHz) :-1.36dBi

LTE-B38 (2570-2620MHz) :-0.95dBi

LTE-B40 (2300-2400MHz) :-1.72dBi

LTE-B41 (2496-2690MHz) :-1.24dBi

LTE-B66 (1710-2200MHz) :-0.72dBi

WIFI(5G) (5180-5850MHz) :-2.02dBi

WIFI(2.4G) (2412-2472MHz) :-1.35dBi

BT (2400-2500MHz) :-1.35dBi

GPS (1570-1620MHz) :-1.42dBi

Antenna dimension drawing

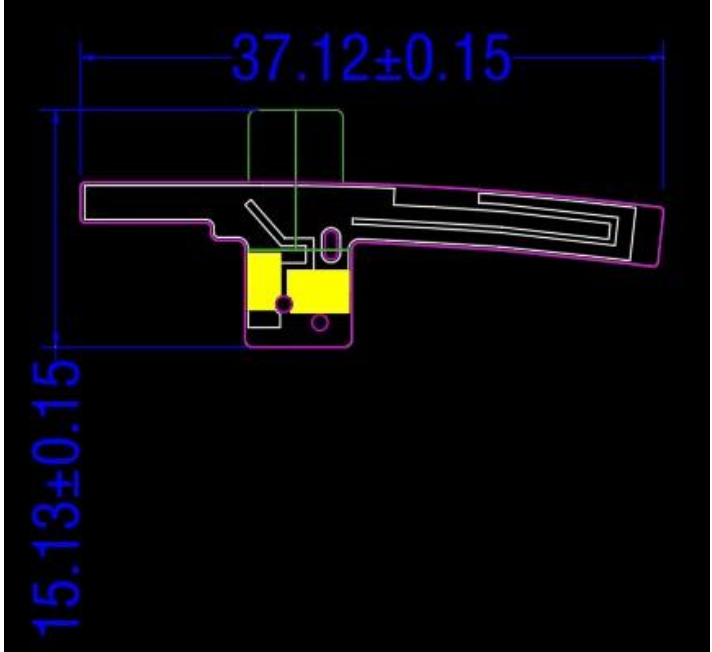
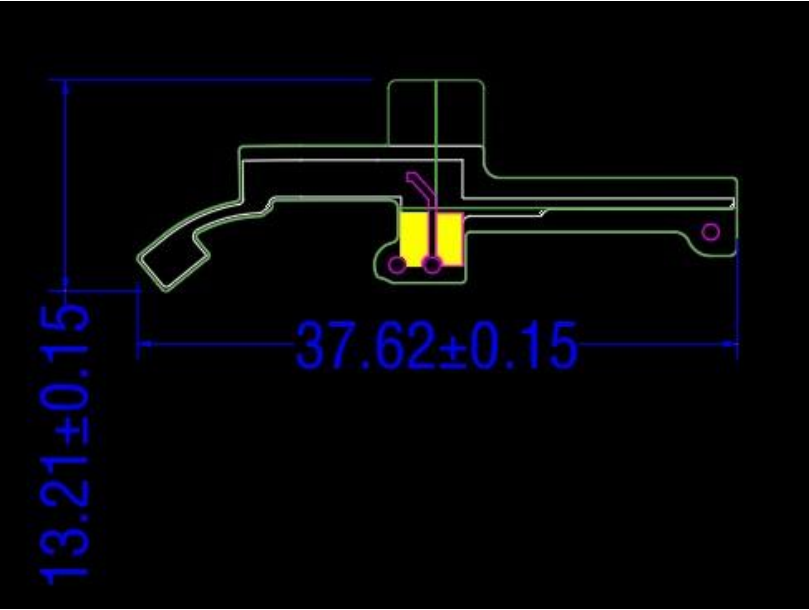
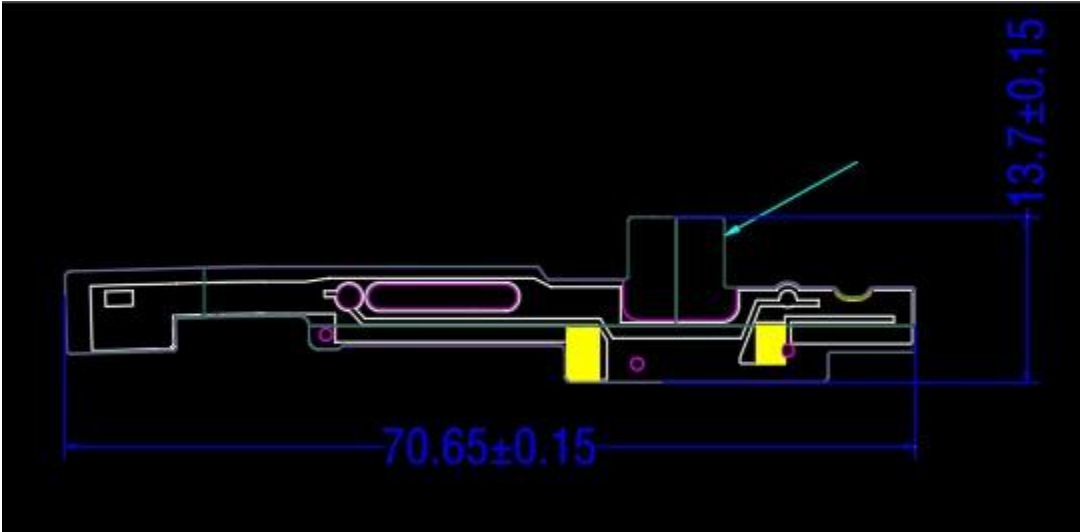

2.3 Main antenna Peak Gain(791~960M)

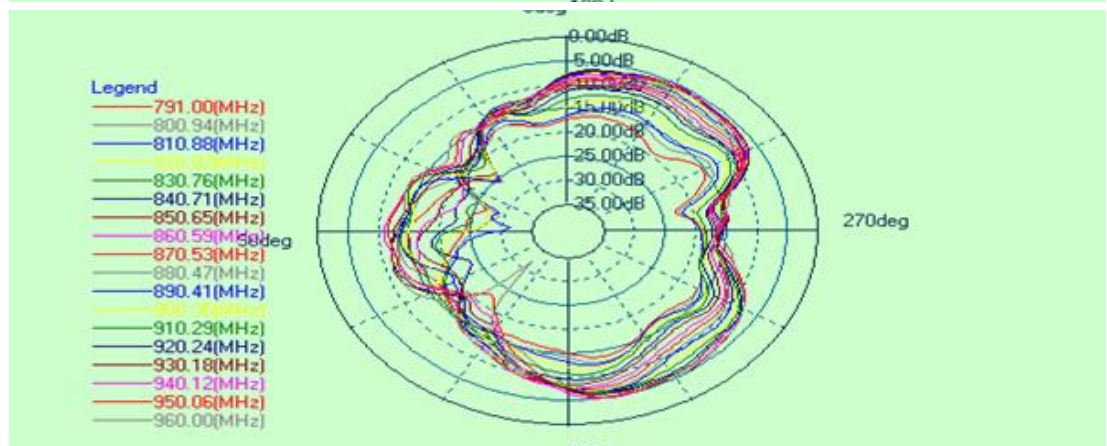
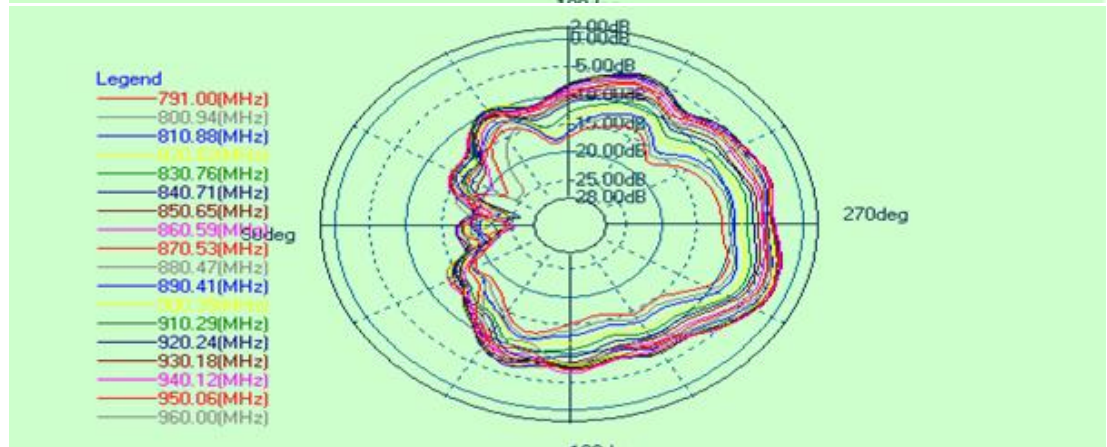
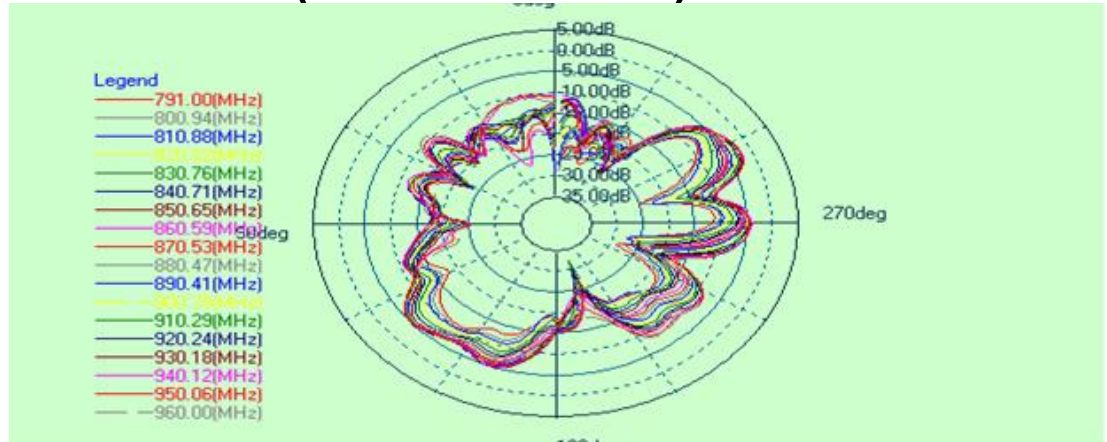
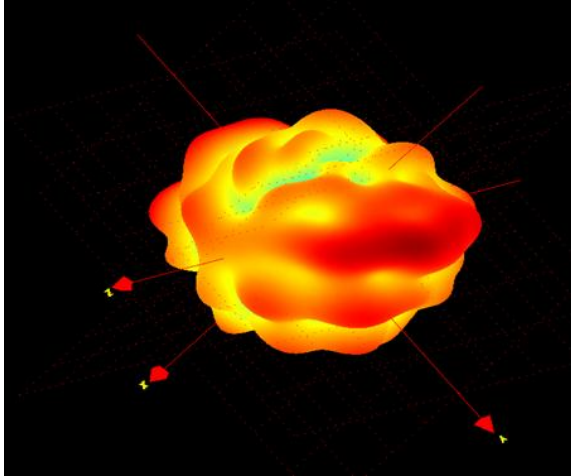

Freq (MHZ)	Effi (%)
720	24.8
824	26.7
960	27.4

2.3 Main antenna Peak Gain(2490~2690M)

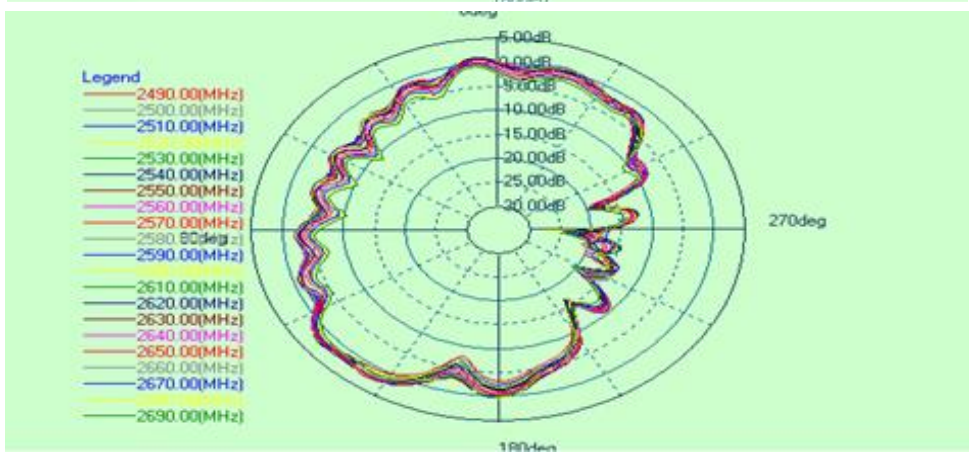
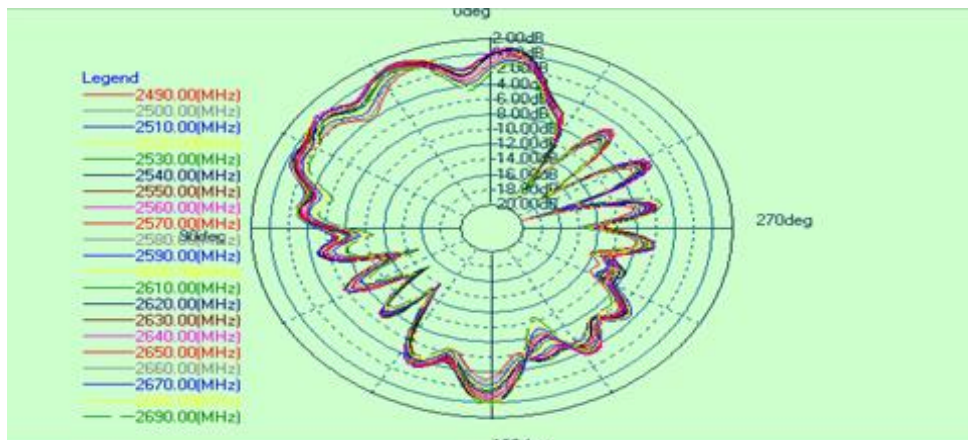
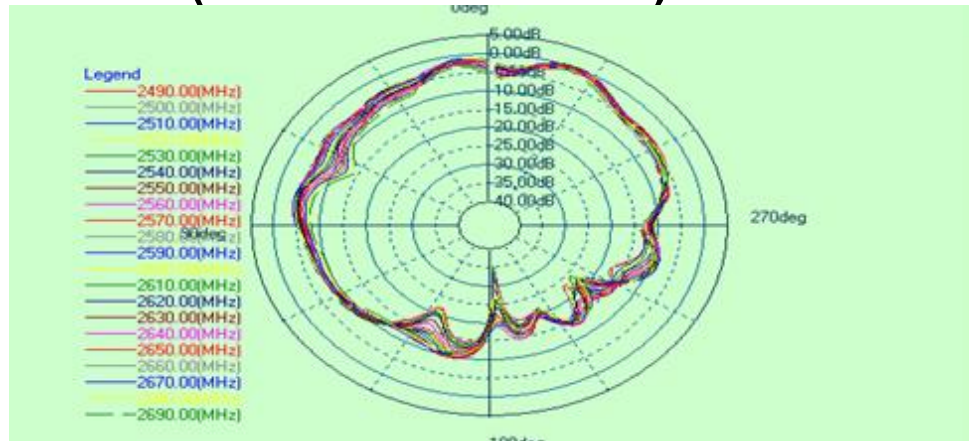
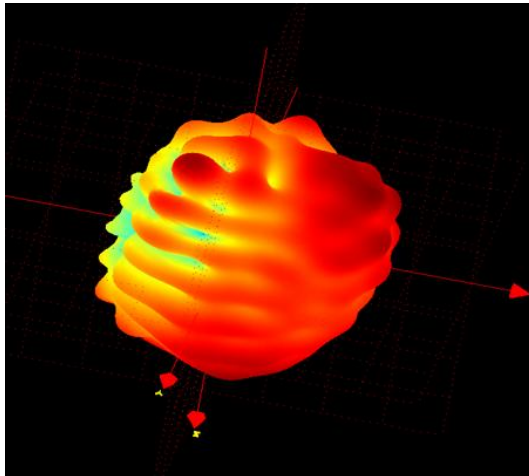

Freq (MHZ)	Effi (%)
2590	38.7

2.3 DIV antenna Peak Gain(1710~2170M)

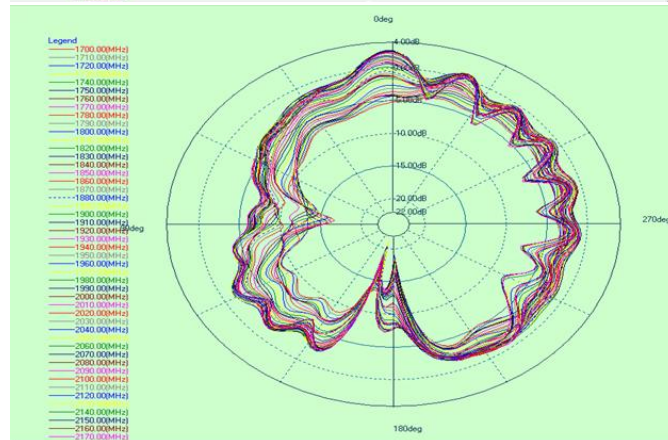
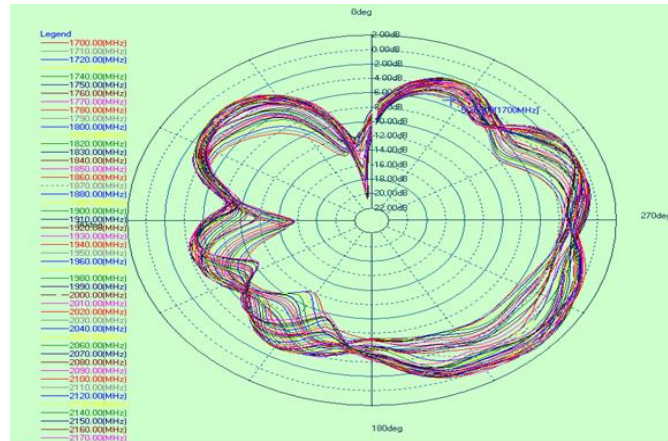
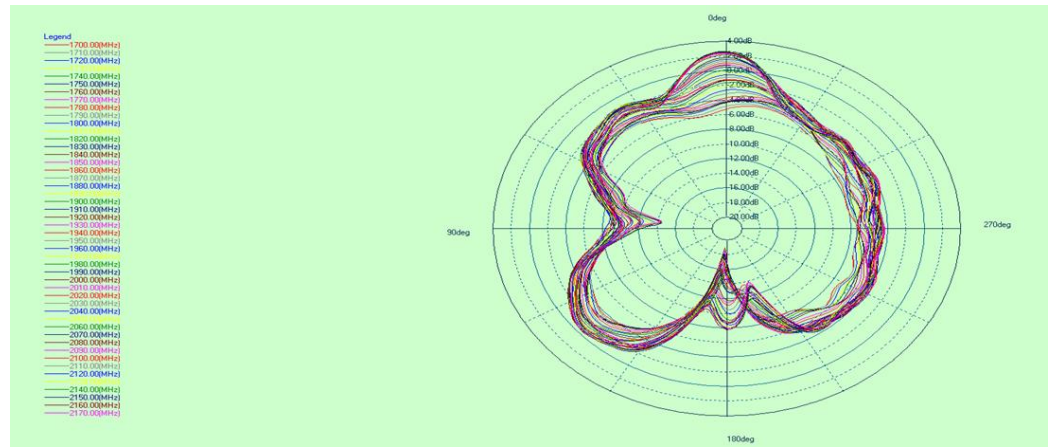
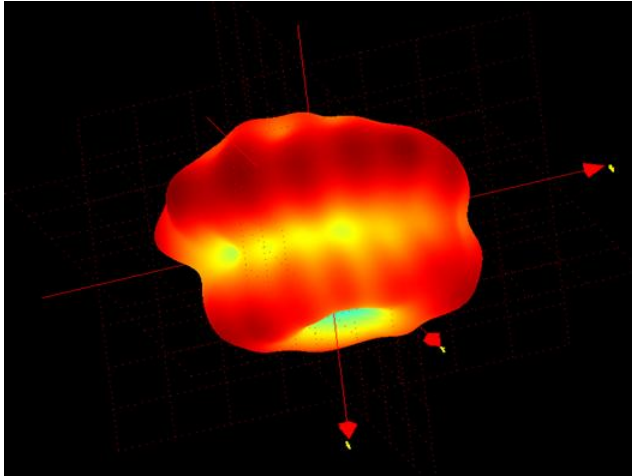

Freq (MHZ)	Effi (%)
1880	34.6
1990	36.8
2110	35.4

2.3 G/W/B antenna Peak Gain(1575M)

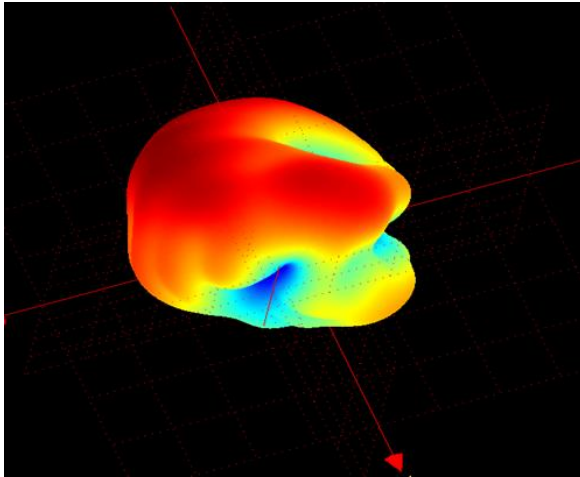

Freq (MHZ)	Effi (%)
1575	36.7

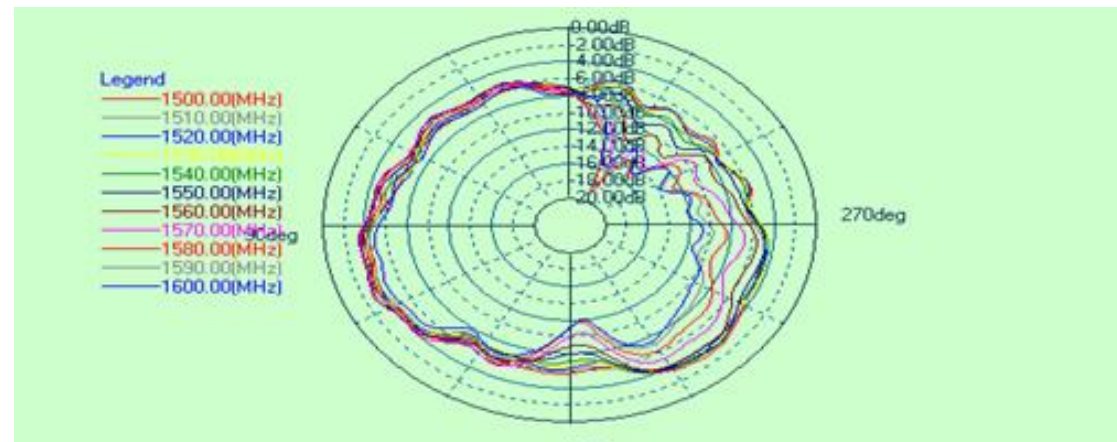
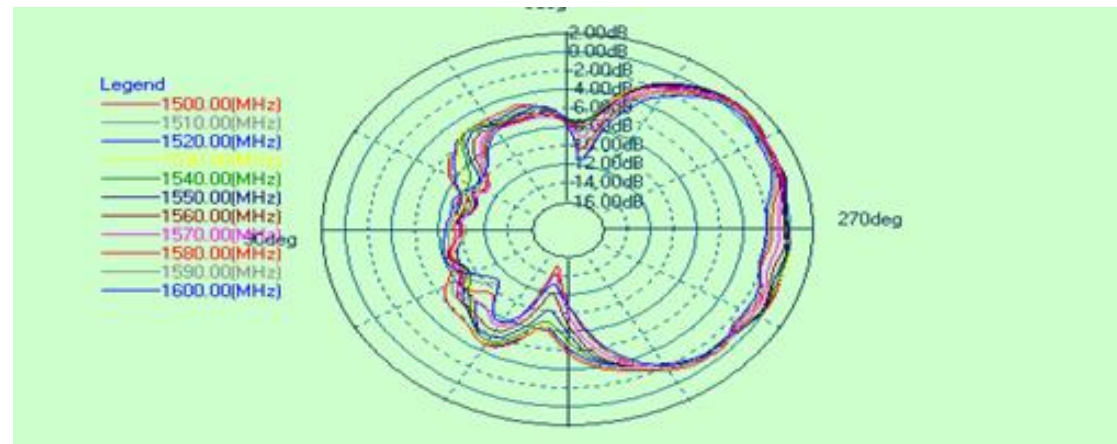
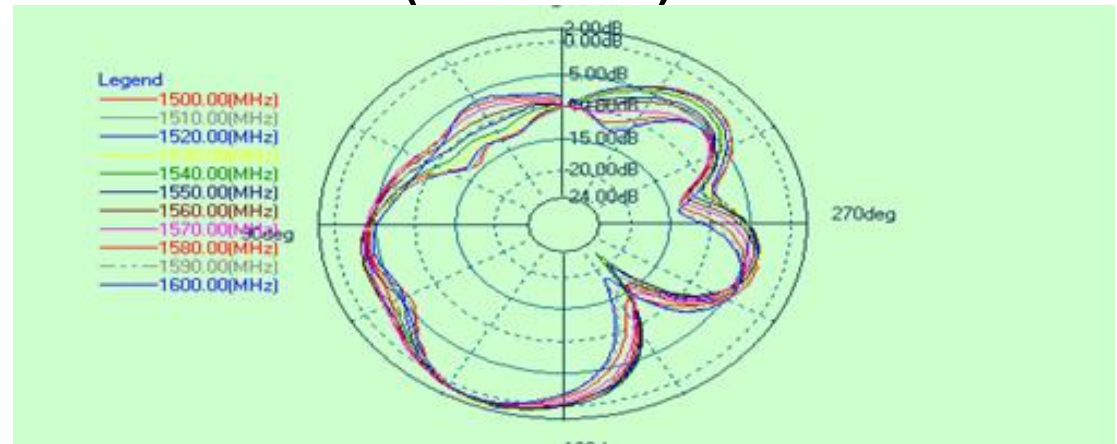

2.3 G/W/B antenna Peak Gain(2400-2500M)

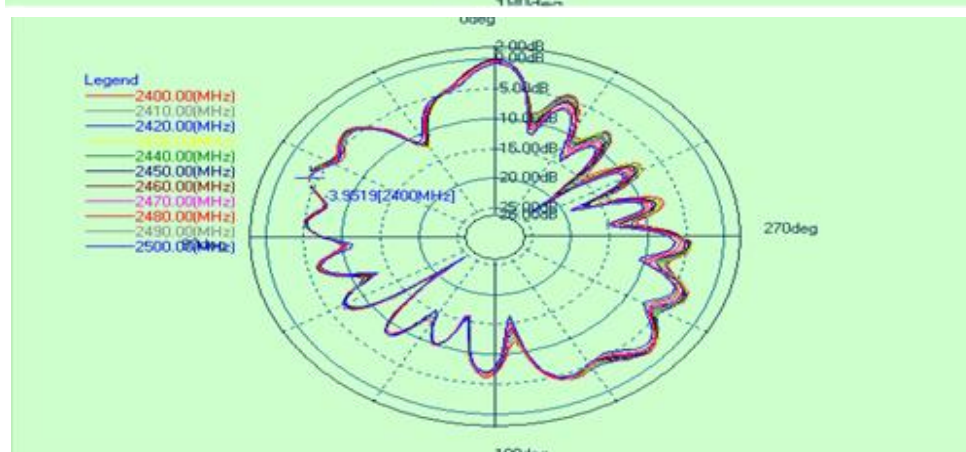
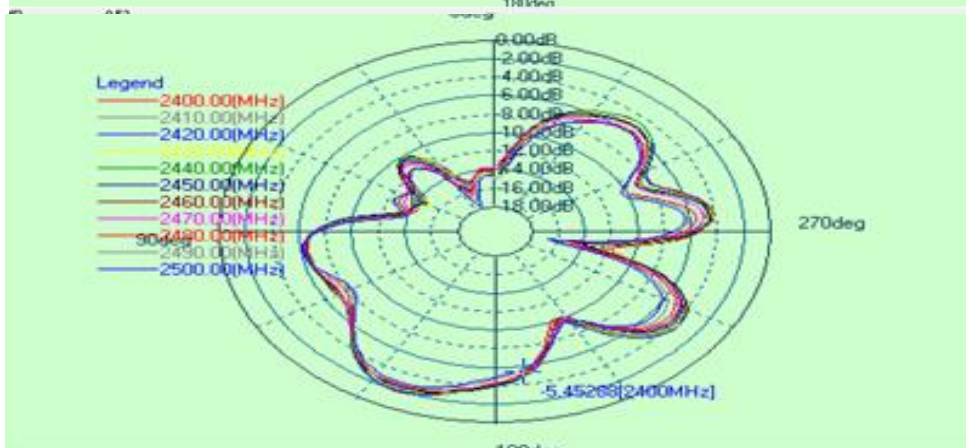
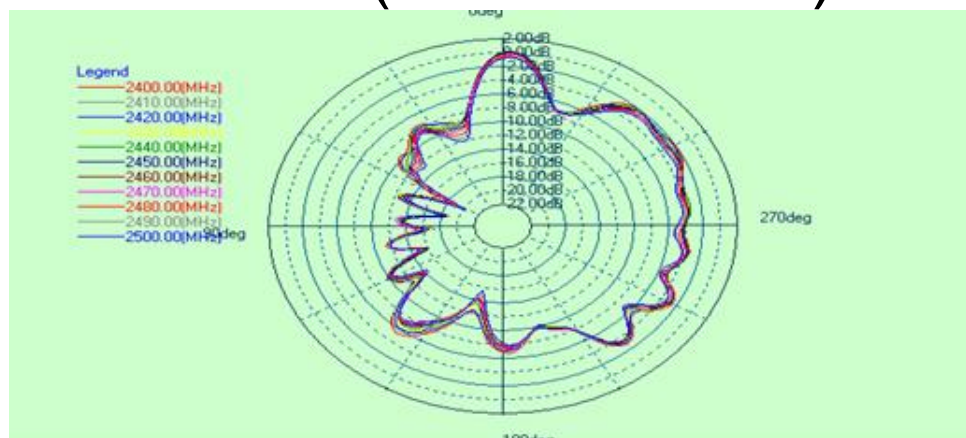
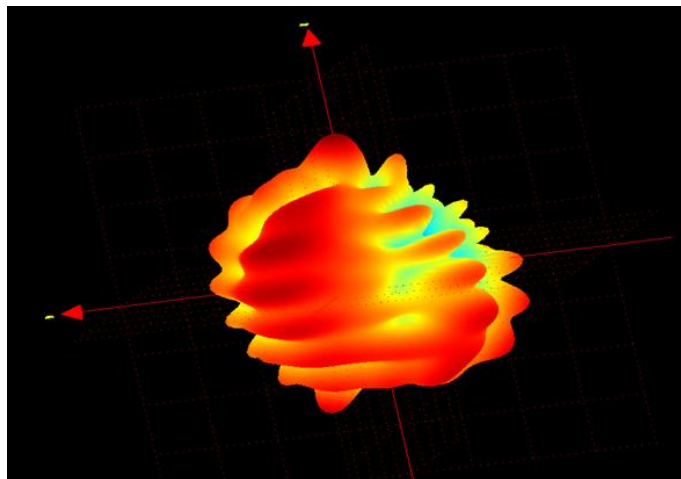

Freq (MHZ)	Effi (%)
2450	34.7

2.3 G/W/B antenna Peak Gain(5100-5800M)

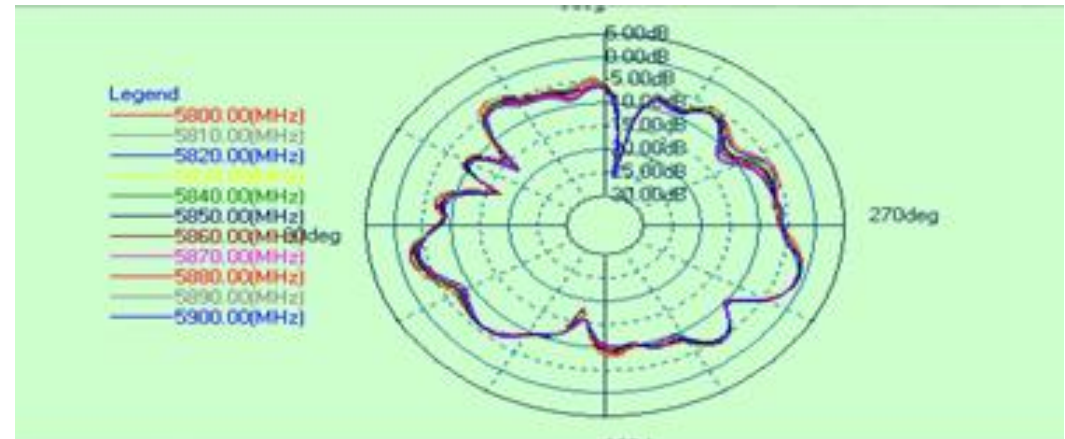
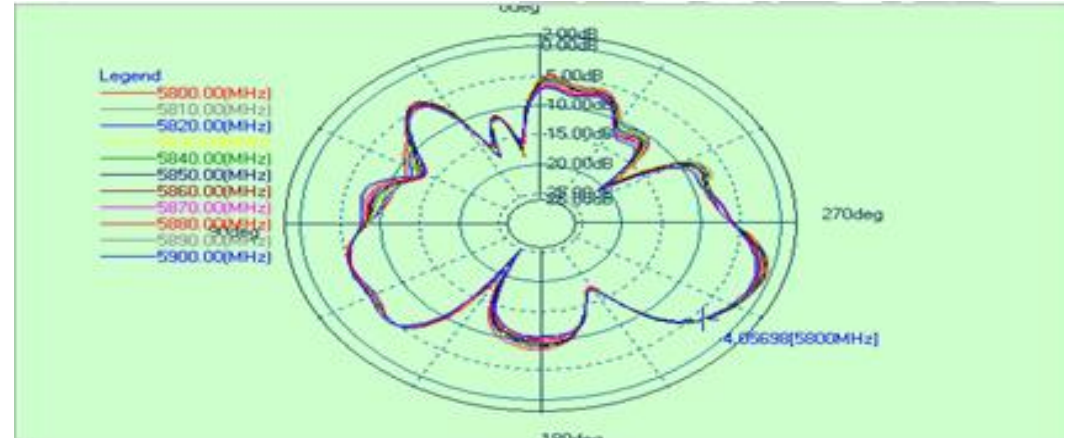
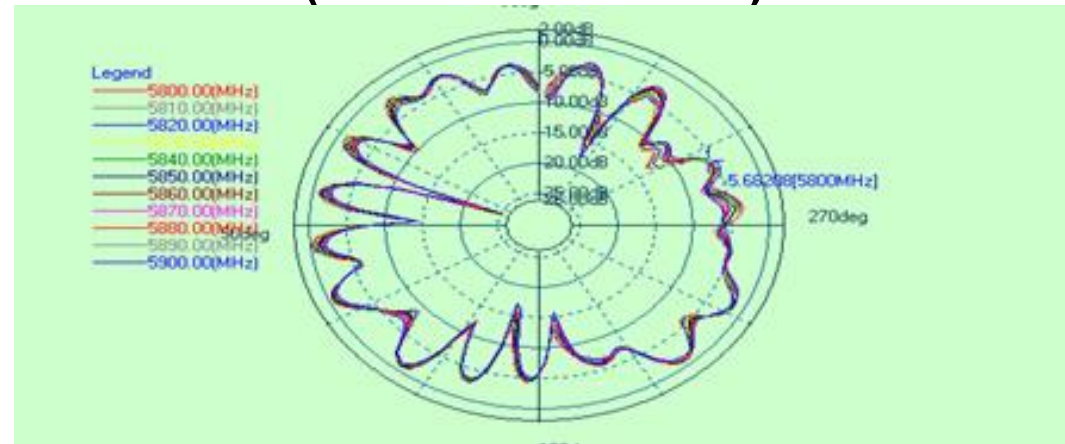
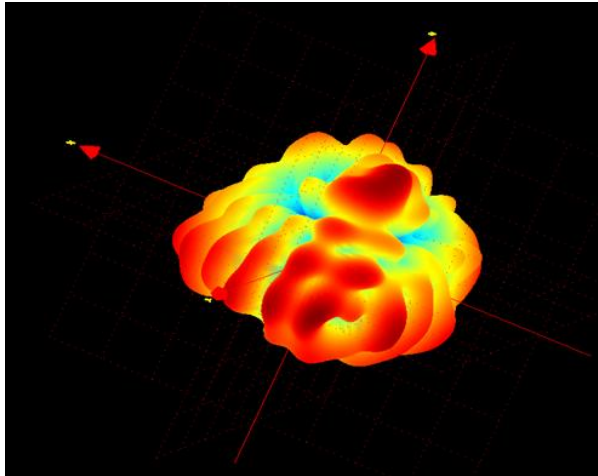

Freq (MHZ)	Effi (%)
5525	35.2