

# FCC SAR EVALUATION REPORT

**In accordance with the requirements of  
FCC 47 CFR Part 2(2.1093), ANSI/IEEE C95.1-1992 and  
IEEE Std 1528-2013**

**Product Name :** Mobile Phone

**Brand Name :** ACER

**Model Name :** SOSPIRO-A60L

**Family Model :** SOSPIRO-A60L-G

**Report No. :** S23071202208001

**FCC ID :** 2AZYA-A60L

**Prepared for**

Senwa Global International, S.A. de C.V.

Carretera Mexico-Toluca No. 5324 PB, Colonia El Yaqui Del. Cuajimalpa de Morelos,  
C.P. 05320 Ciudad de Mexico, Mexico

**Prepared by**

Shenzhen NTEK Testing Technology Co., Ltd.

1&5/F, Building C, 1&2/F, Building E, Fenda Science Park, Sanwei Community,  
Hangcheng Street, Baoan District, Shenzhen ,Guangdong, China

Tel. 400-800-6106, 0755-2320 0050, 0755-2320 0090

Website: <http://www.ntek.org.cn>

## TEST RESULT CERTIFICATION

**Applicant's name** ..... Senwa Global International, S.A. de C.V.  
**Address**..... Carretera Mexico-Toluca No. 5324 PB, Colonia El Yaqui Del. Cuajimalpa de Morelos, C.P. 05320 Ciudad de Mexico, Mexico

**Manufacturer's Name** . Senwa Mobile China Ltd  
**Address**..... A611, Languang technology building, No. 27, Gaoxin North 6th Road, songpingshan community, Xili street, Nanshan District, Shenzhen, Guangdong Province

**Product description**

Product name ..... Mobile Phone  
 Brand Name ..... ACER  
 Model and/or type reference ..... SOSPIRO-A60L  
 Family Model ..... SOSPIRO-A60L-G  
 FCC 47 CFR Part 2(2.1093)  
 ANSI/IEEE C95.1-1992

**Standards** ..... IEEE Std 1528-2013  
 Published RF exposure KDB procedures

This device described above has been tested by Shenzhen NTEK. In accordance with the measurement methods and procedures specified in IEEE Std 1528-2013 and KDB 865664 D01. Testing has shown that this device is capable of compliance with localized specific absorption rate (SAR) specified in FCC 47 CFR Part 2(2.1093) and ANSI/IEEE C95.1-1992. The test results in this report apply only to the tested sample of the stated device/equipment. Other similar device/equipment will not necessarily produce the same results due to production tolerance and measurement uncertainties.

This report shall not be reproduced except in full, without the written approval of Shenzhen NTEK, this document may be altered or revised by Shenzhen NTEK, personal only, and shall be noted in the revision of the document.

Test Sample Number ..... S230712022009

**Date of Test**

Date (s) of performance of tests... Jul. 14, 2023 ~ Jul. 27, 2023

Date of Issue ..... Aug. 09, 2023

Test Result ..... **Pass**

Prepared By : Jack Li  
 (Test Engineer) :  
 (Jack Li)

Approved By : Alex  
 (Lab Manager) :  
 (Alex Li)

※ ※ **Revision History** ※ ※

REV.	DESCRIPTION	ISSUED DATE	REMARK
Rev.1.0	Initial Test Report Release	Aug. 09, 2023	Jack Li

## TABLE OF CONTENTS

1. General Information .....	6
1.1. RF exposure limits.....	6
1.2. Statement of Compliance .....	7
1.3. EUT Description .....	7
1.4. Test specification(s) .....	9
1.5. Ambient Condition.....	9
2. SAR Measurement System .....	10
2.1. SATIMO SAR Measurement Set-up Diagram .....	10
2.2. Robot .....	11
2.3. E-Field Probe.....	12
2.3.1. E-Field Probe Calibration .....	12
2.4. SAM phantoms .....	13
2.4.1. Technical Data .....	14
2.5. Device Holder .....	15
2.6. Test Equipment List .....	16
3. SAR Measurement Procedures .....	19
3.1. Power Reference .....	19
3.2. Area scan & Zoom scan.....	19
3.3. Description of interpolation/extrapolation scheme .....	21
3.4. Volumetric Scan .....	21
3.5. Power Drift .....	21
4. System Verification Procedure .....	22
4.1. Tissue Verification .....	22
4.1.1. Tissue Dielectric Parameter Check Results .....	23
4.2. System Verification Procedure .....	24
4.2.1. System Verification Results.....	25
5. SAR Measurement variability and uncertainty .....	26
5.1. SAR measurement variability.....	26
5.2. SAR measurement uncertainty .....	26
6. RF Exposure Positions.....	27
6.1. Ear and handset reference point .....	27
6.2. Definition of the cheek position .....	27
6.3. Definition of the tilt position .....	29
6.4. Body Worn Accessory .....	29
6.5. Wireless Router Devices .....	30
7. RF Output Power .....	31
7.1. GSM Conducted Power .....	31
7.2. WCDMA Conducted Power .....	31
7.3. LTE Conducted Power .....	33

7.4. WLAN & Bluetooth Output Power .....	46
8. Antenna Location.....	47
9. Stand-alone SAR test exclusion.....	47
10. SAR Results .....	48
10.1. SAR measurement Result.....	48
10.1.1. SAR measurement Result of GSM850.....	48
10.1.2. SAR measurement Result of GSM1900.....	49
10.1.3. SAR measurement Result of WCDMA Band 2.....	50
10.1.4. SAR measurement Result of WCDMA Band 4.....	51
10.1.5. SAR measurement Result of WCDMA Band 5.....	52
10.1.6. SAR measurement Result of LTE Band 2 .....	53
10.1.7. SAR measurement Result of LTE Band 4 .....	55
10.1.8. SAR measurement Result of LTE Band 5 .....	57
10.1.9. SAR measurement Result of LTE Band 7 .....	59
10.1.10. SAR measurement Result of LTE Band 13 .....	61
10.1.11. SAR measurement Result of LTE Band 66 .....	63
10.1.12. SAR measurement Result of WLAN 2.4G .....	65
10.2. Simultaneous Transmission Analysis.....	66
11. Appendix A. Photo documentation .....	67
12. Appendix B. System Check Plots.....	68
13. Appendix C. Plots of High SAR Measurement.....	81
14. Appendix D. Calibration Certificate .....	130

## 1. General Information

### 1.1. RF exposure limits

(A).Limits for Occupational/Controlled Exposure (W/kg)

Whole-Body	Partial-Body	Hands, Wrists, Feet and Ankles
0.4	8.0	20.0

(B).Limits for General Population/Uncontrolled Exposure (W/kg)

Whole-Body	Partial-Body	Hands, Wrists, Feet and Ankles
0.08	1.6	4.0

NOTE: **Whole-Body SAR** is averaged over the entire body, **partial-body SAR** is averaged over any 1 gram of tissue defined as a tissue volume in the shape of a cube. **SAR for hands, wrists, feet and ankles** is averaged over any 10 grams of tissue defined as a tissue volume in the shape of a cube.

#### **Occupational/Controlled Environments:**

Are defined as locations where there is exposure that may be incurred by people who are aware of the potential for exposure, (i.e. as a result of employment or occupation).

#### **General Population/Uncontrolled Environments:**

Are defined as locations where there is the exposure of individuals who have no knowledge or control of their exposure.

#### NOTE

Localized Head, Neck and Trunk LIMIT

1.6 W/kg

APPLIED TO THIS EUT

## 1.2. Statement of Compliance

The maximum results of Specific Absorption Rate (SAR) found during testing for SOSPIRO-A60L are as follows.

RF Exposure Conditions		Equipment Class -Highest Reported SAR (W/kg)			
		PCE	DTS	NII	DSS
1-g Head		0.699	0.416	N/A	0.167
1-g Body-Worn (Separation distance of 10mm)		1.190	0.240	N/A	0.083
1-g Hotspot (Separation distance of 10mm)		1.190	0.240	N/A	0.083
Max Simultaneous Tx	Head	1.115	1.115	N/A	0.866
	Body-Worn	1.430	1.430	N/A	1.273
	Hotspot	1.430	1.430	N/A	1.273

Note: The Max Simultaneous Tx is calculated based on the same configuration and test position.

This device is in compliance with Specific Absorption Rate (SAR) for general population/uncontrolled exposure limits (1.6 W/kg) specified in FCC 47 CFR Part 2(2.1093) and ANSI/IEEE C95.1-1992, and had been tested in accordance with the measurement methods and procedures specified in IEEE Std 1528-2013 & KDB 865664 D01.

## 1.3. EUT Description

Device Information	
Product Name	Mobile Phone
Brand Name	ACER
Model Name	SOSPIRO-A60L
Family Model	SOSPIRO-A60L-G
Model Difference	All models are the same circuit and RF module, except the model name and colour.
FCC ID	2AZYA-A60L
Device Phase	Identical Prototype
Exposure Category	General population / Uncontrolled environment
Antenna Type	PIFA Antenna
Battery Information	DC 3.8V, 3000mAh
HW Version	sp9832e_1h10_go
SW Version	ACER_A60L_TELCEL_Ver01
Device Operating Configurations	
Supporting Mode(s)	GSM 850/1900, WCDMA Band 2/4/5, LTE Band 2/4/5/7/13/66, WLAN 2.4G, Bluetooth
Test Modulation	GSM(GMSK/8PSK), WCDMA(QPSK), LTE(QPSK/16QAM),

	WLAN(DSSS/OFDM), Bluetooth(GFSK, π/4-DQPSK, 8DPSK),		
Device Class	B		
Operating Frequency Range(s)	Band	Tx (MHz)	Rx (MHz)
	GSM 850	824-849	869-894
	GSM 1900	1850-1910	1930-1990
	WCDMA Band 2	1850-1910	1930-1990
	WCDMA Band 4	1710-1755	2110-2155
	WCDMA Band 5	824-849	869-894
	LTE Band 2	1850-1910	1930-1990
	LTE Band 4	1710-1755	2110-2155
	LTE Band 5	824-849	869-894
	LTE Band 7	2500-2570	2620-2690
	LTE Band 13	777-787	746-756
	LTE Band 66	1710-1780	2110-2200
	WLAN 2.4G	2412-2462	
	Bluetooth	2402-2480	
	GPRS Multislot Class(12)	Max Number of Timeslots in Uplink	
Max Number of Timeslots in Downlink		4	
Max Total Timeslot		5	
EGPRS Multislot Class(12)	Max Number of Timeslots in Uplink		4
	Max Number of Timeslots in Downlink		4
	Max Total Timeslot		5
Power Class	4, tested with power level 5(GSM 850)		
	1, tested with power level 0(GSM 1900)		
	3, tested with power control "all 1"(WCDMA Band 2)		
	3, tested with power control "all 1"(WCDMA Band 4)		
	3, tested with power control "all 1"(WCDMA Band 5)		
	3, tested with power control all Max.(LTE Band 2)		
	3, tested with power control all Max.(LTE Band 4)		
	3, tested with power control all Max.(LTE Band 5)		
	3, tested with power control all Max.(LTE Band 7)		
	3, tested with power control all Max.(LTE Band 13)		
	3, tested with power control all Max.(LTE Band 66)		



**1.4. Test specification(s)**

FCC 47 CFR Part 2(2.1093)
ANSI/IEEE C95.1-1992
IEEE Std 1528-2013
KDB 865664 D01 SAR measurement 100 MHz to 6 GHz
KDB 865664 D02 RF Exposure Reporting
KDB 447498 D01 General RF Exposure Guidance
KDB 248227 D01 802.11 Wi-Fi SAR
KDB 941225 D01 3G SAR Procedures
KDB 941225 D05 SAR for LTE Devices
KDB 941225 D06 Hotspot SAR
KDB 648474 D04 Handset SAR

**1.5. Ambient Condition**

Ambient temperature	20°C – 24°C
Relative Humidity	30% – 70%

## 2. SAR Measurement System

### 2.1. SATIMO SAR Measurement Set-up Diagram

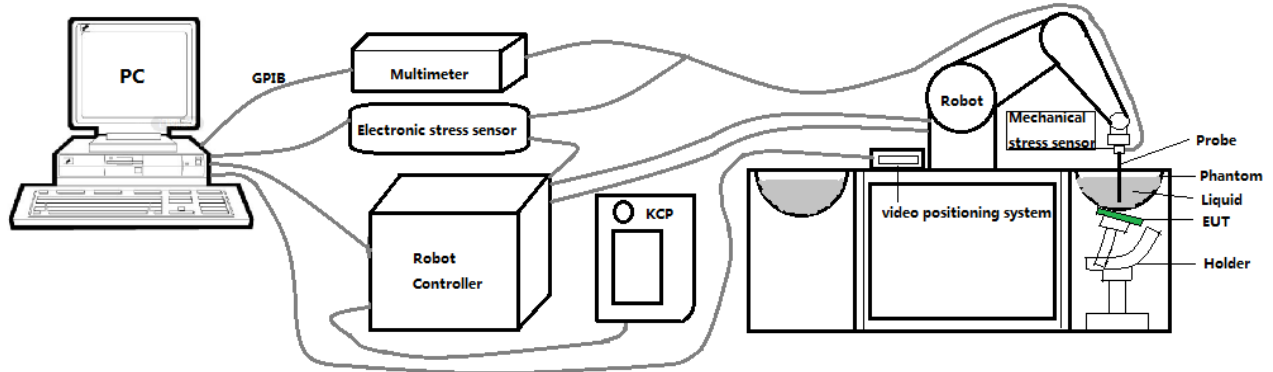

These measurements were performed with the automated near-field scanning system OPENSAR from SATIMO. The system is based on a high precision robot (working range: 901 mm), which positions the probes with a positional repeatability of better than  $\pm 0.03$  mm. The SAR measurements were conducted with dosimetric probe (manufactured by SATIMO), designed in the classical triangular configuration and optimized for dosimetric evaluation.

The first step of the field measurement is the evaluation of the voltages induced on the probe by the device under test. Probe diode detectors are nonlinear. Below the diode compression point, the output voltage is proportional to the square of the applied E-field; above the diode compression point, it is linear to the applied E-field. The compression point depends on the diode, and a calibration procedure is necessary for each sensor of the probe.

The Keithley multimeter reads the voltage of each sensor and send these three values to the PC. The corresponding E field value is calculated using the probe calibration factors, which are stored in the working directory. This evaluation includes linearization of the diode characteristics. The field calculation is done separately for each sensor. Each component of the E field is displayed on the "Dipole Area Scan Interface" and the total E field is displayed on the "3D Interface"

## 2.2. Robot

The SATIMO SAR system uses the high precision robots from KUKA. For the 6-axis controller system, the robot controller version (KUKA) from KUKA is used. The KUKA robot series have many features that are important for our application:



- High precision (repeatability  $\pm 0.03$  mm)
- High reliability (industrial design)
- Jerk-free straight movements
- Low ELF interference (the closed metallic construction shields against motor control fields)

### 2.3. E-Field Probe

This E-field detection probe is composed of three orthogonal dipoles linked to special Schottky diodes with low detection thresholds. The probe allows the measurement of electric fields in liquids such as the one defined in the IEEE and CENELEC standards.

For the measurements the Specific Dosimetric E-Field Probe SN 08/16 EPGO287 with following specifications is used



- Dynamic range: 0.01-100 W/kg
  - Tip Diameter : 2.5 mm
  - Distance between probe tip and sensor center: 1 mm
  - Distance between sensor center and the inner phantom surface: 2 mm (repeatability better than  $\pm 1$  mm).
  - Probe linearity:  $\pm 0.08$  dB
  - Axial isotropy:  $\pm 0.01$  dB
  - Hemispherical Isotropy:  $\pm 0.01$  dB
  - Calibration range: 650MHz to 5900MHz for head & body simulating liquid.
  - Lower detection limit: 8mW/kg
- Angle between probe axis (evaluation axis) and surface normal line: less than  $30^\circ$ .

#### 2.3.1. E-Field Probe Calibration

Each probe needs to be calibrated according to a dosimetric assessment procedure with accuracy better than  $\pm 10\%$ . The spherical isotropy shall be evaluated and within  $\pm 0.25$ dB. The sensitivity parameters (Norm X, Norm Y, and Norm Z), the diode compression parameter (DCP) and the conversion factor (Conv F) of the probe are tested. The calibration data can be referred to appendix D of this report.

## 2.4. SAM phantoms

Photo of SAM phantom SN 16/15 SAM119



The SAM phantom is used to measure the SAR relative to people exposed to electro-magnetic field radiated by Smart Phones.

2.4.1. Technical Data

Serial Number	Shell thickness	Filling volume	Dimensions	Positionner Material	Permittivity	Loss Tangent
SN 16/15 SAM119	2 mm ±0.2 mm	27 liters	Length:1000 mm Width:500 mm Height:200 mm	Gelcoat with fiberglass	3.4	0.02



Serial Number	Left Head(mm)		Right Head(mm)		Flat Part(mm)	
	1	2	1	2	1	2
SN 16/15 SAM119	2	2.02	2	2.08	1	2.09
	3	2.05	3	2.06	2	2.06
	4	2.07	4	2.07	3	2.08
	5	2.08	5	2.08	4	2.10
	6	2.05	6	2.07	5	2.10
	7	2.05	7	2.05	6	2.07
	8	2.07	8	2.06	7	2.07
	9	2.08	9	2.06	-	-

The test, based on ultrasonic system, allows measuring the thickness with an accuracy of 10 µm.

## 2.5. Device Holder

The positioning system allows obtaining cheek and tilting position with a very good accuracy. In compliance with CENELEC, the tilt angle uncertainty is lower than 1 degree.

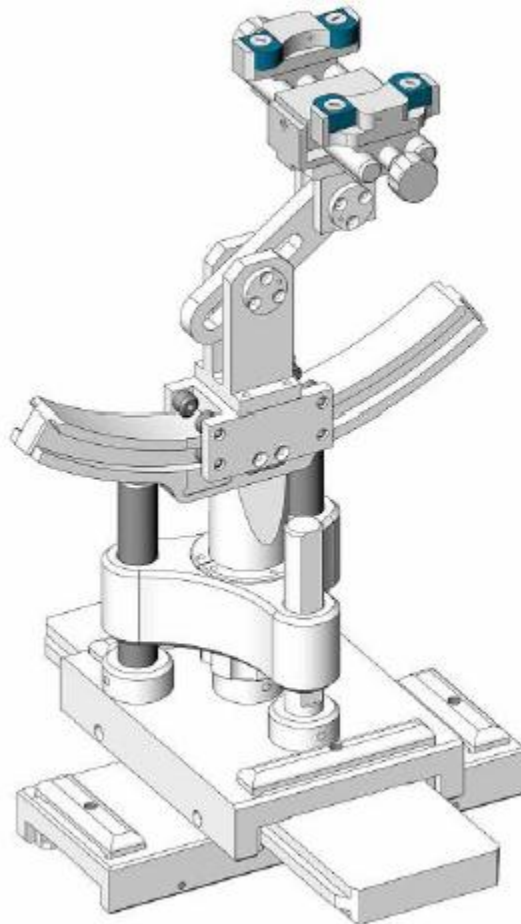

Serial Number	Holder Material	Permittivity	Loss Tangent
SN 16/15 MSH100	Delrin	3.7	0.005

## 2.6. Test Equipment List

This table gives a complete overview of the SAR measurement equipment.

Devices used during the test described are marked

	Manufacturer	Name of Equipment	Type/Model	Serial Number	Calibration	
					Last Cal.	Due Date
<input checked="" type="checkbox"/>	MVG	E FIELD PROBE	SSE2	SN 08/16 EPGO287	Jan. 10, 2023	Jan. 09, 2024
<input checked="" type="checkbox"/>	MVG	750 MHz Dipole	SID750	SN 03/15 DIP 0G750-355	Mar. 01, 2021	Feb. 28, 2024
<input checked="" type="checkbox"/>	MVG	835 MHz Dipole	SID835	SN 03/15 DIP 0G835-347	Mar. 01, 2021	Feb. 28, 2024
<input type="checkbox"/>	MVG	900 MHz Dipole	SID900	SN 03/15 DIP 0G900-348	Mar. 01, 2021	Feb. 28, 2024
<input checked="" type="checkbox"/>	MVG	1800 MHz Dipole	SID1800	SN 03/15 DIP 1G800-349	Mar. 01, 2021	Feb. 28, 2024
<input checked="" type="checkbox"/>	MVG	1900 MHz Dipole	SID1900	SN 03/15 DIP 1G900-350	Mar. 01, 2021	Feb. 28, 2024
<input type="checkbox"/>	MVG	2000 MHz Dipole	SID2000	SN 03/15 DIP 2G000-351	Mar. 01, 2021	Feb. 28, 2024
<input type="checkbox"/>	MVG	2300 MHz Dipole	SID2300	SN 03/16 DIP 2G300-358	Mar. 01, 2021	Feb. 28, 2024
<input checked="" type="checkbox"/>	MVG	2450 MHz Dipole	SID2450	SN 03/15 DIP 2G450-352	Mar. 01, 2021	Feb. 28, 2024
<input checked="" type="checkbox"/>	MVG	2600 MHz Dipole	SID2600	SN 03/15 DIP 2G600-356	Mar. 01, 2021	Feb. 28, 2024
<input type="checkbox"/>	MVG	3500 MHz Dipole	SID3500	SN 09/12 DIP 3G500-360	Oct. 15, 2022	Oct. 14, 2025
<input type="checkbox"/>	MVG	5000 MHz Dipole	SWG5500	SN 13/14 WGA 33	Mar. 01, 2021	Feb. 28, 2024
<input checked="" type="checkbox"/>	MVG	Liquid measurement Kit	SCLMP	SN 21/15 OCPG 72	NCR	NCR
<input checked="" type="checkbox"/>	MVG	Power Amplifier	N.A	AMPLISAR_28/14_003	NCR	NCR
<input checked="" type="checkbox"/>	KEITHLEY	Millivoltmeter	2000	4072790	NCR	NCR
<input checked="" type="checkbox"/>	R&S	Universal radio communication tester	CMU200	117858	May 29, 2023	May 28, 2024
<input checked="" type="checkbox"/>	R&S	Wideband radio communication	CMW500	103917	May 29, 2023	May 28, 2024



		tester				
<input checked="" type="checkbox"/>	HP	Network Analyzer	8753D	3410J01136	May 29, 2023	May 28, 2024
<input checked="" type="checkbox"/>	Agilent	MXG Vector Signal Generator	N5182A	MY47070317	May 29, 2023	May 28, 2024
<input checked="" type="checkbox"/>	Agilent	Power meter	E4419B	MY45102538	May 29, 2023	May 28, 2024
<input checked="" type="checkbox"/>	Agilent	Power sensor	E9301A	MY41495644	May 29, 2023	May 28, 2024
<input checked="" type="checkbox"/>	Agilent	Power sensor	E9301A	US39212148	May 29, 2023	May 28, 2024
<input checked="" type="checkbox"/>	MCLI/USA	Directional Coupler	CB11-20	0D2L51502	Jul. 04, 2023	Jul. 03, 2024
<input checked="" type="checkbox"/>	N/A	Thermometer	N/A	LES-085	Mar. 27, 2023	Mar. 26, 2026
<input checked="" type="checkbox"/>	MVG	SAM Phantom	SSM2	SN 16/15 SAM119	NCR	NCR
<input checked="" type="checkbox"/>	MVG	Device Holder	SMPPD	SN 16/15 MSH100	NCR	NCR
<input checked="" type="checkbox"/>	Shenzhen Tianxu Communication Technology Co., Ltd.	Human Simulating Liquid	Head 750	Head 750	NCR	NCR
<input checked="" type="checkbox"/>	Shenzhen Tianxu Communication Technology Co., Ltd.	Human Simulating Liquid	Head 835	Head 835	NCR	NCR
<input checked="" type="checkbox"/>	Shenzhen Tianxu Communication Technology Co., Ltd.	Human Simulating Liquid	Head 1800	Head 1800	NCR	NCR
<input checked="" type="checkbox"/>	Shenzhen Tianxu Communication Technology Co., Ltd.	Human Simulating Liquid	Head 1900	Head 1900	NCR	NCR
<input checked="" type="checkbox"/>	Shenzhen Tianxu Communication Technology Co., Ltd.	Human Simulating Liquid	Head 2450	Head 2450	NCR	NCR

	Co., Ltd.					
<input checked="" type="checkbox"/>	Shenzhen Tianxu Communication Technology Co., Ltd.	Human Simulating Liquid	Head 2600	Head 2600	NCR	NCR

### 3. SAR Measurement Procedures

The measurement procedures are as follows:

<Conducted power measurement>

- (a) For WWAN power measurement, use base station simulator to configure EUT WWAN transmission in conducted connection with RF cable, at maximum power in each supported wireless interface and frequency band.
- (b) Read the WWAN RF power level from the base station simulator.
- (c) For Wi-Fi/BT power measurement, use engineering software to configure EUT Wi-Fi/BT continuously transmission, at maximum RF power in each supported wireless interface and frequency band.
- (d) Connect EUT RF port through RF cable to the power meter, and measure Wi-Fi/BT output power.

<SAR measurement>

- (a) Use base station simulator to configure EUT WWAN transmission in radiated connection, and engineering software to configure EUT Wi-Fi/BT continuously transmission, at maximum RF power, in the highest power channel.
- (b) Place the EUT in the positions as Appendix A demonstrates.
- (c) Set scan area, grid size and other setting on the OPENSAR software.
- (d) Measure SAR results for the highest power channel on each testing position.
- (e) Find out the largest SAR result on these testing positions of each band.
- (f) Measure SAR results for other channels in worst SAR testing position if the reported SAR of highest power channel is larger than 0.8 W/kg.

According to the test standard, the recommended procedure for assessing the peak spatial-average SAR value consists of the following steps:

- (a) Power reference measurement
- (b) Area scan
- (c) Zoom scan
- (d) Power drift measurement

#### 3.1. Power Reference

The Power Reference Measurement and Power Drift Measurements are for monitoring the power drift of the device under test in the batch process. The minimum distance of probe sensors to surface determines the closest measurement point to phantom surface. This distance cannot be smaller than the distance of sensor calibration points to probe tip as defined in the probe properties.

#### 3.2. Area scan & Zoom scan

The area scan is a 2D scan to find the hot spot location on the DUT. The zoom scan is a 3D scan

above the hot spot to calculate the 1g and 10g SAR value.

Measurement of the SAR distribution with a grid of 8 to 16 mm \* 8 to 16 mm and a constant distance to the inner surface of the phantom. Since the sensors cannot directly measure at the inner phantom surface, the values between the sensors and the inner phantom surface are extrapolated. With these values the area of the maximum SAR is calculated by an interpolation scheme. Around this point, a cube of 30 \* 30 \* 30 mm or 32 \* 32 \* 32 mm is assessed by measuring 5 or 8 \* 5 or 8 \* 4 or 5 mm. With these data, the peak spatial-average SAR value can be calculated.

From the scanned SAR distribution, identify the position of the maximum SAR value, in addition identify the positions of any local maxima with SAR values within 2 dB of the maximum value that will not be within the zoom scan of other peaks; additional peaks shall be measured only when the primary peak is within 2 dB of the SAR compliance limit (e.g., 1 W/kg for 1,6 W/kg 1 g limit, or 1,26 W/kg for 2 W/kg, 10 g limit).

Area scan & Zoom scan scan parameters extracted from FCC KDB 865664 D01 SAR measurement 100 MHz to 6 GHz.

		≤ 3 GHz	> 3 GHz	
Maximum distance from closest measurement point (geometric center of probe sensors) to phantom surface		5 ± 1 mm	½·δ·ln(2) ± 0.5 mm	
Maximum probe angle from probe axis to phantom surface normal at the measurement location		30° ± 1°	20° ± 1°	
Maximum area scan spatial resolution: Δx <sub>Area</sub> , Δy <sub>Area</sub>		≤ 2 GHz: ≤ 15 mm 2 – 3 GHz: ≤ 12 mm	3 – 4 GHz: ≤ 12 mm 4 – 6 GHz: ≤ 10 mm	
		When the x or y dimension of the test device, in the measurement plane orientation, is smaller than the above, the measurement resolution must be ≤ the corresponding x or y dimension of the test device with at least one measurement point on the test device.		
Maximum zoom scan spatial resolution: Δx <sub>Zoom</sub> , Δy <sub>Zoom</sub>		≤ 2 GHz: ≤ 8 mm 2 – 3 GHz: ≤ 5 mm*	3 – 4 GHz: ≤ 5 mm* 4 – 6 GHz: ≤ 4 mm*	
Maximum zoom scan spatial resolution, normal to phantom surface	uniform grid: Δz <sub>Zoom</sub> (n)	≤ 5 mm	3 – 4 GHz: ≤ 4 mm 4 – 5 GHz: ≤ 3 mm 5 – 6 GHz: ≤ 2 mm	
	graded grid	Δz <sub>Zoom</sub> (1): between 1 <sup>st</sup> two points closest to phantom surface	≤ 4 mm	3 – 4 GHz: ≤ 3 mm 4 – 5 GHz: ≤ 2.5 mm 5 – 6 GHz: ≤ 2 mm
		Δz <sub>Zoom</sub> (n>1): between subsequent points	≤ 1.5·Δz <sub>Zoom</sub> (n-1)	
Minimum zoom scan volume	x, y, z	≥ 30 mm	3 – 4 GHz: ≥ 28 mm 4 – 5 GHz: ≥ 25 mm 5 – 6 GHz: ≥ 22 mm	

Note: δ is the penetration depth of a plane-wave at normal incidence to the tissue medium; see draft standard IEEE P1528-2011 for details.

\* When zoom scan is required and the *reported* SAR from the *area scan based 1-g SAR estimation* procedures of KDB 447498 is ≤ 1.4 W/kg, ≤ 8 mm, ≤ 7 mm and ≤ 5 mm zoom scan resolution may be applied, respectively, for 2 GHz to 3 GHz, 3 GHz to 4 GHz and 4 GHz to 6 GHz.

### **3.3. Description of interpolation/extrapolation scheme**

The local SAR inside the phantom is measured using small dipole sensing elements inside a probe body. The probe tip must not be in contact with the phantom surface in order to minimise measurements errors, but the highest local SAR will occur at the surface of the phantom.

An extrapolation is used to determine these highest local SAR values. The extrapolation is based on a fourth-order least-square polynomial fit of measured data. The local SAR value is then extrapolated from the liquid surface with a 1 mm step.

The measurements have to be performed over a limited time (due to the duration of the battery) so the step of measurement is high. It could vary between 5 and 8 mm. To obtain an accurate assessment of the maximum SAR averaged over 10 grams and 1 gram requires a very fine resolution in the three dimensional scanned data array.

### **3.4. Volumetric Scan**

The volumetric scan consists of a full 3D scan over a specific area. This 3D scan is useful for multi Tx SAR measurement. Indeed, it is possible with OpenSAR to add, point by point, several volumetric scans to calculate the SAR value of the combined measurement as it is defined in the standard IEEE1528 and IEC62209.

### **3.5. Power Drift**

All SAR testing is under the EUT installed with a full charged battery and transmit maximum output power. In OpenSAR measurement software, the power reference measurement and power drift measurement procedures are used for monitoring the power drift of EUT during SAR test. Both these procedures measure the field at a specified reference position before and after the SAR testing. The software will calculate the field difference in V/m. If the power drifts more than  $\pm 5\%$ , the SAR will be retested.

## 4. System Verification Procedure

### 4.1. Tissue Verification

The following tissue formulations are provided for reference only as some of the parameters have not been thoroughly verified. The composition of ingredients may be modified accordingly to achieve the desired target tissue parameters required for routine SAR evaluation.

Ingredients (% of weight)	Head Tissue									
	750	835	900	1800	1900	2000	2450	2600	5200	5800
Frequency Band (MHz)										
Water	34.40	34.40	34.40	55.36	55.36	57.87	57.87	57.87	65.53	65.53
NaCl	0.79	0.79	0.79	0.35	0.35	0.16	0.16	0.16	0.00	0.00
1,2-Propanediol	64.81	64.81	64.81	0.00	0.00	0.00	0.00	0.00	0.00	0.00
Triton X-100	0.00	0.00	0.00	30.45	30.45	19.97	19.97	19.97	24.24	24.24
DGBE	0.00	0.00	0.00	13.84	13.84	22.00	22.00	22.00	10.23	10.23

For SAR measurement of the field distribution inside the phantom, the phantom must be filled with homogeneous tissue simulating liquid to a depth of at least 15 cm. For head SAR testing, the liquid depth from the ear reference point (ERP) of the phantom to the liquid top surface is larger than 15 cm.

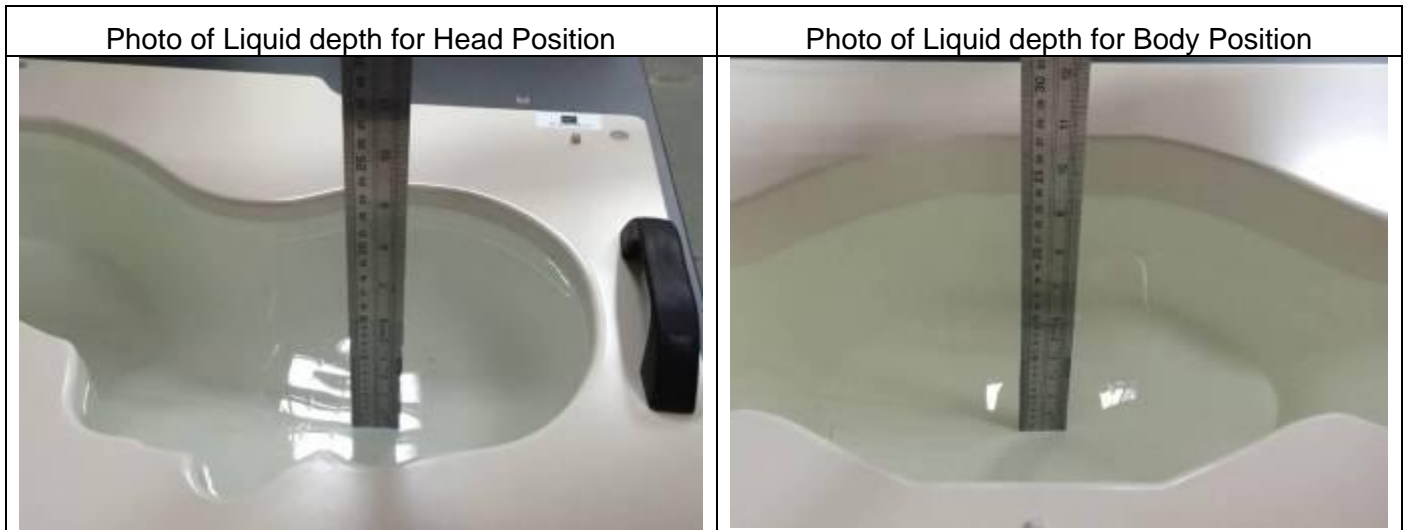

#### 4.1.1. Tissue Dielectric Parameter Check Results

The simulating liquids should be checked at the beginning of a series of SAR measurements to determine if the dielectric parameters are within the tolerances of the specified target values. The measured conductivity and relative permittivity should be within  $\pm 5\%$  of the target values.

Tissue Type	Measured Frequency (MHz)	Target Tissue		Measured Tissue		Liquid Temp.	Test Date
		$\epsilon_r$ ( $\pm 5\%$ )	$\sigma$ (S/m) ( $\pm 5\%$ )	$\epsilon_r$	$\sigma$ (S/m)		
Head 750	750	41.96 (39.86~44.06)	0.89 (0.85~0.93)	40.08	0.90	21.5 °C	Jul. 14, 2023
Head 850	835	41.50 (39.43~43.58)	0.90 (0.86~0.95)	40.47	0.92	21.1 °C	Jul. 21, 2023
Head 1800	1800	40.00 (38.00~42.00)	1.40 (1.33~1.47)	38.44	1.36	21.8 °C	Jul. 18, 2023
Head 1900	1900	40.00 (38.00~42.00)	1.40 (1.33~1.47)	38.49	1.43	21.3 °C	Jul. 19, 2023
Head 2450	2450	39.20 (37.24~41.16)	1.80 (1.71~1.89)	37.73	1.79	21.7 °C	Jul. 26, 2023
Head 2600	2600	39.01 (37.06~40.96)	1.96 (1.86~2.06)	38.14	1.97	21.4 °C	Jul. 27, 2023

NOTE: The dielectric parameters of the tissue-equivalent liquid should be measured under similar ambient conditions and within 2 °C of the conditions expected during the SAR evaluation to satisfy protocol requirements.

### 4.2. System Verification Procedure

The system verification is performed for verifying the accuracy of the complete measurement system and performance of the software. The dipole is connected to the signal source consisting of signal generator and amplifier via a directional coupler, N-connector cable and adaption to SMA. It is fed with a power of 100mW (below 5GHz) or 100mW (above 5GHz). To adjust this power a power meter is used. The power sensor is connected to the cable before the system verification to measure the power at this point and do adjustments at the signal generator. At the outputs of the directional coupler both return loss as well as forward power are controlled during the system verification to make sure that emitted power at the dipole is kept constant. This can also be checked by the power drift measurement after the test (result on plot).

The system verification is shown as below picture:

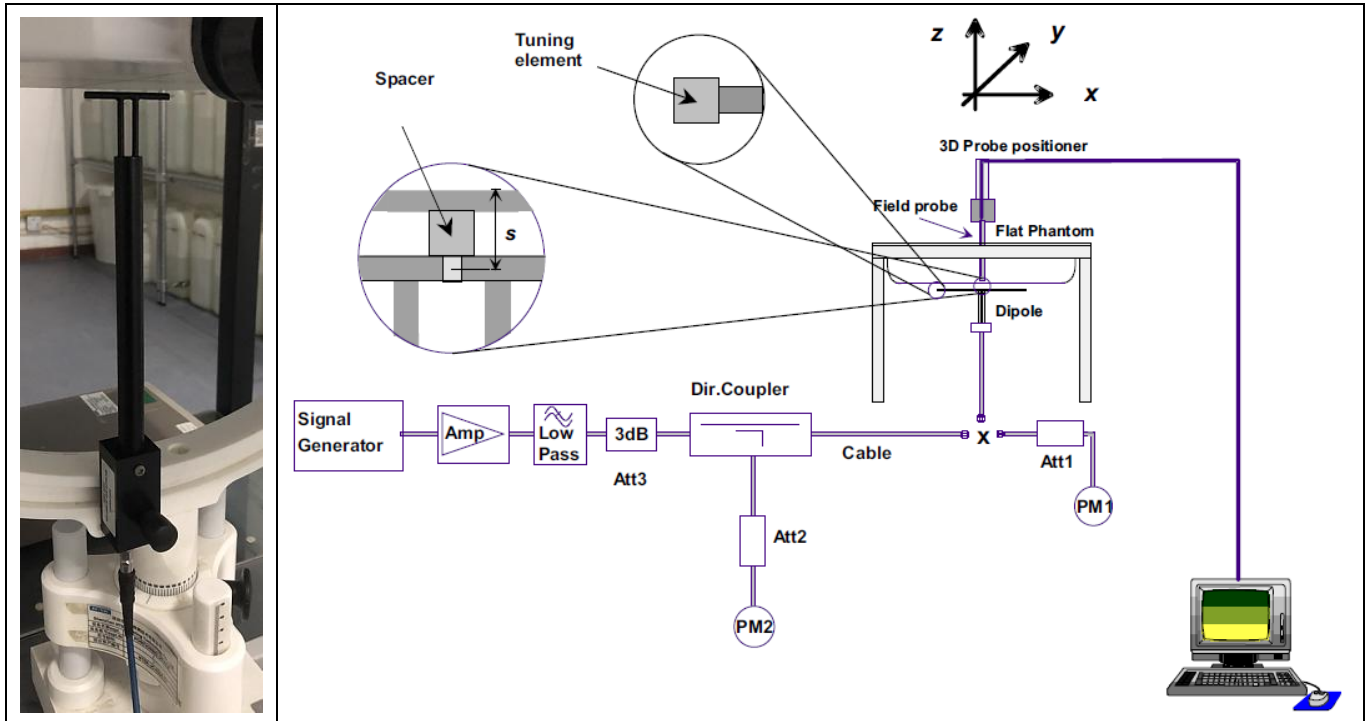



### 4.2.1. System Verification Results

Comparing to the original SAR value provided by SATIMO, the verification data should be within its specification of  $\pm 10\%$ . Below table shows the target SAR and measured SAR after normalized to 1W input power. The table below indicates the system performance verification can meet the variation criterion and the plots can be referred to Appendix B of this report.

System Verification	Target SAR (1W)		Measured SAR		Liquid Temp.	Delta (%)		Test Date
	( $\pm 10\%$ )		(Normalized to 1W)			1-g ( $\pm 10\%$ )	10-g ( $\pm 10\%$ )	
	1-g (W/Kg)	10-g (W/Kg)	1-g (W/Kg)	10-g (W/Kg)				
750MHz	8.53	5.56	7.92	6.00	21.5 °C	-7.15%	7.91%	Jul. 14, 2023
	(7.68~9.38)	(5.01~6.11)						
835MHz	9.84	6.22	9.07	6.07	21.1 °C	-7.83%	-2.41%	Jul. 21, 2023
	(8.86~10.82)	(5.60~6.84)						
1800MHz	37.96	19.81	35.74	19.36	21.8 °C	-5.85%	-2.27%	Jul. 18, 2023
	(34.17~41.75)	(17.83~21.79)						
1900MHz	40.37	20.48	42.68	21.82	21.3 °C	5.72%	6.54%	Jul. 19, 2023
	(36.34~44.40)	(18.44~22.52)						
2450MHz	53.69	23.94	53.60	22.85	21.7 °C	-0.17%	-2.97%	Jul. 26, 2023
	(48.33~59.05)	(21.55~26.33)						
2600MHz	55.83	24.19	52.77	26.34	21.4 °C	-5.48%	8.89%	Jul. 27, 2023
	(50.25~61.41)	(21.78~26.60)						

## **5. SAR Measurement variability and uncertainty**

### **5.1. SAR measurement variability**

Per KDB865664 D01 SAR measurement 100 MHz to 6 GHz, SAR measurement variability must be assessed for each frequency band, which is determined by the SAR probe calibration point and tissue-equivalent medium used for the device measurements. The additional measurements are repeated after the completion of all measurements requiring the same head or body tissue-equivalent medium in a frequency band. The test device should be returned to ambient conditions (normal room temperature) with the battery fully charged before it is re-mounted on the device holder for the repeated measurement(s) to minimize any unexpected variations in the repeated results.

- 1) Repeated measurement is not required when the original highest measured SAR is  $< 0.80$  W/kg; steps 2) through 4) do not apply.
- 2) When the original highest measured SAR is  $\geq 0.80$  W/kg, repeat that measurement once.
- 3) Perform a second repeated measurement only if the ratio of largest to smallest SAR for the original and first repeated measurements is  $> 1.20$  or when the original or repeated measurement is  $\geq 1.45$  W/kg (~ 10% from the 1-g SAR limit).
- 4) Perform a third repeated measurement only if the original, first or second repeated measurement is  $\geq 1.5$  W/kg and the ratio of largest to smallest SAR for the original, first and second repeated measurements is  $> 1.20$ .

### **5.2. SAR measurement uncertainty**

Per KDB865664 D01 SAR Measurement 100 MHz to 6 GHz, when the highest measured 1-g SAR within a frequency band is  $< 1.5$  W/kg, the extensive SAR measurement uncertainty analysis described in IEEE Std 1528-2013 is not required in SAR reports submitted for equipment approval. The equivalent ratio (1.5/1.6) is applied to extremity and occupational exposure conditions.

## 6. RF Exposure Positions

### 6.1. Ear and handset reference point

Figure 6.1.1 shows the front, back, and side views of the SAM phantom. The center-of-mouth reference point is labeled “M”, the left ear reference point (ERP) is marked “LE”, and the right ERP is marked “RE”.



Fig 6.1.1 Front, back, and side views of SAM phantom

### 6.2. Definition of the cheek position

1. Define two imaginary lines on the handset, the vertical centerline and the horizontal line. The vertical centerline passes through two points on the front side of the handset: the midpoint of the width  $w_t$  of the handset at the level of the acoustic output (point A in Figure 6.2.1 and Figure 6.2.2), and the midpoint of the width  $w_b$  of the bottom of the handset (point B). The horizontal line is perpendicular to the vertical centerline and passes through the center of the acoustic output (see Figure 6.2.1). The two lines intersect at point A. Note that for many handsets, point A coincides with the center of the acoustic output; however, the acoustic output may be located elsewhere on the horizontal line. Also note that the vertical centerline is not necessarily parallel to the front face of the handset (see Figure 6.2.2), especially for clamshell handsets, handsets with flip covers, and other irregularly-shaped handsets.
2. Position the handset close to the surface of the phantom such that point A is on the (virtual) extension of the line passing through points RE and LE on the phantom (see Figure 6.2.3), such that the plane defined by the vertical centerline and the horizontal line of the handset is approximately parallel to the sagittal plane of the phantom.
3. Translate the handset towards the phantom along the line passing through RE and LE until handset point A touches the pinna at the ERP
4. While maintaining the handset in this plane, rotate it around the LE-RE line until the vertical centerline is in the plane normal to the plane containing B-M and N-F lines, i.e., the Reference Plane.
5. Rotate the handset around the vertical centerline until the handset (horizontal line) is parallel to the N-F line.

6. While maintaining the vertical centerline in the Reference Plane, keeping point A on the line passing through RE and LE, and maintaining the handset contact with the pinna, rotate the handset about the N-F line until any point on the handset is in contact with a phantom point below the pinna on the cheek. See Figure 6.2.3. The actual rotation angles should be documented in the test report.

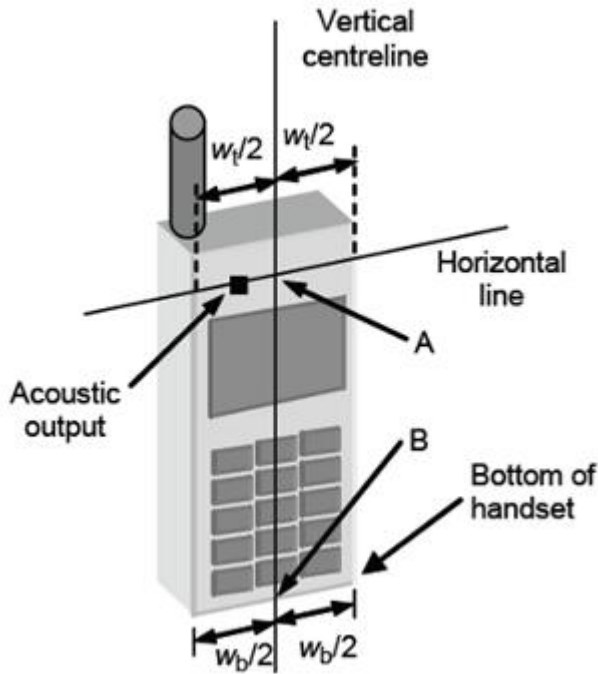

Fig 6.2.1 Handset vertical and horizontal reference lines—“fixed case”

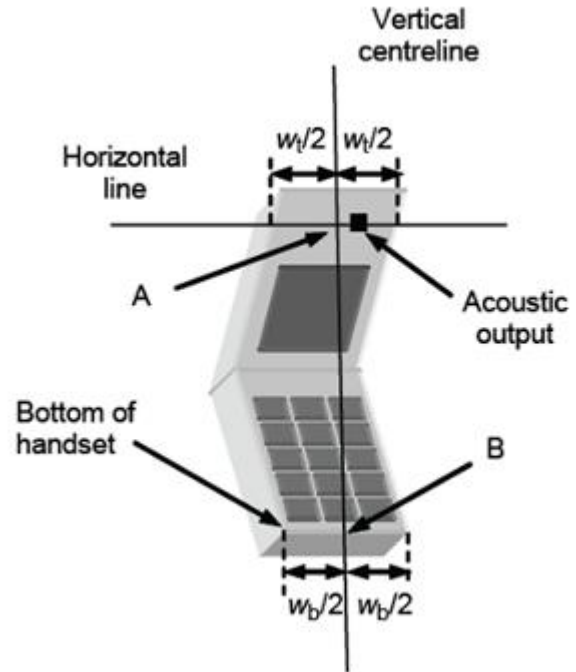

Fig 6.2.2 Handset vertical and horizontal reference lines— “clam-shell case”

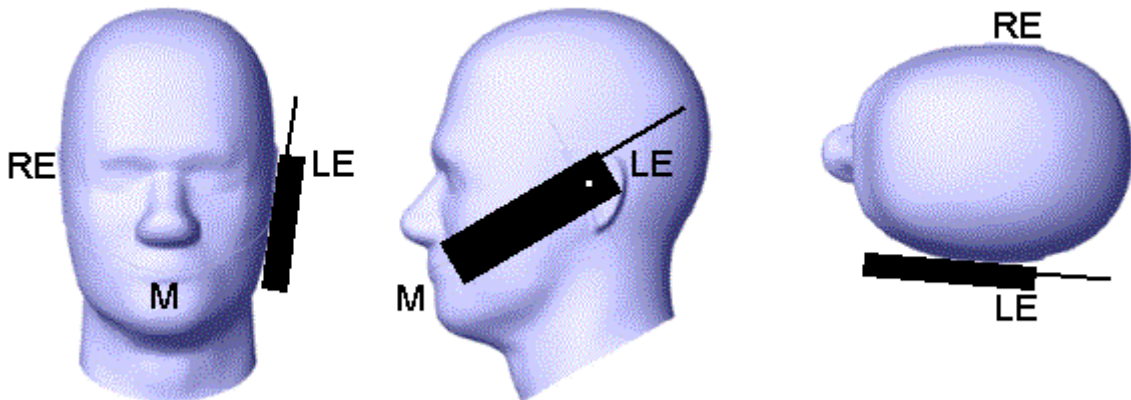

Fig 6.2.3 cheek or touch position. The reference points for the right ear (RE), left ear (LE), and mouth (M), which establish the Reference Plane for handset positioning, are indicated.

### 6.3. Definition of the tilt position

1. While maintaining the orientation of the handset, retract the handset parallel to the reference plane far enough away from the phantom to enable a rotation of the device by 15 degree.
2. Rotate the Handset around the horizontal line by 15 degree (see Figure 6.3.1).
3. While maintaining the orientation of the handset, move the handset towards the phantom on a line passing through RE and LE until any part of the handset touches the ear. The tilt position is obtained when the contact is on the pinna. If the contact is at any location other than the pinna, e.g., the antenna with the back of the phantom head, the angle of the handset shall be reduced. In this case, the tilt position is obtained if any part of the handset is in contact with the pinna as well as a second part of the handset is in contact with the phantom, e.g., the antenna with the back of the head.

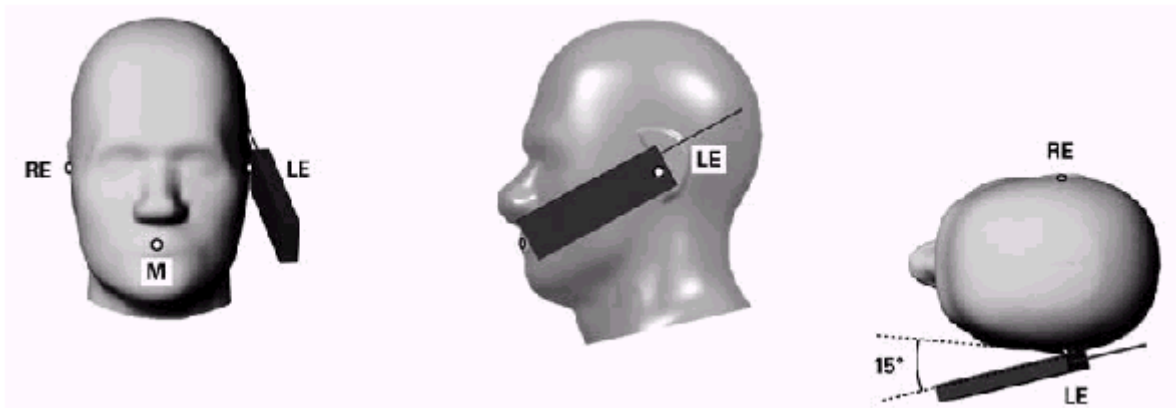

Figure 6.3.1 – Tilt position of the wireless device on the left side of SAM

### 6.4. Body Worn Accessory

1. Body-worn operating configurations are tested with the belt-clips and holsters attached to the device and positioned against a flat phantom in a normal use configuration (see Figure 6.4.1). Per KDB 648474 D04, body-worn accessory exposure is typically related to voice mode operations when handsets are carried in body-worn accessories. The body-worn accessory procedures in FCC KDB 447498 D01 should be used to test for body-worn accessory SAR compliance, without a headset connected to it. This enables the test results for such configuration to be compatible with that required for hotspot mode when the body-worn accessory test separation distance is greater than or equal to that required for hotspot mode, when applicable. When the reported SAR for body-worn accessory, measured without a headset connected to the handset is  $< 1.2$  W/kg, the highest reported SAR configuration for that wireless mode and frequency band should be repeated for that body-worn accessory with a handset attached to the handset.
2. Accessories for body-worn operation configurations are divided into two categories: those that do not contain metallic components and those that do contain metallic components and those that do contain metallic components. When multiple accessories that do not contain metallic components are supplied with the device, the device is tested with only the accessory that dictates the closest

spacing to the body. Then multiple accessories that contain metallic components are test with the device with each accessory. If multiple accessories share an identical metallic component (i.e. the same metallic belt-clip used with different holsters with no other metallic components) only the accessory that dictates the closest spacing to the body is tested.

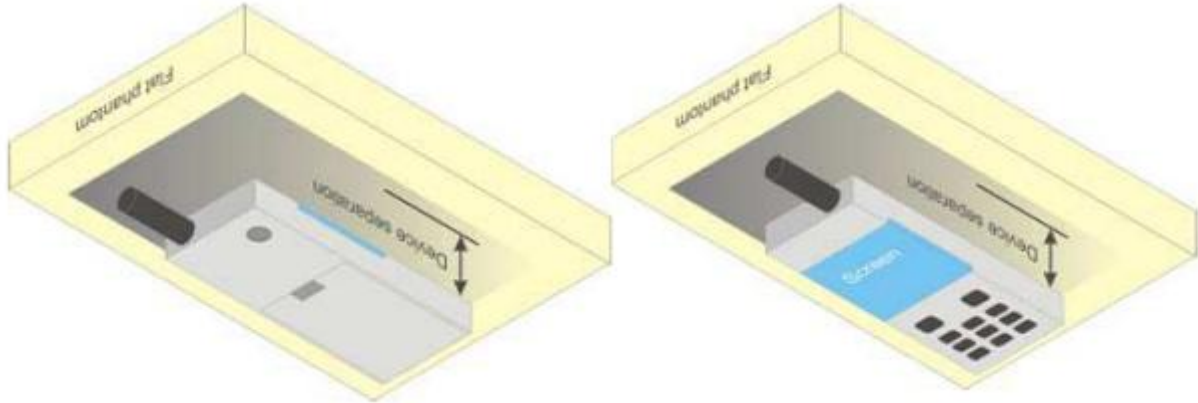

Figure 6.4.1 – Test positions for body-worn devices

### 6.5. Wireless Router Devices

Some battery-operated handsets have the capability to transmit and receive user through simultaneous transmission of WLAN simultaneously with a separate licensed transmitter. The FCC has provided guidance in FCC KDB Publication 941225 D06 where SAR test considerations for handsets ( $L \times W \geq 9 \text{ cm} \times 5 \text{ cm}$ ) are based on a composite test separation distance of 10mm from the front, back and edges of the device containing transmitting antennas within 2.5cm of their edges, determined from general mixed use conditions for this type of devices. Since the hotspot SAR results may overlap with the body-worn accessory SAR requirements, the more conservative configurations can be considered, thus excluding some body-worn accessory SAR tests.

When the user enables the personal wireless router functions for the handset, actual operations include simultaneous transmission of both the WLAN transmitter and another licensed transmitter. Both transmitters often do not transmit at the same transmitting frequency and thus cannot be evaluated for SAR under actual use conditions due to the limitations of the SAR assessment probes. Therefore, SAR must be evaluated for each frequency transmission and mode separately and spatially summed with the WLAN transmitter according to FCC KDB Publication 447498 D01 publication procedures. The “Portable Hotspot” feature on the handset was NOT activated during SAR assessments, to ensure the SAR measurements were evaluated for a single transmission frequency RF signal at a time.



## 7. RF Output Power

### 7.1. GSM Conducted Power

Band GSM850	Burst-Averaged output Power (dBm)				Frame-Averaged output Power (dBm)			
Tx Channel	Tune-up	128	189	251	Tune-up	128	189	251
Frequency (MHz)	(dBm)	824.2	836.4	848.8	(dBm)	824.2	836.4	848.8
GSM (GMSK)	33.50	33.38	33.29	33.37	24.47	24.35	24.26	24.34
GPRS(GMSK,1 Tx slot)	33.50	33.36	33.27	33.35	24.47	24.33	24.24	24.32
GPRS(GMSK,2 Tx slot)	31.50	31.38	31.14	31.12	25.48	25.36	25.12	25.10
GPRS(GMSK,3 Tx slot)	29.50	29.39	29.24	29.21	25.24	25.13	24.98	24.95
GPRS(GMSK,4 Tx slot)	27.50	27.20	27.05	27.04	24.49	24.19	24.04	24.03
EGPRS(8PSK,1 Tx slot)	33.50	33.38	33.28	33.37	24.47	24.35	24.25	24.34
EGPRS(8PSK,2 Tx slot)	31.50	31.36	31.13	31.12	25.48	25.34	25.11	25.10
EGPRS(8PSK,3 Tx slot)	29.50	29.37	29.21	29.17	25.24	25.11	24.95	24.91
EGPRS(8PSK,4 Tx slot)	27.50	27.14	27.05	27.02	24.49	24.13	24.04	24.01
Band GSM1900	Burst-Averaged output Power (dBm)				Frame-Averaged output Power (dBm)			
Tx Channel	Tune-up	512	661	810	Tune-up	512	661	810
Frequency (MHz)	(dBm)	1850.2	1880	1909.8	(dBm)	1850.2	1880	1909.8
GSM (GMSK)	31.00	30.55	30.51	30.56	21.97	21.52	21.48	21.53
GPRS(GMSK,1 Tx slot)	31.00	30.51	30.50	30.55	21.97	21.48	21.47	21.52
GPRS(GMSK,2 Tx slot)	28.50	28.48	28.38	28.14	22.48	22.46	22.36	22.12
GPRS(GMSK,3 Tx slot)	27.00	26.96	26.85	26.60	22.74	22.70	22.59	22.34
GPRS(GMSK,4 Tx slot)	25.00	24.86	24.74	24.48	21.99	21.85	21.73	21.47
EGPRS(8PSK,1 Tx slot)	31.00	30.55	30.54	30.58	21.97	21.52	21.51	21.55
EGPRS(8PSK,2 Tx slot)	29.00	28.52	28.42	28.17	22.98	22.50	22.40	22.15
EGPRS(8PSK,3 Tx slot)	27.00	26.98	26.86	26.60	22.74	22.72	22.60	22.34
EGPRS(8PSK,4 Tx slot)	25.00	24.90	24.77	24.50	21.99	21.89	21.76	21.49

### 7.2. WCDMA Conducted Power

WCDMA Band 2	Burst-Averaged output Power (dBm)			
Tx Channel	Tune-up	9262	9400	9538
Frequency (MHz)	(dBm)	1852.4	1880	1907.6
RMC12.2K	24.00	23.45	23.48	23.57
HSDPA Sub 1	23.50	23.11	23.12	23.15
HSDPA Sub 2	23.00	22.77	22.76	22.89

HSDPA Sub 3	23.00	22.37	22.67	22.73
HSDPA Sub 4	22.50	22.31	22.45	22.44
HSUPA Sub 1	23.00	22.92	22.89	22.96
HSUPA Sub 2	23.50	22.96	23.03	23.08
HSUPA Sub 3	23.00	22.84	22.88	22.48
HSUPA Sub 4	23.50	22.94	23.03	22.82
HSUPA Sub 5	23.00	22.68	22.70	22.68
WCDMA Band 4	Burst-Averaged output Power (dBm)			
Tx Channel	Tune-up (dBm)	1312	1413	1513
Frequency (MHz)		1712.4	1732.6	1752.6
RMC12.2K	23.50	23.21	23.25	23.41
HSDPA Sub 1	23.00	22.92	22.92	22.96
HSDPA Sub 2	23.00	22.64	22.72	22.69
HSDPA Sub 3	22.50	22.07	22.46	22.43
HSDPA Sub 4	22.50	22.17	22.29	22.29
HSUPA Sub 1	23.00	22.80	22.86	22.76
HSUPA Sub 2	23.00	22.80	22.89	22.91
HSUPA Sub 3	23.00	22.34	22.41	22.77
HSUPA Sub 4	23.00	22.75	22.91	22.92
HSUPA Sub 5	23.00	22.55	22.65	22.73
WCDMA Band 5	Burst-Averaged output Power (dBm)			
Tx Channel	Tune-up (dBm)	4132	4182	4233
Frequency (MHz)		826.4	836.4	846.6
RMC12.2K	23.50	23.02	23.02	22.97
HSDPA Sub 1	23.00	22.89	22.19	22.68
HSDPA Sub 2	23.00	22.68	21.93	22.42
HSDPA Sub 3	22.50	22.42	21.80	22.06
HSDPA Sub 4	22.50	22.05	21.29	21.78
HSUPA Sub 1	23.00	22.84	22.03	22.56
HSUPA Sub 2	23.00	22.83	22.20	22.63
HSUPA Sub 3	23.00	22.57	21.90	22.38
HSUPA Sub 4	23.00	22.63	21.96	22.34
HSUPA Sub 5	23.00	22.58	21.79	22.43



**7.3. LTE Conducted Power**

Band	Band Width	Modulation	RB Configuration		Tune-up (dBm)	Channel/Frequency(MHz)		
			RB Size	RB Offset		18607/1850.7	18900/1880	19193/1909.3
LTE Band 2	1.4MHz	QPSK	1	0	23.50	22.72	23.26	23.33
			1	2	23.50	22.96	23.34	23.28
			1	5	23.50	22.92	23.38	23.28
			3	0	23.50	23.02	23.25	23.38
			3	1	23.50	22.98	23.32	23.32
			3	2	23.50	22.92	23.24	23.28
		16QAM	1	0	23.00	22.04	22.23	22.89
			1	2	23.00	22.03	22.25	22.78
			1	5	23.00	22.04	22.15	22.73
			3	0	23.00	22.16	22.39	22.50
			3	1	23.00	22.12	22.32	22.49
			3	2	23.00	22.13	22.26	22.50
			6	0	21.50	20.95	21.37	20.98
Band	Band Width	Modulation	RB Configuration		Tune-up (dBm)	Channel/Frequency(MHz)		
			RB Size	RB Offset		18615/1851.5	18900/1880	19185/1908.5
LTE Band 2	3MHz	QPSK	1	0	23.50	22.97	23.27	23.35
			1	7	23.50	22.93	23.37	23.39
			1	14	23.50	23.01	23.43	23.40
			8	0	22.50	21.93	22.30	22.33
			8	4	22.50	22.01	22.24	22.22
			8	7	22.50	21.98	22.19	22.28
			15	0	22.50	21.96	22.19	22.18
		16QAM	1	0	23.00	22.57	22.32	22.84
			1	7	23.00	22.63	22.20	22.82
			1	14	23.00	22.43	22.07	22.72
			8	0	22.00	21.17	21.60	21.37
			8	4	22.00	21.14	21.24	21.34
			8	7	22.00	21.11	21.34	21.43
15	0	22.00	21.16	21.58	21.27			
Band	Band Width	Modulation	RB Configuration		Tune-up (dBm)	Channel/Frequency(MHz)		



2			1	74	24.00	23.12	23.20	23.51			
			36	0	22.50	22.01	22.27	22.27			
			36	18	22.50	22.12	22.20	22.33			
			36	37	22.50	22.17	22.12	22.29			
			75	0	22.50	22.09	22.14	22.40			
		16QAM	1	0	23.00	22.54	22.91	22.42			
			1	37	23.00	22.68	22.80	22.26			
			1	74	23.00	22.70	22.85	22.41			
			36	0	21.50	21.07	21.17	21.36			
			36	18	21.50	21.05	21.20	21.44			
			36	37	21.50	21.10	21.18	21.33			
			75	0	22.00	21.17	21.72	21.32			
			Band	Band Width	Modulation	RB Configuration		Tune-up (dBm)	Channel/Frequency(MHz)		
						RB Size	RB Offset		18700/1860	18900/1880	19100/1900
LTE Band 2	20MHz	QPSK	1	0	24.00	23.29	23.44	23.58			
			1	49	24.00	23.32	23.42	23.59			
			1	99	24.00	23.48	23.49	23.51			
			50	0	22.50	22.06	22.27	22.31			
			50	24	22.50	22.15	22.19	22.24			
			50	49	22.50	22.01	22.16	22.28			
			100	0	22.50	22.12	22.21	22.39			
		16QAM	1	0	22.50	22.00	21.57	22.32			
			1	49	22.50	21.99	21.60	22.35			
			1	99	22.50	22.32	21.80	22.31			
			50	0	22.00	21.12	21.33	21.35			
			50	24	22.00	21.15	21.56	21.35			
			50	49	22.00	21.18	21.21	21.35			
			100	0	22.00	21.20	21.67	21.45			

Band	Band Width	Modulation	RB Configuration		Tune-up (dBm)	Channel/Frequency(MHz)		
			RB Size	RB Offset		19957/1710.7	20175/1732.5	20393/1754.3
LTE Band 4	1.4MHz	QPSK	1	0	23.50	22.60	23.01	23.14
			1	2	23.50	22.70	23.07	23.15
			1	5	23.50	22.64	23.06	23.22
			3	0	23.50	22.81	23.07	23.10
			3	1	23.50	22.85	23.15	23.07

		16QAM	3	2	23.50	22.77	23.09	23.06
			6	0	22.50	21.67	22.07	22.05
			1	0	23.00	22.28	22.63	22.68
			1	2	23.00	22.30	22.61	22.72
			1	5	23.00	22.33	22.55	22.74
			3	0	22.50	22.15	22.34	22.37
			3	1	22.50	22.02	22.39	22.41
			3	2	22.50	22.10	22.36	22.29
			6	0	21.00	20.56	20.83	20.75
Band	Band Width	Modulation	RB Configuration		Tune-up (dBm)	Channel/Frequency(MHz)		
			RB Size	RB Offset		19965/1711.5	20175/1732.5	20385/1753.5
LTE Band 4	3MHz	QPSK	1	0	23.50	22.97	23.01	23.17
			1	7	23.50	23.04	23.13	23.21
			1	14	23.50	23.00	23.03	23.13
			8	0	22.50	21.65	22.07	22.08
			8	4	22.50	21.77	22.06	22.09
			8	7	22.50	21.73	22.04	22.17
			15	0	22.50	21.74	22.02	22.01
		16QAM	1	0	23.00	21.90	22.58	22.71
			1	7	23.00	21.84	22.65	22.71
			1	14	23.00	21.70	22.82	22.76
			8	0	21.50	20.99	21.27	21.34
			8	4	21.50	20.94	21.13	21.34
			8	7	21.50	20.84	21.28	21.30
			15	0	21.50	20.90	21.23	21.38
Band	Band Width	Modulation	RB Configuration		Tune-up (dBm)	Channel/Frequency(MHz)		
			RB Size	RB Offset		19975/1712.5	20175/1732.5	20375/1752.5
LTE Band 4	5MHz	QPSK	1	0	23.50	23.16	23.32	23.13
			1	12	23.50	23.00	23.32	23.25
			1	24	23.50	22.96	23.34	23.20
			12	0	22.50	21.76	21.87	21.88
			12	6	22.50	21.71	22.06	21.98
			12	11	22.50	21.63	22.02	21.96
			25	0	22.00	21.64	22.00	21.94
		16QAM	1	0	22.50	21.89	22.03	21.92
			1	12	22.50	21.62	22.06	21.97

Band	Band Width	Modulation	RB Configuration		Tune-up (dBm)	Channel/Frequency(MHz)		
			RB Size	RB Offset		20000/1715	20175/1732.5	20350/1750
			1	24	22.50	21.75	22.09	21.99
			12	0	21.50	20.90	21.06	21.05
			12	6	21.50	20.76	21.11	21.14
			12	11	21.50	20.78	21.18	21.07
			25	0	21.50	20.90	21.34	21.37
Band	Band Width	Modulation	RB Configuration		Tune-up (dBm)	Channel/Frequency(MHz)		
			RB Size	RB Offset		20025/1717.5	20175/1732.5	20325/1747.5
LTE Band 4	10MHz	QPSK	1	0	23.50	22.78	22.95	22.83
			1	24	23.50	22.62	22.56	22.89
			1	49	23.50	22.83	23.12	22.98
			25	0	22.50	21.62	21.95	21.89
			25	12	22.50	21.71	21.93	22.05
			25	24	22.50	21.70	22.02	22.07
			50	0	22.50	21.80	22.04	22.06
		16QAM	1	0	23.00	22.37	22.63	22.67
			1	24	23.00	22.36	22.73	22.60
			1	49	23.00	22.36	22.72	22.80
			25	0	21.50	20.69	21.05	21.04
			25	12	21.50	20.71	21.15	21.07
			25	24	21.50	21.34	21.40	21.09
			50	0	22.00	21.87	21.15	21.06
Band	Band Width	Modulation	RB Configuration		Tune-up (dBm)	Channel/Frequency(MHz)		
			RB Size	RB Offset		20025/1717.5	20175/1732.5	20325/1747.5
LTE Band 4	15MHz	QPSK	1	0	23.50	22.80	23.01	22.84
			1	37	23.50	22.78	23.03	22.85
			1	74	23.50	22.94	23.13	22.89
			36	0	22.50	21.60	22.03	22.00
			36	18	22.50	21.67	22.08	21.80
			36	37	22.50	21.74	22.01	21.95
			75	0	22.00	21.67	21.94	21.94
		16QAM	1	0	23.00	22.40	22.49	22.53
			1	37	23.00	22.20	22.62	22.67
			1	74	23.00	22.48	22.76	22.66
			36	0	21.50	20.72	21.08	20.89
			36	18	21.50	21.06	21.12	20.91
			36	37	21.50	20.75	21.05	20.92

Band	Band Width	Modulation	RB Configuration		Tune-up (dBm)	Channel/Frequency(MHz)		
			RB Size	RB Offset		20050/1720	20175/1732.5	20300/1745
			75	0	21.50	21.11	21.23	21.17
LTE Band 4	20MHz	QPSK	1	0	23.50	23.01	23.23	22.97
			1	49	23.50	22.96	23.34	23.03
			1	99	23.50	23.20	23.47	23.17
			50	0	22.50	21.73	21.95	21.85
			50	24	22.50	21.76	22.13	22.02
			50	49	22.50	21.84	22.00	22.06
			100	0	22.50	21.67	22.00	22.07
		16QAM	1	0	22.50	21.91	21.97	22.07
			1	49	22.50	21.92	22.00	22.24
			1	99	22.50	22.11	22.22	22.16
			50	0	21.50	20.72	21.06	21.10
			50	24	21.50	21.13	21.09	21.06
			50	49	21.50	20.99	21.11	21.16
			100	0	21.50	21.23	21.19	21.09

Band	Band Width	Modulation	RB Configuration		Tune-up (dBm)	Channel/Frequency(MHz)		
			RB Size	RB Offset		20407/824.7	20525/836.5	20643/848.3
			1	0	23.50	22.99	23.14	22.90
LTE Band 5	1.4MHz	QPSK	1	2	23.50	23.07	23.11	22.86
			1	5	23.50	23.02	23.07	22.88
			3	0	23.50	23.09	23.03	23.04
			3	1	23.50	23.09	22.95	23.02
			3	2	23.50	23.15	22.96	23.04
			6	0	22.50	22.10	22.04	22.02
			16QAM	1	0	23.00	22.53	21.93
		1		2	23.00	22.55	22.00	22.42
		1		5	23.00	22.56	21.84	22.34
		3		0	22.50	22.36	22.19	22.19
		3		1	22.50	22.36	22.10	22.10
		3		2	22.50	22.38	22.07	22.10
		6		0	21.50	20.83	21.10	20.99
		Band	Band Width	Modulation	RB Configuration		Tune-up (dBm)	Channel/Frequency(MHz)

Band	Band Width	Modulation	RB Configuration		Tune-up (dBm)	Channel/Frequency(MHz)		
			RB Size	RB Offset		20425/826.5	20525/836.5	20625/846.5
LTE Band 5	3MHz	QPSK	1	0	23.50	20415/825.5	20525/836.5	20635/847.5
			1	7	23.50	23.14	23.08	23.11
			1	14	23.50	23.14	23.20	23.09
			8	0	22.50	23.18	23.10	23.09
			8	4	22.50	22.12	21.86	21.95
			8	7	22.50	22.13	21.93	21.98
			8	7	22.50	22.20	21.91	21.93
		16QAM	15	0	22.50	22.10	22.02	21.90
			1	0	23.00	22.53	21.83	21.86
			1	7	23.00	22.63	22.03	21.81
			1	14	23.00	22.70	21.95	21.85
			8	0	22.00	21.28	21.36	20.99
			8	4	22.00	21.19	21.41	21.06
			8	7	22.00	21.57	21.41	21.35
15	0	21.50	21.22	21.38	20.94			
LTE Band 5	5MHz	QPSK	1	0	23.50	22.92	23.17	23.01
			1	12	23.50	23.25	23.14	23.16
			1	24	23.50	23.10	23.12	23.14
			12	0	22.50	22.15	21.93	21.91
			12	6	22.50	22.24	21.89	21.95
			12	11	22.50	22.10	21.81	21.96
			25	0	22.50	22.18	21.95	21.83
		16QAM	1	0	23.00	22.67	21.91	21.95
			1	12	23.00	22.68	22.05	21.88
			1	24	23.00	22.51	21.94	21.76
			12	0	21.50	21.13	21.31	20.83
			12	6	21.50	21.44	21.39	20.89
			12	11	21.50	21.44	21.31	20.89
			25	0	22.00	21.51	21.51	21.02
LTE Band	10MHz	QPSK	RB Configuration		Tune-up (dBm)	Channel/Frequency(MHz)		
			RB Size	RB Offset		20450/829	20525/836.5	20600/844
LTE Band	10MHz	QPSK	1	0	23.50	23.31	23.00	22.91
			1	24	23.50	23.28	22.93	22.92

5			1	49	23.50	23.20	22.81	22.85
			25	0	22.50	22.08	21.95	21.87
			25	12	22.50	22.13	21.91	21.81
			25	24	22.50	21.92	21.91	21.84
			50	0	22.50	22.10	21.89	21.89
		16QAM	1	0	22.50	22.12	22.47	22.25
			1	24	22.50	22.06	22.33	22.27
			1	49	22.50	22.04	22.34	22.36
			25	0	22.00	21.66	21.33	20.85
			25	12	22.00	21.34	21.21	20.76
			25	24	22.00	21.53	20.79	20.75
			50	0	21.50	21.11	21.30	20.96

Band	Band Width	Modulation	RB Configuration		Tune-up (dBm)	Channel/Frequency(MHz)		
			RB Size	RB Offset		20775/2502.5	21100/2535	21425/2567.5
LTE Band 7	5MHz	QPSK	1	0	24.00	23.10	23.50	23.53
			1	12	24.00	23.20	23.50	23.51
			1	24	24.00	23.28	23.47	23.34
			12	0	22.50	22.31	22.27	22.25
			12	6	22.50	22.31	22.28	22.24
			12	11	22.50	22.31	22.27	22.29
			25	0	22.50	22.35	22.28	22.27
		16QAM	1	0	22.50	22.36	22.39	22.44
			1	12	22.50	22.40	22.29	22.33
			1	24	22.50	22.39	22.39	22.25
			12	0	22.00	21.68	21.35	21.42
			12	6	22.00	21.42	21.38	21.46
			12	11	22.00	21.43	21.39	21.41
			25	0	22.00	21.63	21.59	21.61
Band	Band Width	Modulation	RB Configuration		Tune-up (dBm)	Channel/Frequency(MHz)		
			RB Size	RB Offset		20800/2505	21100/2535	21400/2565
LTE Band 7	10MHz	QPSK	1	0	23.50	23.33	23.31	23.23
			1	24	23.50	23.37	23.28	23.26
			1	49	23.50	23.26	23.30	23.23
			25	0	22.50	22.35	22.26	22.22
			25	12	22.50	22.23	22.25	22.27



Band	Band Width	Modulation	RB Configuration		Tune-up (dBm)	Channel/Frequency(MHz)		
			RB Size	RB Offset		20825/2507.5	21100/2535	21375/2562.5
		16QAM	25	24	22.50	22.32	22.34	22.23
			50	0	22.50	22.35	22.23	22.23
			1	0	23.50	22.93	22.92	22.90
			1	24	23.50	22.82	22.87	22.74
			1	49	23.50	22.84	23.02	22.88
			25	0	21.50	21.34	21.38	21.28
			25	12	21.50	21.40	21.37	21.34
			25	24	21.50	21.31	21.37	21.32
			50	0	22.00	21.50	21.38	21.33
Band	Band Width	Modulation	RB Configuration		Tune-up (dBm)	Channel/Frequency(MHz)		
			RB Size	RB Offset		20850/2510	21100/2535	21350/2560
LTE Band 7	15MHz	QPSK	1	0	24.00	23.53	23.49	23.41
			1	37	24.00	23.46	23.47	23.42
			1	74	24.00	23.54	23.50	23.39
			36	0	22.50	22.41	22.33	22.29
			36	18	22.50	22.23	22.32	22.15
			36	37	22.50	22.28	22.32	22.31
			75	0	22.50	22.36	22.33	22.12
		16QAM	1	0	22.50	22.38	22.37	22.31
			1	37	22.50	22.41	22.23	22.27
			1	74	22.50	22.35	22.37	22.27
			36	0	22.00	21.64	21.47	21.41
			36	18	22.00	21.54	21.44	21.42
			36	37	22.00	21.57	21.46	21.50
			75	0	21.50	21.38	21.35	21.29
LTE Band 7	20MHz	QPSK	1	0	24.00	23.47	23.45	23.47
			1	49	24.00	23.37	23.39	23.35
			1	99	24.00	23.44	23.53	23.43
			50	0	22.50	22.31	22.32	22.21
			50	24	22.50	22.32	22.31	22.29
			50	49	22.50	22.16	22.28	22.23
			100	0	22.50	22.25	22.34	22.20
		16QAM	1	0	23.00	22.18	22.45	22.38
			1	49	23.00	22.38	22.49	22.12

			1	99	23.00	22.34	22.56	22.31
			50	0	22.00	21.46	21.43	21.35
			50	24	22.00	21.38	21.45	21.30
			50	49	22.00	21.44	21.50	21.32
			100	0	21.50	21.38	21.36	21.37

Band	Band Width	Modulation	RB Configuration		Tune-up (dBm)	Channel/Frequency(MHz)		
			RB Size	RB Offset		23205/779.5	23230/782	23255/784.5
LTE Band 13	5MHz	QPSK	1	0	23.50	22.76	23.18	23.16
			1	12	23.50	22.95	23.11	22.95
			1	24	23.50	22.84	23.12	23.28
			12	0	22.00	21.72	21.78	21.85
			12	6	22.00	21.88	21.89	21.82
			12	11	22.00	21.73	21.70	21.90
			25	0	22.00	21.75	21.90	21.89
		16QAM	1	0	22.00	21.88	21.86	21.97
			1	12	22.00	21.83	21.82	21.92
			1	24	22.00	21.80	21.78	21.83
			12	0	21.50	21.35	20.89	20.89
			12	6	21.50	20.92	21.23	20.85
			12	11	21.50	20.88	20.84	20.96
			25	0	21.50	21.11	21.46	21.17

Band	Band Width	Modulation	RB Configuration		Tune-up (dBm)	Channel/Frequency(MHz)		
			RB Size	RB Offset		N/A	23230/782	N/A
LTE Band 13	10MHz	QPSK	1	0	24.00	N/A	22.94	N/A
			1	24	24.00	N/A	23.02	N/A
			1	49	24.00	N/A	22.89	N/A
			25	0	23.00	N/A	21.87	N/A
			25	12	23.00	N/A	21.72	N/A
			25	24	23.00	N/A	21.91	N/A
			50	0	23.00	N/A	21.78	N/A
		16QAM	1	0	23.00	N/A	22.29	N/A
			1	24	23.00	N/A	22.34	N/A
			1	49	23.00	N/A	22.26	N/A
			25	0	22.00	N/A	20.90	N/A
			25	12	22.00	N/A	21.13	N/A

			25	24	22.00	N/A	20.80	N/A
			50	0	22.00	N/A	21.17	N/A

Band	Band Width	Modulation	RB Configuration		Tune-up (dBm)	Channel/Frequency(MHz)		
			RB Size	RB Offset		131979/1710.7	132322/1745	132665/1779.3
LTE Band 66	1.4MHz	QPSK	1	0	23.50	21.76	23.03	23.20
			1	2	23.50	22.79	23.12	23.25
			1	5	23.50	22.75	23.12	23.26
			3	0	23.50	22.84	23.05	23.27
			3	1	23.50	22.77	23.10	23.35
			3	2	23.50	22.80	23.03	23.29
			6	0	22.50	21.69	21.94	22.16
		16QAM	1	0	23.00	21.87	22.68	22.85
			1	2	23.00	22.02	22.73	22.80
			1	5	23.00	21.78	22.53	22.85
			3	0	23.00	21.99	22.22	22.53
			3	1	23.00	21.99	22.33	22.51
			3	2	23.00	22.02	22.28	22.50
			6	0	21.50	20.69	20.76	21.01
Band	Band Width	Modulation	RB Configuration		Tune-up (dBm)	Channel/Frequency(MHz)		
			RB Size	RB Offset		131987/1711.5	132322/1745	132657/1778.5
LTE Band 66	3MHz	QPSK	1	0	23.50	22.82	23.11	23.13
			1	7	23.50	22.76	23.06	23.09
			1	14	23.50	22.76	23.10	23.08
			8	0	22.50	21.79	22.11	22.21
			8	4	22.50	21.83	22.07	22.14
			8	7	22.50	21.79	22.02	22.11
			15	0	22.50	21.80	22.03	22.10
		16QAM	1	0	23.00	22.47	22.55	22.77
			1	7	23.00	22.41	22.61	22.69
			1	14	23.00	22.38	22.69	22.70
			8	0	21.50	20.87	21.20	21.31
			8	4	21.50	20.94	21.20	21.28
			8	7	21.50	20.87	21.24	21.35
			15	0	21.50	20.87	21.31	21.31
Band	Band	Modulation	RB		Tune-up	Channel/Frequency(MHz)		

	Width		Configuration		(dBm)			
			RB Size	RB Offset		131997/1712.5	132322/1745	132647/1777.5
LTE Band 66	5MHz	QPSK	1	0	24.00	22.96	23.28	23.50
			1	12	24.00	23.02	23.30	23.46
			1	24	24.00	23.04	23.36	23.41
			12	0	22.50	21.67	21.92	22.13
			12	6	22.50	21.85	22.09	22.17
			12	11	22.50	21.77	22.03	22.14
			25	0	22.50	21.78	22.04	22.14
		16QAM	1	0	22.50	21.78	22.01	22.23
			1	12	22.50	21.77	22.14	22.27
			1	24	22.50	21.73	22.07	22.22
			12	0	21.50	20.88	21.44	21.32
			12	6	21.50	20.90	21.03	21.26
			12	11	21.50	20.86	21.19	21.30
			25	0	21.50	21.01	21.26	21.41
Band	Band Width	Modulation	RB Configuration		Tune-up (dBm)	Channel/Frequency(MHz)		
			RB Size	RB Offset		132022/1715	132322/1745	132622/1775
LTE Band 66	10MHz	QPSK	1	0	23.50	22.82	22.89	23.30
			1	24	23.50	22.85	22.93	23.17
			1	49	23.50	22.92	22.99	23.13
			25	0	22.50	21.65	22.01	22.12
			25	12	22.50	21.54	21.94	22.25
			25	24	22.50	21.86	22.07	22.09
			50	0	22.50	21.72	21.93	22.24
		16QAM	1	0	23.00	21.79	22.84	22.97
			1	24	23.00	22.38	22.71	22.83
			1	49	23.00	22.52	22.86	22.83
			25	0	21.50	20.80	21.37	21.27
			25	12	21.50	20.69	21.04	21.17
			25	24	21.50	20.81	21.03	21.14
			50	0	21.50	20.80	21.17	21.19
Band	Band Width	Modulation	RB Configuration		Tune-up (dBm)	Channel/Frequency(MHz)		
			RB Size	RB Offset		132047/1717.5	132322/1745	132597/1772.5
LTE	15MHz	QPSK	1	0	23.50	22.86	22.90	23.22

Band 66			1	37	23.50	22.74	22.97	23.15
			1	74	23.50	22.90	23.02	23.20
			36	0	22.50	21.69	22.01	22.22
			36	18	22.50	21.77	22.06	22.23
			36	37	22.50	21.84	22.06	22.15
			75	0	22.50	21.77	22.05	22.24
		16QAM	1	0	23.00	22.35	22.70	22.85
			1	37	23.00	22.36	22.81	22.90
			1	74	23.00	22.66	22.87	22.70
			36	0	21.50	20.74	20.98	21.25
			36	18	21.50	20.80	21.06	21.30
			36	37	21.50	20.87	21.05	21.23
			75	0	21.50	20.98	21.18	21.32
Band	Band Width	Modulation	RB Configuration		Tune-up (dBm)	Channel/Frequency(MHz)		
			RB Size	RB Offset		132072/1720	132322/1745	132572/1770
LTE Band 66	20MHz	QPSK	1	0	24.00	23.08	23.10	23.51
			1	49	24.00	23.05	23.08	23.47
			1	99	24.00	23.27	23.28	23.42
			50	0	22.50	21.76	21.88	22.09
			50	24	22.50	21.88	21.95	22.12
			50	49	22.50	21.93	22.04	22.14
			100	0	22.50	21.80	22.08	22.10
		16QAM	1	0	23.00	21.88	22.74	22.33
			1	49	23.00	21.85	22.71	22.19
			1	99	23.00	22.03	22.81	22.21
			50	0	21.50	20.74	21.08	21.30
			50	24	21.50	20.94	21.13	21.30
			50	49	21.50	20.99	21.21	21.23
			100	0	21.50	20.97	21.12	21.26

#### 7.4. WLAN & Bluetooth Output Power

Mode	Channel	Frequency (MHz)	Tune-up (dBm)	Output Power (dBm)
802.11b	1	2412	15.50	14.37
	6	2437	15.50	14.33
	11	2462	15.50	15.47
802.11g	1	2412	14.50	13.70
	6	2437	14.50	13.53
	11	2462	14.50	14.28
802.11n HT20	1	2412	12.50	12.18
	6	2437	12.50	12.16
	11	2462	12.50	12.48

NOTE: Power measurement results of WLAN 2.4G.

BR+EDR	Output Power (dBm)				
	Channel	Tune-up (dBm)	Data Rates		
			1M	2M	3M
	0CH	6.00	5.10	4.85	4.05
	39CH	5.00	4.58	3.92	4.47
	78CH	4.00	3.25	3.10	3.54

BLE	Channel	Tune-up (dBm)	Output Power (dBm)
	0CH	-1.00	-1.74
	19CH	-2.00	-2.80
	39CH	-3.00	-3.66

NOTE: Power measurement results of Bluetooth.



Bluetooth	6.00	3.98	5	2.480	1.25	3.0	Yes
-----------	------	------	---	-------	------	-----	-----

NOTE: Standalone SAR test exclusion for Bluetooth.

When standalone SAR test exclusion applies to an antenna that transmits simultaneously with other antennas, the standalone SAR must be estimated according to following to determine simultaneous transmission SAR test exclusion:

$[(\text{max. power of channel, including tune-up tolerance, mW})/(\text{min. test separation distance, mm})] * [\sqrt{f_{\text{(GHz)}}/x}] \text{ W/kg}$  for test separation distances  $\leq 50\text{mm}$ , where  $x = 7.5$  for 1-g SAR and  $x = 18.75$  for 10-g SAR.

When the minimum test separation distance is  $< 5 \text{ mm}$ , a distance of  $5 \text{ mm}$  is applied to determine SAR test exclusion.

Mode	Position	$P_{\text{max}}$ (dBm)	$P_{\text{max}}$ (mW)	Distance (mm)	f (GHz)	x	Estimated SAR (W/Kg)
Bluetooth	Head	6.00	3.98	5	2.48	7.5	0.167
Bluetooth	Body	6.00	3.98	10	2.48	7.5	0.083
Bluetooth	Hotspot	6.00	3.98	10	2.48	7.5	0.083

NOTE: Estimated SAR calculation for Bluetooth

## 10. SAR Results

### 10.1. SAR measurement Result

#### 10.1.1. SAR measurement Result of GSM850

Test Position of Head	Test channel /Freq.	Mode	SAR Value (W/kg)		Power Drift(%)	Conducted Power (dBm)	Tune-up Power (dBm)	Scaled SAR 1-g (W/Kg)	Date	Plot
			1-g	10-g						
Left Cheek	189/836.4	GPRS(GMSK 2TS)	0.228	0.163	-0.63	31.14	31.50	0.248	2023/7/21	1#
Left Tilt 15 Degree	189/836.4	GPRS(GMSK 2TS)	0.130	0.091	0.05	31.14	31.50	0.141	2023/7/21	
Right Cheek	189/836.4	GPRS(GMSK 2TS)	0.196	0.135	2.32	31.14	31.50	0.213	2023/7/21	
Right Tilt 15 Degree	189/836.4	GPRS(GMSK 2TS)	0.092	0.065	1.72	31.14	31.50	0.100	2023/7/21	

NOTE: Head SAR test results of GSM850.

Test	Test	Test Mode	SAR Value	Power	Conducted	Tune-up	Scaled	Date	Plot
------	------	-----------	-----------	-------	-----------	---------	--------	------	------



Position of Body-Worn with 10mm	channel /Freq.		(W/kg)		Drift (±5%)	power (dBm)	power (dBm)	SAR 1g (W/Kg)		
			1g	10g						
Front Side	189/836.4	GPRS(GMSK 2TS)	0.216	0.149	-0.61	31.14	31.50	0.235	2023/7/21	
Back Side	189/836.4	GPRS(GMSK 2TS)	0.323	0.223	-1.70	31.14	31.50	0.351	2023/7/21	2#

NOTE: Body-Worn SAR test results of GSM850

Test Position of Hotspot with 10mm	Test channel /Freq.	Mode	SAR Value (W/kg)		Power Drift(%)	Conducted Power (dBm)	Tune-up Power (dBm)	Scaled SAR 1-g (W/Kg)	Date	Plot
			1-g	10-g						
Front Side	189/836.4	GPRS(GMSK 2TS)	0.216	0.149	-0.61	31.14	31.50	0.235	2023/7/21	
Back Side	189/836.4	GPRS(GMSK 2TS)	0.323	0.223	-1.70	31.14	31.50	0.351	2023/7/21	2#
Left Side	189/836.4	GPRS(GMSK 2TS)	0.099	0.068	3.94	31.14	31.50	0.108	2023/7/21	
Right Side	189/836.4	GPRS(GMSK 2TS)	0.105	0.069	-2.97	31.14	31.50	0.114	2023/7/21	
Bottom Side	189/836.4	GPRS(GMSK 2TS)	0.170	0.116	-3.30	31.14	31.50	0.185	2023/7/21	

NOTE: Hotspot SAR test results of GSM850

**10.1.2. SAR measurement Result of GSM1900**

Test Position of Head	Test channel /Freq.	Mode	SAR Value (W/kg)		Power Drift(%)	Conducted Power (dBm)	Tune-up Power (dBm)	Scaled SAR 1-g (W/Kg)	Date	Plot
			1-g	10-g						
Left Cheek	661/1880	GPRS(GMSK 3TS)	0.272	0.152	0.20	26.85	27.00	0.282	2023/7/19	3#
Left Tilt 15 Degree	661/1880	GPRS(GMSK 3TS)	0.157	0.084	1.65	26.85	27.00	0.163	2023/7/19	
Right Cheek	661/1880	GPRS(GMSK 3TS)	0.237	0.131	-2.37	26.85	27.00	0.245	2023/7/19	
Right Tilt 15 Degree	661/1880	GPRS(GMSK 3TS)	0.125	0.070	2.96	26.85	27.00	0.129	2023/7/19	

NOTE: Head SAR test results of GSM1900

Test	Test	Test Mode	SAR Value	Power	Conducted	Tune-up	Scaled	Date	Plot
------	------	-----------	-----------	-------	-----------	---------	--------	------	------

Position of Body-Worn with 10mm	channel /Freq.		(W/kg)		Drift (±5%)	power (dBm)	power (dBm)	SAR 1g (W/Kg)		
			1g	10g						
Front Side	661/1880	GPRS(GMSK 3TS)	0.192	0.102	0.63	26.85	27.00	0.199	2023/7/19	
Back Side	661/1880	GPRS(GMSK 3TS)	0.285	0.151	-2.54	26.85	27.00	0.295	2023/7/19	4#

NOTE: Body-Worn SAR test results of GSM1900

Test Position of Hotspot with 10mm	Test channel /Freq.	Mode	SAR Value (W/kg)		Power Drift(%)	Conducted Power (dBm)	Tune-up Power (dBm)	Scaled SAR 1-g (W/Kg)	Date	Plot
			1-g	10-g						
Front Side	661/1880	GPRS(GMSK 3TS)	0.192	0.102	0.63	26.85	27.00	0.199	2023/7/19	
Back Side	661/1880	GPRS(GMSK 3TS)	0.285	0.151	-2.54	26.85	27.00	0.295	2023/7/19	4#
Left Side	661/1880	GPRS(GMSK 3TS)	0.087	0.044	-1.35	26.85	27.00	0.090	2023/7/19	
Right Side	661/1880	GPRS(GMSK 3TS)	0.096	0.050	-2.66	26.85	27.00	0.099	2023/7/19	
Bottom Side	661/1880	GPRS(GMSK 3TS)	0.150	0.079	3.76	26.85	27.00	0.155	2023/7/19	

NOTE: Hotspot SAR test results of GSM1900

### 10.1.3. SAR measurement Result of WCDMA Band 2

Test Position of Head	Test channel /Freq	Mode	SAR Value (W/kg)		Power Drift(%)	Conducted Power (dBm)	Tune-up Power (dBm)	Scaled SAR 1-g (W/Kg)	Date	Plot
			1-g	10-g						
Left Cheek	9400/1880	RMC12.2K	0.620	0.352	-0.10	23.48	24.00	0.699	2023/7/19	5#
Left Tilt 15 Degree	9400/1880	RMC12.2K	0.317	0.178	0.24	23.48	24.00	0.357	2023/7/19	
Right Cheek	9400/1880	RMC12.2K	0.552	0.298	-3.81	23.48	24.00	0.622	2023/7/19	
Right Tilt 15 Degree	9400/1880	RMC12.2K	0.261	0.147	2.02	23.48	24.00	0.294	2023/7/19	

NOTE: Head SAR test results of WCDMA Band 2

Test Position of Body-Worn with 10mm	Test channel /Freq.	Test Mode	SAR Value (W/kg)		Power Drift (±5%)	Conducted power (dBm)	Tune-up power (dBm)	Scaled SAR 1g (W/Kg)	Date	Plot
			1g	10g						
Front Side	9400/1880	RMC12.2K	0.276	0.147	-2.75	23.48	24.00	0.311	2023/7/19	
Back Side	9400/1880	RMC12.2K	0.421	0.236	-0.06	23.48	24.00	0.475	2023/7/19	6#

NOTE: Body-Worn SAR test results of WCDMA Band 2

Test Position of Hotspot with 10mm	Test channel /Freq.	Mode	SAR Value (W/kg)		Power Drift(%)	Conducted Power (dBm)	Tune-up Power (dBm)	Scaled SAR 1-g (W/Kg)	Date	Plot
			1-g	10-g						
Front Side	9400/1880	RMC12.2K	0.276	0.147	-2.75	23.48	24.00	0.311	2023/7/19	
Back Side	9400/1880	RMC12.2K	0.421	0.236	-0.06	23.48	24.00	0.475	2023/7/19	6#
Left Side	9400/1880	RMC12.2K	0.141	0.076	3.80	23.48	24.00	0.159	2023/7/19	
Right Side	9400/1880	RMC12.2K	0.138	0.077	-2.52	23.48	24.00	0.156	2023/7/19	
Bottom Side	9400/1880	RMC12.2K	0.220	0.123	0.29	23.48	24.00	0.248	2023/7/19	

NOTE: Hotspot SAR test results of WCDMA Band 2

#### 10.1.4. SAR measurement Result of WCDMA Band 4

Test Position of Head	Test channel /Freq	Mode	SAR Value (W/kg)		Power Drift(%)	Conducted Power (dBm)	Tune-up Power (dBm)	Scaled SAR 1-g (W/Kg)	Date	Plot
			1-g	10-g						
Left Cheek	1413/1732.6	RMC12.2K	0.559	0.338	-0.08	23.25	23.50	0.592	2023/7/18	7#
Left Tilt 15 Degree	1413/1732.6	RMC12.2K	0.321	0.186	-3.66	23.25	23.50	0.340	2023/7/18	
Right Cheek	1413/1732.6	RMC12.2K	0.504	0.290	3.22	23.25	23.50	0.534	2023/7/18	
Right Tilt 15	1413/1732.6	RMC12.2K	0.267	0.155	-1.90	23.25	23.50	0.283	2023/7/18	

Degree										
--------	--	--	--	--	--	--	--	--	--	--

NOTE: Head SAR test results of WCDMA Band 4

Test Position of Body-Worn with 10mm	Test channel /Freq.	Test Mode	SAR Value (W/kg)		Power Drift ( $\pm 5\%$ )	Conducted power (dBm)	Tune-up power (dBm)	Scaled SAR 1g (W/Kg)	Date	Plot
			1g	10g						
Front Side	1413/1732.6	RMC12.2K	0.312	0.179	-3.10	23.25	23.50	0.330	2023/7/18	
Back Side	1413/1732.6	RMC12.2K	0.489	0.290	0.15	23.25	23.50	0.518	2023/7/18	8#

NOTE: Body-Worn SAR test results of WCDMA Band 4

Test Position of Hotspot with 10mm	Test channel /Freq.	Mode	SAR Value (W/kg)		Power Drift(%)	Conducted Power (dBm)	Tune-up Power (dBm)	Scaled SAR 1-g (W/Kg)	Date	Plot
			1-g	10-g						
Front Side	1413/1732.6	RMC12.2K	0.312	0.179	-3.10	23.25	23.50	0.330	2023/7/18	
Back Side	1413/1732.6	RMC12.2K	0.489	0.290	0.15	23.25	23.50	0.518	2023/7/18	8#
Left Side	1413/1732.6	RMC12.2K	0.159	0.091	-1.00	23.25	23.50	0.168	2023/7/18	
Right Side	1413/1732.6	RMC12.2K	0.159	0.091	-3.63	23.25	23.50	0.168	2023/7/18	
Bottom Side	1413/1732.6	RMC12.2K	0.265	0.151	-0.23	23.25	23.50	0.281	2023/7/18	

NOTE: Hotspot SAR test results of WCDMA Band 4

### 10.1.5. SAR measurement Result of WCDMA Band 5

Test Position of Head	Test channel /Freq	Mode	SAR Value (W/kg)		Power Drift(%)	Conducted Power (dBm)	Tune-up Power (dBm)	Scaled SAR 1-g (W/Kg)	Date	Plot
			1-g	10-g						
Left Cheek	4182/836.4	RMC12.2K	0.160	0.121	-1.47	23.02	23.50	0.179	2023/7/21	9#
Left Tilt 15 Degree	4182/836.4	RMC12.2K	0.092	0.069	-2.89	23.02	23.50	0.103	2023/7/21	
Right Cheek	4182/836.4	RMC12.2K	0.144	0.105	3.39	23.02	23.50	0.161	2023/7/21	
Right Tilt 15	4182/836.4	RMC12.2K	0.074	0.053	1.42	23.02	23.50	0.083	2023/7/21	

Degree										
--------	--	--	--	--	--	--	--	--	--	--

NOTE: Head SAR test results of WCDMA Band 5

Test Position of Body-Worn with 10mm	Test channel /Freq.	Test Mode	SAR Value (W/kg)		Power Drift (±5%)	Conducted power (dBm)	Tune-up power (dBm)	Scaled SAR 1g (W/Kg)	Date	Plot
			1g	10g						
Front Side	4182/836.4	RMC12.2K	0.162	0.115	1.39	23.02	23.50	0.181	2023/7/21	
Back Side	4182/836.4	RMC12.2K	0.226	0.161	-0.19	23.02	23.50	0.252	2023/7/21	10#

NOTE: Body-Worn SAR test results of WCDMA Band 5

Test Position of Hotspot with 10mm	Test channel /Freq.	Mode	SAR Value (W/kg)		Power Drift(%)	Conducted Power (dBm)	Tune-up Power (dBm)	Scaled SAR 1-g (W/Kg)	Date	Plot
			1-g	10-g						
Front Side	4182/836.4	RMC12.2K	0.162	0.115	1.39	23.02	23.50	0.181	2023/7/21	
Back Side	4182/836.4	RMC12.2K	0.226	0.161	-0.19	23.02	23.50	0.252	2023/7/21	10#
Left Side	4182/836.4	RMC12.2K	0.078	0.053	2.69	23.02	23.50	0.087	2023/7/21	
Right Side	4182/836.4	RMC12.2K	0.081	0.058	0.94	23.02	23.50	0.090	2023/7/21	
Bottom Side	4182/836.4	RMC12.2K	0.135	0.096	-0.27	23.02	23.50	0.151	2023/7/21	

NOTE: Hotspot SAR test results of WCDMA Band 5

**10.1.6. SAR measurement Result of LTE Band 2**

Test Position of Head	Test channel /Freq.	Mode	SAR Value (W/kg)		Power Drift(%)	Conducted Power (dBm)	Tune-up Power (dBm)	Scaled SAR 1-g (W/Kg)	Date	Plot
			1-g	10-g						
<b>1RB</b>										
Left Cheek	18900/1880	20M QPSK(1,49)	0.480	0.280	0.08	23.42	24.00	0.549	2023/7/19	13#
Left Tilt 15 Degree	18900/1880	20M QPSK(1,49)	0.277	0.162	-0.15	23.42	24.00	0.317	2023/7/19	
Right Cheek	18900/1880	20M QPSK(1,49)	0.422	0.244	-1.07	23.42	24.00	0.482	2023/7/19	
Right Tilt 15 Degree	18900/1880	20M QPSK(1,49)	0.217	0.124	-1.98	23.42	24.00	0.248	2023/7/19	

50%RB										
Left Cheek	18900/1880	20M QPSK(50,0)	0.268	0.144	-3.84	22.27	22.50	0.283	2023/7/19	
Left Tilt 15 Degree	18900/1880	20M QPSK(50,0)	0.146	0.085	-4.52	22.27	22.50	0.154	2023/7/19	
Right Cheek	18900/1880	20M QPSK(50,0)	0.247	0.124	1.00	22.27	22.50	0.260	2023/7/19	
Right Tilt 15 Degree	18900/1880	20M QPSK(50,0)	0.111	0.067	2.43	22.27	22.50	0.117	2023/7/19	

NOTE: Head SAR test results of LTE Band 2

Test Position of Body-Worn with 10mm	Test channel /Freq.	Test Mode	SAR Value (W/kg)		Power Drift (±5%)	Conducted power (dBm)	Tune-up power (dBm)	Scaled SAR 1g (W/Kg)	Date	Plot
			1g	10g						
1RB										
Front Side	18900/1880	20M QPSK(1,49)	0.324	0.174	0.20	23.42	24.00	0.370	2023/7/19	
Back Side	18900/1880	20M QPSK(1,49)	0.496	0.269	-1.04	23.42	24.00	0.567	2023/7/19	14#
50%RB										
Front Side	18900/1880	20M QPSK(50,0)	0.170	0.090	4.79	22.27	22.50	0.179	2023/7/19	
Back Side	18900/1880	20M QPSK(50,0)	0.264	0.149	2.79	22.27	22.50	0.278	2023/7/19	

NOTE: Body-Worn SAR test results of LTE Band 2

Test Position of Hotspot with 10mm	Test channel /Freq.	Mode	SAR Value (W/kg)		Power Drift(%)	Conducted Power (dBm)	Tune-up Power (dBm)	Scaled SAR 1-g (W/Kg)	Date	Plot
			1-g	10-g						
1RB										
Front Side	18900/1880	20M QPSK(1,49)	0.324	0.174	0.20	23.42	24.00	0.370	2023/7/19	
Back Side	18900/1880	20M QPSK(1,49)	0.496	0.269	-1.04	23.42	24.00	0.567	2023/7/19	14#
Left Side	18900/1880	20M QPSK(1,49)	0.162	0.084	-3.30	23.42	24.00	0.185	2023/7/19	
Right Side	18900/1880	20M QPSK(1,49)	0.159	0.084	1.34	23.42	24.00	0.182	2023/7/19	

Bottom Side	18900/1880	20M QPSK(1,49)	0.270	0.144	3.76	23.42	24.00	0.309	2023/7/19	
50%RB										
Front Side	18900/1880	20M QPSK(50,0)	0.170	0.090	4.79	22.27	22.50	0.179	2023/7/19	
Back Side	18900/1880	20M QPSK(50,0)	0.264	0.149	2.79	22.27	22.50	0.278	2023/7/19	
Left Side	18900/1880	20M QPSK(50,0)	0.097	0.049	2.51	22.27	22.50	0.102	2023/7/19	
Right Side	18900/1880	20M QPSK(50,0)	0.088	0.043	-2.53	22.27	22.50	0.093	2023/7/19	
Bottom Side	18900/1880	20M QPSK(50,0)	0.151	0.085	1.19	22.27	22.50	0.159	2023/7/19	

NOTE: Hotspot SAR test results of LTE Band 2

**10.1.7. SAR measurement Result of LTE Band 4**

Test Position of Head	Test channel /Freq.	Mode	SAR Value (W/kg)		Power Drift(%)	Conducted Power (dBm)	Tune-up Power (dBm)	Scaled SAR 1-g (W/Kg)	Date	Plot
			1-g	10-g						
1RB										
Left Cheek	20175/1732.5	20M QPSK(1,99)	0.421	0.260	-0.61	23.47	23.50	0.424	2023/7/18	15#
Left Tilt 15 Degree	20175/1732.5	20M QPSK(1,99)	0.220	0.136	-0.13	23.47	23.50	0.222	2023/7/18	
Right Cheek	20175/1732.5	20M QPSK(1,99)	0.374	0.219	3.07	23.47	23.50	0.377	2023/7/18	
Right Tilt 15 Degree	20175/1732.5	20M QPSK(1,99)	0.177	0.109	-2.43	23.47	23.50	0.178	2023/7/18	
50%RB										
Left Cheek	20175/1732.5	20M QPSK(50,24)	0.240	0.150	-3.67	22.13	22.50	0.261	2023/7/18	
Left Tilt 15 Degree	20175/1732.5	20M QPSK(50,24)	0.113	0.068	0.35	22.13	22.50	0.123	2023/7/18	
Right	20175/1732.5	20M QPSK(50,24)	0.195	0.124	1.35	22.13	22.50	0.212	2023/7/18	

Cheek										
Right Tilt 15 Degree	20175/1732.5	20M QPSK(50,24)	0.105	0.056	4.36	22.13	22.50	0.114	2023/7/18	

NOTE: Head SAR test results of LTE Band 4

Test Position of Body-Worn with 10mm	Test channel /Freq.	Test Mode	SAR Value (W/kg)		Power Drift (±5%)	Conducted power (dBm)	Tune-up power (dBm)	Scaled SAR 1g (W/Kg)	Date	Plot
			1g	10g						
1RB										
Front Side	20175/1732.5	20M QPSK(1,99)	0.288	0.171	1.80	23.47	23.50	0.290	2023/7/18	
Back Side	20175/1732.5	20M QPSK(1,99)	0.432	0.270	-0.74	23.47	23.50	0.435	2023/7/18	16#
50%RB										
Front Side	20175/1732.5	20M QPSK(50,24)	0.155	0.086	4.05	22.13	22.50	0.169	2023/7/18	
Back Side	20175/1732.5	20M QPSK(50,24)	0.229	0.136	-1.04	22.13	22.50	0.249	2023/7/18	

NOTE: Body-Worn SAR test results of LTE Band 4

Test Position of Hotspot with 10mm	Test channel /Freq.	Mode	SAR Value (W/kg)		Power Drift(%)	Conducted Power (dBm)	Tune-up Power (dBm)	Scaled SAR 1-g (W/Kg)	Date	Plot
			1-g	10-g						
1RB										
Front Side	20175/1732.5	20M QPSK(1,99)	0.288	0.171	1.80	23.47	23.50	0.290	2023/7/18	
Back Side	20175/1732.5	20M QPSK(1,99)	0.432	0.270	-0.74	23.47	23.50	0.435	2023/7/18	16#
Left Side	20175/1732.5	20M QPSK(1,99)	0.132	0.078	0.49	23.47	23.50	0.133	2023/7/18	
Right Side	20175/1732.5	20M QPSK(1,99)	0.135	0.081	-3.84	23.47	23.50	0.136	2023/7/18	



Bottom Side	20175/1732.5	20M QPSK(1,99)	0.225	0.138	-1.49	23.47	23.50	0.227	2023/7/18	
50%RB										
Front Side	20175/1732.5	20M QPSK(50,24)	0.155	0.086	4.05	22.13	22.50	0.169	2023/7/18	
Back Side	20175/1732.5	20M QPSK(50,24)	0.229	0.136	-1.04	22.13	22.50	0.249	2023/7/18	
Left Side	20175/1732.5	20M QPSK(50,24)	0.068	0.046	-0.26	22.13	22.50	0.074	2023/7/18	
Right Side	20175/1732.5	20M QPSK(50,24)	0.079	0.044	3.77	22.13	22.50	0.086	2023/7/18	
Bottom Side	20175/1732.5	20M QPSK(50,24)	0.128	0.075	-0.45	22.13	22.50	0.139	2023/7/18	

NOTE: Hotspot SAR test results of LTE Band 4

**10.1.8. SAR measurement Result of LTE Band 5**

Test Position of Head	Test channel /Freq.	Mode	SAR Value (W/kg)		Power Drift(%)	Conducted Power (dBm)	Tune-up Power (dBm)	Scaled SAR 1-g (W/Kg)	Date	Plot
			1-g	10-g						
1RB										
Left Cheek	20525/836.5	10M QPSK(1,0)	0.162	0.123	-1.33	23.00	23.50	0.182	2023/7/21	17#
Left Tilt 15 Degree	20525/836.5	10M QPSK(1,0)	0.089	0.066	-3.74	23.00	23.50	0.100	2023/7/21	
Right Cheek	20525/836.5	10M QPSK(1,0)	0.154	0.116	1.00	23.00	23.50	0.173	2023/7/21	
Right Tilt 15 Degree	20525/836.5	10M QPSK(1,0)	0.073	0.054	-1.00	23.00	23.50	0.082	2023/7/21	
50%RB										
Left Cheek	20525/836.5	10M QPSK(25,12)	0.089	0.067	-1.87	21.91	22.50	0.102	2023/7/21	
Left Tilt 15 Degree	20525/836.5	10M QPSK(25,12)	0.050	0.039	-3.21	21.91	22.50	0.057	2023/7/21	
Right	20525/836.5	10M QPSK(25,12)	0.079	0.065	2.32	21.91	22.50	0.090	2023/7/21	

Cheek										
Right Tilt 15 Degree	20525/836.5	10M QPSK(25,12)	0.040	0.028	-0.75	21.91	22.50	0.046	2023/7/21	

NOTE: Head SAR test results of LTE Band 5

Test Position of Body-Worn with 10mm	Test channel /Freq.	Test Mode	SAR Value (W/kg)		Power Drift (±5%)	Conducted power (dBm)	Tune-up power (dBm)	Scaled SAR 1g (W/Kg)	Date	Plot
			1g	10g						
1RB										
Front Side	20525/836.5	10M QPSK(1,0)	0.132	0.094	-3.63	23.00	23.50	0.148	2023/7/21	
Back Side	20525/836.5	10M QPSK(1,0)	0.197	0.141	-0.98	23.00	23.50	0.221	2023/7/21	18#
50%RB										
Front Side	20525/836.5	10M QPSK(25,12)	0.076	0.049	-3.18	21.91	22.50	0.087	2023/7/21	
Back Side	20525/836.5	10M QPSK(25,12)	0.102	0.081	-4.55	21.91	22.50	0.117	2023/7/21	

NOTE: Body-Worn SAR test results of LTE Band 5

Test Position of Hotspot with 10mm	Test channel /Freq.	Mode	SAR Value (W/kg)		Power Drift(%)	Conducted Power (dBm)	Tune-up Power (dBm)	Scaled SAR 1-g (W/Kg)	Date	Plot
			1-g	10-g						
1RB										
Front Side	20525/836.5	10M QPSK(1,0)	0.132	0.094	-3.63	23.00	23.50	0.148	2023/7/21	
Back Side	20525/836.5	10M QPSK(1,0)	0.197	0.141	-0.98	23.00	23.50	0.221	2023/7/21	18#
Left Side	20525/836.5	10M QPSK(1,0)	0.063	0.043	-2.99	23.00	23.50	0.071	2023/7/21	
Right Side	20525/836.5	10M QPSK(1,0)	0.069	0.048	-2.79	23.00	23.50	0.077	2023/7/21	

Bottom Side	20525/836.5	10M QPSK(1,0)	0.110	0.079	0.11	23.00	23.50	0.123	2023/7/21	
50%RB										
Front Side	20525/836.5	10M QPSK(25,12)	0.076	0.049	-3.18	21.91	22.50	0.087	2023/7/21	
Back Side	20525/836.5	10M QPSK(25,12)	0.102	0.081	-4.55	21.91	22.50	0.117	2023/7/21	
Left Side	20525/836.5	10M QPSK(25,12)	0.032	0.025	1.59	21.91	22.50	0.037	2023/7/21	
Right Side	20525/836.5	10M QPSK(25,12)	0.037	0.026	-1.18	21.91	22.50	0.042	2023/7/21	
Bottom Side	20525/836.5	10M QPSK(25,12)	0.062	0.045	1.91	21.91	22.50	0.071	2023/7/21	

NOTE: Hotspot SAR test results of LTE Band 5

**10.1.9. SAR measurement Result of LTE Band 7**

Test Position of Head	Test channel /Freq.	Mode	SAR Value (W/kg)		Power Drift(%)	Conducted Power (dBm)	Tune-up Power (dBm)	Scaled SAR 1-g (W/Kg)	Date	Plot
			1-g	10-g						
1RB										
Left Cheek	21100/2535	20M QPSK(1,99)	0.193	0.099	-4.08	23.53	24.00	0.215	2023/7/27	19#
Left Tilt 15 Degree	21100/2535	20M QPSK(1,99)	0.100	0.049	-3.62	23.53	24.00	0.111	2023/7/27	
Right Cheek	21100/2535	20M QPSK(1,99)	0.182	0.093	-3.96	23.53	24.00	0.203	2023/7/27	
Right Tilt 15 Degree	21100/2535	20M QPSK(1,99)	0.086	0.042	0.79	23.53	24.00	0.096	2023/7/27	
50%RB										
Left Cheek	21100/2535	20M QPSK(50,0)	0.114	0.052	-4.15	22.32	22.50	0.119	2023/7/27	
Left Tilt 15 Degree	21100/2535	20M QPSK(50,0)	0.050	0.025	-4.82	22.32	22.50	0.052	2023/7/27	
Right	21100/2535	20M	0.107	0.048	-2.65	22.32	22.50	0.112	2023/7/27	

Cheek		QPSK(50,0)								
Right Tilt 15 Degree	21100/2535	20M QPSK(50,0)	0.048	0.022	-0.63	22.32	22.50	0.050	2023/7/27	

NOTE: Head SAR test results of LTE Band 7

Test Position of Body-Worn with 10mm	Test channel /Freq.	Mode	SAR Value (W/kg)		Power Drift(%)	Conducted Power (dBm)	Tune-up Power (dBm)	Scaled SAR 1-g (W/Kg)	Date	Plot
			1-g	10-g						
1RB										
Front Side	21100/2535	20M QPSK(1,99)	0.630	0.302	-0.44	23.53	24.00	0.702	2023/7/27	
Back Side	21100/2535	20M QPSK(1,99)	1.031	0.494	-0.26	23.53	24.00	1.149	2023/7/27	
Back Side	20850/2510	20M QPSK(1,99)	1.190	0.569	-0.55	23.50	23.50	1.190	2023/7/27	20#
Back Side	21350/2560	20M QPSK(1,99)	0.897	0.429	-0.98	23.43	23.50	0.912	2023/7/27	
BackSide Repeated	20850/2510	20M QPSK(1,99)	1.185	0.560	0.21	23.50	23.50	1.185	2023/7/27	
50%RB										
Front Side	21100/2535	20M QPSK(50,0)	0.374	0.176	-1.46	22.32	22.50	0.390	2023/7/27	
Back Side	21100/2535	20M QPSK(50,0)	0.554	0.263	-0.18	22.32	22.50	0.577	2023/7/27	
100%RB										
BackSide	21100/2535	20M QPSK(100,0)	0.458	0.241	2.01	22.34	22.50	0.475	2023/7/27	

NOTE: Body-Worn SAR test results of LTE Band 7

Test Position of Hotspot with 10mm	Test channel /Freq.	Mode	SAR Value (W/kg)		Power Drift(%)	Conducted Power (dBm)	Tune-up Power (dBm)	Scaled SAR 1-g (W/Kg)	Date	Plot
			1-g	10-g						
1RB										
Front Side	21100/2535	20M QPSK(1,99)	0.630	0.302	-0.44	23.53	24.00	0.702	2023/7/27	
Back Side	21100/2535	20M QPSK(1,99)	1.031	0.494	-0.26	23.53	24.00	1.149	2023/7/27	
Left Side	21100/2535	20M QPSK(1,99)	0.324	0.155	-0.56	23.53	24.00	0.361	2023/7/27	
Right Side	21100/2535	20M QPSK(1,99)	0.312	0.144	0.35	23.53	24.00	0.348	2023/7/27	

Bottom Side	21100/2535	20M QPSK(1,99)	0.520	0.244	1.23	23.53	24.00	0.579	2023/7/27	
Back Side	20850/2510	20M QPSK(1,99)	1.190	0.569	-0.55	23.50	23.50	1.190	2023/7/27	20#
Back Side	21350/2560	20M QPSK(1,99)	0.897	0.429	-0.98	23.43	23.50	0.912	2023/7/27	
BackSide Repeated	20850/2510	20M QPSK(1,99)	1.185	0.560	0.21	23.50	23.50	1.185	2023/7/27	
50%RB										
Front Side	21100/2535	20M QPSK(50,0)	0.374	0.176	-1.46	22.32	22.50	0.390	2023/7/27	
Back Side	21100/2535	20M QPSK(50,0)	0.554	0.263	-0.18	22.32	22.50	0.577	2023/7/27	
Left Side	21100/2535	20M QPSK(50,0)	0.194	0.090	-0.69	22.32	22.50	0.202	2023/7/27	
Right Side	21100/2535	20M QPSK(50,0)	0.167	0.073	1.52	22.32	22.50	0.174	2023/7/27	
Bottom Side	21100/2535	20M QPSK(50,0)	0.269	0.144	-1.45	22.32	22.50	0.280	2023/7/27	

NOTE: Hotspot SAR test results of LTE Band 7

**10.1.10. SAR measurement Result of LTE Band 13**

Test Position of Head	Test channel /Freq.	Mode	SAR Value (W/kg)		Power Drift(%)	Conducted Power (dBm)	Tune-up Power (dBm)	Scaled SAR 1-g (W/Kg)	Date	Plot
			1-g	10-g						
1RB										
Left Cheek	23230/782	10M QPSK(1,24)	0.230	0.179	-0.92	23.02	23.50	0.257	2023/7/14	21#
Left Tilt 15 Degree	23230/782	10M QPSK(1,24)	0.118	0.089	1.82	23.02	23.50	0.132	2023/7/14	
Right Cheek	23230/782	10M QPSK(1,24)	0.216	0.168	2.75	23.02	23.50	0.241	2023/7/14	
Right Tilt 15 Degree	23230/782	10M QPSK(1,24)	0.114	0.085	-1.45	23.02	23.50	0.127	2023/7/14	
50%RB										

Left Cheek	23230/782	10M QPSK(25,24)	0.129	0.103	2.80	21.91	22.00	0.132	2023/7/14	
Left Tilt 15 Degree	23230/782	10M QPSK(25,24)	0.066	0.049	3.69	21.91	22.00	0.067	2023/7/14	
Right Cheek	23230/782	10M QPSK(25,24)	0.112	0.092	0.24	21.91	22.00	0.114	2023/7/14	
Right Tilt 15 Degree	23230/782	10M QPSK(25,24)	0.068	0.043	-3.35	21.91	22.00	0.069	2023/7/14	

NOTE: Head SAR test results of LTE Band 13

Test Position of Body-Worn with 10mm	Test channel /Freq.	Mode	SAR Value (W/kg)		Power Drift(%)	Conducted Power (dBm)	Tune-up Power (dBm)	Scaled SAR 1-g (W/Kg)	Date	Plot
			1-g	10-g						
1RB										
Front Side	23230/782	10M QPSK(1,24)	0.246	0.181	1.13	23.02	23.50	0.275	2023/7/14	
Back Side	23230/782	10M QPSK(1,24)	0.381	0.295	-0.84	23.02	23.50	0.426	2023/7/14	22#
50%RB										
Front Side	23230/782	10M QPSK(25,24)	0.125	0.101	-4.35	21.91	22.00	0.128	2023/7/14	
Back Side	23230/782	10M QPSK(25,24)	0.225	0.169	-1.88	21.91	22.00	0.230	2023/7/14	

NOTE: Body-Worn SAR test results of LTE Band 13

Test Position of Hotspot with 10mm	Test channel /Freq.	Mode	SAR Value (W/kg)		Power Drift(%)	Conducted Power (dBm)	Tune-up Power (dBm)	Scaled SAR 1-g (W/Kg)	Date	Plot
			1-g	10-g						
1RB										
Front Side	23230/782	10M QPSK(1,24)	0.246	0.181	1.13	23.02	23.50	0.275	2023/7/14	
Back Side	23230/782	10M QPSK(1,24)	0.381	0.295	-0.84	23.02	23.50	0.426	2023/7/14	22#
Left Side	23230/782	10M QPSK(1,24)	0.120	0.088	1.25	23.02	23.50	0.134	2023/7/14	
Right Side	23230/782	10M QPSK(1,24)	0.123	0.094	0.88	23.02	23.50	0.137	2023/7/14	
Bottom	23230/782	10M QPSK(1,24)	0.195	0.146	0.67	23.02	23.50	0.218	2023/7/14	

Side										
50%RB										
Front Side	23230/782	10M QPSK(25,24)	0.125	0.101	-4.35	21.91	22.00	0.128	2023/7/14	
Back Side	23230/782	10M QPSK(25,24)	0.225	0.169	-1.88	21.91	22.00	0.230	2023/7/14	
Left Side	23230/782	10M QPSK(25,24)	0.071	0.045	-0.98	21.91	22.00	0.072	2023/7/14	
Right Side	23230/782	10M QPSK(25,24)	0.069	0.055	4.45	21.91	22.00	0.070	2023/7/14	
Bottom Side	23230/782	10M QPSK(25,24)	0.106	0.086	-4.87	21.91	22.00	0.108	2023/7/14	

NOTE: Hotspot SAR test results of LTE Band 13

**10.1.11. SAR measurement Result of LTE Band 66**

Test Position of Head	Test channel /Freq.	Mode	SAR Value (W/kg)		Power Drift(%)	Conducted Power (dBm)	Tune-up Power (dBm)	Scaled SAR 1-g (W/Kg)	Date	Plot
			1-g	10-g						
1RB										
Left Cheek	132322/1745	20M QPSK(1,0)	0.343	0.212	1.15	23.10	24.00	0.422	2023/7/18	23#
Left Tilt 15 Degree	132322/1745	20M QPSK(1,0)	0.181	0.111	-2.65	23.10	24.00	0.223	2023/7/18	
Right Cheek	132322/1745	20M QPSK(1,0)	0.292	0.171	3.79	23.10	24.00	0.359	2023/7/18	
Right Tilt 15 Degree	132322/1745	20M QPSK(1,0)	0.138	0.083	3.58	23.10	24.00	0.170	2023/7/18	
50%RB										
Left Cheek	132322/1745	20M QPSK(50,49)	0.189	0.123	-3.48	22.04	22.50	0.210	2023/7/18	
Left Tilt 15 Degree	132322/1745	20M QPSK(50,49)	0.095	0.064	-1.46	22.04	22.50	0.106	2023/7/18	
Right Cheek	132322/1745	20M QPSK(50,49)	0.161	0.088	-4.15	22.04	22.50	0.179	2023/7/18	

Right Tilt 15 Degree	132322/1745	20M QPSK(50,49)	0.069	0.048	2.20	22.04	22.50	0.077	2023/7/18	
----------------------	-------------	-----------------	-------	-------	------	-------	-------	-------	-----------	--

NOTE: Head SAR test results of LTE Band 66

Test Position of Body-Worn with 10mm	Test channel /Freq.	Mode	SAR Value (W/kg)		Power Drift(%)	Conducted Power (dBm)	Tune-up Power (dBm)	Scaled SAR 1-g (W/Kg)	Date	Plot
			1-g	10-g						
1RB										
Front Side	132322/1745	20M QPSK(1,0)	0.294	0.178	1.49	23.10	24.00	0.362	2023/7/18	
Back Side	132322/1745	20M QPSK(1,0)	0.478	0.290	-0.23	23.10	24.00	0.588	2023/7/18	24#
50%RB										
Front Side	132322/1745	20M QPSK(50,49)	0.168	0.094	0.34	22.04	22.50	0.187	2023/7/18	
Back Side	132322/1745	20M QPSK(50,49)	0.286	0.174	2.18	22.04	22.50	0.318	2023/7/18	

NOTE: Body-Worn SAR test results of LTE Band 66

Test Position of Hotspot with 10mm	Test channel /Freq.	Mode	SAR Value (W/kg)		Power Drift(%)	Conducted Power (dBm)	Tune-up Power (dBm)	Scaled SAR 1-g (W/Kg)	Date	Plot
			1-g	10-g						
1RB										
Front Side	132322/1745	20M QPSK(1,0)	0.294	0.178	1.49	23.10	24.00	0.362	2023/7/18	
Back Side	132322/1745	20M QPSK(1,0)	0.478	0.290	-0.23	23.10	24.00	0.588	2023/7/18	24#
Left Side	132322/1745	20M QPSK(1,0)	0.156	0.091	0.74	23.10	24.00	0.192	2023/7/18	
Right Side	132322/1745	20M QPSK(1,0)	0.144	0.086	-0.97	23.10	24.00	0.177	2023/7/18	
Bottom Side	132322/1745	20M QPSK(1,0)	0.250	0.150	0.57	23.10	24.00	0.308	2023/7/18	
50%RB										
Front Side	132322/1745	20M QPSK(50,49)	0.168	0.094	0.34	22.04	22.50	0.187	2023/7/18	
Back Side	132322/1745	20M QPSK(50,49)	0.286	0.174	2.18	22.04	22.50	0.318	2023/7/18	
Left	132322/1745	20M QPSK(50,49)	0.079	0.046	2.28	22.04	22.50	0.088	2023/7/18	



Side										
Right Side	132322/1745	20M QPSK(50,49)	0.076	0.048	-2.37	22.04	22.50	0.084	2023/7/18	
Bottom Side	132322/1745	20M QPSK(50,49)	0.125	0.089	2.42	22.04	22.50	0.139	2023/7/18	

NOTE: Hotspot SAR test results of LTE Band 66

**10.1.12. SAR measurement Result of WLAN 2.4G**

Test Position of Head	Test channel /Freq.	Mode	SAR Value (W/kg)		Power Drift(%)	Conducted Power (dBm)	Tune-up Power (dBm)	Scaled SAR 1-g (W/Kg)	Date	Plot
			1-g	10-g						
Left Cheek	11/2462	802.11b	0.413	0.214	-0.79	15.47	15.50	0.416	2023/7/26	11#
Left Tilt 15 Degree	11/2462	802.11b	0.231	0.120	-3.53	15.47	15.50	0.233	2023/7/26	
Right Cheek	11/2462	802.11b	0.379	0.189	-2.32	15.47	15.50	0.382	2023/7/26	
Right Tilt 15 Degree	11/2462	802.11b	0.203	0.104	-3.74	15.47	15.50	0.204	2023/7/26	

NOTE: Head SAR test results of WLAN2.4G

Test Position of Body-Worn with 10mm	Test channel /Freq.	Mode	SAR Value (W/kg)		Power Drift(%)	Conducted Power (dBm)	Tune-up Power (dBm)	Scaled SAR 1-g (W/Kg)	Date	Plot
			1-g	10-g						
Front Side	11/2462	802.11b	0.168	0.083	-3.95	15.47	15.50	0.169	2023/7/26	
Back Side	11/2462	802.11b	0.238	0.123	-0.64	15.47	15.50	0.240	2023/7/26	12#

NOTE: Body-worn SAR test results of WLAN2.4G

Test Position of Hotspot with 10mm	Test channel /Freq.	Mode	SAR Value (W/kg)		Power Drift(%)	Conducted Power (dBm)	Tune-up Power (dBm)	Scaled SAR 1-g (W/Kg)	Date	Plot
			1-g	10-g						
Front	11/2462	802.11b	0.168	0.083	-3.95	15.47	15.50	0.169	2023/7/26	

Side										
Back Side	11/2462	802.11b	0.238	0.123	-0.64	15.47	15.50	0.240	2023/7/26	12#
Right Side	11/2462	802.11b	0.072	0.035	-1.06	15.47	15.50	0.072	2023/7/26	
Top Side	11/2462	802.11b	0.081	0.042	-1.87	15.47	15.50	0.082	2023/7/26	

NOTE: Hotspot SAR test results of WLAN2.4G

## 10.2. Simultaneous Transmission Analysis

Per KDB 447498 D01, simultaneous transmission SAR is compliant if,

- 1) Scalar SAR summation < 1.6W/kg.
- 2)  $SPLSR = (SAR_1 + SAR_2)^{1.5} / (\text{min. separation distance, mm})$ , and the peak separation distance is determined from the square root of  $[(x_1-x_2)^2 + (y_1-y_2)^2 + (z_1-z_2)^2]$ , where  $(x_1, y_1, z_1)$  and  $(x_2, y_2, z_2)$  are the coordinates of the extrapolated peak SAR locations in the zoom scan. If  $SPLSR \leq 0.04$ , simultaneously transmission SAR measurement is not necessary.

Test Position		Scaled SAR <sub>MAX</sub>		$\Sigma$ 1-g SAR (W/Kg)	SPLSR	Remark
		WWAN	DTS			
Head	Left Cheek	0.699	0.416	1.115	N/A	N/A
	Left Tilt 15 Degree	0.357	0.233	0.590	N/A	N/A
	Right Cheek	0.622	0.382	1.004	N/A	N/A
	Right Tilt 15 Degree	0.294	0.204	0.498	N/A	N/A
Body-Worn	Front Side	0.702	0.169	0.871	N/A	N/A
	Back Side	1.190	0.240	1.430	N/A	N/A
Hotspot	Front Side	0.702	0.169	0.871	N/A	N/A
	Back Side	1.190	0.240	1.430	N/A	N/A
	Left Side	0.361	N/A	0.361	N/A	N/A
	Right Side	0.348	0.072	0.420	N/A	N/A
	Top Side	N/A	0.082	0.082	N/A	N/A
	Bottom Side	0.579	N/A	0.579	N/A	N/A

Test Position		Scaled SAR <sub>MAX</sub>		$\Sigma$ 1-g SAR (W/Kg)	SPLSR	Remark
		WWAN	DSS			
Head	Left Cheek	0.699	0.167	0.866	N/A	N/A

	Left Tilt 15 Degree	0.357	0.167	0.524	N/A	N/A
	Right Cheek	0.622	0.167	0.789	N/A	N/A
	Right Tilt 15 Degree	0.294	0.167	0.461	N/A	N/A
Body-Worn	Front Side	0.702	0.083	0.785	N/A	N/A
	Back Side	1.190	0.083	1.273	N/A	N/A
Hotspot	Front Side	0.702	0.083	0.785	N/A	N/A
	Back Side	1.190	0.083	1.273	N/A	N/A
	Left Side	0.361	N/A	0.361	N/A	N/A
	Right Side	0.348	0.083	0.431	N/A	N/A
	Top Side	N/A	0.083	0.083	N/A	N/A
	Bottom Side	0.579	N/A	0.579	N/A	N/A

## 11. Appendix A. Photo documentation

Refer to appendix Test Setup photo---SAR

## 12. Appendix B. System Check Plots

Table of contents
<b>MEASUREMENT 1 System Performance Check - 750MHz</b>
<b>MEASUREMENT 2 System Performance Check - 835MHz</b>
<b>MEASUREMENT 3 System Performance Check - 1800MHz</b>
<b>MEASUREMENT 4 System Performance Check - 1900MHz</b>
<b>MEASUREMENT 5 System Performance Check - 2450MHz</b>
<b>MEASUREMENT 6 System Performance Check - 2600MHz</b>

# MEASUREMENT 1

Date of measurement: 14/7/2023

## A. Experimental conditions.

<b>Area Scan</b>	<u>dx=15mm dy=15mm, h= 5.00 mm</u>
<b>ZoomScan</b>	<u>5x5x7,dx=8mm dy=8mm dz=5mm</u>
<b>Phantom</b>	<u>Validation plane</u>
<b>Device Position</b>	<u>Dipole</u>
<b>Band</b>	<u>CW750</u>
<b>Channels</b>	<u>Middle</u>
<b>Signal</b>	<u>CW (Crest factor: 1.0)</u>
<b>ConvF</b>	<u>1.49</u>

## B. SAR Measurement Results

<b>Frequency (MHz)</b>	750.000000
<b>Relative permittivity (real part)</b>	40.082234
<b>Relative permittivity (imaginary part)</b>	21.565670
<b>Conductivity (S/m)</b>	0.898570
<b>Variation (%)</b>	2.170000

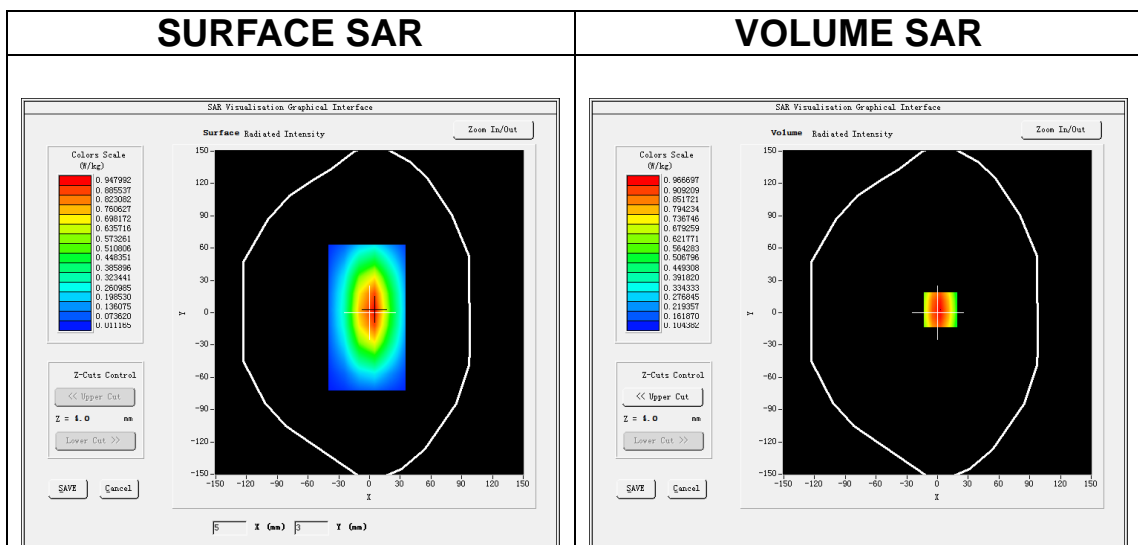

**Maximum location: X=3.00, Y=3.00**

**SAR Peak: 1.30 W/kg**

<b>SAR 10g (W/Kg)</b>	0.600171
<b>SAR 1g (W/Kg)</b>	0.792104

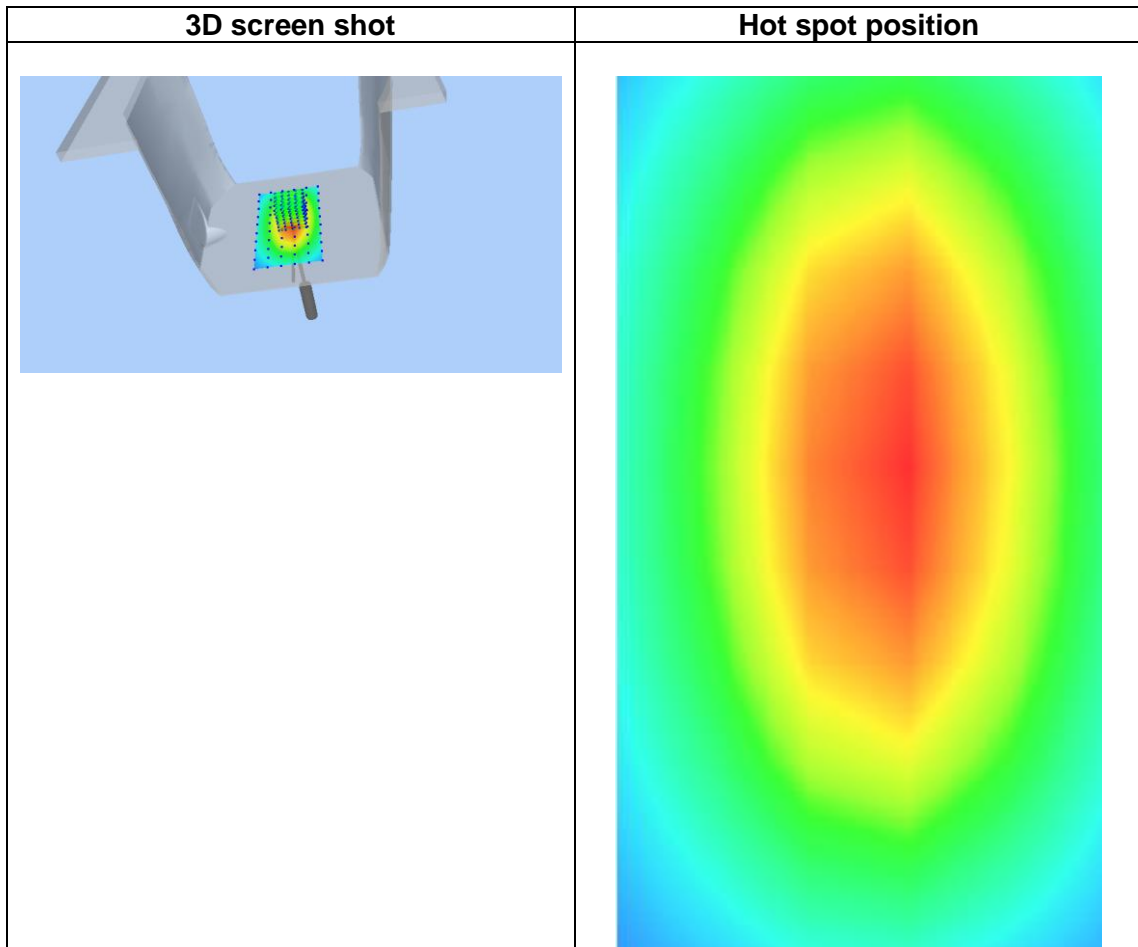
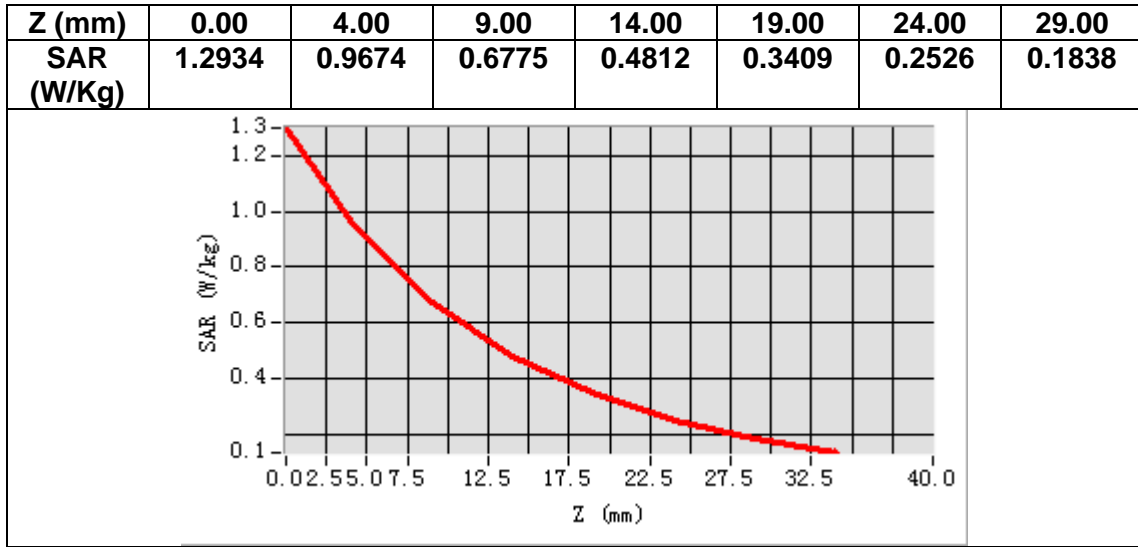

# MEASUREMENT 2

Date of measurement: 21/7/2023

## A. Experimental conditions.

<b>Area Scan</b>	<u>dx=15mm dy=15mm, h= 5.00 mm</u>
<b>ZoomScan</b>	<u>5x5x7, dx=8mm dy=8mm dz=5mm</u>
<b>Phantom</b>	<u>Validation plane</u>
<b>Device Position</b>	<u>Dipole</u>
<b>Band</b>	<u>CW835</u>
<b>Channels</b>	<u>Middle</u>
<b>Signal</b>	<u>CW (Crest factor: 1.0)</u>
<b>ConvF</b>	<u>1.50</u>

## B. SAR Measurement Results

<b>Frequency (MHz)</b>	835.000000
<b>Relative permittivity (real part)</b>	40.470470
<b>Relative permittivity (imaginary part)</b>	19.750009
<b>Conductivity (S/m)</b>	0.916181
<b>Variation (%)</b>	-0.380000

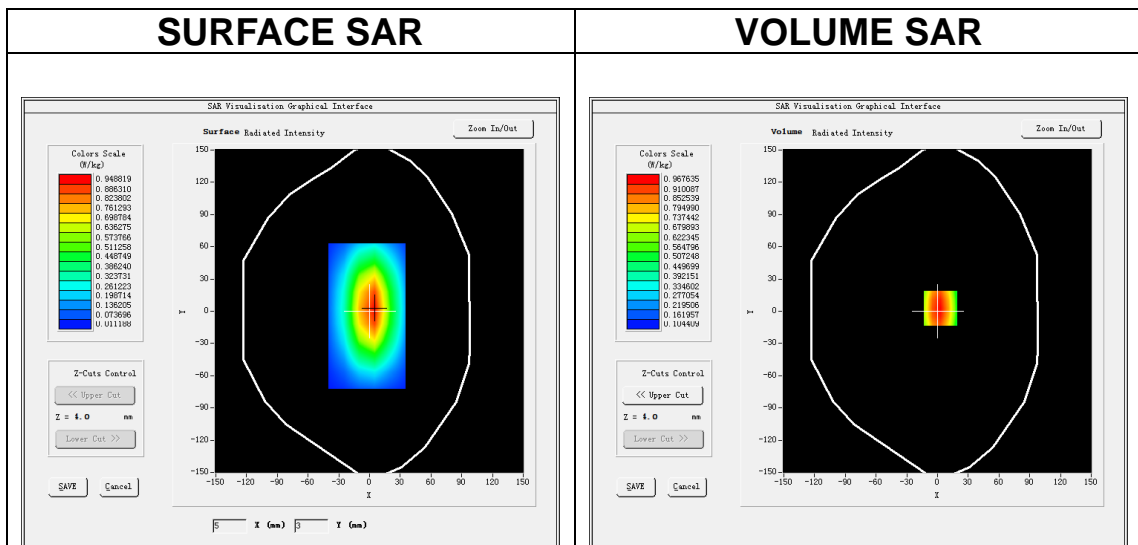

**Maximum location: X=3.00, Y=3.00**  
**SAR Peak: 1.30 W/kg**

<b>SAR 10g (W/Kg)</b>	0.607257
<b>SAR 1g (W/Kg)</b>	0.907267

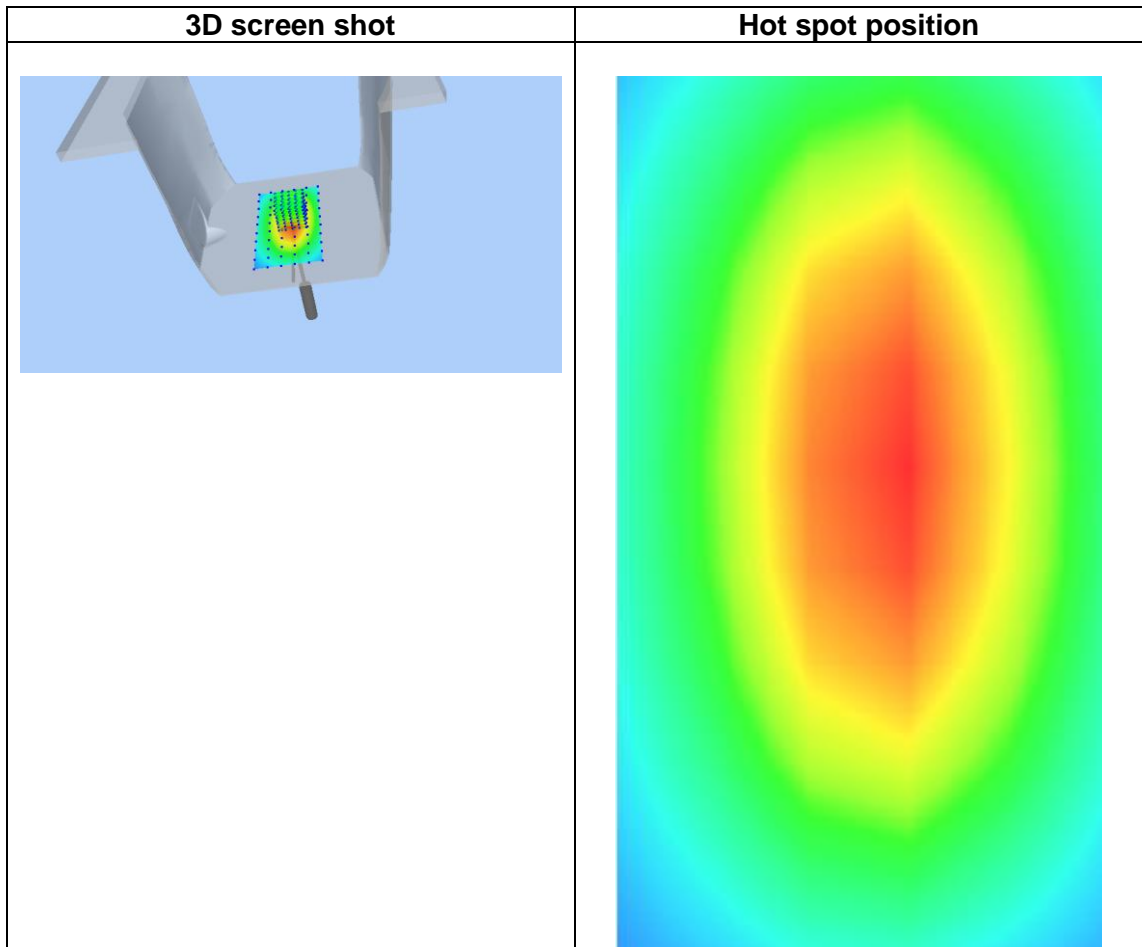
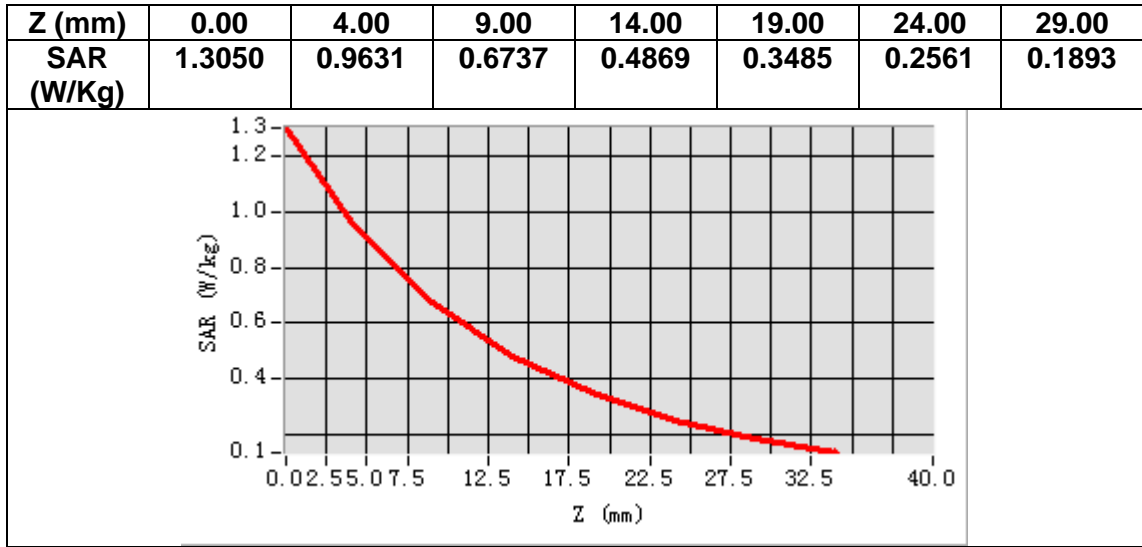



# MEASUREMENT 3

Date of measurement: 18/7/2023

## A. Experimental conditions.

<b>Area Scan</b>	<u>dx=15mm dy=15mm, h= 5.00 mm</u>
<b>ZoomScan</b>	<u>5x5x7, dx=8mm dy=8mm dz=5mm</u>
<b>Phantom</b>	<u>Validation plane</u>
<b>Device Position</b>	<u>Dipole</u>
<b>Band</b>	<u>CW1800</u>
<b>Channels</b>	<u>Middle</u>
<b>Signal</b>	<u>CW (Crest factor: 1.0)</u>
<b>ConvF</b>	<u>1.73</u>

## B. SAR Measurement Results

<b>Frequency (MHz)</b>	1800.000000
<b>Relative permittivity (real part)</b>	38.441499
<b>Relative permittivity (imaginary part)</b>	13.574630
<b>Conductivity (S/m)</b>	1.357463
<b>Variation (%)</b>	-1.940000

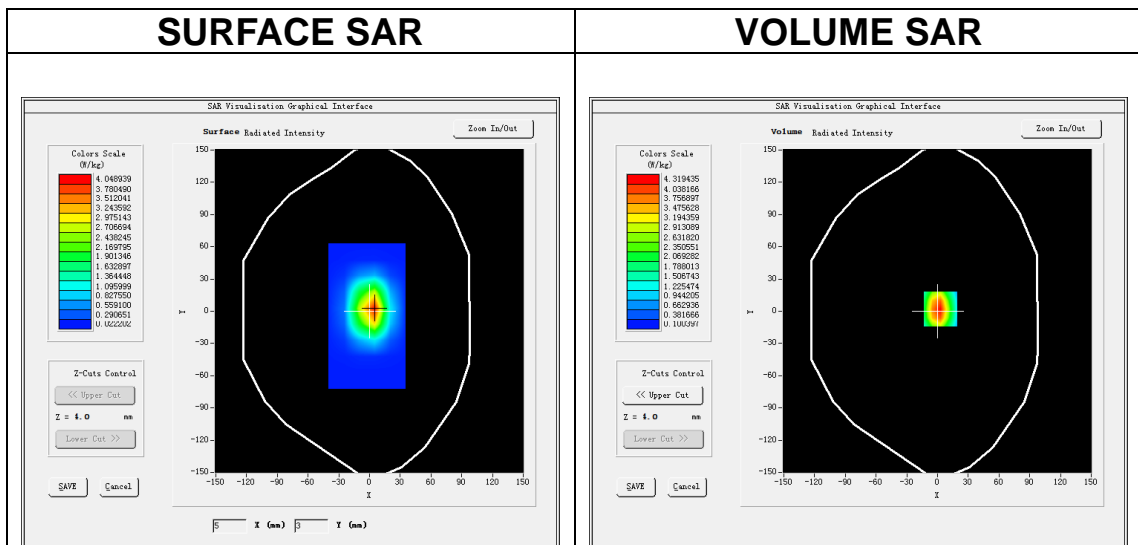

**Maximum location: X=3.00, Y=2.00**  
**SAR Peak: 6.82 W/kg**

<b>SAR 10g (W/Kg)</b>	1.936013
<b>SAR 1g (W/Kg)</b>	3.574067

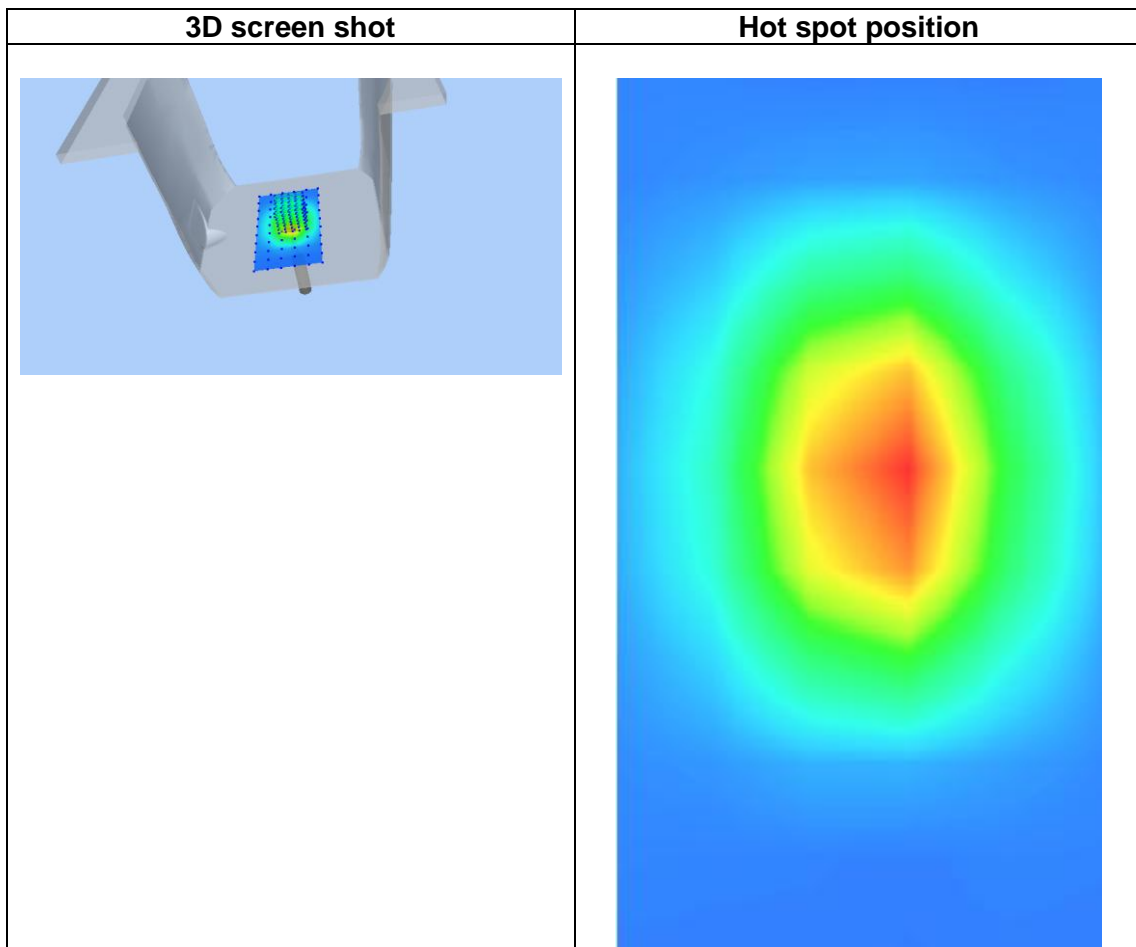
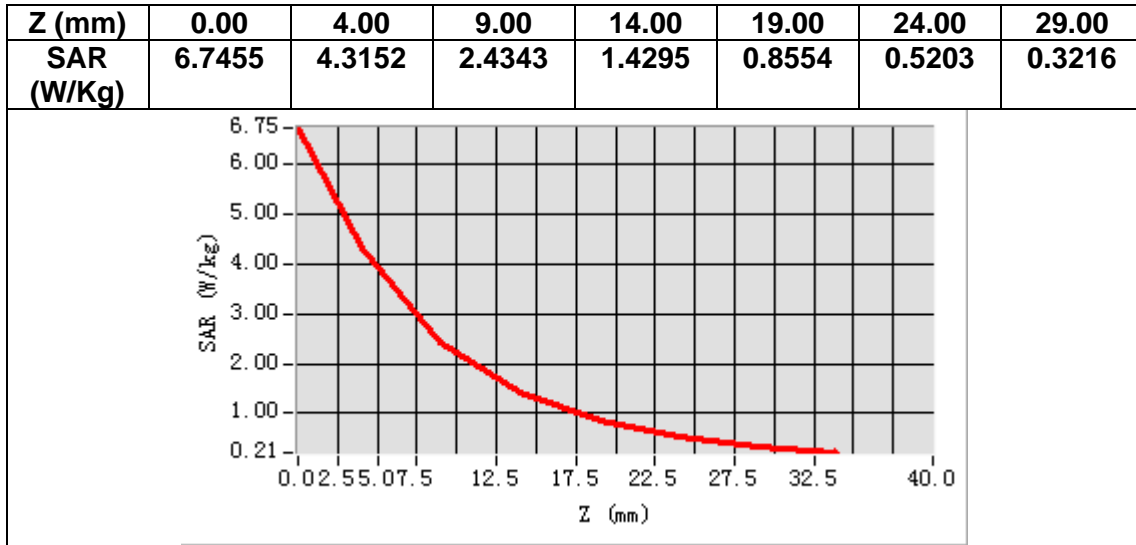

# MEASUREMENT 4

Date of measurement: 19/7/2023

## A. Experimental conditions.

<b>Area Scan</b>	<u>dx=15mm dy=15mm, h= 5.00 mm</u>
<b>ZoomScan</b>	<u>5x5x7, dx=8mm dy=8mm dz=5mm</u>
<b>Phantom</b>	<u>Validation plane</u>
<b>Device Position</b>	<u>Dipole</u>
<b>Band</b>	<u>CW1900</u>
<b>Channels</b>	<u>Middle</u>
<b>Signal</b>	<u>CW (Crest factor: 1.0)</u>
<b>ConvF</b>	<u>1.91</u>

## B. SAR Measurement Results

<b>Frequency (MHz)</b>	1900.000000
<b>Relative permittivity (real part)</b>	38.491595
<b>Relative permittivity (imaginary part)</b>	13.559062
<b>Conductivity (S/m)</b>	1.431234
<b>Variation (%)</b>	-0.480000

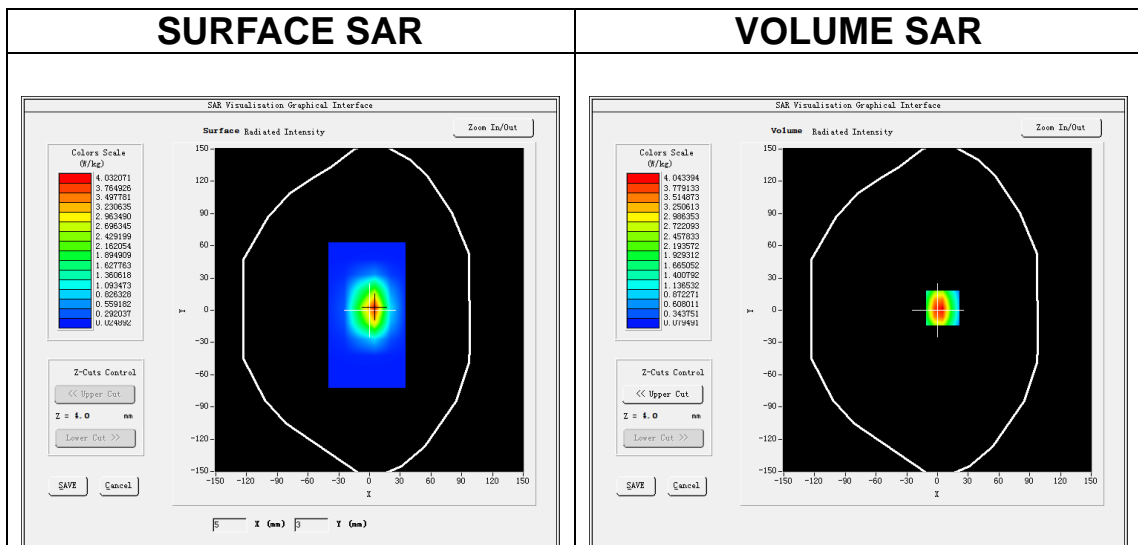

**Maximum location: X=5.00, Y=2.00**

**SAR Peak: 6.70 W/kg**

<b>SAR 10g (W/Kg)</b>	2.182344
<b>SAR 1g (W/Kg)</b>	4.268128

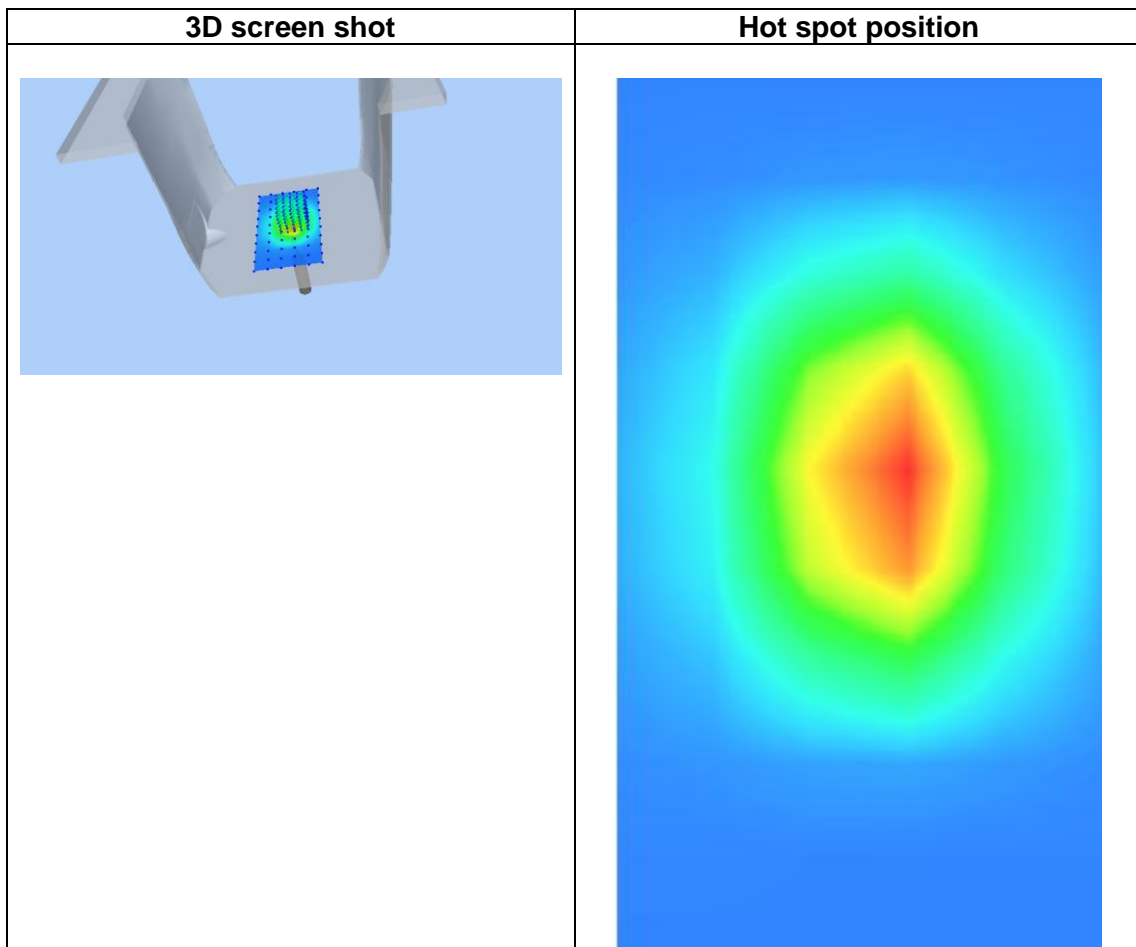
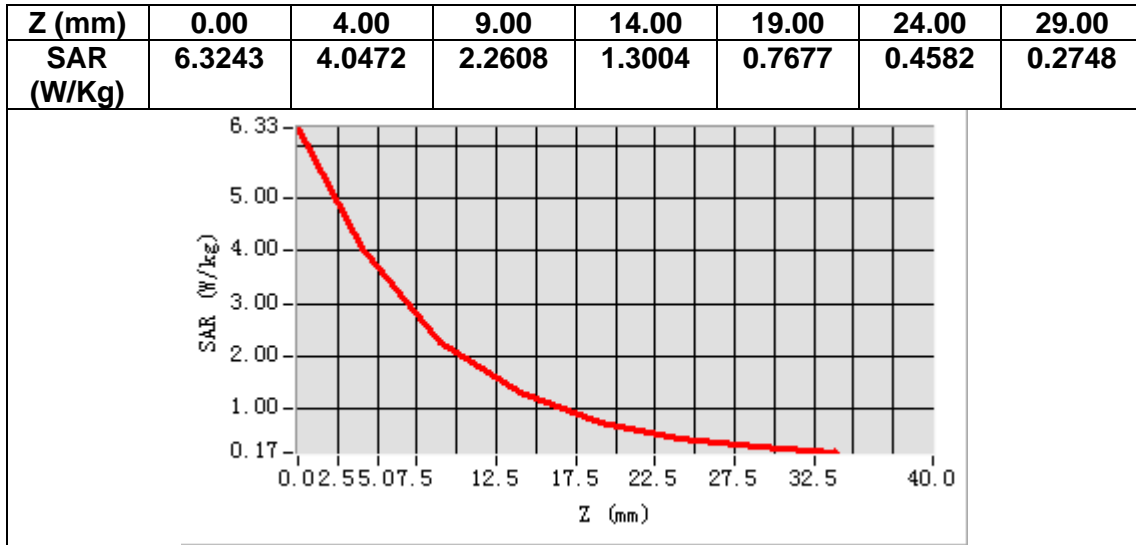

# MEASUREMENT 5

Date of measurement: 26/7/2023

## A. Experimental conditions.

<b>Area Scan</b>	<u>dx=12mm dy=12mm, h= 5.00 mm</u>
<b>ZoomScan</b>	<u>7x7x7, dx=5mm dy=5mm dz=5mm</u>
<b>Phantom</b>	<u>Validation plane</u>
<b>Device Position</b>	<u>Dipole</u>
<b>Band</b>	<u>CW2450</u>
<b>Channels</b>	<u>Middle</u>
<b>Signal</b>	<u>CW (Crest factor: 1.0)</u>
<b>ConvF</b>	<u>1.98</u>

## B. SAR Measurement Results

<b>Frequency (MHz)</b>	2450.000000
<b>Relative permittivity (real part)</b>	37.725838
<b>Relative permittivity (imaginary part)</b>	13.153547
<b>Conductivity (S/m)</b>	1.790344
<b>Variation (%)</b>	0.350000

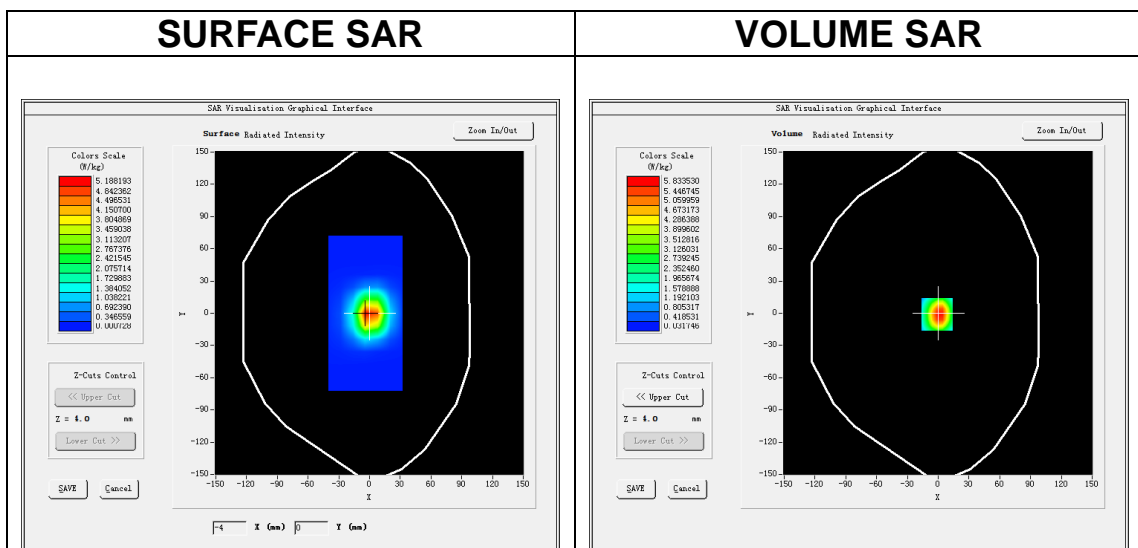

**Maximum location: X=-1.00, Y=-1.00**  
**SAR Peak: 9.83 W/kg**

<b>SAR 10g (W/Kg)</b>	2.285046
<b>SAR 1g (W/Kg)</b>	5.360065

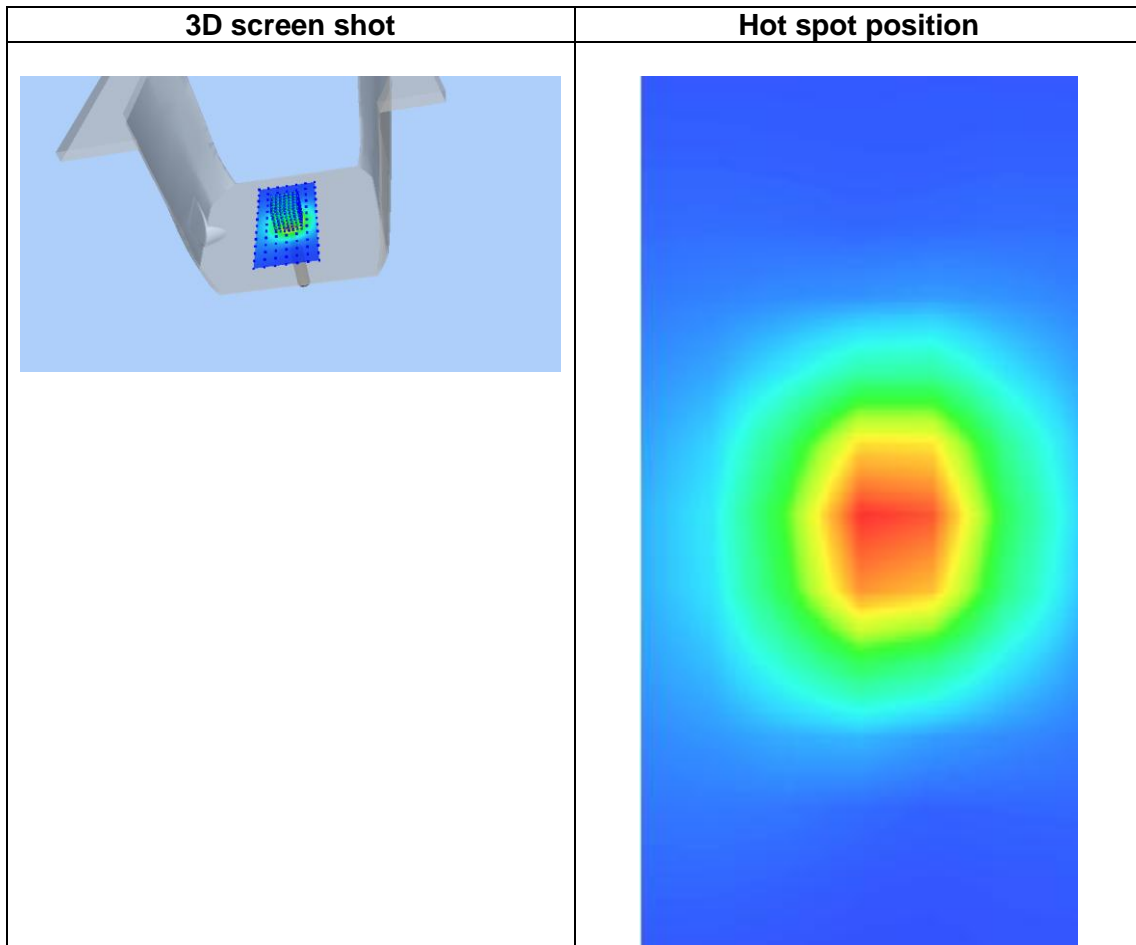
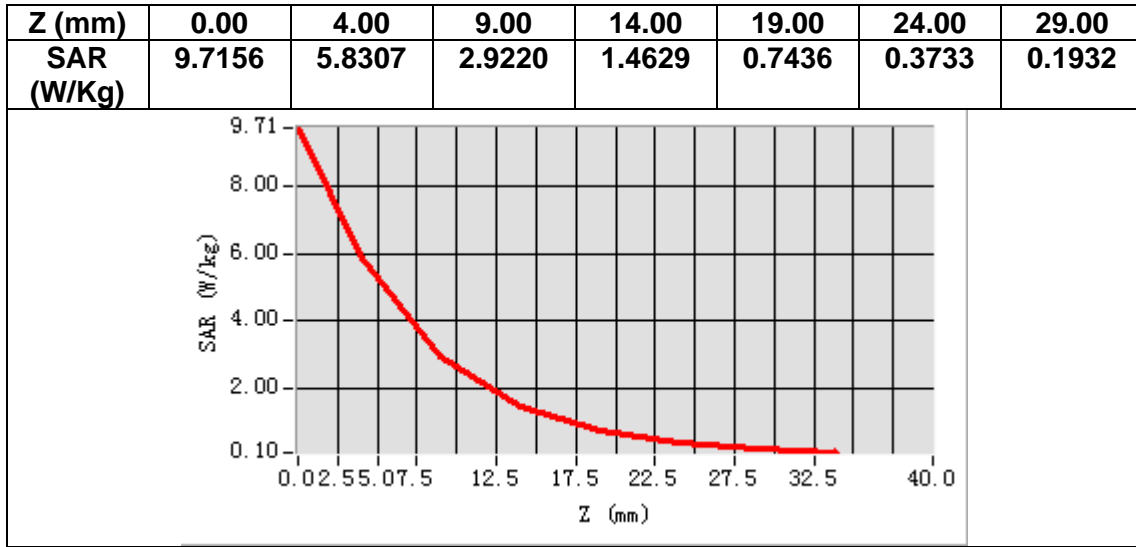

# MEASUREMENT 6

Date of measurement: 27/7/2023

## A. Experimental conditions.

<b>Area Scan</b>	<u>dx=12mm dy=12mm, h= 5.00 mm</u>
<b>ZoomScan</b>	<u>7x7x7, dx=5mm dy=5mm dz=5mm</u>
<b>Phantom</b>	<u>Validation plane</u>
<b>Device Position</b>	<u>Dipole</u>
<b>Band</b>	<u>CW2600</u>
<b>Channels</b>	<u>Middle</u>
<b>Signal</b>	<u>CW (Crest factor: 1.0)</u>
<b>ConvF</b>	<u>1.87</u>

## B. SAR Measurement Results

<b>Frequency (MHz)</b>	2600.000000
<b>Relative permittivity (real part)</b>	38.141595
<b>Relative permittivity (imaginary part)</b>	13.635535
<b>Conductivity (S/m)</b>	1.969577
<b>Variation (%)</b>	0.820000

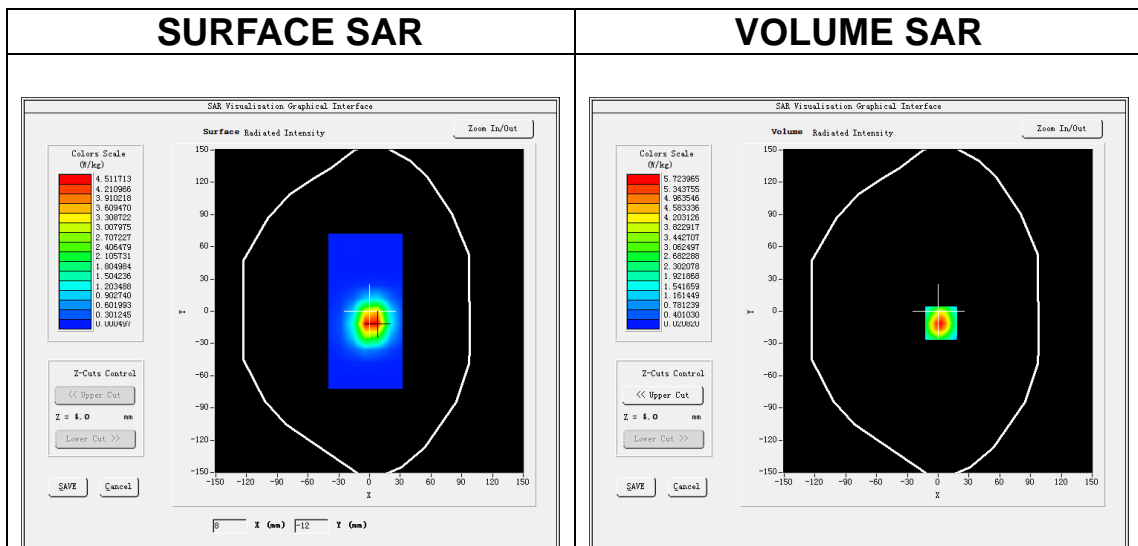

**Maximum location: X=3.00, Y=-11.00**

**SAR Peak: 10.29 W/kg**

<b>SAR 10g (W/Kg)</b>	2.634293
<b>SAR 1g (W/Kg)</b>	5.277081

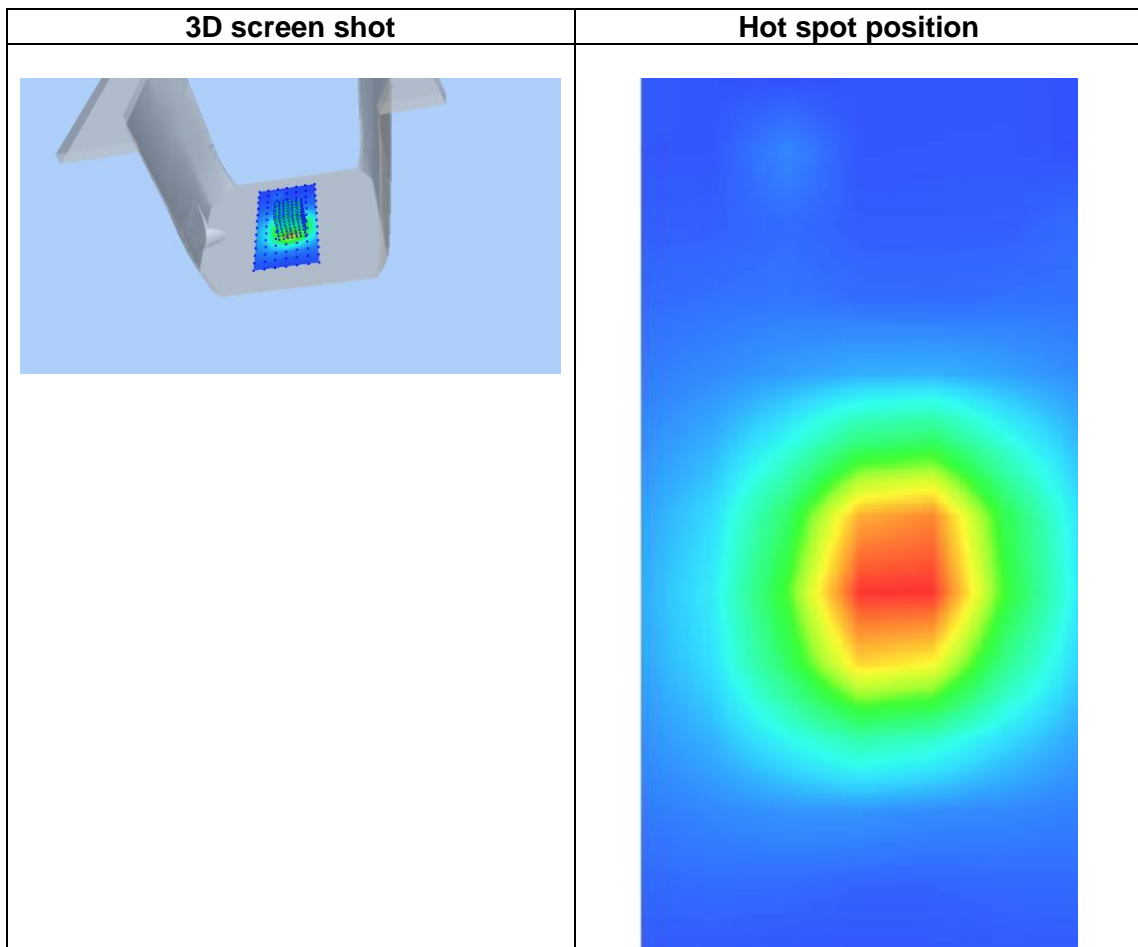
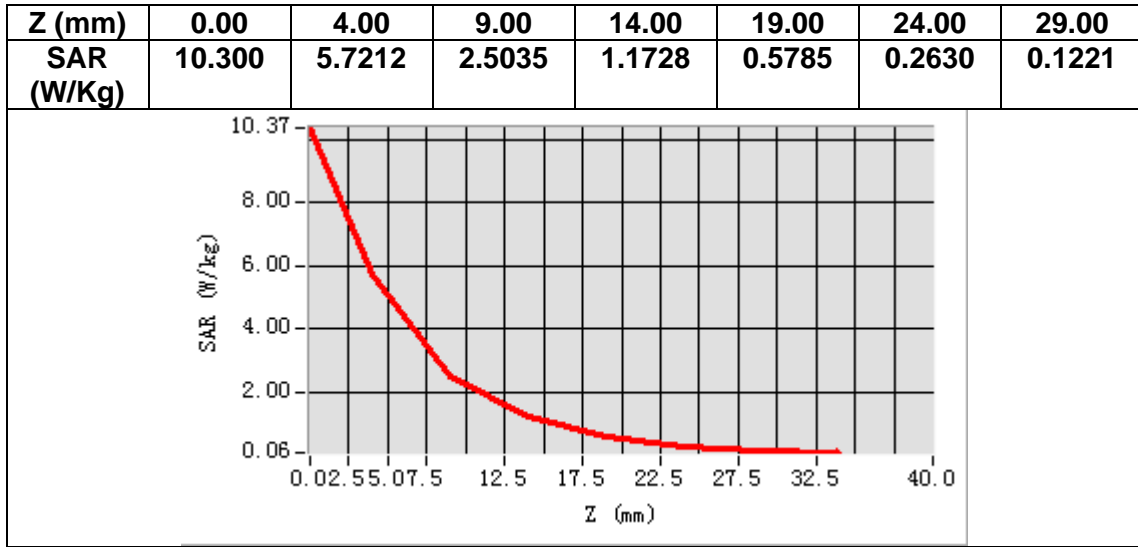



### 13. Appendix C. Plots of High SAR Measurement

<b>Table of contents</b>
<b>MEASUREMENT 1 GSM 850 Head</b>
<b>MEASUREMENT 2 GSM 850 Body</b>
<b>MEASUREMENT 3 GSM 1900 Head</b>
<b>MEASUREMENT 4 GSM 1900 Body</b>
<b>MEASUREMENT 5 WCDMA Band 2 Head</b>
<b>MEASUREMENT 6 WCDMA Band 2 Body</b>
<b>MEASUREMENT 7 WCDMA Band 4 Head</b>
<b>MEASUREMENT 8 WCDMA Band 4 Body</b>
<b>MEASUREMENT 9 WCDMA Band 5 Head</b>
<b>MEASUREMENT 10 WCDMA Band 5 Body</b>
<b>MEASUREMENT 11 WLAN 2.4G Head</b>
<b>MEASUREMENT 12 WLAN 2.4G Body</b>
<b>MEASUREMENT 13 LTE Band 2 Head</b>
<b>MEASUREMENT 14 LTE Band 2 Body</b>
<b>MEASUREMENT 15 LTE Band 4 Head</b>
<b>MEASUREMENT 16 LTE Band 4 Body</b>
<b>MEASUREMENT 17 LTE Band 5 Head</b>
<b>MEASUREMENT 18 LTE Band 5 Body</b>
<b>MEASUREMENT 19 LTE Band 7 Head</b>
<b>MEASUREMENT 20 LTE Band 7 Body</b>
<b>MEASUREMENT 21 LTE Band 13 Head</b>
<b>MEASUREMENT 22 LTE Band 13 Body</b>
<b>MEASUREMENT 23 LTE Band 66 Head</b>
<b>MEASUREMENT 24 LTE Band 66 Body</b>

# MEASUREMENT 1

Date of measurement: 21/7/2023

## A. Experimental conditions.

<b>Area Scan</b>	<u>dx=15mm dy=15mm, h= 5.00 mm</u>
<b>ZoomScan</b>	<u>5x5x7, dx=8mm dy=8mm dz=5mm</u>
<b>Phantom</b>	<u>Left head</u>
<b>Device Position</b>	<u>Cheek</u>
<b>Band</b>	<u>GSM850</u>
<b>Channels</b>	<u>Middle</u>
<b>Signal</b>	<u>TDMA (Crest factor: 4.0)</u>
<b>ConvF</b>	<u>1.50</u>

## B. SAR Measurement Results

<b>Frequency (MHz)</b>	836.400000
<b>Relative permittivity (real part)</b>	40.386131
<b>Relative permittivity (imaginary part)</b>	19.775848
<b>Conductivity (S/m)</b>	0.918918
<b>Variation (%)</b>	-0.630000

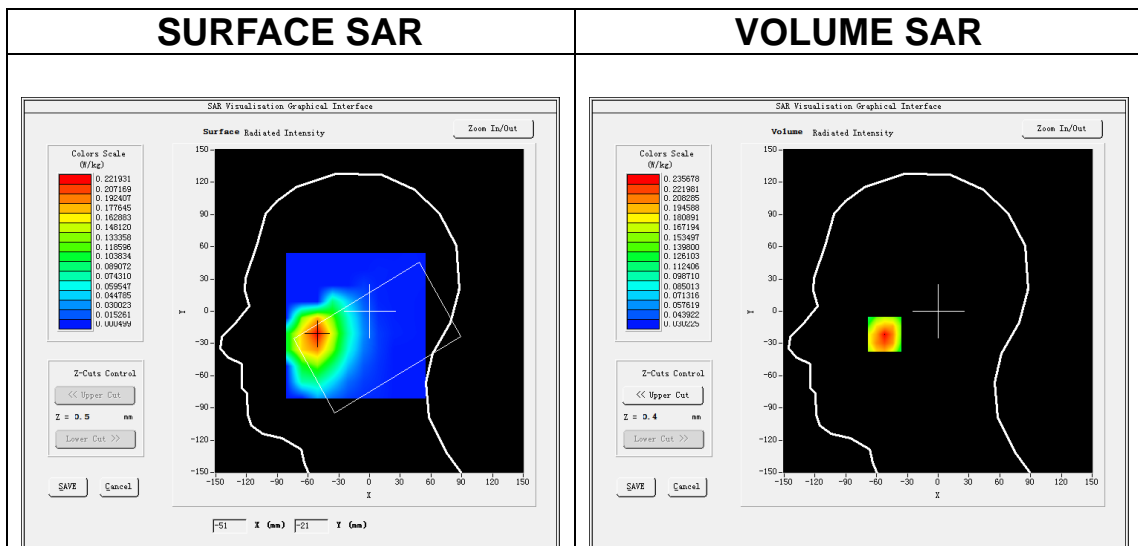

**Maximum location: X=-52.00, Y=-21.00**  
**SAR Peak: 0.29 W/kg**

<b>SAR 10g (W/Kg)</b>	0.162946
<b>SAR 1g (W/Kg)</b>	0.228086

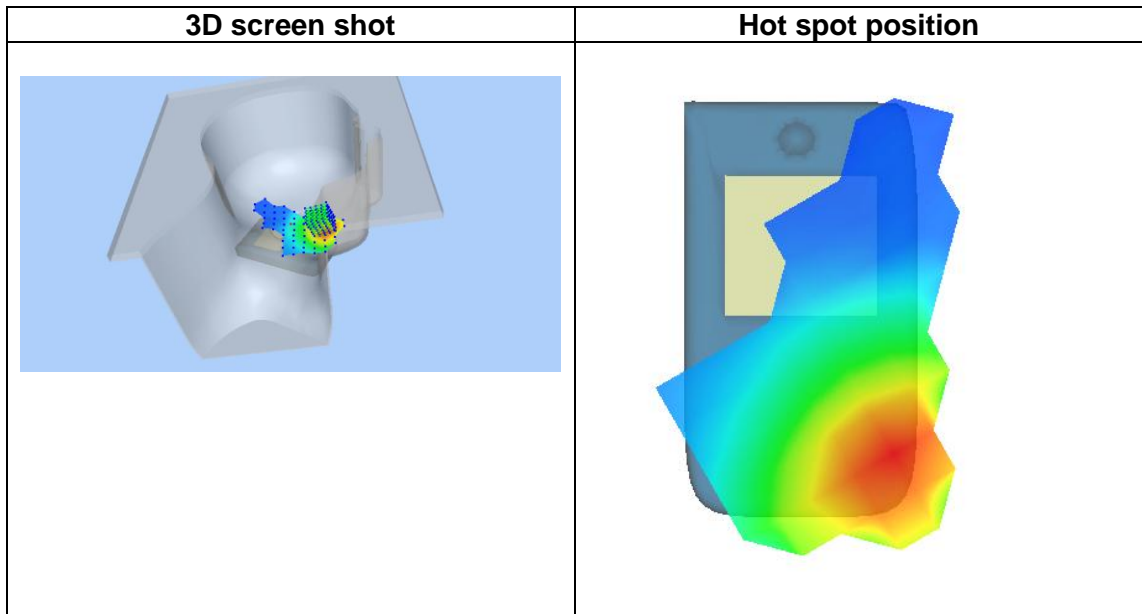
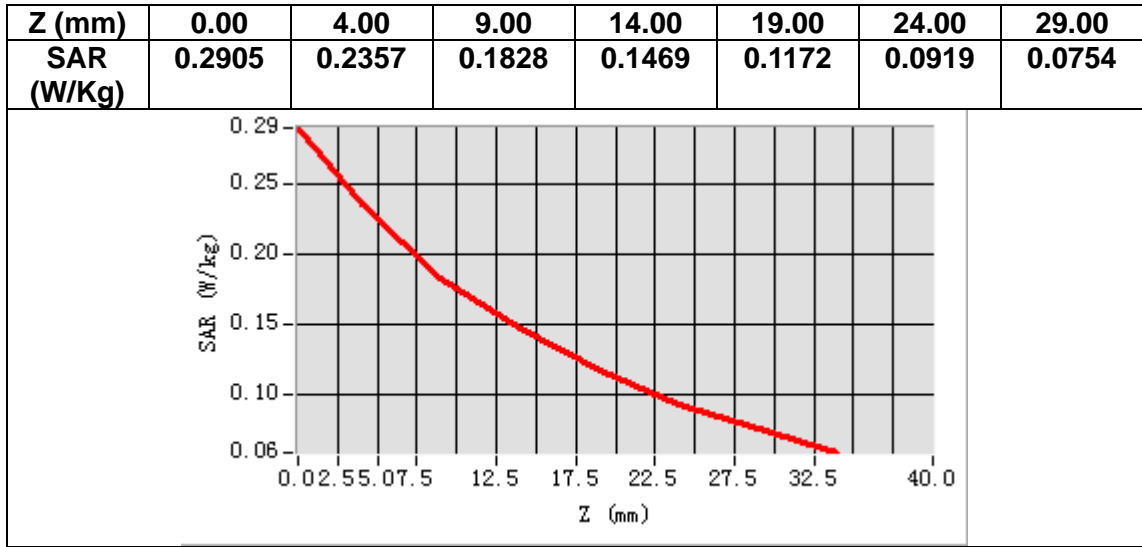

# MEASUREMENT 2

Date of measurement: 21/7/2023

## A. Experimental conditions.

<b>Area Scan</b>	<u>dx=15mm dy=15mm, h= 5.00 mm</u>
<b>ZoomScan</b>	<u>5x5x7, dx=8mm dy=8mm dz=5mm</u>
<b>Phantom</b>	<u>Validation plane</u>
<b>Device Position</b>	<u>Body</u>
<b>Band</b>	<u>GSM850</u>
<b>Channels</b>	<u>Middle</u>
<b>Signal</b>	<u>TDMA (Crest factor: 4.0)</u>
<b>ConvF</b>	<u>1.50</u>

## B. SAR Measurement Results

<b>Frequency (MHz)</b>	836.400000
<b>Relative permittivity (real part)</b>	40.386131
<b>Relative permittivity (imaginary part)</b>	19.775848
<b>Conductivity (S/m)</b>	0.918918
<b>Variation (%)</b>	-1.700000

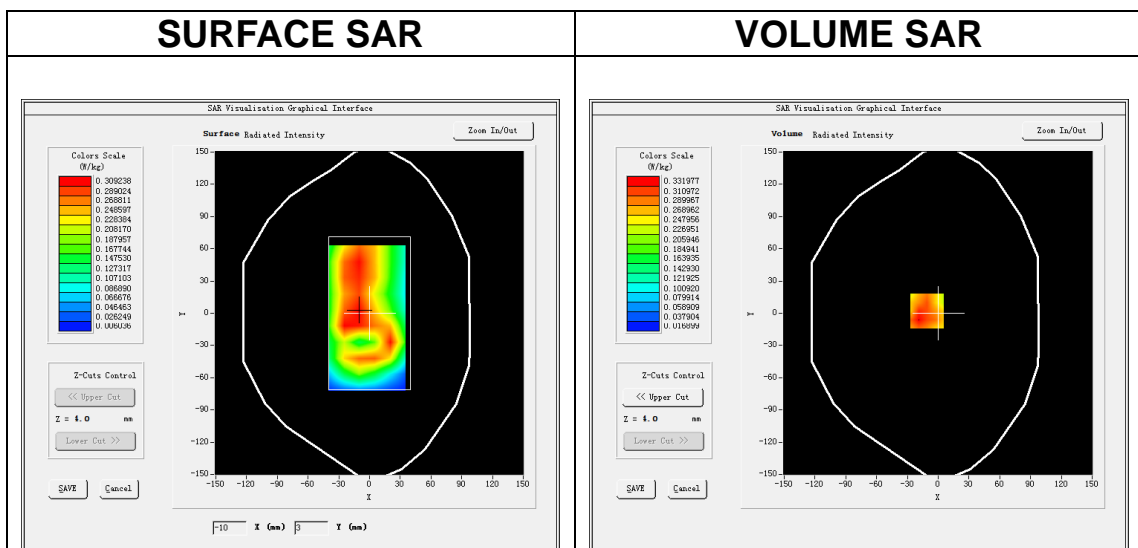

**Maximum location: X=-11.00, Y=2.00**  
**SAR Peak: 0.43 W/kg**

<b>SAR 10g (W/Kg)</b>	0.223041
<b>SAR 1g (W/Kg)</b>	0.323457

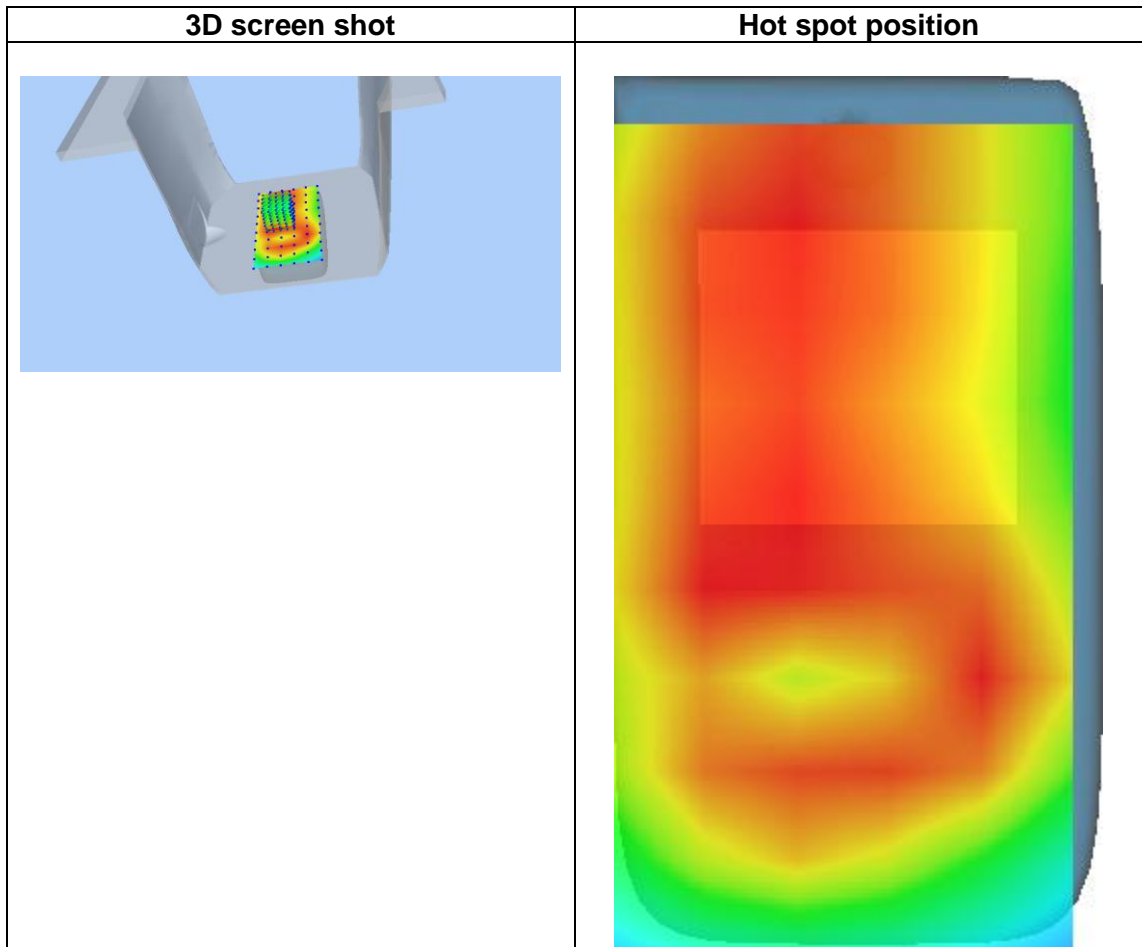
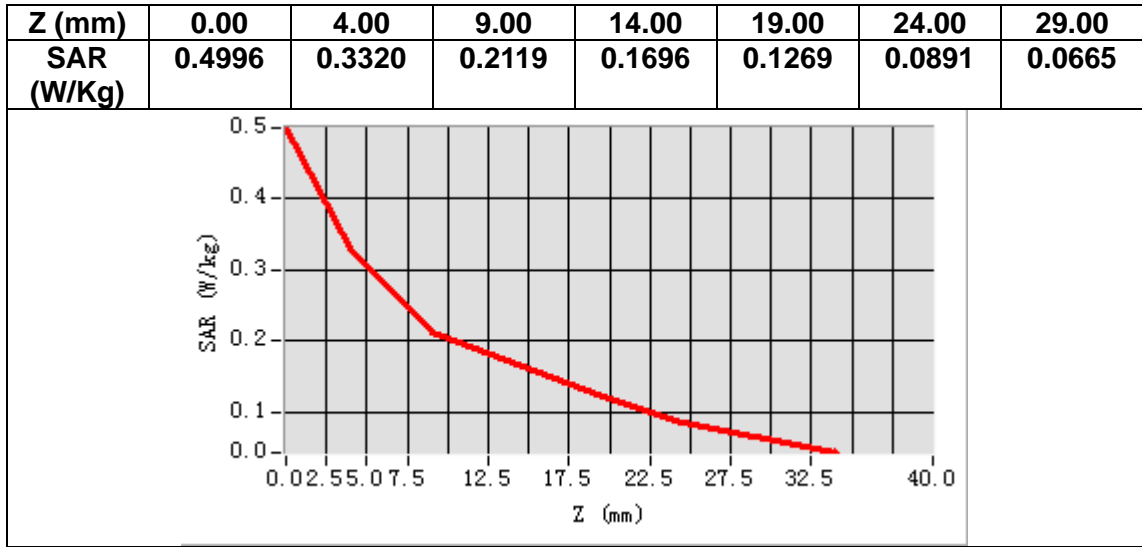

# MEASUREMENT 3

Date of measurement: 19/7/2023

## A. Experimental conditions.

<b>Area Scan</b>	<u>dx=15mm dy=15mm, h= 5.00 mm</u>
<b>ZoomScan</b>	<u>5x5x7,dx=8mm dy=8mm dz=5mm</u>
<b>Phantom</b>	<u>Left head</u>
<b>Device Position</b>	<u>Cheek</u>
<b>Band</b>	<u>GSM1900</u>
<b>Channels</b>	<u>Middle</u>
<b>Signal</b>	<u>TDMA (Crest factor: 2.7)</u>
<b>ConvF</b>	<u>1.91</u>

## B. SAR Measurement Results

<b>Frequency (MHz)</b>	1880.000000
<b>Relative permittivity (real part)</b>	38.577995
<b>Relative permittivity (imaginary part)</b>	14.012720
<b>Conductivity (S/m)</b>	1.463551
<b>Variation (%)</b>	0.200000

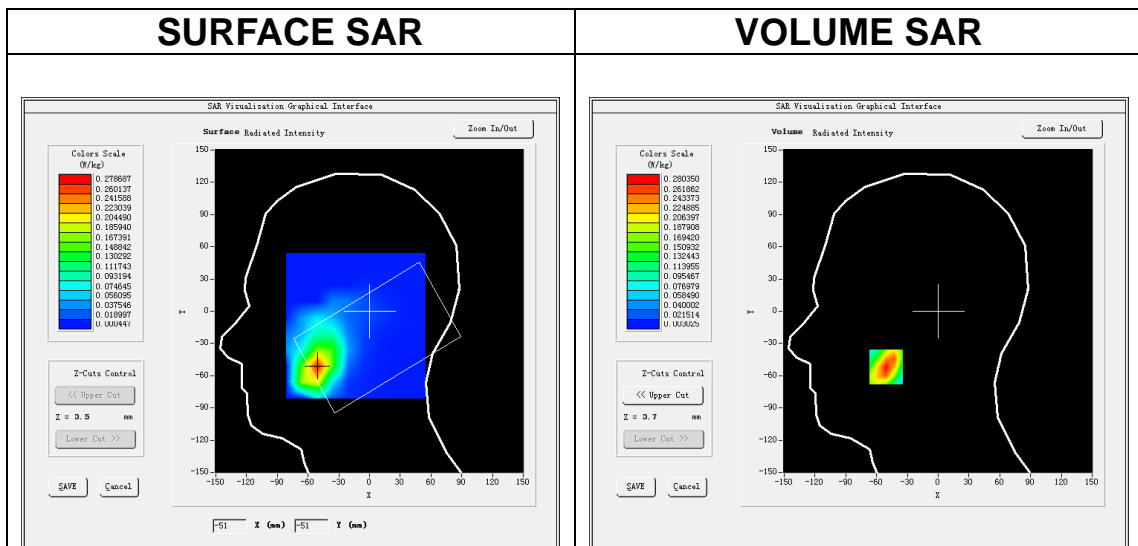

**Maximum location: X=-51.00, Y=-52.00**  
**SAR Peak: 0.42 W/kg**

<b>SAR 10g (W/Kg)</b>	0.151535
<b>SAR 1g (W/Kg)</b>	0.272306

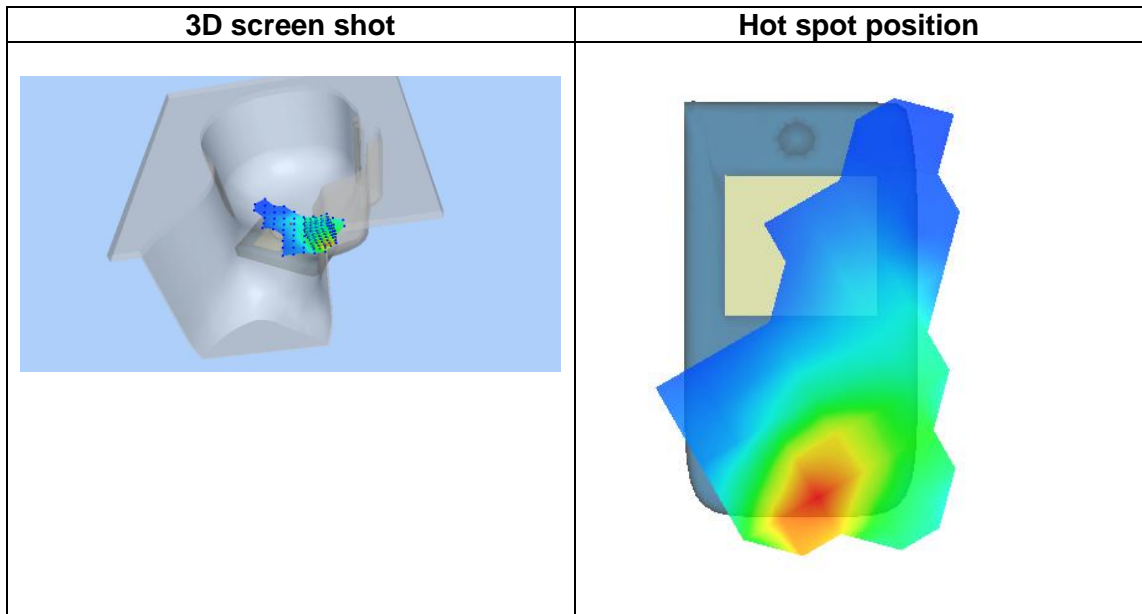
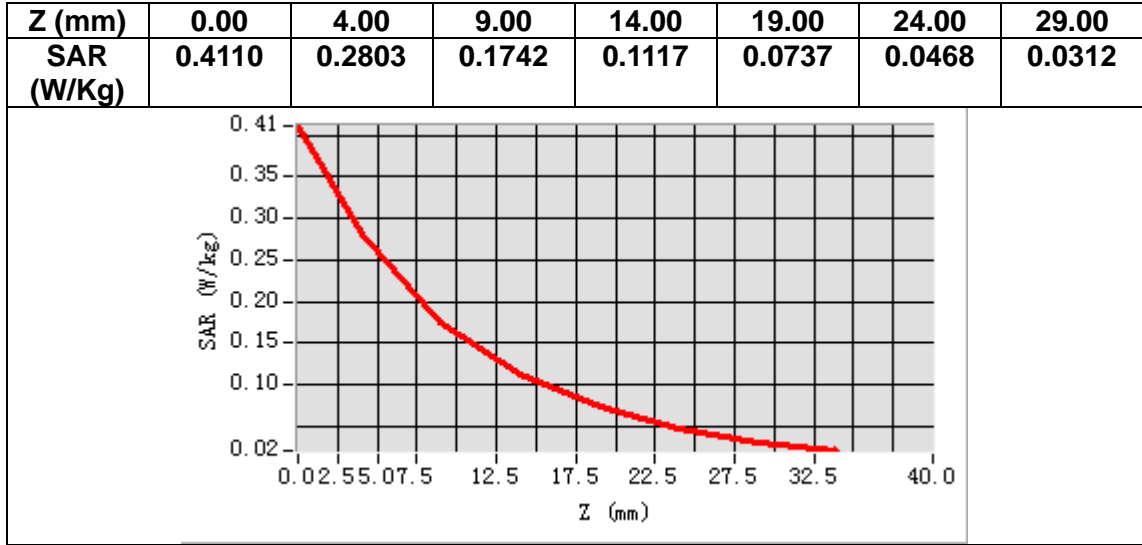

# MEASUREMENT 4

Date of measurement: 19/7/2023

## A. Experimental conditions.

<b>Area Scan</b>	<u>dx=15mm dy=15mm, h= 5.00 mm</u>
<b>ZoomScan</b>	<u>5x5x7, dx=8mm dy=8mm dz=5mm</u>
<b>Phantom</b>	<u>Validation plane</u>
<b>Device Position</b>	<u>Body</u>
<b>Band</b>	<u>GSM1900</u>
<b>Channels</b>	<u>Middle</u>
<b>Signal</b>	<u>TDMA (Crest factor: 2.7)</u>
<b>ConvF</b>	<u>1.91</u>

## B. SAR Measurement Results

<b>Frequency (MHz)</b>	1880.000000
<b>Relative permittivity (real part)</b>	38.577995
<b>Relative permittivity (imaginary part)</b>	14.012720
<b>Conductivity (S/m)</b>	1.463551
<b>Variation (%)</b>	-2.540000

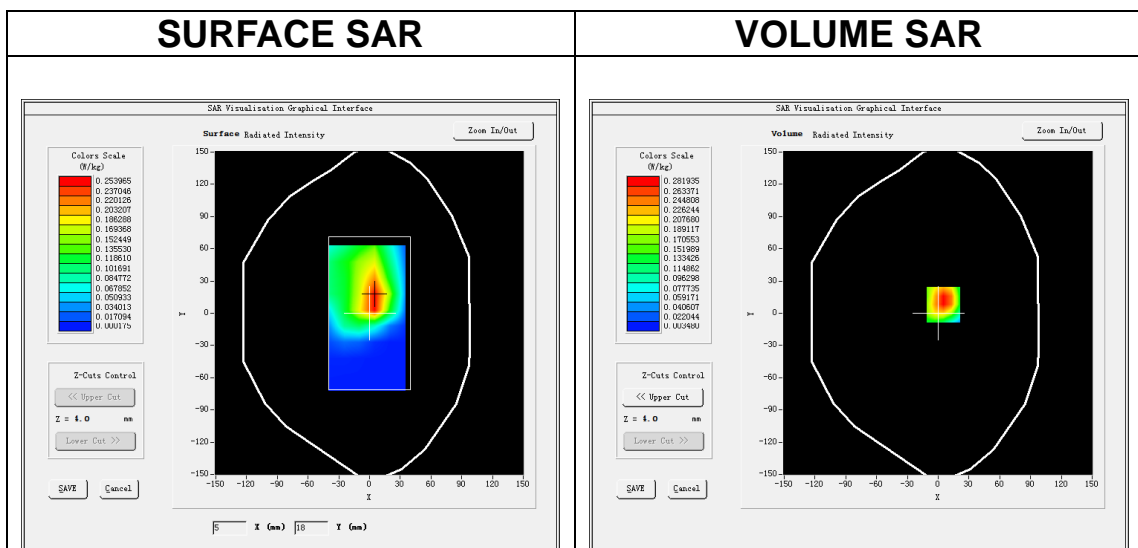

**Maximum location: X=5.00, Y=8.00**  
**SAR Peak: 0.47 W/kg**

<b>SAR 10g (W/Kg)</b>	0.151047
<b>SAR 1g (W/Kg)</b>	0.284650



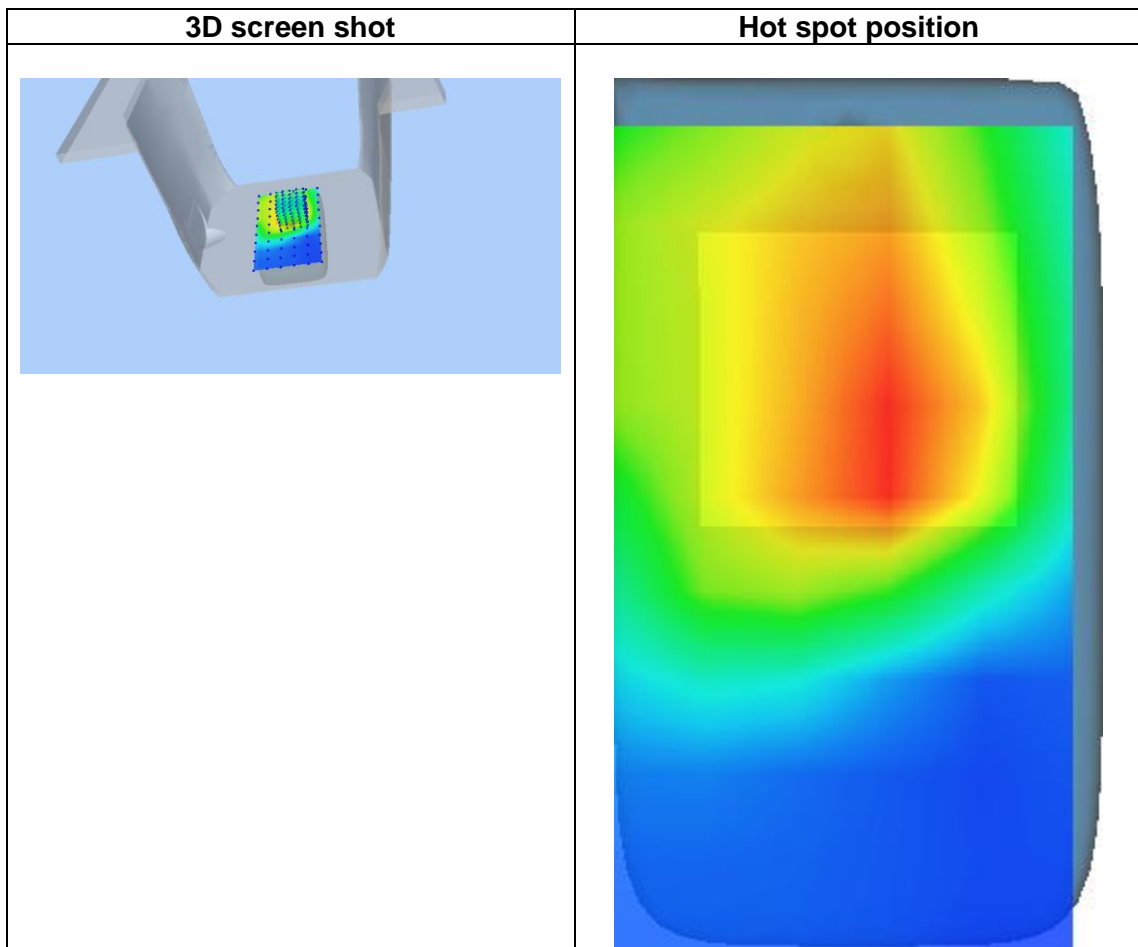
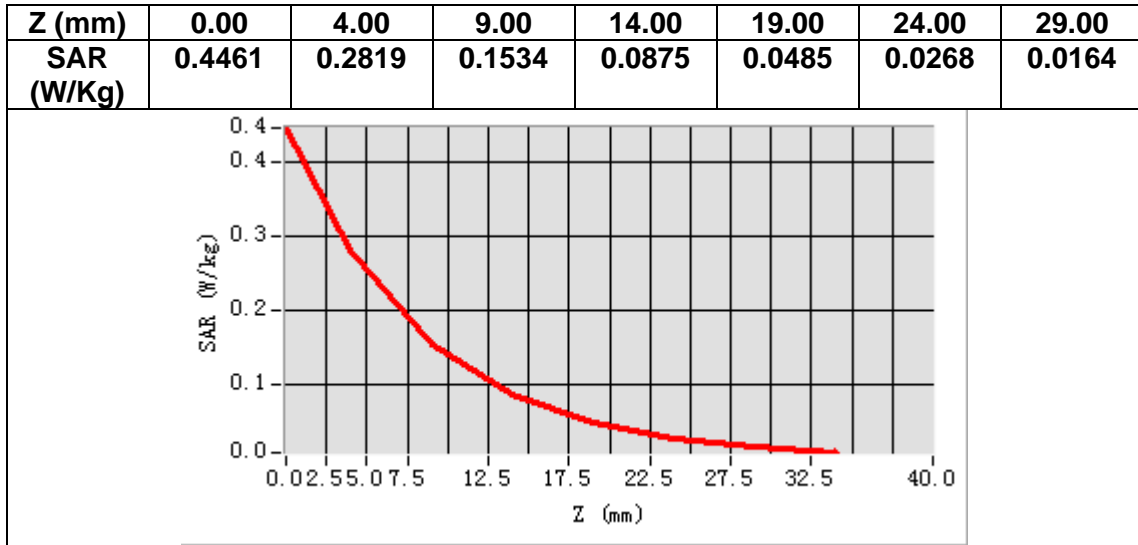

# MEASUREMENT 5

Date of measurement: 19/7/2023

## A. Experimental conditions.

<b>Area Scan</b>	<u>dx=15mm dy=15mm, h= 5.00 mm</u>
<b>ZoomScan</b>	<u>5x5x7, dx=8mm dy=8mm dz=5mm</u>
<b>Phantom</b>	<u>Left head</u>
<b>Device Position</b>	<u>Cheek</u>
<b>Band</b>	<u>Band2 WCDMA1900</u>
<b>Channels</b>	<u>Middle</u>
<b>Signal</b>	<u>WCDMA (Crest factor: 1.0)</u>
<b>ConvF</b>	<u>1.91</u>

## B. SAR Measurement Results

<b>Frequency (MHz)</b>	1880.000000
<b>Relative permittivity (real part)</b>	38.577995
<b>Relative permittivity (imaginary part)</b>	14.012720
<b>Conductivity (S/m)</b>	1.463551
<b>Variation (%)</b>	-0.100000

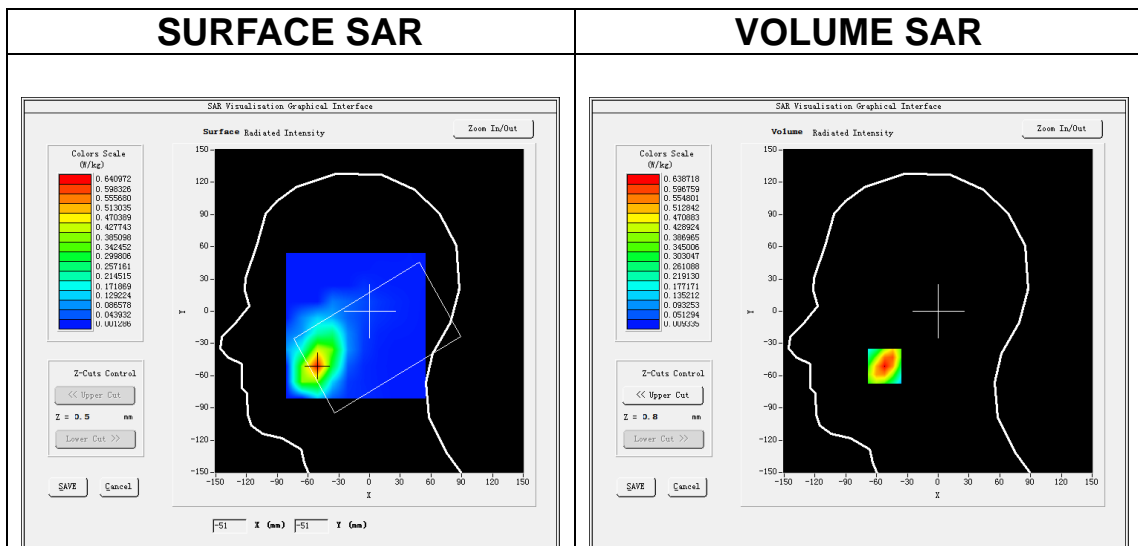

**Maximum location: X=-52.00, Y=-51.00**  
**SAR Peak: 0.91 W/kg**

<b>SAR 10g (W/Kg)</b>	0.352412
<b>SAR 1g (W/Kg)</b>	0.619894

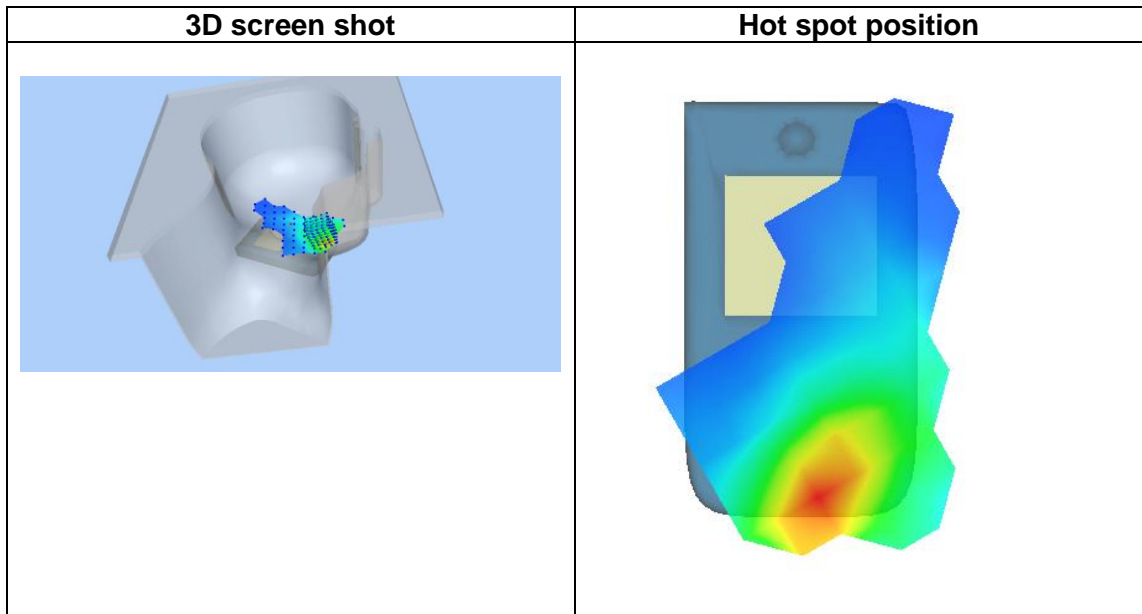
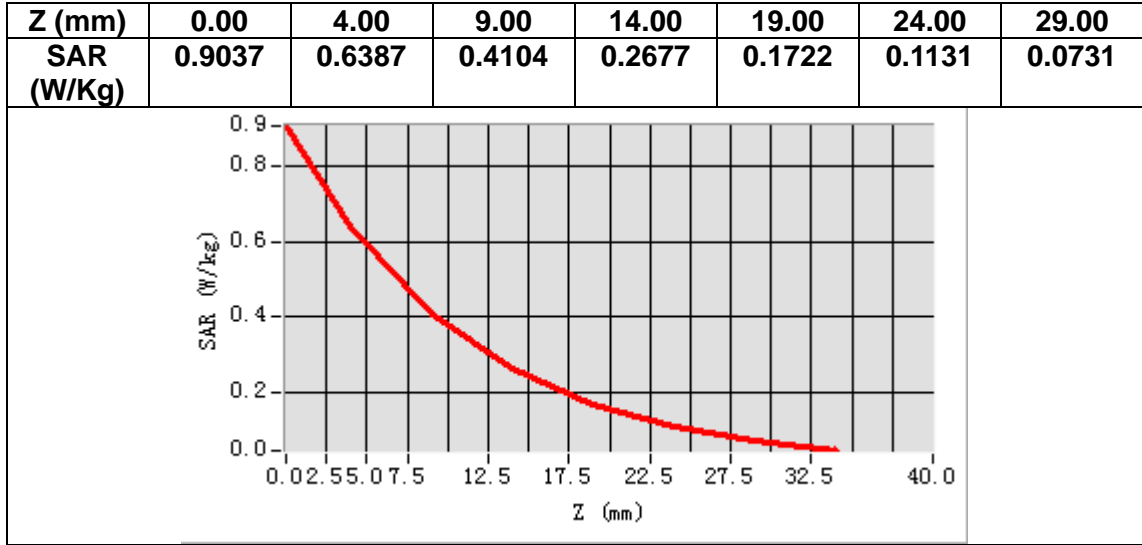

# MEASUREMENT 6

Date of measurement: 19/7/2023

## A. Experimental conditions.

<b>Area Scan</b>	<u>dx=15mm dy=15mm, h= 5.00 mm</u>
<b>ZoomScan</b>	<u>5x5x7, dx=8mm dy=8mm dz=5mm</u>
<b>Phantom</b>	<u>Validation plane</u>
<b>Device Position</b>	<u>Body</u>
<b>Band</b>	<u>Band2 WCDMA1900</u>
<b>Channels</b>	<u>Middle</u>
<b>Signal</b>	<u>WCDMA (Crest factor: 1.0)</u>
<b>ConvF</b>	<u>1.91</u>

## B. SAR Measurement Results

<b>Frequency (MHz)</b>	1880.000000
<b>Relative permittivity (real part)</b>	38.577995
<b>Relative permittivity (imaginary part)</b>	14.012720
<b>Conductivity (S/m)</b>	1.463551
<b>Variation (%)</b>	-0.060000

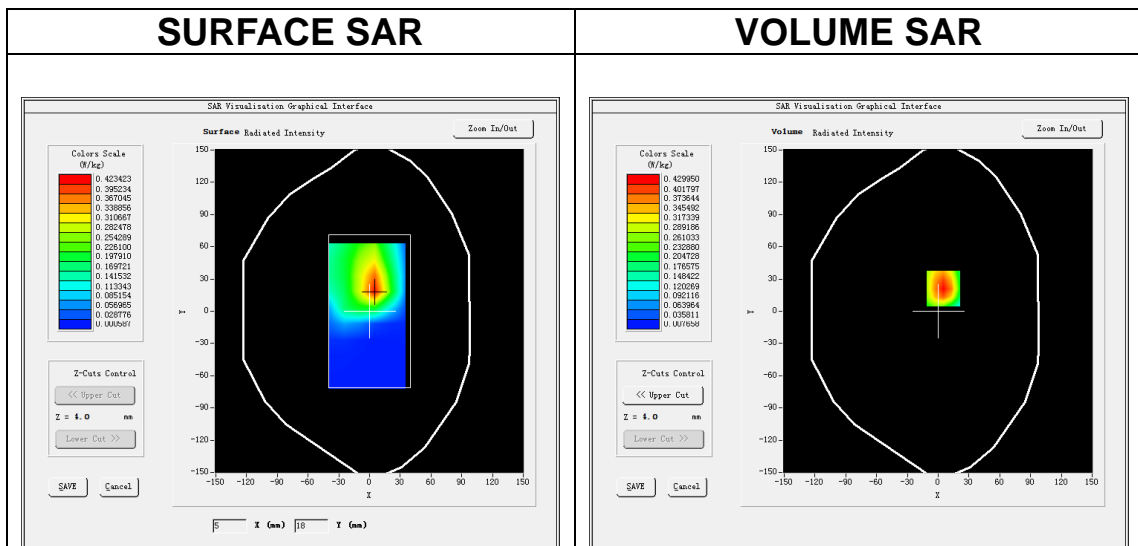

**Maximum location: X=5.00, Y=21.00**  
**SAR Peak: 0.65 W/kg**

<b>SAR 10g (W/Kg)</b>	0.236461
<b>SAR 1g (W/Kg)</b>	0.421483

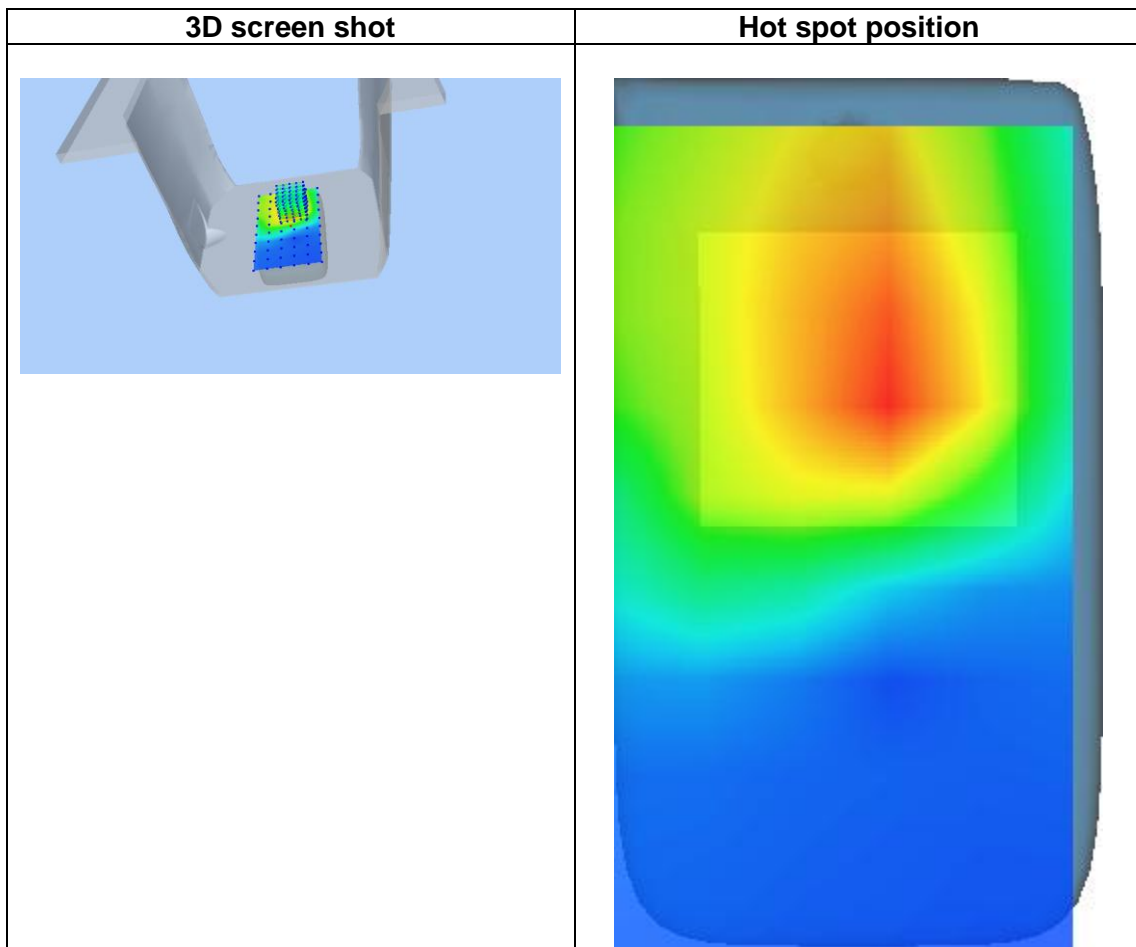
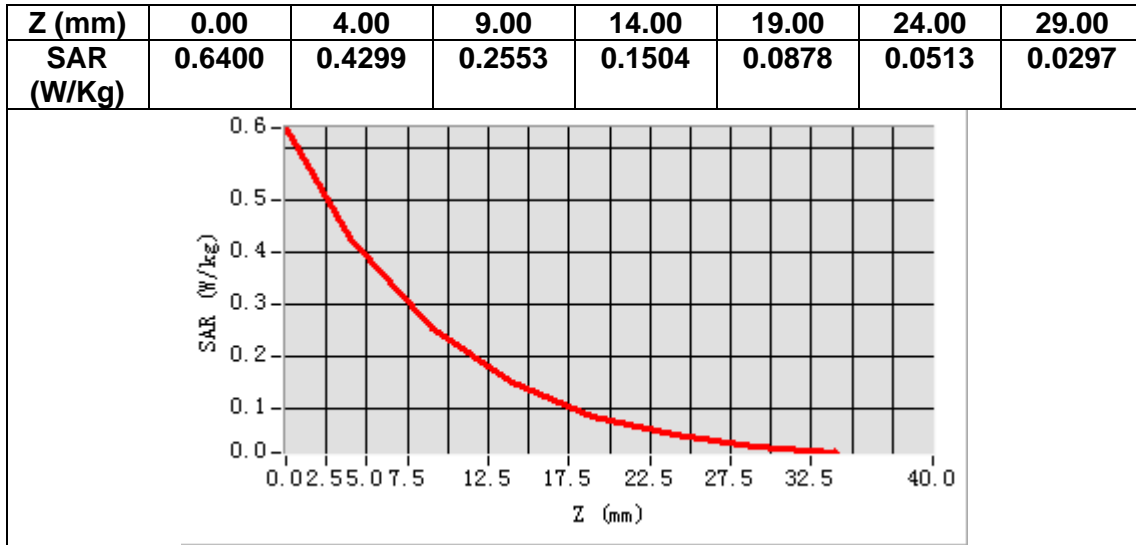

# MEASUREMENT 7

Date of measurement: 18/7/2023

## A. Experimental conditions.

<b>Area Scan</b>	<u>dx=15mm dy=15mm, h= 5.00 mm</u>
<b>ZoomScan</b>	<u>5x5x7, dx=8mm dy=8mm dz=5mm</u>
<b>Phantom</b>	<u>Left head</u>
<b>Device Position</b>	<u>Cheek</u>
<b>Band</b>	<u>Band4 WCDMA1700</u>
<b>Channels</b>	<u>Middle</u>
<b>Signal</b>	<u>WCDMA (Crest factor: 1.0)</u>
<b>ConvF</b>	<u>1.73</u>

## B. SAR Measurement Results

<b>Frequency (MHz)</b>	1732.600000
<b>Relative permittivity (real part)</b>	38.901199
<b>Relative permittivity (imaginary part)</b>	13.526930
<b>Conductivity (S/m)</b>	1.301591
<b>Variation (%)</b>	-0.080000

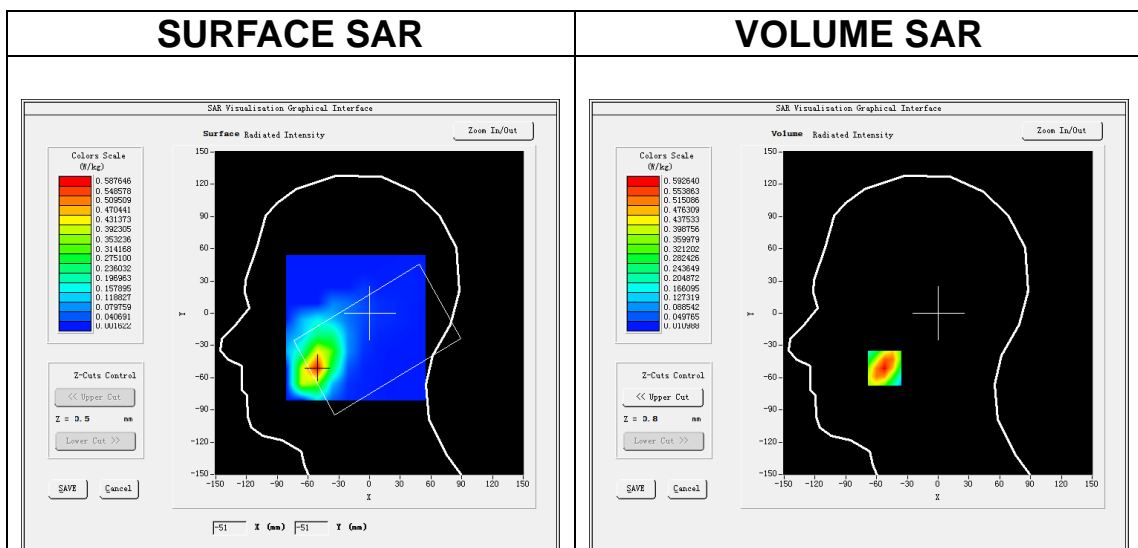

**Maximum location: X=-52.00, Y=-51.00**  
**SAR Peak: 0.82 W/kg**

<b>SAR 10g (W/Kg)</b>	0.337598
<b>SAR 1g (W/Kg)</b>	0.559082

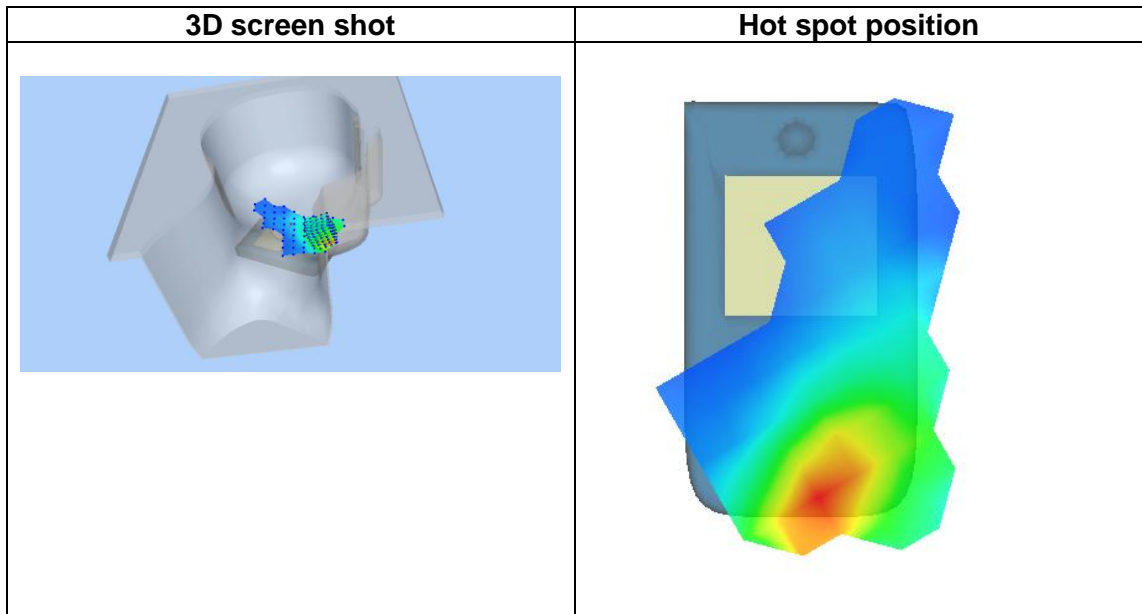
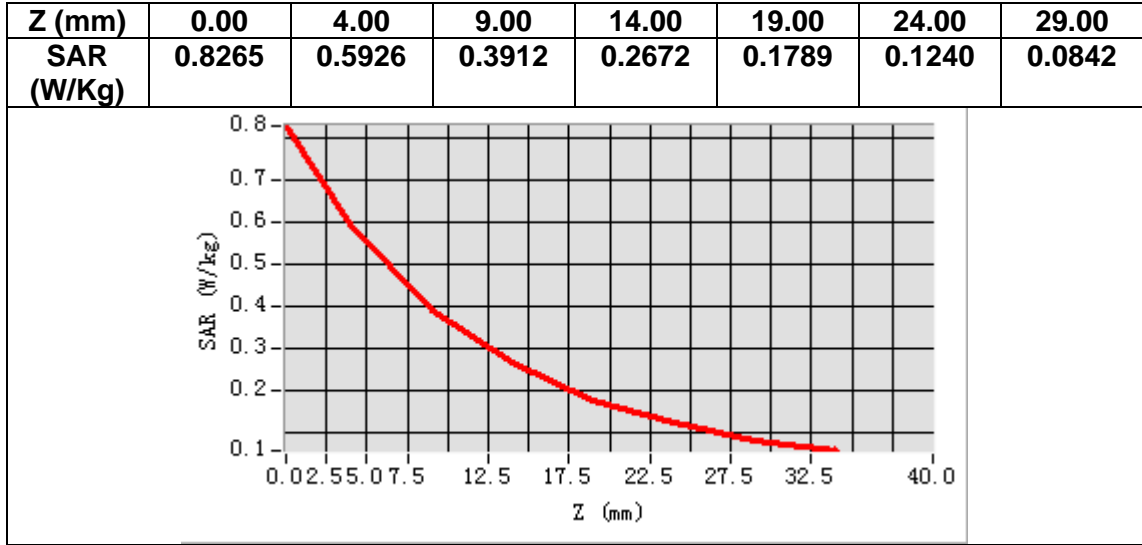

# MEASUREMENT 8

Date of measurement: 18/7/2023

## A. Experimental conditions.

<b>Area Scan</b>	<u>dx=15mm dy=15mm, h= 5.00 mm</u>
<b>ZoomScan</b>	<u>5x5x7, dx=8mm dy=8mm dz=5mm</u>
<b>Phantom</b>	<u>Validation plane</u>
<b>Device Position</b>	<u>Body</u>
<b>Band</b>	<u>Band4 WCDMA1700</u>
<b>Channels</b>	<u>Middle</u>
<b>Signal</b>	<u>WCDMA (Crest factor: 1.0)</u>
<b>ConvF</b>	<u>1.73</u>

## B. SAR Measurement Results

<b>Frequency (MHz)</b>	1732.600000
<b>Relative permittivity (real part)</b>	38.901199
<b>Relative permittivity (imaginary part)</b>	13.526930
<b>Conductivity (S/m)</b>	1.301591
<b>Variation (%)</b>	0.150000

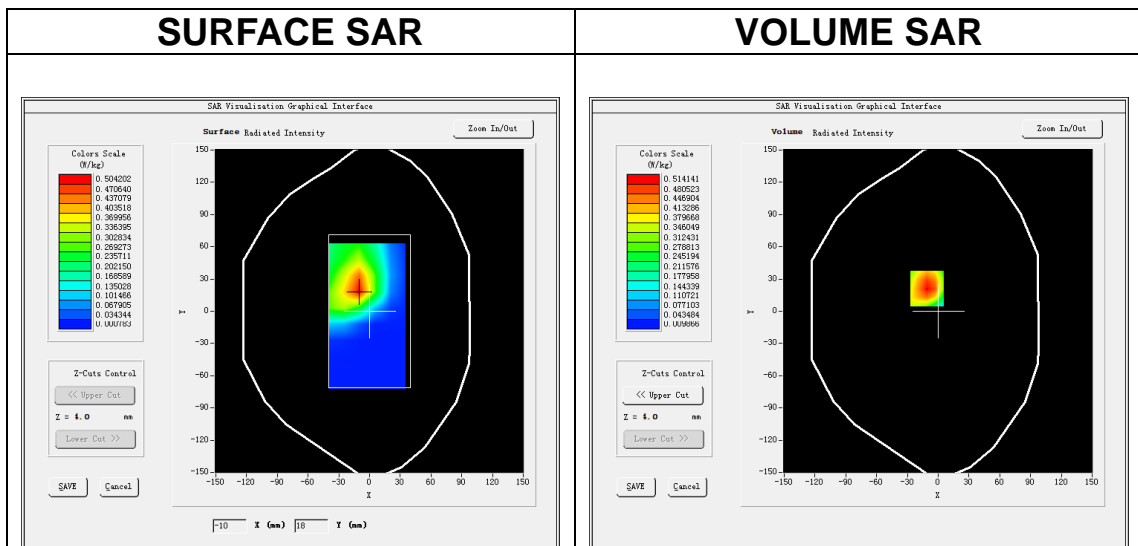

**Maximum location: X=-11.00, Y=21.00**  
**SAR Peak: 0.75 W/kg**

<b>SAR 10g (W/Kg)</b>	0.289538
<b>SAR 1g (W/Kg)</b>	0.488890



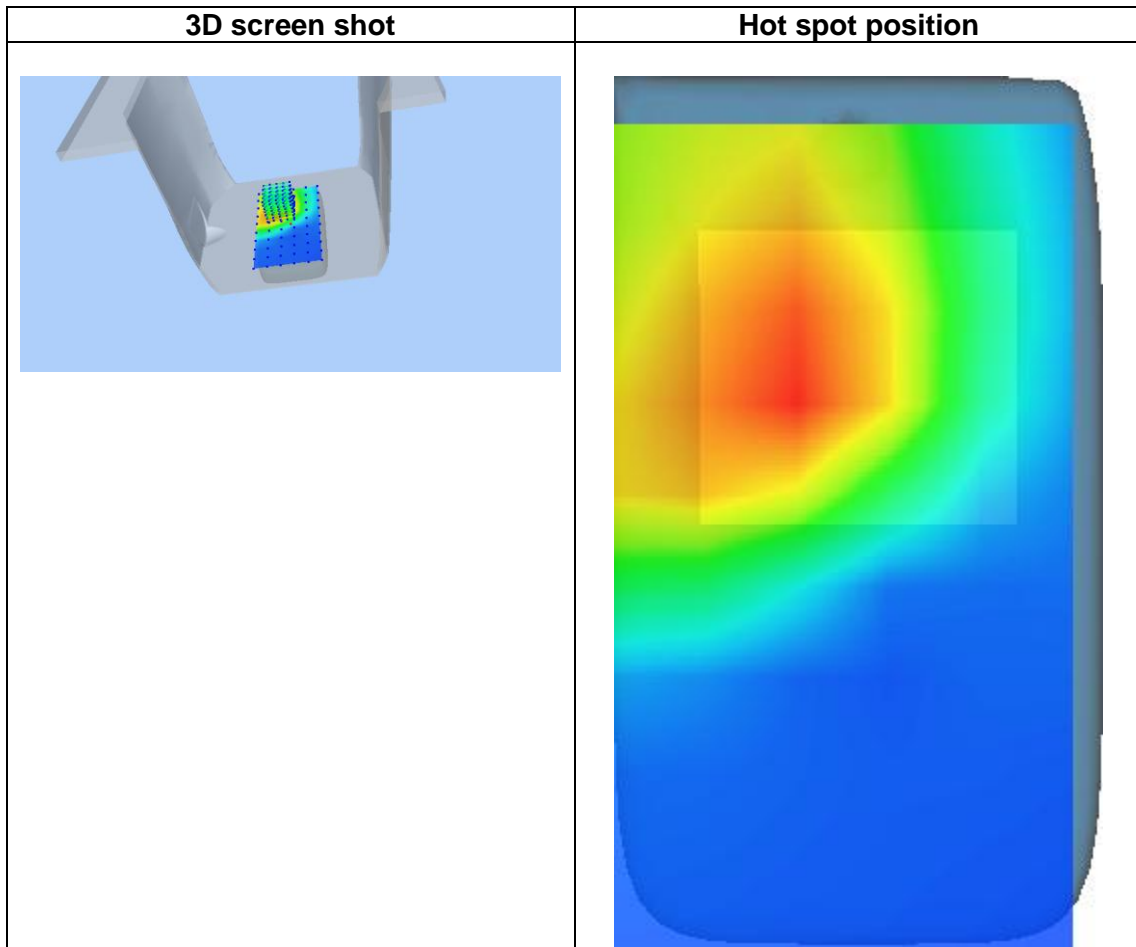
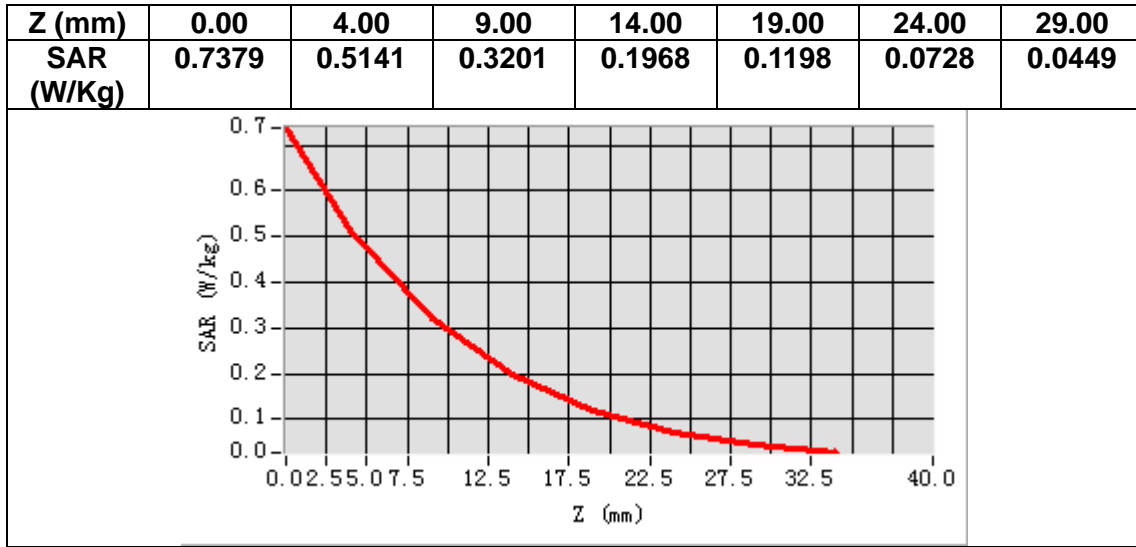

# MEASUREMENT 9

Date of measurement: 21/7/2023

## A. Experimental conditions.

<b>Area Scan</b>	<u>dx=15mm dy=15mm, h= 5.00 mm</u>
<b>ZoomScan</b>	<u>5x5x7,dx=8mm dy=8mm dz=5mm</u>
<b>Phantom</b>	<u>Left head</u>
<b>Device Position</b>	<u>Cheek</u>
<b>Band</b>	<u>Band5_WCDMA850</u>
<b>Channels</b>	<u>Middle</u>
<b>Signal</b>	<u>WCDMA (Crest factor: 1.0)</u>
<b>ConvF</b>	<u>1.50</u>

## B. SAR Measurement Results

<b>Frequency (MHz)</b>	836.400000
<b>Relative permittivity (real part)</b>	40.386131
<b>Relative permittivity (imaginary part)</b>	19.775848
<b>Conductivity (S/m)</b>	0.918918
<b>Variation (%)</b>	-1.470000

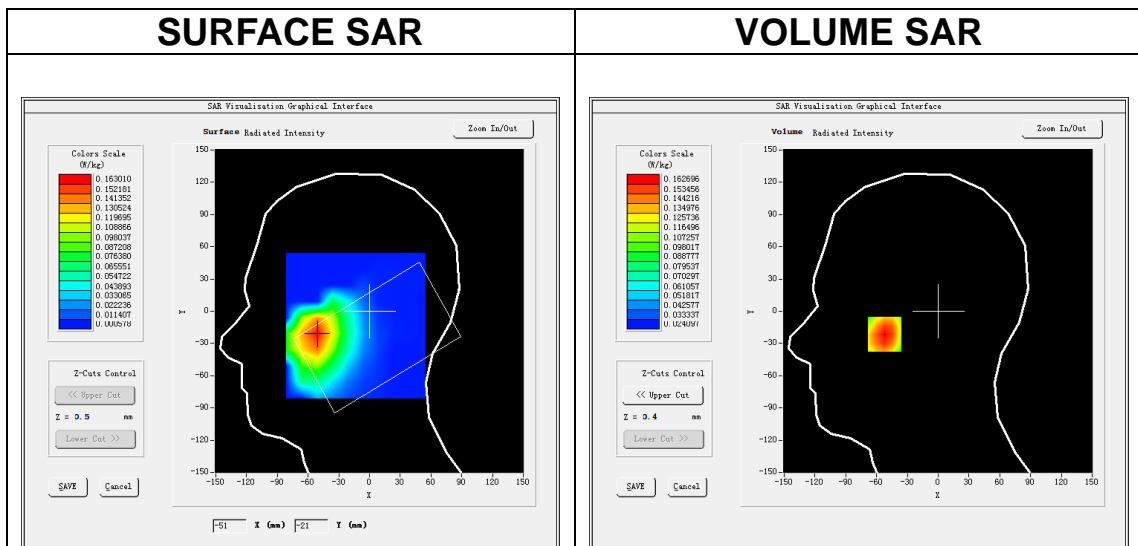

**Maximum location: X=-52.00, Y=-21.00**  
**SAR Peak: 0.19 W/kg**

<b>SAR 10g (W/Kg)</b>	0.121238
<b>SAR 1g (W/Kg)</b>	0.160468

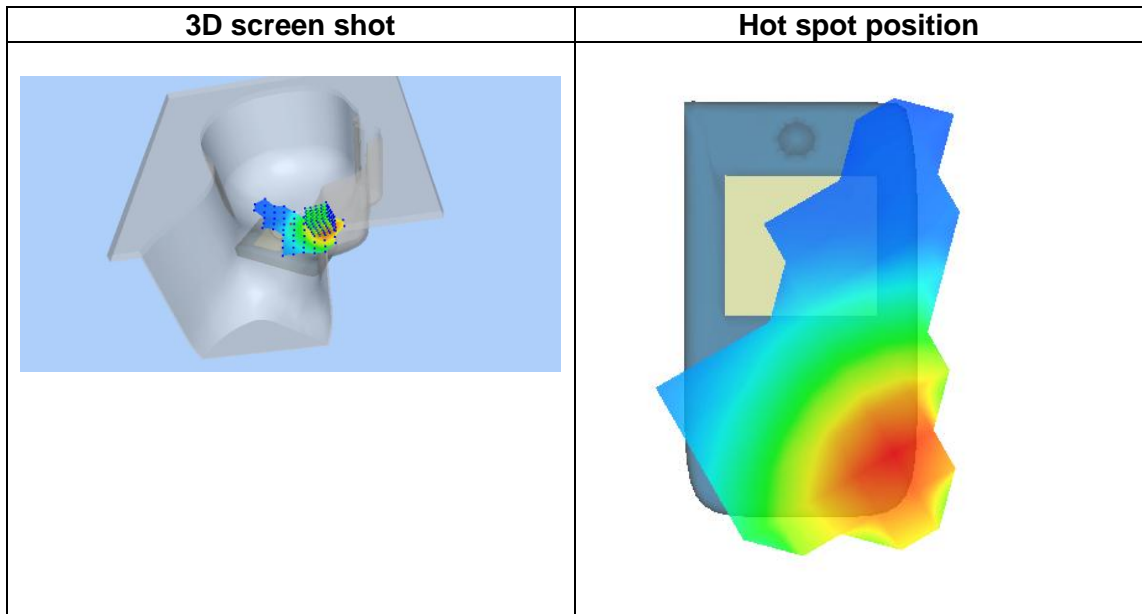
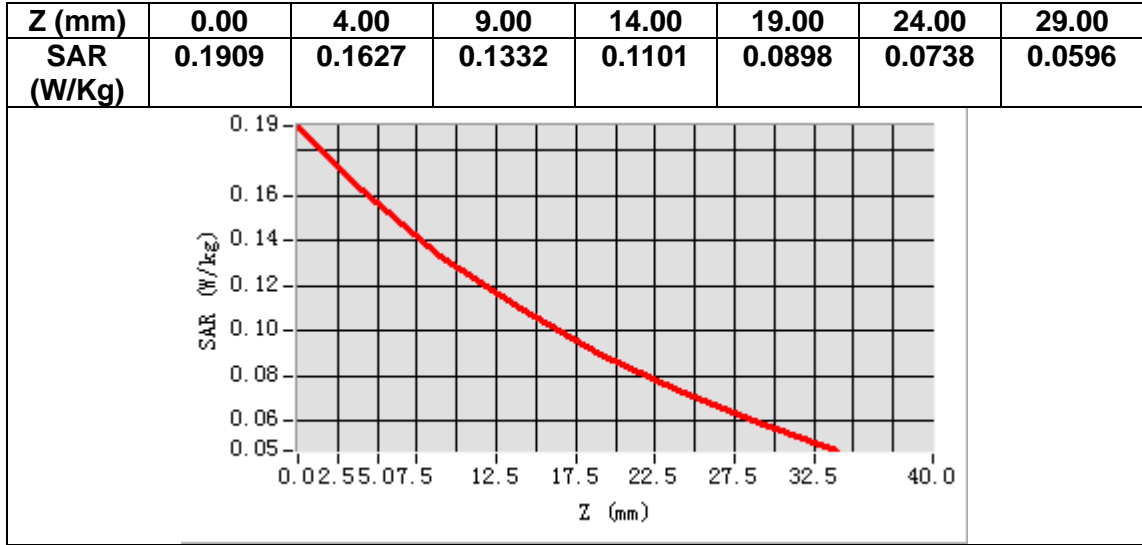

# MEASUREMENT 10

Date of measurement: 21/7/2023

## A. Experimental conditions.

<b>Area Scan</b>	<u>dx=15mm dy=15mm, h= 5.00 mm</u>
<b>ZoomScan</b>	<u>5x5x7, dx=8mm dy=8mm dz=5mm</u>
<b>Phantom</b>	<u>Validation plane</u>
<b>Device Position</b>	<u>Body</u>
<b>Band</b>	<u>Band5_WCDMA850</u>
<b>Channels</b>	<u>Middle</u>
<b>Signal</b>	<u>WCDMA (Crest factor: 1.0)</u>
<b>ConvF</b>	<u>1.50</u>

## B. SAR Measurement Results

<b>Frequency (MHz)</b>	836.400000
<b>Relative permittivity (real part)</b>	40.386131
<b>Relative permittivity (imaginary part)</b>	19.775848
<b>Conductivity (S/m)</b>	0.918918
<b>Variation (%)</b>	-0.190000

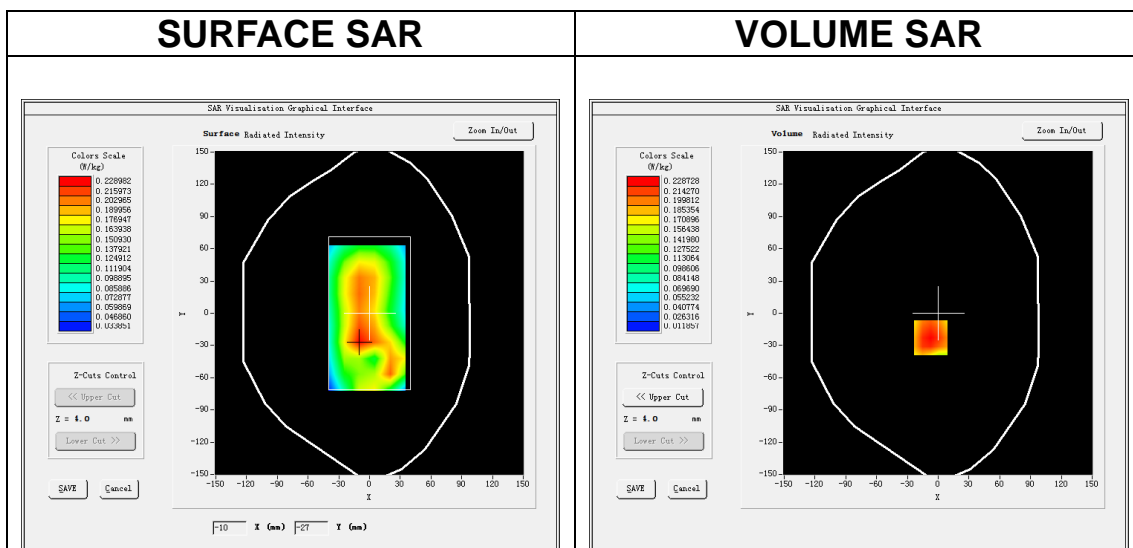

**Maximum location: X=-7.00, Y=-23.00**  
**SAR Peak: 0.29 W/kg**

<b>SAR 10g (W/Kg)</b>	0.160911
<b>SAR 1g (W/Kg)</b>	0.226102

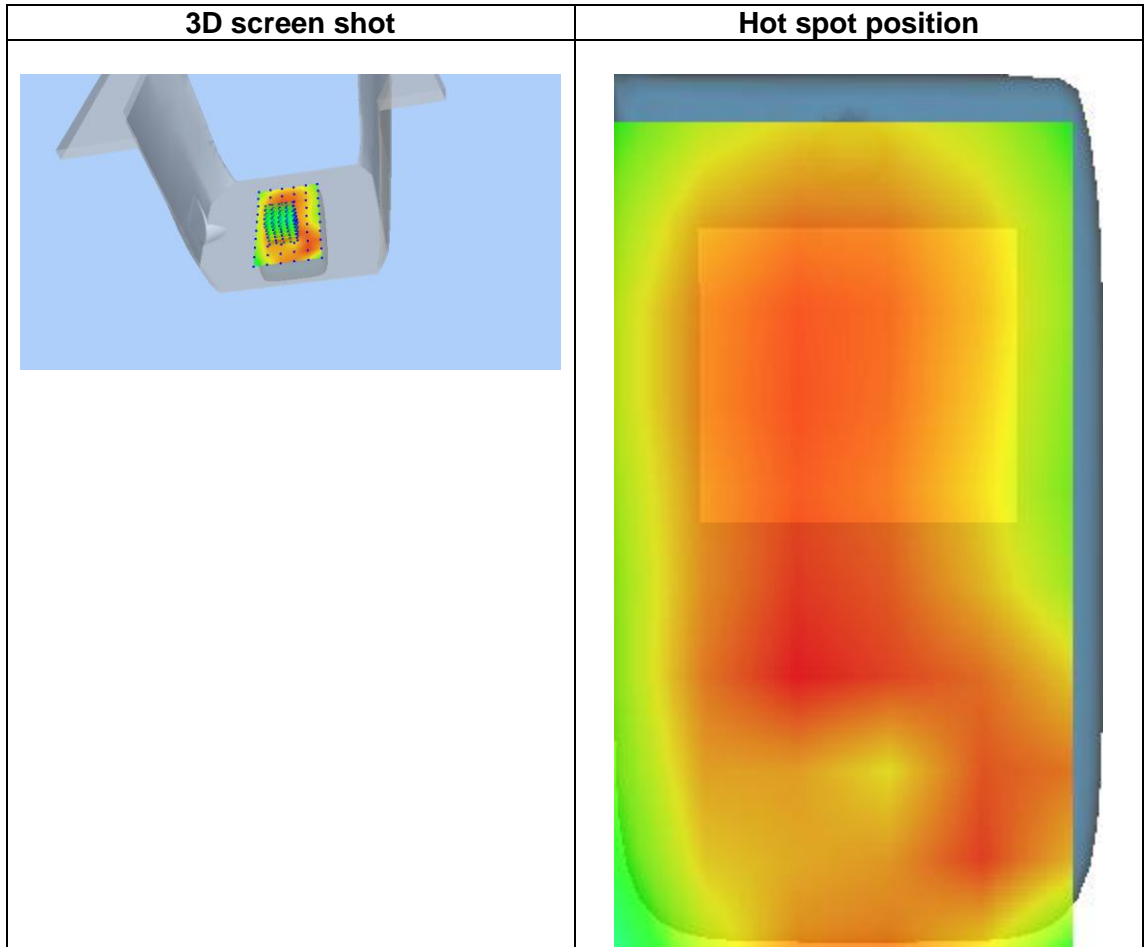
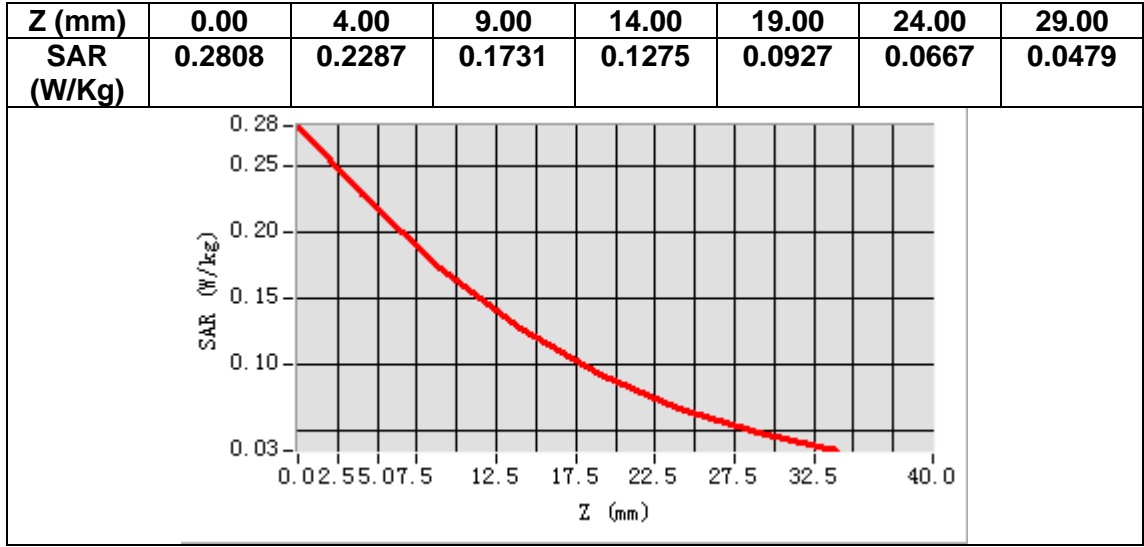

# MEASUREMENT 11

Date of measurement: 26/7/2023

## A. Experimental conditions.

<b>Area Scan</b>	<u>dx=12mm dy=12mm, h= 5.00 mm</u>
<b>ZoomScan</b>	<u>7x7x7,dx=5mm dy=5mm dz=5mm</u>
<b>Phantom</b>	<u>Left head</u>
<b>Device Position</b>	<u>Cheek</u>
<b>Band</b>	<u>IEEE 802.11b ISM</u>
<b>Channels</b>	<u>High</u>
<b>Signal</b>	<u>IEEE802.11b (Crest factor: 1.0)</u>
<b>ConvF</b>	<u>1.98</u>

## B. SAR Measurement Results

<b>Frequency (MHz)</b>	2462.000000
<b>Relative permittivity (real part)</b>	37.701838
<b>Relative permittivity (imaginary part)</b>	13.212847
<b>Conductivity (S/m)</b>	1.807224
<b>Variation (%)</b>	-0.790000

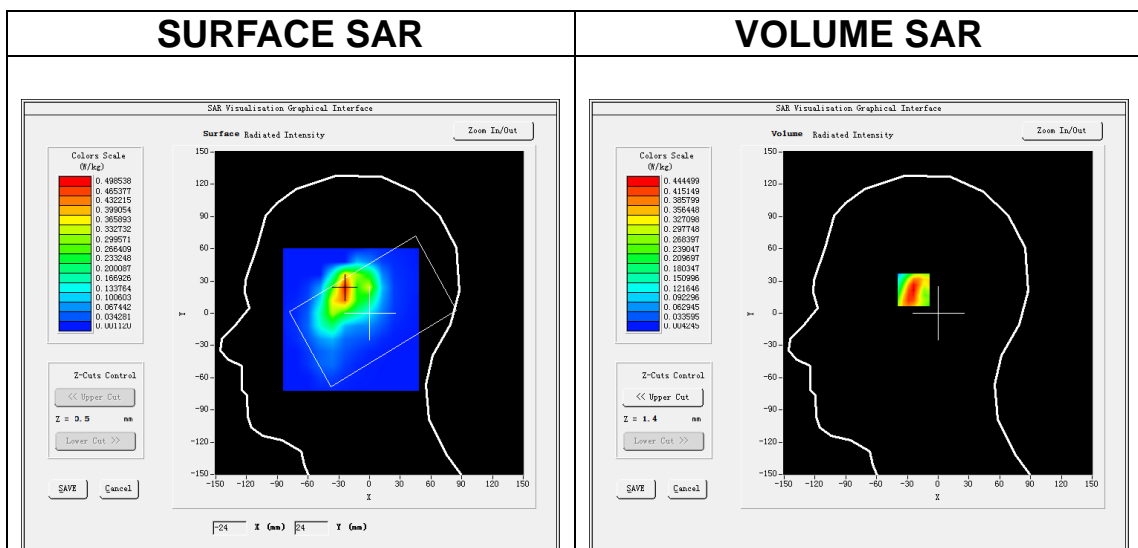

**Maximum location: X=-24.00, Y=24.00**  
**SAR Peak: 0.71 W/kg**

<b>SAR 10g (W/Kg)</b>	0.214152
<b>SAR 1g (W/Kg)</b>	0.412834

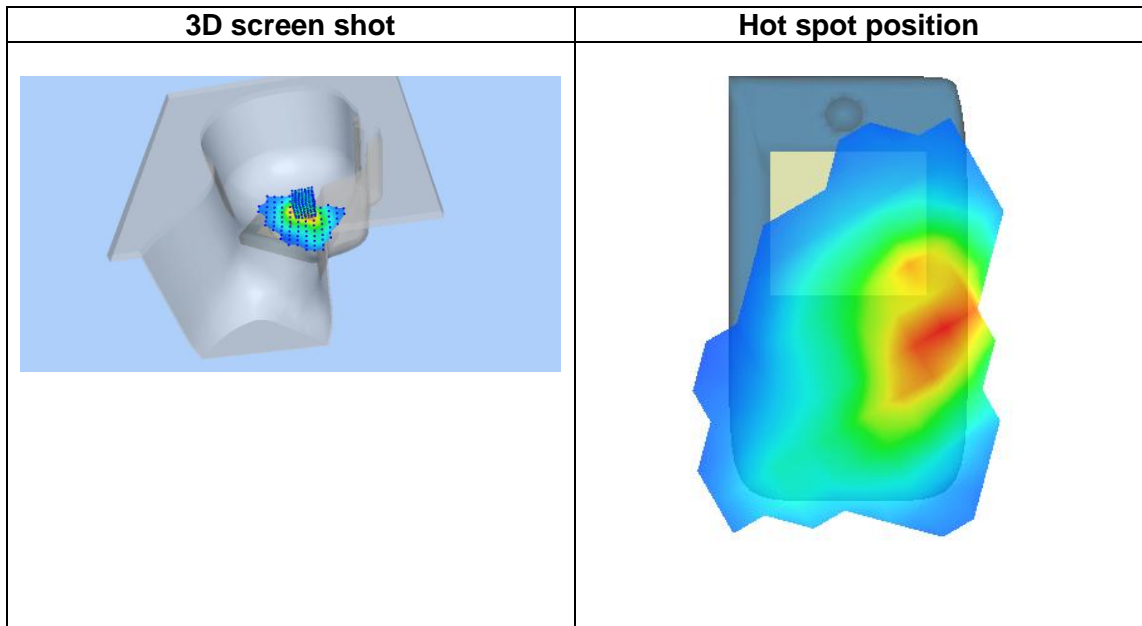
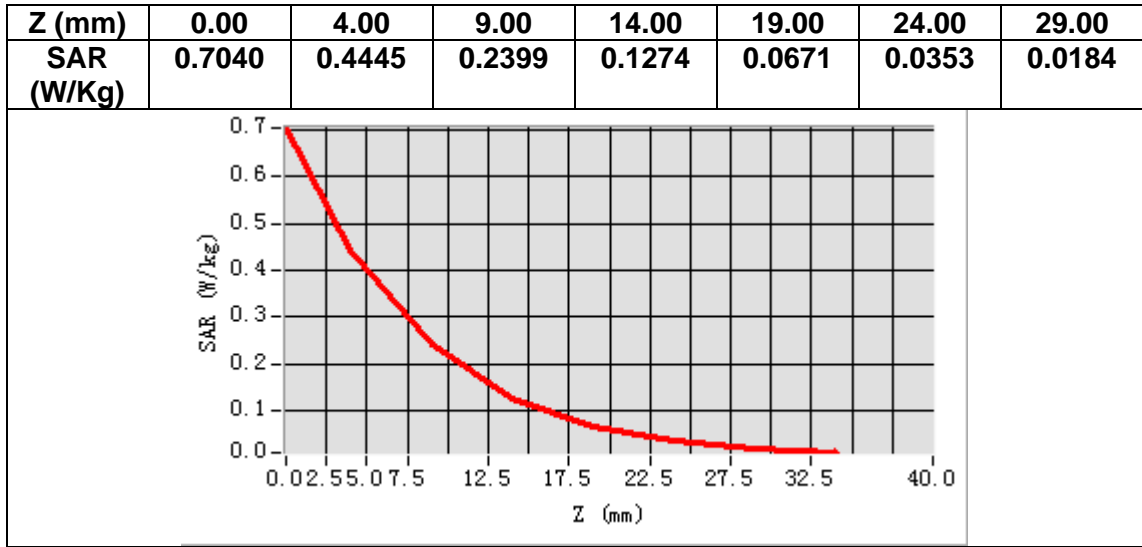

# MEASUREMENT 12

Date of measurement: 26/7/2023

## A. Experimental conditions.

<b>Area Scan</b>	<u>dx=12mm dy=12mm, h= 5.00 mm</u>
<b>ZoomScan</b>	<u>7x7x7, dx=5mm dy=5mm dz=5mm</u>
<b>Phantom</b>	<u>Validation plane</u>
<b>Device Position</b>	<u>Body</u>
<b>Band</b>	<u>High</u>
<b>Channels</b>	<u>Middle</u>
<b>Signal</b>	<u>IEEE802.11b (Crest factor: 1.0)</u>
<b>ConvF</b>	<u>1.98</u>

## B. SAR Measurement Results

<b>Frequency (MHz)</b>	2462.000000
<b>Relative permittivity (real part)</b>	37.701838
<b>Relative permittivity (imaginary part)</b>	13.212847
<b>Conductivity (S/m)</b>	1.807224
<b>Variation (%)</b>	-0.640000

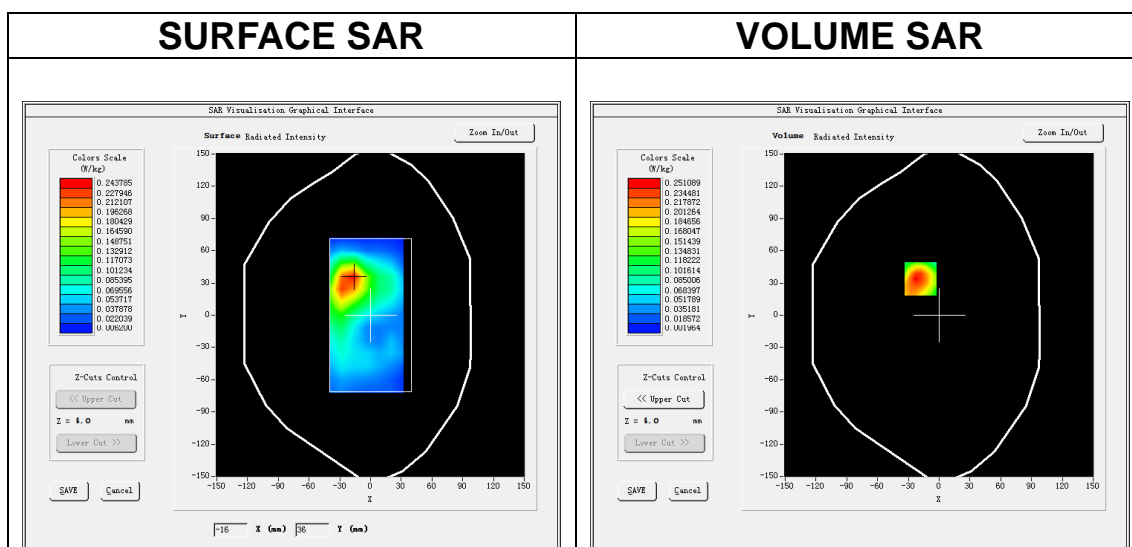

**Maximum location: X=-18.00, Y=34.00**  
**SAR Peak: 0.43 W/kg**

<b>SAR 10g (W/Kg)</b>	0.123238
<b>SAR 1g (W/Kg)</b>	0.237900



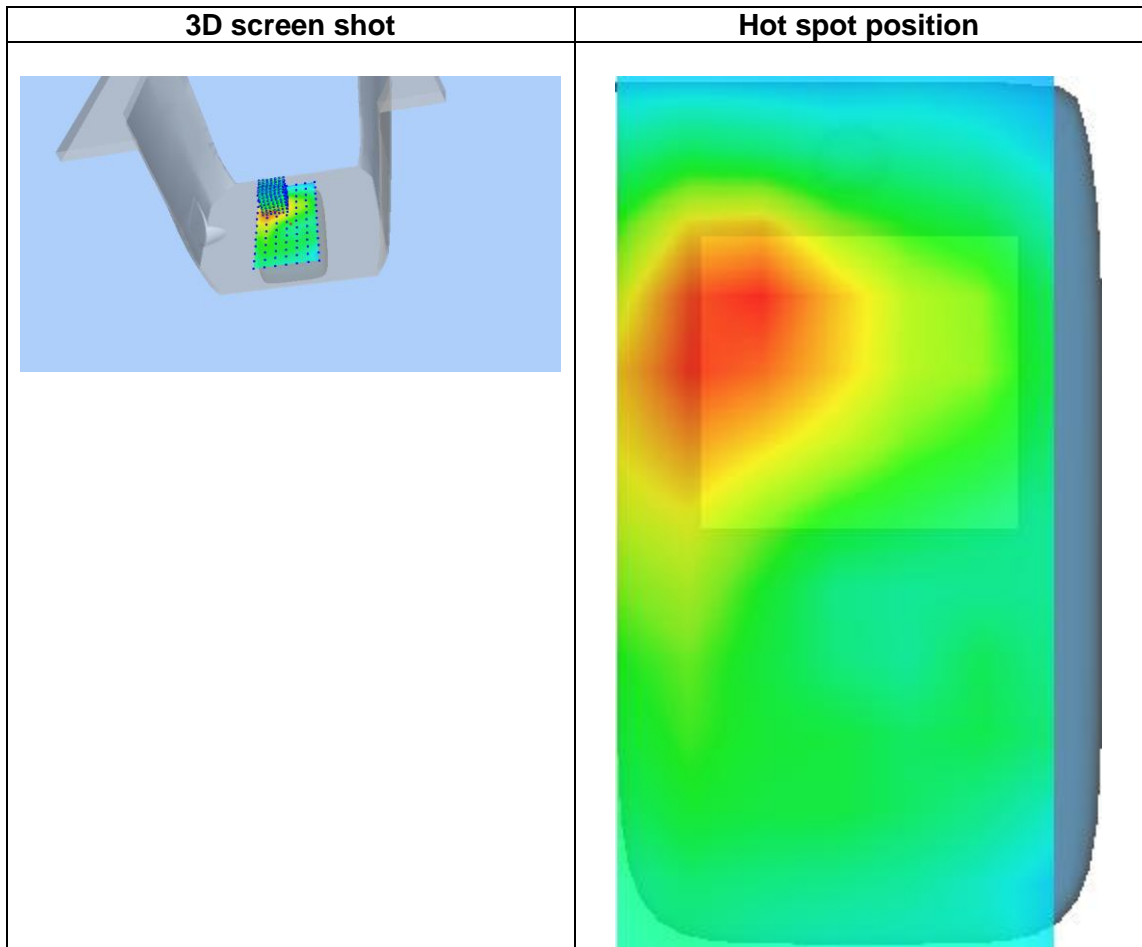
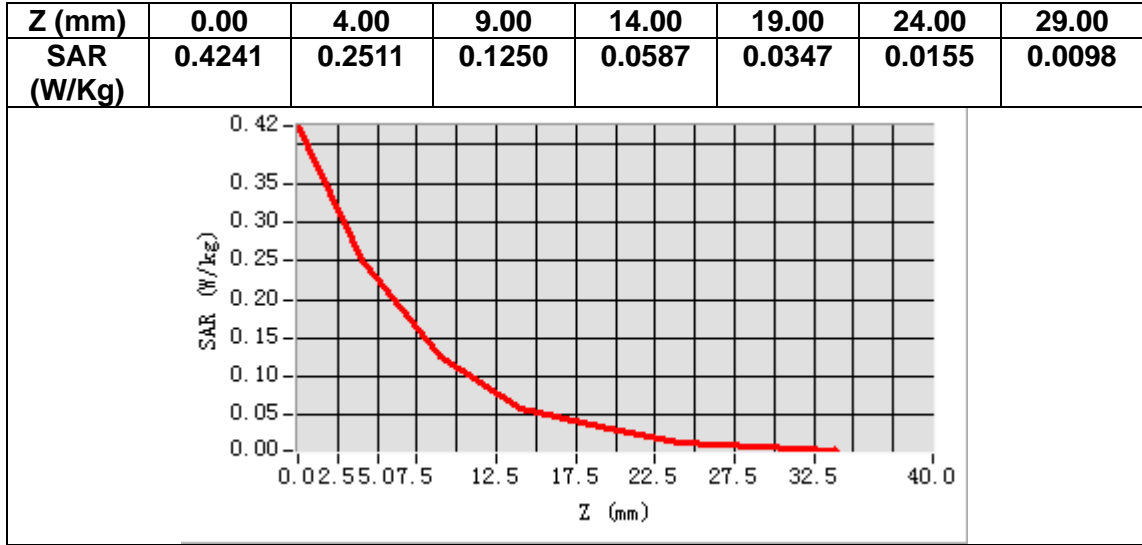

# MEASUREMENT 13

Date of measurement: 19/7/2023

## A. Experimental conditions.

<b>Area Scan</b>	<u>dx=15mm dy=15mm, h= 5.00 mm</u>
<b>ZoomScan</b>	<u>5x5x7,dx=8mm dy=8mm dz=5mm</u>
<b>Phantom</b>	<u>Left head</u>
<b>Device Position</b>	<u>Cheek</u>
<b>Band</b>	<u>LTE band 2</u>
<b>Channels</b>	<u>Middle</u>
<b>Signal</b>	<u>LTE (Crest factor: 1.0)</u>
<b>ConvF</b>	<u>1.91</u>

## B. SAR Measurement Results

<b>Frequency (MHz)</b>	1880.000000
<b>Relative permittivity (real part)</b>	38.577995
<b>Relative permittivity (imaginary part)</b>	14.012720
<b>Conductivity (S/m)</b>	1.463551
<b>Variation (%)</b>	0.080000

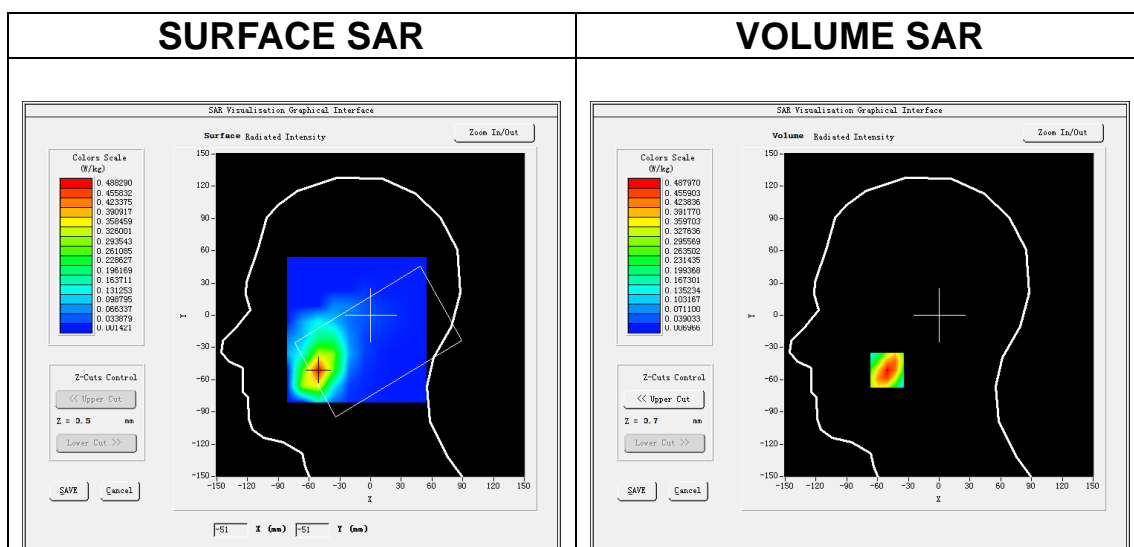

**Maximum location: X=-51.00, Y=-51.00**  
**SAR Peak: 0.69 W/kg**

<b>SAR 10g (W/Kg)</b>	0.279823
<b>SAR 1g (W/Kg)</b>	0.480266

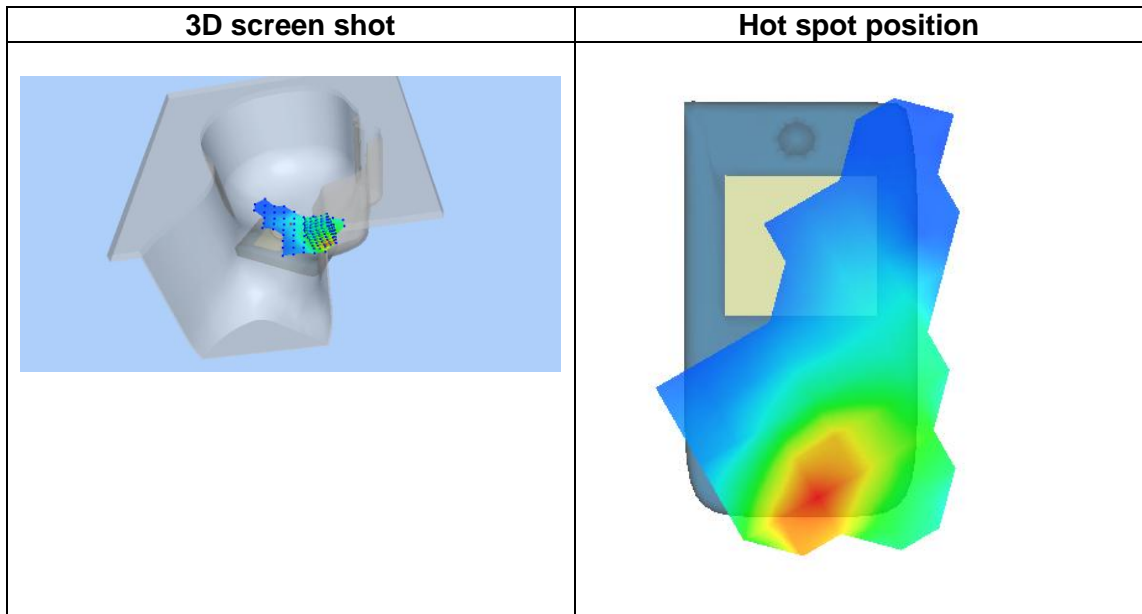
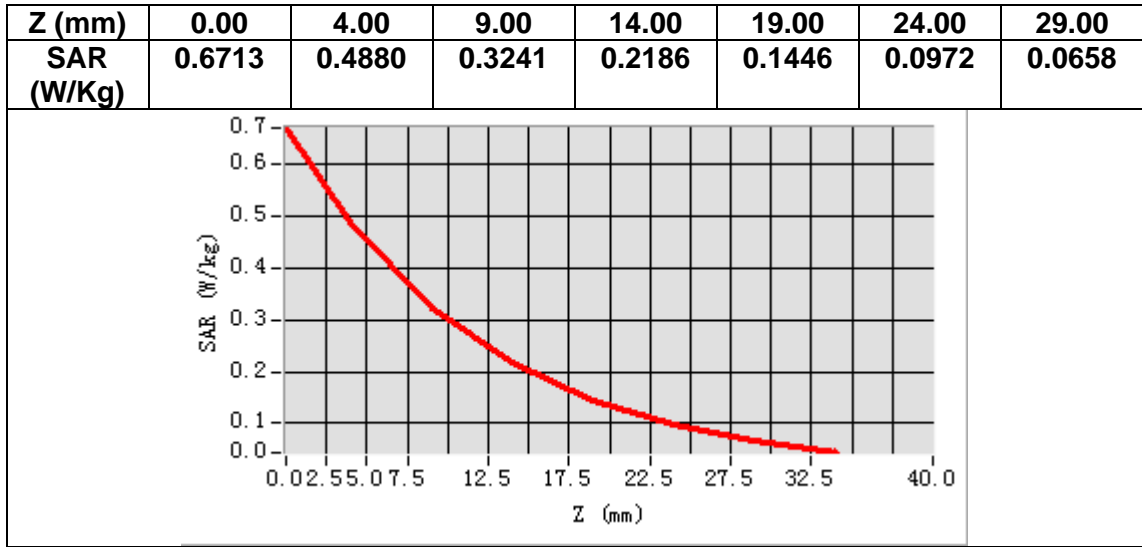

# MEASUREMENT 14

Date of measurement: 19/7/2023

## A. Experimental conditions.

<b>Area Scan</b>	<u>dx=15mm dy=15mm, h= 5.00 mm</u>
<b>ZoomScan</b>	<u>5x5x7, dx=8mm dy=8mm dz=5mm</u>
<b>Phantom</b>	<u>Validation plane</u>
<b>Device Position</b>	<u>Body</u>
<b>Band</b>	<u>LTE band 2</u>
<b>Channels</b>	<u>Middle</u>
<b>Signal</b>	<u>LTE (Crest factor: 1.0)</u>
<b>ConvF</b>	<u>1.91</u>

## B. SAR Measurement Results

<b>Frequency (MHz)</b>	1880.000000
<b>Relative permittivity (real part)</b>	38.577995
<b>Relative permittivity (imaginary part)</b>	14.012720
<b>Conductivity (S/m)</b>	1.463551
<b>Variation (%)</b>	-1.040000

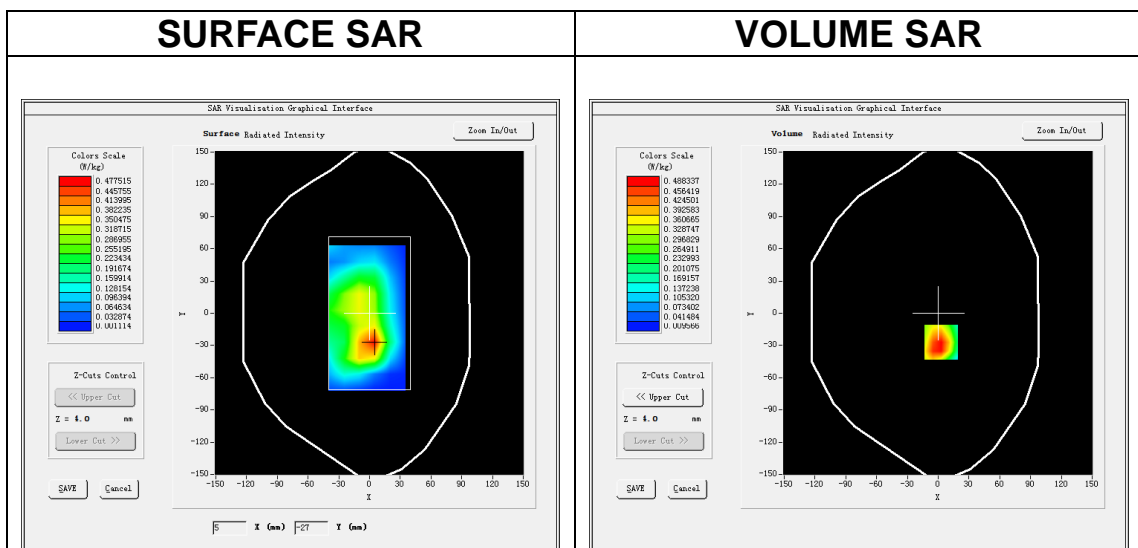

**Maximum location: X=3.00, Y=-27.00**  
**SAR Peak: 0.77 W/kg**

<b>SAR 10g (W/Kg)</b>	0.269089
<b>SAR 1g (W/Kg)</b>	0.495652

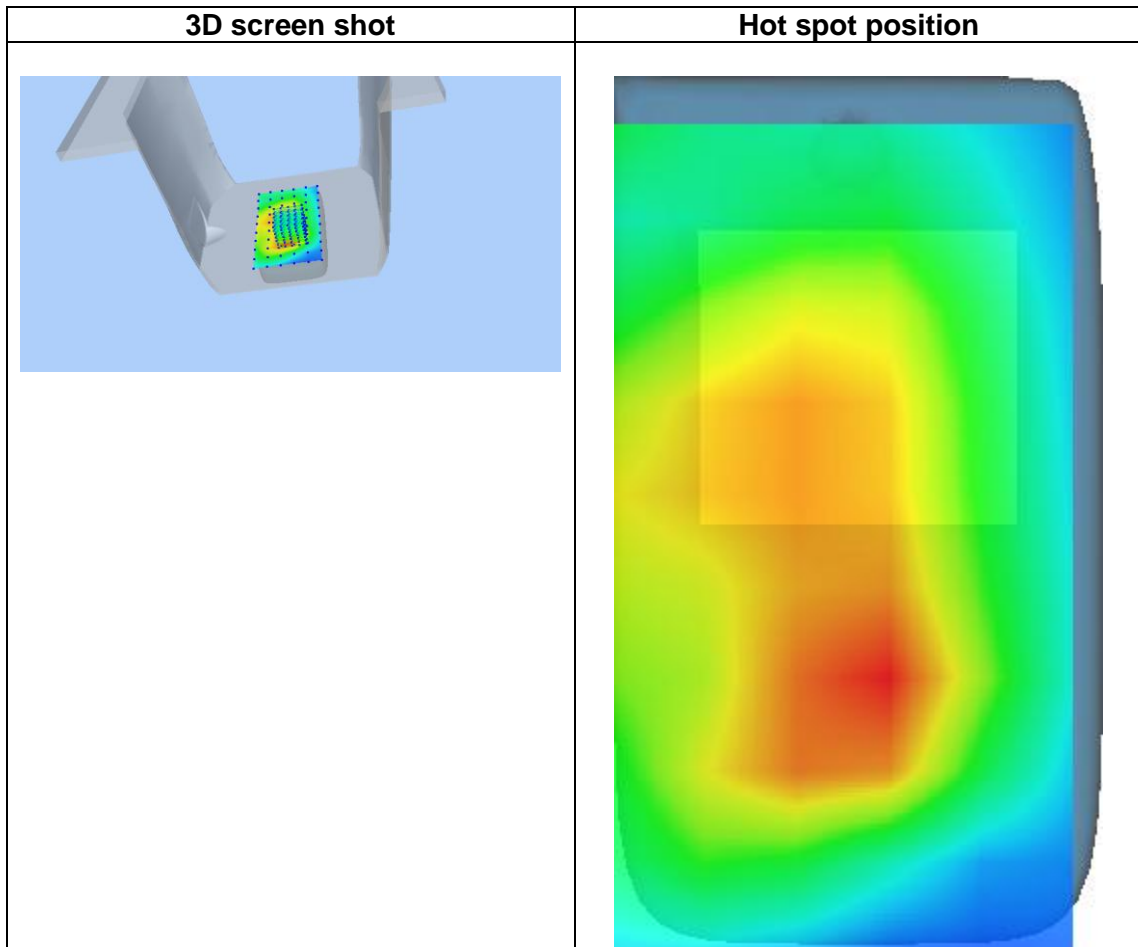
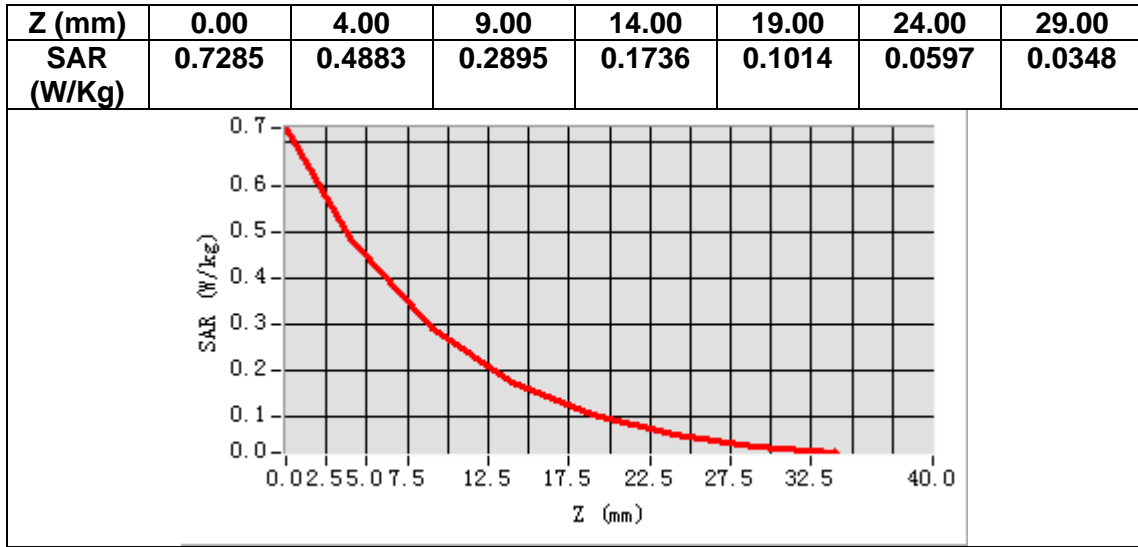

# MEASUREMENT 15

Date of measurement: 18/7/2023

## A. Experimental conditions.

<b>Area Scan</b>	<u>dx=15mm dy=15mm, h= 5.00 mm</u>
<b>ZoomScan</b>	<u>5x5x7, dx=8mm dy=8mm dz=5mm</u>
<b>Phantom</b>	<u>Left head</u>
<b>Device Position</b>	<u>Cheek</u>
<b>Band</b>	<u>LTE band 4</u>
<b>Channels</b>	<u>Middle</u>
<b>Signal</b>	<u>LTE (Crest factor: 1.0)</u>
<b>ConvF</b>	<u>1.73</u>

## B. SAR Measurement Results

<b>Frequency (MHz)</b>	1732.500000
<b>Relative permittivity (real part)</b>	38.909100
<b>Relative permittivity (imaginary part)</b>	13.511780
<b>Conductivity (S/m)</b>	1.300509
<b>Variation (%)</b>	-0.610000

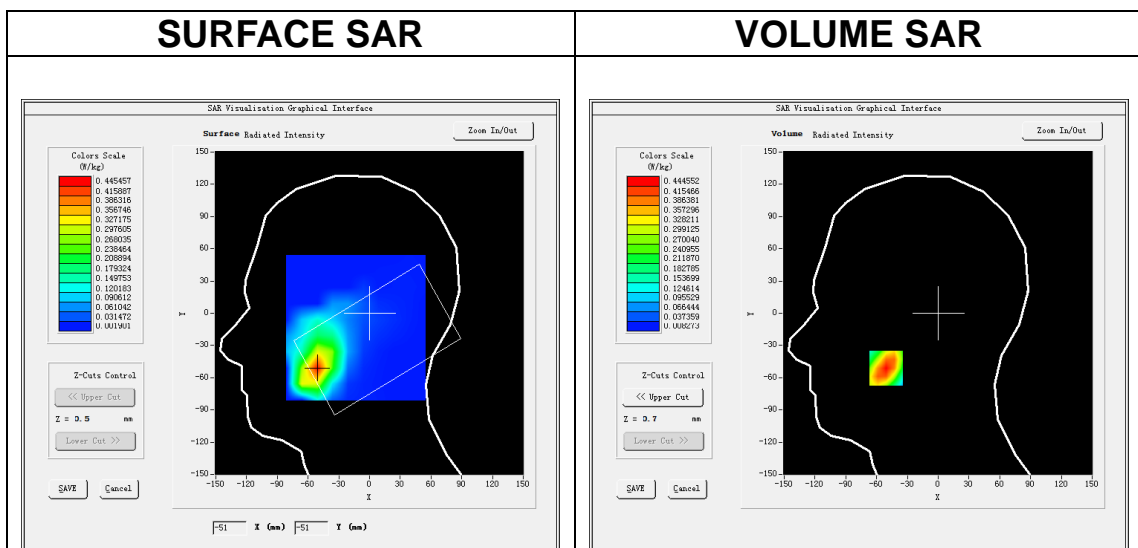

**Maximum location: X=-51.00, Y=-51.00**  
**SAR Peak: 0.61 W/kg**

<b>SAR 10g (W/Kg)</b>	0.260105
<b>SAR 1g (W/Kg)</b>	0.421471

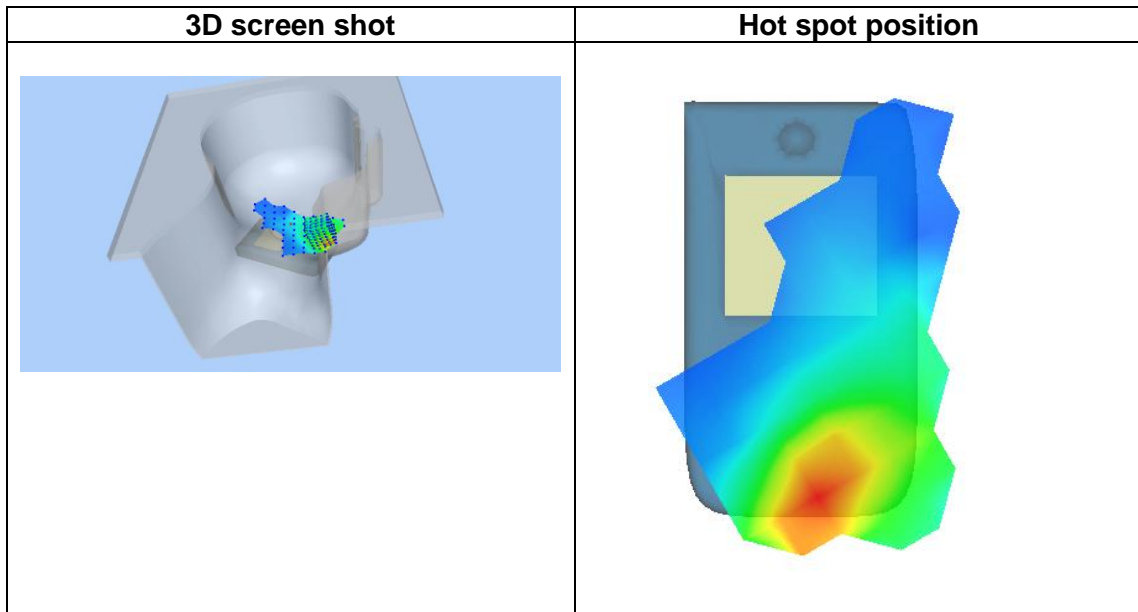
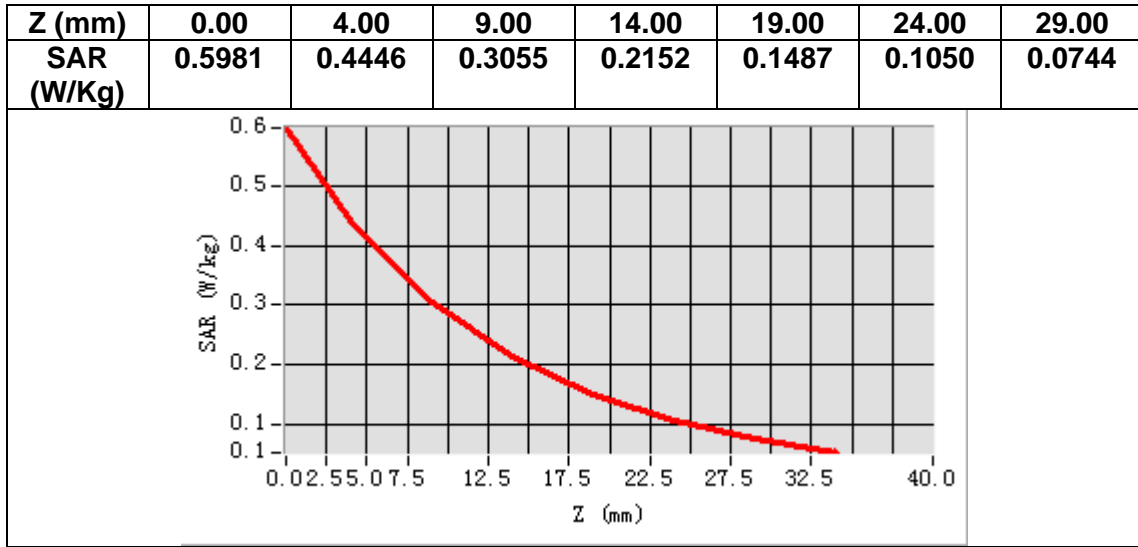

# MEASUREMENT 16

Date of measurement: 18/7/2023

## A. Experimental conditions.

<b>Area Scan</b>	<u>dx=15mm dy=15mm, h= 5.00 mm</u>
<b>ZoomScan</b>	<u>5x5x7, dx=8mm dy=8mm dz=5mm</u>
<b>Phantom</b>	<u>Validation plane</u>
<b>Device Position</b>	<u>Body</u>
<b>Band</b>	<u>LTE band 4</u>
<b>Channels</b>	<u>Middle</u>
<b>Signal</b>	<u>LTE (Crest factor: 1.0)</u>
<b>ConvF</b>	<u>1.73</u>

## B. SAR Measurement Results

<b>Frequency (MHz)</b>	1732.500000
<b>Relative permittivity (real part)</b>	38.909100
<b>Relative permittivity (imaginary part)</b>	13.511780
<b>Conductivity (S/m)</b>	1.300509
<b>Variation (%)</b>	-0.740000

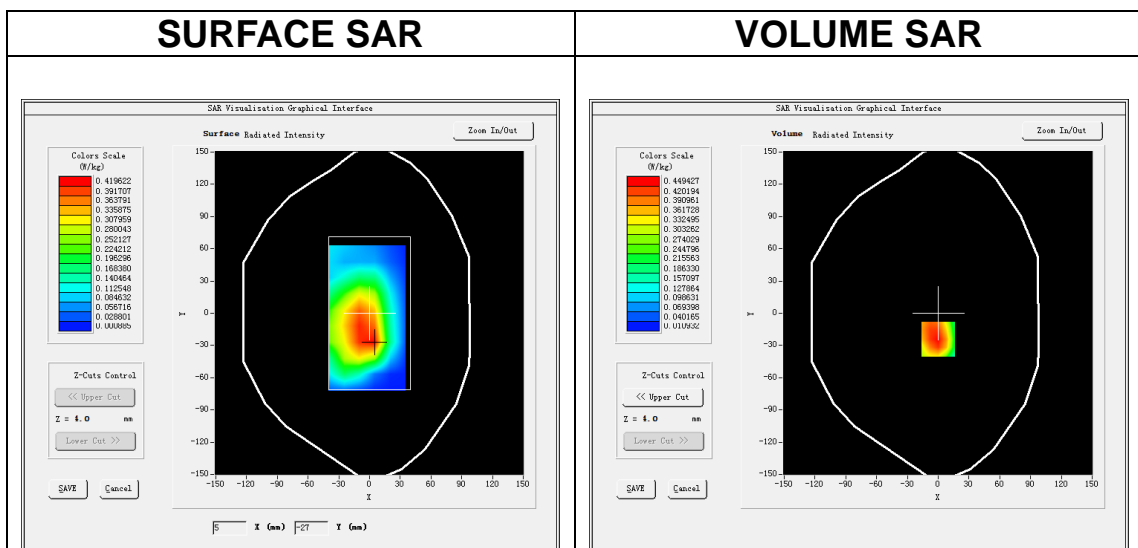

**Maximum location: X=0.00, Y=-24.00**  
**SAR Peak: 0.65 W/kg**

<b>SAR 10g (W/Kg)</b>	0.269602
<b>SAR 1g (W/Kg)</b>	0.431550



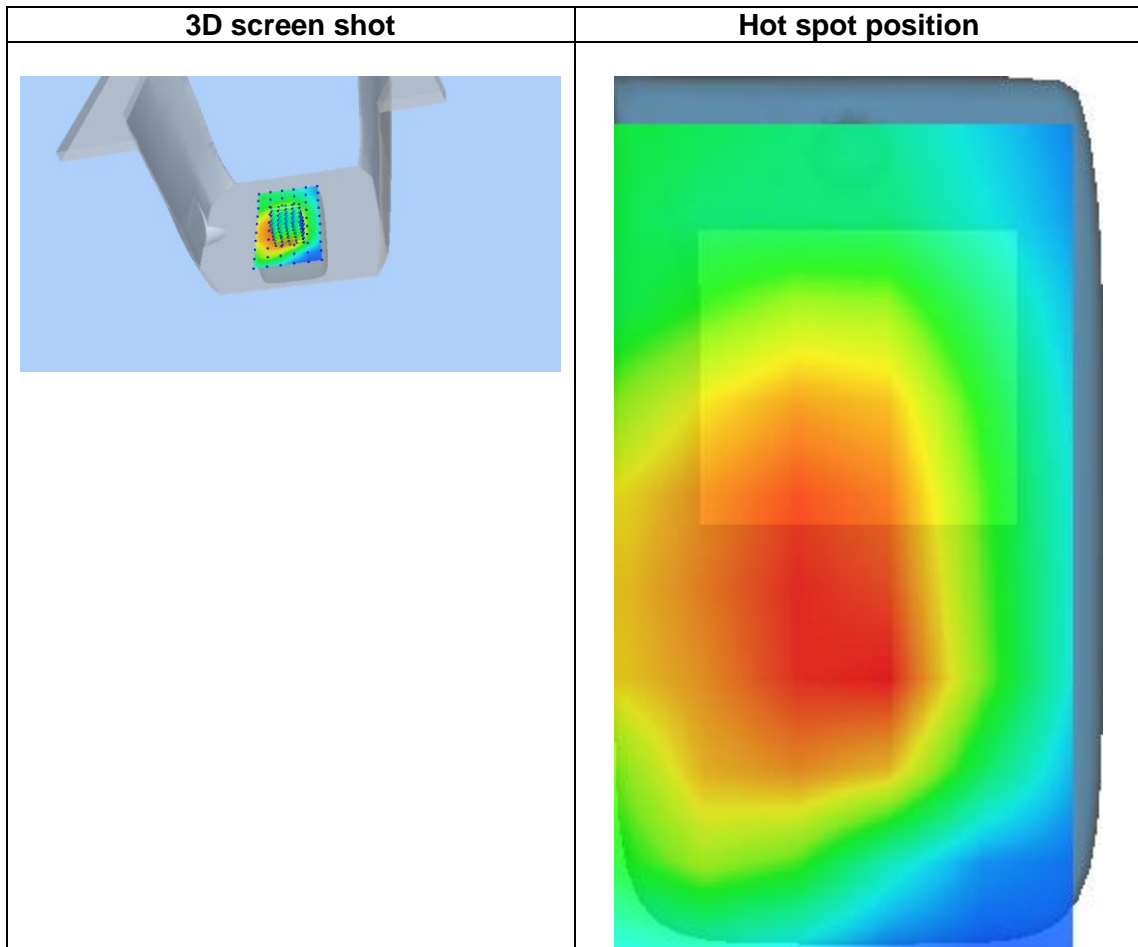
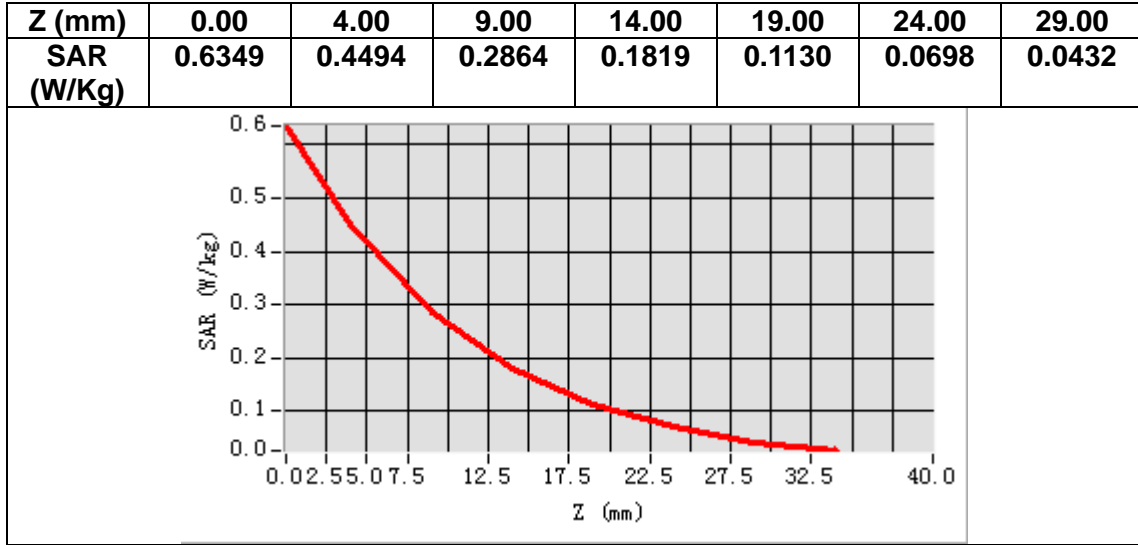

# MEASUREMENT 17

Date of measurement: 21/7/2023

## A. Experimental conditions.

<b>Area Scan</b>	<u>dx=15mm dy=15mm, h= 5.00 mm</u>
<b>ZoomScan</b>	<u>5x5x7,dx=8mm dy=8mm dz=5mm</u>
<b>Phantom</b>	<u>Left head</u>
<b>Device Position</b>	<u>Cheek</u>
<b>Band</b>	<u>LTE band 5</u>
<b>Channels</b>	<u>Middle</u>
<b>Signal</b>	<u>LTE (Crest factor: 1.0)</u>
<b>ConvF</b>	<u>1.50</u>

## B. SAR Measurement Results

<b>Frequency (MHz)</b>	836.500000
<b>Relative permittivity (real part)</b>	40.388721
<b>Relative permittivity (imaginary part)</b>	19.774509
<b>Conductivity (S/m)</b>	0.918965
<b>Variation (%)</b>	-1.330000

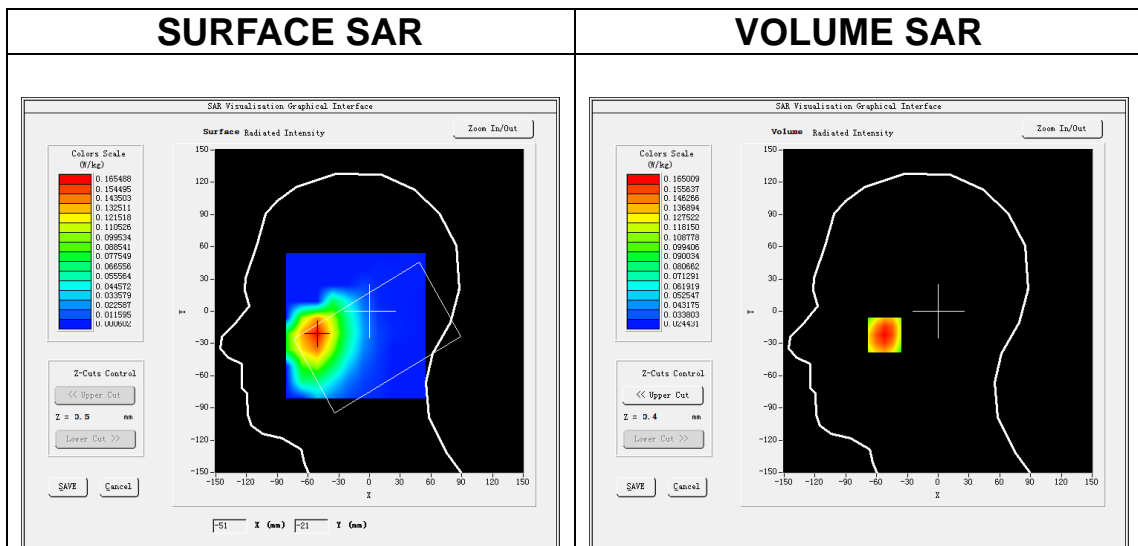

**Maximum location: X=-52.00, Y=-22.00**  
**SAR Peak: 0.19 W/kg**

<b>SAR 10g (W/Kg)</b>	0.123484
<b>SAR 1g (W/Kg)</b>	0.162465