

FCC CERTIFICATION TEST REPORT

FOR

Applicant	:	KAWA ELECTRONICS COMPANY LIMITED
Address	:	FLAT A 21/F CHEUNG LEE IND BLDG 9 CHEUNG LEE ST CHAI WAN HONG KONG
Equipment under Test	:	Dash cam
Model No.	:	D6
Trade Mark	:	KAWA
FCC ID	:	2AZWZ20221
Manufacturer	:	KAWA ELECTRONICS COMPANY LIMITED
Address	:	FLAT A 21/F CHEUNG LEE IND BLDG 9 CHEUNG LEE ST CHAI WAN HONG KONG

Issued By: Dongguan Dongdian Testing Service Co., Ltd.

Add.: No. 17, Zongbu Road 2, Songshan Lake Sci&Tech, Industry Park,
Dongguan City, Guangdong Province, China, 523808

Tel.: +86-0769-38826678, **E-mail:** ddt@dgddt.com, <http://www.dgddt.com>

REPORT

Table of Contents

	Test report declares.....	4
1.	Summary of Test Results.....	6
2.	General Test Information	7
2.1.	Description of EUT	7
2.2.	Accessories of EUT.....	7
2.3.	Assistant equipment used for test.....	8
2.4.	Block diagram of EUT configuration for test	8
2.5.	Deviations of test standard.....	8
2.6.	Test environment conditions	8
2.7.	Test laboratory	9
2.8.	Measurement uncertainty.....	9
3.	Equipment Used During Test.....	10
4.	6 dB Bandwidth and 99% Bandwidth.....	12
4.1.	Block diagram of test setup.....	12
4.2.	Limits	12
4.3.	Test procedure	12
4.4.	Test result.....	13
4.5.	Original test data	14
5.	Conducted Peak Output Power	23
5.1.	Block diagram of test setup.....	23
5.2.	Limits	23
5.3.	Test procedure	23
5.4.	Test result.....	23
6.	Power Spectral Density.....	24
6.1.	Block diagram of test setup.....	24
6.2.	Limits	24
6.3.	Test procedure	24
6.4.	Test result.....	24
6.5.	Original test data	25
7.	Band Edge and Spurious Emissions (Conducted)	30
7.1.	Block diagram of test setup.....	30
7.2.	Limits	30
7.3.	Test procedure	30
7.4.	Test result.....	31
7.5.	Original test data	31
8.	Radiated Spurious Emissions.....	47
8.1.	Block diagram of test setup.....	47

8.2.	Limit	48
8.3.	Test procedure	49
8.4.	Test result.....	51
9.	Radiated Band Edge Compliance.....	66
9.1.	Block diagram of test setup.....	66
9.2.	Limit	66
9.3.	Test procedure	66
9.4.	Test result.....	66
10.	Power Line Conducted Emission	83
10.1.	Block diagram of test setup.....	83
10.2.	Power line conducted emission limits (Class B).....	83
10.3.	Test procedure	83
10.4.	Test result.....	84
11.	Antenna Requirements	85
11.1.	Limit.....	85
11.2.	Result	85
12.	Test Setup Photograph	86
13.	Photos of the EUT	87

Test Report Declare

Applicant	:	KAWA ELECTRONICS COMPANY LIMITED
Address	:	FLAT A 21/F CHEUNG LEE IND BLDG 9 CHEUNG LEE ST CHAI WAN HONG KONG
Equipment under Test	:	Dash cam
Model No	:	D6
Trade Mark	:	KAWA
Manufacturer	:	KAWA ELECTRONICS COMPANY LIMITED
Address	:	FLAT A 21/F CHEUNG LEE IND BLDG 9 CHEUNG LEE ST CHAI WAN HONG KONG

Test Standard Used: FCC Rules and Regulations Part 15 Subpart C.

Test procedure used: ANSI C63.10:2013, 558074 D01 15.247 Meas Guidance v05r02

We Declare:

The equipment described above is tested by Dongguan Dongdian Testing Service Co., Ltd and in the configuration tested the equipment complied with the standards specified above. The test results are contained in this test report and Dongguan Dongdian Testing Service Co., Ltd is assumed of full responsibility for the accuracy and completeness of these tests.

After test and evaluation, our opinion is that the equipment provided for test compliance with the requirement of the above FCC standards.

Report No:	DDT-R21120722-2E01		
Date of Receipt:	Dec. 31, 2021	Date of Test:	Dec. 31, 2021 ~ Jan. 27, 2022

Prepared By:

Sam Li

Sam Li/Engineer

Approved By:



Damon Hu/EMC Manager

Note: This report applies to above tested sample only. This report shall not be reproduced in parts without written approval of Dongguan Dongdian Testing Service Co., Ltd.

Revision History

Rev.	Revisions	Issue Date	Revised By
---	Initial issue	Feb. 08, 2022	

1. Summary of Test Results

The EUT have been tested according to the applicable standards as referenced below.		
Description of Test Item	Standard	Results
6 dB Bandwidth and 99% Bandwidth	FCC 15.247 (a) (2)	Pass
Conducted Output Power	FCC 15.247 (b) (3)	Pass
Power Spectral Density	FCC 15.247 (e)	Pass
Band-edge and Spurious Emissions (Conducted)	FCC 15.247 (d)	Pass
Radiated Spurious Emissions	FCC 15.247 (d) FCC 15.209 FCC 15.205	Pass
Radiated Band Edge Compliance	FCC 15.247 (d) FCC 15.209 FCC 15.205	Pass
Power Line Conducted Emission	FCC 15.207	N/A
Antenna Requirement	FCC 15.203	Pass
Note: N/A is an abbreviation for Not Applicable.		

2. General Test Information

2.1. Description of EUT

EUT* Name	: Dash cam
Model Number	: D6
EUT function description	: Please reference user manual of this device
Power Supply	: DC 5V by an external car charger.
Radio Technology	: IEEE 802.11b/g/n
Operation frequency	: IEEE 802.11b: 2412 MHz - 2462 MHz IEEE 802.11g: 2412 MHz - 2462 MHz IEEE 802.11n HT20: 2412 MHz - 2462 MHz IEEE 802.11n HT40: 2422 MHz - 2452 MHz
Modulation	: IEEE 802.11b: DSSS (CCK, DQPSK, DBPSK) IEEE 802.11g: OFDM (64QAM, 16QAM, QPSK, BPSK) IEEE 802.11n: OFDM (64QAM, 16QAM, QPSK, BPSK)
Transmitter rate	: IEEE 802.11b: 1, 2, 5.5, 11 Mbps IEEE 802.11g: 6, 9, 12, 18, 24, 36, 48, 54 Mbps IEEE 802.11n HT20: MCS0~MCS7 IEEE 802.11n HT40: MCS0~MCS7
Antenna Type	: 0.48 dBi
Sample Type	: Series production
Serial Number	: N/A

Note: EUT is the abbreviation of equipment under test.

Channel information					
CH	Frequency (MHz)	CH	Frequency (MHz)	CH	Frequency (MHz)
1	2412	5	2432	9	2452
2	2417	6	2437	10	2457
3	2422	7	2442	11	2462
4	2427	8	2447	/	/

2.2. Accessories of EUT

Assistant equipment	Manufacturer	Model number	Serial No.	Other
Car charger	N/A	CA01	N/A	Input: DC 12-24V Output: DC 5V2A
USB cable	N/A	N/A	N/A	Length: 3.50m

2.3. Assistant equipment used for test

Assistant equipment	Manufacturer	Model number	EMC Compliance	Other
N/A	N/A	N/A	N/A	N/A

2.4. Block diagram of EUT configuration for test

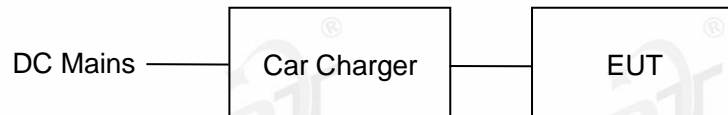

Test software: PUTTY

The test software was used to control EUT work in Continuous Tx mode, and select test channel, wireless mode as below table.

Tested mode, channel, and data rate information				
Mode	Setting Tx Power	data rate (Mbps) (see Note)	Channel	Frequency (MHz)
IEEE 802.11b	48	11	LCH: CH1	2412
	48	11	MCH: CH6	2437
	48	11	HCH: CH11	2462
IEEE 802.11g	48	54	LCH: CH1	2412
	48	54	MCH: CH6	2437
	48	54	HCH: CH11	2462
IEEE 802.11n HT20	48	MCS7	LCH: CH1	2412
	48	MCS7	MCH: CH6	2437
	48	MCS7	HCH: CH11	2462
IEEE 802.11n HT40	48	MCS7	LCH: CH3	2422
	48	MCS7	MCH: CH6	2437
	48	MCS7	HCH: CH9	2452

Note: According exploratory test, EUT will have maximum output power in those data rate, so those data rate were used for all test.

2.5. Deviations of test standard

No deviation

2.6. Test environment conditions

During the measurement the environmental conditions were within the listed ranges:

Temperature range:	21-25 °C
Humidity range:	40-75%
Pressure range:	86-106 kPa

2.7. Test laboratory

Dongguan Dongdian Testing Service Co., Ltd.

Add.: No. 17, Zongbu Road 2, Songshan Lake Sci&Tech, Industry Park, Dongguan City, Guangdong Province, China, 523808.

Tel.: +86-0769-38826678, <http://www.dgddt.com>, Email: ddt@dgddt.com.

CNAS Accreditation No. L6451; A2LA Accreditation Number: 3870.01

FCC Designation Number: CN1182, Test Firm Registration Number: 540522

Innovation, Science and Economic Development Canada Site Registration Number: 10288A

Conformity Assessment Body identifier: CN0048

VCCI facility registration number: C-20087, T-20088, R-20123, G-20118

2.8. Measurement uncertainty

Test Item	Uncertainty
Bandwidth	1.1%
Peak Output Power (Conducted) (Spectrum Analyzer)	0.86 dB (10 MHz ≤ f < 3.6 GHz);
	1.38 dB (3.6 GHz ≤ f < 8 GHz)
Peak Output Power (Conducted) (Power Sensor)	0.74 dB
Power Spectral Density	0.74 dB (10 MHz ≤ f < 3.6 GHz);
	1.38 dB (3.6 GHz ≤ f < 8 GHz)
Frequencies Stability	6.7 x 10 ⁻⁸ (Antenna couple method)
	5.5 x 10 ⁻⁸ (Conducted method)
Conducted Spurious Emissions	0.86 dB (10 MHz ≤ f < 3.6 GHz);
	1.40 dB (3.6 GHz ≤ f < 8 GHz)
	1.66 dB (8 GHz ≤ f < 22 GHz)
Uncertainty for Radio Frequency (RBW < 20 kHz)	3x10 ⁻⁸
Temperature	0.4 °C
Humidity	2 %
Uncertainty for Radiation Emission Test (9 kHz – 30 MHz)	3.44 dB
Uncertainty for Radiation Emission Test (30 MHz - 1 GHz)	4.70 dB (Antenna Polarize: V)
	4.84 dB (Antenna Polarize: H)
Uncertainty for Radiation Emission Test (1 GHz - 40 GHz)	4.10 dB (1 - 6 GHz)
	4.40 dB (6 GHz - 18 GHz)
	3.54 dB (18 GHz - 26 GHz)
	4.30 dB (26 GHz - 40 GHz)
Uncertainty for Power Line Conduction Emission Test	3.32 dB (150 kHz - 30 MHz)
Note: This uncertainty represents an expanded uncertainty expressed at approximately the 95% confidence level using a coverage factor of k=2.	

3. Equipment Used During Test

Equipment	Manufacturer	Model No.	Serial No.	Last Cal.	Cal. Interval
<input checked="" type="checkbox"/> RF Connected Test (Tonscend RF Measurement System 1#)					
Spectrum analyzer	R&S	FSU26	200071	Sep. 02, 2021	1 Year
Wideband Radio Communication tester	R&S	CMW500	120259	Sep. 02, 2021	1 Year
Vector Signal Generator	Agilent	E8267D	US49060192	Sep. 18, 2021	1 Year
Vector Signal Generator	Agilent	N5182A	MY48180737	Jun. 01, 2021	1 Year
RF Control Unit	Tonsend	JS0806-2	158060010	Jun. 01, 2021	1 Year
Temp&Humi Programmable	ZHIXIANG	ZXGDJS-150L	ZX170110-A	Jun. 01, 2021	1 Year
Test Software	JS Tonscend	JS1120-3	Ver.2.6.77.0518	N/A	N/A
<input type="checkbox"/> RF Connected Test (Tonscend RF Measurement System 3#)					
Signal analyzer	R&S	FSQ26	101272	Jun. 01, 2021	1 Year
Wideband Radio Communication tester	R&S	CMW500	117491	Jun. 01, 2021	1 Year
Vector Signal Generator	Agilent	N5182A	MY19060405	Jun. 01, 2021	1 Year
Vector Signal Generator	Agilent	N5182A	MY48180912	Jun. 01, 2021	1 Year
RF Control Unit	Tonsend	JS0806-2	DDT-ZC01449	Jun. 01, 2021	1 Year
Temp&Humi Programmable	ZHIXIANG	ZXGDJS-150L	ZX170110-A	Jun. 01, 2021	1 Year
Test Software	JS Tonscend	JS1120-3	Ver.2.6.77.0518	N/A	N/A
<input type="checkbox"/> RF Connected Test (Tonscend RF Measurement System 4#)					
MXA Signal Analyzer	Agilent	N9020A	MY49100362	Sep. 02, 2021	1 Year
Wideband Radio Communication tester	R&S	CMW500	120259	Jun. 01, 2021	1 Year
MXG Vector Signal Generator	Agilent	N5182B	MY59100192	Jun. 01, 2021	1 Year
Vector Signal Generator	Agilent	E8267D	US49060192	Sep. 18, 2021	1 Year
RF Control Unit	Tonsend	JS0806-2	2118060485	Oct. 18, 2021	1 Year
Temp&Humi Programmable	ZHIXIANG	ZXGDJS-150L	ZX170110-A	Jun. 01, 2021	1 Year
Test Software	JS Tonscend	JS1120-3	Ver.2.6.88.0346	N/A	N/A
<input checked="" type="checkbox"/> Radiation 3#chamber					
EMI Test Receiver	R&S	ESU	100472	Jun. 01, 2021	1 Year
Spectrum analyzer	Agilent	E4447A	MY50180031	Jun. 01, 2021	1 Year
Active Loop antenna	Schwarzbeck	FMZB-1519	1519-038	Sep. 19, 2021	1 Year
Trilog Broadband Antenna	Schwarzbeck	VULB 9163	01429	Aug. 07, 2021	1 Year
Double Ridged Horn Antenna	Schwarzbeck	BBHA9120	02108	Jul. 17, 2021	1 Year
Broad Band Horn Antenna	Schwarzbeck	BBHA 9170	790	May 08, 2021	1 Year
Pre-amplifier	COM-POWER	PAM-118A	18040084	Sep. 02, 2021	1 Year

Pre-amplifier	COM-POWER	PAM-840A	461369	Mar. 15, 2021	1 Year
Test software	Audix	E3	V 6.1.1.1	N/A	N/A
<input type="checkbox"/> Power Line Conducted Emissions Test 1#					
Test Receiver	R&S	ESCI	100551	Sep. 02, 2021	1 Year
LISN 1	R&S	ENV216	101109	Sep. 02, 2021	1 Year
LISN 2	R&S	ESH2-Z5	100309	Sep. 02, 2021	1 Year
Pulse Limiter	R&S	ESH3-Z2	101242	Sep. 02, 2021	1 Year
CE Cable 1	HUBSER	N/A	W10.01	Sep. 02, 2021	1 Year
LISN 3	SCHWARZBECK	NSLK 8163	00017	Sep. 02, 2021	1 Year
Test software	Audix	E3	V 6.11111b	N/A	N/A
<input type="checkbox"/> Power Line Conducted Emissions Test 2#					
Test Receiver	R&S	ESCI	101028	Sep. 02, 2021	1 Year
LISN 1	R&S	ENV216	101170	Sep. 02, 2021	1 Year
Pulse Limiter	R&S	KH43101	431011801568-1 2#	Jun. 01, 2021	1 Year
CE Cable 2	HUBSER	RG214-5	N/A	Jun. 01, 2021	1 Year
Test software	Audix	E3	V 6.11111b	N/A	N/A

4. 6 dB Bandwidth and 99% Bandwidth

4.1. Block diagram of test setup

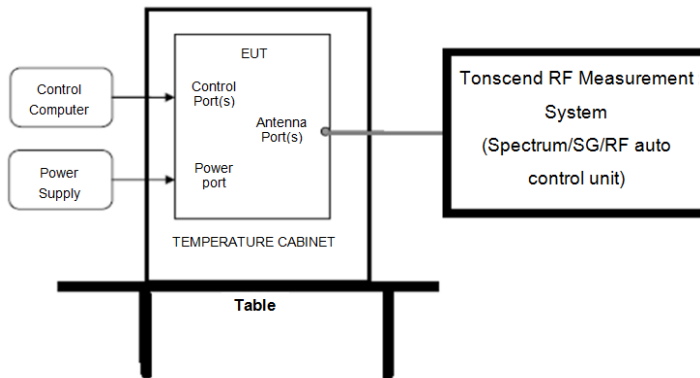

4.2. Limits

For direct sequence systems, the minimum 6 dB bandwidth shall be at least 500 kHz

4.3. Test procedure

(1) Connect EUT's antenna output to spectrum analyzer by RF cable.

(2) 99% Bandwidth set the spectrum analyzer as follows:

RBW: 500 kHz / 1MHz

VBW: 2 MHz / 3MHz

Detector Mode: Peak

Sweep time: auto

Trace mode Max hold

(3) 6 dB Bandwidth set the spectrum analyzer as follows:

RBW: 100 kHz

VBW: 300 kHz

Detector Mode: Peak

Sweep time: auto

Trace mode Max hold

(4) Allow the trace to stabilize, measure the maximum width of the emission that is constrained by the frequencies associated with the two outermost amplitude points (upper and lower frequencies) that are attenuated by 6 dB relative to the maximum level measured in the fundamental emission.

4.4. Test result

Test Mode	Test	Ant	6 dB Bandwidth [MHz]	Limit [MHz]	Verdict
11B	2412	Ant1	9.640	0.5	Pass
11B	2437	Ant1	9.480	0.5	Pass
11B	2462	Ant1	9.480	0.5	Pass
11G	2412	Ant1	16.520	0.5	Pass
11G	2437	Ant1	16.560	0.5	Pass
11G	2462	Ant1	16.520	0.5	Pass
11N20SISO	2412	Ant1	17.840	0.5	Pass
11N20SISO	2437	Ant1	17.840	0.5	Pass
11N20SISO	2462	Ant1	17.800	0.5	Pass
11N40SISO	2422	Ant1	36.480	0.5	Pass
11N40SISO	2437	Ant1	36.480	0.5	Pass
11N40SISO	2452	Ant1	36.480	0.5	Pass

Test Mode	Test	Ant	99% OBW [MHz]	Limit [MHz]	Verdict
11B	2412	Ant1	15.560	---	Pass
11B	2437	Ant1	15.560	---	Pass
11B	2462	Ant1	15.600	---	Pass
11G	2412	Ant1	17.560	---	Pass
11G	2437	Ant1	17.520	---	Pass
11G	2462	Ant1	17.600	---	Pass
11N20SISO	2412	Ant1	18.520	---	Pass
11N20SISO	2437	Ant1	18.480	---	Pass
11N20SISO	2462	Ant1	18.480	---	Pass
11N40SISO	2422	Ant1	37.280	---	Pass
11N40SISO	2437	Ant1	37.120	---	Pass
11N40SISO	2452	Ant1	37.440	---	Pass

4.5. Original test data

6 dB Bandwidth:

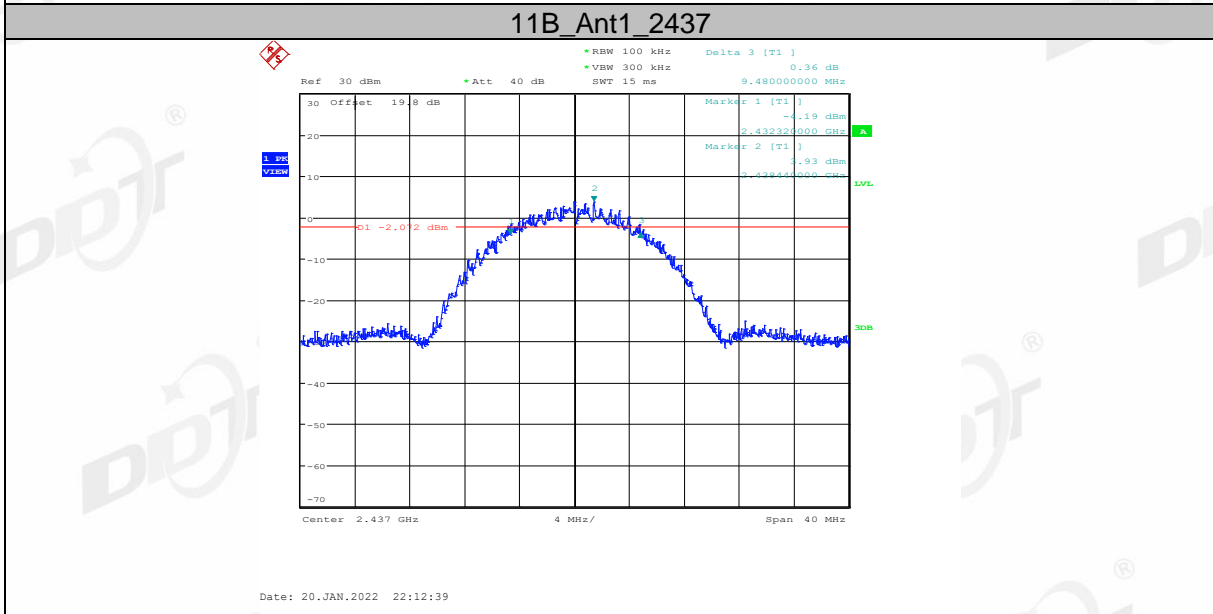
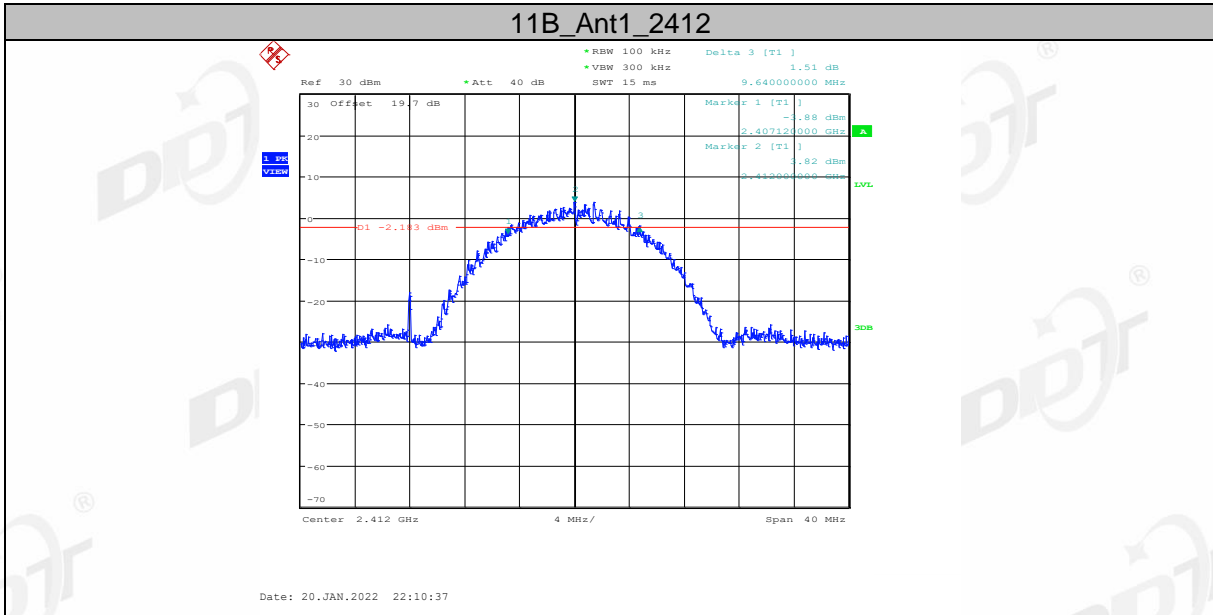

11B_Ant1_2462

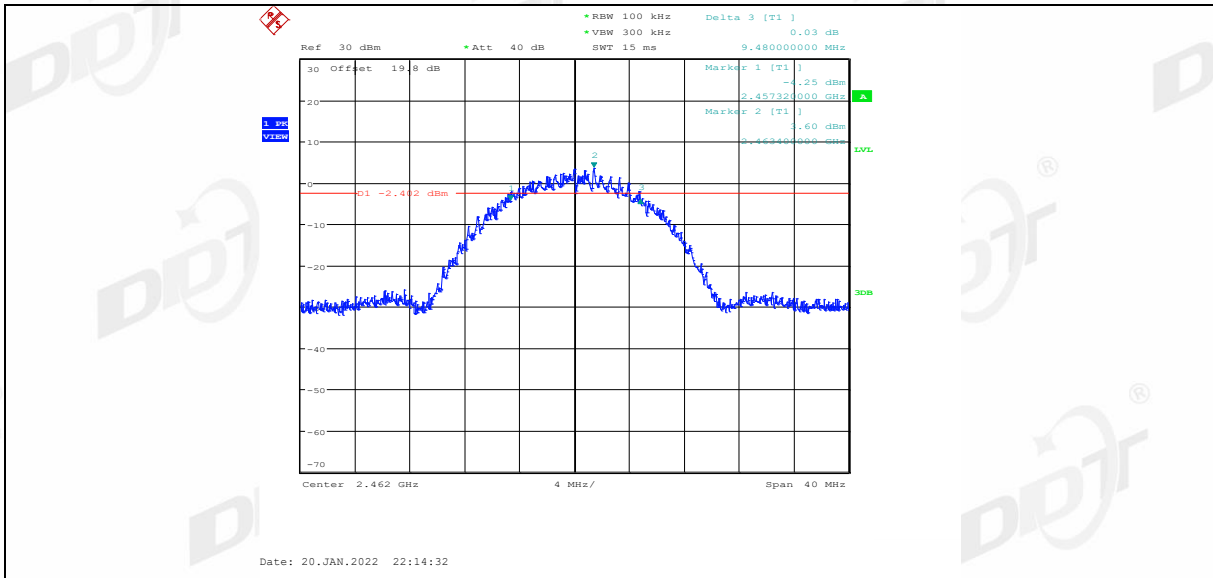

11G_Ant1_2412

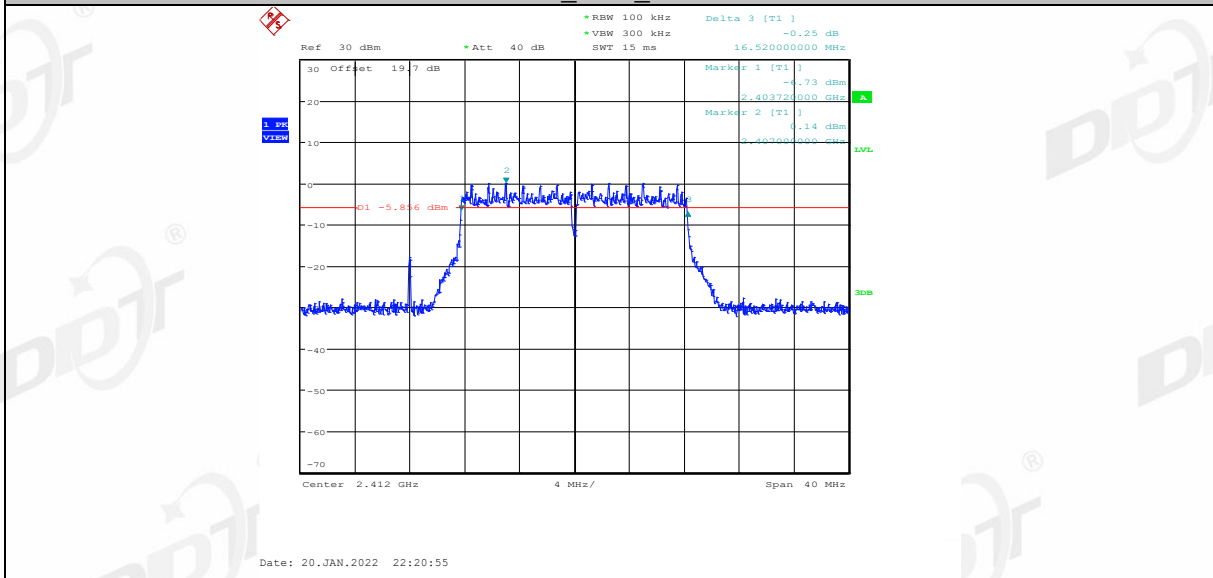

11G_Ant1_2437

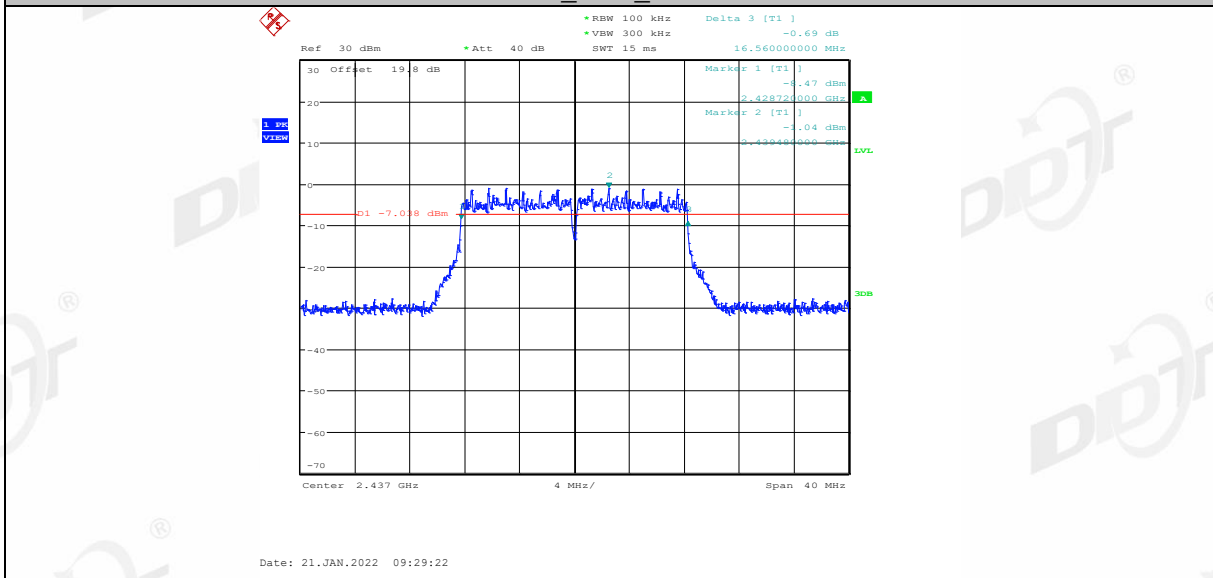

11G_Ant1_2462

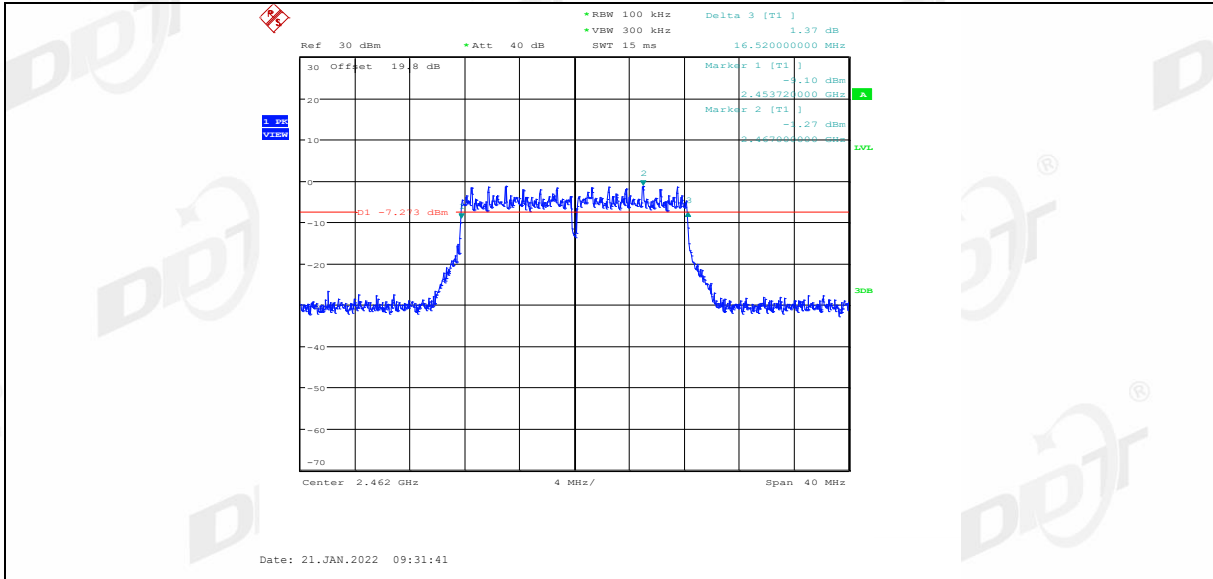

11N20SISO_Ant1_2412

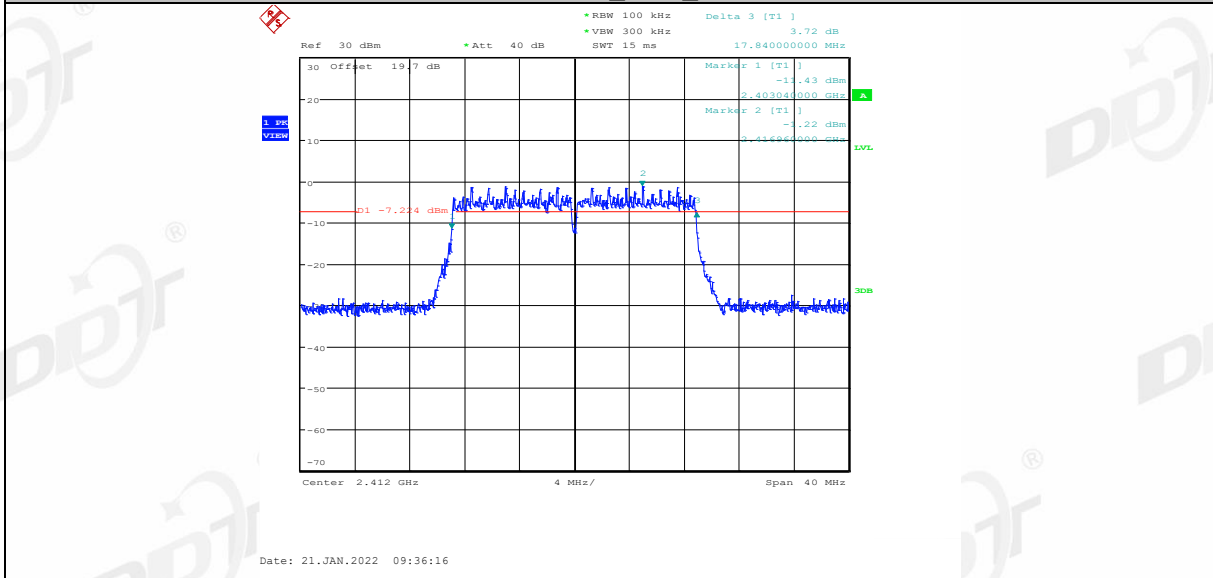

11N20SISO_Ant1_2437

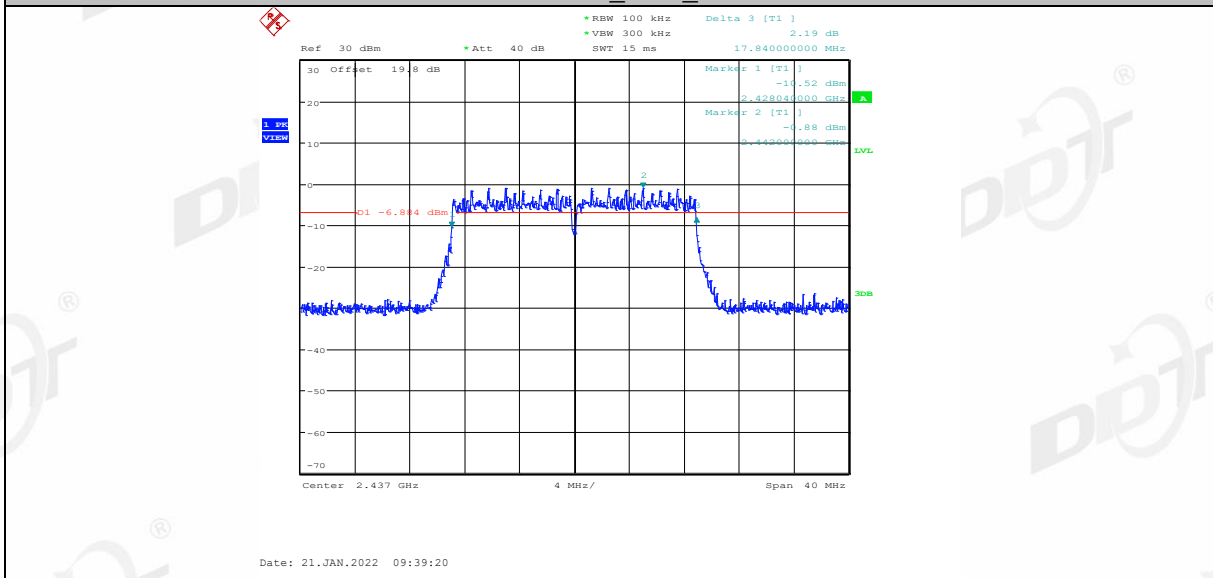

11N20SISO_Ant1_2462

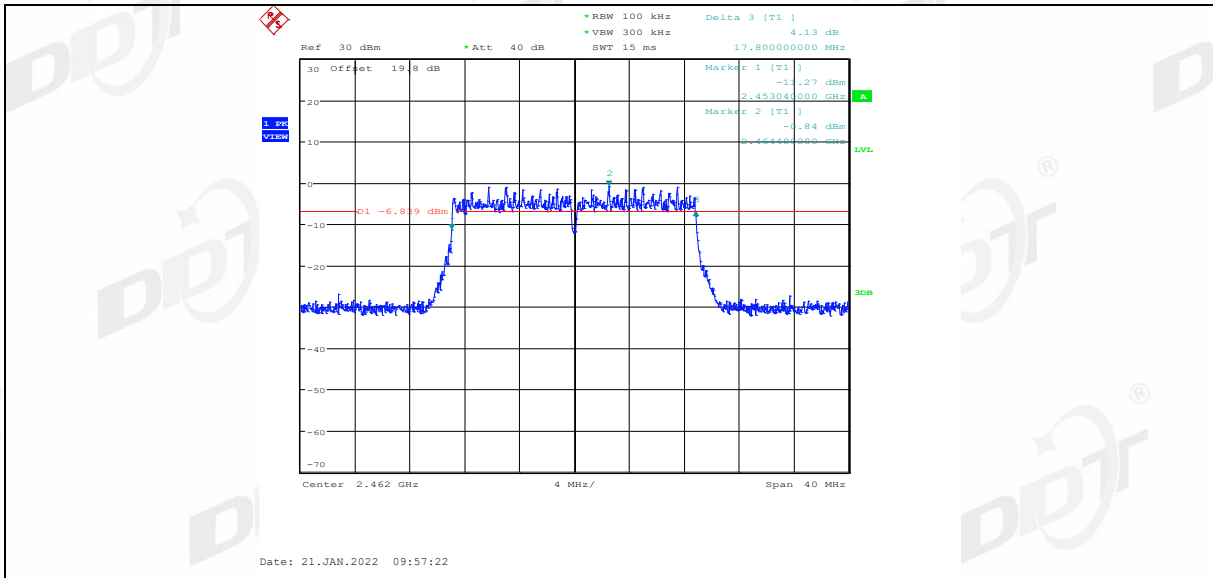

11N40SISO_Ant1_2422

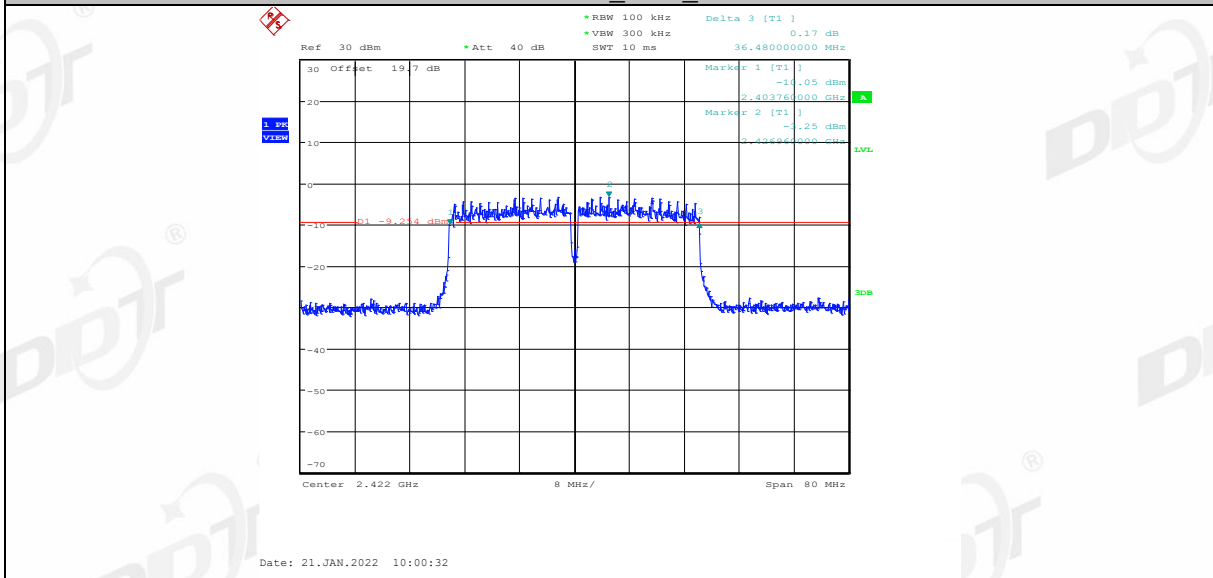

11N40SISO_Ant1_2437

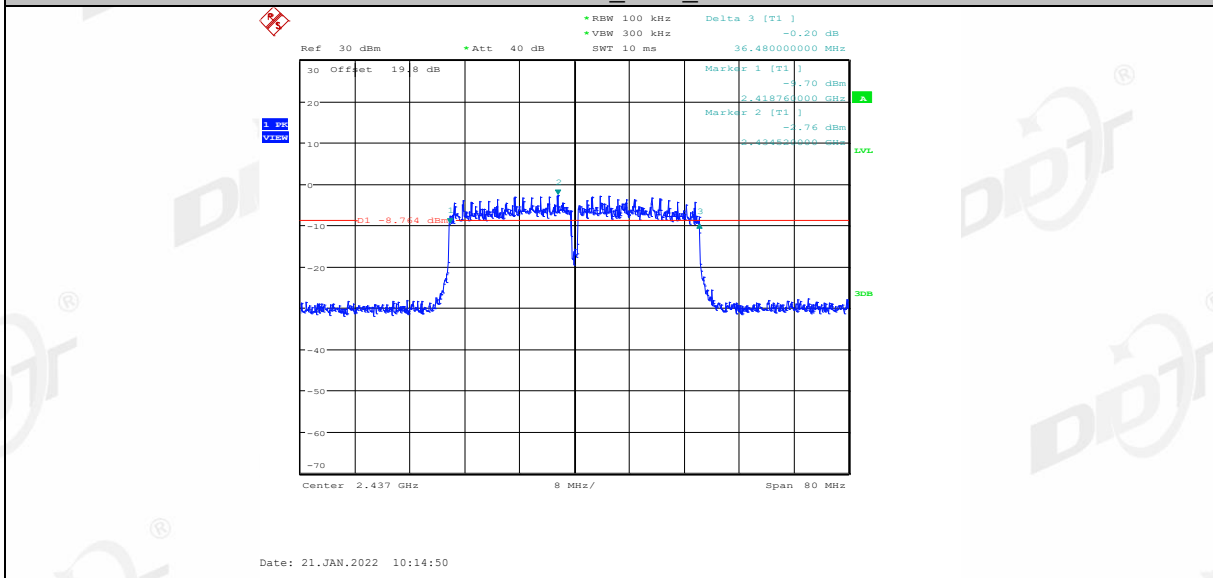

11N40SISO_Ant1_2452

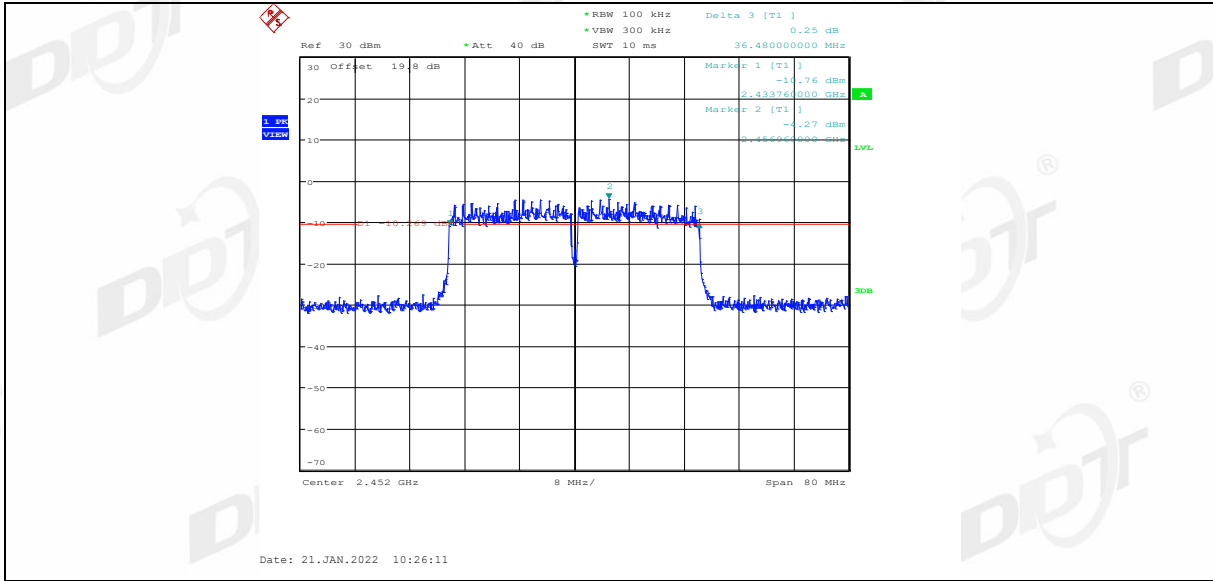

99% Bandwidth:

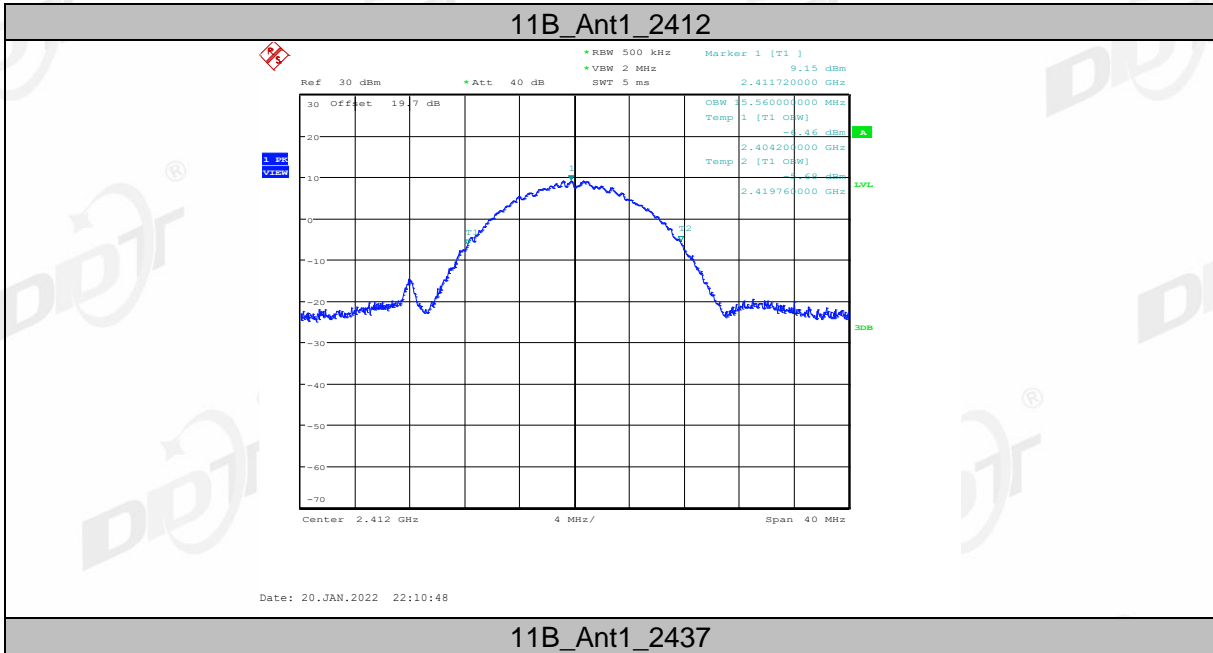

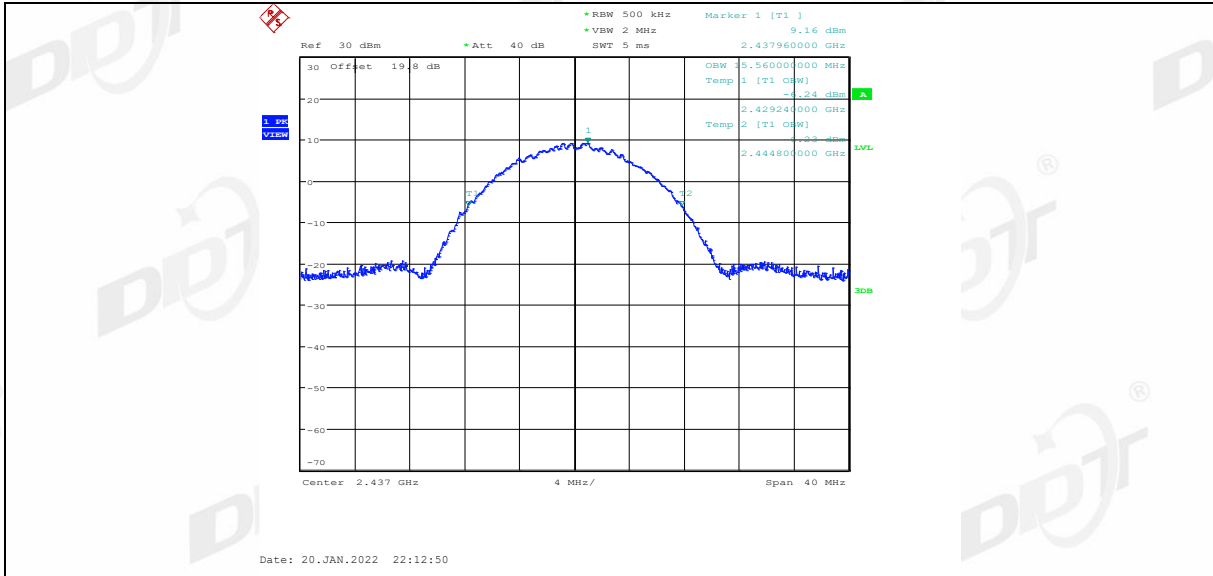

11B_Ant1_2462

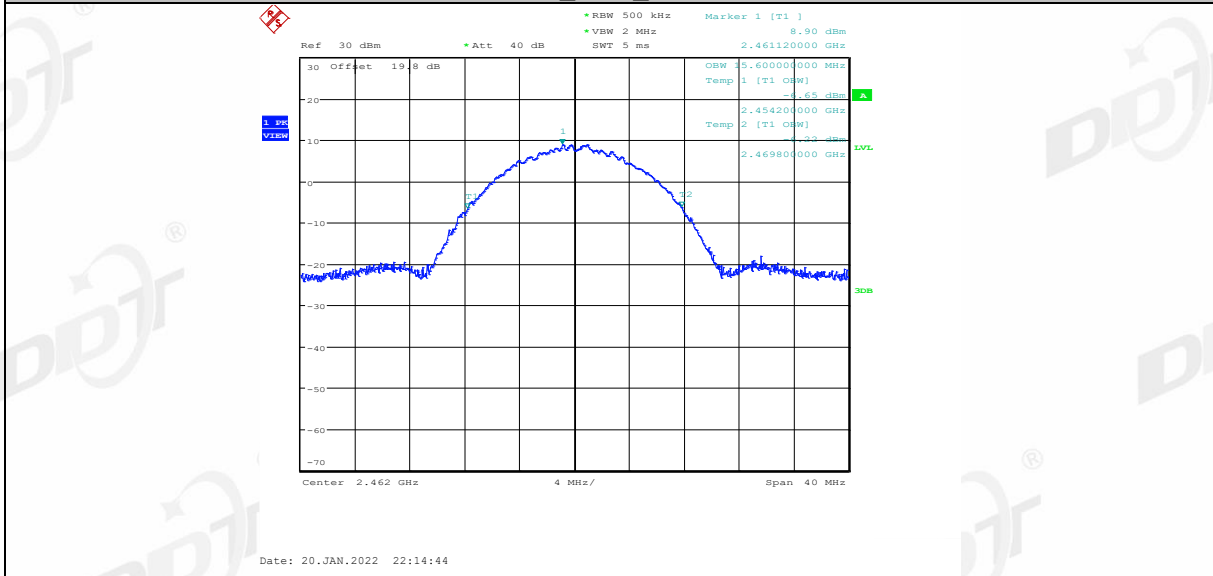

11G_Ant1_2412

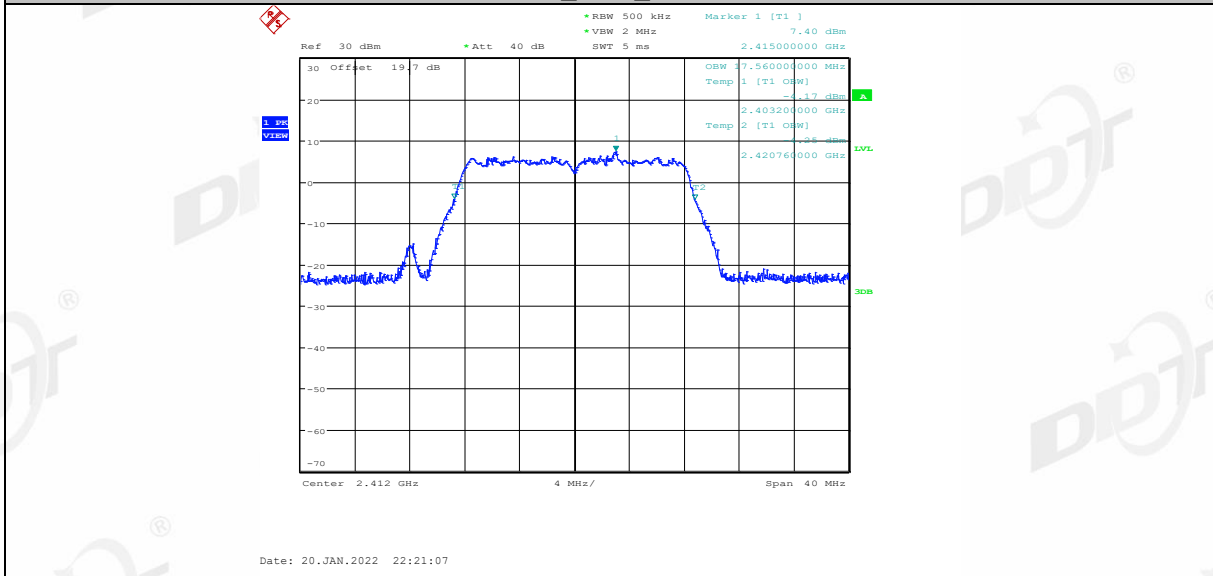

11G_Ant1_2437

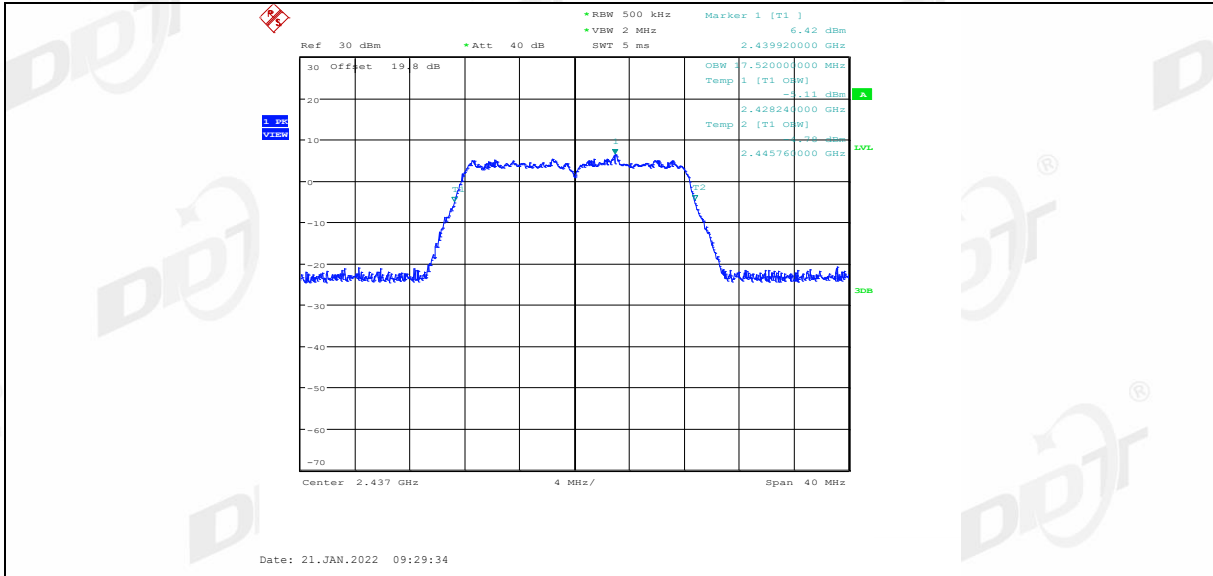

11G_Ant1_2462

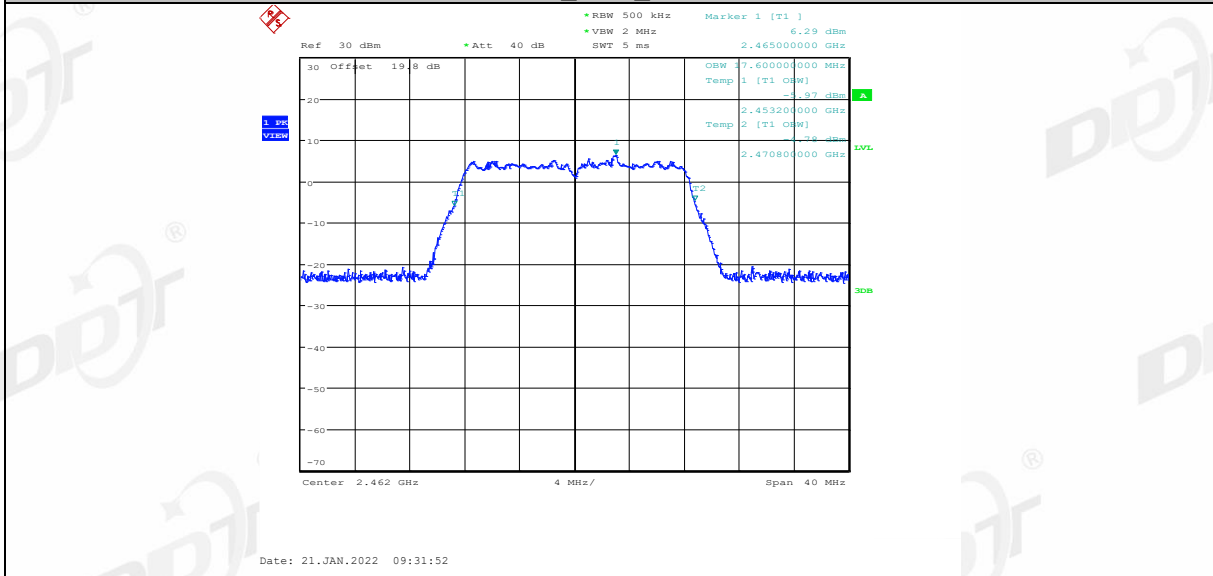

11N20SISO_Ant1_2412

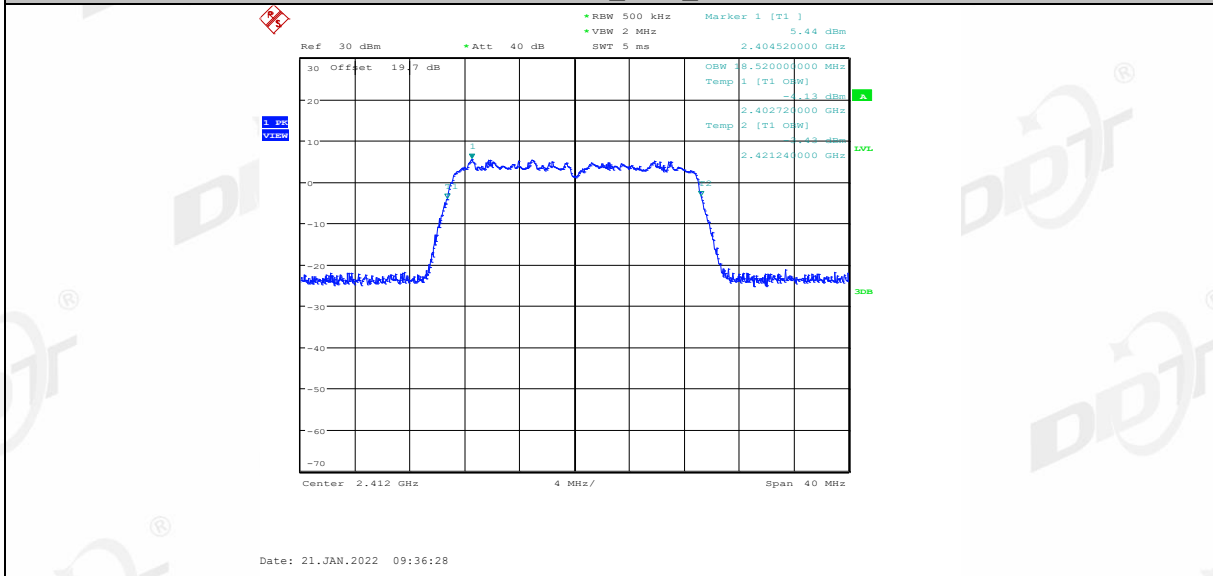

11N20SISO_Ant1_2437

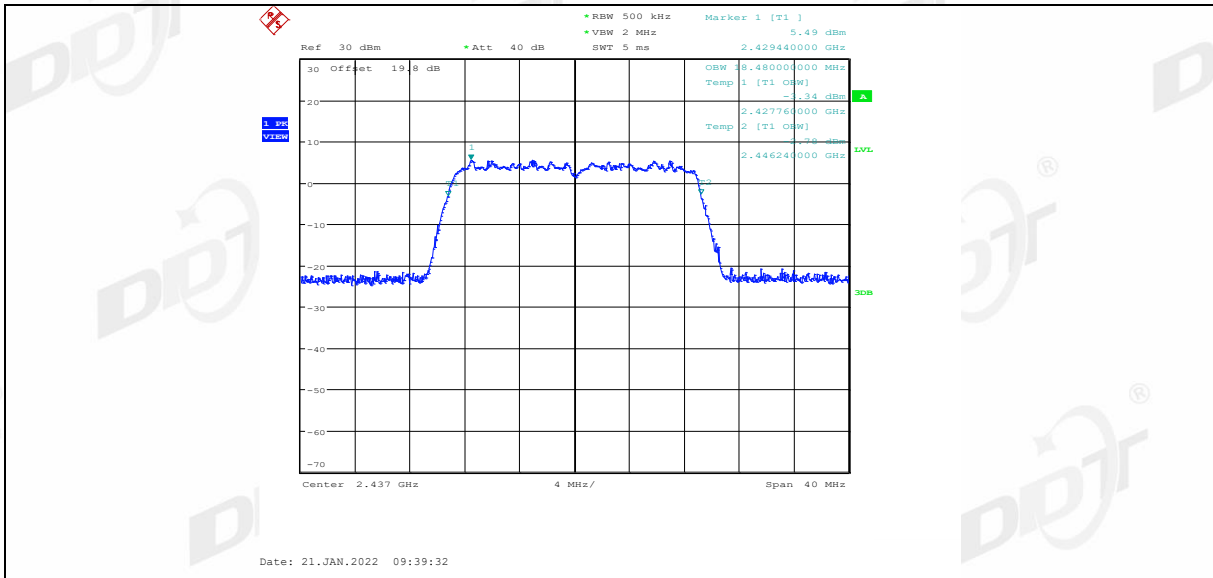

11N20SISO_Ant1_2462

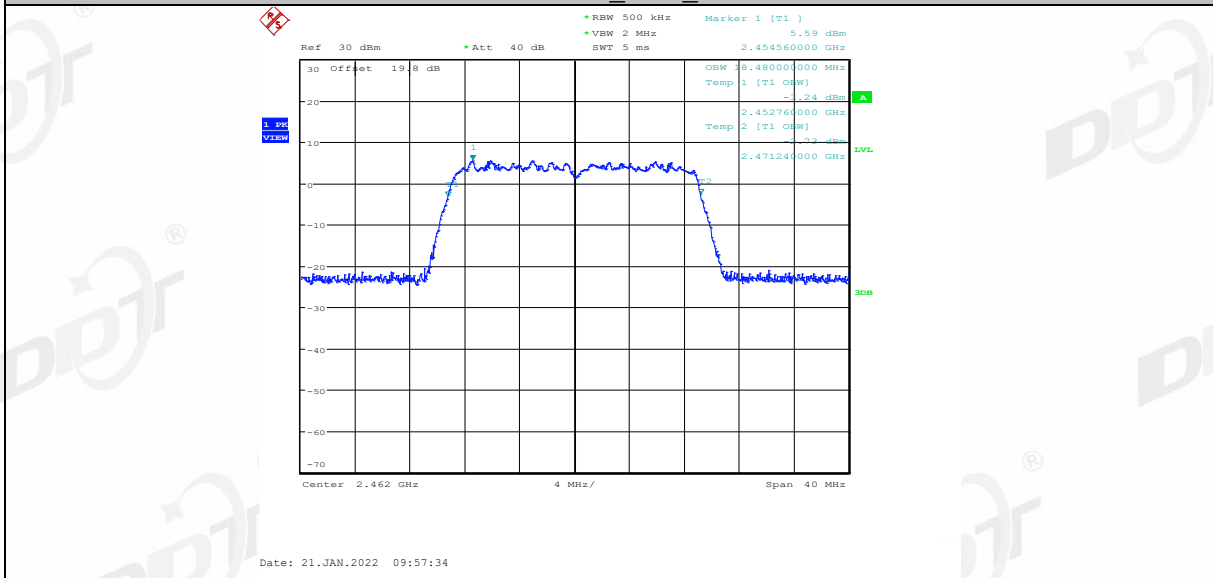

11N40SISO_Ant1_2422

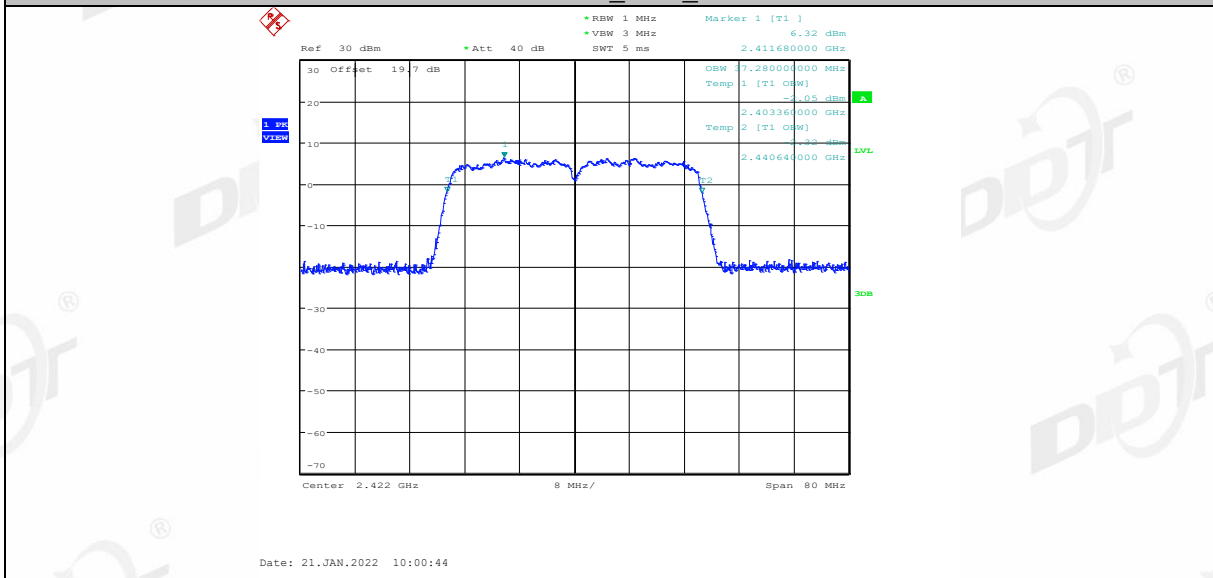

11N40SISO_Ant1_2437

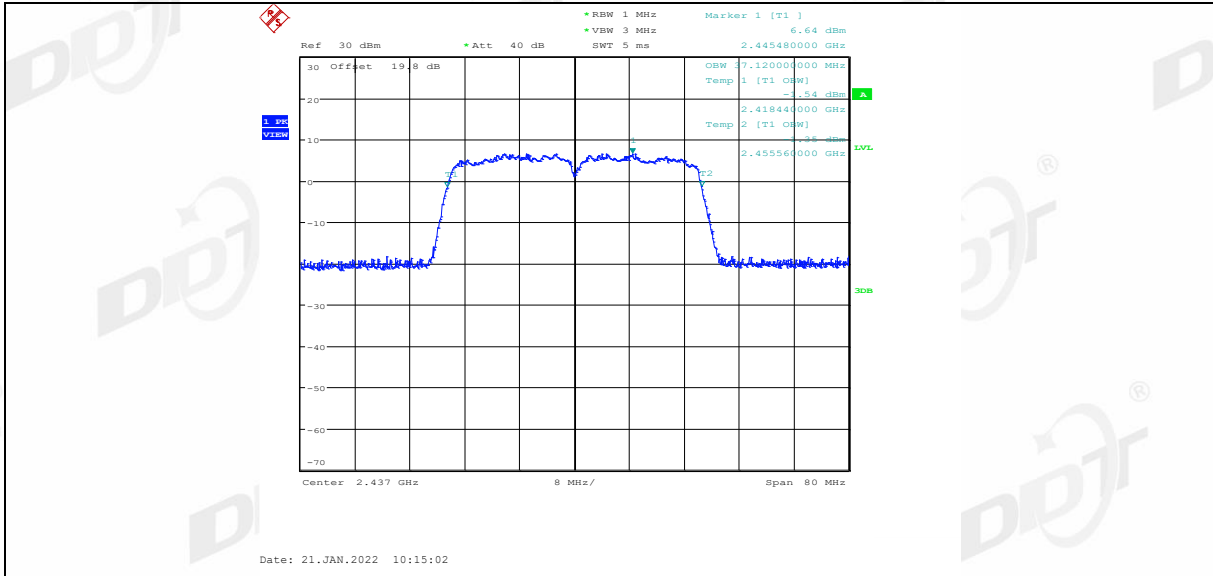

11N40SISO_Ant1_2452

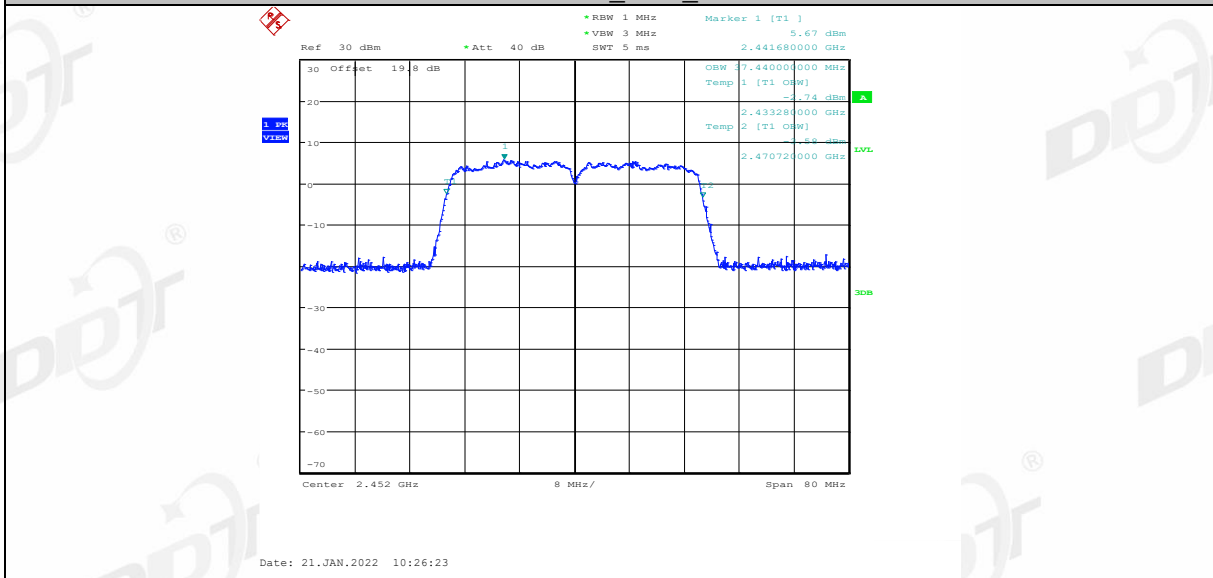

5. Conducted Peak Output Power

5.1. Block diagram of test setup

Same as section 4.1

5.2. Limits

For systems using digital modulation in the 902 - 928 MHz, 2400 - 2483.5 MHz, and 5725 - 5850 MHz bands: 1 Watt. If transmitting antennas of directional gain greater than 6 dBi are used, the conducted output power from the intentional radiator shall be reduced below the stated values as appropriate, by the amount in dB that the directional gain of the antenna exceeds 6 dBi.

5.3. Test procedure

Connect each EUT's antenna output to power sensor by RF cable and attenuator

Measure the PK output power of each antenna port by power sensor

5.4. Test result

Test Mode	Test Channel	Ant	Power [dBm]	Limit [dBm]	Verdict
11B	2412	ANT1	15.29	30	Pass
11B	2437	ANT1	15.22	30	Pass
11B	2462	ANT1	15.08	30	Pass
11G	2412	ANT1	13.78	30	Pass
11G	2437	ANT1	14.08	30	Pass
11G	2462	ANT1	14.01	30	Pass
11N20SISO	2412	ANT1	13.76	30	Pass
11N20SISO	2437	ANT1	13.74	30	Pass
11N20SISO	2462	ANT1	13.63	30	Pass
11N40SISO	2422	ANT1	13.90	30	Pass
11N40SISO	2437	ANT1	13.88	30	Pass
11N40SISO	2452	ANT1	13.84	30	Pass

6. Power Spectral Density

6.1. Block diagram of test setup

Same as section 4.1

6.2. Limits

For digitally modulated systems, the power spectral density conducted from the intentional radiator to the antenna shall not be greater than 8 dBm in any 3 kHz band during any time interval of continuous transmission.

6.3. Test procedure

(1) Connect EUT's antenna output to spectrum analyzer by RF cable.

(2) Set the spectrum analyzer as follows:

Center frequency	DTS Channel center frequency
RBW:	$3 \text{ kHz} \leq \text{RBW} \leq 100 \text{ kHz}$
VBW:	$\geq 3\text{RBW}$
Span	1.5 times the DTS bandwidth
Detector Mode:	Peak
Sweep time:	auto
Trace mode	Max hold

(3) Allow the trace to stabilize, use the peak marker function to determine the maximum amplitude level within the RBW.

(4) If measured value exceeds limit, reduce RBW (no less than 3 kHz) and repeat.

6.4. Test result

Test Mode	Antenna	Channel [MHz]	Result [dBm/ 3 kHz]	Limit [dBm/ 3 kHz]	Verdict
11B	ANT1	2412	-8.80	8	Pass
11B	ANT1	2437	-8.47	8	Pass
11B	ANT1	2462	-8.85	8	Pass
11G	ANT1	2412	-13.76	8	Pass
11G	ANT1	2437	-13.43	8	Pass
11G	ANT1	2462	-12.90	8	Pass
11N20SISO	ANT1	2412	-14.15	8	Pass
11N20SISO	ANT1	2437	-12.59	8	Pass
11N20SISO	ANT1	2462	-14.46	8	Pass
11N40SISO	ANT1	2422	-17.12	8	Pass
11N40SISO	ANT1	2437	-16.78	8	Pass
11N40SISO	ANT1	2452	-16.97	8	Pass

6.5. Original test data

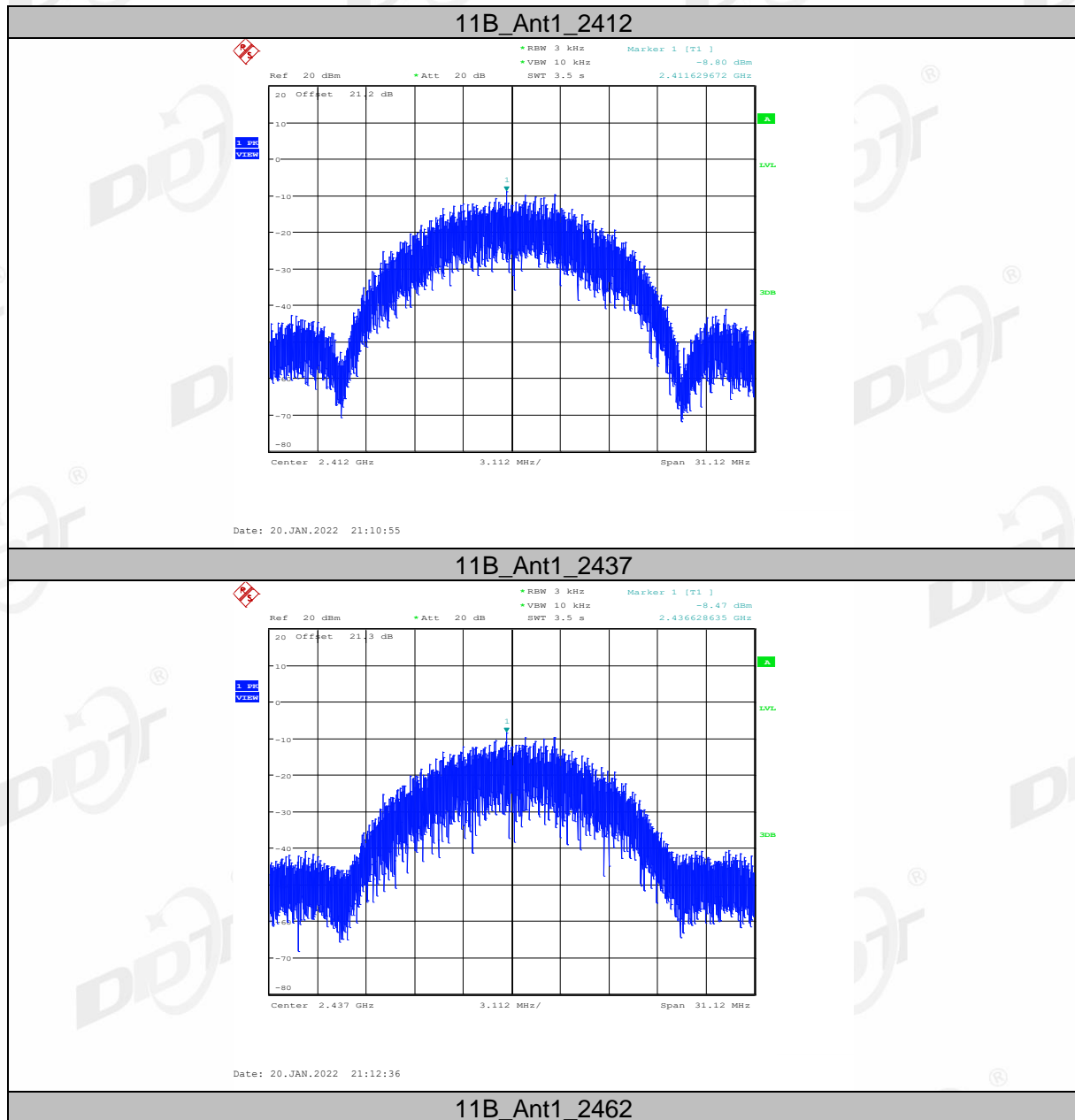

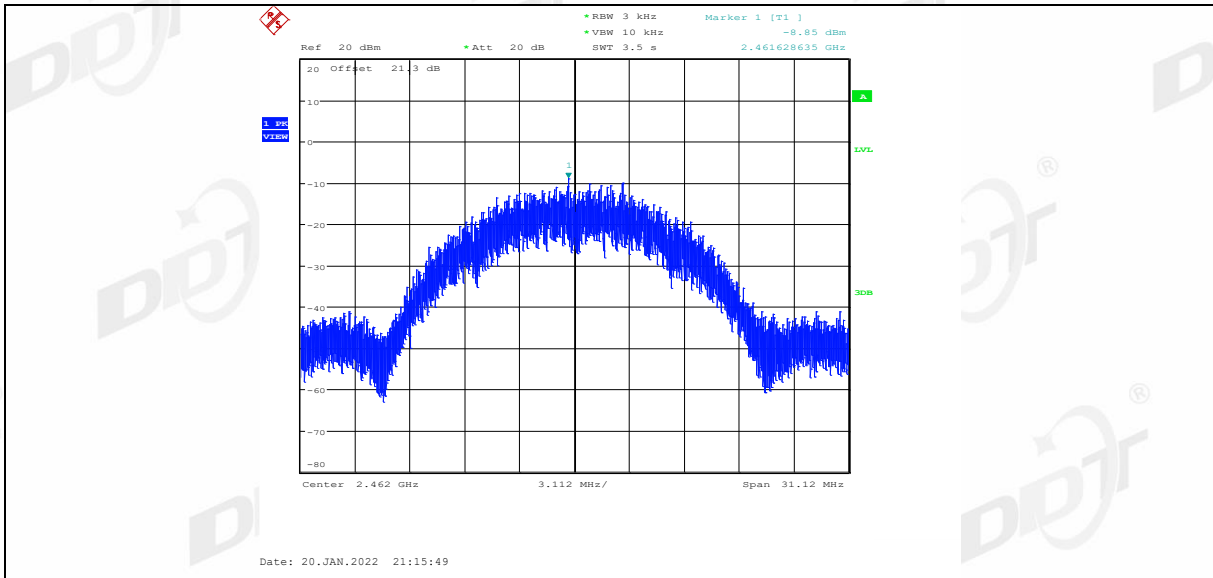

11G_Ant1_2412

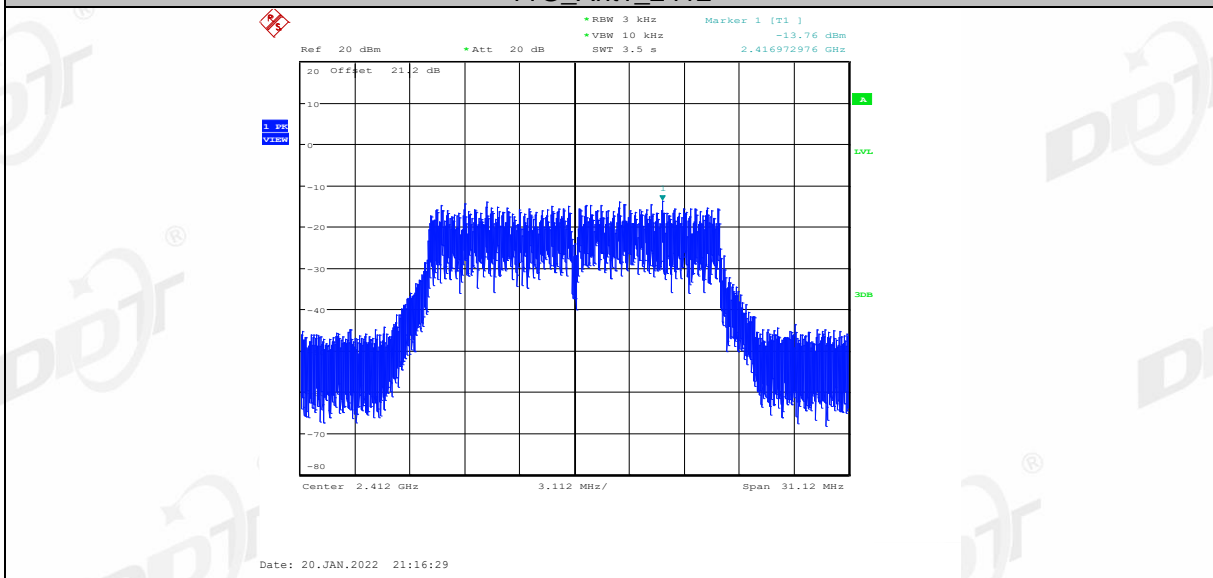

11G_Ant1_2437

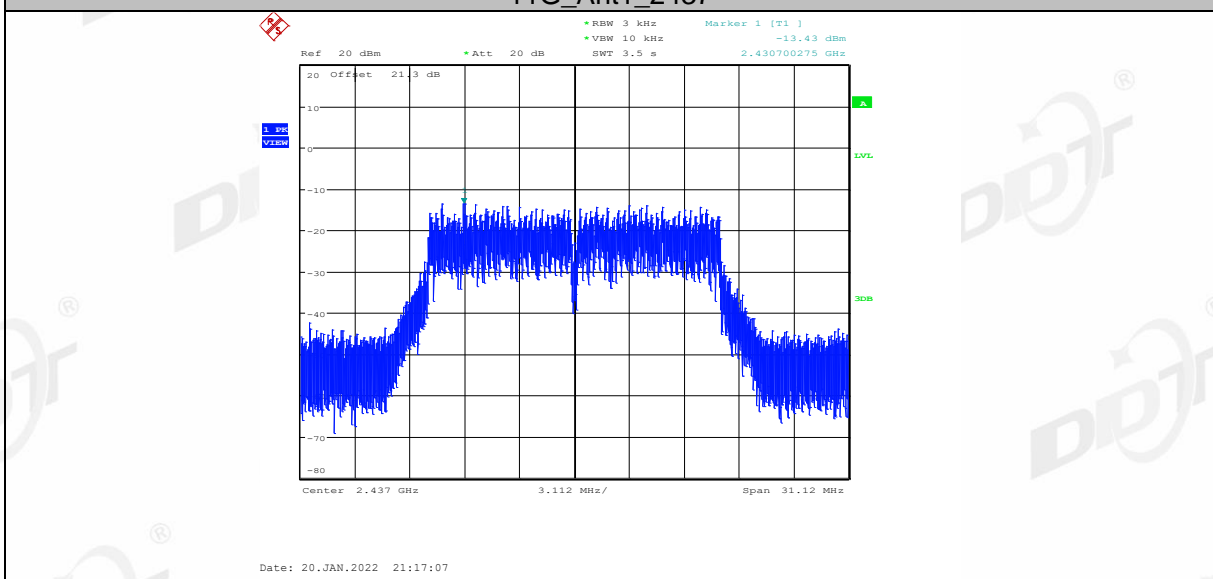

11G_Ant1_2462

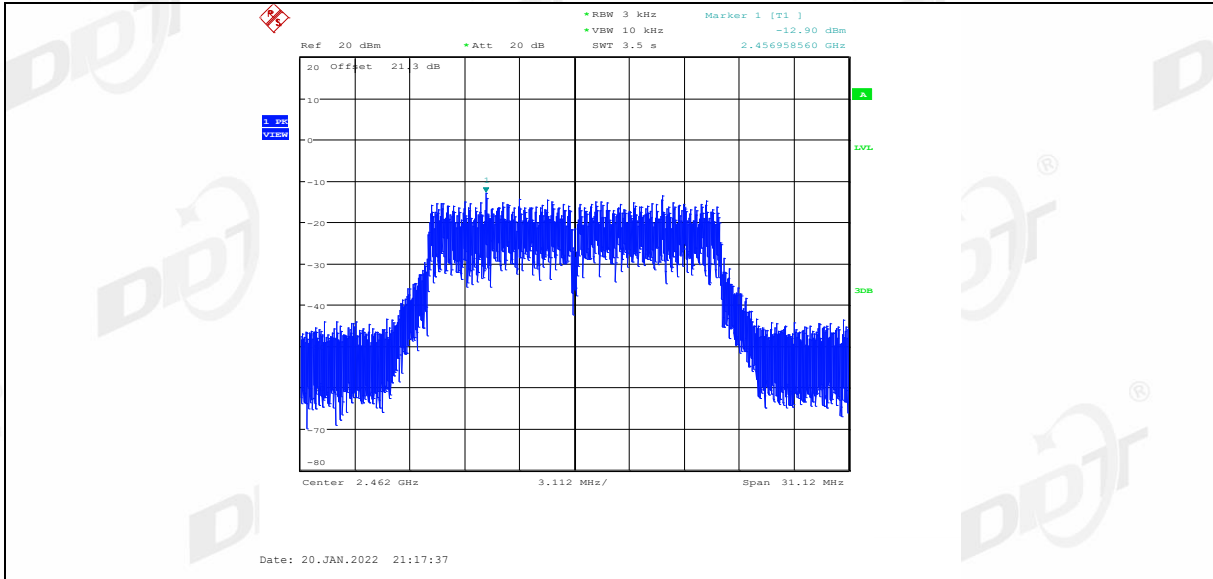

11N20SISO_Ant1_2412

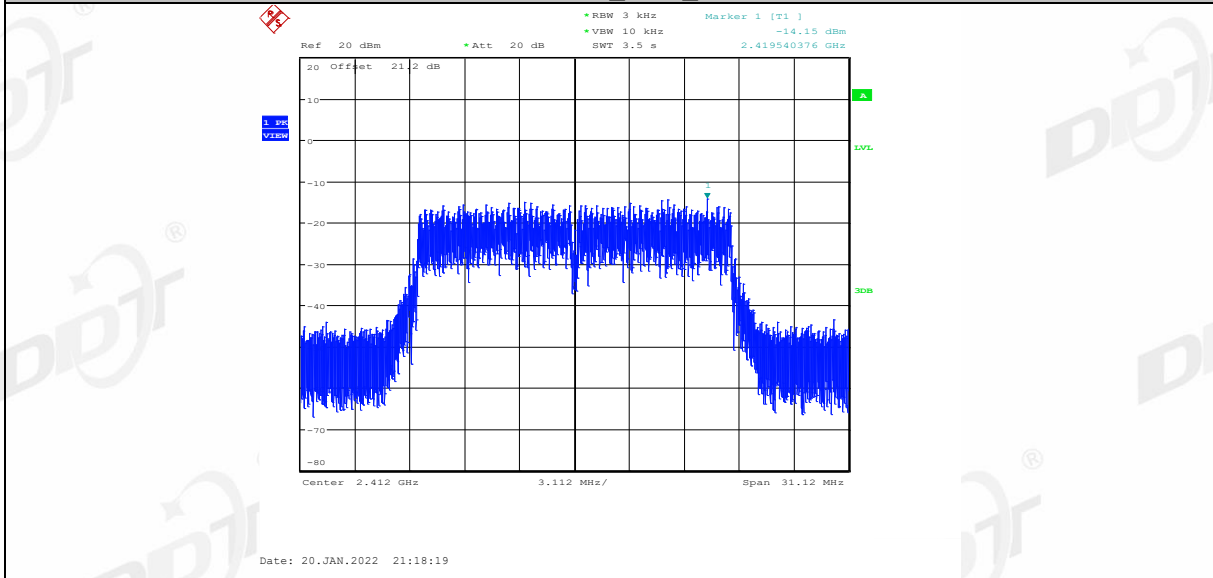

11N20SISO_Ant1_2437

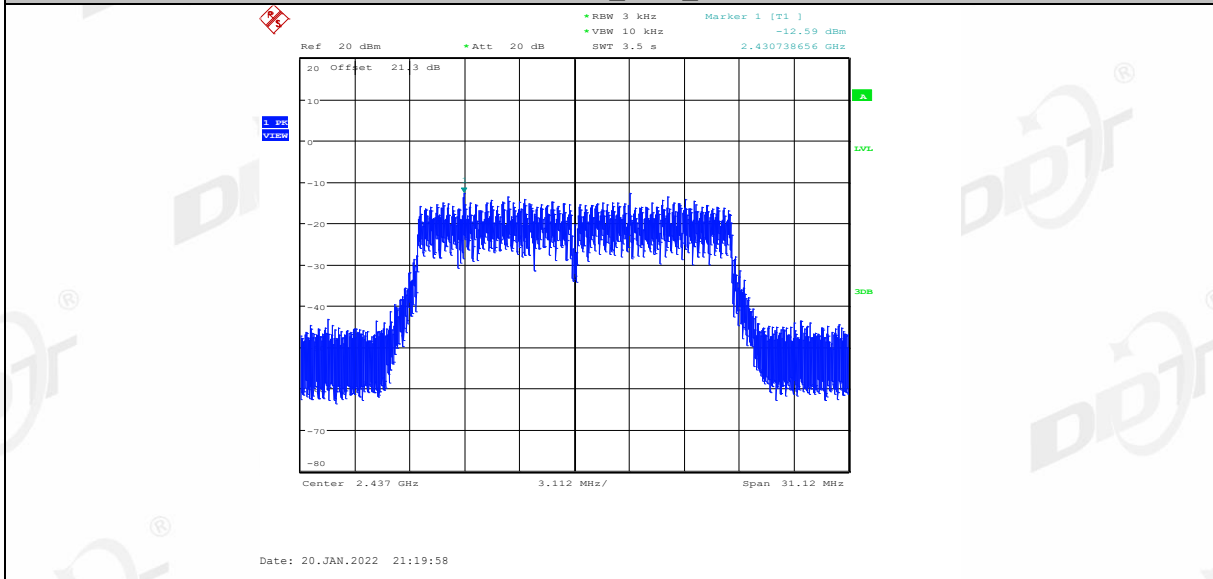

11N20SISO_Ant1_2462

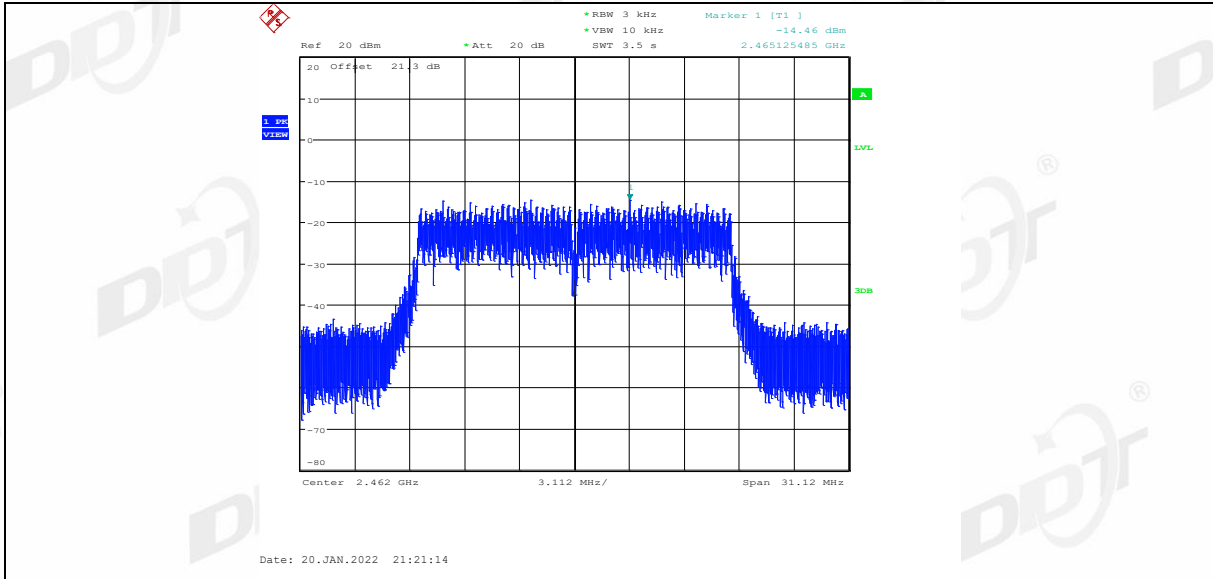

11N40SISO_Ant1_2422

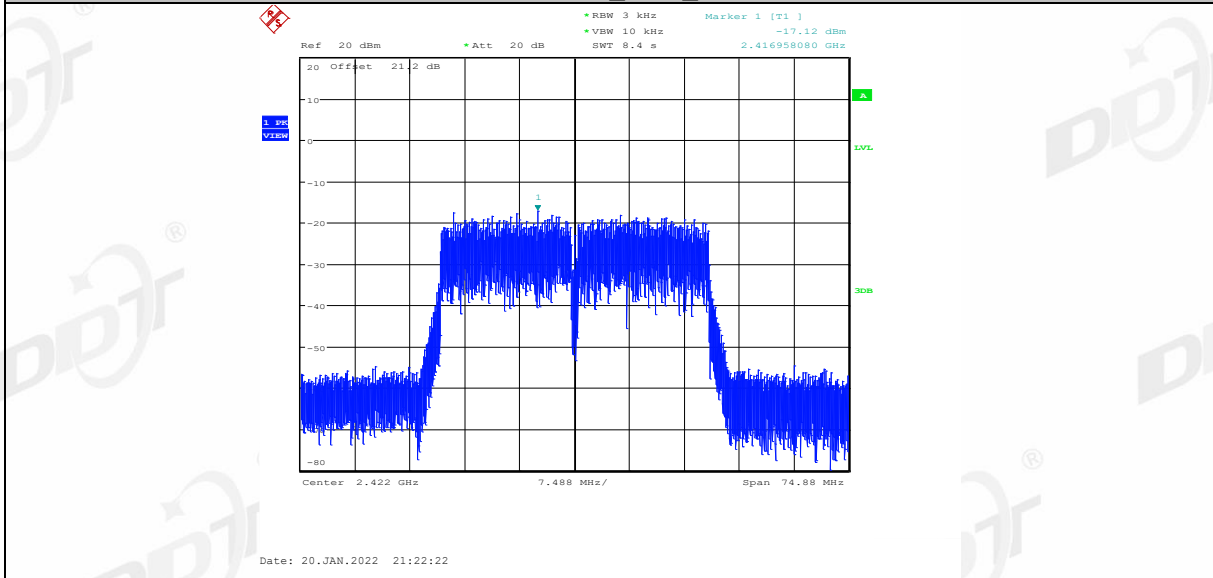

11N40SISO_Ant1_2437

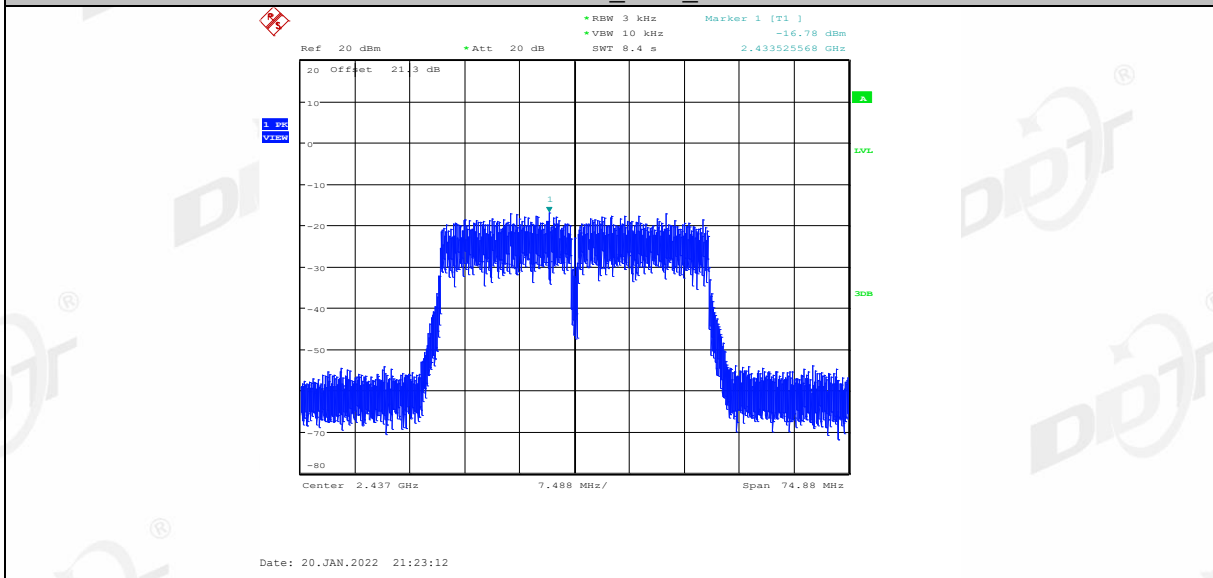

11N40SISO_Ant1_2452

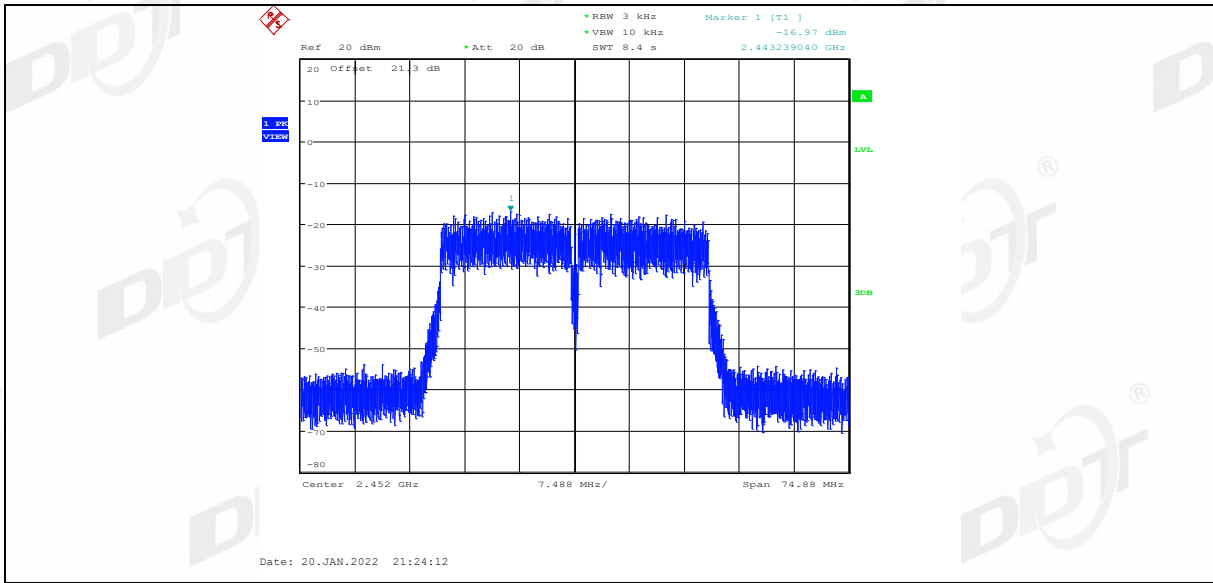

7. Band Edge and Spurious Emissions (Conducted)

7.1. Block diagram of test setup

Same as section 4.1

7.2. Limits

In any 100 kHz bandwidth outside the frequency bands in which the spread spectrum intentional radiator is operating, the radio frequency power that is produced by the intentional radiator shall be at least 20 dB below that in the 100 kHz bandwidth within the band that contains the highest level of the desired power.

7.3. Test procedure

(1) Connect EUT's antenna output to spectrum analyzer by RF cable.

(2) Establish a reference level by using the following procedure:

Center frequency	DTS Channel center frequency
RBW:	100 kHz
VBW:	300 kHz
Span	1.5 times the DTS bandwidth
Detector Mode:	Peak
Sweep time:	auto
Trace mode	Max hold

(3) Allow the trace to stabilize, use the peak marker function to determine the maximum peak power level to establish the reference level.

(4) Set the spectrum analyzer as follows:

RBW:	100 kHz
VBW:	300 kHz
Span	Encompass frequency range to be measured
Number of measurement points	$\geq \text{span}/\text{RBW}$
Detector Mode:	Peak
Sweep time:	auto
Trace mode	Max hold

(5) Allow the trace to stabilize, use the peak marker function to determine the maximum amplitude of all unwanted emissions outside of the authorized frequency band

7.4. Test result

EUT Set Mode	CH or Frequency	Ant1 Result (dBm)	EUT Set Mode	CH or Frequency	Ant1 Result (dBm)
11b	CH1	Pass	11n HT 20	CH1	Pass
	CH6	Pass		CH6	Pass
	CH11	Pass		CH11	Pass
11g	CH1	Pass	11n HT 40	CH3	Pass
	CH6	Pass		CH6	Pass
	CH11	Pass		CH9	Pass

7.5. Original test data

Band Edge:

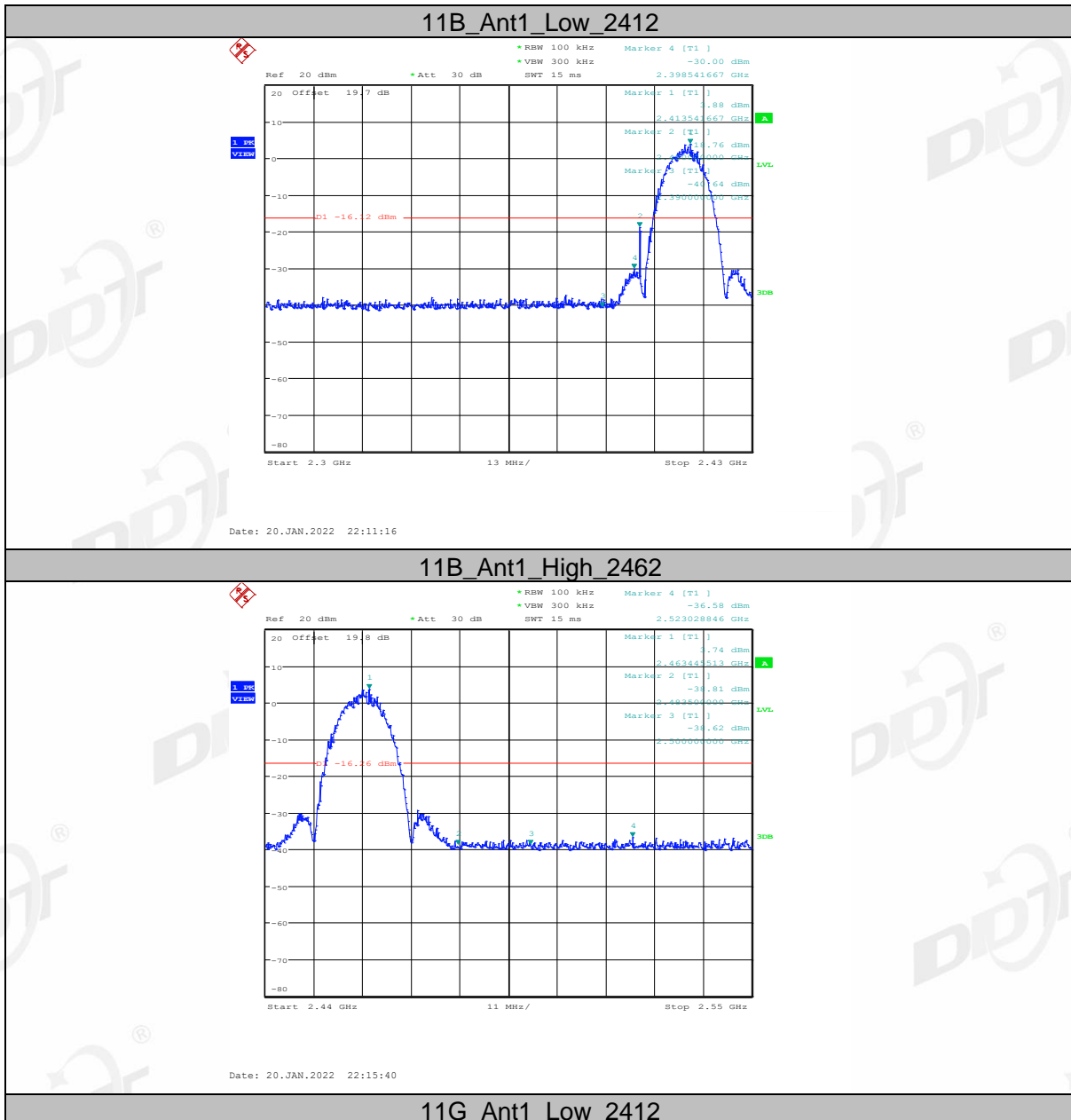

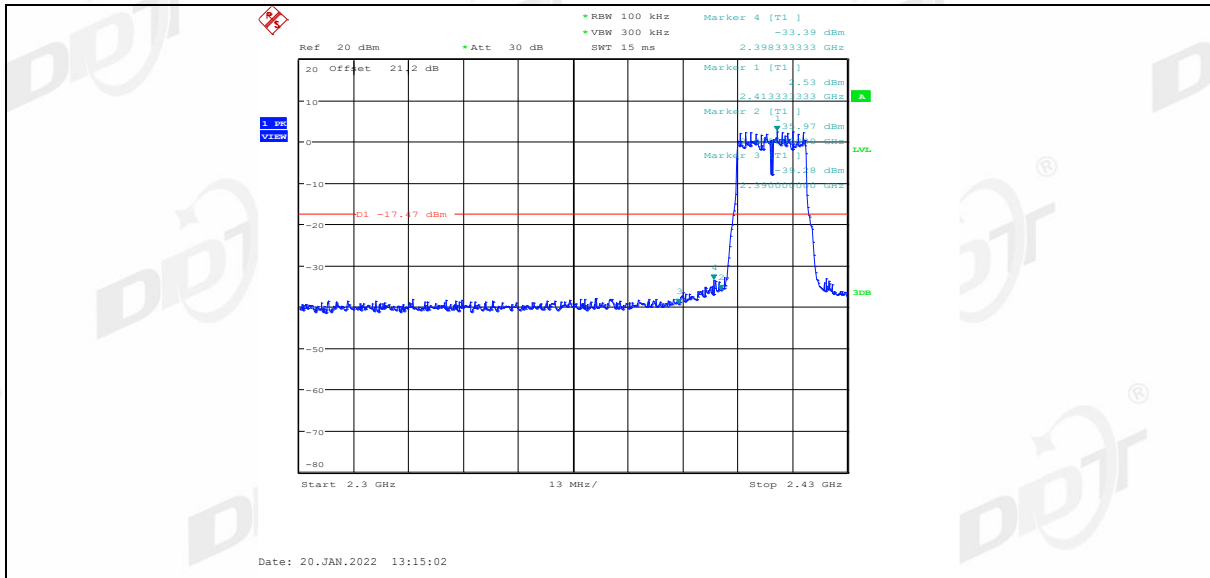

11G_Ant1_High_2462

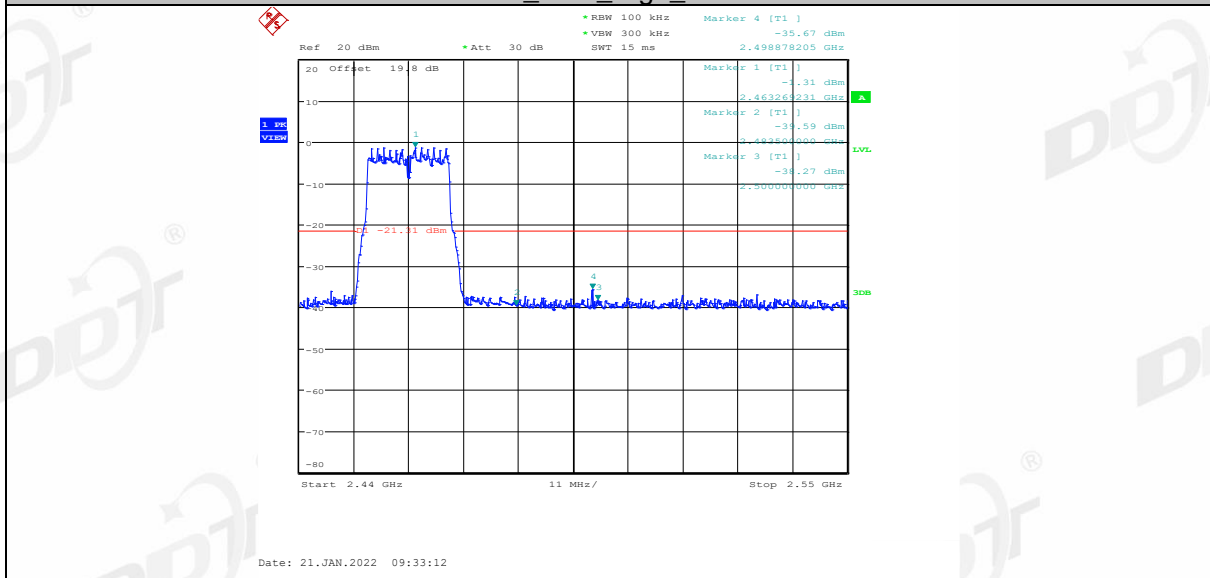

11N20SISO_Ant1_Low_2412

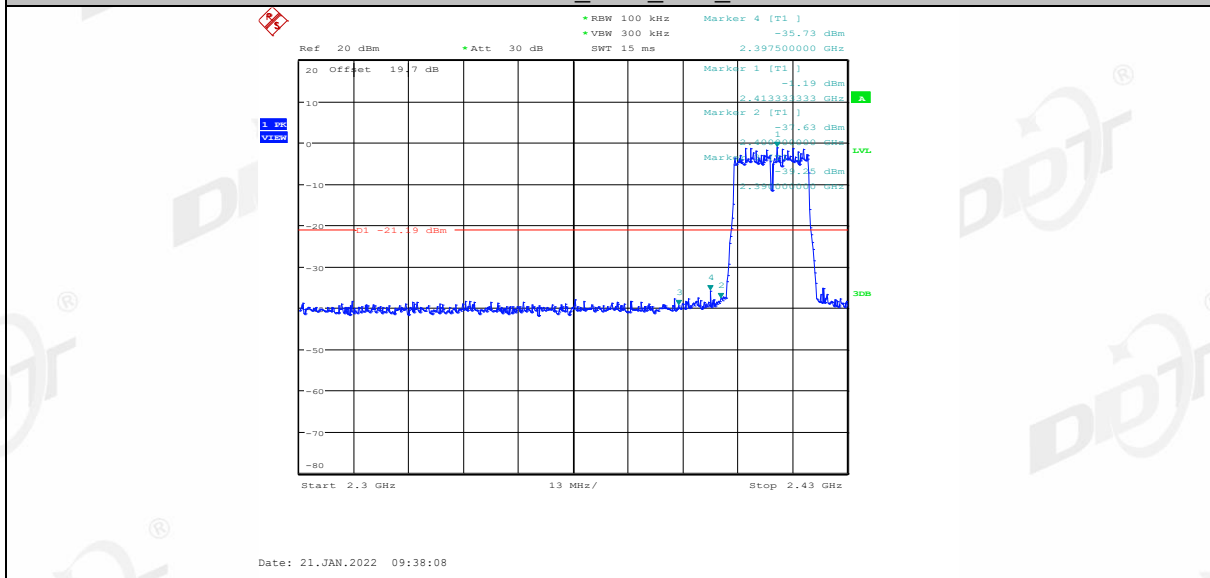

11N20SISO_Ant1_High_2462

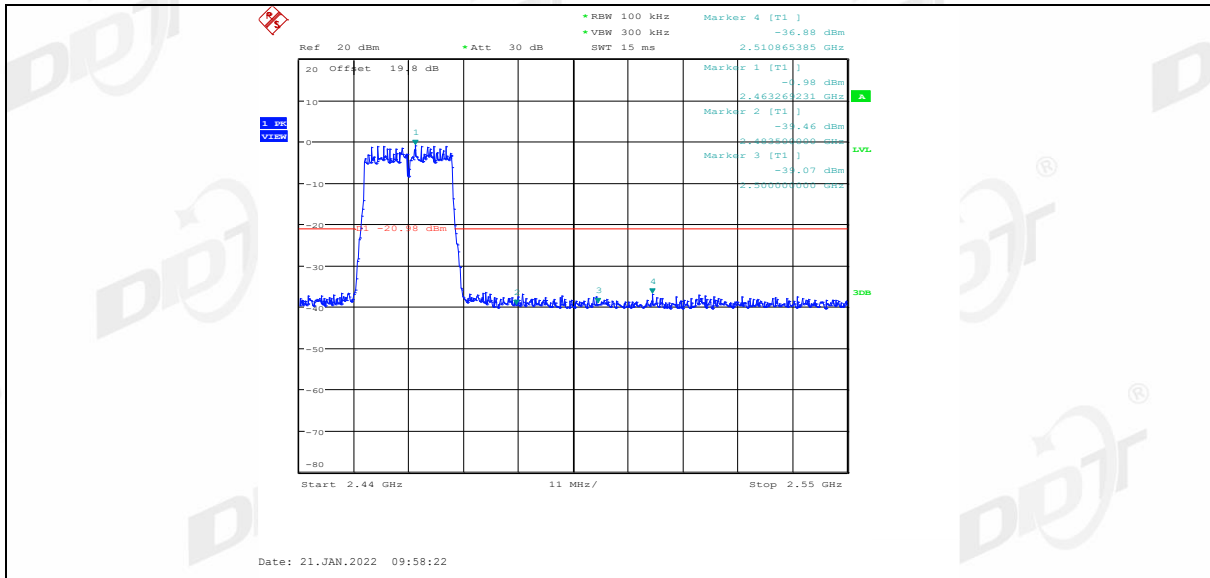

11N40SISO_Ant1_Low_2422

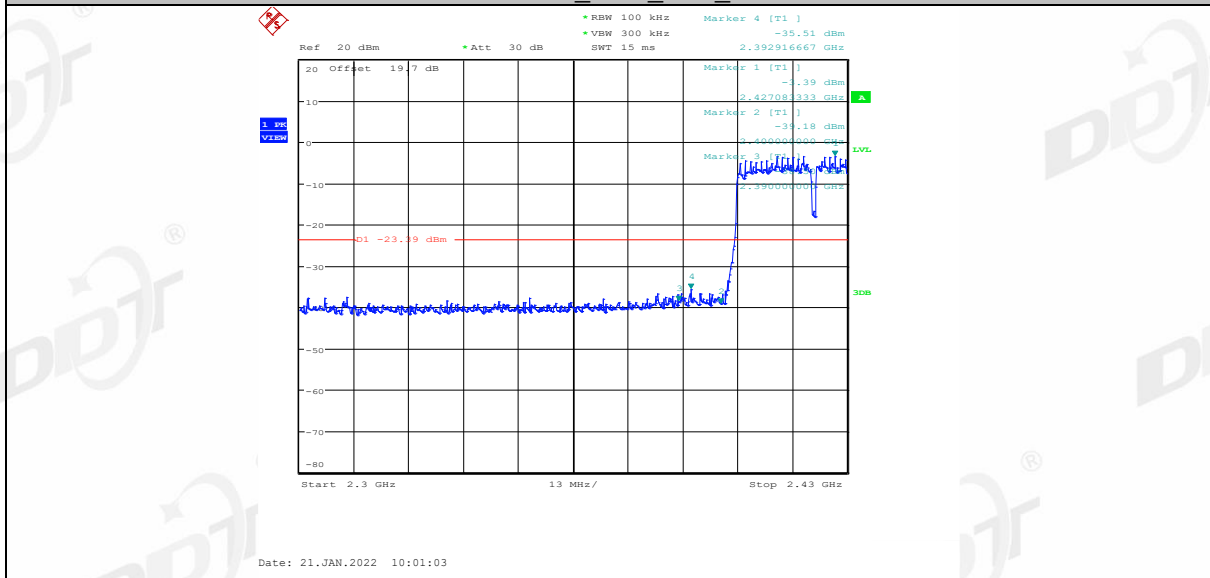

11N40SISO_Ant1_High_2452

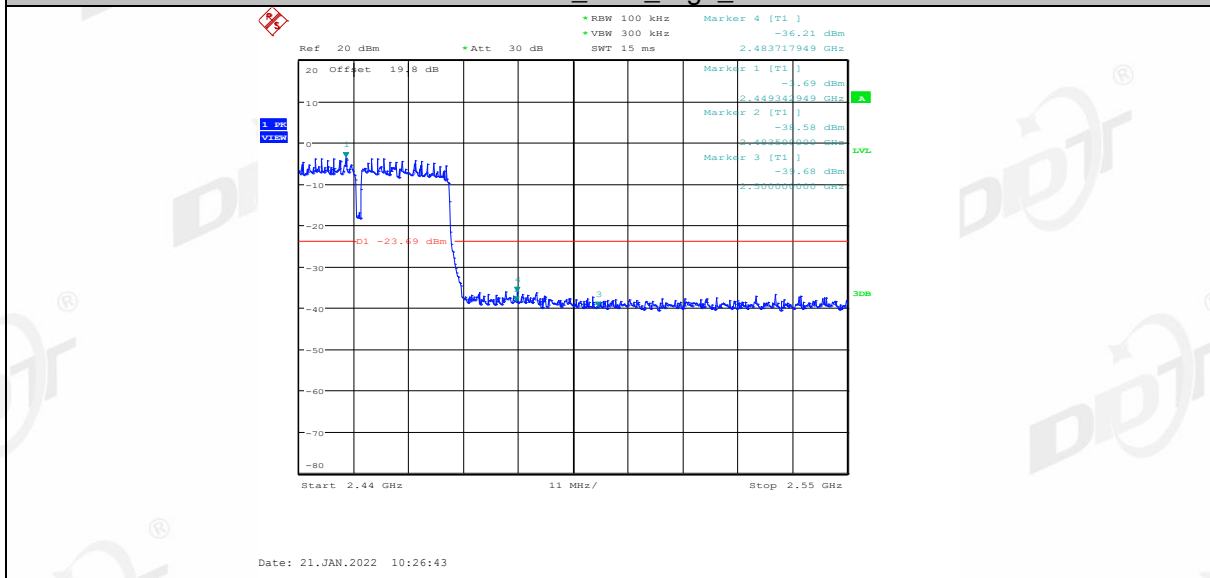

Spurious Emissions:

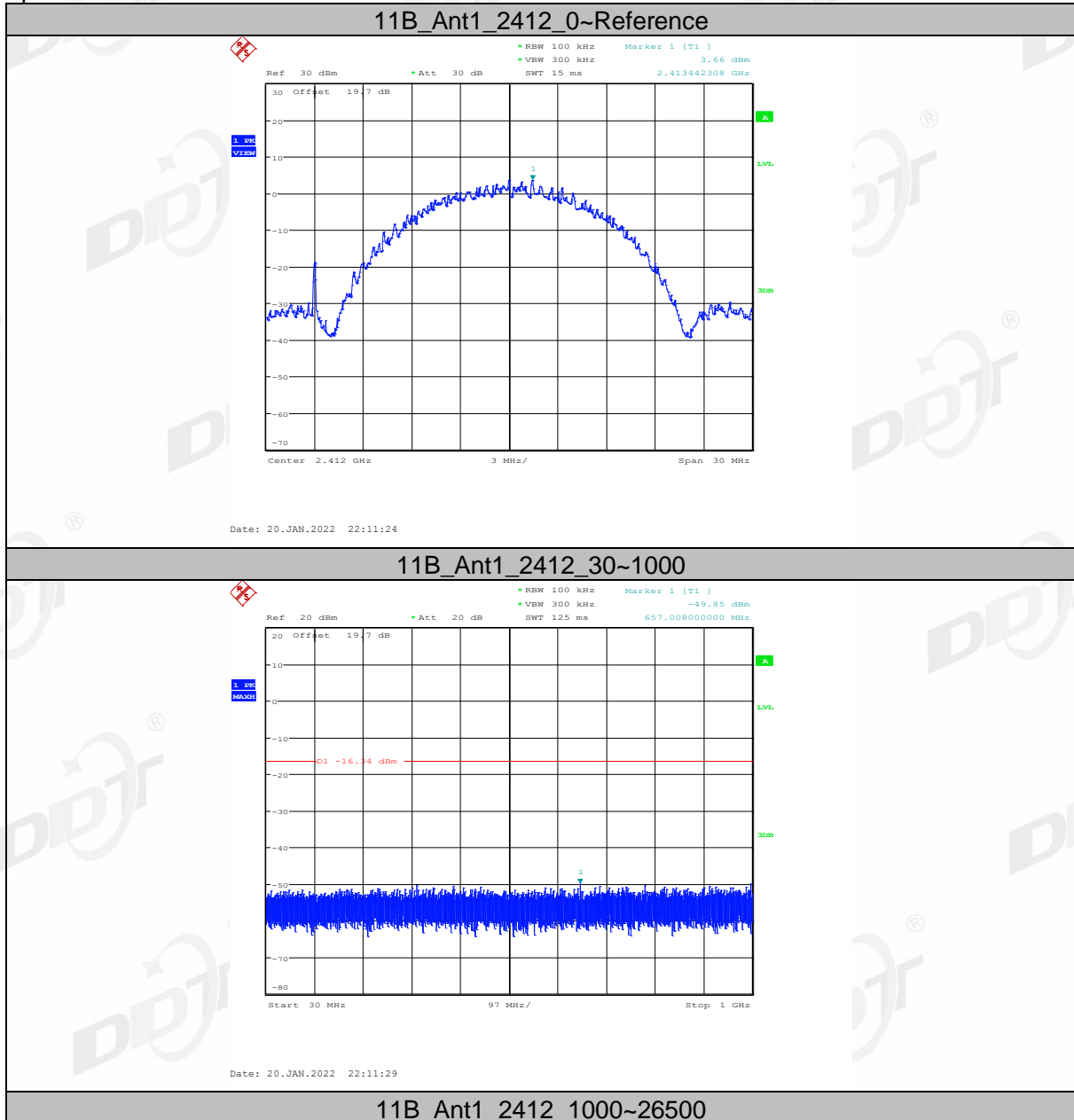

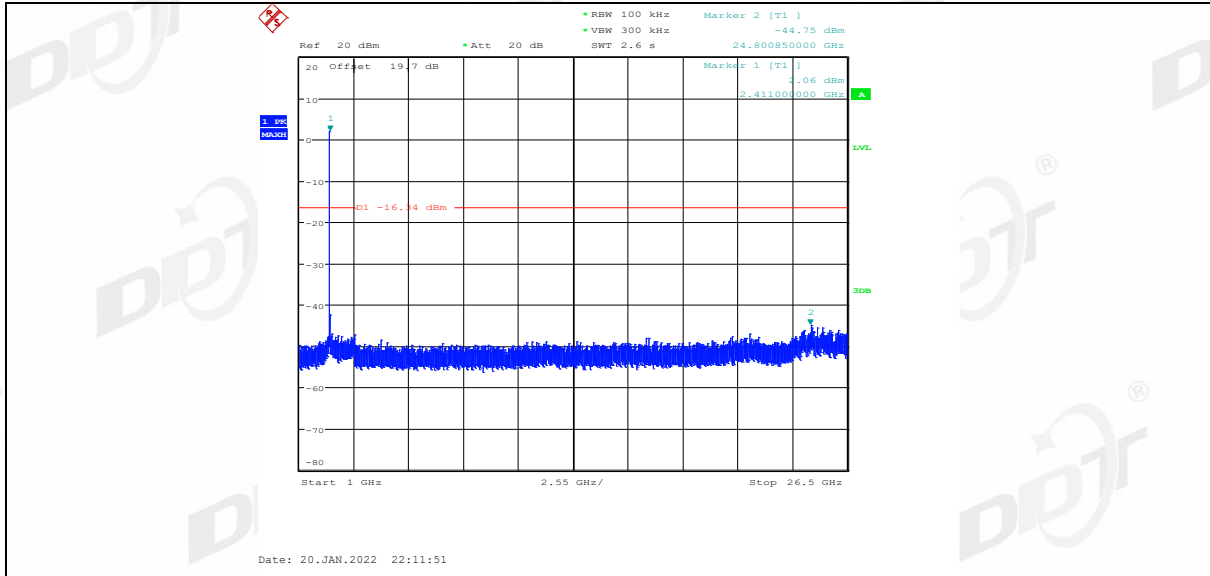

11B_Ant1_2437_0~Reference

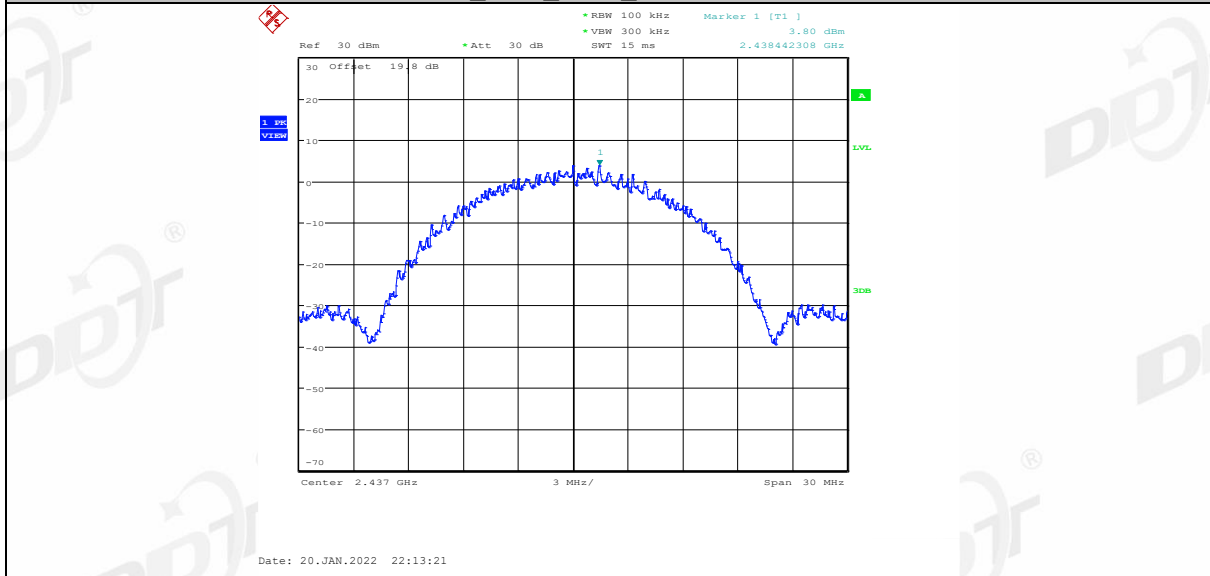

11B_Ant1_2437_30~1000

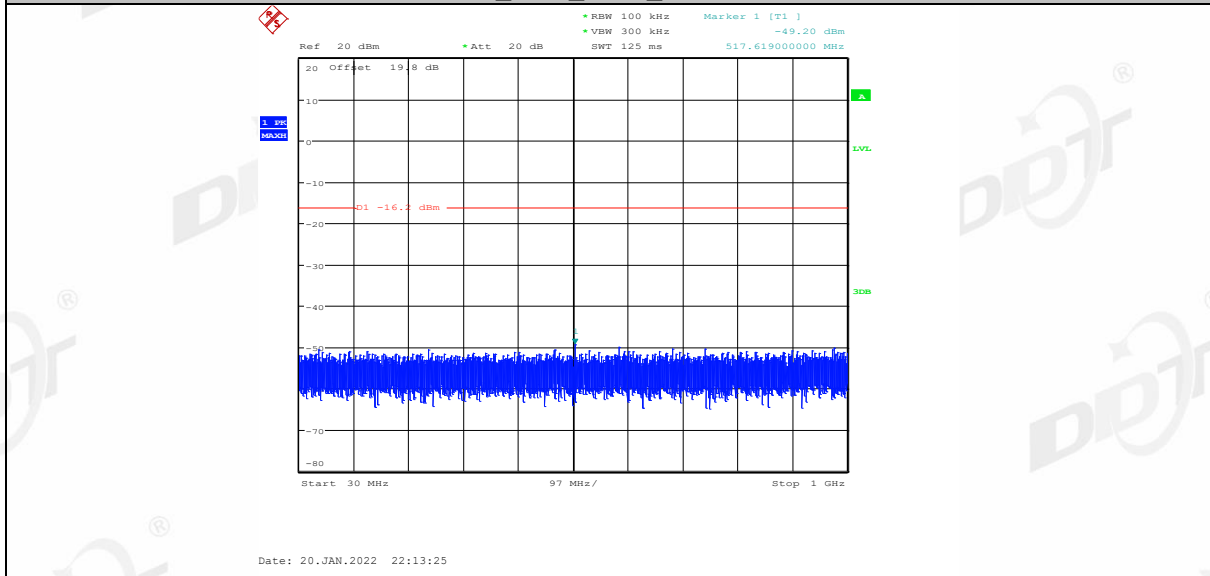

11B_Ant1_2437_1000~26500

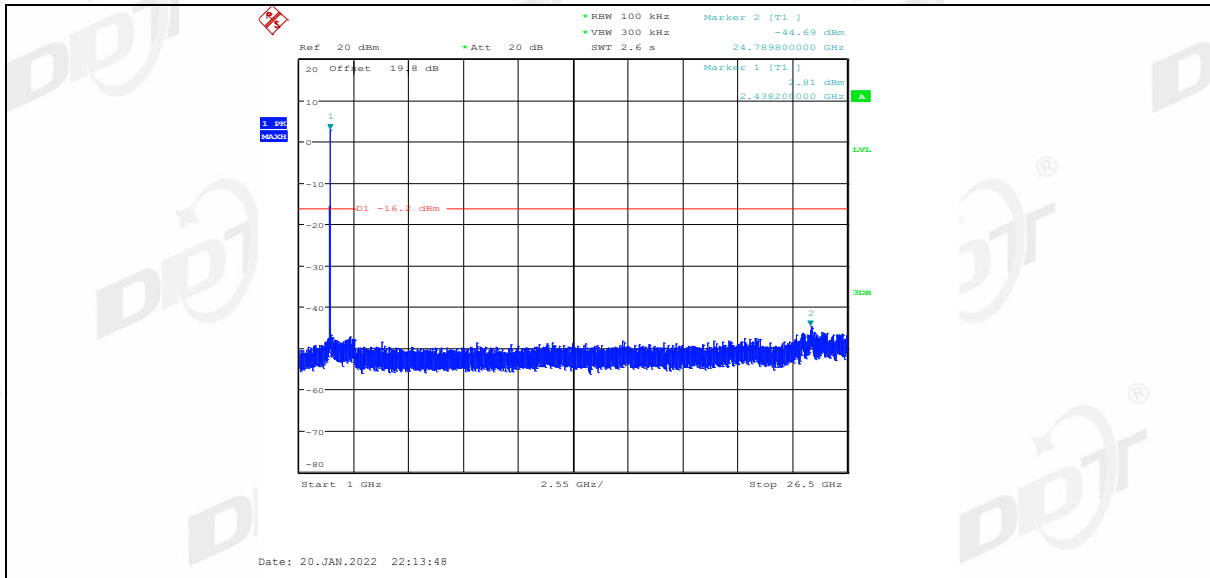

11B_Ant1_2462_0~Reference

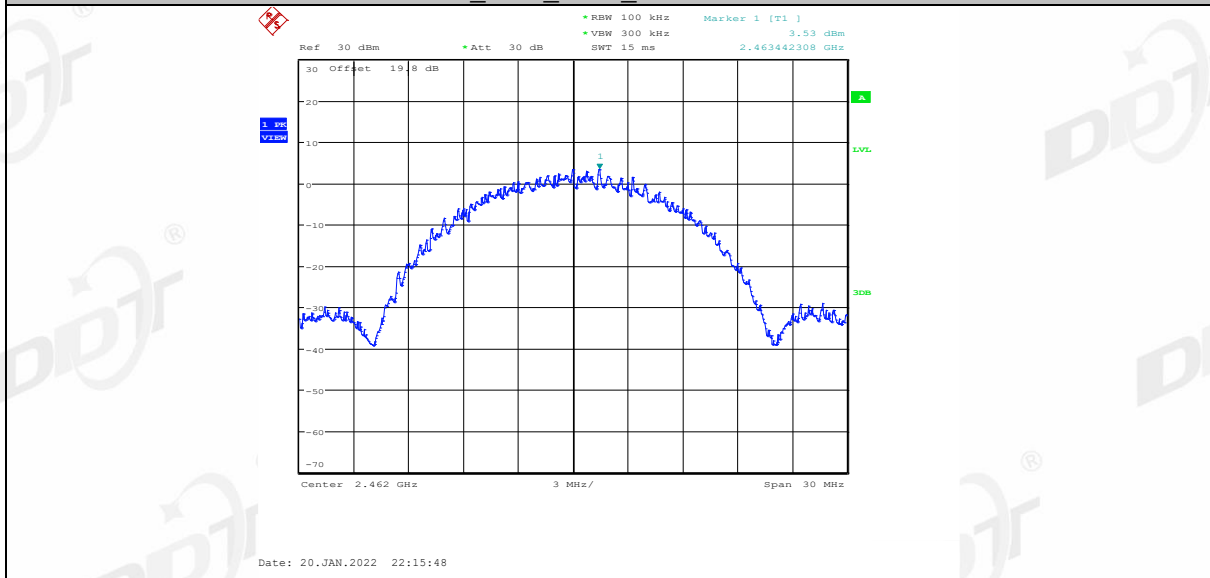

11B_Ant1_2462_30~1000

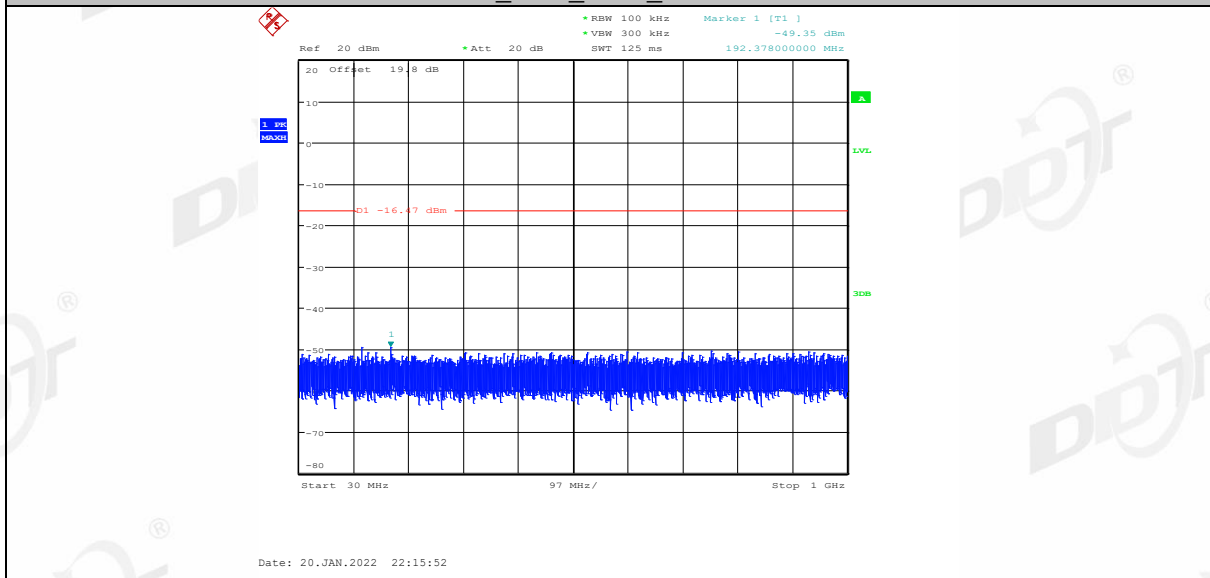

11B_Ant1_2462_1000~26500

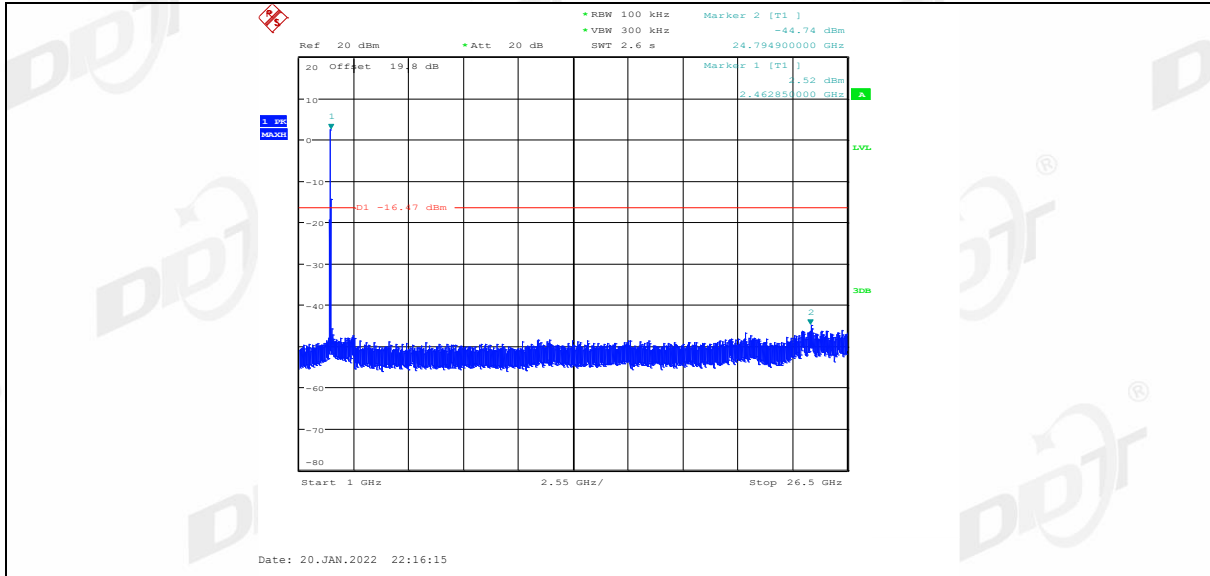

11G_Ant1_2412_0~Reference

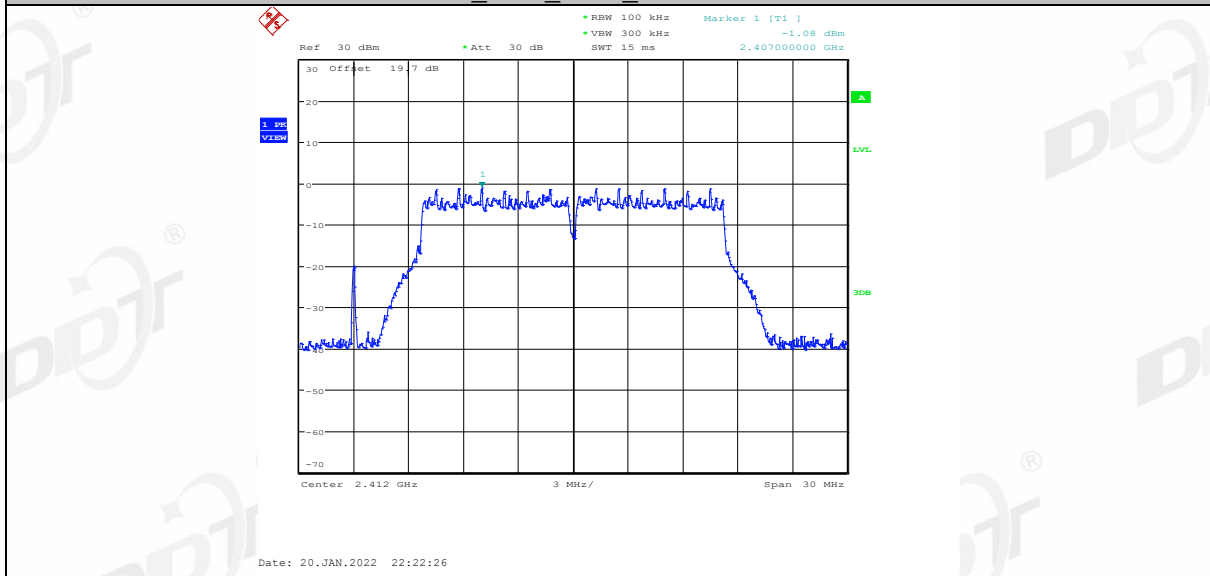

11G_Ant1_2412_30~1000

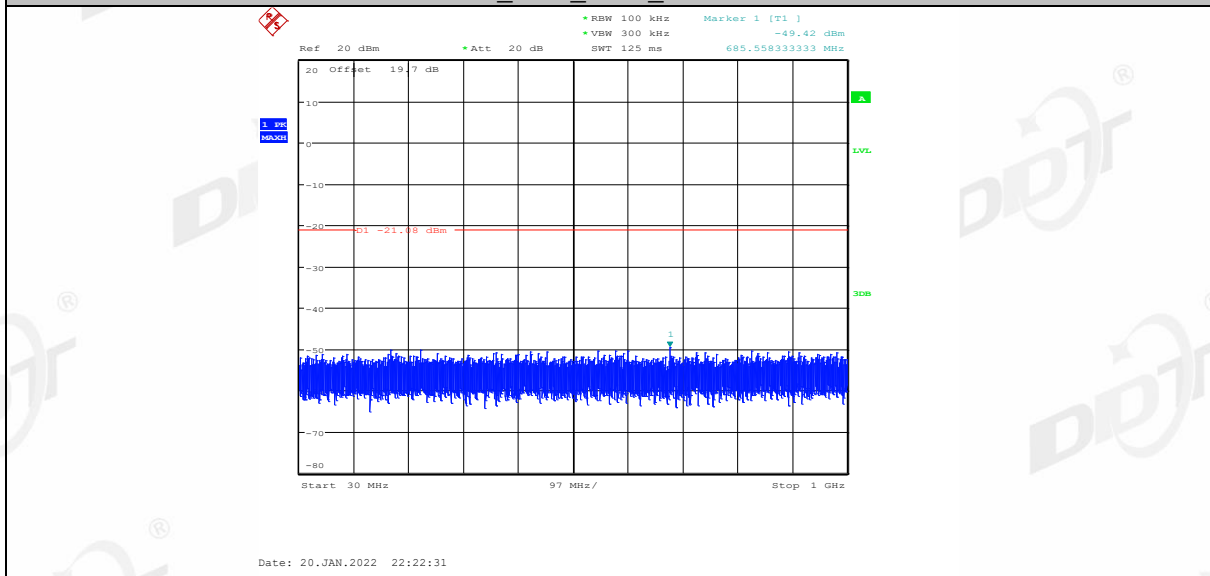

11G_Ant1_2412_1000~26500

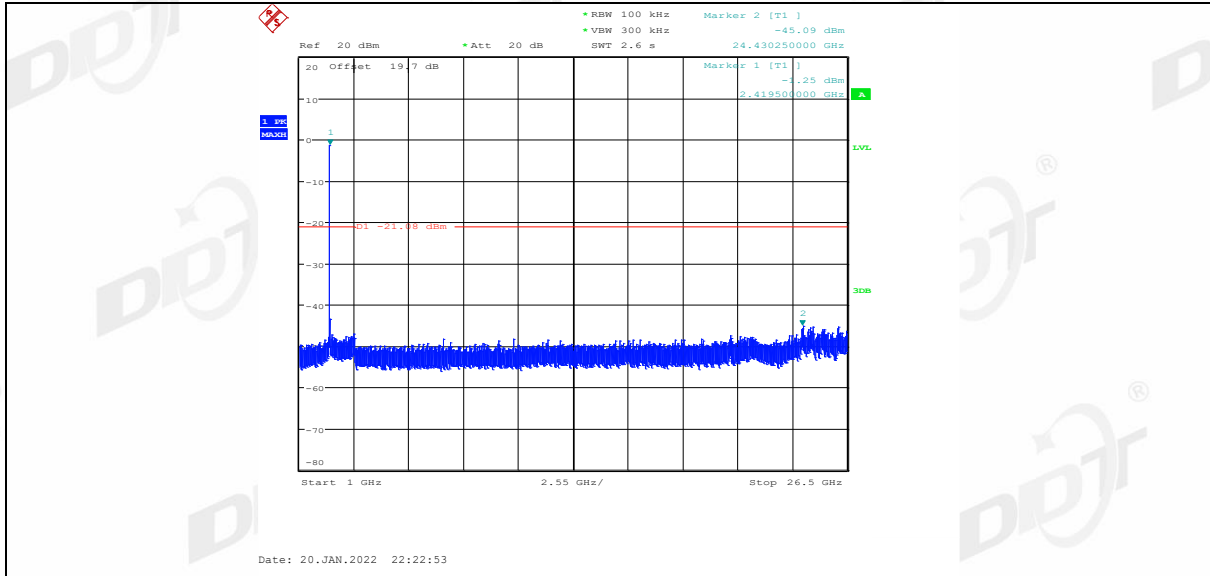

11G_Ant1_2437_0~Reference

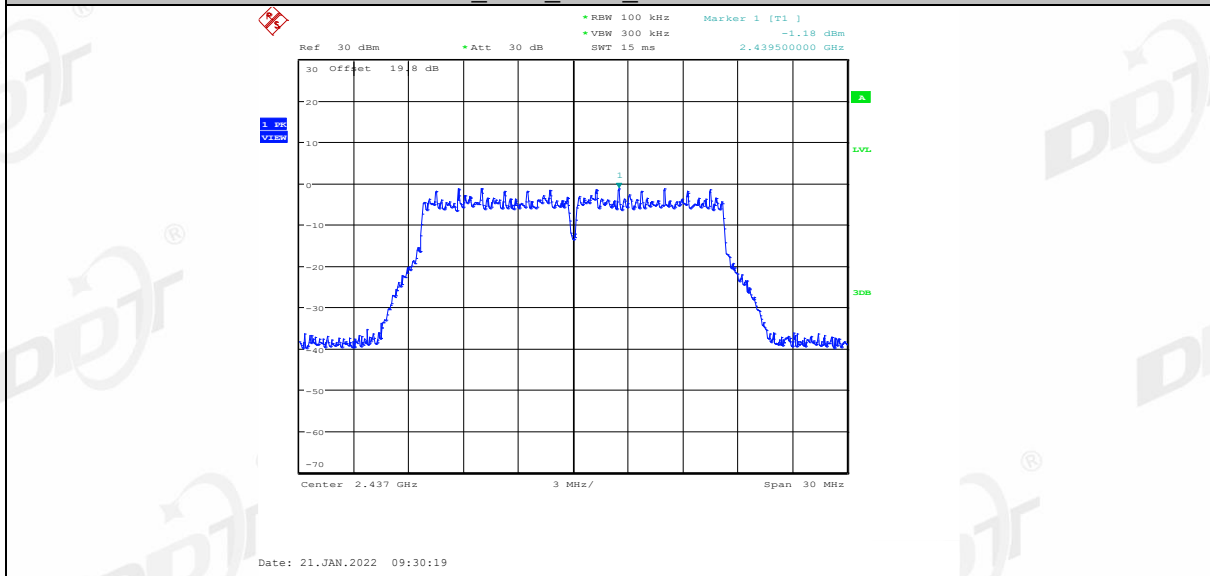

11G_Ant1_2437_30~1000

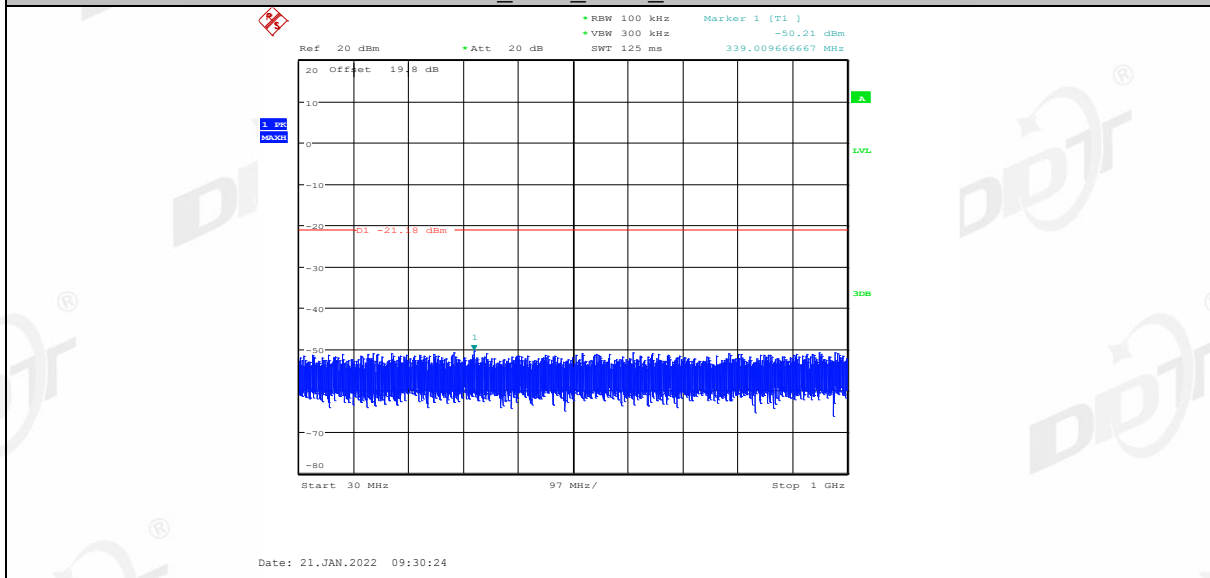

11G_Ant1_2437_1000~26500

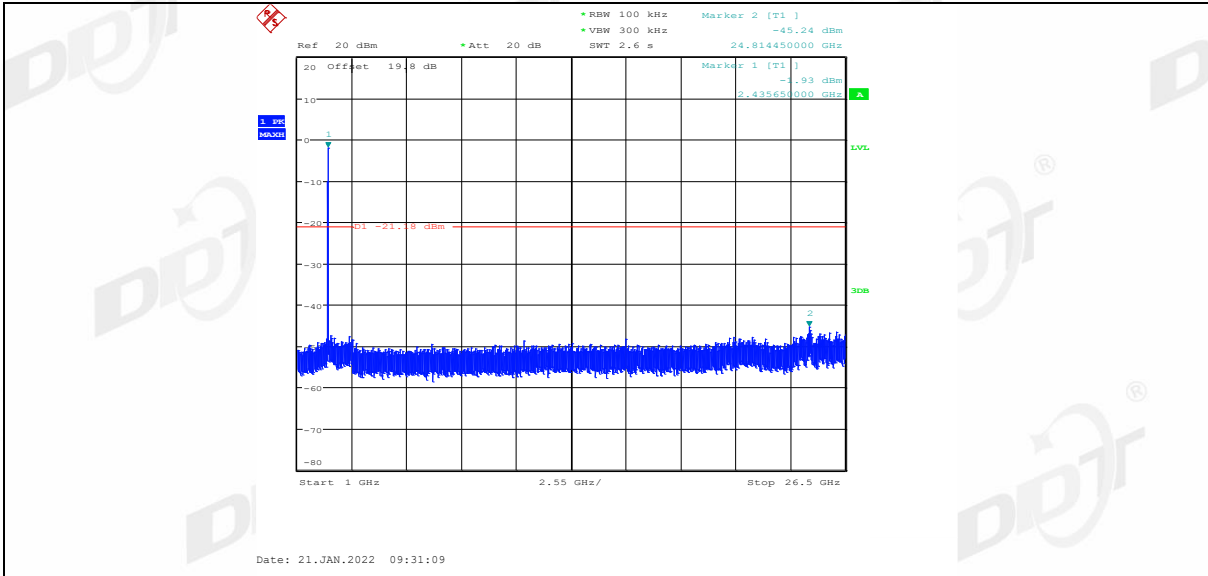

11G_Ant1_2462_0~Reference

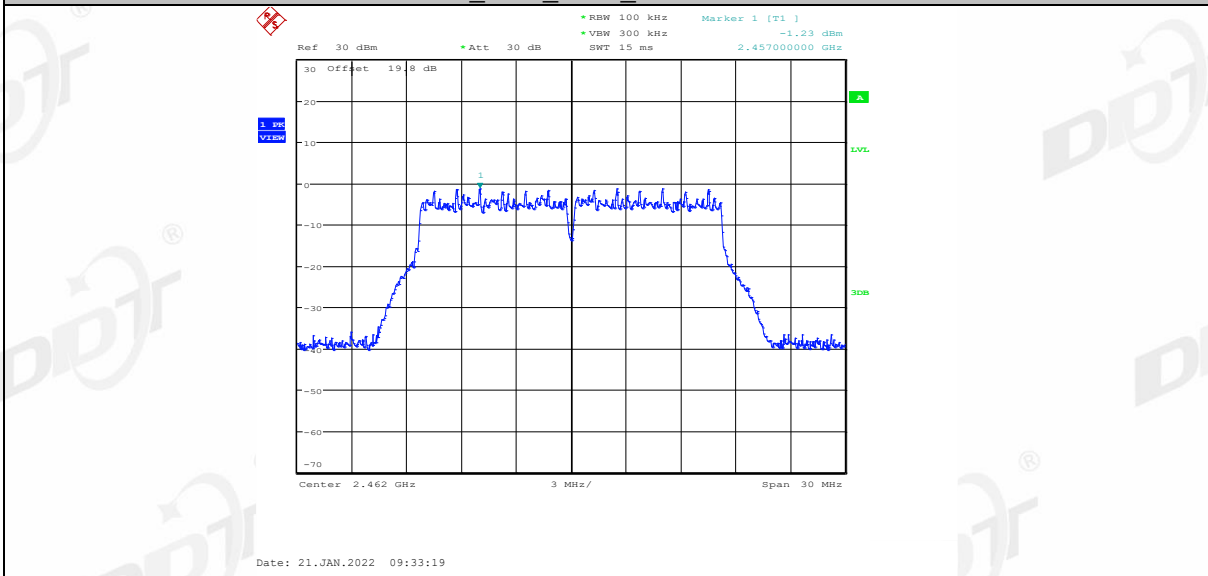

11G_Ant1_2462_30~1000

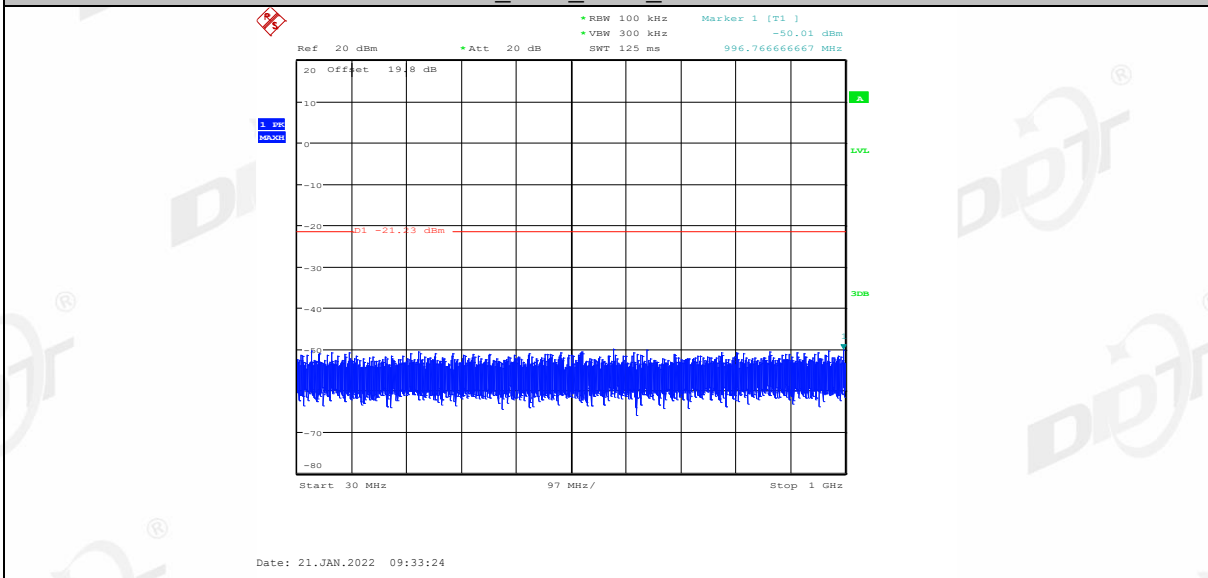

11G_Ant1_2462_1000~26500

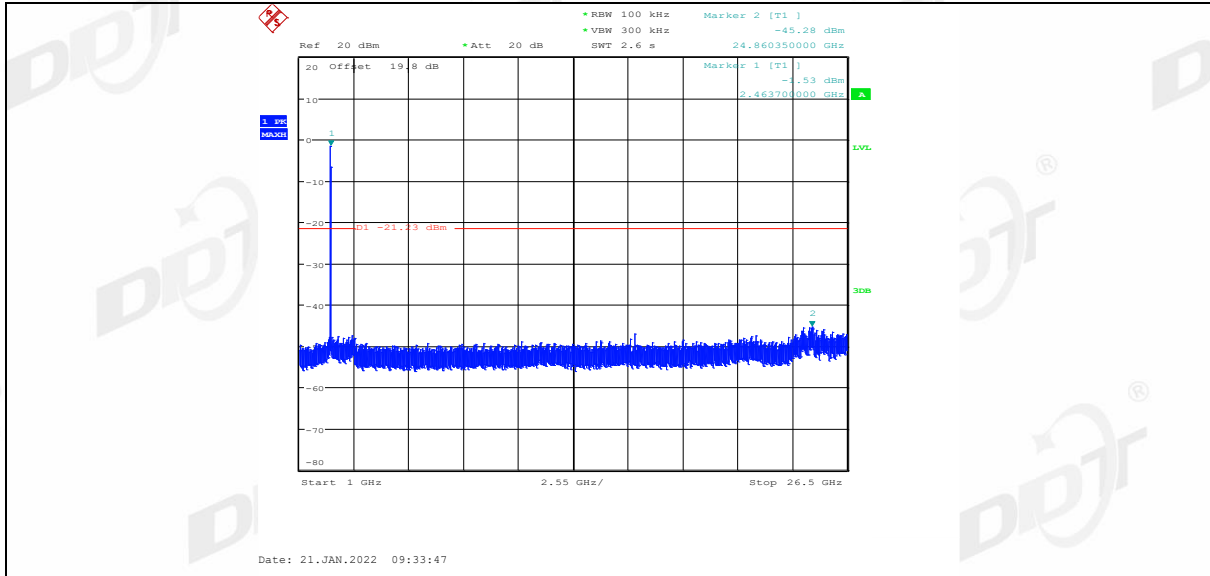

11N20SISO_Ant1_2412_0~Reference

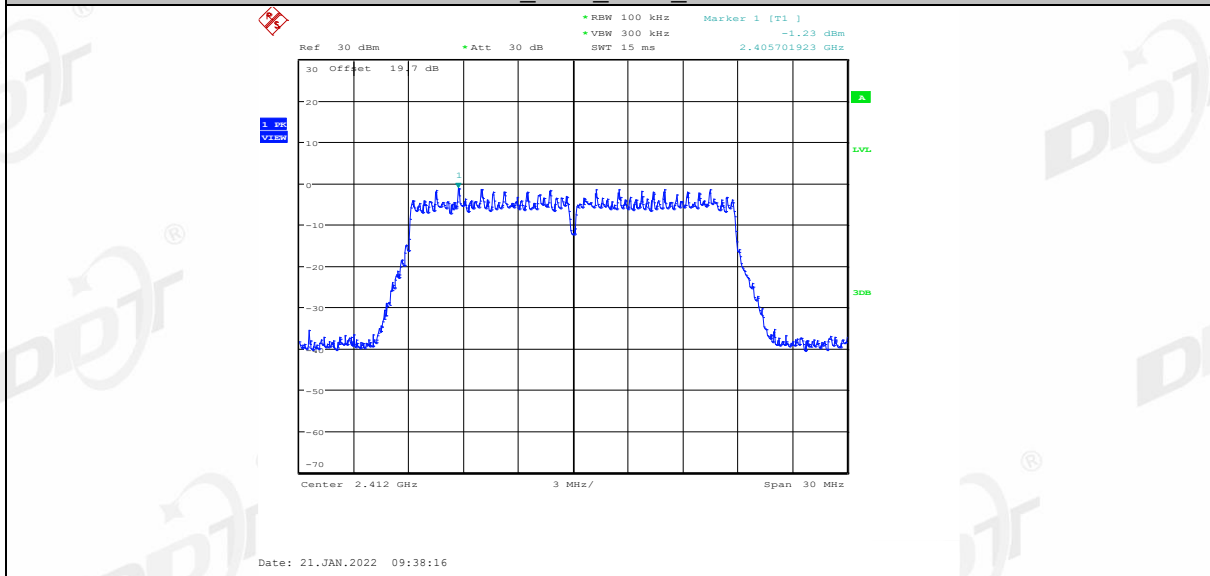

11N20SISO_Ant1_2412_30~1000

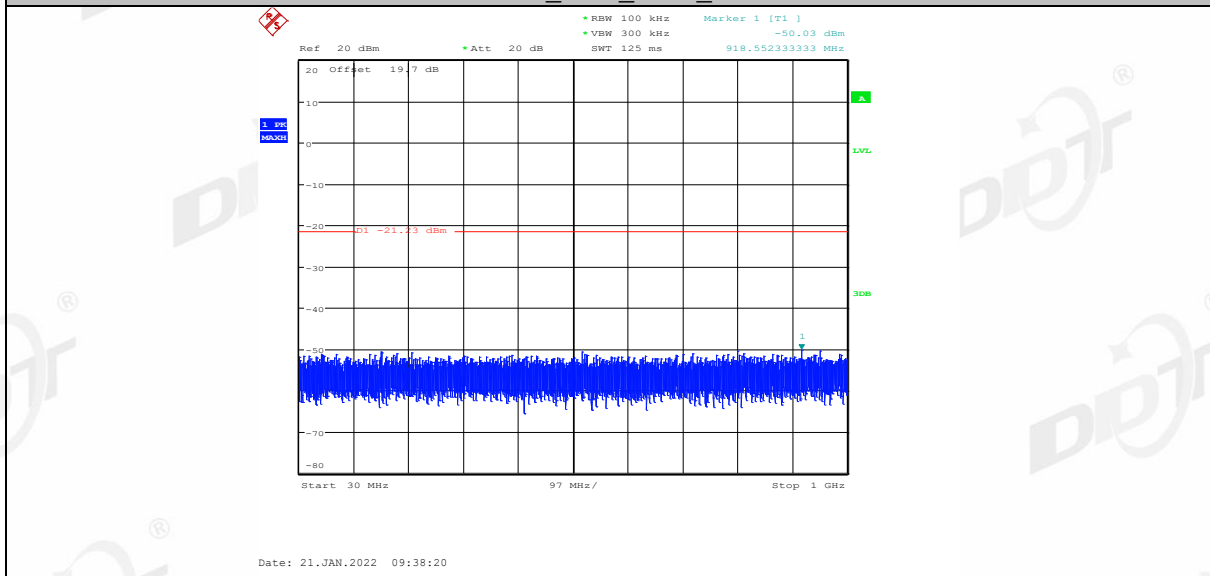

11N20SISO_Ant1_2412_1000~26500

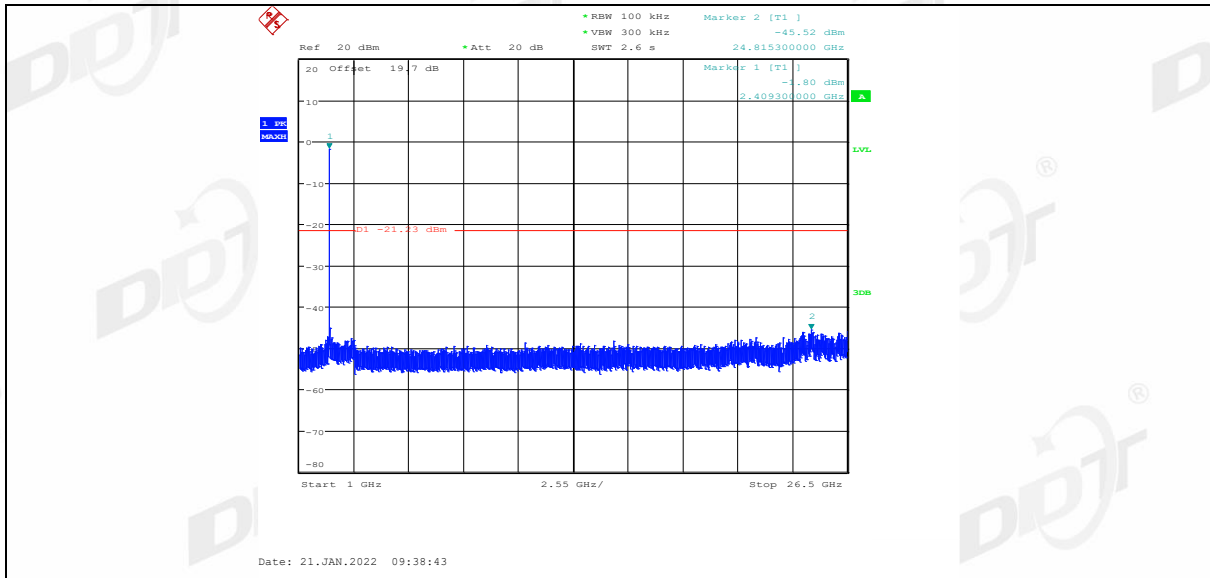

11N20SISO_Ant1_2437_0~Reference

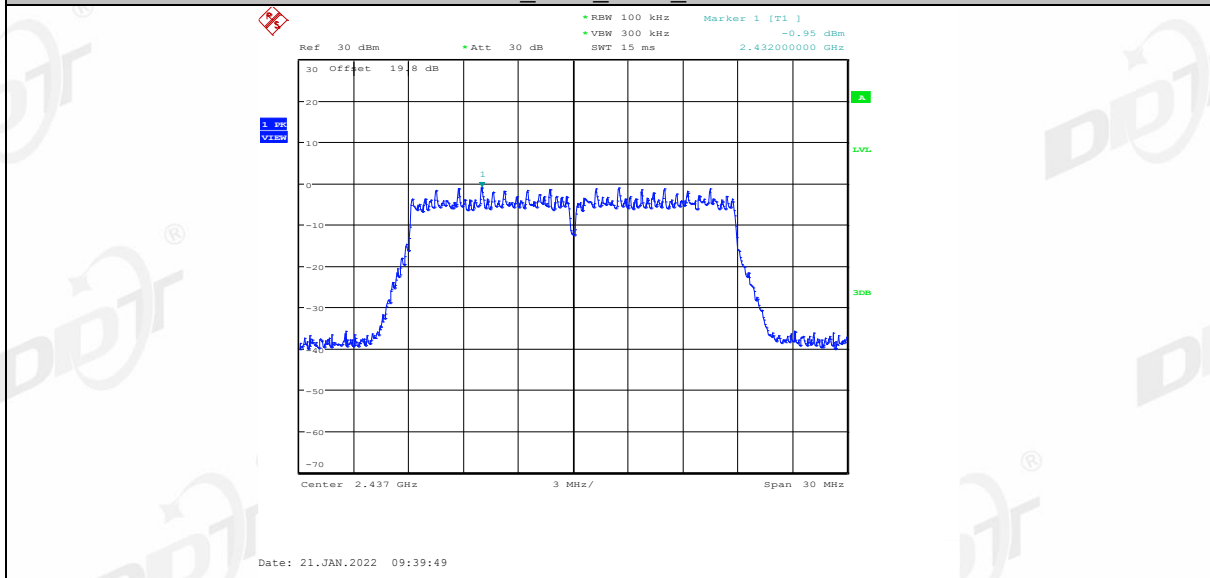

11N20SISO_Ant1_2437_30~1000

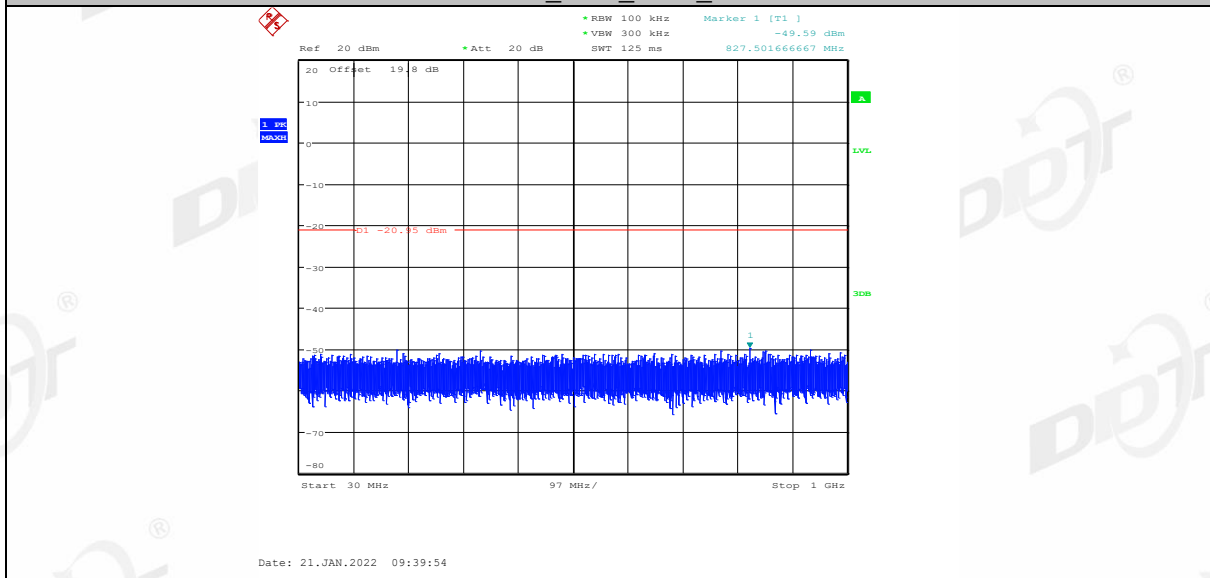

11N20SISO_Ant1_2437_1000~26500

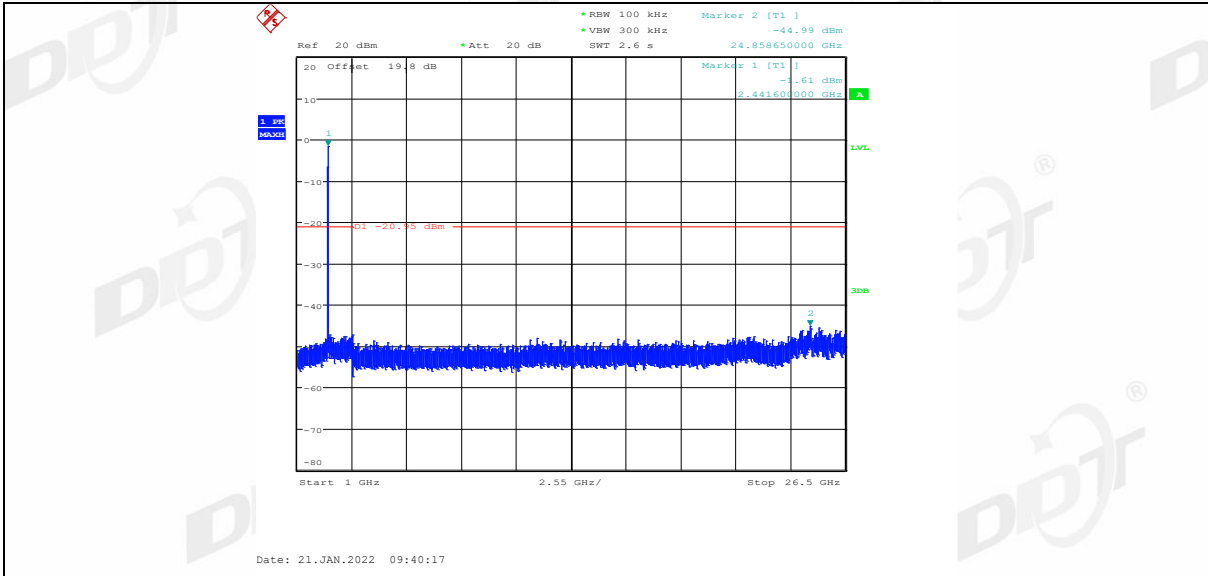

11N20SISO_Ant1_2462_0~Reference

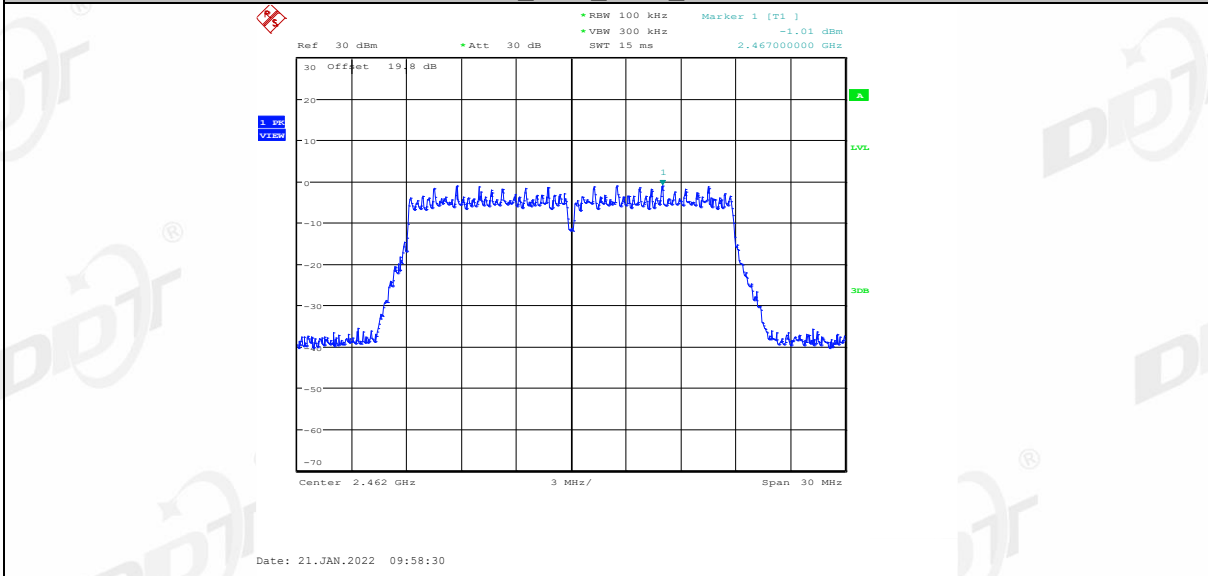

11N20SISO_Ant1_2462_30~1000

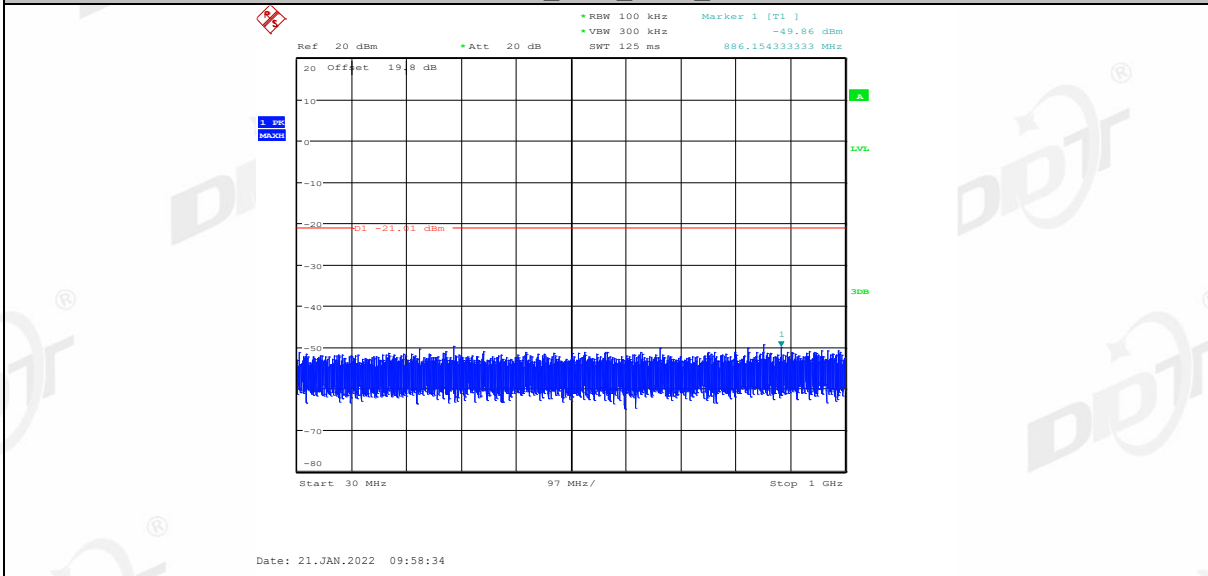

11N20SISO_Ant1_2462_1000~26500

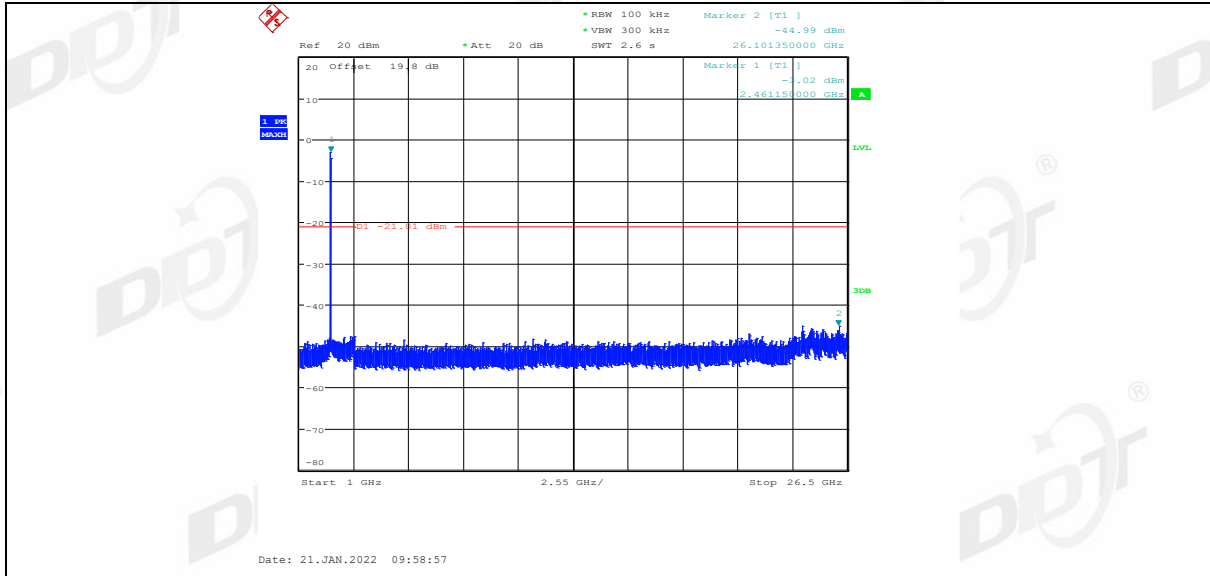

11N40SISO_Ant1_2422_0~Reference

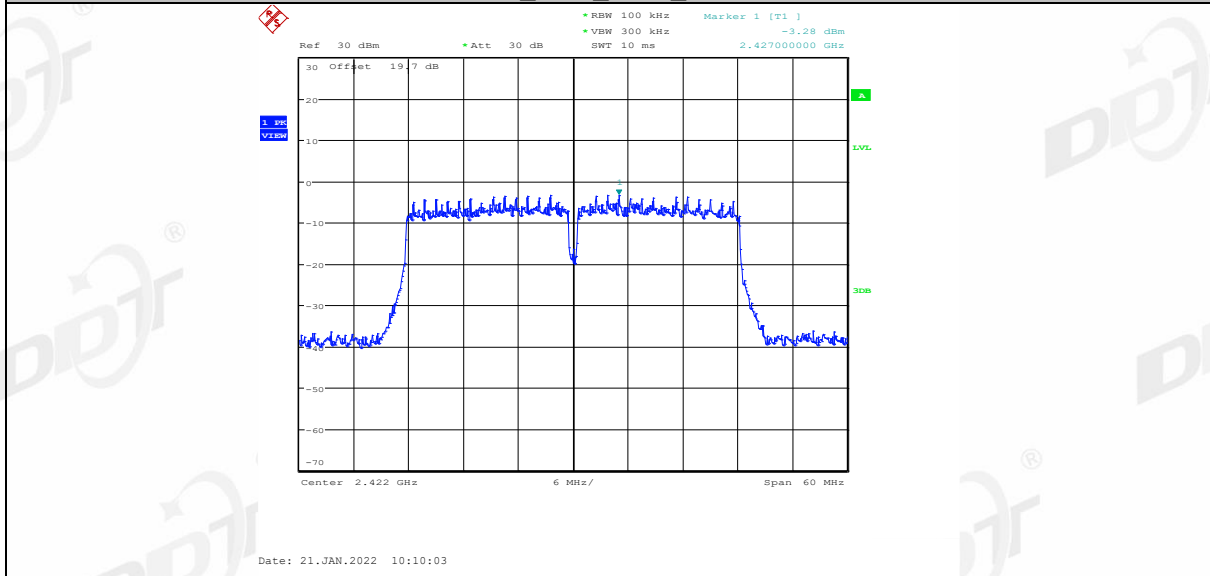

11N40SISO_Ant1_2422_30~1000

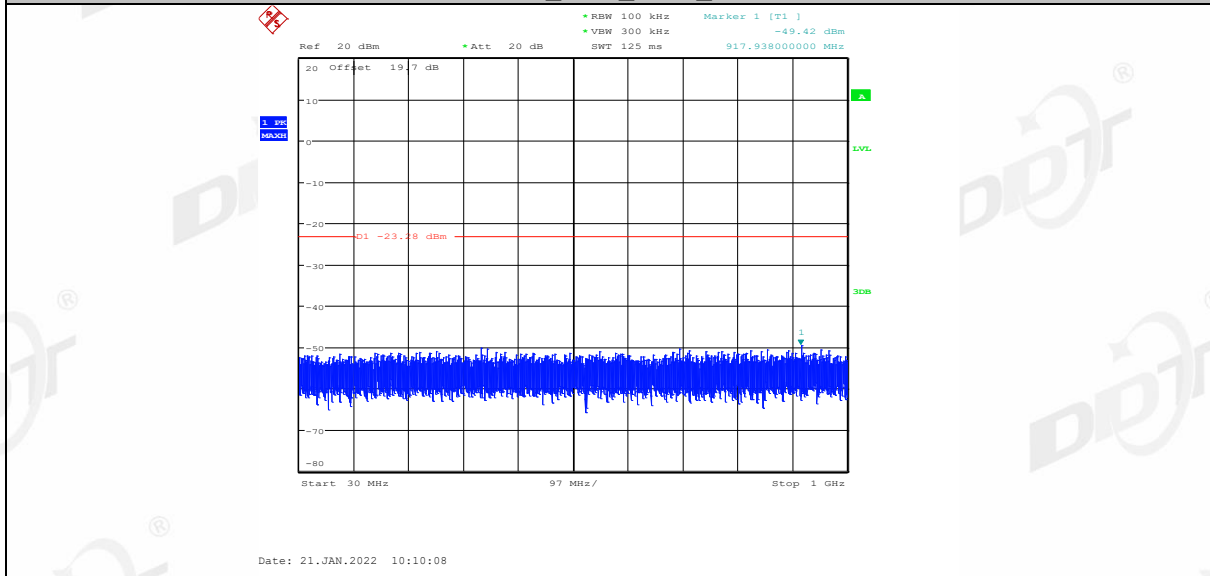

11N40SISO_Ant1_2422_1000~26500

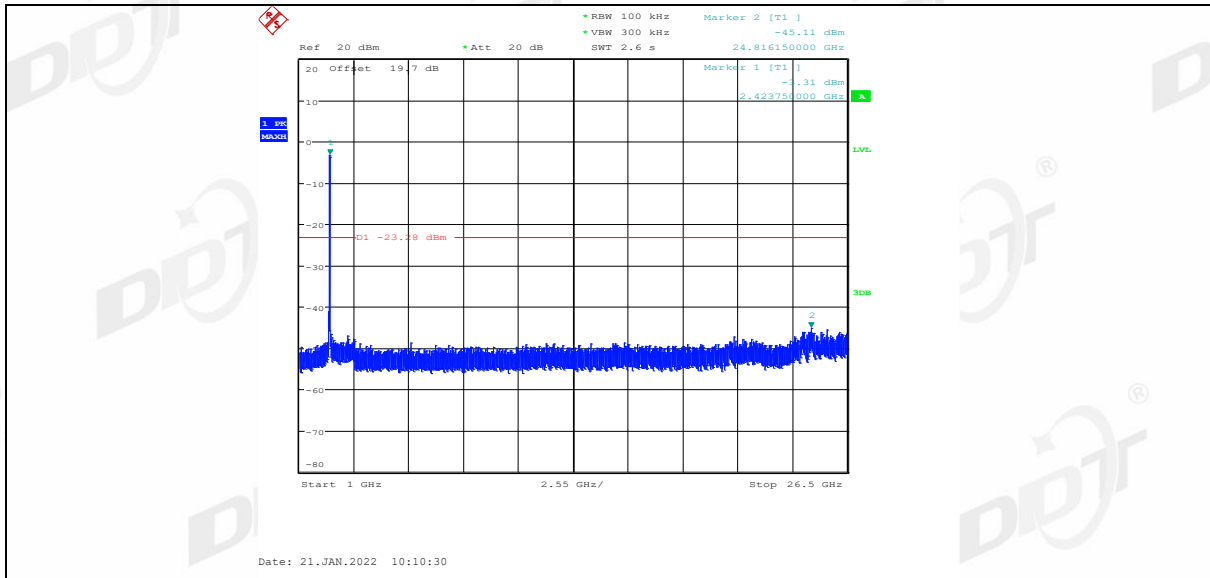

11N40SISO_Ant1_2437_0~Reference

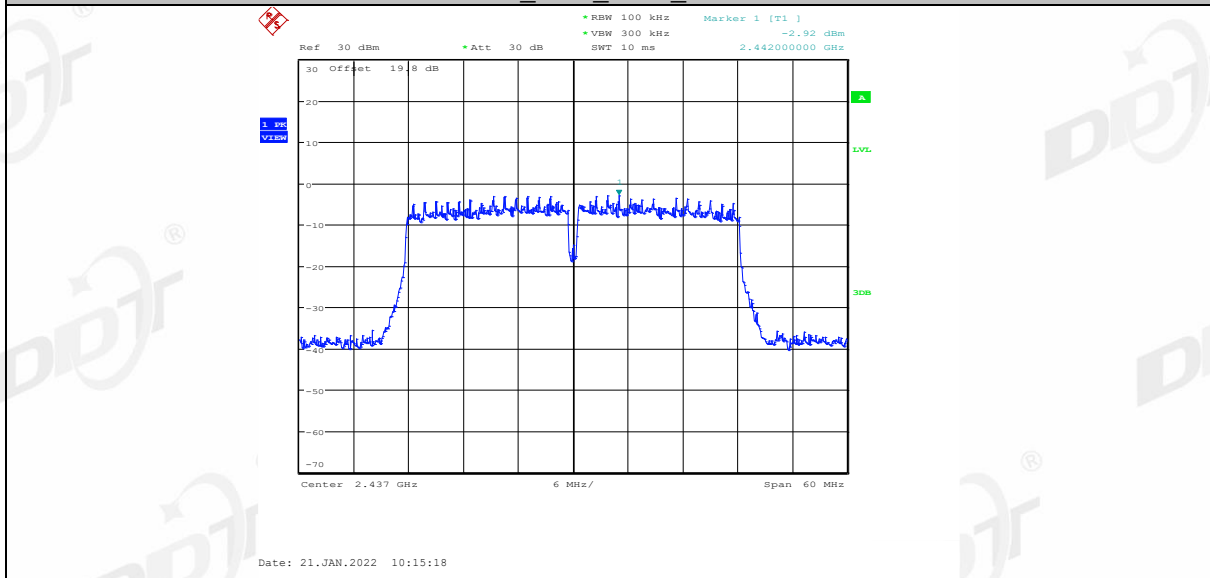

11N40SISO_Ant1_2437_30~1000

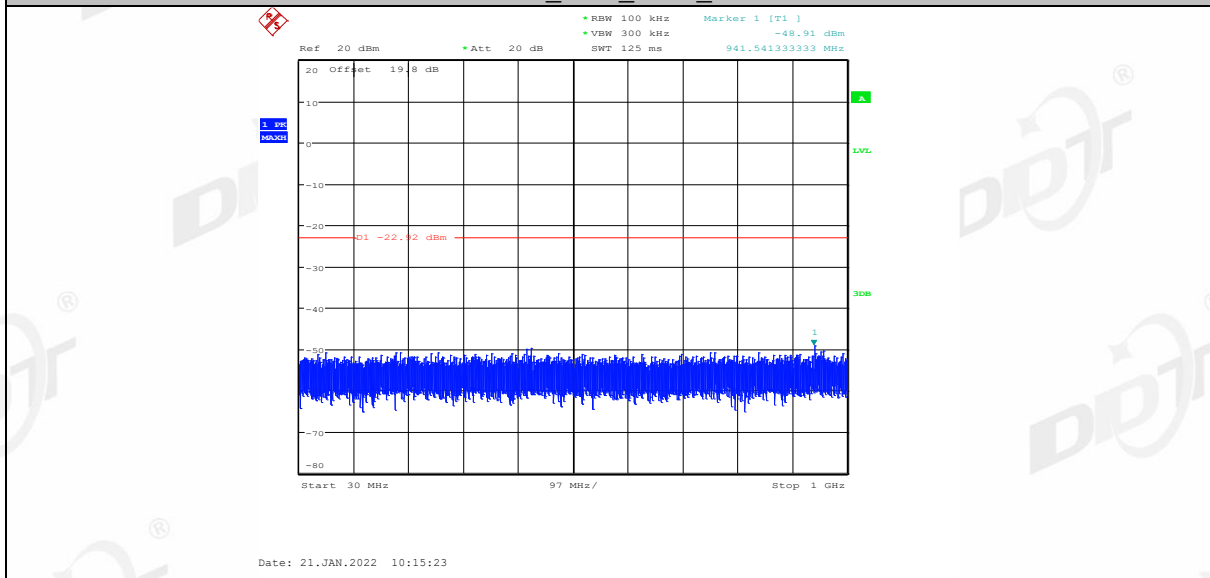

11N40SISO_Ant1_2437_1000~26500

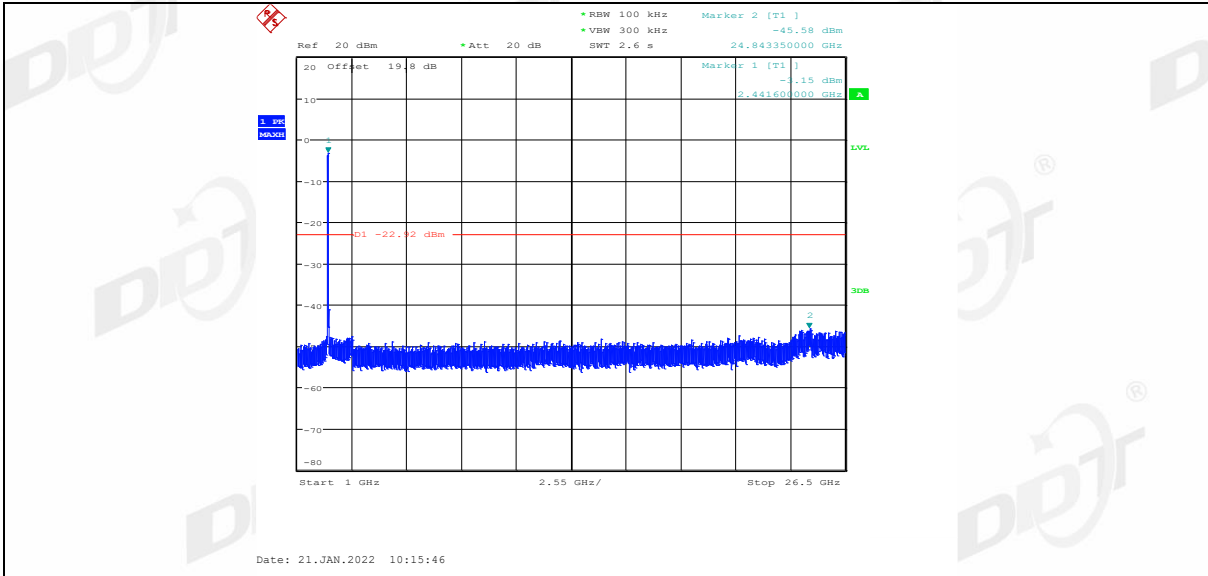

11N40SISO_Ant1_2452_0~Reference

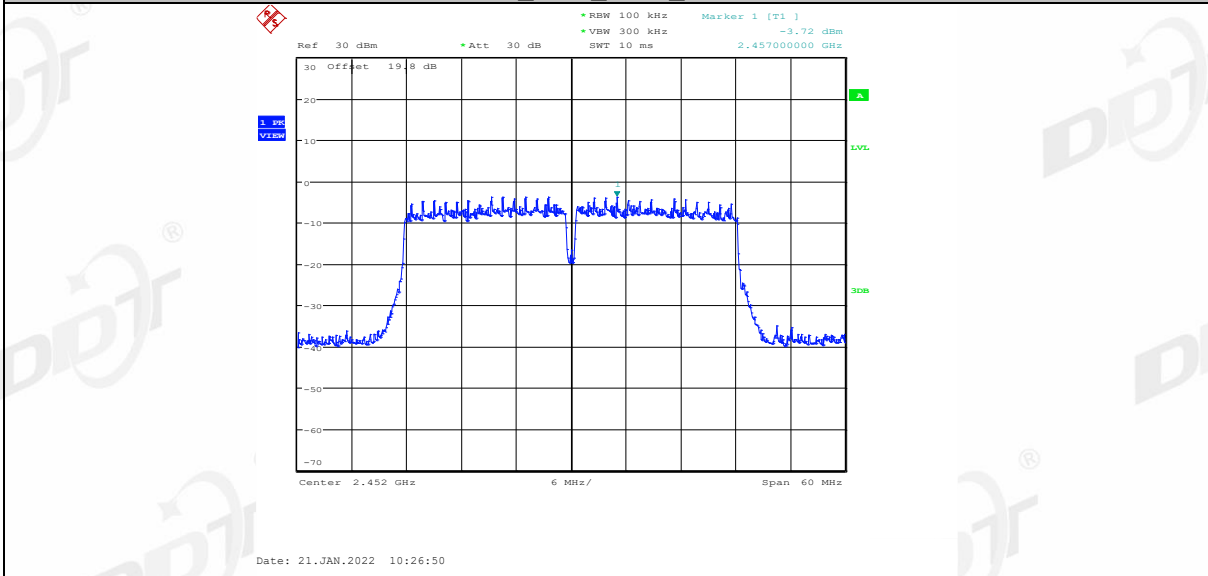

11N40SISO_Ant1_2452_30~1000

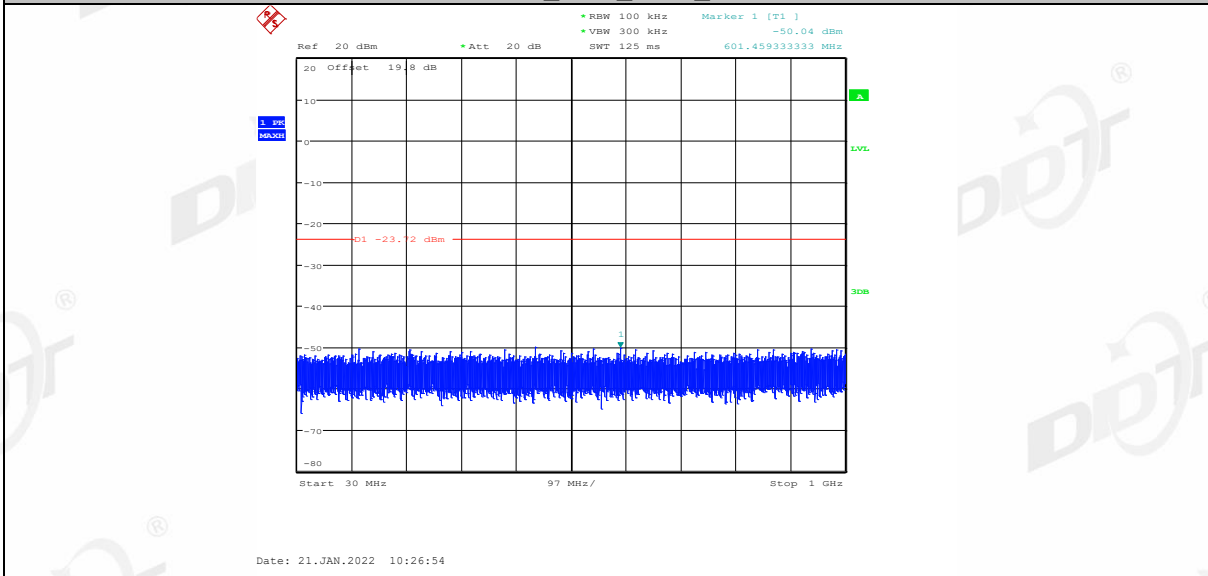

11N40SISO_Ant1_2452_1000~26500

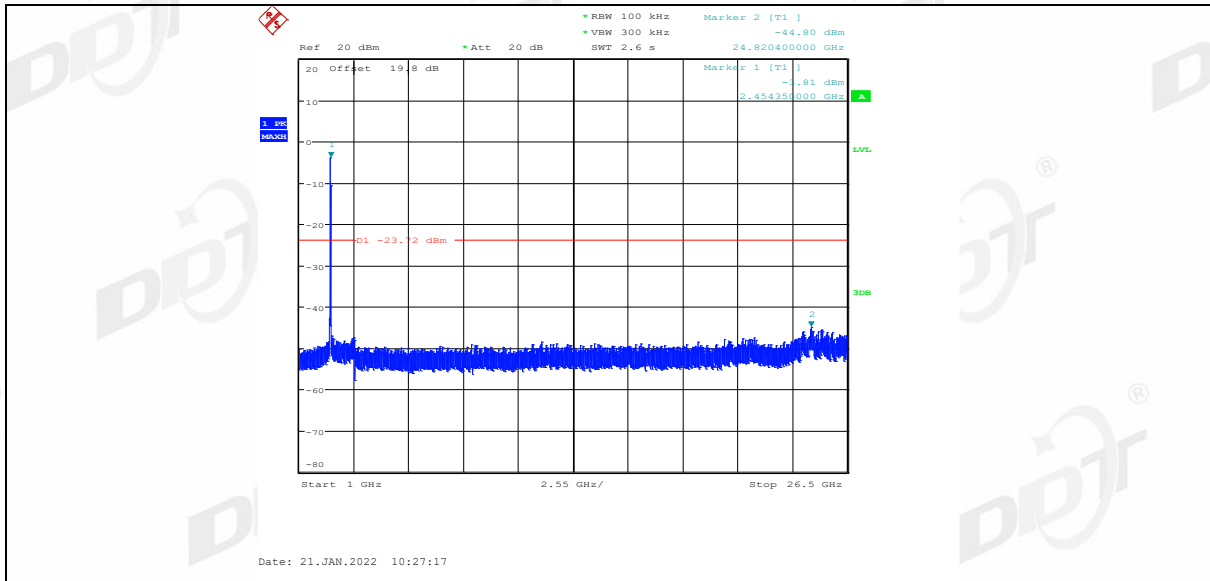

8. Radiated Spurious Emissions

8.1. Block diagram of test setup

In 3 m Anechoic Chamber, test setup diagram for 9 kHz - 30 MHz:

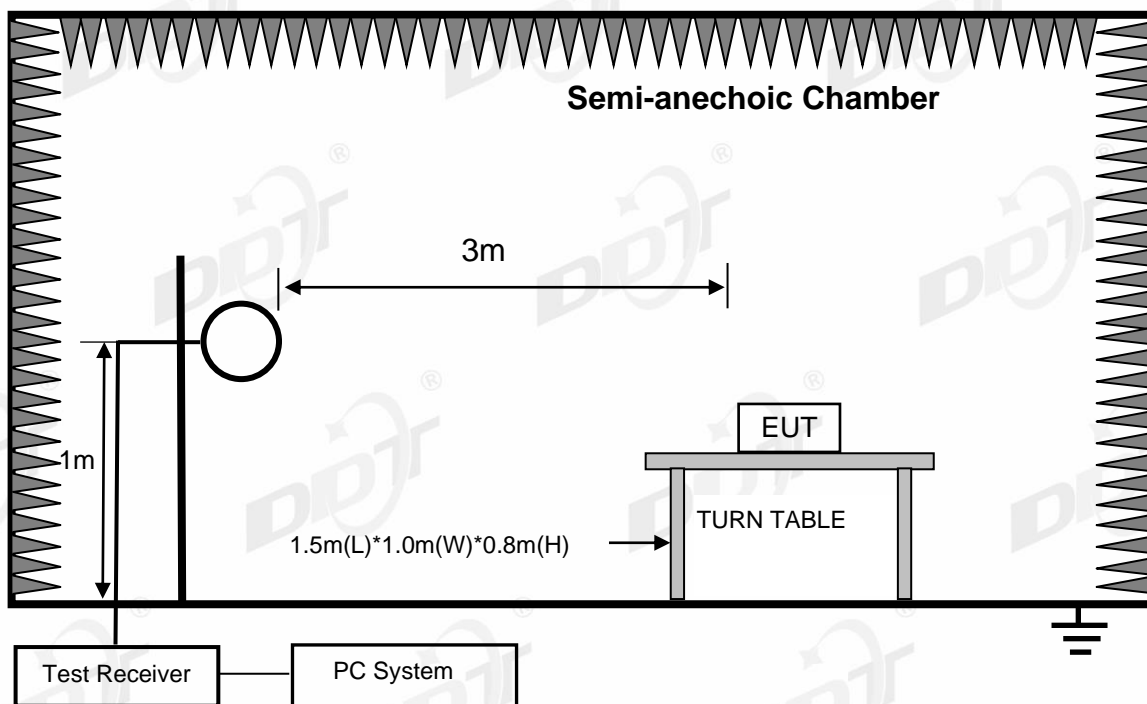

In 3 m Anechoic Chamber, test setup diagram for 30 MHz - 1 GHz:

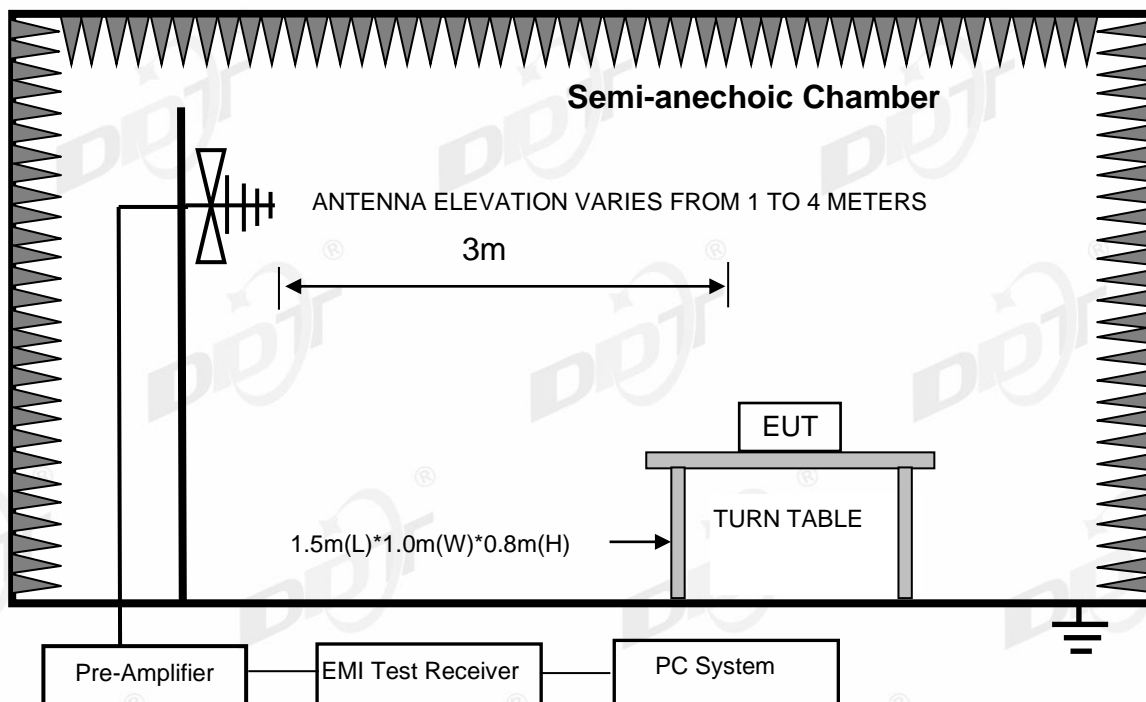

In 3 m Anechoic Chamber, test setup diagram for frequency above 1 GHz:

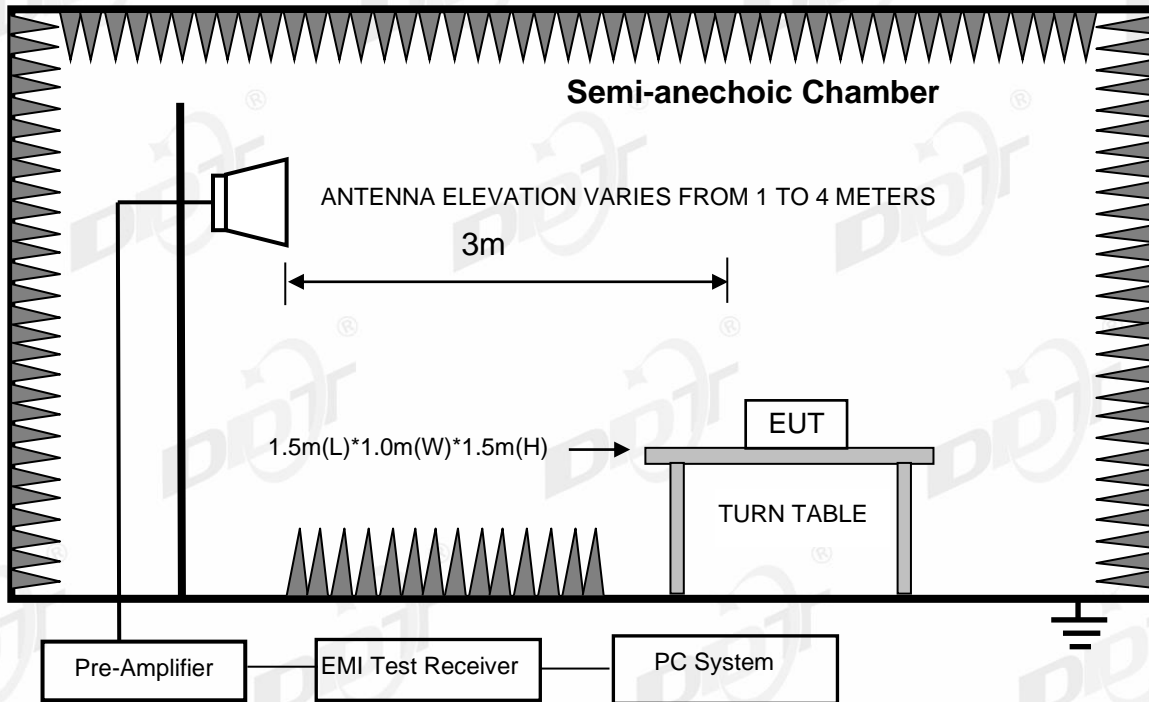

Note: For harmonic emissions test an appropriate high pass filter was inserted in the input port of AMP.

8.2. Limit

8.2.1 FCC 15.205 Restricted frequency band

MHz	MHz	MHz	GHz
0.090-0.110	16.42-16.423	399.9-410	4.5-5.15
¹ 0.495-0.505	16.69475-16.69525	608-614	5.35-5.46
2.1735-2.1905	16.80425-16.80475	960-1240	7.25-7.75
4.125-4.128	25.5-25.67	1300-1427	8.025-8.5
4.1772&4.17775	37.5-38.25	1435-1626.5	9.0-9.2
4.2072&4.20775	73-74.6	1645.5-1646.5	9.3-9.5
6.215-6.218	74.8-75.2	1660-1710	10.6-12.7
6.26775-6.26825	108-121.94	1718.8-1722.2	13.25-13.4
6.31175-6.31225	123-138	2200-2300	14.47-14.5
8.291-8.294	149.9-150.05	2310-2390	15.35-16.2
8.362-8.366	156.52475-156.52525	2483.5-2500	17.7-21.4
8.37625-8.38675	156.7-156.9	2690-2900	22.01-23.12
8.41425-8.41475	162.0125-167.17	3260-3267	23.6-24.0
12.29-12.293	167.72-173.2	3332-3339	31.2-31.8
12.51975-12.52025	240-285	3345.8-3358	36.43-36.5
12.57675-12.57725	322-335.4	3600-4400	(²)
13.36-13.41			

¹Until February 1, 1999, this restricted band shall be 0.490-0.510 MHz.

²Above 38.6

8.2.2 FCC 15.209 Limit.

FREQUENCY MHz	DISTANCE Meters	FIELD STRENGTHS LIMIT	
		$\mu\text{V}/\text{m}$	$\text{dB}(\mu\text{V})/\text{m}$
0.009 ~ 0.490	300	2400/F(kHz)	67.6-20log(F)
0.490 ~ 1.705	30	24000/F(kHz)	87.6-20log(F)
1.705 ~ 30.0	30	30	29.54
30 ~ 88	3	100	40.0
88 ~ 216	3	150	43.5
216 ~ 960	3	200	46.0
960 ~ 1000	3	500	54.0
Above 1000	3	74.0 dB(μV)/m (Peak) 54.0 dB(μV)/m (Average)	

Note: (1) The emission limits shown in the above table are based on measurements employing a CISPR QP detector except for the frequency bands 9 - 90 kHz, 110 - 490 kHz and above 1000 MHz. Radiated emissions limits in these three bands are based on measurements employing an average detector.

(2) At frequencies below 30 MHz, measurement may be performed at a distance closer than that specified, and the limit at closer measurement distance can be extrapolated by below formula:

$$\text{Limit}_{3\text{m}}(\text{dB}\mu\text{V}/\text{m}) = \text{Limit}_{30\text{m}}(\text{dB}\mu\text{V}/\text{m}) + 40\text{Log}(30\text{m}/3\text{m})$$

8.2.3 Limit for this EUT

All the emissions appearing within 15.205 restricted frequency bands shall not exceed the limits shown in 15.209, all the other emissions shall be at least 20 dB below the fundamental emissions or comply with 15.209 limits.

8.3. Test procedure

(1) EUT height should be 0.8 m for below 1 GHz at a semi-anechoic chamber while EUT height should be 1.5 m for above 1 GHz at full chamber or semi-anechoic chamber ground with absorbers.

(2) The antenna used as below table.

Test frequency range	Test antenna used	Measuring distance
9 kHz - 30 MHz	Active Loop antenna	3 m
30 MHz - 1 GHz	Trilog Broadband Antenna	3 m
1 GHz - 18 GHz	Double Ridged Horn Antenna (1 GHz - 18 GHz)	3 m
18 GHz - 40 GHz	Horn Antenna (18 GHz - 40 GHz)	1 m

According ANSI C63.10:2013 clause 6.4.4.2 and 6.5.3, for measurements below 30 MHz, the loop antenna was positioned with its plane vertical from the EUT and rotated about its vertical axis for maximum response at each azimuth position around the EUT. And the loop antenna also is positioned with its plane horizontal at the specified distance from the EUT. The center of the

loop is 1 m above the ground. For measurement above 30 MHz, the Trilog Broadband Antenna or Horn Antenna was located 3 m from EUT, Measurements were made with the antenna positioned in both the horizontal and vertical planes of Polarization, and the measurement antenna was varied from 1 m to 4 m. in height above the reference ground plane to obtain the maximum signal strength.

(3) Below pre-scan procedure was first performed in order to find prominent frequency spectrum radiated emissions from 9 kHz to 25 GHz:

(a) Scanning the peak frequency spectrum with the antenna specified in step (3), and the EUT was rotated 360 degree, the antenna height was varied from 1 m to 4 m (Except loop antenna, it's fixed 1 m above ground.)

(b) Change work frequency or channel of device if practicable.

(c) Change modulation type of device if practicable.

(d) Change power supply range from 85% to 115% of the rated supply voltage

(e) Rotated EUT though three orthogonal axes to determine the attitude of EUT arrangement produces highest emissions.

Spectrum frequency from 9 kHz to 25 GHz (tenth harmonic of fundamental frequency) was investigated, and no any obvious emission were detected from 18 GHz to 25 GHz, so below final test was performed with frequency range from 9 kHz to 18 GHz.

(4) For final emissions measurements at each frequency of interest, the EUT was rotated and the antenna height was varied between 1 m and 4 m in order to maximize the emission. Measurements in both horizontal and vertical polarities were made and the data was recorded. In order to find the maximum emission, the relative positions of equipments and all of the interface cables were changed according to ANSI C63.10:2013 on Radiated Emission test.

(5) The emissions from 9 kHz to 1 GHz were measured based on CISPR QP detector except for the frequency bands 9 - 90 kHz, 110 - 490 kHz, for emissions from 9 kHz - 90 kHz, 110 kHz - 490 kHz and above 1 GHz were measured based on average detector, for emissions above 1 GHz, peak emissions also be measured and need comply with Peak limit.

(6) The emissions from 9 kHz to 1 GHz, QP or average values were measured with EMI receiver with below RBW:

Frequency band	RBW
9 kHz - 150 kHz	200 Hz
150 kHz - 30 MHz	9 kHz
30 MHz - 1 GHz	120 kHz

(7) For emissions above 1 GHz, both Peak and Average level were measured with Spectrum Analyzer, and the RBW is set at 1 MHz, VBW is set at 3 MHz for Peak measure; About Average measure refer to ANSI C63.10:2013 clause 4.2.3.2.3 procedure.

8.4. Test result

Pass. (See below detailed test result)

All the emissions except fundamental emission from 9 kHz to 25 GHz were comply with 15.209 limit.

Note1: According exploratory test, the emission levels are 20 dB below the limit detected from 9 kHz to 30 MHz and 18 GHz to 25 GHz, so the final test was performed with frequency range from 30 MHz to 18 GHz and recorded in below.

Note2: For emissions below 1 GHz, according exploratory explorer test, when change Tx mode and channel, have no distinct influence on emissions level, so for emissions below 1 GHz, the final test was only performed with EUT working in 11b, Tx CH1 mode.

Note3: For emissions above 1 GHz. Scan with 11b mode, 11g mode, 11n HT20 and 11n HT40 mode, the worst case is 11b mode. If peak results comply with AV limit, AV Result is deemed to comply with AV limit. Other emission levels are attenuated 20 dB below the limit, so it does not record in the report.

Radiated Emission test (below 1 GHz)

TR-4-E-009 Radiated Emission Test Result

Test Site : DDT 3m Chamber 3# D:\2021 report data\Q21120722 -2E D6\FCC BELOW 1G\FCC BELOW 1G_00001.EMI
Test Date : 2022-01-25 **Tested By** : Kennys Zhang
EUT : Dash cam **Model Number** : D6
Power Supply : DC 5V **Test Mode** : Tx Mode
Condition : Temp:24.5°,Humi:55%,Press:100.1kPa **Antenna/Distance** : VLUB 9163 3#/3m/Vertical
Memo :

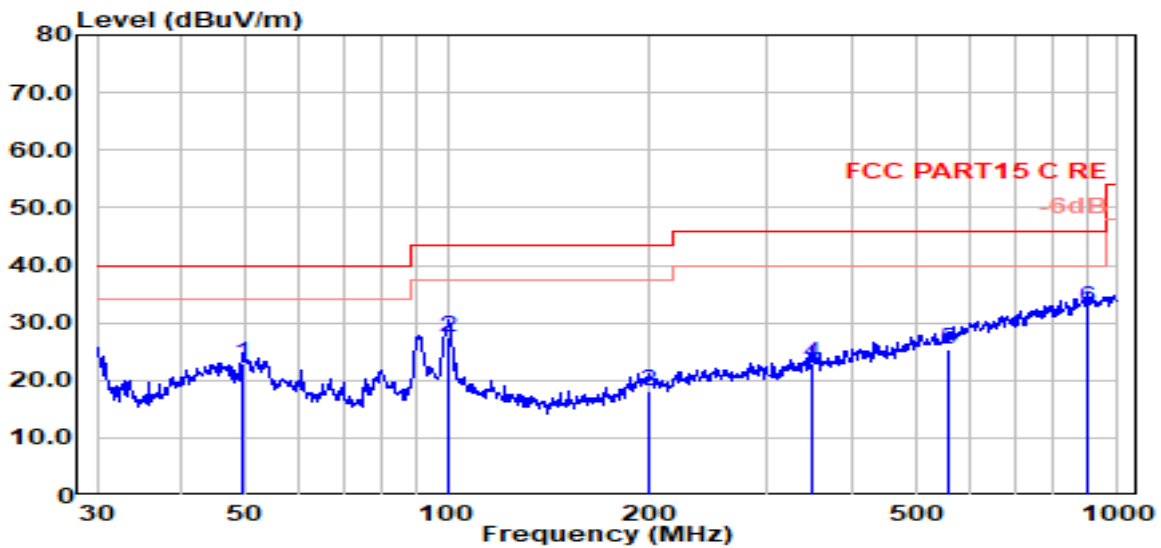

Item (Mark)	Freq. (MHz)	Read Level (dBUV)	Antenna Factor (dB/m)	Cable Loss (dB)	Result Level (dBUV/m)	Limit Line (dBUV/m)	Over Limit (dB)	Detector	Polarization
1	49.36	6.48	12.73	3.66	22.87	40.00	-17.13	QP	Vertical
2	100.23	12.05	11.52	3.98	27.55	43.50	-15.95	QP	Vertical
3	199.29	1.66	11.97	4.45	18.08	43.50	-25.42	QP	Vertical
4	349.25	2.89	15.04	4.98	22.91	46.00	-23.09	QP	Vertical
5	558.73	2.21	17.50	5.61	25.32	46.00	-20.68	QP	Vertical
6	900.15	3.88	22.10	6.48	32.46	46.00	-13.54	QP	Vertical

Note:

1. Result Level = Read Level + Antenna Factor + Cable loss.
2. If Peak Result complies with QP limit, QP Result is deemed to comply with QP limit.
3. Test setup: RBW: 120 kHz, VBW: 300 kHz, Sweep time: auto

TR-4-E-009 Radiated Emission Test Result

Test Site : DDT 3m Chamber 3#

D:\2021 report data\Q21120722 -2E D6\FCC BELOW
1G\FCC BELOW 1G_00002.EMI

Test Date : 2022-01-25

Tested By : Kennys Zhang

EUT : Dash cam

Model Number : D6

Power Supply : DC 5V

Test Mode : Tx Mode

Condition : Temp:24.5°,Humi:55%,Press:100.1kPa **Antenna/Distance** : VLUB 9163 3#/3m/Horizontal

Memo :

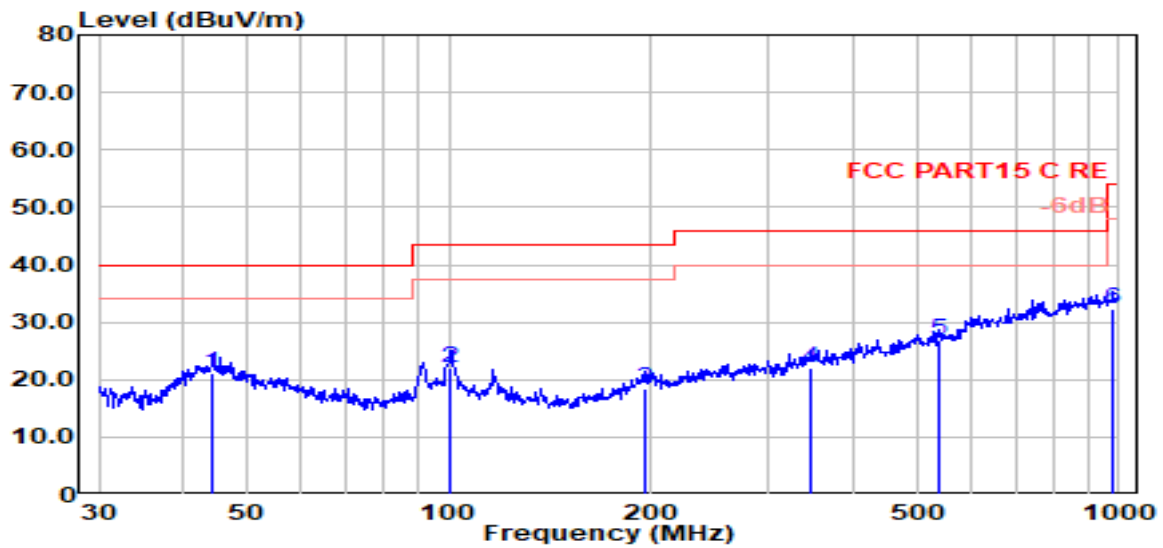

Item (Mark)	Freq. (MHz)	Read Level (dBμV)	Antenna Factor (dB/m)	Cable Loss (dB)	Result Level (dBμV/m)	Limit Line (dBμV/m)	Over Limit (dB)	Detector	Polarization
1	44.28	2.52	15.03	3.61	21.16	40.00	-18.84	QP	Horizontal
2	100.23	6.67	11.52	3.98	22.18	43.50	-21.32	QP	Horizontal
3	196.51	2.07	11.80	4.43	18.31	43.50	-25.19	QP	Horizontal
4	348.03	2.18	14.94	4.98	22.10	46.00	-23.90	QP	Horizontal
5	539.48	3.84	17.40	5.56	26.80	46.00	-19.20	QP	Horizontal
6	979.18	3.29	22.30	6.73	32.32	54.00	-21.68	QP	Horizontal

Note:

1. Result Level = Read Level + Antenna Factor + Cable loss.
2. If Peak Result complies with QP limit, QP Result is deemed to comply with QP limit.
3. Test setup: RBW: 120 kHz, VBW: 300 kHz, Sweep time: auto

Radiated Emission test (above 1 GHz) TR-4-E-009 Radiated Emission Test Result

Test Site : DDT 3m Chamber 3# D:\2021 report data\Q21120722 -2E D6\FCC ABOVE 1G\FCC ABOVE 1G_00001.EMI
Test Date : 2022-01-25 **Tested By** : Kennys Zhang
EUT : Dash cam **Model Number** : D6
Power Supply : DC 5V **Test Mode** : Tx Mode
Condition : Temp:24.5°,Humi:55%,Press:100.1kPa **Antenna/Distance** : 2021 BBHA 9120D 3#
NEW/3m/Horizontal
Memo : 11B 2412

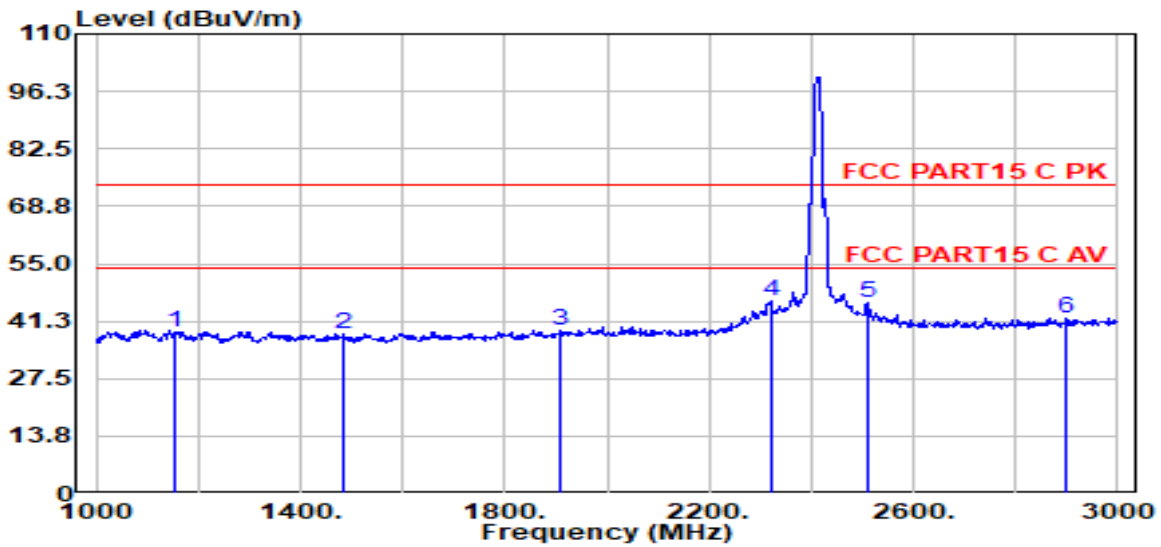

Item (Mark)	Freq. (MHz)	Read Level (dBμV)	Antenna Factor (dB/m)	Cable Loss (dB)	PRM Factor (dB)	Result Level (dBμV/m)	Limit Line (dBμV/m)	Over Limit (dB)	Detector	Polarization
1	1156.00	49.72	25.47	1.19	38.13	38.77	74.00	-35.23	Peak	Horizontal
2	1484.00	49.63	25.40	1.37	38.63	38.36	74.00	-35.64	Peak	Horizontal
3	1908.00	49.79	26.46	1.56	39.26	39.21	74.00	-34.79	Peak	Horizontal
4	2322.00	55.85	27.28	1.69	39.56	45.98	74.00	-28.02	Peak	Horizontal
5	2510.00	55.01	27.64	1.74	39.66	45.47	74.00	-28.53	Peak	Horizontal
6	2900.00	50.02	29.12	1.84	39.85	41.92	74.00	-32.08	Peak	Horizontal

Note:

1. Result Level = Read Level + Antenna Factor + Cable loss - PRM Factor.
2. If Peak Result complies with AV limit, AV Result is deemed to comply with AV limit.
3. Test setup: RBW: 1 MHz, VBW: 3 MHz, Sweep time: auto.

TR-4-E-009 Radiated Emission Test Result

Test Site : DDT 3m Chamber 3# D:\2021 report data\Q21120722 -2E D6\FCC ABOVE 1G\FCC ABOVE 1G_00002.EMI
Test Date : 2022-01-25 **Tested By** : Kennys Zhang
EUT : Dash cam **Model Number** : D6
Power Supply : DC 5V **Test Mode** : Tx Mode
Condition : Temp:24.5°,Humi:55%,Press:100.1kPa **Antenna/Distance** : 2021 BBHA 9120D 3#
NEW/3m/VERTICAL
Memo : 11B 2412

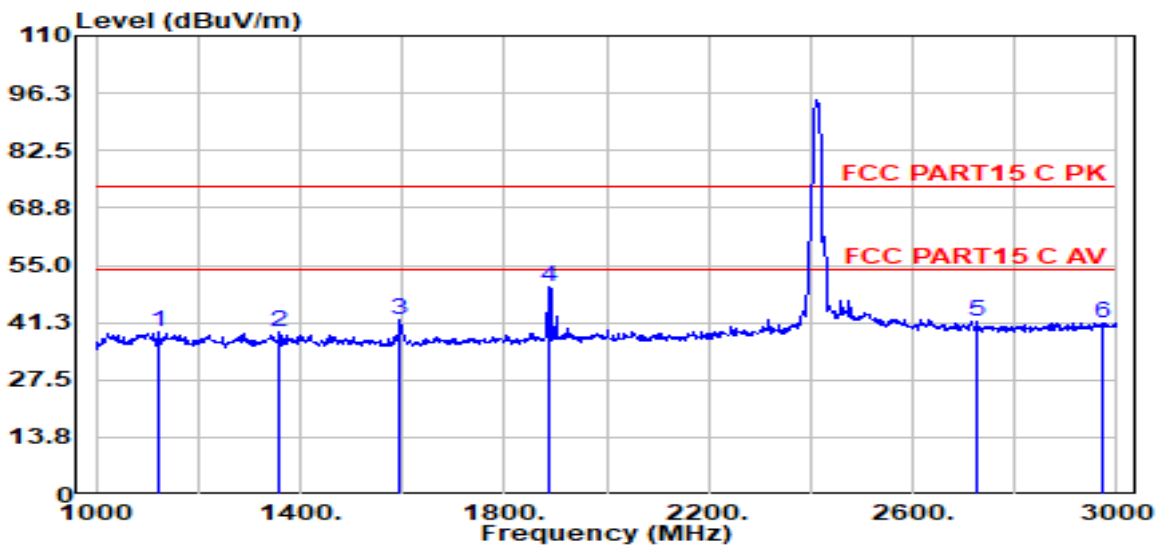

Item (Mark)	Freq. (MHz)	Read Level (dBμV)	Antenna Factor (dB/m)	Cable Loss (dB)	PRM Factor (dB)	Result Level (dBμV/m)	Limit Line (dBμV/m)	Over Limit (dB)	Detector	Polarization
1	1122.00	49.97	25.48	1.17	38.08	39.06	74.00	-34.94	Peak	VERTICAL
2	1360.00	50.12	25.43	1.30	38.44	38.98	74.00	-35.02	Peak	VERTICAL
3	1596.00	53.06	25.65	1.42	38.79	41.95	74.00	-32.05	Peak	VERTICAL
4	1888.00	60.58	26.41	1.55	39.23	49.97	74.00	-24.03	Peak	VERTICAL
5	2728.00	50.30	28.47	1.80	39.76	41.56	74.00	-32.44	Peak	VERTICAL
6	2974.00	49.14	29.40	1.86	39.89	41.30	74.00	-32.70	Peak	VERTICAL

Note:

1. Result Level = Read Level + Antenna Factor + Cable loss - PRM Factor.
2. If Peak Result complies with AV limit, AV Result is deemed to comply with AV limit.
3. Test setup: RBW: 1 MHz, VBW: 3 MHz, Sweep time: auto.

TR-4-E-009 Radiated Emission Test Result

Test Site : DDT 3m Chamber 3# D:\2021 report data\Q21120722 -2E D6\FCC ABOVE 1G\FCC ABOVE 1G_00003.EMI
Test Date : 2022-01-25 **Tested By** : Kennys Zhang
EUT : Dash cam **Model Number** : D6
Power Supply : DC 5V **Test Mode** : Tx Mode
Condition : Temp:24.5°,Humi:55%,Press:100.1kPa **Antenna/Distance** : 2021 BBHA 9120D 3#
NEW/3m/VERTICAL
Memo : 11B 2437

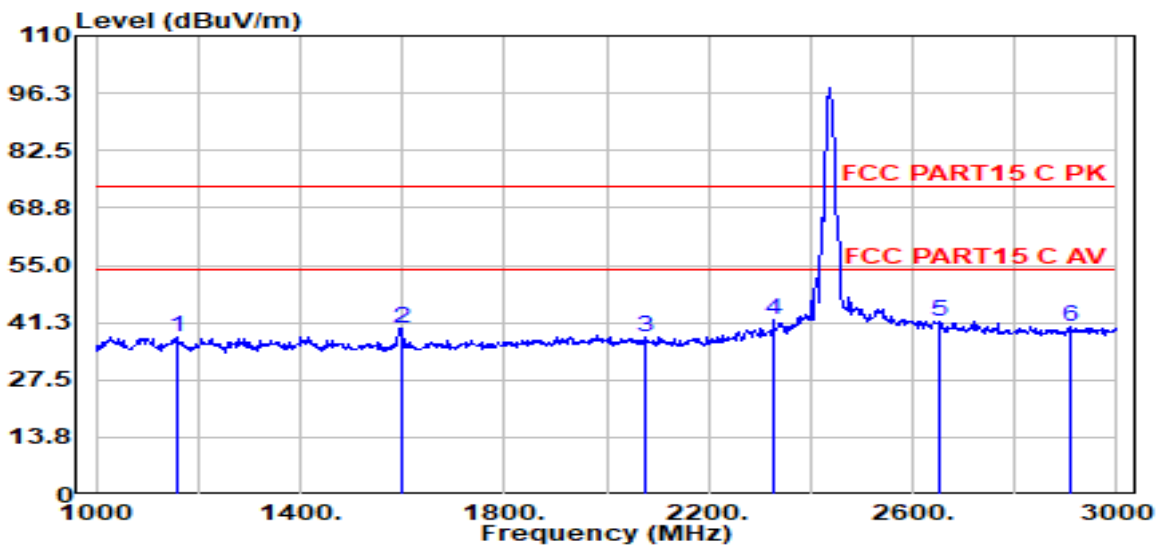

Item (Mark)	Freq. (MHz)	Read Level (dBμV)	Antenna Factor (dB/m)	Cable Loss (dB)	PRM Factor (dB)	Result Level (dBμV/m)	Limit Line (dBμV/m)	Over Limit (dB)	Detector	Polarization
1	1158.00	48.80	25.47	1.19	38.14	37.85	74.00	-36.15	Peak	VERTICAL
2	1600.00	51.01	25.66	1.42	38.80	39.90	74.00	-34.10	Peak	VERTICAL
3	2074.00	47.94	26.83	1.62	39.44	37.65	74.00	-36.35	Peak	VERTICAL
4	2328.00	51.74	27.29	1.69	39.56	41.87	74.00	-32.13	Peak	VERTICAL
5	2650.00	50.61	28.17	1.78	39.73	41.58	74.00	-32.42	Peak	VERTICAL
6	2910.00	48.33	29.16	1.85	39.86	40.26	74.00	-33.74	Peak	VERTICAL

Note:

1. Result Level = Read Level + Antenna Factor + Cable loss - PRM Factor.
2. If Peak Result complies with AV limit, AV Result is deemed to comply with AV limit.
3. Test setup: RBW: 1 MHz, VBW: 3 MHz, Sweep time: auto.

TR-4-E-009 Radiated Emission Test Result

Test Site : DDT 3m Chamber 3#

D:\2021 report data\Q21120722 -2E D6\FCC ABOVE
1G\FCC ABOVE 1G_00004.EMI

Test Date : 2022-01-25

Tested By : Kennys Zhang

EUT : Dash cam

Model Number : D6

Power Supply : DC 5V

Test Mode : Tx Mode

Condition : Temp:24.5°,Humi:55%,Press:100.1kPa **Antenna/Distance** : 2021 BBHA 9120D 3#
NEW/3m/HORIZONTAL

Memo : 11B 2437

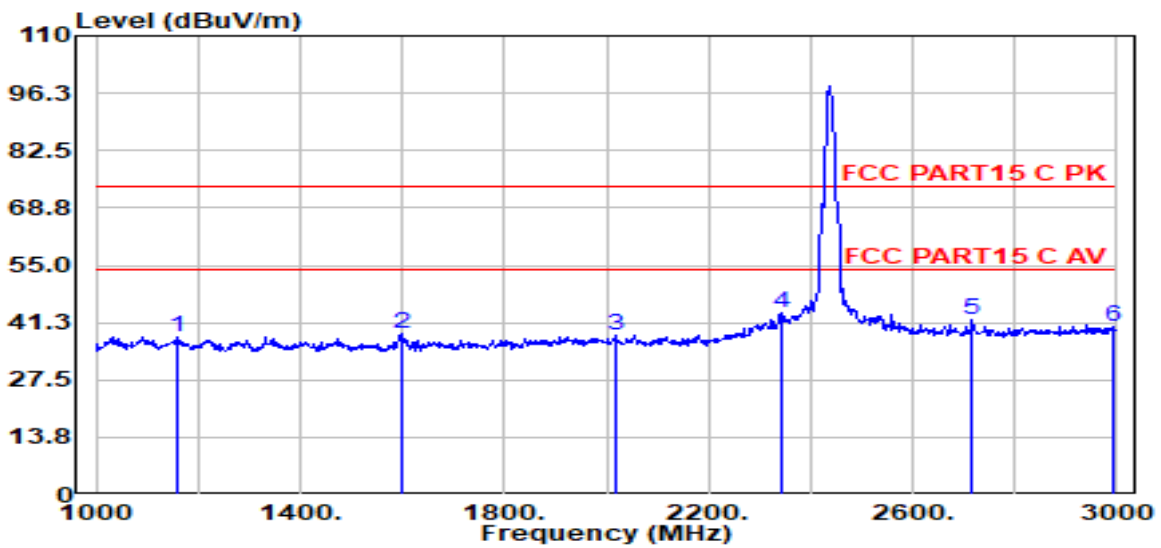

Item (Mark)	Freq. (MHz)	Read Level (dBμV)	Antenna Factor (dB/m)	Cable Loss (dB)	PRM Factor (dB)	Result Level (dBμV/m)	Limit Line (dBμV/m)	Over Limit (dB)	Detector	Polarization
1	1160.00	48.53	25.47	1.19	38.14	37.58	74.00	-36.42	Peak	HORIZONTAL
2	1600.00	49.88	25.66	1.42	38.80	38.77	74.00	-35.23	Peak	HORIZONTAL
3	2016.00	48.44	26.73	1.60	39.41	38.04	74.00	-35.96	Peak	HORIZONTAL
4	2344.00	53.53	27.32	1.70	39.57	43.69	74.00	-30.31	Peak	HORIZONTAL
5	2716.00	50.71	28.42	1.80	39.76	41.92	74.00	-32.08	Peak	HORIZONTAL
6	2992.00	47.83	29.47	1.87	39.90	40.06	74.00	-33.94	Peak	HORIZONTAL

Note:

1. Result Level = Read Level + Antenna Factor + Cable loss - PRM Factor.
2. If Peak Result complies with AV limit, AV Result is deemed to comply with AV limit.
3. Test setup: RBW: 1 MHz, VBW: 3 MHz, Sweep time: auto.

TR-4-E-009 Radiated Emission Test Result

Test Site : DDT 3m Chamber 3# D:\2021 report data\Q21120722 -2E D6\FCC ABOVE 1G\FCC ABOVE 1G_00005.EMI
Test Date : 2022-01-25 **Tested By** : Kennys Zhang
EUT : Dash cam **Model Number** : D6
Power Supply : DC 5V **Test Mode** : Tx Mode
Condition : Temp:24.5°,Humi:55%,Press:100.1kPa **Antenna/Distance** : 2021 BBHA 9120D 3#
NEW/3m/HORIZONTAL
Memo : 11B 2462

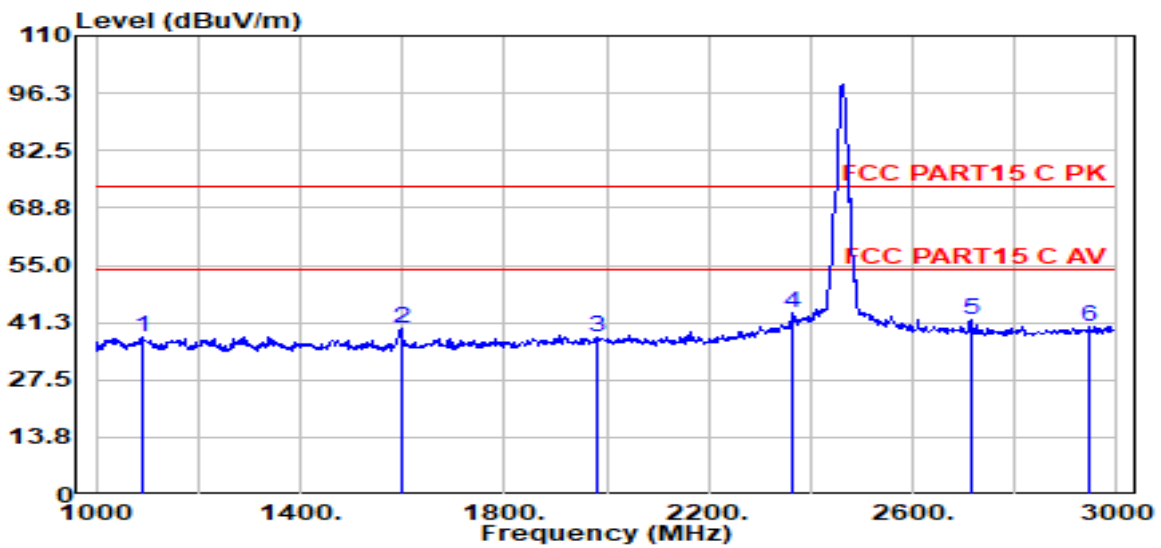

Item (Mark)	Freq. (MHz)	Read Level (dBμV)	Antenna Factor (dB/m)	Cable Loss (dB)	PRM Factor (dB)	Result Level (dBμV/m)	Limit Line (dBμV/m)	Over Limit (dB)	Detector	Polarization
1	1092.00	48.76	25.48	1.15	38.04	37.87	74.00	-36.13	Peak	HORIZONTAL
2	1598.00	50.77	25.65	1.42	38.80	39.66	74.00	-34.34	Peak	HORIZONTAL
3	1982.00	48.32	26.65	1.59	39.37	37.87	74.00	-36.13	Peak	HORIZONTAL
4	2366.00	53.30	27.36	1.70	39.58	43.50	74.00	-30.50	Peak	HORIZONTAL
5	2714.00	50.78	28.41	1.80	39.76	41.99	74.00	-32.01	Peak	HORIZONTAL
6	2948.00	48.40	29.30	1.86	39.87	40.47	74.00	-33.53	Peak	HORIZONTAL

Note:

1. Result Level = Read Level + Antenna Factor + Cable loss - PRM Factor.
2. If Peak Result complies with AV limit, AV Result is deemed to comply with AV limit.
3. Test setup: RBW: 1 MHz, VBW: 3 MHz, Sweep time: auto.

TR-4-E-009 Radiated Emission Test Result

Test Site : DDT 3m Chamber 3# D:\2021 report data\Q21120722 -2E D6\FCC ABOVE 1G\FCC ABOVE 1G_00006.EMI
Test Date : 2022-01-25 **Tested By** : Kennys Zhang
EUT : Dash cam **Model Number** : D6
Power Supply : DC 5V **Test Mode** : Tx Mode
Condition : Temp:24.5°,Humi:55%,Press:100.1kPa **Antenna/Distance** : 2021 BBHA 9120D 3#
NEW/3m/VERTICAL
Memo : 11B 2462

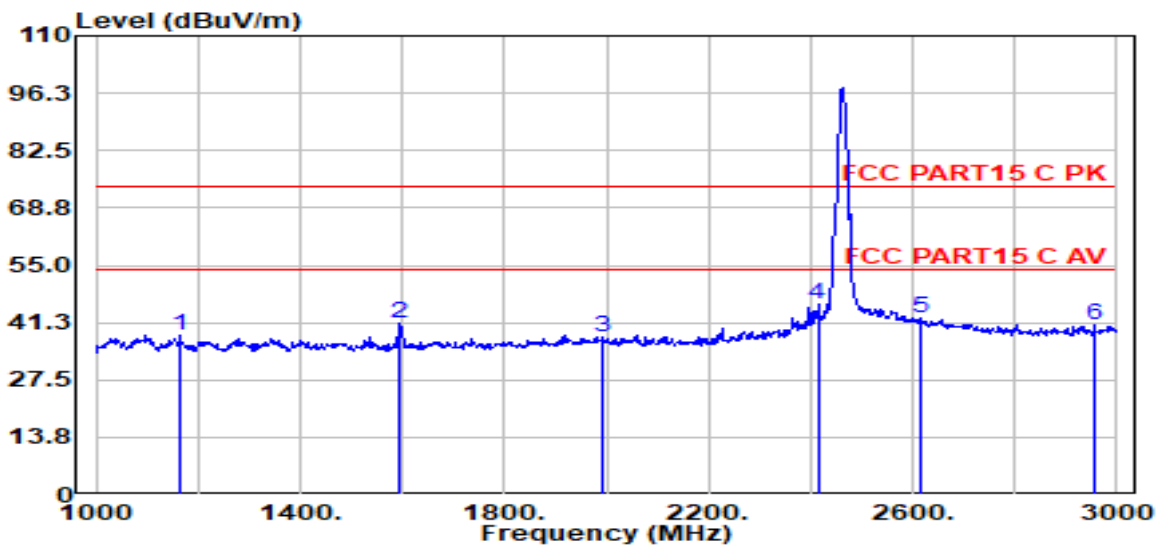

Item (Mark)	Freq. (MHz)	Read Level (dBμV)	Antenna Factor (dB/m)	Cable Loss (dB)	PRM Factor (dB)	Result Level (dBμV/m)	Limit Line (dBμV/m)	Over Limit (dB)	Detector	Polarization
1	1164.00	48.99	25.47	1.19	38.15	38.03	74.00	-35.97	Peak	VERTICAL
2	1594.00	52.33	25.64	1.42	38.79	41.22	74.00	-32.78	Peak	VERTICAL
3	1992.00	48.19	26.68	1.60	39.39	37.76	74.00	-36.24	Peak	VERTICAL
4	2414.00	55.47	27.45	1.72	39.61	45.75	74.00	-28.25	Peak	VERTICAL
5	2618.00	51.35	28.05	1.77	39.71	42.21	74.00	-31.79	Peak	VERTICAL
6	2956.00	48.74	29.33	1.86	39.88	40.84	74.00	-33.16	Peak	VERTICAL

Note:

1. Result Level = Read Level + Antenna Factor + Cable loss - PRM Factor.
2. If Peak Result complies with AV limit, AV Result is deemed to comply with AV limit.
3. Test setup: RBW: 1 MHz, VBW: 3 MHz, Sweep time: auto.

TR-4-E-009 Radiated Emission Test Result

Test Site : DDT 3m Chamber 3#

D:\2021 report data\Q21120722 -2E D6\FCC ABOVE
1G\FCC ABOVE 1G_00007.EMI

Test Date : 2022-01-25

Tested By : Kennys Zhang

EUT : Dash cam

Model Number : D6

Power Supply : DC 5V

Test Mode : Tx Mode

Condition : Temp:24.5°,Humi:55%,Press:100.1kPa **Antenna/Distance** : 2021 BBHA 9120D 3#
NEW/3m/VERTICAL

Memo : 11B 2412

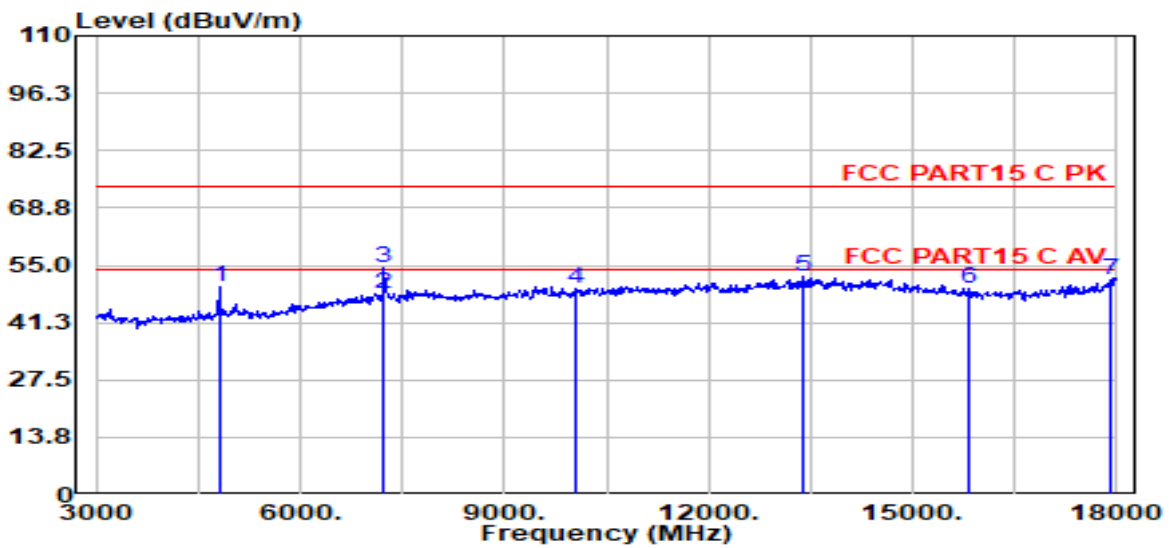

Item (Mark)	Freq. (MHz)	Read Level (dBμV)	Antenna Factor (dB/m)	Cable Loss (dB)	PRM Factor (dB)	Result Level (dBμV/m)	Limit Line (dBμV/m)	Over Limit (dB)	Detector	Polarization
1	4824.00	53.20	32.54	2.48	40.36	50.01	74.00	-23.99	Peak	VERTICAL
2	7230.00	46.51	36.18	3.08	39.72	48.31	54.00	-5.69	Average	VERTICAL
3	7230.00	52.54	36.18	3.08	39.72	54.34	74.00	-19.66	Peak	VERTICAL
4	10065.00	45.30	38.48	3.67	40.57	49.35	74.00	-24.65	Peak	VERTICAL
5	13380.00	45.53	39.90	4.09	40.13	52.33	74.00	-21.67	Peak	VERTICAL
6	15840.00	43.59	38.19	4.59	39.85	49.56	74.00	-24.44	Peak	VERTICAL
7	17925.00	41.41	42.04	4.94	40.66	51.50	74.00	-22.50	Peak	VERTICAL

Note:

1. Result Level = Read Level + Antenna Factor + Cable loss - PRM Factor.
2. If Peak Result complies with AV limit, AV Result is deemed to comply with AV limit.
3. Test setup: RBW: 1 MHz, VBW: 3 MHz, Sweep time: auto.

TR-4-E-009 Radiated Emission Test Result

Test Site : DDT 3m Chamber 3#

D:\2021 report data\Q21120722 -2E D6\FCC ABOVE
1G\FCC ABOVE 1G_00008.EMI

Test Date : 2022-01-25

Tested By : Kennys Zhang

EUT : Dash cam

Model Number : D6

Power Supply : DC 5V

Test Mode : Tx Mode

Condition : Temp:24.5°,Humi:55%,Press:100.1kPa **Antenna/Distance** : 2021 BBHA 9120D 3#
NEW/3m/HORIZONTAL

Memo : 11B 2412

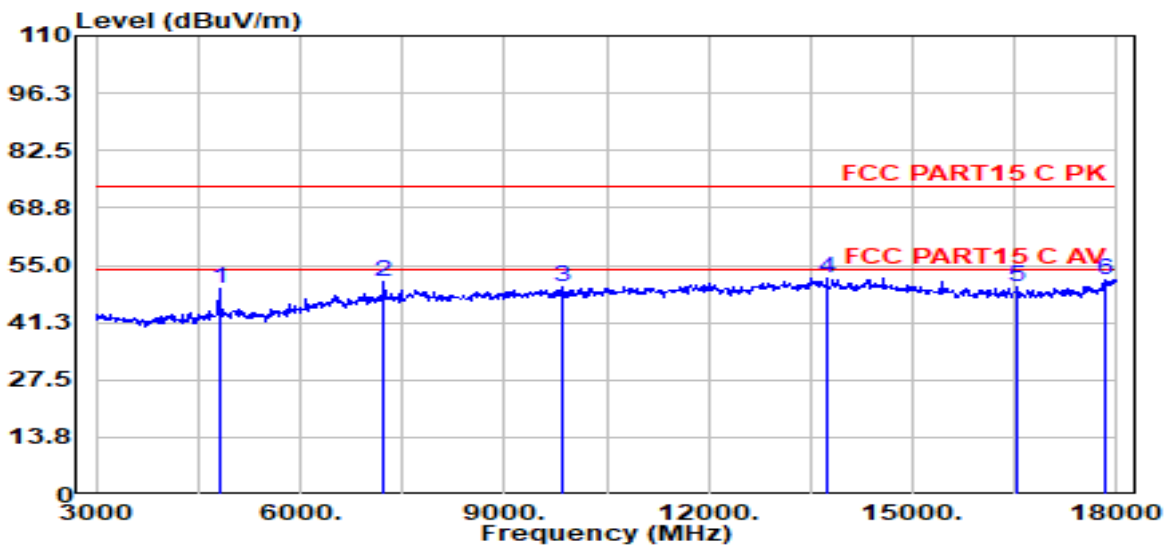

Item (Mark)	Freq. (MHz)	Read Level (dBμV)	Antenna Factor (dB/m)	Cable Loss (dB)	PRM Factor (dB)	Result Level (dBμV/m)	Limit Line (dBμV/m)	Over Limit (dB)	Detector	Polarization
1	4824.00	52.38	32.54	2.48	40.36	49.19	74.00	-24.81	Peak	HORIZONTAL
2	7230.00	49.21	36.18	3.08	39.72	51.01	74.00	-22.99	Peak	HORIZONTAL
3	9840.00	45.86	38.50	3.65	40.49	49.96	74.00	-24.04	Peak	HORIZONTAL
4	13740.00	44.75	39.95	4.25	39.88	51.98	74.00	-22.02	Peak	HORIZONTAL
5	16545.00	43.71	37.95	4.73	40.01	49.72	74.00	-24.28	Peak	HORIZONTAL
6	17835.00	41.92	41.48	4.91	40.60	51.45	74.00	-22.55	Peak	HORIZONTAL

Note:

1. Result Level = Read Level + Antenna Factor + Cable loss - PRM Factor.
2. If Peak Result complies with AV limit, AV Result is deemed to comply with AV limit.
3. Test setup: RBW: 1 MHz, VBW: 3 MHz, Sweep time: auto.

TR-4-E-009 Radiated Emission Test Result

Test Site : DDT 3m Chamber 3# D:\2021 report data\Q21120722 -2E D6\FCC ABOVE 1G\FCC ABOVE 1G_00009.EMI
Test Date : 2022-01-25 **Tested By** : Kennys Zhang
EUT : Dash cam **Model Number** : D6
Power Supply : DC 5V **Test Mode** : Tx Mode
Condition : Temp:24.5°,Humi:55%,Press:100.1kPa **Antenna/Distance** : 2021 BBHA 9120D 3#
NEW/3m/HORIZONTAL
Memo : 11B 2437

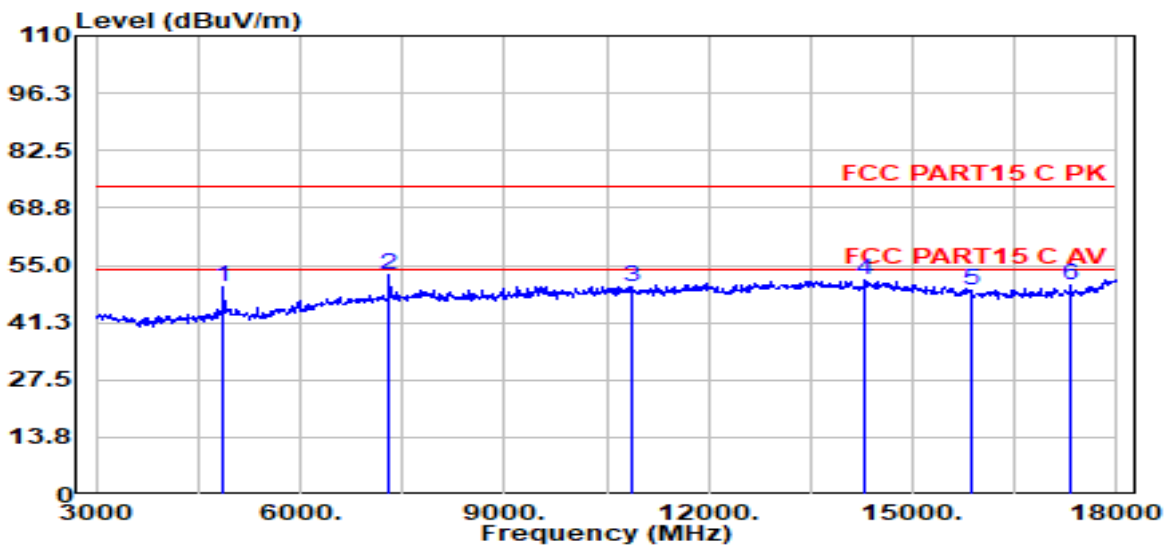

Item (Mark)	Freq. (MHz)	Read Level (dBμV)	Antenna Factor (dB/m)	Cable Loss (dB)	PRM Factor (dB)	Result Level (dBUV/m)	Limit Line (dBUV/m)	Over Limit (dB)	Detector	Polarization
1	4874.00	52.69	32.70	2.49	40.37	49.68	74.00	-24.32	Peak	HORIZONTAL
2	7305.00	50.68	36.24	3.09	39.73	52.56	74.00	-21.44	Peak	HORIZONTAL
3	10860.00	44.87	39.22	3.76	40.26	49.98	74.00	-24.02	Peak	HORIZONTAL
4	14310.00	43.90	39.90	4.42	39.67	51.36	74.00	-22.64	Peak	HORIZONTAL
5	15855.00	43.08	38.16	4.59	39.86	49.02	74.00	-24.98	Peak	HORIZONTAL
6	17325.00	42.96	39.09	4.78	40.30	50.13	74.00	-23.87	Peak	HORIZONTAL

Note:

1. Result Level = Read Level + Antenna Factor + Cable loss - PRM Factor.
2. If Peak Result complies with AV limit, AV Result is deemed to comply with AV limit.
3. Test setup: RBW: 1 MHz, VBW: 3 MHz, Sweep time: auto.

TR-4-E-009 Radiated Emission Test Result

Test Site : DDT 3m Chamber 3#

D:\2021 report data\Q21120722 -2E D6\FCC ABOVE
1G\FCC ABOVE 1G_00010.EMI

Test Date : 2022-01-25

Tested By : Kennys Zhang

EUT : Dash cam

Model Number : D6

Power Supply : DC 5V

Test Mode : Tx Mode

Condition : Temp:24.5°,Humi:55%,Press:100.1kPa **Antenna/Distance** : 2021 BBHA 9120D 3#
NEW/3m/VERTICAL

Memo : 11B 2437

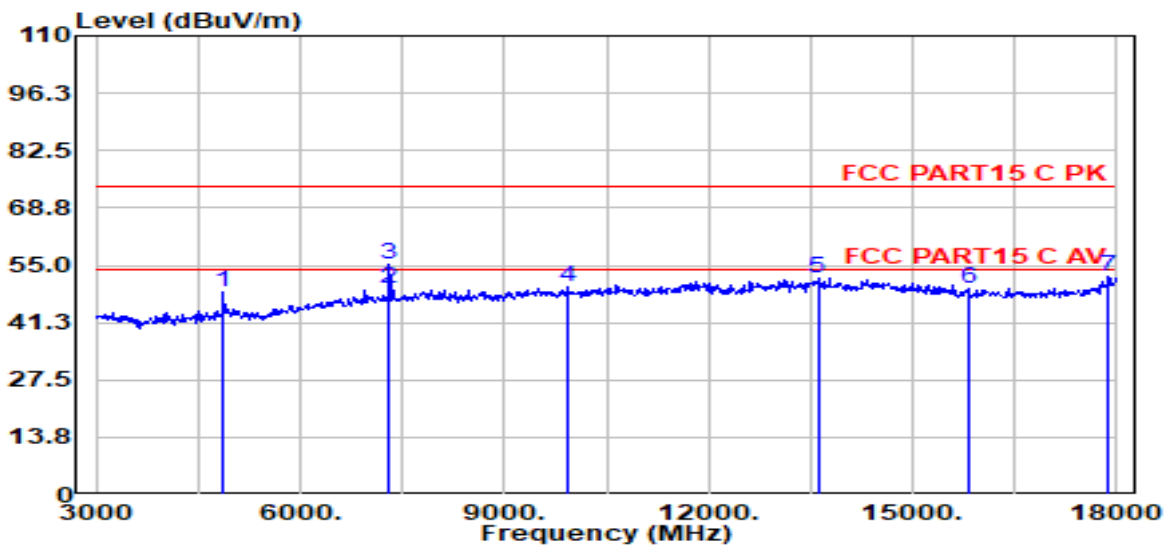

Item (Mark)	Freq. (MHz)	Read Level (dBμV)	Antenna Factor (dB/m)	Cable Loss (dB)	PRM Factor (dB)	Result Level (dBUV/m)	Limit Line (dBUV/m)	Over Limit (dB)	Detector	Polarization
1	4875.00	51.65	32.70	2.50	40.38	48.64	74.00	-25.36	Peak	VERTICAL
2	7305.00	47.61	36.24	3.09	39.73	49.48	54.00	-4.52	Average	VERTICAL
3	7305.00	53.33	36.24	3.09	39.73	55.20	74.00	-18.80	Peak	VERTICAL
4	9945.00	45.69	38.43	3.66	40.56	49.69	74.00	-24.31	Peak	VERTICAL
5	13605.00	44.87	39.98	4.10	39.98	51.90	74.00	-22.10	Peak	VERTICAL
6	15825.00	43.32	38.22	4.59	39.85	49.30	74.00	-24.70	Peak	VERTICAL
7	17865.00	42.44	41.66	4.92	40.62	52.15	74.00	-21.85	Peak	VERTICAL

Note:

1. Result Level = Read Level + Antenna Factor + Cable loss - PRM Factor.
2. If Peak Result complies with AV limit, AV Result is deemed to comply with AV limit.
3. Test setup: RBW: 1 MHz, VBW: 3 MHz, Sweep time: auto.

TR-4-E-009 Radiated Emission Test Result

Test Site : DDT 3m Chamber 3#

D:\2021 report data\Q21120722 -2E D6\FCC ABOVE
1G\FCC ABOVE 1G_00011.EMI

Test Date : 2022-01-25

Tested By : Kennys Zhang

EUT : Dash cam

Model Number : D6

Power Supply : DC 5V

Test Mode : Tx Mode

Condition : Temp:24.5°,Humi:55%,Press:100.1kPa **Antenna/Distance** : 2021 BBHA 9120D 3#
NEW/3m/VERTICAL

Memo : 11B 2462

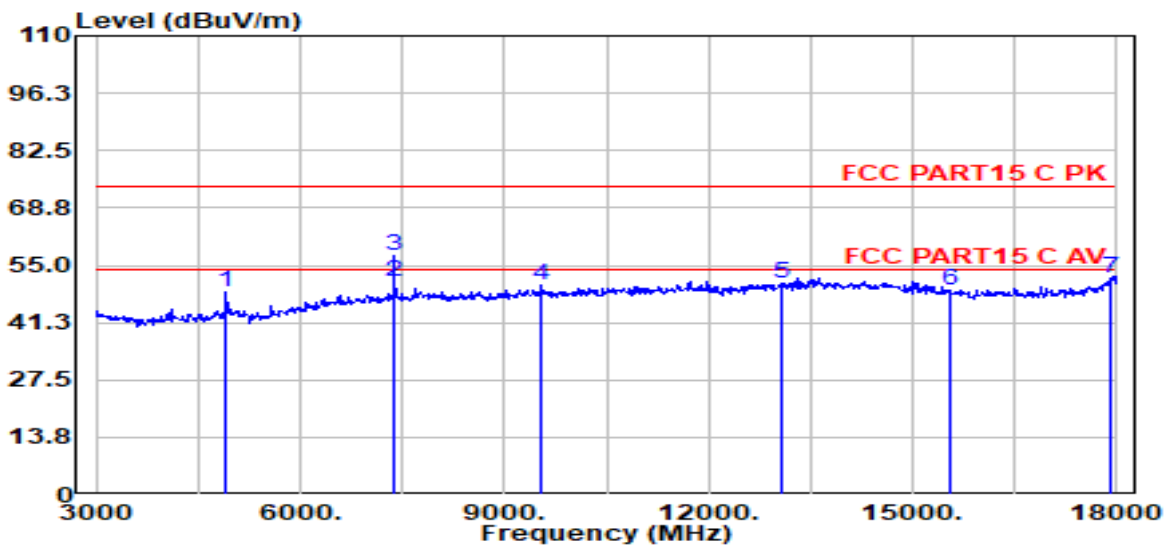

Item (Mark)	Freq. (MHz)	Read Level (dBμV)	Antenna Factor (dB/m)	Cable Loss (dB)	PRM Factor (dB)	Result Level (dBμV/m)	Limit Line (dBμV/m)	Over Limit (dB)	Detector	Polarization
1	4920.00	51.21	32.84	2.51	40.38	48.36	74.00	-25.64	Peak	VERTICAL
2	7380.00	48.99	36.30	3.11	39.74	50.93	54.00	-3.07	Average	VERTICAL
3	7380.00	55.24	36.30	3.11	39.74	57.18	74.00	-16.82	Peak	VERTICAL
4	9555.00	45.79	38.67	3.63	40.29	50.14	74.00	-23.86	Peak	VERTICAL
5	13065.00	43.89	39.65	4.35	40.35	50.49	74.00	-23.51	Peak	VERTICAL
6	15555.00	42.60	38.70	4.56	39.77	49.00	74.00	-25.00	Peak	VERTICAL
7	17895.00	41.94	41.85	4.93	40.64	51.84	74.00	-22.16	Peak	VERTICAL

Note:

1. Result Level = Read Level + Antenna Factor + Cable loss - PRM Factor.
2. If Peak Result complies with AV limit, AV Result is deemed to comply with AV limit.
3. Test setup: RBW: 1 MHz, VBW: 3 MHz, Sweep time: auto.

TR-4-E-009 Radiated Emission Test Result

Test Site : DDT 3m Chamber 3# D:\2021 report data\Q21120722 -2E D6\FCC ABOVE 1G\FCC ABOVE 1G_00012.EMI
Test Date : 2022-01-25 **Tested By** : Kennys Zhang
EUT : Dash cam **Model Number** : D6
Power Supply : DC 5V **Test Mode** : Tx Mode
Condition : Temp:24.5°,Humi:55%,Press:100.1kPa **Antenna/Distance** : 2021 BBHA 9120D 3#
NEW/3m/HORIZONTAL
Memo : 11B 2462

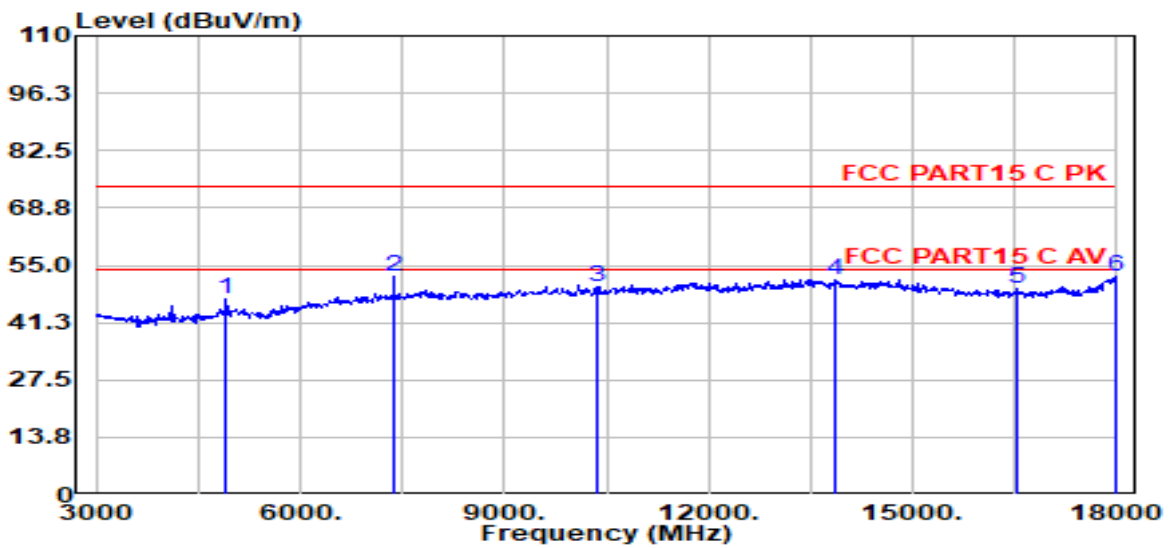

Item (Mark)	Freq. (MHz)	Read Level (dBμV)	Antenna Factor (dB/m)	Cable Loss (dB)	PRM Factor (dB)	Result Level (dBμV/m)	Limit Line (dBμV/m)	Over Limit (dB)	Detector	Polarization
1	4920.00	49.78	32.84	2.51	40.38	46.93	74.00	-27.07	Peak	HORIZONTAL
2	7380.00	50.47	36.30	3.11	39.74	52.41	74.00	-21.59	Peak	HORIZONTAL
3	10365.00	45.45	38.84	3.67	40.45	49.95	74.00	-24.05	Peak	HORIZONTAL
4	13845.00	43.92	39.93	4.36	39.81	51.32	74.00	-22.68	Peak	HORIZONTAL
5	16545.00	43.59	37.95	4.73	40.01	49.59	74.00	-24.41	Peak	HORIZONTAL
6	17970.00	42.08	42.31	4.95	40.68	52.44	74.00	-21.56	Peak	HORIZONTAL

Note:

1. Result Level = Read Level + Antenna Factor + Cable loss - PRM Factor.
2. If Peak Result complies with AV limit, AV Result is deemed to comply with AV limit.
3. Test setup: RBW: 1 MHz, VBW: 3 MHz, Sweep time: auto.

9. Radiated Band Edge Compliance

9.1. Block diagram of test setup

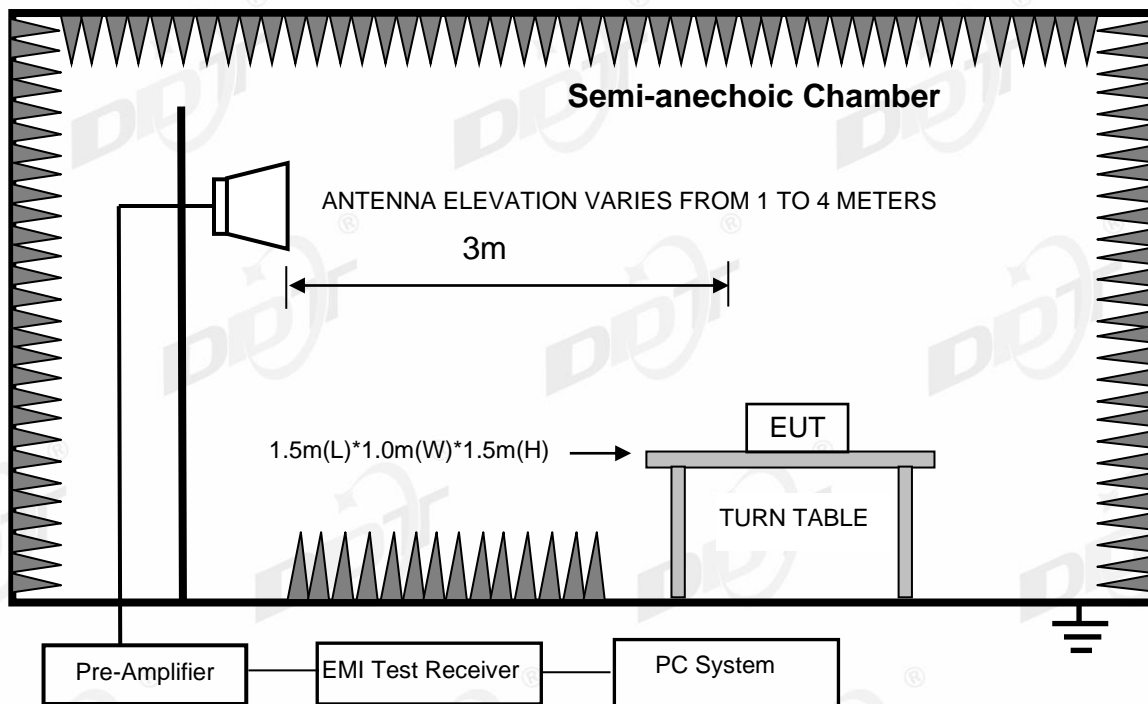

9.2. Limit

All restricted frequency bands shall not exceed the limits shown in 15.209, all the other emissions outside operation frequency band 2400 MHz to 2483.5 MHz shall be at least 20 dB below the fundamental emissions or comply with FCC 15.209 limits.

9.3. Test procedure

Same with clause 8.3 except change investigated frequency range from 2310 MHz to 2430 MHz and 2445 MHz to 2500 MHz, 2310 MHz to 2450 MHz and 2425 MHz to 2500 MHz.

Remark: All restriction band have been tested, and only the worst case is shown in report.

9.4. Test result

Pass. (See below detailed test result)

TR-4-E-009 Radiated Emission Test Result

Test Site : DDT 3m Chamber 3# D:\2021 report data\Q21120722 -2E D6\FCC ABOVE 1G\FCC ABOVE 1G_00029.EMI
Test Date : 2022-01-25 **Tested By** : Kennys Zhang
EUT : Dash cam **Model Number** : D6
Power Supply : DC 5V **Test Mode** : Tx Mode
Condition : Temp:24.5°,Humi:55%,Press:100.1kPa **Antenna/Distance** : 2021 BBHA 9120D 3#
NEW/3m/HORIZONTAL
Memo : 11B 2412

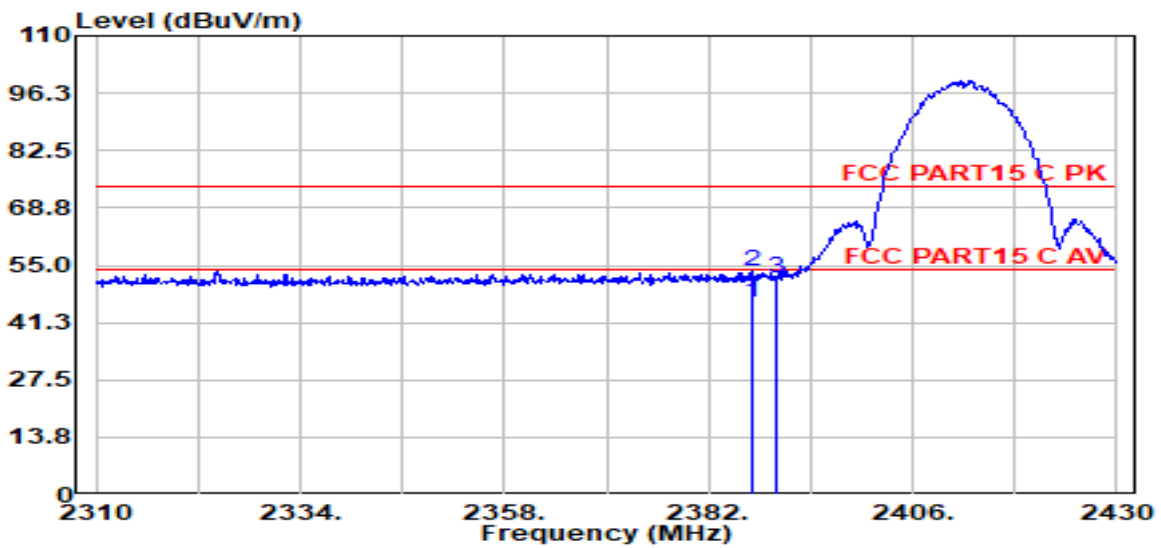

Item (Mark)	Freq. (MHz)	Read Level (dBμV)	Antenna Factor (dB/m)	Cable Loss (dB)	PRM Factor (dB)	Result Level (dBμV/m)	Limit Line (dBμV/m)	Over Limit (dB)	Detector	Polarization
1	2387.28	16.28	27.40	1.71	0.00	46.11	54.00	-7.89	Average	HORIZONTAL
2	2387.28	23.75	27.40	1.71	0.00	53.57	74.00	-20.43	Peak	HORIZONTAL
3	2390.04	22.06	27.40	1.71	0.00	51.89	74.00	-22.11	Peak	HORIZONTAL

Note:

1. Result Level = Read Level + Antenna Factor + Cable loss - PRM Factor.
2. If Peak Result complies with AV limit, AV Result is deemed to comply with AV limit.
3. Test setup: RBW: 1 MHz, VBW: 3 MHz, Sweep time: auto.

TR-4-E-009 Radiated Emission Test Result

Test Site : DDT 3m Chamber 3#

D:\2021 report data\Q21120722 -2E D6\FCC ABOVE
1G\FCC ABOVE 1G_00030.EMI

Test Date : 2022-01-25

Tested By : Kennys Zhang

EUT : Dash cam

Model Number : D6

Power Supply : DC 5V

Test Mode : Tx Mode

Condition : Temp:24.5°,Humi:55%,Press:100.1kPa **Antenna/Distance** : 2021 BBHA 9120D 3#
NEW/3m/VERTICAL

Memo : 11B 2412

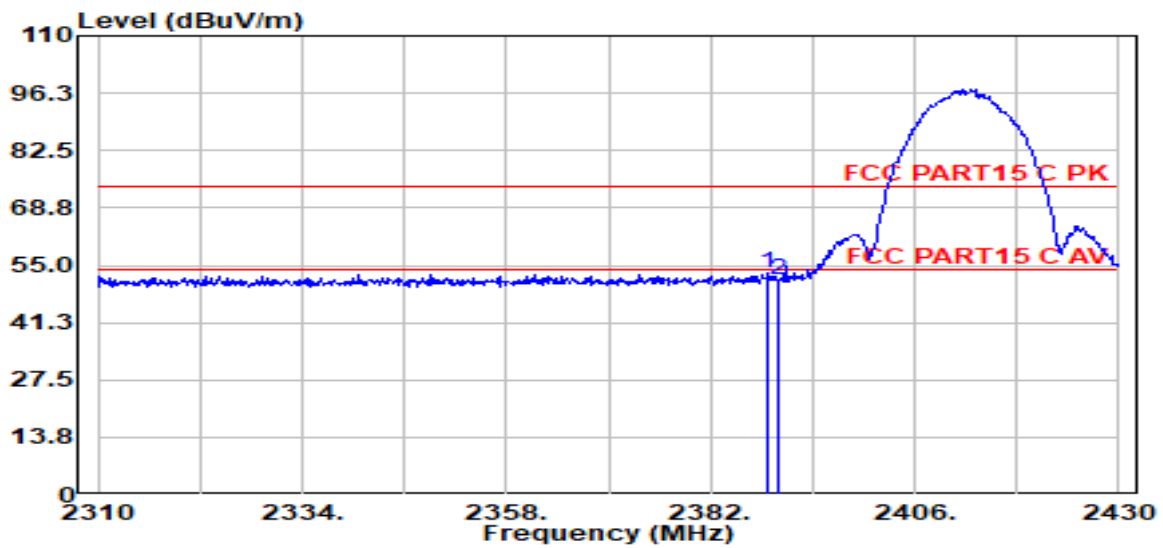

Item (Mark)	Freq. (MHz)	Read Level (dBμV)	Antenna Factor (dB/m)	Cable Loss (dB)	PRM Factor (dB)	Result Level (dBμV/m)	Limit Line (dBμV/m)	Over Limit (dB)	Detector	Polarization
1	2388.72	23.13	27.40	1.71	0.00	52.96	74.00	-21.04	Peak	VERTICAL
2	2390.04	21.79	27.40	1.71	0.00	51.63	74.00	-22.37	Peak	VERTICAL

Note:

1. Result Level = Read Level + Antenna Factor + Cable loss - PRM Factor.
2. If Peak Result complies with AV limit, AV Result is deemed to comply with AV limit.
3. Test setup: RBW: 1 MHz, VBW: 3 MHz, Sweep time: auto.

TR-4-E-009 Radiated Emission Test Result

Test Site : DDT 3m Chamber 3#

D:\2021 report data\Q21120722 -2E D6\FCC ABOVE
1G\FCC ABOVE 1G_00031.EMI

Test Date : 2022-01-25

Tested By : Kennys Zhang

EUT : Dash cam

Model Number : D6

Power Supply : DC 5V

Test Mode : Tx Mode

Condition : Temp:24.5°,Humi:55%,Press:100.1kPa **Antenna/Distance** : 2021 BBHA 9120D 3#
NEW/3m/VERTICAL

Memo : 11B 2462

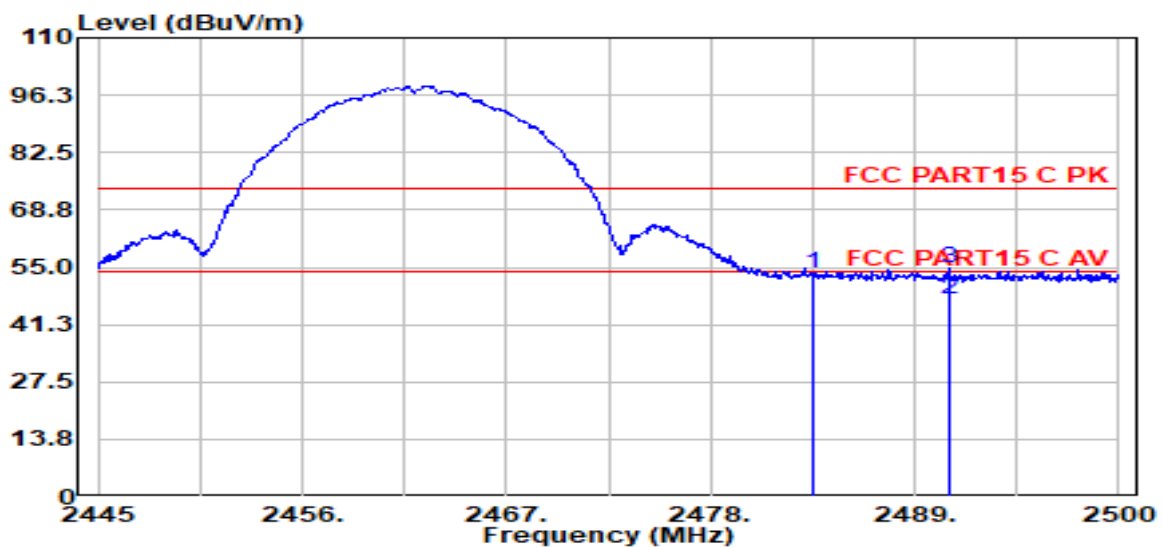

Item (Mark)	Freq. (MHz)	Read Level (dBμV)	Antenna Factor (dB/m)	Cable Loss (dB)	PRM Factor (dB)	Result Level (dBUV/m)	Limit Line (dBUV/m)	Over Limit (dB)	Detector	Polarization
1	2483.50	23.38	27.57	1.74	0.00	53.42	74.00	-20.58	Peak	VERTICAL
2	2490.82	17.28	27.58	1.74	0.00	47.33	54.00	-6.67	Average	VERTICAL
3	2490.82	24.67	27.58	1.74	0.00	54.72	74.00	-19.28	Peak	VERTICAL

Note:

1. Result Level = Read Level + Antenna Factor + Cable loss - PRM Factor.
2. If Peak Result complies with AV limit, AV Result is deemed to comply with AV limit.
3. Test setup: RBW: 1 MHz, VBW: 3 MHz, Sweep time: auto.

TR-4-E-009 Radiated Emission Test Result

Test Site : DDT 3m Chamber 3# D:\2021 report data\Q21120722 -2E D6\FCC ABOVE 1G\FCC ABOVE 1G_00032.EMI
Test Date : 2022-01-25 **Tested By** : Kennys Zhang
EUT : Dash cam **Model Number** : D6
Power Supply : DC 5V **Test Mode** : Tx Mode
Condition : Temp:24.5°,Humi:55%,Press:100.1kPa **Antenna/Distance** : 2021 BBHA 9120D 3#
NEW/3m/HORIZONTAL
Memo : 11B 2462

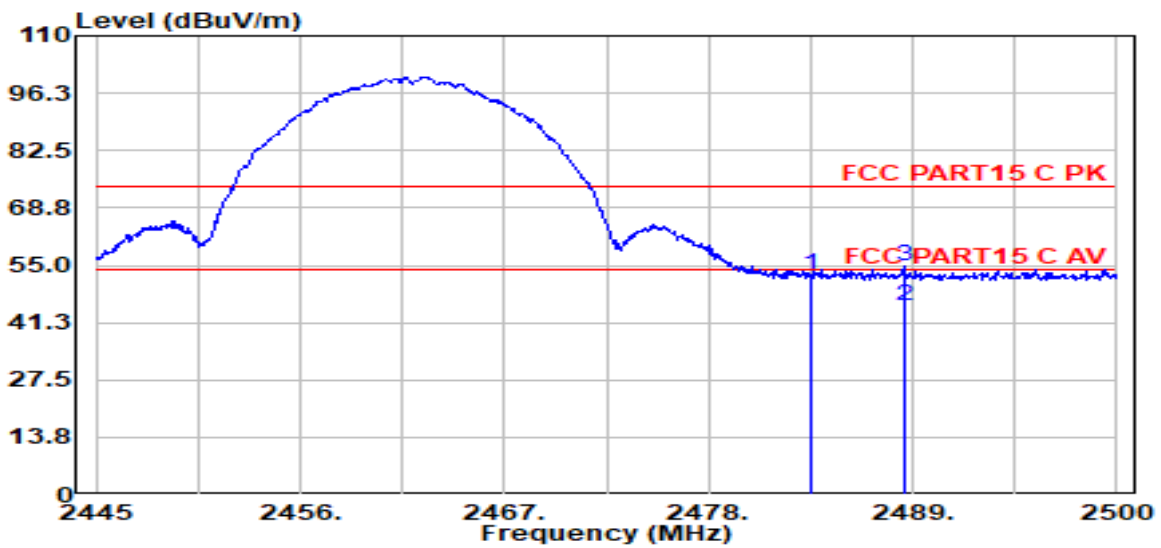

Item (Mark)	Freq. (MHz)	Read Level (dBμV)	Antenna Factor (dB/m)	Cable Loss (dB)	PRM Factor (dB)	Result Level (dBμV/m)	Limit Line (dBμV/m)	Over Limit (dB)	Detector	Polarization
1	2483.50	22.74	27.57	1.74	0.00	52.78	74.00	-21.22	Peak	HORIZONTAL
2	2488.51	15.28	27.58	1.74	0.00	45.33	54.00	-8.67	Average	HORIZONTAL
3	2488.51	24.94	27.58	1.74	0.00	54.99	74.00	-19.01	Peak	HORIZONTAL

Note:

1. Result Level = Read Level + Antenna Factor + Cable loss - PRM Factor.
2. If Peak Result complies with AV limit, AV Result is deemed to comply with AV limit.
3. Test setup: RBW: 1 MHz, VBW: 3 MHz, Sweep time: auto.

TR-4-E-009 Radiated Emission Test Result

Test Site : DDT 3m Chamber 3#

D:\2021 report data\Q21120722 -2E D6\FCC ABOVE
1G\FCC ABOVE 1G_00017.EMI

Test Date : 2022-01-25

Tested By : Kennys Zhang

EUT : Dash cam

Model Number : D6

Power Supply : DC 5V

Test Mode : Tx Mode

Condition : Temp:24.5°,Humi:55%,Press:100.1kPa **Antenna/Distance** : 2021 BBHA 9120D 3#
NEW/3m/HORIZONTAL

Memo : 11G 2412

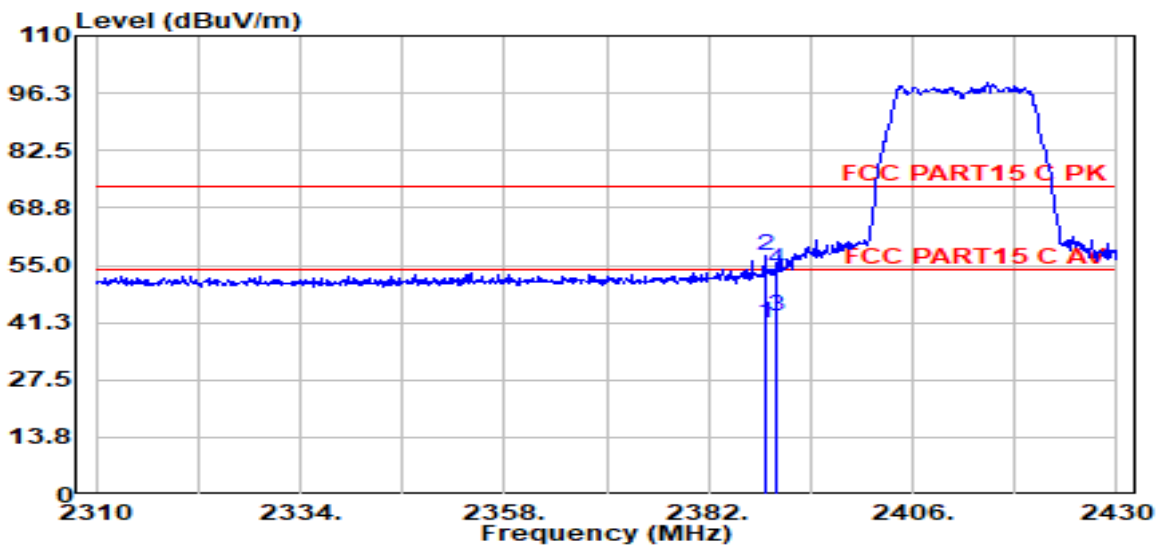

Item (Mark)	Freq. (MHz)	Read Level (dBμV)	Antenna Factor (dB/m)	Cable Loss (dB)	PRM Factor (dB)	Result Level (dBμV/m)	Limit Line (dBμV/m)	Over Limit (dB)	Detector	Polarization
1	2388.60	11.28	27.40	1.71	0.00	41.11	54.00	-12.89	Average	HORIZONTAL
2	2388.60	27.44	27.40	1.71	0.00	57.27	74.00	-16.73	Peak	HORIZONTAL
3	2390.04	12.97	27.40	1.71	0.00	42.80	54.00	-11.20	Average	HORIZONTAL
4	2390.04	23.94	27.40	1.71	0.00	53.78	74.00	-20.22	Peak	HORIZONTAL

Note:

1. Result Level = Read Level + Antenna Factor + Cable loss - PRM Factor.
2. If Peak Result complies with AV limit, AV Result is deemed to comply with AV limit.
3. Test setup: RBW: 1 MHz, VBW: 3 MHz, Sweep time: auto.

TR-4-E-009 Radiated Emission Test Result

Test Site : DDT 3m Chamber 3# D:\2021 report data\Q21120722 -2E D6\FCC ABOVE 1G\FCC ABOVE 1G_00018.EMI
Test Date : 2022-01-25 **Tested By** : Kennys Zhang
EUT : Dash cam **Model Number** : D6
Power Supply : DC 5V **Test Mode** : Tx Mode
Condition : Temp:24.5°,Humi:55%,Press:100.1kPa **Antenna/Distance** : 2021 BBHA 9120D 3#
NEW/3m/VERTICAL
Memo : 11G 2412

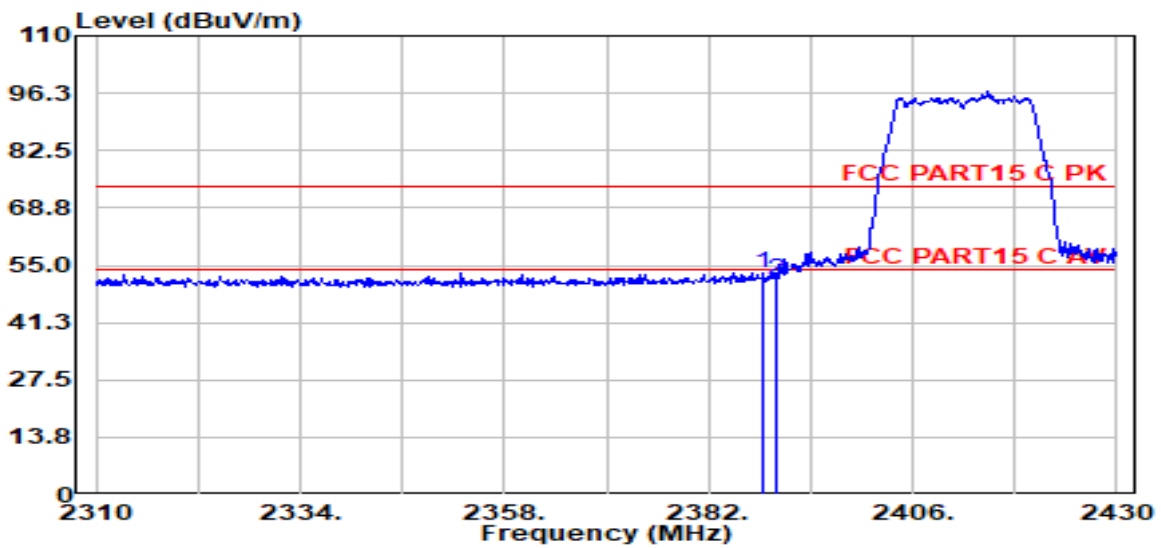

Item (Mark)	Freq. (MHz)	Read Level (dBμV)	Antenna Factor (dB/m)	Cable Loss (dB)	PRM Factor (dB)	Result Level (dBμV/m)	Limit Line (dBμV/m)	Over Limit (dB)	Detector	Polarization
1	2388.48	23.45	27.40	1.71	0.00	53.28	74.00	-20.72	Peak	VERTICAL
2	2390.04	21.75	27.40	1.71	0.00	51.58	74.00	-22.42	Peak	VERTICAL

Note:

1. Result Level = Read Level + Antenna Factor + Cable loss - PRM Factor.
2. If Peak Result complies with AV limit, AV Result is deemed to comply with AV limit.
3. Test setup: RBW: 1 MHz, VBW: 3 MHz, Sweep time: auto.

TR-4-E-009 Radiated Emission Test Result

Test Site : DDT 3m Chamber 3# D:\2021 report data\Q21120722 -2E D6\FCC ABOVE 1G\FCC ABOVE 1G_00019.EMI
Test Date : 2022-01-25 **Tested By** : Kennys Zhang
EUT : Dash cam **Model Number** : D6
Power Supply : DC 5V **Test Mode** : Tx Mode
Condition : Temp:24.5°,Humi:55%,Press:100.1kPa **Antenna/Distance** : 2021 BBHA 9120D 3#
NEW/3m/VERTICAL
Memo : 11G 2462

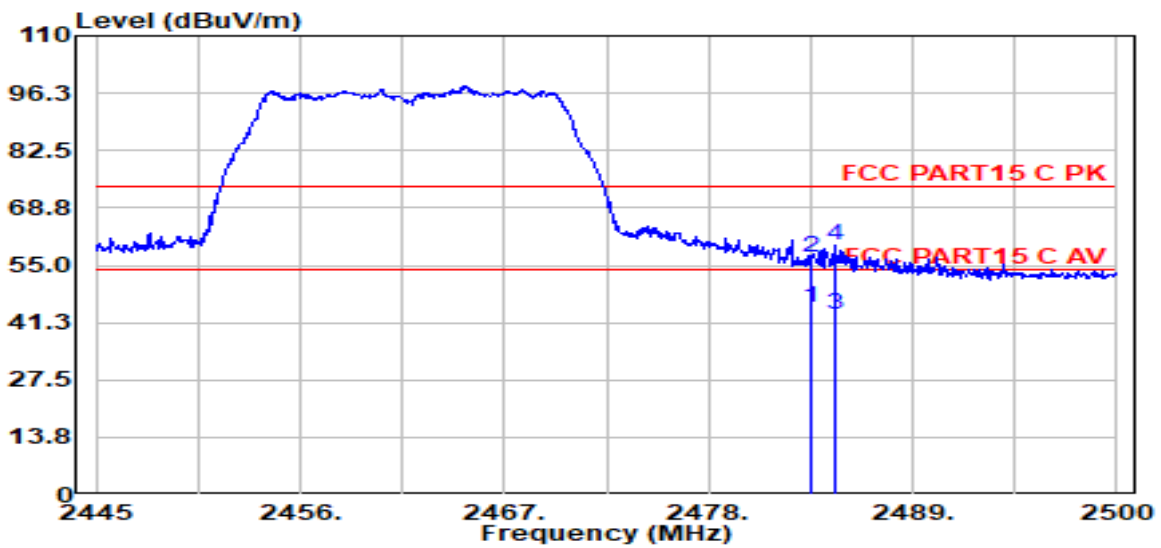

Item (Mark)	Freq. (MHz)	Read Level (dBμV)	Antenna Factor (dB/m)	Cable Loss (dB)	PRM Factor (dB)	Result Level (dBUV/m)	Limit Line (dBUV/m)	Over Limit (dB)	Detector	Polarization
1	2483.50	14.84	27.57	1.74	0.00	44.88	54.00	-9.12	Average	VERTICAL
2	2483.50	26.66	27.57	1.74	0.00	56.70	74.00	-17.30	Peak	VERTICAL
3	2484.77	13.28	27.57	1.74	0.00	43.32	54.00	-10.68	Average	VERTICAL
4	2484.77	29.65	27.57	1.74	0.00	59.70	74.00	-14.30	Peak	VERTICAL

Note:

1. Result Level = Read Level + Antenna Factor + Cable loss - PRM Factor.
2. If Peak Result complies with AV limit, AV Result is deemed to comply with AV limit.
3. Test setup: RBW: 1 MHz, VBW: 3 MHz, Sweep time: auto.

TR-4-E-009 Radiated Emission Test Result

Test Site : DDT 3m Chamber 3#

D:\2021 report data\Q21120722 -2E D6\FCC ABOVE
1G\FCC ABOVE 1G_00020.EMI

Test Date : 2022-01-25

Tested By : Kennys Zhang

EUT : Dash cam

Model Number : D6

Power Supply : DC 5V

Test Mode : Tx Mode

Condition : Temp:24.5°,Humi:55%,Press:100.1kPa **Antenna/Distance** : 2021 BBHA 9120D 3#
NEW/3m/HORIZONTAL

Memo : 11G 2462

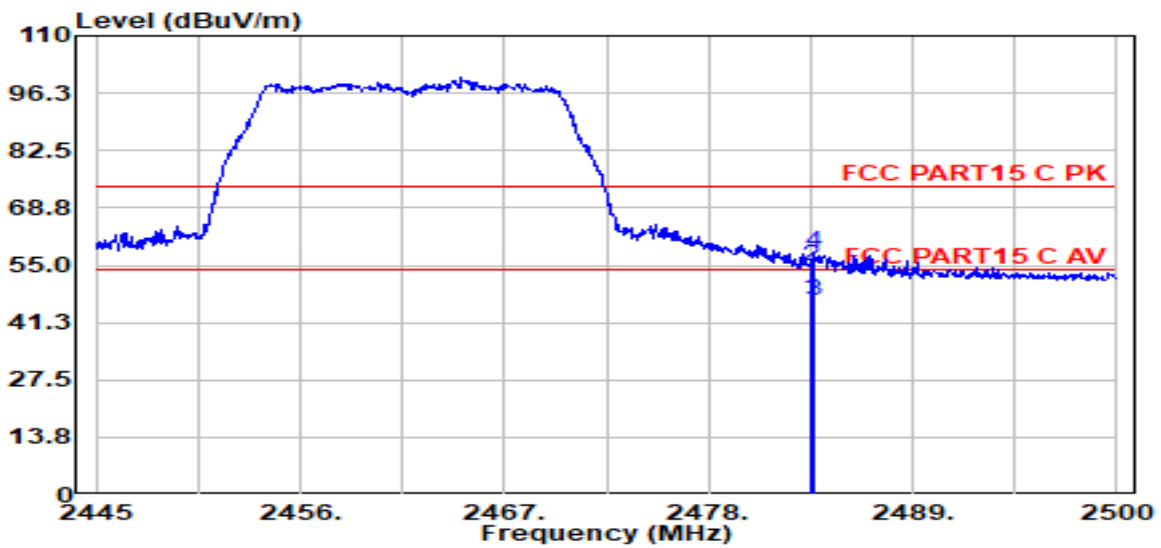

Item (Mark)	Freq. (MHz)	Read Level (dBμV)	Antenna Factor (dB/m)	Cable Loss (dB)	PRM Factor (dB)	Result Level (dBμV/m)	Limit Line (dBμV/m)	Over Limit (dB)	Detector	Polarization
1	2483.50	16.82	27.57	1.74	0.00	46.86	54.00	-7.14	Average	HORIZONTAL
2	2483.50	24.95	27.57	1.74	0.00	54.99	74.00	-19.01	Peak	HORIZONTAL
3	2483.67	16.52	27.57	1.74	0.00	46.56	54.00	-7.44	Average	HORIZONTAL
4	2483.67	28.22	27.57	1.74	0.00	58.26	74.00	-15.74	Peak	HORIZONTAL

Note:

1. Result Level = Read Level + Antenna Factor + Cable loss - PRM Factor.
2. If Peak Result complies with AV limit, AV Result is deemed to comply with AV limit.
3. Test setup: RBW: 1 MHz, VBW: 3 MHz, Sweep time: auto.

TR-4-E-009 Radiated Emission Test Result

Test Site : DDT 3m Chamber 3#

D:\2021 report data\Q21120722 -2E D6\FCC ABOVE
1G\FCC ABOVE 1G_00021.EMI

Test Date : 2022-01-25

Tested By : Kennys Zhang

EUT : Dash cam

Model Number : D6

Power Supply : DC 5V

Test Mode : Tx Mode

Condition : Temp:24.5°,Humi:55%,Press:100.1kPa **Antenna/Distance** : 2021 BBHA 9120D 3#
NEW/3m/HORIZONTAL

Memo : 11N20 2412

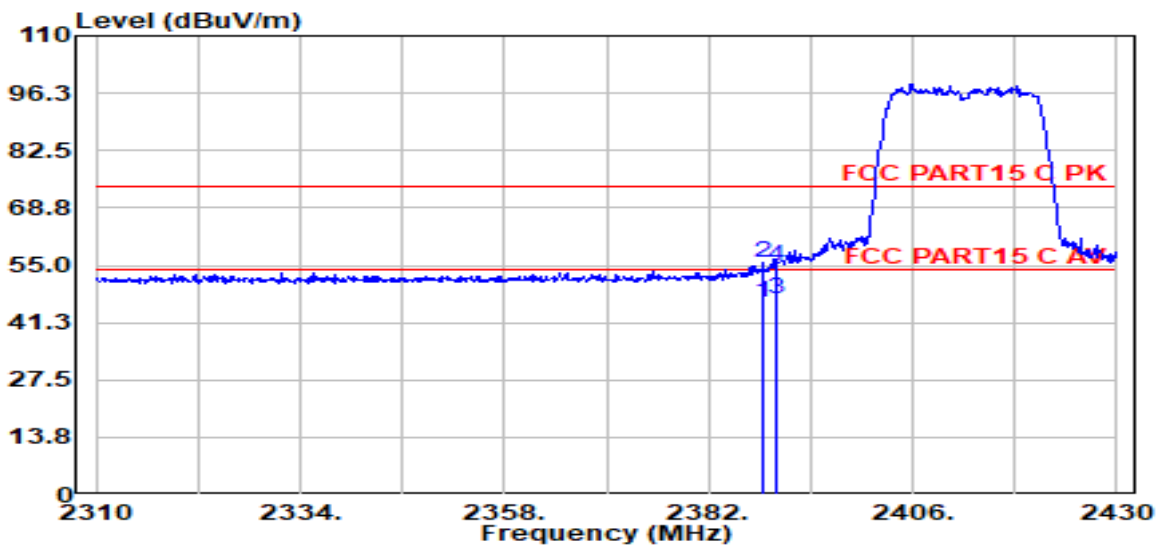

Item (Mark)	Freq. (MHz)	Read Level (dBμV)	Antenna Factor (dB/m)	Cable Loss (dB)	PRM Factor (dB)	Result Level (dBμV/m)	Limit Line (dBμV/m)	Over Limit (dB)	Detector	Polarization
1	2388.36	16.28	27.40	1.71	0.00	46.11	54.00	-7.89	Average	HORIZONTAL
2	2388.36	25.64	27.40	1.71	0.00	55.47	74.00	-18.53	Peak	HORIZONTAL
3	2390.04	17.20	27.40	1.71	0.00	47.03	54.00	-6.97	Average	HORIZONTAL
4	2390.04	24.82	27.40	1.71	0.00	54.65	74.00	-19.35	Peak	HORIZONTAL

Note:

1. Result Level = Read Level + Antenna Factor + Cable loss - PRM Factor.
2. If Peak Result complies with AV limit, AV Result is deemed to comply with AV limit.
3. Test setup: RBW: 1 MHz, VBW: 3 MHz, Sweep time: auto.

TR-4-E-009 Radiated Emission Test Result

Test Site : DDT 3m Chamber 3# D:\2021 report data\Q21120722 -2E D6\FCC ABOVE 1G\FCC ABOVE 1G_00022.EMI
Test Date : 2022-01-25 **Tested By** : Kennys Zhang
EUT : Dash cam **Model Number** : D6
Power Supply : DC 5V **Test Mode** : Tx Mode
Condition : Temp:24.5°,Humi:55%,Press:100.1kPa **Antenna/Distance** : 2021 BBHA 9120D 3#
NEW/3m/VERTICAL
Memo : 11N20 2412

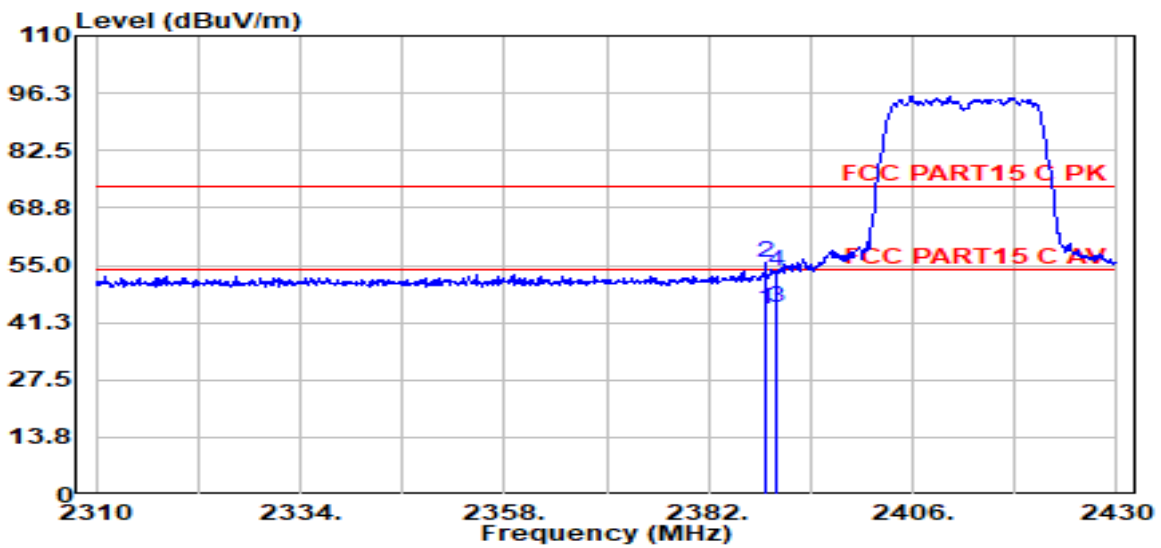

Item (Mark)	Freq. (MHz)	Read Level (dBμV)	Antenna Factor (dB/m)	Cable Loss (dB)	PRM Factor (dB)	Result Level (dBμV/m)	Limit Line (dBμV/m)	Over Limit (dB)	Detector	Polarization
1	2388.72	14.74	27.40	1.71	0.00	44.57	54.00	-9.43	Average	VERTICAL
2	2388.72	25.71	27.40	1.71	0.00	55.54	74.00	-18.46	Peak	VERTICAL
3	2390.04	15.10	27.40	1.71	0.00	44.93	54.00	-9.07	Average	VERTICAL
4	2390.04	23.77	27.40	1.71	0.00	53.60	74.00	-20.40	Peak	VERTICAL

Note:

1. Result Level = Read Level + Antenna Factor + Cable loss - PRM Factor.
2. If Peak Result complies with AV limit, AV Result is deemed to comply with AV limit.
3. Test setup: RBW: 1 MHz, VBW: 3 MHz, Sweep time: auto.

TR-4-E-009 Radiated Emission Test Result

Test Site : DDT 3m Chamber 3#

D:\2021 report data\Q21120722 -2E D6\FCC ABOVE
1G\FCC ABOVE 1G_00023.EMI

Test Date : 2022-01-25

Tested By : Kennys Zhang

EUT : Dash cam

Model Number : D6

Power Supply : DC 5V

Test Mode : Tx Mode

Condition : Temp:24.5°,Humi:55%,Press:100.1kPa **Antenna/Distance** : 2021 BBHA 9120D 3#
NEW/3m/VERTICAL

Memo : 11N20 2462

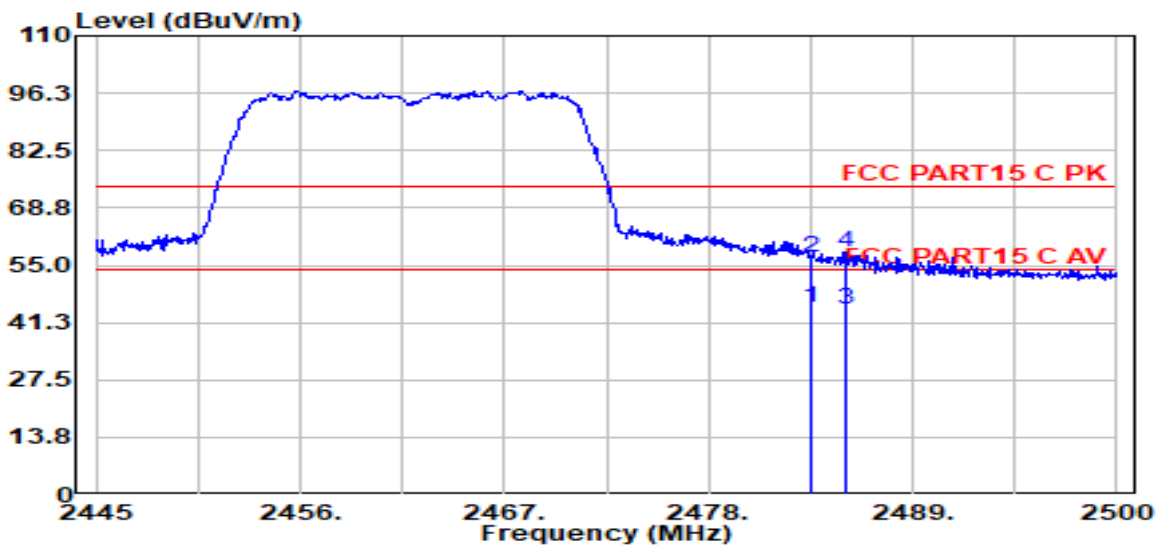

Item (Mark)	Freq. (MHz)	Read Level (dBμV)	Antenna Factor (dB/m)	Cable Loss (dB)	PRM Factor (dB)	Result Level (dBUV/m)	Limit Line (dBUV/m)	Over Limit (dB)	Detector	Polarization
1	2483.50	14.87	27.57	1.74	0.00	44.91	54.00	-9.09	Average	VERTICAL
2	2483.50	26.94	27.57	1.74	0.00	56.98	74.00	-17.02	Peak	VERTICAL
3	2485.37	14.21	27.57	1.74	0.00	44.25	54.00	-9.75	Average	VERTICAL
4	2485.37	28.25	27.57	1.74	0.00	58.29	74.00	-15.71	Peak	VERTICAL

Note:

1. Result Level = Read Level + Antenna Factor + Cable loss - PRM Factor.
2. If Peak Result complies with AV limit, AV Result is deemed to comply with AV limit.
3. Test setup: RBW: 1 MHz, VBW: 3 MHz, Sweep time: auto.

TR-4-E-009 Radiated Emission Test Result

Test Site : DDT 3m Chamber 3#

D:\2021 report data\Q21120722 -2E D6\FCC ABOVE
1G\FCC ABOVE 1G_00024.EMI

Test Date : 2022-01-25

Tested By : Kennys Zhang

EUT : Dash cam

Model Number : D6

Power Supply : DC 5V

Test Mode : Tx Mode

Condition : Temp:24.5°,Humi:55%,Press:100.1kPa **Antenna/Distance** : 2021 BBHA 9120D 3#
NEW/3m/HORIZONTAL

Memo : 11N20 2462

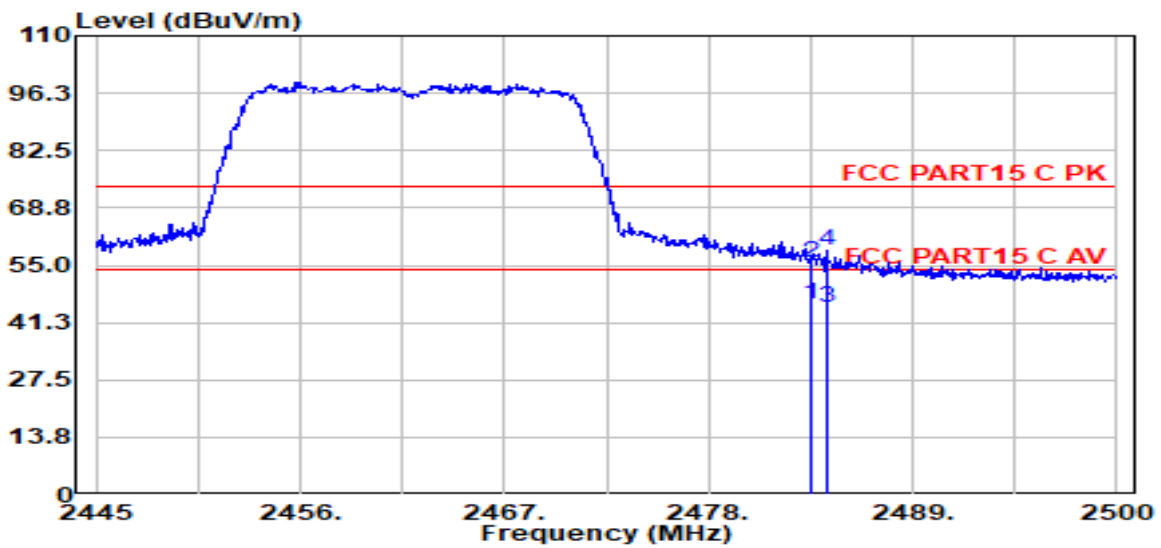

Item (Mark)	Freq. (MHz)	Read Level (dBμV)	Antenna Factor (dB/m)	Cable Loss (dB)	PRM Factor (dB)	Result Level (dBμV/m)	Limit Line (dBμV/m)	Over Limit (dB)	Detector	Polarization
1	2483.50	15.69	27.57	1.74	0.00	45.73	54.00	-8.27	Average	HORIZONTAL
2	2483.50	25.56	27.57	1.74	0.00	55.60	74.00	-18.40	Peak	HORIZONTAL
3	2484.33	14.88	27.57	1.74	0.00	44.92	54.00	-9.08	Average	HORIZONTAL
4	2484.33	28.41	27.57	1.74	0.00	58.45	74.00	-15.55	Peak	HORIZONTAL

Note:

1. Result Level = Read Level + Antenna Factor + Cable loss - PRM Factor.
2. If Peak Result complies with AV limit, AV Result is deemed to comply with AV limit.
3. Test setup: RBW: 1 MHz, VBW: 3 MHz, Sweep time: auto.

TR-4-E-009 Radiated Emission Test Result

Test Site : DDT 3m Chamber 3# D:\2021 report data\Q21120722 -2E D6\FCC ABOVE 1G\FCC ABOVE 1G_00025.EMI
Test Date : 2022-01-25 **Tested By** : Kennys Zhang
EUT : Dash cam **Model Number** : D6
Power Supply : DC 5V **Test Mode** : Tx Mode
Condition : Temp:24.5°,Humi:55%,Press:100.1kPa **Antenna/Distance** : 2021 BBHA 9120D 3#
NEW/3m/HORIZONTAL
Memo : 11N40 2422

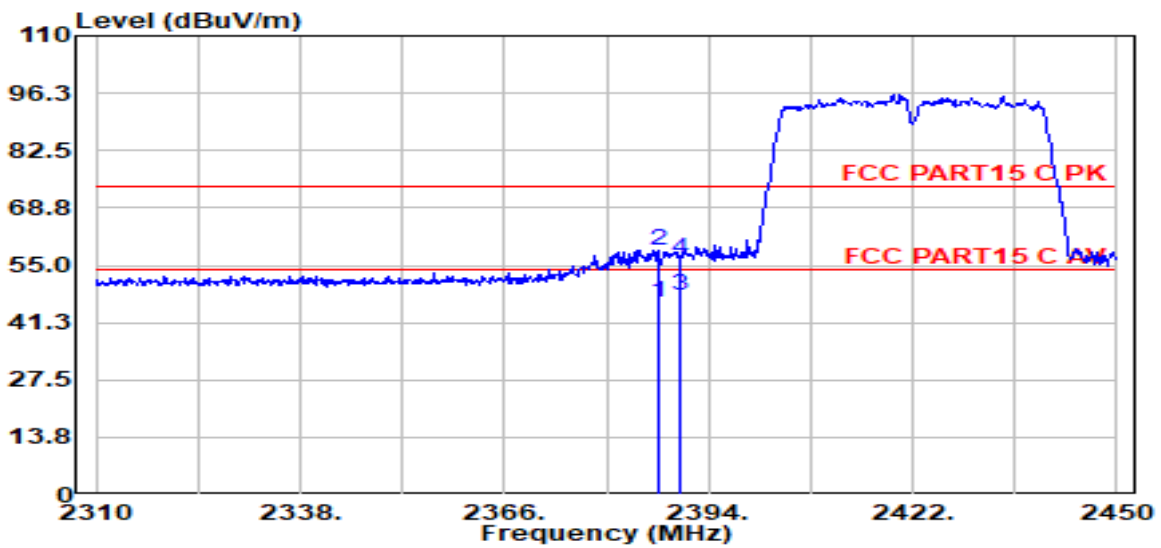

Item (Mark)	Freq. (MHz)	Read Level (dBμV)	Antenna Factor (dB/m)	Cable Loss (dB)	PRM Factor (dB)	Result Level (dBμV/m)	Limit Line (dBμV/m)	Over Limit (dB)	Detector	Polarization
1	2387.28	16.20	27.40	1.71	0.00	46.03	54.00	-7.97	Average	HORIZONTAL
2	2387.28	28.87	27.40	1.71	0.00	58.70	74.00	-15.30	Peak	HORIZONTAL
3	2389.94	17.74	27.40	1.71	0.00	47.57	54.00	-6.43	Average	HORIZONTAL
4	2389.94	26.49	27.40	1.71	0.00	56.33	74.00	-17.67	Peak	HORIZONTAL

Note:

1. Result Level = Read Level + Antenna Factor + Cable loss - PRM Factor.
2. If Peak Result complies with AV limit, AV Result is deemed to comply with AV limit.
3. Test setup: RBW: 1 MHz, VBW: 3 MHz, Sweep time: auto.

TR-4-E-009 Radiated Emission Test Result

Test Site : DDT 3m Chamber 3#

D:\2021 report data\Q21120722 -2E D6\FCC ABOVE
1G\FCC ABOVE 1G_00026.EMI

Test Date : 2022-01-25

Tested By : Kennys Zhang

EUT : Dash cam

Model Number : D6

Power Supply : DC 5V

Test Mode : Tx Mode

Condition : Temp:24.5°,Humi:55%,Press:100.1kPa **Antenna/Distance** : 2021 BBHA 9120D 3#
NEW/3m/VERTICAL

Memo : 11N40 2422

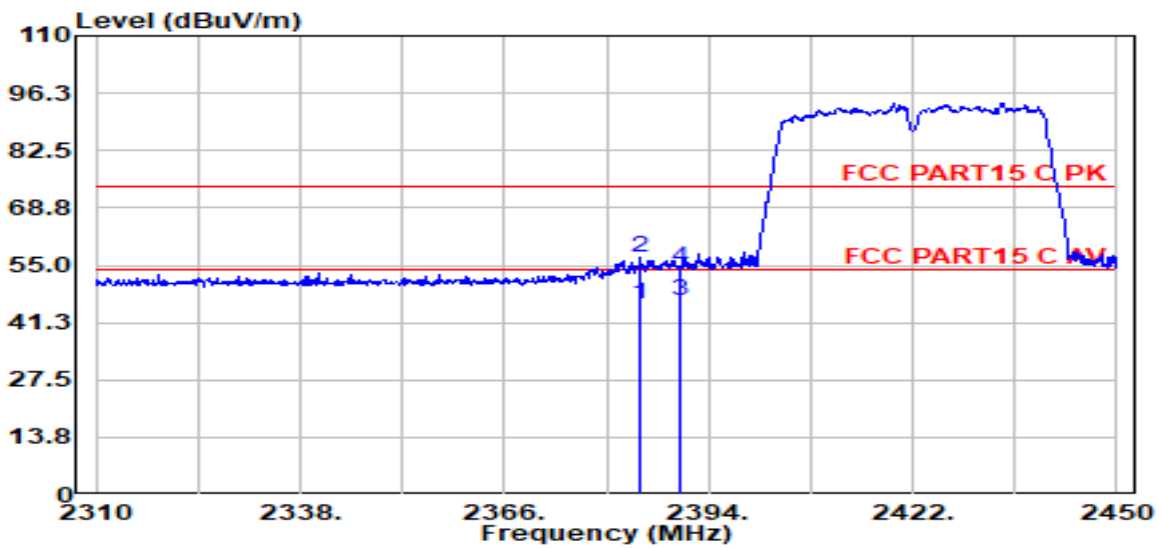

Item (Mark)	Freq. (MHz)	Read Level (dBμV)	Antenna Factor (dB/m)	Cable Loss (dB)	PRM Factor (dB)	Result Level (dBμV/m)	Limit Line (dBμV/m)	Over Limit (dB)	Detector	Polarization
1	2384.62	15.88	27.39	1.71	0.00	45.70	54.00	-8.30	Average	VERTICAL
2	2384.62	26.86	27.39	1.71	0.00	56.68	74.00	-17.32	Peak	VERTICAL
3	2389.94	16.78	27.40	1.71	0.00	46.61	54.00	-7.39	Average	VERTICAL
4	2389.94	24.42	27.40	1.71	0.00	54.25	74.00	-19.75	Peak	VERTICAL

Note:

1. Result Level = Read Level + Antenna Factor + Cable loss - PRM Factor.
2. If Peak Result complies with AV limit, AV Result is deemed to comply with AV limit.
3. Test setup: RBW: 1 MHz, VBW: 3 MHz, Sweep time: auto.

TR-4-E-009 Radiated Emission Test Result

Test Site : DDT 3m Chamber 3#

D:\2021 report data\Q21120722 -2E D6\FCC ABOVE
1G\FCC ABOVE 1G_00027.EMI

Test Date : 2022-01-25

Tested By : Kennys Zhang

EUT : Dash cam

Model Number : D6

Power Supply : DC 5V

Test Mode : Tx Mode

Condition : Temp:24.5°,Humi:55%,Press:100.1kPa **Antenna/Distance** : 2021 BBHA 9120D 3#
NEW/3m/VERTICAL

Memo : 11N40 2452

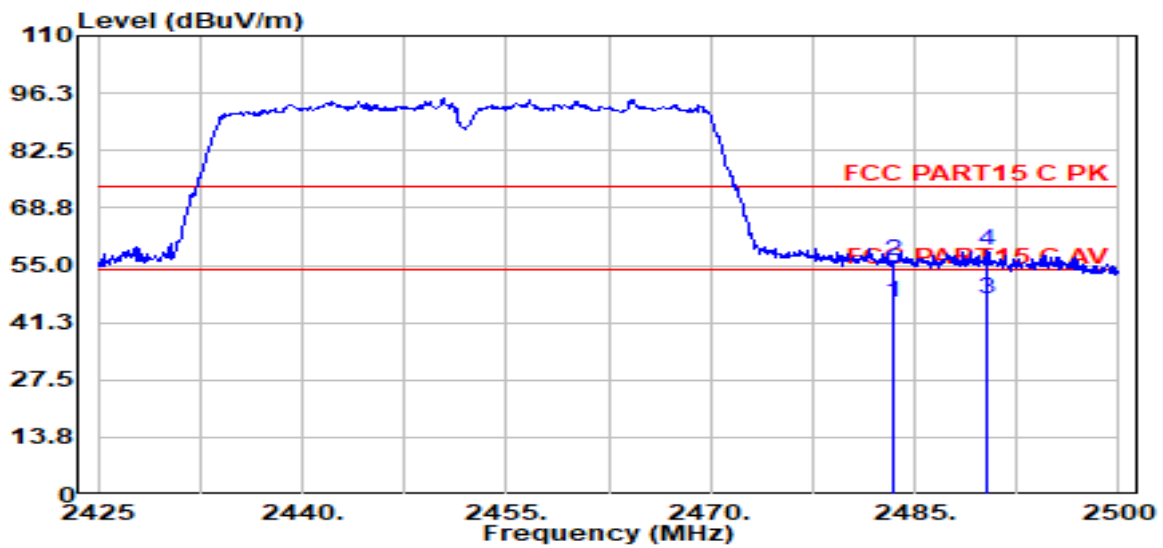

Item (Mark)	Freq. (MHz)	Read Level (dBμV)	Antenna Factor (dB/m)	Cable Loss (dB)	PRM Factor (dB)	Result Level (dBμV/m)	Limit Line (dBμV/m)	Over Limit (dB)	Detector	Polarization
1	2483.50	16.18	27.57	1.74	0.00	46.22	54.00	-7.78	Average	VERTICAL
2	2483.50	26.06	27.57	1.74	0.00	56.10	74.00	-17.90	Peak	VERTICAL
3	2490.33	16.87	27.58	1.74	0.00	46.92	54.00	-7.08	Average	VERTICAL
4	2490.33	28.42	27.58	1.74	0.00	58.47	74.00	-15.53	Peak	VERTICAL

Note:

1. Result Level = Read Level + Antenna Factor + Cable loss - PRM Factor.
2. If Peak Result complies with AV limit, AV Result is deemed to comply with AV limit.
3. Test setup: RBW: 1 MHz, VBW: 3 MHz, Sweep time: auto.

TR-4-E-009 Radiated Emission Test Result

Test Site : DDT 3m Chamber 3# D:\2021 report data\Q21120722 -2E D6\FCC ABOVE 1G\FCC ABOVE 1G_00028.EMI
Test Date : 2022-01-25 **Tested By** : Kennys Zhang
EUT : Dash cam **Model Number** : D6
Power Supply : DC 5V **Test Mode** : Tx Mode
Condition : Temp:24.5°,Humi:55%,Press:100.1kPa **Antenna/Distance** : 2021 BBHA 9120D 3#
NEW/3m/HORIZONTAL
Memo : 11N40 2452

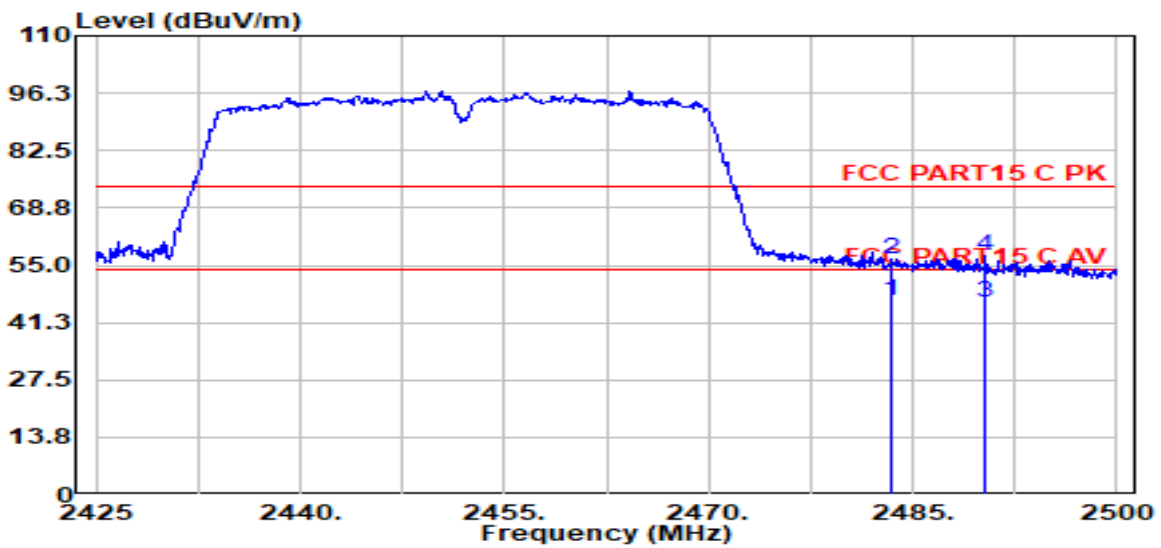

Item (Mark)	Freq. (MHz)	Read Level (dBμV)	Antenna Factor (dB/m)	Cable Loss (dB)	PRM Factor (dB)	Result Level (dBμV/m)	Limit Line (dBμV/m)	Over Limit (dB)	Detector	Polarization
1	2483.50	16.58	27.57	1.74	0.00	46.62	54.00	-7.38	Average	HORIZONTAL
2	2483.50	26.28	27.57	1.74	0.00	56.32	74.00	-17.68	Peak	HORIZONTAL
3	2490.33	16.22	27.58	1.74	0.00	46.27	54.00	-7.73	Average	HORIZONTAL
4	2490.33	27.15	27.58	1.74	0.00	57.21	74.00	-16.79	Peak	HORIZONTAL

Note:

1. Result Level = Read Level + Antenna Factor + Cable loss - PRM Factor.
2. If Peak Result complies with AV limit, AV Result is deemed to comply with AV limit.
3. Test setup: RBW: 1 MHz, VBW: 3 MHz, Sweep time: auto.

10. Power Line Conducted Emission

10.1. Block diagram of test setup

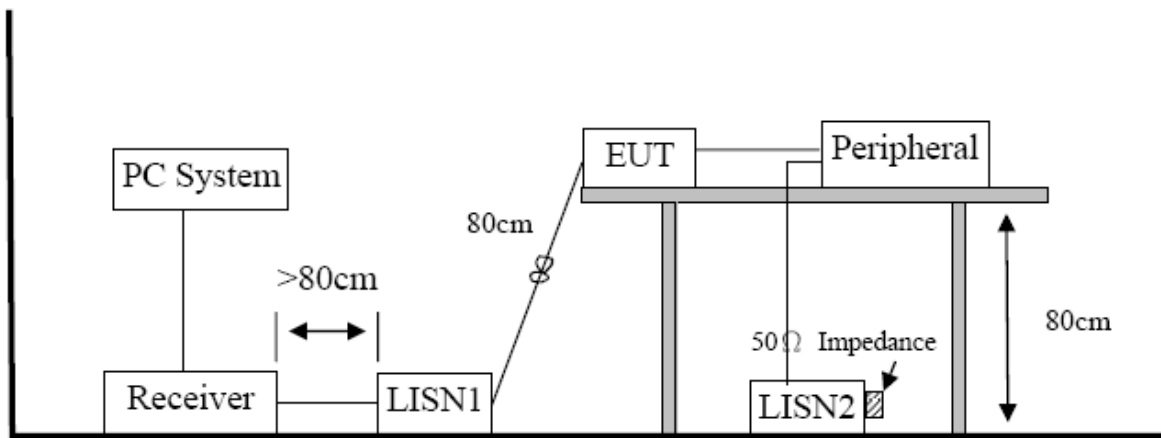

10.2. Power line conducted emission limits (Class B)

Frequency	Quasi-Peak Level dB(μ V)	Average Level dB(μ V)
150 kHz ~ 500 kHz	66 ~ 56*	56 ~ 46*
500 kHz ~ 5 MHz	56	46
5 MHz ~ 30 MHz	60	50

Note 1: * Decreasing linearly with logarithm of frequency.

Note 2: The lower limit shall apply at the transition frequencies.

10.3. Test procedure

The EUT and Support equipment, if needed, were put placed on a non-metallic table, 80cm above the ground plane.

All I/O cables were positioned to simulate typical actual usage as per ANSI C63.4.

All support equipment power received from a second LISN.

Emissions were measured on each current carrying line of the EUT using an EMI Test Receiver connected to the LISN powering the EUT.

The Receiver scanned from 150 kHz to 30 MHz for emissions in each of the test modes.

During the above scans, the emissions were maximized by cable manipulation.

After the preliminary scan, we found the test mode producing the highest emission level.

The EUT configuration and worse cable configuration of the above highest emission levels were recorded for reference of the final test.

EUT and support equipment were set up on the test bench as per the configuration with highest emission level in the preliminary test.

A scan was taken on both power lines, Neutral and Line, recording at least the six highest emissions.

Emission frequency and amplitude were recorded into a computer in which correction factors were used to calculate the emission level and compare reading to the applicable limit.

The test data of the worst-case condition(s) was recorded.

The bandwidth of test receiver is set at 9 kHz.

10.4. Test result

Not Applicable, since the EUT is not AC-operated device.

11. Antenna Requirements

11.1. Limit

For intentional device, according to FCC 47 CFR Section 15.203, an intentional radiator shall be designed to ensure that no antenna other than that furnished by the responsible party shall be used with the device. And according to FCC 47 CFR Section 15.247 (b), if transmitting antennas of directional gain greater than 6 dBi are used, the power shall be reduced by the amount in dB that the directional gain of the antenna exceeds 6 dBi.

11.2. Result

The antenna used for this product and that no antenna other than that furnished by the responsible party shall be used with the device, the maximum peak gain is 0.48 dBi.