

FCC TEST REPORT

For

Shenzhen CYX Industrial Co.,Ltd.

Laptop

Test Model: ACL1

Additional Model No.: Please Refer to Page 6

Prepared for : Shenzhen CYX Industrial Co.,Ltd.
Address : Building A, Corrent Low Carbon Industrial Zone, Huarong Road, Dalang Street, Longhua District, ShenZhen, China

Prepared by : Shenzhen LCS Compliance Testing Laboratory Ltd.
Address : 101, 201 Bldg A & 301 Bldg C, Juji Industrial Park Yabianxueziwei, Shajing Street, Baoan District, Shenzhen, 518000, China

Tel : (+86)755-82591330
Fax : (+86)755-82591332
Web : www.LCS-cert.com
Mail : webmaster@LCS-cert.com

Date of receipt of test sample : May 17, 2021
Number of tested samples : 2
Serial number : Prototype
Date of Test : May 17, 2021 ~ June 02, 2021
Date of Report : June 09, 2021

**FCC TEST REPORT
FCC CFR 47 PART 15 E (15.407)**

Report Reference No. : **LCS210513034AEF**

Date of Issue..... : June 09, 2021

Testing Laboratory Name : **Shenzhen LCS Compliance Testing Laboratory Ltd.**

Address..... : 101, 201 Bldg A & 301 Bldg C, Juji Industrial Park Yabianxueziwei,
Shajing Street, Baoan District, Shenzhen, 518000, China

Full application of Harmonised standards

Testing Location/ Procedure..... : Partial application of Harmonised standards

Other standard testing method

Applicant's Name..... : **Shenzhen CYX Industrial Co.,Ltd.**

Address..... : Building A, Corrent Low Carbon Industrial Zone, Huarong Road,
Dalang Street, Longhua District, ShenZhen, China

Test Specification

Standard : FCC CFR 47 PART 15E (15.407)

Test Report Form No...... : LCSEMC-1.0

TRF Originator : Shenzhen LCS Compliance Testing Laboratory Ltd.

Master TRF : Dated 2011-03

Shenzhen LCS Compliance Testing Laboratory Ltd. All rights reserved.

This publication may be reproduced in whole or in part for non-commercial purposes as long as the Shenzhen LCS Compliance Testing Laboratory Ltd. is acknowledged as copyright owner and source of the material. Shenzhen LCS Compliance Testing Laboratory Ltd. takes no responsibility for and will not assume liability for damages resulting from the reader's interpretation of the reproduced material due to its placement and context.

EUT Description..... : **Laptop**

Trade Mark..... : N/A

Test Model : ACL1

Ratings..... : Input: DC 12V, 2500mA
DC 7.6V by Rechargeable Li-ion Battery, 5000mAh

Result : **Positive**

Compiled by:



Linda He/ Administrator

Supervised by:



Jin Wang/ Technique principal

Approved by:

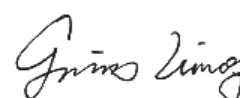

Gavin Liang/ Manager

FCC -- TEST REPORT

| | |
|---|---------------------------------------|
| Test Report No. : LCS210513034AEF | <u>June 09, 2021</u> Date of issue |
|---|---------------------------------------|

| | |
|--------------------------|---|
| EUT..... | : Laptop |
| Test Model..... | : ACL1 |
| Applicant..... | : Shenzhen CYX Industrial Co.,Ltd. |
| Address..... | : Building A, Corrent Low Carbon Industrial Zone, Huarong Road, Dalang Street, Longhua District, ShenZhen, China |
| Telephone..... | : / |
| Fax..... | : / |
| Manufacturer..... | : Shenzhen CYX Industrial Co.,Ltd. |
| Address..... | : Building A, Corrent Low Carbon Industrial Zone, Huarong Road, Dalang Street, Longhua District, ShenZhen, China |
| Telephone..... | : / |
| Fax..... | : / |
| Factory..... | : Shenzhen CYX Industrial Co.,Ltd. |
| Address..... | : Building A, Corrent Low Carbon Industrial Zone, Huarong Road, Dalang Street, Longhua District, ShenZhen, China |
| Telephone..... | : / |
| Fax..... | : / |

| | |
|---------------------|-----------------|
| Test Result: | Positive |
|---------------------|-----------------|

The test report merely corresponds to the test sample.
 It is not permitted to copy extracts of these test result without the written permission of the test laboratory.

Revision History

| Revision | Issue Date | Revisions | Revised By |
|----------|---------------|---------------|-------------|
| 000 | June 09, 2021 | Initial Issue | Gavin Liang |
| | | | |
| | | | |

TABLE OF CONTENTS

| | |
|--|-----------|
| 1. GENERAL INFORMATION..... | 6 |
| 1.1. DESCRIPTION OF DEVICE (EUT) | 6 |
| 1.2. HOST SYSTEM CONFIGURATION LIST AND DETAILS | 8 |
| 1.3. EXTERNAL I/O CABLE | 8 |
| 1.4. DESCRIPTION OF TEST FACILITY | 8 |
| 1.5. STATEMENT OF THE MEASUREMENT UNCERTAINTY | 8 |
| 1.6. MEASUREMENT UNCERTAINTY | 8 |
| 1.7. DESCRIPTION OF TEST MODES | 9 |
| 1.8. CHANNEL LIST AND FREQUENCY | 9 |
| 2. TEST METHODOLOGY | 10 |
| 3. SYSTEM TEST CONFIGURATION..... | 10 |
| 3.1. EUT EXERCISE SOFTWARE..... | 10 |
| 3.2. SPECIAL ACCESSORIES | 10 |
| 3.3. BLOCK DIAGRAM/SCHEMATICS..... | 10 |
| 3.4. EQUIPMENT MODIFICATIONS | 10 |
| 3.5. TEST SETUP..... | 10 |
| 3.6. PROCEDURE..... | 10 |
| 4. SUMMARY OF TEST RESULTS..... | 12 |
| 5. DESCRIPTION OF DYNAMIC FREQUENCY SELECTION TEST..... | 13 |
| 5.1. REQUIREMENTS | 13 |
| 5.2. LIMIT | 13 |
| 6. DFS DETECTION THRESHOLD VALUES..... | 14 |
| 7. DFS TEST SIGNALS | 15 |
| 8. TEST RESULT | 18 |
| 9. LIST OF MEASURING EQUIPMENTS | 73 |
| 10. TEST SETUP PHOTOGRAPHS OF EUT | 74 |
| 11. EXTERIOR PHOTOGRAPHS OF THE EUT..... | 74 |
| 12. INTERIOR PHOTOGRAPHS OF THE EUT..... | 74 |

1. GENERAL INFORMATION

1.1. Description of Device (EUT)

| | |
|----------------------|--|
| EUT | : Laptop |
| Test Model | : ACL1 |
| Additional Model No. | : ACL2, ACL3, ACL4, ACL5, ACL6, ACL7, ACL8, ACL9, ACL10, ANL1, ANL2, ANL3, ANL4, ANL5, ANL6, ANL7, ANL8, ANL9, ANL10 |
| Model Declaration | : PCB board, structure and internal of these model(s) are the same, So no additional models were tested |
| Power Supply | : Input: DC 12V, 2500mA DC 7.6V by Rechargeable Li-ion Battery, 5000mAh |
| Hardware Version | : G142F1 RVE01 |
| Software Version | : Windows 10 Pro2004 |
| Bluetooth | : |
| Frequency Range | : 2402MHz ~ 2480MHz |
| Channel Number | : 79 channels for Bluetooth V4.2 (BDR/EDR) 40 channels for Bluetooth V4.2 (BT LE) |
| Channel Spacing | : 1MHz for Bluetooth V4.2 (BDR/EDR) 2MHz for Bluetooth V4.2 (BT LE) |
| Modulation Type | : GFSK, $\pi/4$ -DQPSK, 8-DPSK for Bluetooth V4.2 (BDR/EDR) GFSK for Bluetooth V4.2 (BT LE) |
| Bluetooth Version | : V4.2 |
| Antenna Description | : FPC Antenna, 1.8dBi(Max.) |
| 2.4G WLAN | : |
| Frequency Range | : 2412MHz ~ 2462 MHz |
| Channel Spacing | : 5MHz |
| Channel Number | : 11 Channels for 20MHz bandwidth (2412~2462MHz) 7 Channels for 40MHz bandwidth (2422~2452MHz) |
| Modulation Type | : IEEE 802.11b: DSSS (CCK, DQPSK, DBPSK) IEEE 802.11g: OFDM (64QAM, 16QAM, QPSK, BPSK) IEEE 802.11n: OFDM (64QAM, 16QAM, QPSK, BPSK) |
| Antenna Description | : ANT0: FPC Antenna, 1.8dBi(Max.) ANT1: FPC Antenna, 1.8dBi(Max.) |
| 5G WLAN | : |
| Frequency Range | : 5180-5240MHz, 5260-5320MHz, 5500-5700MHz |
| Channel Number | : 4 Channels for 20MHz bandwidth(5180MHz-5240MHz) 4 Channels for 20MHz bandwidth(5260MHz-5320MHz) 11 Channels for 20MHz bandwidth(5500MHz-5700MHz) 2 channels for 40MHz bandwidth(5190MHz~5230MHz) 2 channels for 40MHz bandwidth(5270MHz~5310MHz) 5 Channels for 40MHz bandwidth(5510MHz-5670MHz) 1 channels for 80MHz bandwidth(5210MHz) 1 channels for 80MHz bandwidth(5290MHz) 2 Channels for 80MHz bandwidth(5530MHz-5610MHz) |
| Modulation Type | : IEEE 802.11a/n/ac: OFDM (256QAM, 64QAM, 16QAM, QPSK BPSK) |

Antenna Description : ANT0: FPC Antenna, 1.8dBi(Max.)
ANT1: FPC Antenna, 1.8dBi(Max.)

5.8G WLAN :

Frequency Range : 5745-5825MHz

Channel Number : 5 channels for 20MHz bandwidth(5745-5825MHz)
2 channels for 40MHz bandwidth(5755~5795MHz)
1 channels for 80MHz bandwidth(5775MHz)

Modulation Type : IEEE 802.11a/n/ac: OFDM (256QAM, 64QAM, 16QAM, QPSK, BPSK)

Antenna Description : ANT0: FPC Antenna, 1.8dBi(Max.)
ANT1: FPC Antenna, 1.8dBi(Max.)

1.2. Host System Configuration List and Details

| Manufacturer | Description | Model | Serial Number | Certificate |
|----------------------------------|-------------|-----------------|---------------|-------------|
| SHENZHEN TEKA TECHNOLOGY CO.,LTD | AC ADAPTER | TEKA-TE120250US | --- | SDOC |

1.3. External I/O Cable

| I/O Port Description | Quantity | Cable |
|----------------------|----------|-------|
| Type-C USB Port | 1 | N/A |
| HDMI Port | 1 | N/A |
| Power Port | 1 | N/A |
| USB Port | 2 | N/A |
| Headset Port | 1 | N/A |
| TF Card Port | 1 | N/A |

1.4. Description of Test Facility

NVLAP Accreditation Code is 600167-0.

FCC Designation Number is CN5024.

CAB identifier is CN0071.

CNAS Registration Number is L4595.

The 3m-Semi anechoic test site fulfils CISPR 16-1-4 according to ANSI C63.4:2014 and CISPR 16-1-4:2010 SVSWR requirement for radiated emission above 1GHz.

1.5. Statement of the Measurement Uncertainty

The data and results referenced in this document are true and accurate. The reader is cautioned that there may be errors within the calibration limits of the equipment and facilities. The measurement uncertainty was calculated for all measurements listed in this test report acc. To CISPR 16 – 4 “Specification for radio disturbance and immunity measuring apparatus and methods – Part 4: Uncertainty in EMC Measurements” and is documented in the LCS quality system acc. To DIN EN ISO/IEC 17025. Furthermore, component and process variability of devices similar to that tested may result in additional deviation. The manufacturer has the sole responsibility of continued compliance of the device.

1.6. Measurement Uncertainty

| No. | Item | Uncertainty |
|-----|---------------------------|-------------|
| 1 | DFS Threshold (radiated) | ±1.50dB |
| 2 | DFS Threshold (conducted) | ±1.45dB |
| 3 | Temperature | ±0.5°C |
| 4 | Humidity | ±2% |

(1). This uncertainty represents an expanded uncertainty expressed at approximately the 95% confidence level using a coverage factor of k=2.

1.7. Description of Test Modes

The EUT has been tested under operating condition.

Worst-Case data rates were utilized from preliminary testing of the Chipset, worst-case data rates used during the testing are as follows:

IEEE 802.11a Mode: 6 Mbps, OFDM.

IEEE 802.11ac VHT20 Mode: MCS0

IEEE 802.11n HT20 Mode: MCS0, OFDM.

IEEE 802.11ac VHT40 Mode: MCS0, OFDM.

IEEE 802.11n HT40 Mode: MCS0, OFDM.

IEEE 802.11ac VHT80 Mode: MCS0, OFDM.

1.8. Channel List and Frequency

U-NI-1

| Frequency Band | Channel No. | Frequency (MHz) | Channel No. | Frequency (MHz) |
|--|-------------|-----------------|-------------|-----------------|
| 5180~5240MHz | 36 | 5180 | 44 | 5220 |
| | 38 | 5190 | 46 | 5230 |
| | 40 | 5200 | 48 | 5240 |
| | 42 | 5210 | / | / |
| For IEEE 802.11a/n HT20/ac VHT20, Channel 36, 40 and 48 were tested. | | | | |

U-NI-2A

| Frequency Band | Channel No. | Frequency (MHz) | Channel No. | Frequency (MHz) |
|--|-------------|-----------------|-------------|-----------------|
| 5260~5320MHz | 52 | 5260 | 60 | 5300 |
| | 54 | 5270 | 62 | 5310 |
| | 56 | 5280 | 64 | 5320 |
| | 58 | 5290 | / | / |
| For IEEE 802.11a/n HT20/ac VHT20, Channel 52, 56 and 64 were tested. | | | | |

U-NI-2C

| Frequency Band | Channel No. | Frequency (MHz) | Channel No. | Frequency (MHz) |
|---|-------------|-----------------|-------------|-----------------|
| 5500~5700MHz | 100 | 5500 | 118 | 5590 |
| | 102 | 5510 | 120 | 5600 |
| | 104 | 5520 | 122 | 5610 |
| | 106 | 5530 | 124 | 5620 |
| | 108 | 5540 | 126 | 5630 |
| | 110 | 5550 | 128 | 5640 |
| | 112 | 5560 | 132 | 5660 |
| | 114 | 5570 | 134 | 5670 |
| | 116 | 5580 | 136 | 5680 |
| | -- | -- | 140 | 5700 |
| For IEEE 802.11a/n HT20/ac VHT20, Channel 100, 120 and 140 were tested. | | | | |

2. TEST METHODOLOGY

This report has been prepared to demonstrate compliance with the requirements for Dynamic Frequency Selection (DFS) as stated in FCC CFR 47 PART 15E(15.407). Testing was performed in accordance with the measurement procedure described in FCC KDB 905462 D02 v02

3. SYSTEM TEST CONFIGURATION

3.1. EUT Exercise Software

The system was configured for testing in a continuous transmits condition and change test channels by software (wl_tool) provided by application.

3.2. Special Accessories

N/A

3.3. Block Diagram/Schematics

Please refer to the related document

3.4. Equipment Modifications

Shenzhen LCS Compliance Testing Laboratory Ltd. has not done any modification on the EUT.

3.5. Test Setup

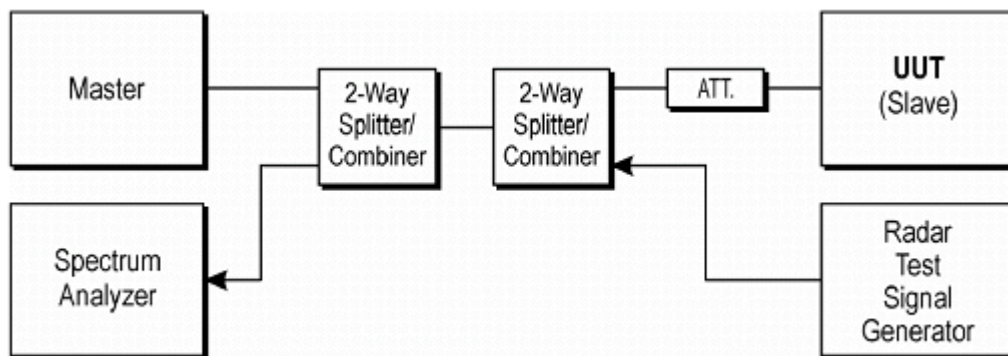

Figure 7-1. Test Setup

3.6. Procedure

The KDB905462 D02 v02 describes a conducted test setup. Each one channel selected between bands 2, band 3 is chosen for the testing.

1. The radar pulse generator is setup to provide a pulse at the frequency that the Master and Client are operating. A Type 0 radar pulse with a 1 μ s pulse width and a 1428 μ s PRI is used for the testing.
2. The vector signal generator is adjusted to provide the radar burst (18 pulses) at a level of approximately -62 dBm at the antenna of the Master device.
3. The Client Device (EUT) is set up per the diagram in Figure 3-1 and communications between the Master device and the Client is established.
4. The MPEG file specified by the FCC ("6½ Magic Hours") is streamed from the "file computer" through the Master to the Slave Device and played in full motion video using Media Player Classic Ver.6.4.8.6 in order to properly load the network.
5. The spectrum analyzer is set to record about 15 sec window to any transmissions occurring up to and after 10 sec.

6. The system is again setup and the monitoring time is shortened in order to capture the Channel Closing Transmission Time. This time is measured to insure that the Client ceases transmission within 200 ms and the aggregate of emissions occurring after 200 ms up to 10 sec do not exceed 60 ms.

(Note: the channel may be different since the Master and Client have changed channels due to the detection of the initial radar pulse.)

7. After the initial radar burst the channel is monitored for 30 minutes to insure no transmissions or beacons occur. A second monitoring setup is used to verify that the Master and Client have both moved to different channels.

4. SUMMARY OF TEST RESULTS

| Applied Standard: FCC CFR 47 PART 15.407 | | | | |
|--|------------------|-----------------------------|--------------------------------|--------------|
| Requirement | Operational Mode | | | RESULTS |
| | Master | Client with radar detection | Client without radar detection | |
| Non-Occupancy Period | Required | Required | Not required | Not required |
| DFS Detection Threshold | Required | Not required | Not required | Not required |
| Channel Availability Check Time | Required | Not required | Not required | Not required |
| Channel Closing Transmission Time | Required | Required | Required | Pass |
| Channel Move Time | Required | Required | Required | Pass |
| U-NII Detection Bandwidth | Required | Not required | Not required | Not required |

5. DESCRIPTION OF DYNAMIC FREQUENCY SELECTION TEST

5.1. Requirements

KDB905462 D02 v02 (04/08/2016) the following are the requirements for Client Devices:

- 1) A Client Device will not transmit before having received appropriate control signals from a Master Device.
- 2) A Client Device will stop all its transmissions whenever instructed by a Master Device to which it is associated and will meet the Channel Move Time and Channel Closing Transmission Time requirements.

The Client Device will not resume any transmissions until it has again received control signals from a Master Device.

- 3) If a Client Device is performing In-Service Monitoring and detects a Radar Waveform above the DFS Detection Threshold, it will inform the Master Device. This is equivalent to the Master Device detecting the Radar Waveform and d) through f) of section 5.1.1(KDB905462 D02 v02) apply.

- 4) Irrespective of Client Device or Master Device detection the Channel Move Time and Channel Closing Transmission Time requirements remain the same.

5.2. Limit

| Parameter | Value |
|-----------------------------------|--|
| Non-occupancy period | Minimum 30 minutes |
| Channel Availability Check Time | 60 seconds |
| Channel Move Time | 10 seconds See Note 1. |
| Channel Closing Transmission Time | 200 milliseconds + an Aggregate of 60 milliseconds over Remaining 10 second period. See Notes 1 and 2. |
| U-NII Detection Bandwidth | Minimum 100 % of the U-NII 99 % transmission power bandwidth. See Note 3. |

Note 1: Channel Move Time and the Channel Closing Transmission Time should be performed with Radar Type 0. The measurement timing begins at the end of the Radar Type 0 burst.

Note 2: The Channel Closing Transmission Time is comprised of 200 milliseconds starting at the beginning of the Channel Move Time plus any additional intermittent control signals required to facilitate a Channel move (an aggregate of 60 milliseconds) during the remainder of the 10 second period. The aggregate duration of control signals will not count quiet periods in between transmissions.

Note 3: During the U-NII Detection Bandwidth detection test, radar type 0 should be used. For each frequency step the minimum percentage of detection is 90 percent. Measurements are performed with no data traffic.

6. DFS DETECTION THRESHOLD VALUES

The DFS detection thresholds are defined for Master devices and Client Devices with In-service monitoring. These detection thresholds are listed in the following table.

| Maximum Transmit Power | Value (See Notes 1 and 2) |
|---|------------------------------|
| EIRP ≥ 200 milliwatt | -64 dBm |
| EIRP < 200 milliwatt and Power spectral < 10 dBm/MHz | -62 dBm |
| EIRP < 200 milliwatt that do not meet the power spectral density requirement | -64 dBm |

Note 1: This is the level at the input of the receiver assuming a 0 dBi receive antenna.

Calibration:

The EUT is slave equipment with a max gain is 2.0dBi;

For a detection threshold level of -62dBm and the master (Brand: Sanmsung), Model: S2LF812265, FCC ID: A3LWEA453E) antenna gain is 3.0 dBi, required detetion threshold is -59.00 dBm (= -62+3.0)

Maximum transmit power is less than 200 milliwatt in this report, so detection threshold level is -62dBm.

Note 2: Throughout these test procedures an additional 1 dB has been added to the amplitude of the test transmission waveforms to account for variations in measurement equipment. This will ensure that the test signal is at or above the detection threshold level to trigger a DFS response.

Note 3: EIRP is based on the highest antenna. For MIMO devices refer to KDB Publication 662911 D01.

7. DFS TEST SIGNALS

As the EUT is a Client Device with no Radar Detection only one type radar pulse is required for the testing. Radar Pulse type 0 was used in the evaluation of the Client device for the purpose of measuring the Channel Move Time and the Channel Closing Transmission Time.

Table 5 – Short Pulse Radar Test Waveforms

| Radar Type | Pulse Width (μsec) | PRI (μsec) | Number of Pulses | Minimum Percentage of Successful Detection | Minimum Number of Trials |
|---|--------------------|---|---|--|--------------------------|
| 0 | 1 | 1428 | 18 | See Note 1 | See Note 1 |
| 1 | 1 | Test A: 15 unique PRI values randomly selected from the list of 23 PRI values in Table 5a | Roundup $\left\{ \begin{matrix} \left(\frac{1}{360} \right) \cdot \\ \left(\frac{19 \cdot 10^6}{PRI_{\mu sec}} \right) \end{matrix} \right\}$ | 60% | 30 |
| | | Test B: 15 unique PRI values randomly selected within the range of 518-3066 μsec, with a minimum increment of 1 μsec, excluding PRI values selected in Test A | | | |
| 2 | 1-5 | 150-230 | 23-29 | 60% | 30 |
| 3 | 6-10 | 200-500 | 16-18 | 60% | 30 |
| 4 | 11-20 | 200-500 | 12-16 | 60% | 30 |
| Aggregate (Radar Types 1-4) | | | | 80% | 120 |
| Note 1: Short Pulse Radar Type 0 should be used for the detection bandwidth test, channel move time, and channel closing time tests. | | | | | |

A minimum of 30 unique waveforms are required for each of the Short Pulse Radar Types 2 through 4. If more than 30 waveforms are used for Short Pulse Radar Types 2 through 4, then each additional waveform must also be unique and not repeated from the previous waveforms. If more than 30 waveforms are used for Short Pulse Radar Type 1, then each additional waveform is generated with Test B and must also be unique and not repeated from the previous waveforms in Tests A or B.

Table 6 – Long Pulse Radar Test Waveform

| Radar Type | Pulse Width (μsec) | Chirp Width (MHz) | PRI (μsec) | Number of Pulses per Burst | Number of Bursts | Minimum Percentage of Successful Detection | Minimum Number of Trials |
|------------|--------------------|-------------------|------------|----------------------------|------------------|--|--------------------------|
| 5 | 50-100 | 5-20 | 1000-2000 | 1-3 | 8-20 | 80% | 30 |

The parameters for this waveform are randomly chosen. Thirty unique waveforms are required for the Long Pulse Radar Type waveforms. If more than 30 waveforms are used for the Long Pulse Radar Type waveforms, then each additional waveform must also be unique and not repeated from the previous waveforms.

Table 7 – Frequency Hopping Radar Test Waveform

| Radar Type | Pulse Width (μsec) | PRI (μsec) | Pulses per Hop | Hopping Rate (kHz) | Hopping Sequence Length (msec) | Minimum Percentage of Successful Detection | Minimum Number of Trials |
|------------|--------------------|------------|----------------|--------------------|--------------------------------|--|--------------------------|
| 6 | 1 | 333 | 9 | 0.333 | 300 | 70% | 30 |

Table 5a - Pulse Repetition Intervals Values for Test A

| Pulse Repetition Frequency Number | Pulse Repetition Frequency (Pulses Per Second) | Pulse Repetition Interval (Microseconds) |
|-----------------------------------|--|--|
| 1 | 1930.5 | 518 |
| 2 | 1858.7 | 538 |
| 3 | 1792.1 | 558 |
| 4 | 1730.1 | 578 |
| 5 | 1672.2 | 598 |
| 6 | 1618.1 | 618 |
| 7 | 1567.4 | 638 |
| 8 | 1519.8 | 658 |
| 9 | 1474.9 | 678 |
| 10 | 1432.7 | 698 |
| 11 | 1392.8 | 718 |
| 12 | 1355 | 738 |
| 13 | 1319.3 | 758 |
| 14 | 1285.3 | 778 |
| 15 | 1253.1 | 798 |
| 16 | 1222.5 | 818 |
| 17 | 1193.3 | 838 |
| 18 | 1165.6 | 858 |
| 19 | 1139 | 878 |
| 20 | 1113.6 | 898 |
| 21 | 1089.3 | 918 |
| 22 | 1066.1 | 938 |
| 23 | 326.2 | 3066 |

Manufacturer’s Statement Regarding Uniform Channel Spreading

The end product implements an automatic channel selection feature at startup such that operation commences on channels distributed across the entire set of allowed 5GHz channels. This feature will ensure uniform spreading is achieved while avoiding non-allowed channels due to prior radar events.

TEST AND MEASUREMENT SYSTEM

System Overview

The measurement system is based on a conducted test method. The short pulse and long pulse signal generating system utilizes the NTIA software and the same manufacturer / model Vector Signal Generator as the NTIA. The hopping signal generating system utilizes the simulated hopping method. The software selects waveform parameters from within the bounds of the signal type on a random basis using uniform distribution. The short pulse types 2, 3 and 4, and the long pulse type 5 parameters are randomized at run-time. The hopping type 6 pulse parameters are fixed while the hopping sequence is based on the August 2005 NTIA Hopping Frequency List, with the initial starting point randomized at run-time. The signal monitoring equipment consists of a spectrum analyzer with the capacity to display 8192 bins on the horizontal axis. A time-domain resolution of 2 msec / bin is achievable with a 16 second sweep time, meeting the 10 second short pulse reporting criteria. The aggregate ON time is calculated by multiplying the number of bins above a threshold during a particular observation period by the dwell time per bin, with the analyzer set to peak detection and max hold. A time-domain resolution of 3 msec / bin is achievable with a 24 second sweep

time, meeting the 22 second long pulse reporting criteria and allowing a minimum of 10 seconds after the end of the long pulse waveform.

Frequency Hopping Signal Generation

The hopping burst generator is a High Speed Digital I/O card plugged into the control computer. This card utilizes an independent hardware clock reference therefore the output pulse timing is unaffected by host computer operating system latency times.

The software selects the hopping sequence as a 100-length segment of the August 2005 NTIA hopping frequency list. This list contains 274 unique pseudorandom sequences. Each such sequence contains 475 frequencies ordered on a random without replacement basis. Each successive trial uses a contiguous 100-length segment from within each successive 475-length sequence in the list. The initial starting point within the list is randomized at run-time such that the first 100-length segment is entirely contained within the first 475-length sequence. The starting point of each successive trial is incremented by 475.

Each frequency in the 100-length segment is compared to the boundaries of the EUT Detection Bandwidth and the software creates a hopping burst pattern in accordance with Section 7.4.1.3 Method #2 Simulated Frequency Hopping Radar Waveform Generating Subsystem of FCC 06-96 APPENDIX. The frequency of the signal generator is incremented in 1 MHz steps from FL to FH for each successive trial. This incremental sequence is repeated as required to generate a minimum of 30 total trials and to maintain a uniform frequency distribution over the entire Detection Bandwidth.

Conducted Method System Block Diagram

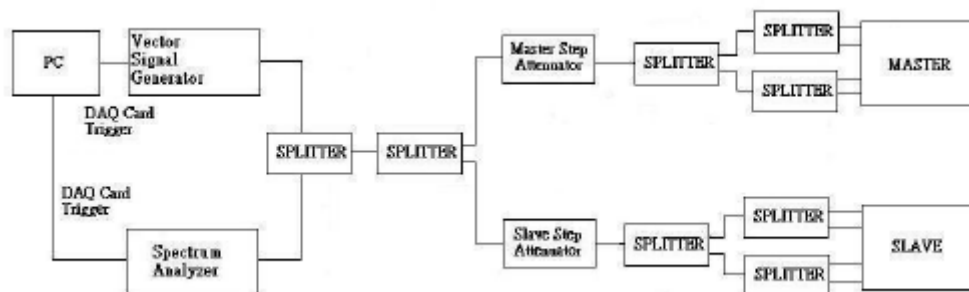

Measurement System Frequency Reference

Lock the signal generator and the spectrum analyzer to the same reference source as follows: Connect the 10 MHz OUT (SWITCHED) on the spectrum analyzer to the 10 MHz IN on the signal generator and set the spectrum analyzer 10 MHz Out to On.

System Calibration

Connect the spectrum analyzer to the test system in place of the master device. Set the signal generator to CW mode. Adjust the amplitude of the signal generator to yield a measured level of -62 dBm on the spectrum analyzer.

Without changing any of the instrument settings, reconnect the spectrum analyzer to the Common port of the Spectrum Analyzer Combiner/Divider and connect a 50 ohm load to the Master Device port of the test system. Measure the amplitude and calculate the difference from -62 dBm. Adjust the Reference Level Offset of the spectrum analyzer to this difference. Confirm that the signal is displayed at -62 dBm. Readjust the RBW and VBW to 3 MHz, set the span to 10 MHz, and confirm that the signal is still displayed at -62 dBm.

The spectrum analyzer displays the level of the signal generator as received at the antenna ports of the Master Device. The interference detection threshold may be varied from the calibrated value of -62 dBm and the spectrum analyzer will still indicate the level as received by the Master Device.

Set the signal generator to produce a radar waveform, trigger a burst manually and measure the level on the spectrum analyzer. Readjust the amplitude of the signal generator as required so that the peak level of the waveform is at a displayed level equal to the required or desired interference detection threshold. Separate signal generator amplitude settings are determined as required for each radar type.

Interference Detection Threshold Adjustment

Download the applicable radar waveforms to the signal generator. Select the radar waveform, trigger a burst manually and measure the amplitude on the spectrum analyzer. Readjust the amplitude of the signal generator as required so that the peak level of the waveform is at a displayed level equal to the required or desired interference detection threshold. Separate signal generator amplitude settings are determined as required for each radar type.

Adjustment Of Displayed Traffic Level

Establish a link between the Master and Slave, adjusting the Link Step Attenuator as needed to provide a suitable received level at the Master and Slave devices. Stream the video test file to generate WLAN traffic. Confirm that the WLAN traffic level, as displayed on the spectrum analyzer, is at lower amplitude than the radar

detection threshold. Confirm that the displayed traffic is from the Master Device. For Master Device testing confirm that the displayed traffic does not include Slave Device traffic. For Slave Device testing confirm that the displayed traffic does not include Master Device traffic.

If a different setting of the Master Step Attenuator is required to meet the above conditions, perform a new System Calibration for the new Master Step Attenuator setting.

Test Setup

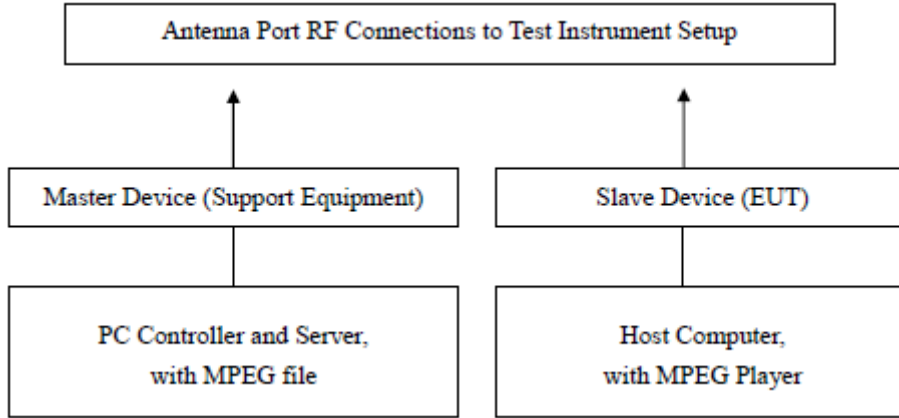

8. TEST RESULT

PLOTS OF RADAR WAVEFORMS

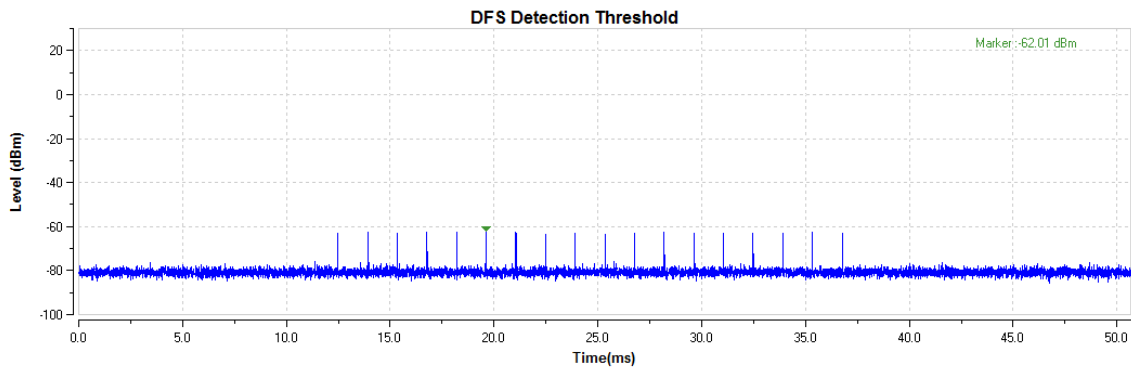

Radar Singal 0

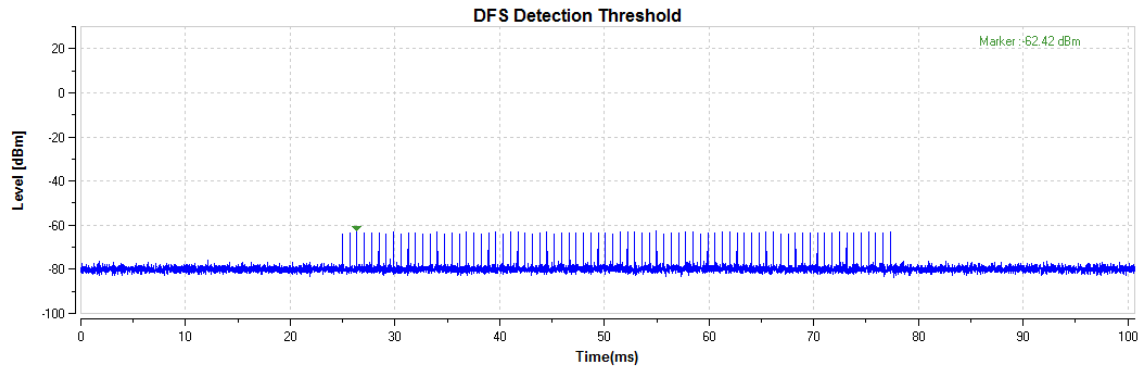

Radar Singal 1

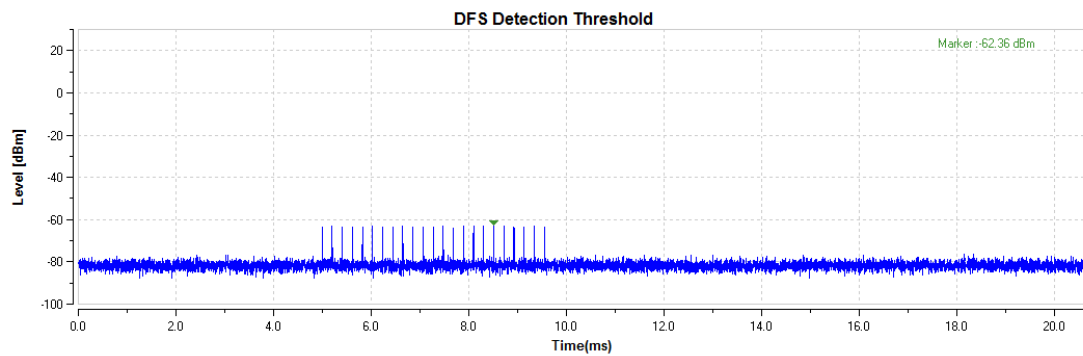

Radar Singal 2

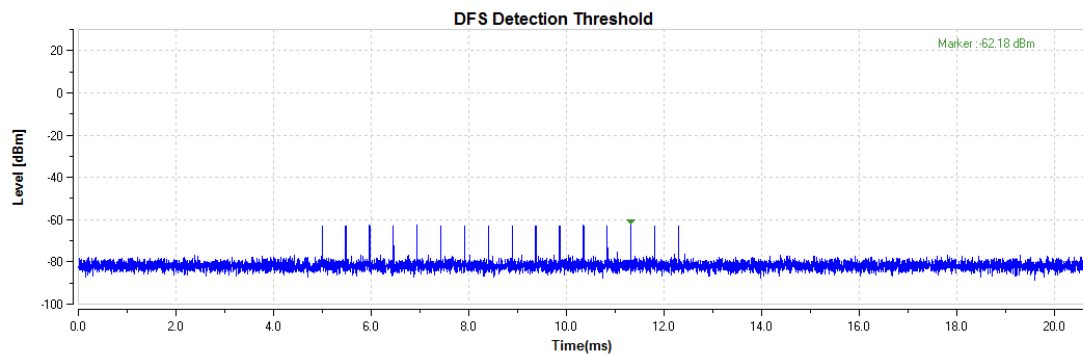

Radar Singal 3

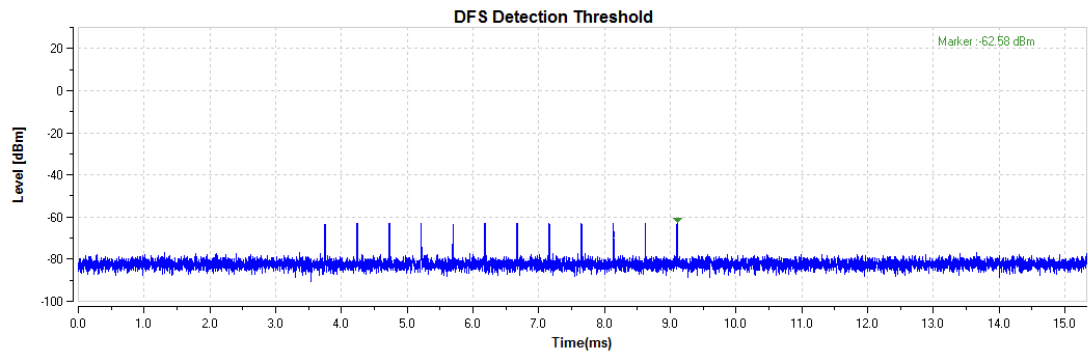

Radar Singal 4

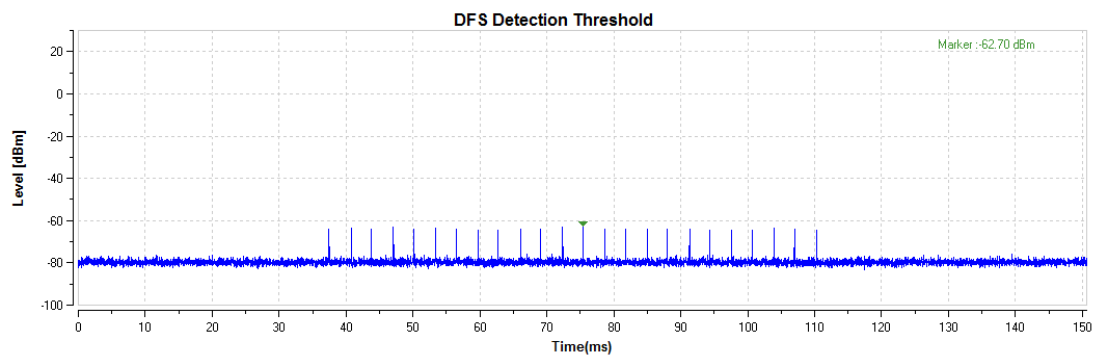

Radar Singal 5

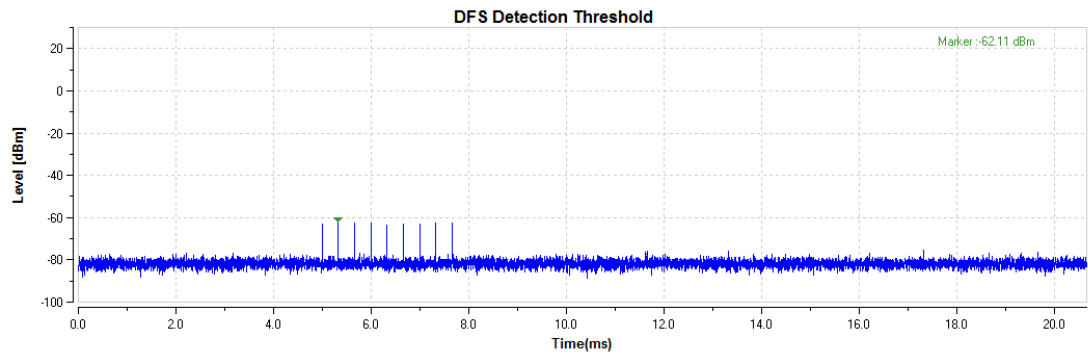

Radar Singal 6

Radar Singal 0

| Trial ID | Radar Type | Pulse Width (us) | PRI (us) | Number of Pulses | Waveform Legth (us) |
|----------|------------|------------------|----------|------------------|---------------------|
| 0 | Type 0 | 1 | 1428 | 18 | 25704 |
| 1 | Type 0 | 1 | 1428 | 18 | 25704 |
| 2 | Type 0 | 1 | 1428 | 18 | 25704 |
| 3 | Type 0 | 1 | 1428 | 18 | 25704 |
| 4 | Type 0 | 1 | 1428 | 18 | 25704 |
| 5 | Type 0 | 1 | 1428 | 18 | 25704 |
| 6 | Type 0 | 1 | 1428 | 18 | 25704 |
| 7 | Type 0 | 1 | 1428 | 18 | 25704 |
| 8 | Type 0 | 1 | 1428 | 18 | 25704 |
| 9 | Type 0 | 1 | 1428 | 18 | 25704 |
| 10 | Type 0 | 1 | 1428 | 18 | 25704 |
| 11 | Type 0 | 1 | 1428 | 18 | 25704 |
| 12 | Type 0 | 1 | 1428 | 18 | 25704 |
| 13 | Type 0 | 1 | 1428 | 18 | 25704 |
| 14 | Type 0 | 1 | 1428 | 18 | 25704 |
| 15 | Type 0 | 1 | 1428 | 18 | 25704 |
| 16 | Type 0 | 1 | 1428 | 18 | 25704 |
| 17 | Type 0 | 1 | 1428 | 18 | 25704 |
| 18 | Type 0 | 1 | 1428 | 18 | 25704 |
| 19 | Type 0 | 1 | 1428 | 18 | 25704 |
| 20 | Type 0 | 1 | 1428 | 18 | 25704 |
| 21 | Type 0 | 1 | 1428 | 18 | 25704 |
| 22 | Type 0 | 1 | 1428 | 18 | 25704 |
| 23 | Type 0 | 1 | 1428 | 18 | 25704 |
| 24 | Type 0 | 1 | 1428 | 18 | 25704 |
| 25 | Type 0 | 1 | 1428 | 18 | 25704 |
| 26 | Type 0 | 1 | 1428 | 18 | 25704 |
| 27 | Type 0 | 1 | 1428 | 18 | 25704 |
| 28 | Type 0 | 1 | 1428 | 18 | 25704 |
| 29 | Type 0 | 1 | 1428 | 18 | 25704 |

Radar Singal 1

| Trial ID | Radar Type | Pulse Width (us) | PRI (us) | Number of Pulses | Waveform Legth (us) | Pulse Repection Frequency (Pulses Per Second) | Pulse Repection Interval (Microseconds) |
|----------|------------|------------------|----------|------------------|---------------------|---|---|
| 0 | Type A | 1 | 938 | 57 | 53466 | 1066.1 | 938 |
| 1 | Type A | 1 | 698 | 76 | 53048 | 1432.7 | 698 |
| 2 | Type A | 1 | 618 | 86 | 53148 | 1618.1 | 618 |
| 3 | Type A | 1 | 538 | 99 | 53262 | 1858.7 | 538 |
| 4 | Type A | 1 | 878 | 61 | 53558 | 1139 | 878 |
| 5 | Type A | 1 | 3066 | 18 | 55188 | 326.2 | 326.2 |
| 6 | Type A | 1 | 638 | 83 | 52954 | 1567.4 | 1567.4 |
| 7 | Type A | 1 | 918 | 58 | 53244 | 1089.3 | 1089.3 |
| 8 | Type A | 1 | 838 | 63 | 52794 | 1193.3 | 1193.3 |
| 9 | Type A | 1 | 858 | 62 | 53196 | 1165.6 | 1165.6 |
| 10 | Type A | 1 | 798 | 67 | 53466 | 1253.1 | 1253.1 |
| 11 | Type A | 1 | 718 | 74 | 53132 | 1392.8 | 1392.8 |
| 12 | Type A | 1 | 578 | 92 | 53176 | 1730.1 | 1730.1 |
| 13 | Type A | 1 | 598 | 89 | 53222 | 1672.2 | 1672.2 |
| 14 | Type A | 1 | 558 | 95 | 53010 | 1792.1 | 1792.1 |
| 15 | Type B | 1 | 2536 | 21 | 53256 | | |
| 16 | Type B | 1 | 966 | 55 | 53130 | | |
| 17 | Type B | 1 | 827 | 64 | 52928 | | |
| 18 | Type B | 1 | 2501 | 22 | 55022 | | |
| 19 | Type B | 1 | 2595 | 21 | 54495 | | |
| 20 | Type B | 1 | 1114 | 48 | 53472 | | |
| 21 | Type B | 1 | 1302 | 41 | 53382 | | |
| 22 | Type B | 1 | 3045 | 18 | 54810 | | |
| 23 | Type B | 1 | 1624 | 33 | 53592 | | |
| 24 | Type B | 1 | 2878 | 19 | 54682 | | |
| 25 | Type B | 1 | 1027 | 52 | 53404 | | |
| 26 | Type B | 1 | 2485 | 22 | 54670 | | |
| 27 | Type B | 1 | 1600 | 33 | 52800 | | |
| 28 | Type B | 1 | 1172 | 46 | 53912 | | |
| 29 | Type B | 1 | 1177 | 45 | 52965 | | |

Radar Singal 2

| Trial ID | Radar Type | Pulse Width (us) | PRI (us) | Number of Pulses | Waveform Legth (us) |
|----------|------------|------------------|----------|------------------|---------------------|
| 0 | Type 2 | 3.2 | 179 | 26 | 4654 |
| 1 | Type 2 | 1.1 | 207 | 23 | 4761 |
| 2 | Type 2 | 2.1 | 230 | 24 | 5520 |
| 3 | Type 2 | 4.8 | 200 | 29 | 5800 |
| 4 | Type 2 | 3.9 | 214 | 28 | 5992 |
| 5 | Type 2 | 2.9 | 222 | 26 | 5772 |
| 6 | Type 2 | 3.2 | 204 | 26 | 5304 |
| 7 | Type 2 | 2.5 | 192 | 25 | 4800 |
| 8 | Type 2 | 3.1 | 164 | 26 | 4264 |
| 9 | Type 2 | 1.2 | 156 | 23 | 3588 |
| 10 | Type 2 | 3.9 | 210 | 27 | 5670 |
| 11 | Type 2 | 4.6 | 201 | 29 | 5829 |
| 12 | Type 2 | 3.2 | 162 | 26 | 4212 |
| 13 | Type 2 | 2.2 | 197 | 25 | 4925 |
| 14 | Type 2 | 4.5 | 163 | 29 | 4727 |
| 15 | Type 2 | 3 | 203 | 26 | 5278 |
| 16 | Type 2 | 5 | 168 | 29 | 4872 |
| 17 | Type 2 | 2.4 | 217 | 25 | 5425 |
| 18 | Type 2 | 2.9 | 191 | 26 | 4966 |
| 19 | Type 2 | 2.3 | 166 | 25 | 4150 |
| 20 | Type 2 | 3.7 | 150 | 27 | 4050 |
| 21 | Type 2 | 2.2 | 176 | 25 | 4400 |
| 22 | Type 2 | 4.9 | 195 | 29 | 5655 |
| 23 | Type 2 | 2.9 | 202 | 26 | 5252 |
| 24 | Type 2 | 2.5 | 178 | 25 | 4450 |
| 25 | Type 2 | 1.1 | 206 | 23 | 4738 |
| 26 | Type 2 | 3.8 | 155 | 27 | 4185 |
| 27 | Type 2 | 4.8 | 157 | 29 | 4553 |
| 28 | Type 2 | 2.4 | 224 | 25 | 5600 |
| 29 | Type 2 | 4.2 | 159 | 28 | 4452 |

Radar Singal 3

| Trial ID | Radar Type | Pulse Width (us) | PRI (us) | Number of Pulses | Waveform Legth (us) |
|----------|------------|------------------|----------|------------------|---------------------|
| 0 | Type 3 | 8.2 | 355 | 17 | 6035 |
| 1 | Type 3 | 6.1 | 487 | 16 | 7792 |
| 2 | Type 3 | 7.1 | 344 | 16 | 5504 |
| 3 | Type 3 | 9.8 | 288 | 18 | 5184 |
| 4 | Type 3 | 8.9 | 230 | 18 | 4140 |
| 5 | Type 3 | 7.9 | 432 | 17 | 7344 |
| 6 | Type 3 | 8.2 | 207 | 17 | 3519 |
| 7 | Type 3 | 7.5 | 443 | 17 | 7531 |
| 8 | Type 3 | 8.1 | 439 | 17 | 7463 |
| 9 | Type 3 | 6.2 | 223 | 16 | 3568 |
| 10 | Type 3 | 8.9 | 208 | 18 | 3744 |
| 11 | Type 3 | 9.6 | 463 | 18 | 8334 |
| 12 | Type 3 | 8.2 | 441 | 17 | 7497 |
| 13 | Type 3 | 7.2 | 323 | 16 | 5168 |
| 14 | Type 3 | 9.5 | 297 | 18 | 5346 |
| 15 | Type 3 | 8 | 412 | 17 | 7004 |
| 16 | Type 3 | 10 | 324 | 18 | 5832 |
| 17 | Type 3 | 7.4 | 271 | 17 | 4607 |
| 18 | Type 3 | 7.9 | 349 | 17 | 5933 |
| 19 | Type 3 | 7.3 | 409 | 16 | 6544 |
| 20 | Type 3 | 8.7 | 373 | 18 | 6714 |
| 21 | Type 3 | 7.2 | 254 | 16 | 4064 |
| 22 | Type 3 | 9.9 | 274 | 18 | 5932 |
| 23 | Type 3 | 7.9 | 278 | 17 | 4726 |
| 24 | Type 3 | 7.5 | 317 | 17 | 5389 |
| 25 | Type 3 | 6.1 | 260 | 16 | 4160 |
| 26 | Type 3 | 8.8 | 211 | 18 | 3798 |
| 27 | Type 3 | 9.7 | 272 | 18 | 4896 |
| 28 | Type 3 | 7.4 | 264 | 17 | 4488 |
| 29 | Type 3 | 9.2 | 284 | 18 | 5112 |

Radar Singal 4

| Trial ID | Radar Type | Pulse Width (us) | PRI (us) | Number of Pulses | Waveform Legth (us) |
|----------|------------|------------------|----------|------------------|---------------------|
| 0 | Type 4 | 16 | 355 | 14 | 4970 |
| 1 | Type 4 | 11.3 | 487 | 12 | 5844 |
| 2 | Type 4 | 13.5 | 344 | 13 | 4472 |
| 3 | Type 4 | 19.4 | 288 | 16 | 4608 |
| 4 | Type 4 | 17.5 | 230 | 15 | 3450 |
| 5 | Type 4 | 15.3 | 432 | 14 | 6048 |
| 6 | Type 4 | 15.9 | 207 | 14 | 2898 |
| 7 | Type 4 | 14.3 | 443 | 13 | 5759 |
| 8 | Type 4 | 15.8 | 439 | 14 | 6145 |
| 9 | Type 4 | 11.5 | 223 | 112 | 2676 |
| 10 | Type 4 | 17.4 | 208 | 15 | 3120 |
| 11 | Type 4 | 19 | 463 | 16 | 7408 |
| 12 | Type 4 | 16 | 441 | 14 | 6174 |
| 13 | Type 4 | 13.8 | 323 | 13 | 4199 |
| 14 | Type 4 | 18.9 | 297 | 16 | 4752 |
| 15 | Type 4 | 15.5 | 412 | 14 | 5768 |
| 16 | Type 4 | 19.9 | 324 | 16 | 5184 |
| 17 | Type 4 | 14.1 | 271 | 13 | 3523 |
| 18 | Type 4 | 15.2 | 349 | 14 | 4886 |
| 19 | Type 4 | 13.8 | 409 | 31 | 5317 |
| 20 | Type 4 | 17.1 | 373 | 151 | 5595 |
| 21 | Type 4 | 13.8 | 254 | 13 | 3302 |
| 22 | Type 4 | 19.8 | 274 | 16 | 4384 |
| 23 | Type 4 | 15.3 | 278 | 14 | 3892 |
| 24 | Type 4 | 14.5 | 317 | 13 | 4121 |
| 25 | Type 4 | 11.3 | 260 | 12 | 3120 |
| 26 | Type 4 | 17.3 | 211 | 15 | 3165 |
| 27 | Type 4 | 19.2 | 272 | 16 | 4352 |
| 28 | Type 4 | 14.2 | 264 | 13 | 3432 |
| 29 | Type 4 | 18.2 | 284 | 15 | 4260 |

Radar Singal 5_5530MHz

| Trial ID | Radar Type | Number of Bursts | Burst Period(s) | Wave from Length (s) | Center Frequency(GHz) | - | | |
|----------|------------|-------------------|------------------|----------------------|----------------------------|------------|------------|------------|
| 0 | Type 5 | 15 | 0.8 | 12 | 5.53 | - | | |
| | Burst ID | Pulse Width (us) | PRI (us) | Chirp Width(MHz) | Number of Pulses per Burst | PRI-1 (us) | PRI-2 (us) | PRI-3 (us) |
| | 0 | 636185 | 77.8 | 13 | 2 | 1685 | 1477 | - |
| | 1 | 32674 | 51.9 | 13 | 1 | 1074 | - | - |
| | 2 | 226294 | 63.8 | 13 | 1 | 1584 | - | - |
| | 3 | 417976 | 96.6 | 13 | 3 | 1682 | 1786 | 1843 |
| | 4 | 611152 | 85.9 | 13 | 3 | 1795 | 1215 | 1729 |
| | 5 | 8789 | 73.7 | 13 | 2 | 1198 | 1549 | - |
| | 6 | 201917 | 77.2 | 13 | 2 | 1837 | 1819 | - |
| | 7 | 395530 | 68.4 | 13 | 2 | 1587 | 1114 | - |
| | 8 | 588564 | 76.7 | 13 | 2 | 2000 | 1155 | - |
| | 9 | 783794 | 53.2 | 13 | 1 | 1147 | - | - |
| | 10 | 177933 | 85.7 | 13 | 3 | 1433 | 1695 | 1394 |
| | 11 | 370624 | 94.3 | 13 | 3 | 1670 | 1426 | 1935 |
| | 12 | 564893 | 77.6 | 13 | 2 | 1294 | 1671 | - |
| | 13 | 759583 | 65.7 | 13 | 1 | 1512 | - | - |
| | 14 | 154262 | 93.5 | 13 | 3 | 1444 | 1130 | 1468 |
| 1 | Type 5 | 8 | 1.5 | 12 | 5.53 | | | |
| | Burst ID | Burst Offset (us) | Pulse Width (us) | Chirp Width (MHz) | Number of Pulses per Burst | PRI-1 (us) | PRI-2 (us) | PRI-3 (us) |
| | 0 | 653020 | 75 | 5 | 2 | 1880 | 1527 | - |
| | 1 | 1015643 | 99.4 | 5 | 3 | 1401 | 1262 | 1257 |
| | 2 | 1379398 | 67.4 | 5 | 2 | 1531 | 1403 | - |
| | 3 | 245489 | 73.6 | 5 | 2 | 1449 | 1041 | - |
| | 4 | 609113 | 65.9 | 5 | 1 | 1432 | - | - |
| | 5 | 970852 | 83.8 | 5 | 3 | 1356 | 1292 | 1419 |
| | 6 | 1335913 | 65.5 | 5 | 1 | 1543 | - | - |
| | 7 | 200406 | 98.6 | 5 | 3 | 1548 | 1796 | 1728 |

| Trial ID | Radar Type | Number of Bursts | Burst Period(s) | Wave from Length (s) | Center Frequency(GHz) | - | | |
|----------|------------|-------------------|------------------|----------------------|----------------------------|------------|------------|------------|
| 2 | Type 5 | 11 | 1.090909 | 12 | 5.53 | | | |
| | Burst ID | Burst Offset (us) | Pulse Width (us) | Chirp Width (MHz) | Number of Pulses per Burst | PRI-1 (us) | PRI-2 (us) | PRI-3 (us) |
| | 0 | 409565 | 73.8 | 9 | 2 | 1806 | 1538 | - |
| | 1 | 673692 | 69.5 | 9 | 2 | 1117 | 1649 | - |
| | 2 | 938562 | 51.9 | 9 | 1 | 1651 | - | - |
| | 3 | 113209 | 84.6 | 9 | 3 | 1976 | 1032 | 1271 |
| | 4 | 376726 | 95.4 | 9 | 3 | 1060 | 1903 | 1388 |
| | 5 | 641212 | 68 | 9 | 2 | 1368 | 1351 | - |
| | 6 | 903714 | 89.6 | 9 | 3 | 1338 | 1514 | 1573 |
| | 7 | 80863 | 81.9 | 9 | 2 | 1022 | 1689 | - |
| | 8 | 344067 | 88.3 | 9 | 3 | 1810 | 1330 | 1838 |
| | 9 | 609331 | 53.7 | 9 | 1 | 1597 | - | - |
| | 10 | 871542 | 91.3 | 9 | 3 | 1961 | 1106 | 1001 |
| 3 | Type 5 | 20 | 0.6 | 12 | 5.53 | | | |
| | Burst ID | Burst Offset (us) | Pulse Width (us) | Chirp Width (MHz) | Number of Pulses per Burst | PRI-1 (us) | PRI-2 (us) | PRI-3 (us) |
| | 0 | 26541 | 68.1 | 19 | 2 | 1339 | 1355 | - |
| | 1 | 171821 | 58.7 | 19 | 1 | 1251 | - | - |
| | 2 | 316229 | 75.3 | 19 | 2 | 1136 | 1640 | - |
| | 3 | 461864 | 56.4 | 19 | 1 | 1753 | - | - |
| | 4 | 8677 | 99.7 | 19 | 3 | 1196 | 1708 | 1159 |
| | 5 | 153995 | 57.7 | 19 | 1 | 1013 | - | - |
| | 6 | 299238 | 59.5 | 19 | 1 | 1072 | - | - |
| | 7 | 443177 | 80 | 19 | 2 | 1482 | 1369 | - |
| | 8 | 587671 | 82 | 19 | 2 | 1993 | 1197 | - |
| | 9 | 135674 | 82.8 | 19 | 2 | 1883 | 1005 | - |
| | 10 | 279928 | 88 | 19 | 3 | 1061 | 1928 | 1101 |
| | 11 | 424279 | 93.2 | 19 | 3 | 1207 | 1907 | 1223 |
| | 12 | 570132 | 70.4 | 19 | 2 | 1526 | 1360 | - |
| | 13 | 117439 | 95.3 | 19 | 3 | 1171 | 1955 | 1775 |
| | 14 | 262502 | 81.9 | 19 | 2 | 1690 | 1545 | - |
| | 15 | 406573 | 98.5 | 19 | 3 | 1975 | 1169 | 1062 |
| | 16 | 553328 | 65 | 19 | 1 | 1767 | - | - |
| | 17 | 99799 | 85.4 | 19 | 3 | 1011 | 1637 | 1425 |
| | 18 | 244095 | 91.6 | 19 | 3 | 1878 | 1445 | 1325 |
| | 19 | 390012 | 67.3 | 19 | 2 | 1091 | 1218 | - |

| Trial ID | Radar Type | Number of Bursts | Burst Period(s) | Wave from Length (s) | Center Frequency(GHz) | - | | |
|----------|------------|-------------------|------------------|----------------------|----------------------------|------------|------------|------------|
| 4 | Type 5 | 17 | 0.705882 | 12 | 5.53 | | | |
| | Burst ID | Burst Offset (us) | Pulse Width (us) | Chirp Width (MHz) | Number of Pulses per Burst | PRI-1 (us) | PRI-2 (us) | PRI-3 (us) |
| | 0 | 629614 | 67.9 | 16 | 2 | 1320 | 1133 | - |
| | 1 | 96856 | 62.3 | 16 | 1 | 1957 | - | - |
| | 2 | 267719 | 53.3 | 16 | 1 | 1592 | - | - |
| | 3 | 436784 | 90 | 16 | 3 | 1900 | 1153 | 1346 |
| | 4 | 608289 | 77.1 | 16 | 2 | 1166 | 1646 | - |
| | 5 | 75610 | 83.9 | 16 | 3 | 1278 | 1232 | 1459 |
| | 6 | 245638 | 89.1 | 16 | 3 | 1240 | 1384 | 1939 |
| | 7 | 416355 | 81.8 | 16 | 2 | 1833 | 1676 | - |
| | 8 | 588736 | 50.3 | 16 | 1 | 1075 | - | - |
| | 9 | 54571 | 87.1 | 16 | 3 | 1116 | 1996 | 1756 |
| | 10 | 225175 | 71.3 | 16 | 2 | 1225 | 1815 | - |
| | 11 | 394825 | 97.5 | 16 | 3 | 1884 | 1465 | 1132 |
| | 12 | 565361 | 90.6 | 16 | 3 | 1561 | 1040 | 1354 |
| | 13 | 33643 | 86.3 | 16 | 3 | 1596 | 1183 | 1792 |
| | 14 | 203957 | 97.6 | 16 | 3 | 1365 | 1073 | 1361 |
| | 15 | 373812 | 84.7 | 16 | 3 | 1021 | 1718 | 1854 |
| | 16 | 544060 | 99.7 | 16 | 3 | 1150 | 1244 | 1988 |

| 5 | Type 5 | 14 | 0.857143 | 12 | 5.53 | | | |
|---|----------|-------------------|------------------|-------------------|----------------------------|------------|------------|------------|
| | Burst ID | Burst Offset (us) | Pulse Width (us) | Chirp Width (MHz) | Number of Pulses per Burst | PRI-1 (us) | PRI-2 (us) | PRI-3 (us) |
| | 0 | 15438 | 92.9 | 12 | 3 | 1085 | 1564 | 1407 |
| | 1 | 222486 | 67.7 | 12 | 2 | 1744 | 1747 | - |
| | 2 | 430731 | 65.8 | 12 | 1 | 1092 | - | - |
| | 3 | 637784 | 56.3 | 12 | 1 | 1851 | - | - |
| | 4 | 845342 | 53.7 | 12 | 1 | 1727 | - | - |
| | 5 | 196720 | 83.5 | 12 | 3 | 1679 | 1930 | 1025 |
| | 6 | 404955 | 65.8 | 12 | 1 | 1519 | - | - |
| | 7 | 610711 | 85.9 | 12 | 3 | 1134 | 1034 | 1808 |
| | 8 | 818057 | 76.3 | 12 | 2 | 1606 | 1926 | - |
| | 9 | 171459 | 81.5 | 12 | 2 | 1891 | 1714 | - |
| | 10 | 377969 | 89.4 | 12 | 3 | 1310 | 1594 | 1827 |
| | 11 | 586875 | 63.4 | 12 | 1 | 1568 | - | - |
| | 12 | 792834 | 69.6 | 12 | 2 | 1307 | 1925 | - |
| | 13 | 146044 | 74.5 | 12 | 2 | 1264 | 1846 | - |

| Trial ID | Radar Type | Number of Bursts | Burst Period(s) | Wave from Length (s) | Center Frequency(GHz) | - | | |
|----------|------------|-------------------|------------------|----------------------|----------------------------|------------|------------|------------|
| 6 | Type 5 | 15 | 0.8 | 12 | 5.53 | | | |
| | Burst ID | Burst Offset (us) | Pulse Width (us) | Chirp Width (MHz) | Number of Pulses per Burst | PRI-1 (us) | PRI-2 (us) | PRI-3 (us) |
| | 0 | 329022 | 96.6 | 13 | 3 | 1182 | 1609 | 1581 |
| | 1 | 521718 | 96.7 | 13 | 3 | 1829 | 1799 | 1154 |
| | 2 | 714222 | 86.5 | 13 | 3 | 1923 | 1396 | 1865 |
| | 3 | 112450 | 73.3 | 13 | 2 | 1908 | 1318 | - |
| | 4 | 306283 | 55.8 | 13 | 1 | 1688 | - | - |
| | 5 | 500239 | 55.4 | 13 | 1 | 1145 | - | - |
| | 6 | 690932 | 85.3 | 13 | 3 | 1336 | 1504 | 1820 |
| | 7 | 88645 | 79.4 | 13 | 2 | 1344 | 1893 | - |
| | 8 | 282508 | 65.7 | 13 | 1 | 1476 | - | - |
| | 9 | 475842 | 68.6 | 13 | 2 | 1008 | 1028 | - |
| | 10 | 667887 | 77.7 | 13 | 2 | 1972 | 1835 | - |
| | 11 | 64845 | 79.6 | 13 | 2 | 1882 | 1331 | - |
| | 12 | 257755 | 94.9 | 13 | 3 | 1830 | 1070 | 1349 |
| | 13 | 452335 | 61.4 | 13 | 1 | 1451 | - | - |
| | 14 | 643395 | 90.6 | 13 | 3 | 1233 | 1562 | 1887 |
| 7 | Type 5 | 12 | 1 | 12 | 5.53 | | | |
| | Burst ID | Burst Offset (us) | Pulse Width (us) | Chirp Width (MHz) | Number of Pulses per Burst | PRI-1 (us) | PRI-2 (us) | PRI-3 (us) |
| | 0 | 51446 | 52.6 | 10 | 1 | 1210 | - | - |
| | 1 | 292696 | 84.1 | 10 | 3 | 1314 | 1725 | 1529 |
| | 2 | 533989 | 97.7 | 10 | 3 | 1139 | 1868 | 1805 |
| | 3 | 775664 | 97.3 | 10 | 3 | 1341 | 1446 | 1755 |
| | 4 | 21542 | 98.8 | 10 | 3 | 1544 | 1386 | 1302 |
| | 5 | 263385 | 72.2 | 10 | 2 | 1771 | 1184 | - |
| | 6 | 505581 | 67.6 | 10 | 2 | 1175 | 1027 | - |
| | 7 | 747058 | 75.7 | 10 | 2 | 1026 | 1871 | - |
| | 8 | 989976 | 60.9 | 10 | 1 | 1798 | - | - |
| | 9 | 234024 | 64.2 | 10 | 1 | 1138 | - | - |
| | 10 | 475207 | 78.8 | 10 | 2 | 1784 | 1604 | - |
| | 11 | 715825 | 87.5 | 10 | 3 | 1511 | 1712 | 1683 |

| Trial ID | Radar Type | Number of Bursts | Burst Period(s) | Wave from Length (s) | Center Frequency(GHz) | - | | |
|----------|------------|-------------------|------------------|----------------------|----------------------------|------------|------------|------------|
| 8 | Type 5 | 14 | 0.857143 | 12 | 5.53 | | | |
| | Burst ID | Burst Offset (us) | Pulse Width (us) | Chirp Width (MHz) | Number of Pulses per Burst | PRI-1 (us) | PRI-2 (us) | PRI-3 (us) |
| | 0 | 823112 | 54.1 | 13 | 1 | 1415 | - | - |
| | 1 | 174965 | 50.7 | 13 | 1 | 1221 | - | - |
| | 2 | 382216 | 52.3 | 13 | 1 | 1974 | - | - |
| | 3 | 587395 | 99.8 | 13 | 3 | 1558 | 1696 | 1949 |
| | 4 | 796897 | 68.4 | 13 | 2 | 1014 | 1099 | - |
| | 5 | 149042 | 80.8 | 13 | 2 | 1736 | 1505 | - |
| | 6 | 356750 | 62.5 | 13 | 1 | 1778 | - | - |
| | 7 | 563824 | 74.8 | 13 | 2 | 1149 | 1204 | - |
| | 8 | 772314 | 50.8 | 13 | 1 | 1049 | - | - |
| | 9 | 123796 | 54 | 13 | 1 | 1417 | - | - |
| | 10 | 331215 | 63 | 13 | 1 | 1730 | - | - |
| | 11 | 537402 | 91.8 | 13 | 3 | 1143 | 1270 | 1347 |
| | 12 | 744805 | 79.3 | 13 | 2 | 1274 | 1992 | - |
| | 13 | 98172 | 64.3 | 13 | 1 | 1937 | - | - |
| 9 | Type 5 | 8 | 1.5 | 12 | 5.53 | | | |
| | Burst ID | Burst Offset (us) | Pulse Width (us) | Chirp Width (MHz) | Number of Pulses per Burst | PRI-1 (us) | PRI-2 (us) | PRI-3 (us) |
| | 0 | 535615 | 63.4 | 6 | 1 | 1043 | - | - |
| | 1 | 898668 | 52 | 6 | 1 | 1863 | - | - |
| | 2 | 1259235 | 97.2 | 6 | 3 | 1973 | 1605 | 1583 |
| | 3 | 127106 | 78.7 | 6 | 2 | 1466 | 1743 | - |
| | 4 | 490358 | 74.2 | 6 | 2 | 1280 | 1219 | - |
| | 5 | 852409 | 88.7 | 6 | 3 | 1293 | 1934 | 1273 |
| | 6 | 1217152 | 54.3 | 6 | 1 | 1991 | - | - |
| | 7 | 82296 | 95.4 | 6 | 3 | 1580 | 1555 | 1791 |

| Trial ID | Radar Type | Number of Bursts | Burst Period(s) | Wave from Length (s) | Center Frequency(GHz) | - | | |
|----------|------------|-------------------|------------------|----------------------|----------------------------|------------|------------|------------|
| 10 | Type 5 | 17 | 0.705882 | 12 | 5.4979 | | | |
| | Burst ID | Burst Offset (us) | Pulse Width (us) | Chirp Width (MHz) | Number of Pulses per Burst | PRI-1 (us) | PRI-2 (us) | PRI-3 (us) |
| | 0 | 209249 | 73.7 | 16 | 2 | 1208 | 1497 | - |
| | 1 | 378386 | 97.4 | 16 | 3 | 1942 | 1754 | 1613 |
| | 2 | 548411 | 91.7 | 16 | 3 | 1999 | 1702 | 1462 |
| | 3 | 17733 | 66.2 | 16 | 1 | 1393 | - | - |
| | 4 | 187952 | 70.8 | 16 | 2 | 1968 | 1821 | - |
| | 5 | 359277 | 52.3 | 16 | 1 | 1740 | - | - |
| | 6 | 528886 | 78.9 | 16 | 2 | 1308 | 1994 | - |
| | 7 | 700166 | 70.9 | 16 | 2 | 1050 | 1358 | - |
| | 8 | 167197 | 75.6 | 16 | 2 | 1437 | 1430 | - |
| | 9 | 338262 | 59.1 | 16 | 1 | 1697 | - | - |
| | 10 | 508324 | 77 | 16 | 2 | 1397 | 1304 | - |
| | 11 | 678689 | 67.9 | 16 | 2 | 1803 | 1083 | - |
| | 12 | 146031 | 81.2 | 16 | 2 | 1720 | 1932 | - |
| | 13 | 316923 | 78.7 | 16 | 2 | 1247 | 1121 | - |
| | 14 | 488056 | 63.3 | 16 | 1 | 1634 | - | - |
| | 15 | 657326 | 68.9 | 16 | 2 | 1849 | 1423 | - |
| | 16 | 125509 | 59.3 | 16 | 1 | 1093 | - | - |

| 11 | Type 5 | 19 | 0.631579 | 12 | 5.4991 | | | |
|----|----------|-------------------|------------------|-------------------|----------------------------|------------|------------|------------|
| | Burst ID | Burst Offset (us) | Pulse Width (us) | Chirp Width (MHz) | Number of Pulses per Burst | PRI-1 (us) | PRI-2 (us) | PRI-3 (us) |
| | 0 | 263736 | 98.9 | 19 | 3 | 1381 | 1680 | 1488 |
| | 1 | 416459 | 82.3 | 19 | 2 | 1716 | 1855 | - |
| | 2 | 567902 | 86.7 | 19 | 3 | 1211 | 1400 | 1919 |
| | 3 | 92979 | 89.7 | 19 | 3 | 1861 | 1068 | 1282 |
| | 4 | 245155 | 98.6 | 19 | 3 | 1507 | 1194 | 1461 |
| | 5 | 397609 | 71.1 | 19 | 2 | 1921 | 1789 | - |
| | 6 | 551431 | 55.9 | 19 | 1 | 1947 | - | - |
| | 7 | 74413 | 67.9 | 19 | 2 | 1350 | 1372 | - |
| | 8 | 226559 | 84.4 | 19 | 3 | 1203 | 1107 | 1443 |
| | 9 | 380056 | 58.8 | 19 | 1 | 1715 | - | - |
| | 10 | 533408 | 65.6 | 19 | 1 | 1017 | - | - |
| | 11 | 55547 | 78.5 | 19 | 2 | 1911 | 1704 | - |
| | 12 | 207876 | 82.3 | 19 | 2 | 1845 | 1686 | - |
| | 13 | 359771 | 90.1 | 19 | 3 | 1938 | 1071 | 1266 |
| | 14 | 511297 | 90.2 | 19 | 3 | 1989 | 1089 | 1950 |
| | 15 | 36803 | 83.1 | 19 | 2 | 1943 | 1406 | - |
| | 16 | 189852 | 58.8 | 19 | 1 | 1742 | - | - |
| | 17 | 341809 | 77 | 19 | 2 | 1187 | 1657 | - |
| | 18 | 495737 | 55 | 19 | 1 | 1012 | - | - |

| Trial ID | Radar Type | Number of Bursts | Burst Period(s) | Wave from Length (s) | Center Frequency(GHz) | - | | |
|----------|------------|-------------------|------------------|----------------------|----------------------------|------------|------------|------------|
| 12 | Type 5 | 15 | 0.8 | 12 | 5.4967 | | | |
| | Burst ID | Burst Offset (us) | Pulse Width (us) | Chirp Width (MHz) | Number of Pulses per Burst | PRI-1 (us) | PRI-2 (us) | PRI-3 (us) |
| | 0 | 22911 | 58.1 | 13 | 1 | 1929 | - | - |
| | 1 | 216473 | 52.1 | 13 | 1 | 1910 | - | - |
| | 2 | 410004 | 59.9 | 13 | 1 | 1971 | - | - |
| | 3 | 603671 | 60.2 | 13 | 1 | 1812 | - | - |
| | 4 | 794160 | 95.9 | 13 | 3 | 1399 | 1906 | 1608 |
| | 5 | 192251 | 79.9 | 13 | 2 | 1626 | 1859 | - |
| | 6 | 385590 | 78.5 | 13 | 2 | 1238 | 1917 | - |
| | 7 | 579862 | 53.8 | 13 | 1 | 1763 | - | - |
| | 8 | 773423 | 64.7 | 13 | 1 | 1800 | - | - |
| | 9 | 168898 | 61.4 | 13 | 1 | 1390 | - | - |
| | 10 | 361606 | 83.2 | 13 | 2 | 1692 | 1858 | - |
| | 11 | 553866 | 84.7 | 13 | 3 | 1533 | 1677 | 1638 |
| | 12 | 747241 | 88.7 | 13 | 3 | 1703 | 1528 | 1058 |
| | 13 | 144710 | 78.3 | 13 | 2 | 1258 | 1951 | - |
| | 14 | 337856 | 69.3 | 13 | 2 | 1731 | 1717 | - |
| 13 | Type 5 | 12 | 1 | 12 | 5.4955 | | | |
| | Burst ID | Burst Offset (us) | Pulse Width (us) | Chirp Width (MHz) | Number of Pulses per Burst | PRI-1 (us) | PRI-2 (us) | PRI-3 (us) |
| | 0 | 664275 | 75.3 | 10 | 2 | 1994 | 1612 | - |
| | 1 | 907886 | 56.3 | 10 | 1 | 1456 | - | - |
| | 2 | 151316 | 67.7 | 10 | 2 | 1617 | 1185 | - |
| | 3 | 393746 | 55.6 | 10 | 1 | 1337 | - | - |
| | 4 | 635093 | 75.2 | 10 | 2 | 1421 | 1267 | - |
| | 5 | 876993 | 76.3 | 10 | 2 | 1359 | 1305 | - |
| | 6 | 121278 | 85.7 | 10 | 3 | 1547 | 1362 | 1924 |
| | 7 | 362696 | 98.4 | 10 | 3 | 1873 | 1550 | 1249 |
| | 8 | 604342 | 86.4 | 10 | 3 | 1779 | 1439 | 1046 |
| | 9 | 846453 | 93.6 | 10 | 3 | 1059 | 1031 | 1452 |
| | 10 | 91871 | 63.3 | 10 | 1 | 1328 | - | - |
| | 11 | 333050 | 92.4 | 10 | 3 | 1412 | 1673 | 1322 |

| Trial ID | Radar Type | Number of Bursts | Burst Period(s) | Wave from Length (s) | Center Frequency(GHz) | - | | |
|----------|------------|-------------------|------------------|----------------------|----------------------------|------------|------------|------------|
| 14 | Type 5 | 19 | 0.631579 | 12 | 5.4987 | | | |
| | Burst ID | Burst Offset (us) | Pulse Width (us) | Chirp Width (MHz) | Number of Pulses per Burst | PRI-1 (us) | PRI-2 (us) | PRI-3 (us) |
| | 0 | 361323 | 93.3 | 18 | 3 | 1983 | 1912 | 1535 |
| | 1 | 515261 | 69.1 | 18 | 2 | 1102 | 1794 | - |
| | 2 | 39025 | 86.9 | 18 | 3 | 1044 | 1152 | 1148 |
| | 3 | 190900 | 84.9 | 18 | 3 | 1894 | 1948 | 1118 |
| | 4 | 343941 | 72.3 | 18 | 2 | 1094 | 1916 | - |
| | 5 | 497624 | 51.7 | 18 | 1 | 1447 | - | - |
| | 6 | 20319 | 58.3 | 18 | 1 | 1429 | - | - |
| | 7 | 172999 | 60.8 | 18 | 1 | 1979 | - | - |
| | 8 | 325872 | 57.1 | 18 | 1 | 1641 | - | - |
| | 9 | 475841 | 88.9 | 18 | 3 | 1886 | 1964 | 1489 |
| | 10 | 1489 | 72 | 18 | 2 | 1909 | 1297 | - |
| | 11 | 153647 | 90.9 | 18 | 3 | 1261 | 1566 | 1370 |
| | 12 | 307096 | 59.8 | 18 | 1 | 1552 | - | - |
| | 13 | 458804 | 70 | 18 | 2 | 1759 | 1291 | - |
| | 14 | 610798 | 67.2 | 18 | 2 | 1625 | 1881 | - |
| | 15 | 134759 | 91.2 | 18 | 3 | 1382 | 1832 | 1661 |
| | 16 | 288306 | 56.5 | 18 | 1 | 1483 | - | - |
| | 17 | 441296 | 51.2 | 18 | 1 | 1237 | - | - |
| | 18 | 592780 | 74.1 | 18 | 2 | 1471 | 1245 | - |

| 15 | Type 5 | 14 | 0.857143 | 12 | 5.4983 | | | |
|----|----------|-------------------|------------------|-------------------|----------------------------|------------|------------|------------|
| | Burst ID | Burst Offset (us) | Pulse Width (us) | Chirp Width (MHz) | Number of Pulses per Burst | PRI-1 (us) | PRI-2 (us) | PRI-3 (us) |
| | 0 | 158286 | 76.9 | 12 | 2 | 1110 | 1140 | - |
| | 1 | 366024 | 50.2 | 12 | 1 | 1316 | - | - |
| | 2 | 573452 | 62.9 | 12 | 1 | 1520 | - | - |
| | 3 | 780619 | 64.7 | 12 | 1 | 1902 | - | - |
| | 4 | 132455 | 83.8 | 12 | 3 | 1410 | 1097 | 1621 |
| | 5 | 340207 | 65.4 | 12 | 1 | 1944 | - | - |
| | 6 | 548208 | 53.2 | 12 | 1 | 1024 | - | - |
| | 7 | 755333 | 51.7 | 12 | 1 | 1603 | - | - |
| | 8 | 107117 | 78.7 | 12 | 2 | 1804 | 1168 | - |
| | 9 | 314500 | 72.4 | 12 | 2 | 1030 | 1343 | - |
| | 10 | 522447 | 53.8 | 12 | 1 | 1327 | - | - |
| | 11 | 728517 | 73.6 | 12 | 2 | 1524 | 1553 | - |
| | 12 | 81611 | 66.7 | 12 | 2 | 1722 | 1122 | - |
| | 13 | 288948 | 82.5 | 12 | 2 | 1404 | 1019 | - |

| Trial ID | Radar Type | Number of Bursts | Burst Period(s) | Wave from Length (s) | Center Frequency(GHz) | - | | |
|----------|------------|-------------------|------------------|----------------------|----------------------------|------------|------------|------------|
| 16 | Type 5 | 20 | 0.6 | 12 | 5.4995 | | | |
| | Burst ID | Burst Offset (us) | Pulse Width (us) | Chirp Width (MHz) | Number of Pulses per Burst | PRI-1 (us) | PRI-2 (us) | PRI-3 (us) |
| | 0 | 345766 | 87.6 | 20 | 3 | 1565 | 1055 | 1840 |
| | 1 | 490019 | 85.2 | 20 | 3 | 1735 | 1541 | 1408 |
| | 2 | 39073 | 84.8 | 20 | 3 | 1534 | 1889 | 1463 |
| | 3 | 183923 | 77.9 | 20 | 2 | 1749 | 1460 | - |
| | 4 | 328777 | 76.5 | 20 | 2 | 1518 | 1485 | - |
| | 5 | 474728 | 60.9 | 20 | 1 | 1540 | - | - |
| | 6 | 21394 | 83 | 20 | 2 | 1080 | 1010 | - |
| | 7 | 165992 | 80.4 | 20 | 2 | 1824 | 1752 | - |
| | 8 | 310973 | 67.5 | 20 | 2 | 1764 | 1181 | - |
| | 9 | 456884 | 62.1 | 20 | 1 | 1495 | - | - |
| | 10 | 3515 | 86.4 | 20 | 3 | 1773 | 1966 | 1263 |
| | 11 | 147928 | 84.3 | 20 | 3 | 1593 | 1188 | 1788 |
| | 12 | 293225 | 76.9 | 20 | 2 | 1226 | 1537 | - |
| | 13 | 438922 | 95.8 | 20 | 3 | 1192 | 1298 | 1844 |
| | 14 | 584015 | 55.2 | 20 | 1 | 1644 | - | - |
| | 15 | 130832 | 59 | 20 | 1 | 1402 | - | - |
| | 16 | 274684 | 94.5 | 20 | 3 | 1296 | 1700 | 1283 |
| | 17 | 418579 | 91.9 | 20 | 3 | 1970 | 1978 | 1165 |
| | 18 | 563464 | 85.2 | 20 | 3 | 1732 | 1551 | 1189 |
| | 19 | 112787 | 69.5 | 20 | 2 | 1038 | 1224 | - |

| | | | | | | | | |
|----|----------|-------------------|------------------|-------------------|----------------------------|------------|------------|------------|
| 17 | Type 5 | 12 | 1 | 12 | 5.4955 | | | |
| | Burst ID | Burst Offset (us) | Pulse Width (us) | Chirp Width (MHz) | Number of Pulses per Burst | PRI-1 (us) | PRI-2 (us) | PRI-3 (us) |
| | 0 | 429224 | 86.4 | 10 | 3 | 1259 | 1918 | 1455 |
| | 1 | 670241 | 92.2 | 10 | 3 | 1598 | 1719 | 1895 |
| | 2 | 912880 | 80.4 | 10 | 2 | 1816 | 1899 | - |
| | 3 | 158603 | 54.3 | 10 | 1 | 1335 | - | - |
| | 4 | 400824 | 53.1 | 10 | 1 | 1303 | - | - |
| | 5 | 641915 | 69.4 | 10 | 2 | 1503 | 1546 | - |
| | 6 | 883823 | 69.1 | 10 | 2 | 1279 | 1639 | - |
| | 7 | 128373 | 100 | 10 | 3 | 1375 | 1438 | 1595 |
| | 8 | 370379 | 79.6 | 10 | 2 | 1239 | 1705 | - |
| | 9 | 611194 | 88.4 | 10 | 3 | 1374 | 1579 | 1623 |
| | 10 | 855665 | 53.3 | 10 | 1 | 1016 | - | - |
| | 11 | 98897 | 65.3 | 10 | 1 | 1709 | - | - |

| Trial ID | Radar Type | Number of Bursts | Burst Period(s) | Wave from Length (s) | Center Frequency(GHz) | - | | |
|----------|------------|-------------------|------------------|----------------------|----------------------------|------------|------------|------------|
| 18 | Type 5 | 14 | 0.857143 | 12 | 5.4963 | | | |
| | Burst ID | Burst Offset (us) | Pulse Width (us) | Chirp Width (MHz) | Number of Pulses per Burst | PRI-1 (us) | PRI-2 (us) | PRI-3 (us) |
| | 0 | 292143 | 55.3 | 12 | 1 | 1920 | - | - |
| | 1 | 499633 | 58.3 | 12 | 1 | 1797 | - | - |
| | 2 | 706377 | 72.3 | 12 | 2 | 1610 | 1039 | - |
| | 3 | 58989 | 84.8 | 12 | 3 | 1131 | 1761 | 1721 |
| | 4 | 266161 | 82.5 | 12 | 2 | 1875 | 1431 | - |
| | 5 | 474469 | 63.3 | 12 | 1 | 1095 | - | - |
| | 6 | 680544 | 80 | 12 | 2 | 1119 | 1913 | - |
| | 7 | 33519 | 90.3 | 12 | 3 | 1660 | 1853 | 1123 |
| | 8 | 240319 | 91.1 | 12 | 3 | 1539 | 1783 | 1172 |
| | 9 | 447400 | 96.6 | 12 | 3 | 1525 | 1036 | 1385 |
| | 10 | 654516 | 82.7 | 12 | 2 | 1710 | 1990 | - |
| | 11 | 8083 | 50.7 | 12 | 1 | 1234 | - | - |
| | 12 | 215435 | 78.4 | 12 | 2 | 1047 | 1109 | - |
| | 13 | 421325 | 99.5 | 12 | 3 | 1299 | 1965 | 1869 |
| 19 | Type 5 | 12 | 1 | 12 | 5.4955 | | | |
| | Burst ID | Burst Offset (us) | Pulse Width (us) | Chirp Width (MHz) | Number of Pulses per Burst | PRI-1 (us) | PRI-2 (us) | PRI-3 (us) |
| | 0 | 733725 | 88.6 | 10 | 3 | 1501 | 1067 | 1927 |
| | 1 | 977882 | 57.4 | 10 | 1 | 1723 | - | - |
| | 2 | 221197 | 96.6 | 10 | 3 | 1086 | 1658 | 1324 |
| | 3 | 462915 | 69.7 | 10 | 2 | 1751 | 1945 | - |
| | 4 | 705071 | 77.9 | 10 | 2 | 1642 | 1317 | - |
| | 5 | 947923 | 62 | 10 | 1 | 1866 | - | - |
| | 6 | 191373 | 88.4 | 10 | 3 | 1997 | 1077 | 1366 |
| | 7 | 432561 | 97.3 | 10 | 3 | 1790 | 1896 | 1367 |
| | 8 | 674004 | 96.2 | 10 | 3 | 1391 | 1787 | 1672 |
| | 9 | 915842 | 95.4 | 10 | 3 | 1020 | 1892 | 1414 |
| | 10 | 162176 | 54.8 | 10 | 1 | 1084 | - | - |
| | 11 | 403553 | 80.4 | 10 | 2 | 1850 | 1436 | - |

| Trial ID | Radar Type | Number of Bursts | Burst Period(s) | Wave from Length (s) | Center Frequency(GHz) | - | | |
|----------|------------|-------------------|------------------|----------------------|----------------------------|------------|------------|------------|
| 20 | Type 5 | 16 | 0.75 | 12 | 5.5625 | | | |
| | Burst ID | Burst Offset (us) | Pulse Width (us) | Chirp Width (MHz) | Number of Pulses per Burst | PRI-1 (us) | PRI-2 (us) | PRI-3 (us) |
| | 0 | 483470 | 74.7 | 15 | 2 | 1619 | 1611 | - |
| | 1 | 666072 | 57.1 | 15 | 1 | 1560 | - | - |
| | 2 | 98810 | 91.9 | 15 | 3 | 1392 | 1475 | 1276 |
| | 3 | 279914 | 83.1 | 15 | 2 | 1809 | 1772 | - |
| | 4 | 462536 | 50.7 | 15 | 1 | 1003 | - | - |
| | 5 | 642324 | 79.2 | 15 | 2 | 1574 | 1600 | - |
| | 6 | 76831 | 58.7 | 15 | 1 | 1186 | - | - |
| | 7 | 257785 | 71 | 15 | 2 | 1521 | 1567 | - |
| | 8 | 438554 | 79 | 15 | 2 | 1777 | 1960 | - |
| | 9 | 620397 | 68.5 | 15 | 2 | 1284 | 1428 | - |
| | 10 | 54310 | 73.5 | 15 | 2 | 1904 | 1352 | - |
| | 11 | 235506 | 70.5 | 15 | 2 | 1864 | 1115 | - |
| | 12 | 417036 | 76.6 | 15 | 2 | 1045 | 1300 | - |
| | 13 | 597974 | 81.2 | 15 | 2 | 1160 | 1675 | - |
| | 14 | 32086 | 61.8 | 15 | 1 | 1277 | - | - |
| | 15 | 212751 | 94.9 | 15 | 3 | 1450 | 1206 | 1860 |
| 21 | Type 5 | 12 | 1 | 12 | 5.5649 | | | |
| | Burst ID | Burst Offset (us) | Pulse Width (us) | Chirp Width (MHz) | Number of Pulses per Burst | PRI-1 (us) | PRI-2 (us) | PRI-3 (us) |
| | 0 | 526149 | 78.5 | 9 | 2 | 1653 | 1698 | - |
| | 1 | 767135 | 89.8 | 9 | 3 | 1174 | 1962 | 1167 |
| | 2 | 12955 | 59.4 | 9 | 1 | 1982 | - | - |
| | 3 | 254612 | 79.6 | 9 | 2 | 1633 | 1890 | - |
| | 4 | 496588 | 76 | 9 | 2 | 1112 | 1811 | - |
| | 5 | 739728 | 53.6 | 9 | 1 | 1144 | - | - |
| | 6 | 980872 | 80.9 | 9 | 2 | 1220 | 1053 | - |
| | 7 | 225249 | 61.6 | 9 | 1 | 1724 | - | - |
| | 8 | 467279 | 53.4 | 9 | 1 | 1901 | - | - |
| | 9 | 709720 | 59.9 | 9 | 1 | 1379 | - | - |
| | 10 | 951847 | 60.4 | 9 | 1 | 1453 | - | - |
| | 11 | 194839 | 91.4 | 9 | 3 | 1768 | 1726 | 1227 |

| Trial ID | Radar Type | Number of Bursts | Burst Period(s) | Wave from Length (s) | Center Frequency(GHz) | - | | |
|----------|------------|-------------------|------------------|----------------------|----------------------------|------------|------------|------------|
| 22 | Type 5 | 20 | 0.8 | 12 | 5.5605 | | | |
| | Burst ID | Burst Offset (us) | Pulse Width (us) | Chirp Width (MHz) | Number of Pulses per Burst | PRI-1 (us) | PRI-2 (us) | PRI-3 (us) |
| | 0 | 261858 | 77 | 20 | 2 | 1191 | 1363 | - |
| | 1 | 407646 | 58.1 | 20 | 1 | 1248 | - | - |
| | 2 | 552319 | 62.1 | 20 | 1 | 1836 | - | - |
| | 3 | 99107 | 76.9 | 20 | 2 | 1334 | 1236 | - |
| | 4 | 243514 | 80 | 20 | 2 | 1914 | 1852 | - |
| | 5 | 389464 | 52 | 20 | 1 | 1701 | - | - |
| | 6 | 531093 | 88.6 | 20 | 3 | 1693 | 1995 | 1905 |
| | 7 | 81159 | 72.9 | 20 | 2 | 1922 | 1387 | - |
| | 8 | 225245 | 98.5 | 20 | 3 | 1839 | 1746 | 1389 |
| | 9 | 371906 | 57.9 | 20 | 1 | 1193 | - | - |
| | 10 | 514197 | 95.9 | 20 | 3 | 1659 | 1870 | 1066 |
| | 11 | 63561 | 53.5 | 20 | 1 | 1162 | - | - |
| | 12 | 207510 | 92 | 20 | 3 | 1745 | 1654 | 1458 |
| | 13 | 353638 | 57.3 | 20 | 1 | 1834 | - | - |
| | 14 | 497515 | 70.5 | 20 | 2 | 1684 | 1586 | - |
| | 15 | 45553 | 70 | 20 | 2 | 1042 | 1664 | - |
| | 16 | 189821 | 84 | 20 | 3 | 1765 | 1630 | 1176 |
| | 17 | 335330 | 76.1 | 20 | 2 | 1557 | 1057 | - |
| | 18 | 478825 | 93.2 | 20 | 3 | 1985 | 1018 | 1340 |
| | 19 | 27594 | 96.8 | 20 | 3 | 1760 | 1614 | 1817 |
| 23 | Type 5 | 14 | 0.857143 | 12 | 5.5637 | | | |
| | Burst ID | Burst Offset (us) | Pulse Width (us) | Chirp Width (MHz) | Number of Pulses per Burst | PRI-1 (us) | PRI-2 (us) | PRI-3 (us) |
| | 0 | 247117 | 50.1 | 12 | 1 | 1841 | - | - |
| | 1 | 453362 | 93.5 | 12 | 3 | 1590 | 1081 | 1413 |
| | 2 | 660875 | 68.8 | 12 | 2 | 1707 | 1577 | - |
| | 3 | 14140 | 56.3 | 12 | 1 | 1056 | - | - |
| | 4 | 220734 | 86 | 12 | 3 | 1953 | 1108 | 1987 |
| | 5 | 428367 | 75.2 | 12 | 2 | 1572 | 1536 | - |
| | 6 | 636681 | 54.4 | 12 | 1 | 1517 | - | - |
| | 7 | 843157 | 71.1 | 12 | 2 | 1329 | 1243 | - |
| | 8 | 195585 | 76.2 | 12 | 2 | 1040 | 1770 | - |
| | 9 | 403231 | 80.2 | 12 | 2 | 1098 | 1209 | - |
| | 10 | 610202 | 79.7 | 12 | 2 | 1588 | 1214 | - |
| | 11 | 815229 | 90.9 | 12 | 3 | 1615 | 1862 | 1601 |
| | 12 | 170267 | 68.7 | 12 | 2 | 1377 | 1441 | - |
| | 13 | 377306 | 67.4 | 12 | 2 | 1872 | 1313 | - |

| Trial ID | Radar Type | Number of Bursts | Burst Period(s) | Wave from Length (s) | Center Frequency(GHz) | - | | |
|----------|------------|-------------------|------------------|----------------------|----------------------------|------------|------------|------------|
| 24 | Type 5 | 13 | 0.923077 | 12 | 5.5641 | | | |
| | Burst ID | Burst Offset (us) | Pulse Width (us) | Chirp Width (MHz) | Number of Pulses per Burst | PRI-1 (us) | PRI-2 (us) | PRI-3 (us) |
| | 0 | 628071 | 94 | 11 | 3 | 1643 | 1748 | 1941 |
| | 1 | 853391 | 70.8 | 11 | 2 | 1177 | 1201 | - |
| | 2 | 156223 | 56.3 | 11 | 1 | 1006 | - | - |
| | 3 | 378734 | 96.7 | 11 | 3 | 1230 | 1163 | 1332 |
| | 4 | 601331 | 90.6 | 11 | 3 | 1217 | 1582 | 1498 |
| | 5 | 825462 | 74.5 | 11 | 2 | 1569 | 1281 | - |
| | 6 | 128265 | 92.6 | 11 | 3 | 1065 | 1669 | 1222 |
| | 7 | 351161 | 89 | 11 | 3 | 1493 | 1135 | 1380 |
| | 8 | 573425 | 96.5 | 11 | 3 | 1607 | 1822 | 1602 |
| | 9 | 798431 | 70.5 | 11 | 2 | 1141 | 1178 | - |
| | 10 | 100737 | 94 | 11 | 3 | 1009 | 1629 | 1956 |
| | 11 | 324661 | 55.8 | 11 | 1 | 1290 | - | - |
| | 12 | 546278 | 87.7 | 11 | 3 | 1435 | 1963 | 1164 |
| 25 | Type 5 | 8 | 1.5 | 12 | 5.5665 | | | |
| | Burst ID | Burst Offset (us) | Pulse Width (us) | Chirp Width (MHz) | Number of Pulses per Burst | PRI-1 (us) | PRI-2 (us) | PRI-3 (us) |
| | 0 | 1253842 | 68.6 | 5 | 2 | 1306 | 1161 | - |
| | 1 | 119486 | 83.1 | 5 | 2 | 1420 | 1315 | - |
| | 2 | 482958 | 60.9 | 5 | 1 | 1687 | - | - |
| | 3 | 845641 | 77.7 | 5 | 2 | 1776 | 1158 | - |
| | 4 | 1208428 | 77.4 | 5 | 2 | 1793 | 1510 | - |
| | 5 | 74748 | 66.8 | 5 | 2 | 1576 | 1323 | - |
| | 6 | 438300 | 63.7 | 5 | 1 | 1333 | - | - |
| | 7 | 800152 | 91.2 | 5 | 3 | 1409 | 1681 | 1275 |

| Trial ID | Radar Type | Number of Bursts | Burst Period(s) | Wave from Length (s) | Center Frequency(GHz) | - | | |
|----------|------------|-------------------|------------------|----------------------|----------------------------|------------|------------|------------|
| 26 | Type 5 | 17 | 0.705882 | 12 | 5.5621 | | | |
| | Burst ID | Burst Offset (us) | Pulse Width (us) | Chirp Width (MHz) | Number of Pulses per Burst | PRI-1 (us) | PRI-2 (us) | PRI-3 (us) |
| | 0 | 545865 | 83.6 | 16 | 3 | 1632 | 1195 | 1000 |
| | 1 | 14067 | 89.4 | 16 | 3 | 1173 | 1627 | 1656 |
| | 2 | 184953 | 55.8 | 16 | 1 | 1532 | - | - |
| | 3 | 353759 | 90.9 | 16 | 3 | 1981 | 1554 | 1998 |
| | 4 | 526388 | 54.7 | 16 | 1 | 1825 | - | - |
| | 5 | 694806 | 97.7 | 16 | 3 | 1734 | 1202 | 1250 |
| | 6 | 163568 | 67.5 | 16 | 2 | 1571 | 1434 | - |
| | 7 | 333410 | 96.7 | 16 | 3 | 1589 | 1469 | 1268 |
| | 8 | 504006 | 68.3 | 16 | 2 | 1750 | 1954 | - |
| | 9 | 675297 | 78.3 | 16 | 2 | 1591 | 1082 | - |
| | 10 | 142890 | 55 | 16 | 1 | 1427 | - | - |
| | 11 | 312479 | 84.9 | 16 | 3 | 1129 | 1936 | 1199 |
| | 12 | 482953 | 74.6 | 16 | 2 | 1959 | 1856 | - |
| | 13 | 655022 | 63.3 | 16 | 1 | 1885 | - | - |
| | 14 | 121457 | 99.8 | 16 | 3 | 1035 | 1515 | 1120 |
| | 15 | 292606 | 63.6 | 16 | 1 | 1647 | - | - |
| | 16 | 461322 | 87.3 | 16 | 3 | 1931 | 1051 | 1831 |

| Trial ID | Radar Type | Number of Bursts | Burst Period(s) | Wave from Length (s) | Center Frequency(GHz) | - | | |
|----------|------------|-------------------|------------------|----------------------|----------------------------|------------|------------|------------|
| 27 | Type 5 | 19 | 0.631579 | 12 | 5.5609 | | | |
| | Burst ID | Burst Offset (us) | Pulse Width (us) | Chirp Width (MHz) | Number of Pulses per Burst | PRI-1 (us) | PRI-2 (us) | PRI-3 (us) |
| | 0 | 565136 | 85.6 | 19 | 3 | 1946 | 1078 | 1015 |
| | 1 | 89970 | 68.6 | 19 | 2 | 1029 | 1780 | - |
| | 2 | 243121 | 54.2 | 19 | 1 | 1111 | - | - |
| | 3 | 396034 | 61.2 | 19 | 1 | 1104 | - | - |
| | 4 | 546225 | 97.1 | 19 | 3 | 1157 | 1969 | 1100 |
| | 5 | 70998 | 98.3 | 19 | 3 | 1142 | 1699 | 1622 |
| | 6 | 224093 | 62.4 | 19 | 1 | 1655 | - | - |
| | 7 | 376127 | 80.2 | 19 | 2 | 1126 | 1769 | - |
| | 8 | 527806 | 87.5 | 19 | 3 | 1216 | 1448 | 1179 |
| | 9 | 52247 | 85.8 | 19 | 3 | 1847 | 1348 | 1472 |
| | 10 | 204582 | 88.1 | 19 | 3 | 1023 | 1124 | 1631 |
| | 11 | 357941 | 65.3 | 19 | 1 | 1848 | - | - |
| | 12 | 510977 | 52.5 | 19 | 1 | 1470 | - | - |
| | 13 | 33698 | 52.3 | 19 | 1 | 1312 | - | - |
| | 14 | 186023 | 74.1 | 19 | 2 | 1915 | 1200 | - |
| | 15 | 339327 | 54.9 | 19 | 1 | 1479 | - | - |
| | 16 | 491053 | 76.2 | 19 | 2 | 1376 | 1502 | - |
| | 17 | 14858 | 60.4 | 19 | 1 | 1758 | - | - |
| | 18 | 167387 | 81.5 | 19 | 2 | 1491 | 1103 | - |

| 28 | Type 5 | 12 | 1 | 12 | 5.5645 | | | |
|----|----------|-------------------|------------------|-------------------|----------------------------|------------|------------|------------|
| | Burst ID | Burst Offset (us) | Pulse Width (us) | Chirp Width (MHz) | Number of Pulses per Burst | PRI-1 (us) | PRI-2 (us) | PRI-3 (us) |
| | 0 | 507709 | 50.5 | 10 | 1 | 1857 | - | - |
| | 1 | 750249 | 55.7 | 10 | 1 | 1246 | - | - |
| | 2 | 989003 | 85.8 | 10 | 3 | 1774 | 1002 | 1967 |
| | 3 | 235634 | 76.9 | 10 | 2 | 1125 | 1474 | - |
| | 4 | 477675 | 75.1 | 10 | 2 | 1254 | 1052 | - |
| | 5 | 718312 | 92.3 | 10 | 3 | 1180 | 1486 | 1492 |
| | 6 | 960895 | 78.1 | 10 | 2 | 1301 | 1757 | - |
| | 7 | 205370 | 92.2 | 10 | 3 | 1898 | 1252 | 1713 |
| | 8 | 446940 | 89 | 10 | 3 | 1260 | 1706 | 1411 |
| | 9 | 689225 | 70.9 | 10 | 2 | 1578 | 1620 | - |
| | 10 | 932305 | 63.1 | 10 | 1 | 1782 | - | - |
| | 11 | 176231 | 55.3 | 10 | 1 | 1522 | - | - |

| Trial ID | Radar Type | Number of Bursts | Burst Period(s) | Wave from Length (s) | Center Frequency(GHz) | - | | |
|----------|------------|-------------------|------------------|----------------------|----------------------------|------------|------------|------------|
| 29 | Type 5 | 18 | 0.686667 | 12 | 5.5617 | | | |
| | Burst ID | Burst Offset (us) | Pulse Width (us) | Chirp Width (MHz) | Number of Pulses per Burst | PRI-1 (us) | PRI-2 (us) | PRI-3 (us) |
| | 0 | 277485 | 83.4 | 17 | 3 | 1454 | 1205 | 1801 |
| | 1 | 437880 | 97.3 | 17 | 3 | 1319 | 1826 | 1635 |
| | 2 | 598445 | 90.4 | 17 | 3 | 1079 | 1986 | 1674 |
| | 3 | 97088 | 91.8 | 17 | 3 | 1563 | 1151 | 1802 |
| | 4 | 257251 | 98.2 | 17 | 3 | 1876 | 1977 | 1766 |
| | 5 | 419893 | 59.5 | 17 | 1 | 1952 | - | - |
| | 6 | 580724 | 80 | 17 | 2 | 1253 | 1137 | - |
| | 7 | 77366 | 86.5 | 17 | 3 | 1054 | 1128 | 1828 |
| | 8 | 238032 | 91.1 | 17 | 3 | 1105 | 1599 | 1442 |
| | 9 | 399605 | 93.5 | 17 | 3 | 1867 | 1373 | 1087 |
| | 10 | 562025 | 60.7 | 17 | 1 | 1033 | - | - |
| | 11 | 57684 | 67.2 | 17 | 2 | 1288 | 1405 | - |
| | 12 | 219083 | 61.8 | 17 | 1 | 1585 | - | - |
| | 13 | 379234 | 79.4 | 17 | 2 | 1933 | 1667 | - |
| | 14 | 540896 | 81.4 | 17 | 2 | 1096 | 1464 | - |
| | 15 | 37916 | 65.7 | 17 | 1 | 1496 | - | - |
| | 16 | 198794 | 76 | 17 | 2 | 1733 | 1255 | - |
| | 17 | 359754 | 81 | 17 | 2 | 1326 | 1668 | - |

Radar Singal 5_5540MHz

| Trial ID | Radar Type | Number of Bursts | Burst Period(s) | Wave from Length (s) | Center Frequency(GHz) | - | | |
|----------|------------|-------------------|------------------|----------------------|----------------------------|------------|------------|------------|
| 0 | Type 5 | 15 | 0.8 | 12 | 5.54 | | | |
| | Burst ID | Burst Offset (us) | Pulse Width (us) | Chirp Width (MHz) | Number of Pulses per Burst | PRI-1 (us) | PRI-2 (us) | PRI-3 (us) |
| | 0 | 636185 | 77.8 | 13 | 2 | 1665 | 1477 | - |
| | 1 | 32674 | 51.9 | 13 | 1 | 1074 | - | - |
| | 2 | 226294 | 63.8 | 13 | 1 | 1584 | - | - |
| | 3 | 417976 | 96.6 | 13 | 3 | 1682 | 1786 | 1843 |
| | 4 | 611152 | 85.9 | 13 | 3 | 1795 | 1215 | 1729 |
| | 5 | 8789 | 73.7 | 13 | 2 | 1198 | 1549 | - |
| | 6 | 201917 | 77.2 | 13 | 2 | 1837 | 1819 | - |
| | 7 | 395530 | 68.4 | 13 | 2 | 1587 | 1114 | - |
| | 8 | 588564 | 76.7 | 13 | 2 | 2000 | 1155 | - |
| | 9 | 783794 | 53.2 | 13 | 1 | 1147 | - | - |
| | 10 | 177933 | 85.7 | 13 | 3 | 1433 | 1695 | 1394 |
| | 11 | 370624 | 94.3 | 13 | 3 | 1670 | 1426 | 1935 |
| | 12 | 564893 | 77.6 | 13 | 2 | 1294 | 1671 | - |
| | 13 | 759583 | 65.7 | 13 | 1 | 1512 | - | - |
| | 14 | 154262 | 93.5 | 13 | 3 | 1444 | 1130 | 1488 |
| 1 | Type 5 | 8 | 1.5 | 12 | 5.54 | | | |
| | Burst ID | Burst Offset (us) | Pulse Width (us) | Chirp Width (MHz) | Number of Pulses per Burst | PRI-1 (us) | PRI-2 (us) | PRI-3 (us) |
| | 0 | 653020 | 75 | 5 | 2 | 1880 | 1527 | - |
| | 1 | 1015643 | 99.4 | 5 | 3 | 1401 | 1262 | 1257 |
| | 2 | 1379398 | 67.4 | 5 | 2 | 1531 | 1403 | - |
| | 3 | 245489 | 73.6 | 5 | 2 | 1449 | 1041 | - |
| | 4 | 609113 | 65.9 | 5 | 1 | 1432 | - | - |
| | 5 | 970852 | 83.8 | 5 | 3 | 1356 | 1292 | 1419 |
| | 6 | 1335913 | 65.5 | 5 | 1 | 1543 | - | - |
| | 7 | 200406 | 98.6 | 5 | 3 | 1548 | 1796 | 1728 |

| Trial ID | Radar Type | Number of Bursts | Burst Period(s) | Wave from Length (s) | Center Frequency(GHz) | - | | |
|----------|------------|-------------------|------------------|----------------------|----------------------------|------------|------------|------------|
| 2 | Type 5 | 11 | 1.090909 | 12 | 5.54 | | | |
| | Burst ID | Burst Offset (us) | Pulse Width (us) | Chirp Width (MHz) | Number of Pulses per Burst | PRI-1 (us) | PRI-2 (us) | PRI-3 (us) |
| | 0 | 409565 | 73.8 | 9 | 2 | 1806 | 1538 | - |
| | 1 | 673692 | 69.5 | 9 | 2 | 1117 | 1649 | - |
| | 2 | 938562 | 51.9 | 9 | 1 | 1651 | - | - |
| | 3 | 113209 | 84.6 | 9 | 3 | 1976 | 1032 | 1271 |
| | 4 | 376726 | 95.4 | 9 | 3 | 1060 | 1903 | 1388 |
| | 5 | 641212 | 68 | 9 | 2 | 1368 | 1351 | - |
| | 6 | 903714 | 89.6 | 9 | 3 | 1338 | 1514 | 1573 |
| | 7 | 80863 | 81.9 | 9 | 2 | 1022 | 1689 | - |
| | 8 | 344067 | 88.3 | 9 | 3 | 1810 | 1330 | 1838 |
| | 9 | 609331 | 53.7 | 9 | 1 | 1597 | - | - |
| | 10 | 871542 | 91.3 | 9 | 3 | 1961 | 1106 | 1001 |
| 3 | Type 5 | 20 | 0.6 | 12 | 5.54 | | | |
| | Burst ID | Burst Offset (us) | Pulse Width (us) | Chirp Width (MHz) | Number of Pulses per Burst | PRI-1 (us) | PRI-2 (us) | PRI-3 (us) |
| | 0 | 26541 | 68.1 | 19 | 2 | 1339 | 1355 | - |
| | 1 | 171821 | 58.7 | 19 | 1 | 1251 | - | - |
| | 2 | 316229 | 75.3 | 19 | 2 | 1136 | 1640 | - |
| | 3 | 461864 | 56.4 | 19 | 1 | 1753 | - | - |
| | 4 | 8677 | 99.7 | 19 | 3 | 1196 | 1708 | 1159 |
| | 5 | 153995 | 57.7 | 19 | 1 | 1013 | - | - |
| | 6 | 299238 | 59.5 | 19 | 1 | 1072 | - | - |
| | 7 | 443177 | 80 | 19 | 2 | 1482 | 1369 | - |
| | 8 | 587671 | 82 | 19 | 2 | 1993 | 1197 | - |
| | 9 | 135674 | 82.8 | 19 | 2 | 1883 | 1005 | - |
| | 10 | 279928 | 88 | 19 | 3 | 1061 | 1928 | 1101 |
| | 11 | 424279 | 93.2 | 19 | 3 | 1207 | 1907 | 1223 |
| | 12 | 570132 | 70.4 | 19 | 2 | 1526 | 1360 | - |
| | 13 | 117439 | 95.3 | 19 | 3 | 1171 | 1955 | 1775 |
| | 14 | 262502 | 81.9 | 19 | 2 | 1690 | 1545 | - |
| | 15 | 408573 | 98.5 | 19 | 3 | 1975 | 1169 | 1062 |
| | 16 | 553328 | 65 | 19 | 1 | 1767 | - | - |
| | 17 | 99799 | 85.4 | 19 | 3 | 1011 | 1637 | 1425 |
| | 18 | 244095 | 91.6 | 19 | 3 | 1878 | 1445 | 1325 |
| | 19 | 390012 | 67.3 | 19 | 2 | 1091 | 1218 | - |

| Trial ID | Radar Type | Number of Bursts | Burst Period(s) | Wave from Length (s) | Center Frequency(GHz) | - | | |
|----------|------------|-------------------|------------------|----------------------|----------------------------|------------|------------|------------|
| 4 | Type 5 | 17 | 0.705882 | 12 | 5.54 | | | |
| | Burst ID | Burst Offset (us) | Pulse Width (us) | Chirp Width (MHz) | Number of Pulses per Burst | PRI-1 (us) | PRI-2 (us) | PRI-3 (us) |
| | 0 | 629614 | 67.9 | 16 | 2 | 1320 | 1133 | - |
| | 1 | 96856 | 62.3 | 16 | 1 | 1957 | - | - |
| | 2 | 267719 | 53.3 | 16 | 1 | 1592 | - | - |
| | 3 | 436784 | 90 | 16 | 3 | 1900 | 1153 | 1346 |
| | 4 | 608289 | 77.1 | 16 | 2 | 1166 | 1646 | - |
| | 5 | 75610 | 83.9 | 16 | 3 | 1278 | 1232 | 1459 |
| | 6 | 245638 | 89.1 | 16 | 3 | 1240 | 1384 | 1939 |
| | 7 | 416355 | 81.8 | 16 | 2 | 1833 | 1676 | - |
| | 8 | 588736 | 50.3 | 16 | 1 | 1075 | - | - |
| | 9 | 54571 | 87.1 | 16 | 3 | 1116 | 1996 | 1756 |
| | 10 | 225175 | 71.3 | 16 | 2 | 1225 | 1815 | - |
| | 11 | 394825 | 97.5 | 16 | 3 | 1884 | 1465 | 1132 |
| | 12 | 565361 | 90.6 | 16 | 3 | 1561 | 1040 | 1354 |
| | 13 | 33643 | 86.3 | 16 | 3 | 1596 | 1183 | 1792 |
| | 14 | 203957 | 97.6 | 16 | 3 | 1365 | 1073 | 1361 |
| | 15 | 373812 | 84.7 | 16 | 3 | 1021 | 1718 | 1854 |
| | 16 | 544060 | 99.7 | 16 | 3 | 1150 | 1244 | 1988 |

| 5 | Type 5 | 14 | 0.857143 | 12 | 5.54 | | | |
|---|----------|-------------------|------------------|-------------------|----------------------------|------------|------------|------------|
| | Burst ID | Burst Offset (us) | Pulse Width (us) | Chirp Width (MHz) | Number of Pulses per Burst | PRI-1 (us) | PRI-2 (us) | PRI-3 (us) |
| | 0 | 15438 | 92.9 | 12 | 3 | 1085 | 1564 | 1407 |
| | 1 | 222486 | 67.7 | 12 | 2 | 1744 | 1747 | - |
| | 2 | 430731 | 65.8 | 12 | 1 | 1092 | - | - |
| | 3 | 637784 | 56.3 | 12 | 1 | 1851 | - | - |
| | 4 | 845342 | 53.7 | 12 | 1 | 1727 | - | - |
| | 5 | 196720 | 83.5 | 12 | 3 | 1679 | 1930 | 1025 |
| | 6 | 404955 | 65.8 | 12 | 1 | 1519 | - | - |
| | 7 | 610711 | 85.9 | 12 | 3 | 1134 | 1034 | 1808 |
| | 8 | 818057 | 76.3 | 12 | 2 | 1606 | 1926 | - |
| | 9 | 171459 | 81.5 | 12 | 2 | 1891 | 1714 | - |
| | 10 | 377969 | 89.4 | 12 | 3 | 1310 | 1594 | 1827 |
| | 11 | 586875 | 63.4 | 12 | 1 | 1568 | - | - |
| | 12 | 792834 | 69.6 | 12 | 2 | 1307 | 1925 | - |
| | 13 | 146044 | 74.5 | 12 | 2 | 1264 | 1846 | - |

| Trial ID | Radar Type | Number of Bursts | Burst Period(s) | Wave from Length (s) | Center Frequency(GHz) | - | | |
|----------|------------|-------------------|------------------|----------------------|----------------------------|------------|------------|------------|
| 6 | Type 5 | 15 | 0.8 | 12 | 5.54 | | | |
| | Burst ID | Burst Offset (us) | Pulse Width (us) | Chirp Width (MHz) | Number of Pulses per Burst | PRI-1 (us) | PRI-2 (us) | PRI-3 (us) |
| | 0 | 329022 | 96.6 | 13 | 3 | 1182 | 1609 | 1581 |
| | 1 | 521718 | 96.7 | 13 | 3 | 1829 | 1799 | 1154 |
| | 2 | 714222 | 86.5 | 13 | 3 | 1923 | 1396 | 1865 |
| | 3 | 112450 | 73.3 | 13 | 2 | 1908 | 1318 | - |
| | 4 | 306283 | 55.8 | 13 | 1 | 1688 | - | - |
| | 5 | 500239 | 55.4 | 13 | 1 | 1145 | - | - |
| | 6 | 690932 | 85.3 | 13 | 3 | 1336 | 1504 | 1820 |
| | 7 | 88645 | 79.4 | 13 | 2 | 1344 | 1893 | - |
| | 8 | 282508 | 65.7 | 13 | 1 | 1476 | - | - |
| | 9 | 475842 | 68.6 | 13 | 2 | 1008 | 1028 | - |
| | 10 | 667887 | 77.7 | 13 | 2 | 1972 | 1835 | - |
| | 11 | 64845 | 79.6 | 13 | 2 | 1882 | 1331 | - |
| | 12 | 257755 | 94.9 | 13 | 3 | 1830 | 1070 | 1349 |
| | 13 | 452335 | 61.4 | 13 | 1 | 1451 | - | - |
| | 14 | 643395 | 90.6 | 13 | 3 | 1233 | 1562 | 1887 |
| 7 | Type 5 | 12 | 1 | 12 | 5.54 | | | |
| | Burst ID | Burst Offset (us) | Pulse Width (us) | Chirp Width (MHz) | Number of Pulses per Burst | PRI-1 (us) | PRI-2 (us) | PRI-3 (us) |
| | 0 | 51446 | 52.6 | 10 | 1 | 1210 | - | - |
| | 1 | 292696 | 84.1 | 10 | 3 | 1314 | 1725 | 1529 |
| | 2 | 533989 | 97.7 | 10 | 3 | 1139 | 1868 | 1805 |
| | 3 | 775684 | 97.3 | 10 | 3 | 1341 | 1446 | 1755 |
| | 4 | 21542 | 98.8 | 10 | 3 | 1544 | 1386 | 1302 |
| | 5 | 263385 | 72.2 | 10 | 2 | 1771 | 1184 | - |
| | 6 | 505581 | 67.6 | 10 | 2 | 1175 | 1027 | - |
| | 7 | 747058 | 75.7 | 10 | 2 | 1026 | 1871 | - |
| | 8 | 989976 | 60.9 | 10 | 1 | 1798 | - | - |
| | 9 | 234024 | 64.2 | 10 | 1 | 1138 | - | - |
| | 10 | 475207 | 78.8 | 10 | 2 | 1784 | 1604 | - |
| | 11 | 715825 | 87.5 | 10 | 3 | 1511 | 1712 | 1683 |

| Trial ID | Radar Type | Number of Bursts | Burst Period(s) | Wave from Length (s) | Center Frequency(GHz) | - | | |
|----------|------------|-------------------|------------------|----------------------|----------------------------|------------|------------|------------|
| 8 | Type 5 | 14 | 0.857143 | 12 | 5.54 | | | |
| | Burst ID | Burst Offset (us) | Pulse Width (us) | Chirp Width (MHz) | Number of Pulses per Burst | PRI-1 (us) | PRI-2 (us) | PRI-3 (us) |
| | 0 | 823112 | 54.1 | 13 | 1 | 1415 | - | - |
| | 1 | 174985 | 50.7 | 13 | 1 | 1221 | - | - |
| | 2 | 382216 | 52.3 | 13 | 1 | 1974 | - | - |
| | 3 | 587395 | 99.8 | 13 | 3 | 1558 | 1698 | 1949 |
| | 4 | 796897 | 68.4 | 13 | 2 | 1014 | 1099 | - |
| | 5 | 149042 | 80.8 | 13 | 2 | 1736 | 1505 | - |
| | 6 | 356750 | 62.5 | 13 | 1 | 1778 | - | - |
| | 7 | 563824 | 74.8 | 13 | 2 | 1149 | 1204 | - |
| | 8 | 772314 | 50.8 | 13 | 1 | 1049 | - | - |
| | 9 | 123796 | 54 | 13 | 1 | 1417 | - | - |
| | 10 | 331215 | 63 | 13 | 1 | 1730 | - | - |
| | 11 | 537402 | 91.8 | 13 | 3 | 1143 | 1270 | 1347 |
| | 12 | 744805 | 79.3 | 13 | 2 | 1274 | 1992 | - |
| | 13 | 98172 | 64.3 | 13 | 1 | 1937 | - | - |
| 9 | Type 5 | 8 | 1.5 | 12 | 5.54 | | | |
| | Burst ID | Burst Offset (us) | Pulse Width (us) | Chirp Width (MHz) | Number of Pulses per Burst | PRI-1 (us) | PRI-2 (us) | PRI-3 (us) |
| | 0 | 535815 | 63.4 | 6 | 1 | 1043 | - | - |
| | 1 | 898868 | 52 | 6 | 1 | 1863 | - | - |
| | 2 | 1259235 | 97.2 | 6 | 3 | 1973 | 1605 | 1583 |
| | 3 | 127106 | 78.7 | 6 | 2 | 1466 | 1743 | - |
| | 4 | 490358 | 74.2 | 6 | 2 | 1280 | 1219 | - |
| | 5 | 852409 | 88.7 | 6 | 3 | 1293 | 1934 | 1273 |
| | 6 | 1217152 | 54.3 | 6 | 1 | 1991 | - | - |
| | 7 | 82296 | 95.4 | 6 | 3 | 1580 | 1555 | 1791 |

| Trial ID | Radar Type | Number of Bursts | Burst Period(s) | Wave from Length (s) | Center Frequency(GHz) | - | | |
|----------|------------|-------------------|------------------|----------------------|----------------------------|------------|------------|------------|
| 10 | Type 5 | 17 | 0.705882 | 12 | 5.5369 | | | |
| | Burst ID | Burst Offset (us) | Pulse Width (us) | Chirp Width (MHz) | Number of Pulses per Burst | PRI-1 (us) | PRI-2 (us) | PRI-3 (us) |
| | 0 | 209249 | 73.7 | 16 | 2 | 1208 | 1497 | - |
| | 1 | 378386 | 97.4 | 16 | 3 | 1942 | 1754 | 1613 |
| | 2 | 548411 | 91.7 | 16 | 3 | 1999 | 1702 | 1462 |
| | 3 | 17733 | 66.2 | 16 | 1 | 1393 | - | - |
| | 4 | 187952 | 70.8 | 16 | 2 | 1968 | 1821 | - |
| | 5 | 359277 | 52.3 | 16 | 1 | 1740 | - | - |
| | 6 | 528886 | 78.9 | 16 | 2 | 1308 | 1984 | - |
| | 7 | 700166 | 70.9 | 16 | 2 | 1050 | 1358 | - |
| | 8 | 167197 | 75.6 | 16 | 2 | 1437 | 1430 | - |
| | 9 | 338262 | 59.1 | 16 | 1 | 1697 | - | - |
| | 10 | 508324 | 77 | 16 | 2 | 1397 | 1304 | - |
| | 11 | 678689 | 67.9 | 16 | 2 | 1803 | 1083 | - |
| | 12 | 146031 | 81.2 | 16 | 2 | 1720 | 1932 | - |
| | 13 | 316923 | 78.7 | 16 | 2 | 1247 | 1121 | - |
| | 14 | 488056 | 63.3 | 16 | 1 | 1634 | - | - |
| | 15 | 657326 | 68.9 | 16 | 2 | 1849 | 1423 | - |
| | 16 | 125509 | 59.3 | 16 | 1 | 1093 | - | - |

| Trial ID | Radar Type | Number of Bursts | Burst Period(s) | Wave from Length (s) | Center Frequency(GHz) | - | | |
|----------|------------|-------------------|------------------|----------------------|----------------------------|------------|------------|------------|
| 11 | Type 5 | 19 | 0.631579 | 12 | 5.5381 | | | |
| | Burst ID | Burst Offset (us) | Pulse Width (us) | Chirp Width (MHz) | Number of Pulses per Burst | PRI-1 (us) | PRI-2 (us) | PRI-3 (us) |
| | 0 | 263736 | 98.9 | 19 | 3 | 1381 | 1680 | 1488 |
| | 1 | 416459 | 82.3 | 19 | 2 | 1716 | 1855 | - |
| | 2 | 567902 | 86.7 | 19 | 3 | 1211 | 1400 | 1919 |
| | 3 | 92979 | 89.7 | 19 | 3 | 1861 | 1068 | 1282 |
| | 4 | 245155 | 98.6 | 19 | 3 | 1507 | 1194 | 1461 |
| | 5 | 397609 | 71.1 | 19 | 2 | 1921 | 1789 | - |
| | 6 | 551431 | 55.9 | 19 | 1 | 1947 | - | - |
| | 7 | 74413 | 67.9 | 19 | 2 | 1350 | 1372 | - |
| | 8 | 226559 | 84.4 | 19 | 3 | 1203 | 1107 | 1443 |
| | 9 | 380056 | 58.8 | 19 | 1 | 1715 | - | - |
| | 10 | 533408 | 65.6 | 19 | 1 | 1017 | - | - |
| | 11 | 55547 | 78.5 | 19 | 2 | 1911 | 1704 | - |
| | 12 | 207876 | 82.3 | 19 | 2 | 1845 | 1686 | - |
| | 13 | 359771 | 90.1 | 19 | 3 | 1938 | 1071 | 1266 |
| | 14 | 511297 | 90.2 | 19 | 3 | 1989 | 1089 | 1950 |
| | 15 | 36803 | 83.1 | 19 | 2 | 1943 | 1406 | - |
| | 16 | 189652 | 58.8 | 19 | 1 | 1742 | - | - |
| | 17 | 341809 | 77 | 19 | 2 | 1187 | 1657 | - |
| | 18 | 495737 | 55 | 19 | 1 | 1012 | - | - |

| Trial ID | Radar Type | Number of Bursts | Burst Period(s) | Wave from Length (s) | Center Frequency(GHz) | - | | |
|----------|------------|-------------------|------------------|----------------------|----------------------------|------------|------------|------------|
| 12 | Type 5 | 15 | 0.8 | 12 | 5.5357 | | | |
| | Burst ID | Burst Offset (us) | Pulse Width (us) | Chirp Width (MHz) | Number of Pulses per Burst | PRI-1 (us) | PRI-2 (us) | PRI-3 (us) |
| | 0 | 22911 | 58.1 | 13 | 1 | 1929 | - | - |
| | 1 | 216473 | 52.1 | 13 | 1 | 1910 | - | - |
| | 2 | 410004 | 59.9 | 13 | 1 | 1971 | - | - |
| | 3 | 603671 | 60.2 | 13 | 1 | 1812 | - | - |
| | 4 | 794160 | 95.9 | 13 | 3 | 1399 | 1906 | 1608 |
| | 5 | 192251 | 79.9 | 13 | 2 | 1626 | 1859 | - |
| | 6 | 385590 | 78.5 | 13 | 2 | 1238 | 1917 | - |
| | 7 | 579862 | 53.8 | 13 | 1 | 1763 | - | - |
| | 8 | 773423 | 64.7 | 13 | 1 | 1800 | - | - |
| | 9 | 168898 | 61.4 | 13 | 1 | 1390 | - | - |
| | 10 | 361606 | 83.2 | 13 | 2 | 1692 | 1858 | - |
| | 11 | 553866 | 84.7 | 13 | 3 | 1533 | 1677 | 1638 |
| | 12 | 747241 | 88.7 | 13 | 3 | 1703 | 1528 | 1058 |
| | 13 | 144710 | 78.3 | 13 | 2 | 1258 | 1951 | - |
| | 14 | 337856 | 69.3 | 13 | 2 | 1731 | 1717 | - |
| 13 | Type 5 | 12 | 1 | 12 | 5.5345 | | | |
| | Burst ID | Burst Offset (us) | Pulse Width (us) | Chirp Width (MHz) | Number of Pulses per Burst | PRI-1 (us) | PRI-2 (us) | PRI-3 (us) |
| | 0 | 664275 | 75.3 | 10 | 2 | 1994 | 1612 | - |
| | 1 | 907886 | 56.3 | 10 | 1 | 1456 | - | - |
| | 2 | 151316 | 67.7 | 10 | 2 | 1617 | 1185 | - |
| | 3 | 393746 | 55.6 | 10 | 1 | 1337 | - | - |
| | 4 | 635093 | 75.2 | 10 | 2 | 1421 | 1267 | - |
| | 5 | 876993 | 76.3 | 10 | 2 | 1359 | 1305 | - |
| | 6 | 121278 | 85.7 | 10 | 3 | 1547 | 1362 | 1924 |
| | 7 | 362696 | 98.4 | 10 | 3 | 1873 | 1550 | 1249 |
| | 8 | 604342 | 86.4 | 10 | 3 | 1779 | 1439 | 1046 |
| | 9 | 846453 | 93.6 | 10 | 3 | 1059 | 1031 | 1452 |
| | 10 | 91871 | 63.3 | 10 | 1 | 1328 | - | - |
| | 11 | 333050 | 92.4 | 10 | 3 | 1412 | 1673 | 1322 |

| Trial ID | Radar Type | Number of Bursts | Burst Period(s) | Wave from Length (s) | Center Frequency(GHz) | - | | |
|----------|------------|-------------------|------------------|----------------------|----------------------------|------------|------------|------------|
| 14 | Type 5 | 19 | 0.631579 | 12 | 5.5377 | | | |
| | Burst ID | Burst Offset (us) | Pulse Width (us) | Chirp Width (MHz) | Number of Pulses per Burst | PRI-1 (us) | PRI-2 (us) | PRI-3 (us) |
| | 0 | 361323 | 93.3 | 18 | 3 | 1983 | 1912 | 1535 |
| | 1 | 515261 | 69.1 | 18 | 2 | 1102 | 1794 | - |
| | 2 | 39025 | 86.9 | 18 | 3 | 1044 | 1152 | 1148 |
| | 3 | 190900 | 84.9 | 18 | 3 | 1894 | 1948 | 1118 |
| | 4 | 343941 | 72.3 | 18 | 2 | 1094 | 1916 | - |
| | 5 | 497624 | 51.7 | 18 | 1 | 1447 | - | - |
| | 6 | 20319 | 58.3 | 18 | 1 | 1429 | - | - |
| | 7 | 172999 | 60.8 | 18 | 1 | 1979 | - | - |
| | 8 | 325872 | 57.1 | 18 | 1 | 1641 | - | - |
| | 9 | 475841 | 88.9 | 18 | 3 | 1886 | 1964 | 1489 |
| | 10 | 1489 | 72 | 18 | 2 | 1909 | 1297 | - |
| | 11 | 153647 | 90.9 | 18 | 3 | 1261 | 1566 | 1370 |
| | 12 | 307096 | 59.8 | 18 | 1 | 1552 | - | - |
| | 13 | 458804 | 70 | 18 | 2 | 1759 | 1291 | - |
| | 14 | 610798 | 67.2 | 18 | 2 | 1625 | 1881 | - |
| | 15 | 134759 | 91.2 | 18 | 3 | 1382 | 1832 | 1661 |
| | 16 | 288306 | 56.5 | 18 | 1 | 1483 | - | - |
| | 17 | 441296 | 51.2 | 18 | 1 | 1237 | - | - |
| | 18 | 592780 | 74.1 | 18 | 2 | 1471 | 1245 | - |

| 15 | Type 5 | 14 | 0.857143 | 12 | 5.5353 | | | |
|----|----------|-------------------|------------------|-------------------|----------------------------|------------|------------|------------|
| | Burst ID | Burst Offset (us) | Pulse Width (us) | Chirp Width (MHz) | Number of Pulses per Burst | PRI-1 (us) | PRI-2 (us) | PRI-3 (us) |
| | 0 | 158286 | 76.9 | 12 | 2 | 1110 | 1140 | - |
| | 1 | 366024 | 50.2 | 12 | 1 | 1316 | - | - |
| | 2 | 573452 | 62.9 | 12 | 1 | 1520 | - | - |
| | 3 | 780619 | 64.7 | 12 | 1 | 1902 | - | - |
| | 4 | 132455 | 83.8 | 12 | 3 | 1410 | 1097 | 1621 |
| | 5 | 340207 | 65.4 | 12 | 1 | 1944 | - | - |
| | 6 | 548208 | 53.2 | 12 | 1 | 1024 | - | - |
| | 7 | 755333 | 51.7 | 12 | 1 | 1603 | - | - |
| | 8 | 107117 | 78.7 | 12 | 2 | 1804 | 1168 | - |
| | 9 | 314500 | 72.4 | 12 | 2 | 1030 | 1343 | - |
| | 10 | 522447 | 53.8 | 12 | 1 | 1327 | - | - |
| | 11 | 728517 | 73.6 | 12 | 2 | 1524 | 1553 | - |
| | 12 | 81611 | 66.7 | 12 | 2 | 1722 | 1122 | - |
| | 13 | 288948 | 82.5 | 12 | 2 | 1404 | 1019 | - |

| Trial ID | Radar Type | Number of Bursts | Burst Period(s) | Wave from Length (s) | Center Frequency(GHz) | - | | |
|----------|------------|-------------------|------------------|----------------------|----------------------------|------------|------------|------------|
| 16 | Type 5 | 20 | 0.6 | 12 | 5.5385 | | | |
| | Burst ID | Burst Offset (us) | Pulse Width (us) | Chirp Width (MHz) | Number of Pulses per Burst | PRI-1 (us) | PRI-2 (us) | PRI-3 (us) |
| | 0 | 345766 | 87.6 | 20 | 3 | 1565 | 1055 | 1840 |
| | 1 | 490019 | 85.2 | 20 | 3 | 1735 | 1541 | 1408 |
| | 2 | 39073 | 84.8 | 20 | 3 | 1534 | 1889 | 1463 |
| | 3 | 183923 | 77.9 | 20 | 2 | 1749 | 1460 | - |
| | 4 | 328777 | 76.5 | 20 | 2 | 1518 | 1485 | - |
| | 5 | 474728 | 60.9 | 20 | 1 | 1540 | - | - |
| | 6 | 21394 | 83 | 20 | 2 | 1080 | 1010 | - |
| | 7 | 165992 | 80.4 | 20 | 2 | 1824 | 1752 | - |
| | 8 | 310973 | 67.5 | 20 | 2 | 1764 | 1181 | - |
| | 9 | 456884 | 62.1 | 20 | 1 | 1495 | - | - |
| | 10 | 3515 | 86.4 | 20 | 3 | 1773 | 1966 | 1263 |
| | 11 | 147928 | 84.3 | 20 | 3 | 1593 | 1188 | 1788 |
| | 12 | 293225 | 76.9 | 20 | 2 | 1226 | 1537 | - |
| | 13 | 436922 | 95.8 | 20 | 3 | 1192 | 1298 | 1844 |
| | 14 | 584015 | 55.2 | 20 | 1 | 1644 | - | - |
| | 15 | 130832 | 59 | 20 | 1 | 1402 | - | - |
| | 16 | 274684 | 94.5 | 20 | 3 | 1296 | 1700 | 1283 |
| | 17 | 418579 | 91.9 | 20 | 3 | 1970 | 1978 | 1165 |
| | 18 | 563464 | 85.2 | 20 | 3 | 1732 | 1551 | 1189 |
| | 19 | 112787 | 69.5 | 20 | 2 | 1038 | 1224 | - |

| | | | | | | | | |
|----|----------|-------------------|------------------|-------------------|----------------------------|------------|------------|------------|
| 17 | Type 5 | 12 | 1 | 12 | 5.5345 | | | |
| | Burst ID | Burst Offset (us) | Pulse Width (us) | Chirp Width (MHz) | Number of Pulses per Burst | PRI-1 (us) | PRI-2 (us) | PRI-3 (us) |
| | 0 | 429224 | 86.4 | 10 | 3 | 1259 | 1918 | 1455 |
| | 1 | 670241 | 92.2 | 10 | 3 | 1598 | 1719 | 1895 |
| | 2 | 912880 | 80.4 | 10 | 2 | 1816 | 1899 | - |
| | 3 | 158603 | 54.3 | 10 | 1 | 1335 | - | - |
| | 4 | 400824 | 53.1 | 10 | 1 | 1303 | - | - |
| | 5 | 641915 | 69.4 | 10 | 2 | 1503 | 1546 | - |
| | 6 | 883823 | 69.1 | 10 | 2 | 1279 | 1639 | - |
| | 7 | 128373 | 100 | 10 | 3 | 1375 | 1438 | 1595 |
| | 8 | 370379 | 79.6 | 10 | 2 | 1239 | 1705 | - |
| | 9 | 611194 | 88.4 | 10 | 3 | 1374 | 1579 | 1623 |
| | 10 | 856665 | 53.3 | 10 | 1 | 1016 | - | - |
| | 11 | 98897 | 65.3 | 10 | 1 | 1709 | - | - |

| Trial ID | Radar Type | Number of Bursts | Burst Period(s) | Wave from Length (s) | Center Frequency(GHz) | - | | |
|----------|------------|-------------------|------------------|----------------------|----------------------------|------------|------------|------------|
| 18 | Type 5 | 14 | 0.857143 | 12 | 5.5353 | | | |
| | Burst ID | Burst Offset (us) | Pulse Width (us) | Chirp Width (MHz) | Number of Pulses per Burst | PRI-1 (us) | PRI-2 (us) | PRI-3 (us) |
| | 0 | 292143 | 55.3 | 12 | 1 | 1920 | - | - |
| | 1 | 499633 | 58.3 | 12 | 1 | 1797 | - | - |
| | 2 | 706377 | 72.3 | 12 | 2 | 1610 | 1039 | - |
| | 3 | 58969 | 84.8 | 12 | 3 | 1131 | 1761 | 1721 |
| | 4 | 266161 | 82.5 | 12 | 2 | 1875 | 1431 | - |
| | 5 | 474469 | 63.3 | 12 | 1 | 1095 | - | - |
| | 6 | 680544 | 80 | 12 | 2 | 1119 | 1913 | - |
| | 7 | 33519 | 90.3 | 12 | 3 | 1660 | 1853 | 1123 |
| | 8 | 240319 | 91.1 | 12 | 3 | 1539 | 1783 | 1172 |
| | 9 | 447400 | 96.6 | 12 | 3 | 1525 | 1036 | 1385 |
| | 10 | 654516 | 82.7 | 12 | 2 | 1710 | 1990 | - |
| | 11 | 8083 | 50.7 | 12 | 1 | 1234 | - | - |
| | 12 | 215435 | 78.4 | 12 | 2 | 1047 | 1109 | - |
| | 13 | 421325 | 99.5 | 12 | 3 | 1299 | 1965 | 1869 |
| 19 | Type 5 | 12 | 1 | 12 | 5.5345 | | | |
| | Burst ID | Burst Offset (us) | Pulse Width (us) | Chirp Width (MHz) | Number of Pulses per Burst | PRI-1 (us) | PRI-2 (us) | PRI-3 (us) |
| | 0 | 733725 | 88.6 | 10 | 3 | 1501 | 1067 | 1927 |
| | 1 | 977882 | 57.4 | 10 | 1 | 1723 | - | - |
| | 2 | 221197 | 96.6 | 10 | 3 | 1086 | 1658 | 1324 |
| | 3 | 462915 | 69.7 | 10 | 2 | 1751 | 1945 | - |
| | 4 | 705071 | 77.9 | 10 | 2 | 1642 | 1317 | - |
| | 5 | 947923 | 62 | 10 | 1 | 1866 | - | - |
| | 6 | 191373 | 88.4 | 10 | 3 | 1997 | 1077 | 1366 |
| | 7 | 432561 | 97.3 | 10 | 3 | 1790 | 1896 | 1367 |
| | 8 | 674004 | 96.2 | 10 | 3 | 1391 | 1787 | 1672 |
| | 9 | 915842 | 95.4 | 10 | 3 | 1020 | 1892 | 1414 |
| | 10 | 162176 | 54.8 | 10 | 1 | 1084 | - | - |
| | 11 | 403553 | 80.4 | 10 | 2 | 1850 | 1436 | - |

| Trial ID | Radar Type | Number of Bursts | Burst Period(s) | Wave from Length (s) | Center Frequency(GHz) | - | | |
|----------|------------|-------------------|------------------|----------------------|----------------------------|------------|------------|------------|
| 20 | Type 5 | 16 | 0.75 | 12 | 5.5435 | | | |
| | Burst ID | Burst Offset (us) | Pulse Width (us) | Chirp Width (MHz) | Number of Pulses per Burst | PRI-1 (us) | PRI-2 (us) | PRI-3 (us) |
| | 0 | 483470 | 74.7 | 15 | 2 | 1619 | 1611 | - |
| | 1 | 666072 | 57.1 | 15 | 1 | 1560 | - | - |
| | 2 | 98810 | 91.9 | 15 | 3 | 1392 | 1475 | 1276 |
| | 3 | 279914 | 83.1 | 15 | 2 | 1809 | 1772 | - |
| | 4 | 462536 | 50.7 | 15 | 1 | 1003 | - | - |
| | 5 | 642324 | 79.2 | 15 | 2 | 1574 | 1600 | - |
| | 6 | 76831 | 58.7 | 15 | 1 | 1186 | - | - |
| | 7 | 257785 | 71 | 15 | 2 | 1521 | 1567 | - |
| | 8 | 438554 | 79 | 15 | 2 | 1777 | 1960 | - |
| | 9 | 620397 | 68.5 | 15 | 2 | 1284 | 1428 | - |
| | 10 | 54310 | 73.5 | 15 | 2 | 1904 | 1352 | - |
| | 11 | 235506 | 70.5 | 15 | 2 | 1864 | 1115 | - |
| | 12 | 417036 | 76.6 | 15 | 2 | 1045 | 1300 | - |
| | 13 | 597974 | 81.2 | 15 | 2 | 1160 | 1675 | - |
| | 14 | 32086 | 61.8 | 15 | 1 | 1277 | - | - |
| | 15 | 212751 | 94.9 | 15 | 3 | 1450 | 1206 | 1860 |
| 21 | Type 5 | 12 | 1 | 12 | 5.5459 | | | |
| | Burst ID | Burst Offset (us) | Pulse Width (us) | Chirp Width (MHz) | Number of Pulses per Burst | PRI-1 (us) | PRI-2 (us) | PRI-3 (us) |
| | 0 | 526149 | 78.5 | 9 | 2 | 1653 | 1698 | - |
| | 1 | 767135 | 89.8 | 9 | 3 | 1174 | 1962 | 1167 |
| | 2 | 12955 | 59.4 | 9 | 1 | 1962 | - | - |
| | 3 | 254612 | 79.6 | 9 | 2 | 1633 | 1890 | - |
| | 4 | 496568 | 76 | 9 | 2 | 1112 | 1811 | - |
| | 5 | 739728 | 53.6 | 9 | 1 | 1144 | - | - |
| | 6 | 980872 | 80.9 | 9 | 2 | 1220 | 1053 | - |
| | 7 | 225249 | 61.6 | 9 | 1 | 1724 | - | - |
| | 8 | 467279 | 53.4 | 9 | 1 | 1901 | - | - |
| | 9 | 709720 | 59.9 | 9 | 1 | 1379 | - | - |
| | 10 | 951847 | 60.4 | 9 | 1 | 1453 | - | - |
| | 11 | 194839 | 91.4 | 9 | 3 | 1768 | 1726 | 1227 |

| Trial ID | Radar Type | Number of Bursts | Burst Period(s) | Wave from Length (s) | Center Frequency(GHz) | - | | |
|----------|------------|-------------------|------------------|----------------------|----------------------------|------------|------------|------------|
| 22 | Type 5 | 20 | 0.8 | 12 | 5.5415 | | | |
| | Burst ID | Burst Offset (us) | Pulse Width (us) | Chirp Width (MHz) | Number of Pulses per Burst | PRI-1 (us) | PRI-2 (us) | PRI-3 (us) |
| | 0 | 261858 | 77 | 20 | 2 | 1191 | 1363 | - |
| | 1 | 407646 | 58.1 | 20 | 1 | 1248 | - | - |
| | 2 | 552319 | 62.1 | 20 | 1 | 1836 | - | - |
| | 3 | 99107 | 76.9 | 20 | 2 | 1334 | 1236 | - |
| | 4 | 243514 | 80 | 20 | 2 | 1914 | 1852 | - |
| | 5 | 389464 | 52 | 20 | 1 | 1701 | - | - |
| | 6 | 531093 | 88.6 | 20 | 3 | 1693 | 1995 | 1905 |
| | 7 | 81159 | 72.9 | 20 | 2 | 1922 | 1387 | - |
| | 8 | 225245 | 98.5 | 20 | 3 | 1839 | 1746 | 1389 |
| | 9 | 371906 | 57.9 | 20 | 1 | 1193 | - | - |
| | 10 | 514197 | 95.9 | 20 | 3 | 1659 | 1870 | 1066 |
| | 11 | 63561 | 53.5 | 20 | 1 | 1162 | - | - |
| | 12 | 207510 | 92 | 20 | 3 | 1745 | 1654 | 1458 |
| | 13 | 353638 | 57.3 | 20 | 1 | 1834 | - | - |
| | 14 | 497515 | 70.5 | 20 | 2 | 1684 | 1586 | - |
| | 15 | 45553 | 70 | 20 | 2 | 1042 | 1664 | - |
| | 16 | 189821 | 84 | 20 | 3 | 1765 | 1630 | 1176 |
| | 17 | 335330 | 76.1 | 20 | 2 | 1557 | 1057 | - |
| | 18 | 478825 | 93.2 | 20 | 3 | 1985 | 1018 | 1340 |
| | 19 | 27594 | 96.8 | 20 | 3 | 1760 | 1614 | 1817 |

| 23 | Type 5 | 14 | 0.857143 | 12 | 5.5447 | | | |
|----|----------|-------------------|------------------|-------------------|----------------------------|------------|------------|------------|
| | Burst ID | Burst Offset (us) | Pulse Width (us) | Chirp Width (MHz) | Number of Pulses per Burst | PRI-1 (us) | PRI-2 (us) | PRI-3 (us) |
| | 0 | 247117 | 50.1 | 12 | 1 | 1841 | - | - |
| | 1 | 453362 | 93.5 | 12 | 3 | 1590 | 1081 | 1413 |
| | 2 | 660875 | 68.8 | 12 | 2 | 1707 | 1577 | - |
| | 3 | 14140 | 56.3 | 12 | 1 | 1056 | - | - |
| | 4 | 220734 | 86 | 12 | 3 | 1953 | 1108 | 1987 |
| | 5 | 428367 | 75.2 | 12 | 2 | 1572 | 1536 | - |
| | 6 | 636881 | 54.4 | 12 | 1 | 1517 | - | - |
| | 7 | 843157 | 71.1 | 12 | 2 | 1329 | 1243 | - |
| | 8 | 195585 | 76.2 | 12 | 2 | 1940 | 1770 | - |
| | 9 | 403231 | 80.2 | 12 | 2 | 1098 | 1209 | - |
| | 10 | 610202 | 79.7 | 12 | 2 | 1588 | 1214 | - |
| | 11 | 815229 | 90.9 | 12 | 3 | 1615 | 1862 | 1601 |
| | 12 | 170267 | 68.7 | 12 | 2 | 1377 | 1441 | - |
| | 13 | 377306 | 67.4 | 12 | 2 | 1872 | 1313 | - |

| Trial ID | Radar Type | Number of Bursts | Burst Period(s) | Wave from Length (s) | Center Frequency(GHz) | - | | |
|----------|------------|-------------------|------------------|----------------------|----------------------------|------------|------------|------------|
| 24 | Type 5 | 13 | 0.923077 | 12 | 5.5451 | | | |
| | Burst ID | Burst Offset (us) | Pulse Width (us) | Chirp Width (MHz) | Number of Pulses per Burst | PRI-1 (us) | PRI-2 (us) | PRI-3 (us) |
| | 0 | 628071 | 94 | 11 | 3 | 1643 | 1748 | 1941 |
| | 1 | 853391 | 70.8 | 11 | 2 | 1177 | 1201 | - |
| | 2 | 156223 | 56.3 | 11 | 1 | 1006 | - | - |
| | 3 | 378734 | 96.7 | 11 | 3 | 1230 | 1163 | 1332 |
| | 4 | 601331 | 90.6 | 11 | 3 | 1217 | 1582 | 1498 |
| | 5 | 825462 | 74.5 | 11 | 2 | 1569 | 1281 | - |
| | 6 | 128265 | 92.6 | 11 | 3 | 1065 | 1669 | 1222 |
| | 7 | 351161 | 89 | 11 | 3 | 1493 | 1135 | 1380 |
| | 8 | 573425 | 96.5 | 11 | 3 | 1607 | 1822 | 1602 |
| | 9 | 798431 | 70.5 | 11 | 2 | 1141 | 1178 | - |
| | 10 | 100737 | 94 | 11 | 3 | 1009 | 1629 | 1956 |
| | 11 | 324661 | 55.8 | 11 | 1 | 1290 | - | - |
| | 12 | 546278 | 87.7 | 11 | 3 | 1435 | 1963 | 1164 |
| 25 | Type 5 | 8 | 1.5 | 12 | 5.5475 | | | |
| | Burst ID | Burst Offset (us) | Pulse Width (us) | Chirp Width (MHz) | Number of Pulses per Burst | PRI-1 (us) | PRI-2 (us) | PRI-3 (us) |
| | 0 | 1253842 | 68.6 | 5 | 2 | 1306 | 1161 | - |
| | 1 | 119486 | 83.1 | 5 | 2 | 1420 | 1315 | - |
| | 2 | 482958 | 60.9 | 5 | 1 | 1687 | - | - |
| | 3 | 845641 | 77.7 | 5 | 2 | 1776 | 1158 | - |
| | 4 | 1208428 | 77.4 | 5 | 2 | 1793 | 1510 | - |
| | 5 | 74748 | 66.8 | 5 | 2 | 1576 | 1323 | - |
| | 6 | 438300 | 63.7 | 5 | 1 | 1333 | - | - |
| | 7 | 800152 | 91.2 | 5 | 3 | 1409 | 1681 | 1275 |

| Trial ID | Radar Type | Number of Bursts | Burst Period(s) | Wave from Length (s) | Center Frequency(GHz) | - | | |
|----------|------------|-------------------|------------------|----------------------|----------------------------|------------|------------|------------|
| 26 | Type 5 | 17 | 0.705882 | 12 | 5.5431 | | | |
| | Burst ID | Burst Offset (us) | Pulse Width (us) | Chirp Width (MHz) | Number of Pulses per Burst | PRI-1 (us) | PRI-2 (us) | PRI-3 (us) |
| | 0 | 545865 | 83.6 | 16 | 3 | 1632 | 1195 | 1000 |
| | 1 | 14067 | 89.4 | 16 | 3 | 1173 | 1627 | 1656 |
| | 2 | 184953 | 55.8 | 16 | 1 | 1532 | - | - |
| | 3 | 353759 | 90.9 | 16 | 3 | 1981 | 1554 | 1998 |
| | 4 | 526388 | 54.7 | 16 | 1 | 1825 | - | - |
| | 5 | 694806 | 97.7 | 16 | 3 | 1734 | 1202 | 1250 |
| | 6 | 163568 | 67.5 | 16 | 2 | 1571 | 1434 | - |
| | 7 | 333410 | 96.7 | 16 | 3 | 1589 | 1469 | 1268 |
| | 8 | 504006 | 68.3 | 16 | 2 | 1750 | 1954 | - |
| | 9 | 675297 | 78.3 | 16 | 2 | 1591 | 1082 | - |
| | 10 | 142890 | 55 | 16 | 1 | 1427 | - | - |
| | 11 | 312479 | 84.9 | 16 | 3 | 1129 | 1936 | 1199 |
| | 12 | 482953 | 74.6 | 16 | 2 | 1959 | 1856 | - |
| | 13 | 655022 | 63.3 | 16 | 1 | 1885 | - | - |
| | 14 | 121457 | 99.8 | 16 | 3 | 1035 | 1515 | 1120 |
| | 15 | 292606 | 63.6 | 16 | 1 | 1647 | - | - |
| | 16 | 461322 | 87.3 | 16 | 3 | 1931 | 1051 | 1831 |

| Trial ID | Radar Type | Number of Bursts | Burst Period(s) | Wave from Length (s) | Center Frequency(GHz) | - | | |
|----------|------------|-------------------|------------------|----------------------|----------------------------|------------|------------|------------|
| 27 | Type 5 | 19 | 0.631579 | 12 | 5.5419 | | | |
| | Burst ID | Burst Offset (us) | Pulse Width (us) | Chirp Width (MHz) | Number of Pulses per Burst | PRI-1 (us) | PRI-2 (us) | PRI-3 (us) |
| | 0 | 565136 | 85.6 | 19 | 3 | 1946 | 1078 | 1015 |
| | 1 | 89970 | 68.6 | 19 | 2 | 1029 | 1780 | - |
| | 2 | 243121 | 54.2 | 19 | 1 | 1111 | - | - |
| | 3 | 398034 | 61.2 | 19 | 1 | 1104 | - | - |
| | 4 | 546225 | 97.1 | 19 | 3 | 1157 | 1969 | 1100 |
| | 5 | 70998 | 98.3 | 19 | 3 | 1142 | 1699 | 1622 |
| | 6 | 224083 | 62.4 | 19 | 1 | 1655 | - | - |
| | 7 | 376127 | 80.2 | 19 | 2 | 1126 | 1769 | - |
| | 8 | 527806 | 87.5 | 19 | 3 | 1216 | 1448 | 1179 |
| | 9 | 52247 | 85.8 | 19 | 3 | 1847 | 1348 | 1472 |
| | 10 | 204582 | 88.1 | 19 | 3 | 1023 | 1124 | 1631 |
| | 11 | 357941 | 65.3 | 19 | 1 | 1848 | - | - |
| | 12 | 510977 | 52.5 | 19 | 1 | 1470 | - | - |
| | 13 | 33698 | 52.3 | 19 | 1 | 1312 | - | - |
| | 14 | 186023 | 74.1 | 19 | 2 | 1915 | 1200 | - |
| | 15 | 339327 | 54.9 | 19 | 1 | 1479 | - | - |
| | 16 | 491053 | 76.2 | 19 | 2 | 1376 | 1502 | - |
| | 17 | 14858 | 60.4 | 19 | 1 | 1758 | - | - |
| | 18 | 167387 | 81.5 | 19 | 2 | 1491 | 1103 | - |

| 28 | Type 5 | 12 | 1 | 12 | 5.5455 | | | |
|----|----------|-------------------|------------------|-------------------|----------------------------|------------|------------|------------|
| | Burst ID | Burst Offset (us) | Pulse Width (us) | Chirp Width (MHz) | Number of Pulses per Burst | PRI-1 (us) | PRI-2 (us) | PRI-3 (us) |
| | 0 | 507709 | 50.5 | 10 | 1 | 1857 | - | - |
| | 1 | 750249 | 55.7 | 10 | 1 | 1246 | - | - |
| | 2 | 989003 | 85.8 | 10 | 3 | 1774 | 1002 | 1967 |
| | 3 | 235634 | 76.9 | 10 | 2 | 1125 | 1474 | - |
| | 4 | 477675 | 75.1 | 10 | 2 | 1254 | 1052 | - |
| | 5 | 718312 | 92.3 | 10 | 3 | 1180 | 1486 | 1492 |
| | 6 | 960895 | 78.1 | 10 | 2 | 1301 | 1757 | - |
| | 7 | 205370 | 92.2 | 10 | 3 | 1898 | 1252 | 1713 |
| | 8 | 446940 | 89 | 10 | 3 | 1260 | 1706 | 1411 |
| | 9 | 689225 | 70.9 | 10 | 2 | 1578 | 1620 | - |
| | 10 | 932305 | 63.1 | 10 | 1 | 1782 | - | - |
| | 11 | 176231 | 55.3 | 10 | 1 | 1522 | - | - |

| Trial ID | Radar Type | Number of Bursts | Burst Period(s) | Wave from Length (s) | Center Frequency(GHz) | - | | |
|----------|------------|-------------------|------------------|----------------------|----------------------------|------------|------------|------------|
| 29 | Type 5 | 18 | 0.666667 | 12 | 5.5427 | | | |
| | Burst ID | Burst Offset (us) | Pulse Width (us) | Chirp Width (MHz) | Number of Pulses per Burst | PRI-1 (us) | PRI-2 (us) | PRI-3 (us) |
| | 0 | 277485 | 83.4 | 17 | 3 | 1454 | 1205 | 1801 |
| | 1 | 437880 | 97.3 | 17 | 3 | 1319 | 1826 | 1635 |
| | 2 | 598445 | 90.4 | 17 | 3 | 1079 | 1986 | 1674 |
| | 3 | 97088 | 91.8 | 17 | 3 | 1563 | 1151 | 1802 |
| | 4 | 257251 | 98.2 | 17 | 3 | 1876 | 1977 | 1766 |
| | 5 | 419893 | 59.5 | 17 | 1 | 1952 | - | - |
| | 6 | 580724 | 80 | 17 | 2 | 1253 | 1137 | - |
| | 7 | 77366 | 86.5 | 17 | 3 | 1054 | 1128 | 1828 |
| | 8 | 238032 | 91.1 | 17 | 3 | 1105 | 1599 | 1442 |
| | 9 | 398605 | 93.5 | 17 | 3 | 1867 | 1373 | 1087 |
| | 10 | 562025 | 60.7 | 17 | 1 | 1033 | - | - |
| | 11 | 57684 | 67.2 | 17 | 2 | 1288 | 1405 | - |
| | 12 | 219083 | 61.8 | 17 | 1 | 1585 | - | - |
| | 13 | 379234 | 79.4 | 17 | 2 | 1933 | 1667 | - |
| | 14 | 540896 | 81.4 | 17 | 2 | 1096 | 1464 | - |
| | 15 | 37916 | 65.7 | 17 | 1 | 1496 | - | - |
| | 16 | 198794 | 76 | 17 | 2 | 1733 | 1255 | - |
| | 17 | 359754 | 81 | 17 | 2 | 1326 | 1668 | - |

Radar Singal 5_5550MHz

| Trial ID | Radar Type | Number of Bursts | Burst Period(s) | Wave from Length (s) | Center Frequency(GHz) | - | | |
|----------|------------|-------------------|------------------|----------------------|----------------------------|------------|------------|------------|
| 0 | Type 5 | 15 | 0.8 | 12 | 5.55 | | | |
| | Burst ID | Burst Offset (us) | Pulse Width (us) | Chirp Width (MHz) | Number of Pulses per Burst | PRI-1 (us) | PRI-2 (us) | PRI-3 (us) |
| | 0 | 636185 | 77.8 | 13 | 2 | 1665 | 1477 | - |
| | 1 | 32674 | 51.9 | 13 | 1 | 1074 | - | - |
| | 2 | 226294 | 63.8 | 13 | 1 | 1584 | - | - |
| | 3 | 417976 | 96.6 | 13 | 3 | 1682 | 1786 | 1843 |
| | 4 | 611152 | 85.9 | 13 | 3 | 1795 | 1215 | 1729 |
| | 5 | 8789 | 73.7 | 13 | 2 | 1198 | 1549 | - |
| | 6 | 201917 | 77.2 | 13 | 2 | 1837 | 1819 | - |
| | 7 | 395530 | 68.4 | 13 | 2 | 1587 | 1114 | - |
| | 8 | 588564 | 76.7 | 13 | 2 | 2000 | 1155 | - |
| | 9 | 783794 | 53.2 | 13 | 1 | 1147 | - | - |
| | 10 | 177933 | 85.7 | 13 | 3 | 1433 | 1695 | 1394 |
| | 11 | 370624 | 94.3 | 13 | 3 | 1670 | 1426 | 1935 |
| | 12 | 564893 | 77.6 | 13 | 2 | 1294 | 1671 | - |
| | 13 | 759583 | 65.7 | 13 | 1 | 1512 | - | - |
| | 14 | 154262 | 93.5 | 13 | 3 | 1444 | 1130 | 1468 |
| 1 | Type 5 | 8 | 1.5 | 12 | 5.55 | | | |
| | Burst ID | Burst Offset (us) | Pulse Width (us) | Chirp Width (MHz) | Number of Pulses per Burst | PRI-1 (us) | PRI-2 (us) | PRI-3 (us) |
| | 0 | 653020 | 75 | 5 | 2 | 1880 | 1527 | - |
| | 1 | 1015643 | 99.4 | 5 | 3 | 1401 | 1262 | 1257 |
| | 2 | 1379398 | 67.4 | 5 | 2 | 1531 | 1403 | - |
| | 3 | 245489 | 73.6 | 5 | 2 | 1449 | 1041 | - |
| | 4 | 609113 | 65.9 | 5 | 1 | 1432 | - | - |
| | 5 | 970852 | 83.8 | 5 | 3 | 1356 | 1292 | 1419 |
| | 6 | 1335913 | 65.5 | 5 | 1 | 1543 | - | - |
| | 7 | 200406 | 98.6 | 5 | 3 | 1548 | 1796 | 1728 |

| Trial ID | Radar Type | Number of Bursts | Burst Period(s) | Wave from Length (s) | Center Frequency(GHz) | - | | |
|----------|------------|-------------------|------------------|----------------------|----------------------------|------------|------------|------------|
| 2 | Type 5 | 11 | 1.090909 | 12 | 5.55 | | | |
| | Burst ID | Burst Offset (us) | Pulse Width (us) | Chirp Width (MHz) | Number of Pulses per Burst | PRI-1 (us) | PRI-2 (us) | PRI-3 (us) |
| | 0 | 409565 | 73.8 | 9 | 2 | 1806 | 1538 | - |
| | 1 | 673692 | 69.5 | 9 | 2 | 1117 | 1649 | - |
| | 2 | 938562 | 51.9 | 9 | 1 | 1651 | - | - |
| | 3 | 113209 | 84.6 | 9 | 3 | 1976 | 1032 | 1271 |
| | 4 | 376726 | 95.4 | 9 | 3 | 1060 | 1903 | 1388 |
| | 5 | 641212 | 68 | 9 | 2 | 1368 | 1351 | - |
| | 6 | 903714 | 89.6 | 9 | 3 | 1338 | 1514 | 1573 |
| | 7 | 80863 | 81.9 | 9 | 2 | 1022 | 1689 | - |
| | 8 | 344067 | 88.3 | 9 | 3 | 1810 | 1330 | 1838 |
| | 9 | 609331 | 53.7 | 9 | 1 | 1597 | - | - |
| | 10 | 871542 | 91.3 | 9 | 3 | 1961 | 1108 | 1001 |
| 3 | Type 5 | 20 | 0.6 | 12 | 5.55 | | | |
| | Burst ID | Burst Offset (us) | Pulse Width (us) | Chirp Width (MHz) | Number of Pulses per Burst | PRI-1 (us) | PRI-2 (us) | PRI-3 (us) |
| | 0 | 26541 | 68.1 | 19 | 2 | 1339 | 1355 | - |
| | 1 | 171821 | 58.7 | 19 | 1 | 1251 | - | - |
| | 2 | 316229 | 75.3 | 19 | 2 | 1136 | 1640 | - |
| | 3 | 461864 | 56.4 | 19 | 1 | 1753 | - | - |
| | 4 | 8677 | 99.7 | 19 | 3 | 1196 | 1708 | 1159 |
| | 5 | 153995 | 57.7 | 19 | 1 | 1013 | - | - |
| | 6 | 299238 | 59.5 | 19 | 1 | 1072 | - | - |
| | 7 | 443177 | 80 | 19 | 2 | 1482 | 1369 | - |
| | 8 | 587671 | 82 | 19 | 2 | 1993 | 1197 | - |
| | 9 | 135674 | 82.8 | 19 | 2 | 1883 | 1005 | - |
| | 10 | 279928 | 88 | 19 | 3 | 1061 | 1928 | 1101 |
| | 11 | 424279 | 93.2 | 19 | 3 | 1207 | 1907 | 1223 |
| | 12 | 570132 | 70.4 | 19 | 2 | 1526 | 1360 | - |
| | 13 | 117439 | 95.3 | 19 | 3 | 1171 | 1955 | 1775 |
| | 14 | 262502 | 81.9 | 19 | 2 | 1690 | 1545 | - |
| | 15 | 406573 | 98.5 | 19 | 3 | 1975 | 1169 | 1062 |
| | 16 | 553328 | 65 | 19 | 1 | 1767 | - | - |
| | 17 | 99799 | 85.4 | 19 | 3 | 1011 | 1637 | 1425 |
| | 18 | 244095 | 91.6 | 19 | 3 | 1878 | 1445 | 1325 |
| | 19 | 390012 | 67.3 | 19 | 2 | 1091 | 1218 | - |

| Trial ID | Radar Type | Number of Bursts | Burst Period(s) | Wave from Length (s) | Center Frequency(GHz) | - | | |
|----------|------------|-------------------|------------------|----------------------|----------------------------|------------|------------|------------|
| 4 | Type 5 | 17 | 0.705882 | 12 | 5.55 | | | |
| | Burst ID | Burst Offset (us) | Pulse Width (us) | Chirp Width (MHz) | Number of Pulses per Burst | PRI-1 (us) | PRI-2 (us) | PRI-3 (us) |
| | 0 | 629614 | 67.9 | 16 | 2 | 1320 | 1133 | - |
| | 1 | 96856 | 62.3 | 16 | 1 | 1957 | - | - |
| | 2 | 267719 | 53.3 | 16 | 1 | 1592 | - | - |
| | 3 | 436784 | 90 | 16 | 3 | 1900 | 1153 | 1346 |
| | 4 | 608289 | 77.1 | 16 | 2 | 1166 | 1646 | - |
| | 5 | 75610 | 83.9 | 16 | 3 | 1278 | 1232 | 1459 |
| | 6 | 245638 | 89.1 | 16 | 3 | 1240 | 1384 | 1939 |
| | 7 | 416355 | 81.8 | 16 | 2 | 1833 | 1676 | - |
| | 8 | 588736 | 50.3 | 16 | 1 | 1075 | - | - |
| | 9 | 54571 | 87.1 | 16 | 3 | 1116 | 1996 | 1756 |
| | 10 | 225175 | 71.3 | 16 | 2 | 1225 | 1815 | - |
| | 11 | 394825 | 97.5 | 16 | 3 | 1884 | 1465 | 1132 |
| | 12 | 565361 | 90.6 | 16 | 3 | 1561 | 1040 | 1354 |
| | 13 | 33643 | 86.3 | 16 | 3 | 1596 | 1183 | 1792 |
| | 14 | 203957 | 97.6 | 16 | 3 | 1365 | 1073 | 1361 |
| | 15 | 373812 | 84.7 | 16 | 3 | 1021 | 1718 | 1854 |
| | 16 | 544060 | 99.7 | 16 | 3 | 1150 | 1244 | 1988 |

| 5 | Type 5 | 14 | 0.857143 | 12 | 5.55 | | | |
|---|----------|-------------------|------------------|-------------------|----------------------------|------------|------------|------------|
| | Burst ID | Burst Offset (us) | Pulse Width (us) | Chirp Width (MHz) | Number of Pulses per Burst | PRI-1 (us) | PRI-2 (us) | PRI-3 (us) |
| | 0 | 15438 | 92.9 | 12 | 3 | 1085 | 1564 | 1407 |
| | 1 | 222486 | 67.7 | 12 | 2 | 1744 | 1747 | - |
| | 2 | 430731 | 65.8 | 12 | 1 | 1092 | - | - |
| | 3 | 637784 | 56.3 | 12 | 1 | 1851 | - | - |
| | 4 | 845342 | 53.7 | 12 | 1 | 1727 | - | - |
| | 5 | 196720 | 83.5 | 12 | 3 | 1679 | 1930 | 1025 |
| | 6 | 404955 | 65.8 | 12 | 1 | 1519 | - | - |
| | 7 | 610711 | 85.9 | 12 | 3 | 1134 | 1034 | 1808 |
| | 8 | 818057 | 76.3 | 12 | 2 | 1606 | 1926 | - |
| | 9 | 171459 | 81.5 | 12 | 2 | 1891 | 1714 | - |
| | 10 | 377969 | 89.4 | 12 | 3 | 1310 | 1594 | 1827 |
| | 11 | 586875 | 63.4 | 12 | 1 | 1568 | - | - |
| | 12 | 792834 | 69.6 | 12 | 2 | 1307 | 1925 | - |
| | 13 | 146044 | 74.5 | 12 | 2 | 1264 | 1846 | - |

| Trial ID | Radar Type | Number of Bursts | Burst Period(s) | Wave from Length (s) | Center Frequency(GHz) | - | | |
|----------|------------|-------------------|------------------|----------------------|----------------------------|------------|------------|------------|
| 6 | Type 5 | 15 | 0.8 | 12 | 5.55 | | | |
| | Burst ID | Burst Offset (us) | Pulse Width (us) | Chirp Width (MHz) | Number of Pulses per Burst | PRI-1 (us) | PRI-2 (us) | PRI-3 (us) |
| | 0 | 329022 | 96.6 | 13 | 3 | 1182 | 1609 | 1581 |
| | 1 | 521718 | 96.7 | 13 | 3 | 1829 | 1799 | 1154 |
| | 2 | 714222 | 86.5 | 13 | 3 | 1923 | 1396 | 1865 |
| | 3 | 112450 | 73.3 | 13 | 2 | 1908 | 1318 | - |
| | 4 | 306283 | 55.8 | 13 | 1 | 1688 | - | - |
| | 5 | 500239 | 55.4 | 13 | 1 | 1145 | - | - |
| | 6 | 690932 | 85.3 | 13 | 3 | 1336 | 1504 | 1820 |
| | 7 | 88645 | 79.4 | 13 | 2 | 1344 | 1893 | - |
| | 8 | 282508 | 65.7 | 13 | 1 | 1476 | - | - |
| | 9 | 475842 | 68.6 | 13 | 2 | 1008 | 1028 | - |
| | 10 | 687887 | 77.7 | 13 | 2 | 1972 | 1835 | - |
| | 11 | 64845 | 79.6 | 13 | 2 | 1882 | 1331 | - |
| | 12 | 257755 | 94.9 | 13 | 3 | 1830 | 1070 | 1349 |
| | 13 | 452335 | 61.4 | 13 | 1 | 1451 | - | - |
| | 14 | 643395 | 90.6 | 13 | 3 | 1233 | 1562 | 1887 |
| 7 | Type 5 | 12 | 1 | 12 | 5.55 | | | |
| | Burst ID | Burst Offset (us) | Pulse Width (us) | Chirp Width (MHz) | Number of Pulses per Burst | PRI-1 (us) | PRI-2 (us) | PRI-3 (us) |
| | 0 | 51446 | 52.6 | 10 | 1 | 1210 | - | - |
| | 1 | 292696 | 84.1 | 10 | 3 | 1314 | 1725 | 1529 |
| | 2 | 533989 | 97.7 | 10 | 3 | 1139 | 1868 | 1805 |
| | 3 | 775564 | 97.3 | 10 | 3 | 1341 | 1446 | 1755 |
| | 4 | 21542 | 98.8 | 10 | 3 | 1544 | 1386 | 1302 |
| | 5 | 263385 | 72.2 | 10 | 2 | 1771 | 1184 | - |
| | 6 | 505581 | 67.6 | 10 | 2 | 1175 | 1027 | - |
| | 7 | 747058 | 75.7 | 10 | 2 | 1026 | 1871 | - |
| | 8 | 989976 | 60.9 | 10 | 1 | 1798 | - | - |
| | 9 | 234024 | 64.2 | 10 | 1 | 1138 | - | - |
| | 10 | 475207 | 78.8 | 10 | 2 | 1784 | 1604 | - |
| | 11 | 715825 | 87.5 | 10 | 3 | 1511 | 1712 | 1683 |

| Trial ID | Radar Type | Number of Bursts | Burst Period(s) | Wave from Length (s) | Center Frequency(GHz) | - | | |
|----------|------------|-------------------|------------------|----------------------|----------------------------|------------|------------|------------|
| 8 | Type 5 | 14 | 0.857143 | 12 | 5.55 | | | |
| | Burst ID | Burst Offset (us) | Pulse Width (us) | Chirp Width (MHz) | Number of Pulses per Burst | PRI-1 (us) | PRI-2 (us) | PRI-3 (us) |
| | 0 | 823112 | 54.1 | 13 | 1 | 1415 | - | - |
| | 1 | 174965 | 50.7 | 13 | 1 | 1221 | - | - |
| | 2 | 382216 | 52.3 | 13 | 1 | 1974 | - | - |
| | 3 | 587395 | 99.8 | 13 | 3 | 1558 | 1696 | 1949 |
| | 4 | 796897 | 68.4 | 13 | 2 | 1014 | 1099 | - |
| | 5 | 149042 | 80.8 | 13 | 2 | 1736 | 1505 | - |
| | 6 | 356750 | 62.5 | 13 | 1 | 1778 | - | - |
| | 7 | 563824 | 74.8 | 13 | 2 | 1149 | 1204 | - |
| | 8 | 772314 | 50.8 | 13 | 1 | 1049 | - | - |
| | 9 | 123796 | 54 | 13 | 1 | 1417 | - | - |
| | 10 | 331215 | 63 | 13 | 1 | 1730 | - | - |
| | 11 | 537402 | 91.8 | 13 | 3 | 1143 | 1270 | 1347 |
| | 12 | 744805 | 79.3 | 13 | 2 | 1274 | 1992 | - |
| | 13 | 98172 | 64.3 | 13 | 1 | 1937 | - | - |
| 9 | Type 5 | 8 | 1.5 | 12 | 5.55 | | | |
| | Burst ID | Burst Offset (us) | Pulse Width (us) | Chirp Width (MHz) | Number of Pulses per Burst | PRI-1 (us) | PRI-2 (us) | PRI-3 (us) |
| | 0 | 535615 | 63.4 | 6 | 1 | 1043 | - | - |
| | 1 | 898668 | 52 | 6 | 1 | 1863 | - | - |
| | 2 | 1259235 | 97.2 | 6 | 3 | 1973 | 1605 | 1583 |
| | 3 | 127106 | 78.7 | 6 | 2 | 1466 | 1743 | - |
| | 4 | 490358 | 74.2 | 6 | 2 | 1280 | 1219 | - |
| | 5 | 852409 | 88.7 | 6 | 3 | 1293 | 1934 | 1273 |
| | 6 | 1217152 | 54.3 | 6 | 1 | 1991 | - | - |
| | 7 | 82296 | 95.4 | 6 | 3 | 1580 | 1555 | 1791 |

| Trial ID | Radar Type | Number of Bursts | Burst Period(s) | Wave from Length (s) | Center Frequency(GHz) | - | | |
|----------|------------|-------------------|------------------|----------------------|----------------------------|------------|------------|------------|
| 10 | Type 5 | 17 | 0.705882 | 12 | 5.5379 | | | |
| | Burst ID | Burst Offset (us) | Pulse Width (us) | Chirp Width (MHz) | Number of Pulses per Burst | PRI-1 (us) | PRI-2 (us) | PRI-3 (us) |
| | 0 | 209249 | 73.7 | 16 | 2 | 1208 | 1497 | - |
| | 1 | 378386 | 97.4 | 16 | 3 | 1942 | 1754 | 1613 |
| | 2 | 548411 | 91.7 | 16 | 3 | 1999 | 1702 | 1462 |
| | 3 | 17733 | 66.2 | 16 | 1 | 1393 | - | - |
| | 4 | 187952 | 70.8 | 16 | 2 | 1968 | 1821 | - |
| | 5 | 359277 | 52.3 | 16 | 1 | 1740 | - | - |
| | 6 | 528886 | 78.9 | 16 | 2 | 1308 | 1984 | - |
| | 7 | 700166 | 70.9 | 16 | 2 | 1050 | 1358 | - |
| | 8 | 167197 | 75.6 | 16 | 2 | 1437 | 1430 | - |
| | 9 | 338262 | 59.1 | 16 | 1 | 1697 | - | - |
| | 10 | 508324 | 77 | 16 | 2 | 1397 | 1304 | - |
| | 11 | 678689 | 67.9 | 16 | 2 | 1803 | 1083 | - |
| | 12 | 146031 | 81.2 | 16 | 2 | 1720 | 1932 | - |
| | 13 | 316923 | 78.7 | 16 | 2 | 1247 | 1121 | - |
| | 14 | 488056 | 63.3 | 16 | 1 | 1634 | - | - |
| | 15 | 657326 | 68.9 | 16 | 2 | 1849 | 1423 | - |
| | 16 | 125509 | 59.3 | 16 | 1 | 1093 | - | - |

| 11 | Type 5 | 19 | 0.631579 | 12 | 5.5391 | | | |
|----|----------|-------------------|------------------|-------------------|----------------------------|------------|------------|------------|
| | Burst ID | Burst Offset (us) | Pulse Width (us) | Chirp Width (MHz) | Number of Pulses per Burst | PRI-1 (us) | PRI-2 (us) | PRI-3 (us) |
| | 0 | 263736 | 98.9 | 19 | 3 | 1381 | 1680 | 1488 |
| | 1 | 416459 | 82.3 | 19 | 2 | 1716 | 1855 | - |
| | 2 | 567902 | 86.7 | 19 | 3 | 1211 | 1400 | 1919 |
| | 3 | 92979 | 89.7 | 19 | 3 | 1861 | 1068 | 1282 |
| | 4 | 245155 | 98.6 | 19 | 3 | 1507 | 1194 | 1461 |
| | 5 | 397609 | 71.1 | 19 | 2 | 1921 | 1789 | - |
| | 6 | 551431 | 55.9 | 19 | 1 | 1947 | - | - |
| | 7 | 74413 | 67.9 | 19 | 2 | 1350 | 1372 | - |
| | 8 | 226559 | 84.4 | 19 | 3 | 1203 | 1107 | 1443 |
| | 9 | 380056 | 58.8 | 19 | 1 | 1715 | - | - |
| | 10 | 533408 | 65.6 | 19 | 1 | 1017 | - | - |
| | 11 | 55547 | 78.5 | 19 | 2 | 1911 | 1704 | - |
| | 12 | 207876 | 82.3 | 19 | 2 | 1845 | 1686 | - |
| | 13 | 359771 | 90.1 | 19 | 3 | 1938 | 1071 | 1266 |
| | 14 | 511297 | 90.2 | 19 | 3 | 1989 | 1089 | 1950 |
| | 15 | 36803 | 83.1 | 19 | 2 | 1943 | 1406 | - |
| | 16 | 189652 | 58.8 | 19 | 1 | 1742 | - | - |
| | 17 | 341809 | 77 | 19 | 2 | 1187 | 1657 | - |
| | 18 | 495737 | 55 | 19 | 1 | 1012 | - | - |

| Trial ID | Radar Type | Number of Bursts | Burst Period(s) | Wave from Length (s) | Center Frequency(GHz) | - | | |
|----------|------------|-------------------|------------------|----------------------|----------------------------|------------|------------|------------|
| 12 | Type 5 | 15 | 0.8 | 12 | 5.5367 | | | |
| | Burst ID | Burst Offset (us) | Pulse Width (us) | Chirp Width (MHz) | Number of Pulses per Burst | PRI-1 (us) | PRI-2 (us) | PRI-3 (us) |
| | 0 | 22911 | 58.1 | 13 | 1 | 1929 | - | - |
| | 1 | 216473 | 52.1 | 13 | 1 | 1910 | - | - |
| | 2 | 410004 | 59.9 | 13 | 1 | 1971 | - | - |
| | 3 | 603671 | 60.2 | 13 | 1 | 1812 | - | - |
| | 4 | 794160 | 95.9 | 13 | 3 | 1399 | 1906 | 1608 |
| | 5 | 192251 | 79.9 | 13 | 2 | 1626 | 1859 | - |
| | 6 | 385590 | 78.5 | 13 | 2 | 1238 | 1917 | - |
| | 7 | 579862 | 53.8 | 13 | 1 | 1763 | - | - |
| | 8 | 773423 | 64.7 | 13 | 1 | 1800 | - | - |
| | 9 | 168898 | 61.4 | 13 | 1 | 1390 | - | - |
| | 10 | 361606 | 83.2 | 13 | 2 | 1692 | 1858 | - |
| | 11 | 553866 | 84.7 | 13 | 3 | 1533 | 1677 | 1638 |
| | 12 | 747241 | 88.7 | 13 | 3 | 1703 | 1528 | 1058 |
| | 13 | 144710 | 78.3 | 13 | 2 | 1258 | 1951 | - |
| | 14 | 337856 | 69.3 | 13 | 2 | 1731 | 1717 | - |
| 13 | Type 5 | 12 | 1 | 12 | 5.5355 | | | |
| | Burst ID | Burst Offset (us) | Pulse Width (us) | Chirp Width (MHz) | Number of Pulses per Burst | PRI-1 (us) | PRI-2 (us) | PRI-3 (us) |
| | 0 | 664275 | 75.3 | 10 | 2 | 1994 | 1612 | - |
| | 1 | 907886 | 56.3 | 10 | 1 | 1456 | - | - |
| | 2 | 151316 | 67.7 | 10 | 2 | 1617 | 1185 | - |
| | 3 | 393746 | 55.6 | 10 | 1 | 1337 | - | - |
| | 4 | 635093 | 75.2 | 10 | 2 | 1421 | 1267 | - |
| | 5 | 876993 | 76.3 | 10 | 2 | 1359 | 1305 | - |
| | 6 | 121278 | 85.7 | 10 | 3 | 1547 | 1362 | 1924 |
| | 7 | 362696 | 98.4 | 10 | 3 | 1873 | 1550 | 1249 |
| | 8 | 604342 | 86.4 | 10 | 3 | 1779 | 1439 | 1046 |
| | 9 | 846453 | 93.6 | 10 | 3 | 1059 | 1031 | 1452 |
| | 10 | 91871 | 63.3 | 10 | 1 | 1328 | - | - |
| | 11 | 333050 | 92.4 | 10 | 3 | 1412 | 1673 | 1322 |

| Trial ID | Radar Type | Number of Bursts | Burst Period(s) | Wave from Length (s) | Center Frequency(GHz) | - | | |
|----------|------------|-------------------|------------------|----------------------|----------------------------|------------|------------|------------|
| 14 | Type 5 | 19 | 0.631579 | 12 | 5.5387 | | | |
| | Burst ID | Burst Offset (us) | Pulse Width (us) | Chirp Width (MHz) | Number of Pulses per Burst | PRI-1 (us) | PRI-2 (us) | PRI-3 (us) |
| | 0 | 361323 | 93.3 | 18 | 3 | 1983 | 1912 | 1535 |
| | 1 | 515261 | 69.1 | 18 | 2 | 1102 | 1794 | - |
| | 2 | 39025 | 86.9 | 18 | 3 | 1044 | 1152 | 1148 |
| | 3 | 190900 | 84.9 | 18 | 3 | 1894 | 1948 | 1118 |
| | 4 | 343941 | 72.3 | 18 | 2 | 1094 | 1916 | - |
| | 5 | 497624 | 51.7 | 18 | 1 | 1447 | - | - |
| | 6 | 20319 | 58.3 | 18 | 1 | 1429 | - | - |
| | 7 | 172999 | 60.8 | 18 | 1 | 1979 | - | - |
| | 8 | 325872 | 57.1 | 18 | 1 | 1641 | - | - |
| | 9 | 475841 | 88.9 | 18 | 3 | 1888 | 1964 | 1489 |
| | 10 | 1489 | 72 | 18 | 2 | 1909 | 1297 | - |
| | 11 | 153647 | 90.9 | 18 | 3 | 1261 | 1566 | 1370 |
| | 12 | 307096 | 59.8 | 18 | 1 | 1552 | - | - |
| | 13 | 458804 | 70 | 18 | 2 | 1759 | 1291 | - |
| | 14 | 610798 | 67.2 | 18 | 2 | 1625 | 1881 | - |
| | 15 | 134759 | 91.2 | 18 | 3 | 1382 | 1832 | 1661 |
| | 16 | 288306 | 56.5 | 18 | 1 | 1483 | - | - |
| | 17 | 441296 | 51.2 | 18 | 1 | 1237 | - | - |
| | 18 | 592780 | 74.1 | 18 | 2 | 1471 | 1245 | - |

| 15 | Type 5 | 14 | 0.857143 | 12 | 5.5363 | | | |
|----|----------|-------------------|------------------|-------------------|----------------------------|------------|------------|------------|
| | Burst ID | Burst Offset (us) | Pulse Width (us) | Chirp Width (MHz) | Number of Pulses per Burst | PRI-1 (us) | PRI-2 (us) | PRI-3 (us) |
| | 0 | 158286 | 76.9 | 12 | 2 | 1110 | 1140 | - |
| | 1 | 366024 | 50.2 | 12 | 1 | 1316 | - | - |
| | 2 | 573452 | 62.9 | 12 | 1 | 1520 | - | - |
| | 3 | 780619 | 64.7 | 12 | 1 | 1902 | - | - |
| | 4 | 132455 | 83.8 | 12 | 3 | 1410 | 1097 | 1621 |
| | 5 | 340207 | 65.4 | 12 | 1 | 1944 | - | - |
| | 6 | 548208 | 53.2 | 12 | 1 | 1024 | - | - |
| | 7 | 755333 | 51.7 | 12 | 1 | 1603 | - | - |
| | 8 | 107117 | 78.7 | 12 | 2 | 1804 | 1168 | - |
| | 9 | 314500 | 72.4 | 12 | 2 | 1030 | 1343 | - |
| | 10 | 522447 | 53.8 | 12 | 1 | 1327 | - | - |
| | 11 | 728517 | 73.6 | 12 | 2 | 1524 | 1553 | - |
| | 12 | 81611 | 66.7 | 12 | 2 | 1722 | 1122 | - |
| | 13 | 288948 | 82.5 | 12 | 2 | 1404 | 1019 | - |

| Trial ID | Radar Type | Number of Bursts | Burst Period(s) | Wave from Length (s) | Center Frequency(GHz) | - | | |
|----------|------------|-------------------|------------------|----------------------|----------------------------|------------|------------|------------|
| 16 | Type 5 | 20 | 0.6 | 12 | 5.5395 | | | |
| | Burst ID | Burst Offset (us) | Pulse Width (us) | Chirp Width (MHz) | Number of Pulses per Burst | PRI-1 (us) | PRI-2 (us) | PRI-3 (us) |
| | 0 | 345766 | 87.6 | 20 | 3 | 1565 | 1055 | 1840 |
| | 1 | 490019 | 85.2 | 20 | 3 | 1735 | 1541 | 1408 |
| | 2 | 39073 | 84.8 | 20 | 3 | 1534 | 1889 | 1463 |
| | 3 | 183923 | 77.9 | 20 | 2 | 1749 | 1460 | - |
| | 4 | 328777 | 76.5 | 20 | 2 | 1518 | 1485 | - |
| | 5 | 474728 | 60.9 | 20 | 1 | 1540 | - | - |
| | 6 | 21394 | 83 | 20 | 2 | 1080 | 1010 | - |
| | 7 | 165992 | 80.4 | 20 | 2 | 1824 | 1752 | - |
| | 8 | 310973 | 67.5 | 20 | 2 | 1764 | 1181 | - |
| | 9 | 456884 | 62.1 | 20 | 1 | 1495 | - | - |
| | 10 | 3515 | 86.4 | 20 | 3 | 1773 | 1966 | 1263 |
| | 11 | 147928 | 84.3 | 20 | 3 | 1593 | 1188 | 1788 |
| | 12 | 293225 | 76.9 | 20 | 2 | 1226 | 1537 | - |
| | 13 | 436922 | 95.8 | 20 | 3 | 1192 | 1298 | 1844 |
| | 14 | 584015 | 55.2 | 20 | 1 | 1644 | - | - |
| | 15 | 130832 | 59 | 20 | 1 | 1402 | - | - |
| | 16 | 274684 | 94.5 | 20 | 3 | 1296 | 1700 | 1283 |
| | 17 | 418579 | 91.9 | 20 | 3 | 1970 | 1978 | 1165 |
| | 18 | 563464 | 85.2 | 20 | 3 | 1732 | 1551 | 1189 |
| | 19 | 112787 | 69.5 | 20 | 2 | 1038 | 1224 | - |
| 17 | Type 5 | 12 | 1 | 12 | 5.5355 | | | |
| | Burst ID | Burst Offset (us) | Pulse Width (us) | Chirp Width (MHz) | Number of Pulses per Burst | PRI-1 (us) | PRI-2 (us) | PRI-3 (us) |
| | 0 | 429224 | 86.4 | 10 | 3 | 1259 | 1918 | 1455 |
| | 1 | 670241 | 92.2 | 10 | 3 | 1598 | 1719 | 1895 |
| | 2 | 912880 | 80.4 | 10 | 2 | 1816 | 1899 | - |
| | 3 | 158603 | 54.3 | 10 | 1 | 1335 | - | - |
| | 4 | 400824 | 53.1 | 10 | 1 | 1303 | - | - |
| | 5 | 641915 | 69.4 | 10 | 2 | 1503 | 1546 | - |
| | 6 | 883823 | 69.1 | 10 | 2 | 1279 | 1639 | - |
| | 7 | 128373 | 100 | 10 | 3 | 1375 | 1438 | 1595 |
| | 8 | 370379 | 79.6 | 10 | 2 | 1239 | 1705 | - |
| | 9 | 611194 | 88.4 | 10 | 3 | 1374 | 1579 | 1623 |
| | 10 | 855665 | 53.3 | 10 | 1 | 1016 | - | - |
| | 11 | 98897 | 65.3 | 10 | 1 | 1709 | - | - |

| Trial ID | Radar Type | Number of Bursts | Burst Period(s) | Wave from Length (s) | Center Frequency(GHz) | - | | |
|----------|------------|-------------------|------------------|----------------------|----------------------------|------------|------------|------------|
| 18 | Type 5 | 14 | 0.857143 | 12 | 5.5363 | | | |
| | Burst ID | Burst Offset (us) | Pulse Width (us) | Chirp Width (MHz) | Number of Pulses per Burst | PRI-1 (us) | PRI-2 (us) | PRI-3 (us) |
| | 0 | 292143 | 55.3 | 12 | 1 | 1920 | - | - |
| | 1 | 499633 | 58.3 | 12 | 1 | 1797 | - | - |
| | 2 | 708377 | 72.3 | 12 | 2 | 1610 | 1039 | - |
| | 3 | 58989 | 84.8 | 12 | 3 | 1131 | 1761 | 1721 |
| | 4 | 266161 | 82.5 | 12 | 2 | 1875 | 1431 | - |
| | 5 | 474469 | 63.3 | 12 | 1 | 1095 | - | - |
| | 6 | 680544 | 80 | 12 | 2 | 1119 | 1913 | - |
| | 7 | 33519 | 90.3 | 12 | 3 | 1660 | 1853 | 1123 |
| | 8 | 240319 | 91.1 | 12 | 3 | 1539 | 1783 | 1172 |
| | 9 | 447400 | 96.6 | 12 | 3 | 1525 | 1036 | 1385 |
| | 10 | 654516 | 82.7 | 12 | 2 | 1710 | 1990 | - |
| | 11 | 8083 | 50.7 | 12 | 1 | 1234 | - | - |
| | 12 | 215435 | 78.4 | 12 | 2 | 1047 | 1109 | - |
| | 13 | 421325 | 99.5 | 12 | 3 | 1299 | 1965 | 1869 |
| 19 | Type 5 | 12 | 1 | 12 | 5.5355 | | | |
| | Burst ID | Burst Offset (us) | Pulse Width (us) | Chirp Width (MHz) | Number of Pulses per Burst | PRI-1 (us) | PRI-2 (us) | PRI-3 (us) |
| | 0 | 733725 | 88.6 | 10 | 3 | 1501 | 1067 | 1927 |
| | 1 | 977882 | 57.4 | 10 | 1 | 1723 | - | - |
| | 2 | 221197 | 96.6 | 10 | 3 | 1086 | 1658 | 1324 |
| | 3 | 462915 | 69.7 | 10 | 2 | 1751 | 1945 | - |
| | 4 | 705071 | 77.9 | 10 | 2 | 1642 | 1317 | - |
| | 5 | 947923 | 62 | 10 | 1 | 1866 | - | - |
| | 6 | 191373 | 88.4 | 10 | 3 | 1997 | 1077 | 1366 |
| | 7 | 432561 | 97.3 | 10 | 3 | 1790 | 1896 | 1367 |
| | 8 | 674004 | 96.2 | 10 | 3 | 1391 | 1787 | 1672 |
| | 9 | 915842 | 95.4 | 10 | 3 | 1020 | 1892 | 1414 |
| | 10 | 162176 | 54.8 | 10 | 1 | 1084 | - | - |
| | 11 | 403553 | 80.4 | 10 | 2 | 1850 | 1436 | - |

| Trial ID | Radar Type | Number of Bursts | Burst Period(s) | Wave from Length (s) | Center Frequency(GHz) | - | | |
|----------|------------|-------------------|------------------|----------------------|----------------------------|------------|------------|------------|
| 20 | Type 5 | 16 | 0.75 | 12 | 5.5625 | | | |
| | Burst ID | Burst Offset (us) | Pulse Width (us) | Chirp Width (MHz) | Number of Pulses per Burst | PRI-1 (us) | PRI-2 (us) | PRI-3 (us) |
| | 0 | 483470 | 74.7 | 15 | 2 | 1619 | 1611 | - |
| | 1 | 666072 | 57.1 | 15 | 1 | 1560 | - | - |
| | 2 | 98810 | 91.9 | 15 | 3 | 1392 | 1475 | 1276 |
| | 3 | 279914 | 83.1 | 15 | 2 | 1809 | 1772 | - |
| | 4 | 462536 | 50.7 | 15 | 1 | 1003 | - | - |
| | 5 | 642324 | 79.2 | 15 | 2 | 1574 | 1600 | - |
| | 6 | 76831 | 58.7 | 15 | 1 | 1186 | - | - |
| | 7 | 257785 | 71 | 15 | 2 | 1521 | 1567 | - |
| | 8 | 438554 | 79 | 15 | 2 | 1777 | 1960 | - |
| | 9 | 620397 | 68.5 | 15 | 2 | 1284 | 1428 | - |
| | 10 | 54310 | 73.5 | 15 | 2 | 1904 | 1352 | - |
| | 11 | 235506 | 70.5 | 15 | 2 | 1864 | 1115 | - |
| | 12 | 417036 | 76.6 | 15 | 2 | 1045 | 1300 | - |
| | 13 | 597974 | 81.2 | 15 | 2 | 1160 | 1675 | - |
| | 14 | 32086 | 61.8 | 15 | 1 | 1277 | - | - |
| | 15 | 212751 | 94.9 | 15 | 3 | 1450 | 1206 | 1860 |
| 21 | Type 5 | 12 | 1 | 12 | 5.5649 | | | |
| | Burst ID | Burst Offset (us) | Pulse Width (us) | Chirp Width (MHz) | Number of Pulses per Burst | PRI-1 (us) | PRI-2 (us) | PRI-3 (us) |
| | 0 | 526149 | 78.5 | 9 | 2 | 1653 | 1698 | - |
| | 1 | 767135 | 89.8 | 9 | 3 | 1174 | 1962 | 1167 |
| | 2 | 12955 | 59.4 | 9 | 1 | 1982 | - | - |
| | 3 | 254612 | 79.6 | 9 | 2 | 1633 | 1890 | - |
| | 4 | 496588 | 76 | 9 | 2 | 1112 | 1811 | - |
| | 5 | 739728 | 53.6 | 9 | 1 | 1144 | - | - |
| | 6 | 980872 | 80.9 | 9 | 2 | 1220 | 1053 | - |
| | 7 | 225249 | 61.6 | 9 | 1 | 1724 | - | - |
| | 8 | 467279 | 53.4 | 9 | 1 | 1901 | - | - |
| | 9 | 709720 | 59.9 | 9 | 1 | 1379 | - | - |
| | 10 | 951847 | 60.4 | 9 | 1 | 1453 | - | - |
| | 11 | 194839 | 91.4 | 9 | 3 | 1768 | 1726 | 1227 |

| Trial ID | Radar Type | Number of Bursts | Burst Period(s) | Wave from Length (s) | Center Frequency(GHz) | - | | |
|----------|------------|-------------------|------------------|----------------------|----------------------------|------------|------------|------------|
| 22 | Type 5 | 20 | 0.6 | 12 | 5.5605 | | | |
| | Burst ID | Burst Offset (us) | Pulse Width (us) | Chirp Width (MHz) | Number of Pulses per Burst | PRI-1 (us) | PRI-2 (us) | PRI-3 (us) |
| | 0 | 261858 | 77 | 20 | 2 | 1191 | 1363 | - |
| | 1 | 407646 | 58.1 | 20 | 1 | 1248 | - | - |
| | 2 | 552319 | 62.1 | 20 | 1 | 1836 | - | - |
| | 3 | 99107 | 76.9 | 20 | 2 | 1334 | 1236 | - |
| | 4 | 243514 | 80 | 20 | 2 | 1914 | 1852 | - |
| | 5 | 389484 | 52 | 20 | 1 | 1701 | - | - |
| | 6 | 531093 | 88.6 | 20 | 3 | 1693 | 1995 | 1905 |
| | 7 | 81159 | 72.9 | 20 | 2 | 1922 | 1387 | - |
| | 8 | 225245 | 98.5 | 20 | 3 | 1839 | 1746 | 1389 |
| | 9 | 371906 | 57.9 | 20 | 1 | 1193 | - | - |
| | 10 | 514197 | 95.9 | 20 | 3 | 1659 | 1870 | 1066 |
| | 11 | 63561 | 53.5 | 20 | 1 | 1162 | - | - |
| | 12 | 207510 | 92 | 20 | 3 | 1745 | 1654 | 1458 |
| | 13 | 353638 | 57.3 | 20 | 1 | 1834 | - | - |
| | 14 | 497515 | 70.5 | 20 | 2 | 1684 | 1586 | - |
| | 15 | 45553 | 70 | 20 | 2 | 1042 | 1664 | - |
| | 16 | 189821 | 84 | 20 | 3 | 1765 | 1630 | 1176 |
| | 17 | 335330 | 76.1 | 20 | 2 | 1557 | 1057 | - |
| | 18 | 478825 | 93.2 | 20 | 3 | 1985 | 1018 | 1340 |
| | 19 | 27594 | 96.8 | 20 | 3 | 1760 | 1614 | 1817 |

| 23 | Type 5 | 14 | 0.857143 | 12 | 5.5637 | | | |
|----|----------|-------------------|------------------|-------------------|----------------------------|------------|------------|------------|
| | Burst ID | Burst Offset (us) | Pulse Width (us) | Chirp Width (MHz) | Number of Pulses per Burst | PRI-1 (us) | PRI-2 (us) | PRI-3 (us) |
| | 0 | 247117 | 50.1 | 12 | 1 | 1841 | - | - |
| | 1 | 453362 | 93.5 | 12 | 3 | 1590 | 1081 | 1413 |
| | 2 | 660875 | 68.8 | 12 | 2 | 1707 | 1577 | - |
| | 3 | 14140 | 56.3 | 12 | 1 | 1056 | - | - |
| | 4 | 220734 | 86 | 12 | 3 | 1953 | 1108 | 1987 |
| | 5 | 428367 | 75.2 | 12 | 2 | 1572 | 1536 | - |
| | 6 | 636681 | 54.4 | 12 | 1 | 1517 | - | - |
| | 7 | 843157 | 71.1 | 12 | 2 | 1329 | 1243 | - |
| | 8 | 195585 | 76.2 | 12 | 2 | 1940 | 1770 | - |
| | 9 | 403231 | 80.2 | 12 | 2 | 1098 | 1209 | - |
| | 10 | 610202 | 79.7 | 12 | 2 | 1588 | 1214 | - |
| | 11 | 815229 | 90.9 | 12 | 3 | 1615 | 1862 | 1601 |
| | 12 | 170267 | 68.7 | 12 | 2 | 1377 | 1441 | - |
| | 13 | 377306 | 67.4 | 12 | 2 | 1872 | 1313 | - |

| Trial ID | Radar Type | Number of Bursts | Burst Period(s) | Wave from Length (s) | Center Frequency(GHz) | - | | |
|----------|------------|-------------------|------------------|----------------------|----------------------------|------------|------------|------------|
| 24 | Type 5 | 13 | 0.923077 | 12 | 5.5641 | | | |
| | Burst ID | Burst Offset (us) | Pulse Width (us) | Chirp Width (MHz) | Number of Pulses per Burst | PRI-1 (us) | PRI-2 (us) | PRI-3 (us) |
| | 0 | 628071 | 94 | 11 | 3 | 1643 | 1748 | 1941 |
| | 1 | 853391 | 70.8 | 11 | 2 | 1177 | 1201 | - |
| | 2 | 156223 | 58.3 | 11 | 1 | 1008 | - | - |
| | 3 | 378734 | 96.7 | 11 | 3 | 1230 | 1163 | 1332 |
| | 4 | 601331 | 90.6 | 11 | 3 | 1217 | 1582 | 1498 |
| | 5 | 825462 | 74.5 | 11 | 2 | 1569 | 1281 | - |
| | 6 | 128265 | 92.6 | 11 | 3 | 1065 | 1669 | 1222 |
| | 7 | 351161 | 89 | 11 | 3 | 1493 | 1135 | 1380 |
| | 8 | 573425 | 96.5 | 11 | 3 | 1607 | 1822 | 1602 |
| | 9 | 798431 | 70.5 | 11 | 2 | 1141 | 1178 | - |
| | 10 | 100737 | 94 | 11 | 3 | 1009 | 1629 | 1956 |
| | 11 | 324661 | 55.8 | 11 | 1 | 1290 | - | - |
| | 12 | 546278 | 87.7 | 11 | 3 | 1435 | 1963 | 1164 |
| 25 | Type 5 | 8 | 1.5 | 12 | 5.5665 | | | |
| | Burst ID | Burst Offset (us) | Pulse Width (us) | Chirp Width (MHz) | Number of Pulses per Burst | PRI-1 (us) | PRI-2 (us) | PRI-3 (us) |
| | 0 | 1253942 | 68.6 | 5 | 2 | 1306 | 1161 | - |
| | 1 | 119486 | 83.1 | 5 | 2 | 1420 | 1315 | - |
| | 2 | 482958 | 60.9 | 5 | 1 | 1687 | - | - |
| | 3 | 845641 | 77.7 | 5 | 2 | 1776 | 1158 | - |
| | 4 | 1208428 | 77.4 | 5 | 2 | 1793 | 1510 | - |
| | 5 | 74748 | 66.8 | 5 | 2 | 1576 | 1323 | - |
| | 6 | 438300 | 63.7 | 5 | 1 | 1333 | - | - |
| | 7 | 800152 | 91.2 | 5 | 3 | 1409 | 1681 | 1275 |

| Trial ID | Radar Type | Number of Bursts | Burst Period(s) | Wave from Length (s) | Center Frequency(GHz) | - | | |
|----------|------------|-------------------|------------------|----------------------|----------------------------|------------|------------|------------|
| 26 | Type 5 | 17 | 0.705882 | 12 | 5.5621 | | | |
| | Burst ID | Burst Offset (us) | Pulse Width (us) | Chirp Width (MHz) | Number of Pulses per Burst | PRI-1 (us) | PRI-2 (us) | PRI-3 (us) |
| | 0 | 545865 | 83.6 | 16 | 3 | 1632 | 1195 | 1000 |
| | 1 | 14067 | 89.4 | 16 | 3 | 1173 | 1627 | 1656 |
| | 2 | 184953 | 55.8 | 16 | 1 | 1532 | - | - |
| | 3 | 353759 | 90.9 | 16 | 3 | 1981 | 1554 | 1998 |
| | 4 | 526388 | 54.7 | 16 | 1 | 1825 | - | - |
| | 5 | 694806 | 97.7 | 16 | 3 | 1734 | 1202 | 1250 |
| | 6 | 163568 | 67.5 | 16 | 2 | 1571 | 1434 | - |
| | 7 | 333410 | 96.7 | 16 | 3 | 1589 | 1469 | 1268 |
| | 8 | 504006 | 68.3 | 16 | 2 | 1750 | 1954 | - |
| | 9 | 675297 | 78.3 | 16 | 2 | 1591 | 1082 | - |
| | 10 | 142890 | 55 | 16 | 1 | 1427 | - | - |
| | 11 | 312479 | 84.9 | 16 | 3 | 1129 | 1936 | 1199 |
| | 12 | 482953 | 74.6 | 16 | 2 | 1959 | 1856 | - |
| | 13 | 656022 | 63.3 | 16 | 1 | 1885 | - | - |
| | 14 | 121457 | 99.8 | 16 | 3 | 1035 | 1515 | 1120 |
| | 15 | 292606 | 63.6 | 16 | 1 | 1647 | - | - |
| | 16 | 461322 | 87.3 | 16 | 3 | 1931 | 1051 | 1831 |

| Trial ID | Radar Type | Number of Bursts | Burst Period(s) | Wave from Length (s) | Center Frequency(GHz) | - | | |
|----------|------------|-------------------|------------------|----------------------|----------------------------|------------|------------|------------|
| 27 | Type 5 | 19 | 0.631579 | 12 | 5.5609 | | | |
| | Burst ID | Burst Offset (us) | Pulse Width (us) | Chirp Width (MHz) | Number of Pulses per Burst | PRI-1 (us) | PRI-2 (us) | PRI-3 (us) |
| | 0 | 565136 | 85.6 | 19 | 3 | 1946 | 1078 | 1015 |
| | 1 | 89970 | 68.6 | 19 | 2 | 1029 | 1780 | - |
| | 2 | 243121 | 54.2 | 19 | 1 | 1111 | - | - |
| | 3 | 396034 | 61.2 | 19 | 1 | 1104 | - | - |
| | 4 | 546225 | 97.1 | 19 | 3 | 1157 | 1969 | 1100 |
| | 5 | 70998 | 98.3 | 19 | 3 | 1142 | 1699 | 1622 |
| | 6 | 224093 | 62.4 | 19 | 1 | 1655 | - | - |
| | 7 | 376127 | 80.2 | 19 | 2 | 1126 | 1769 | - |
| | 8 | 527806 | 87.5 | 19 | 3 | 1216 | 1448 | 1179 |
| | 9 | 52247 | 85.8 | 19 | 3 | 1847 | 1348 | 1472 |
| | 10 | 204582 | 88.1 | 19 | 3 | 1023 | 1124 | 1631 |
| | 11 | 357941 | 65.3 | 19 | 1 | 1848 | - | - |
| | 12 | 510977 | 52.5 | 19 | 1 | 1470 | - | - |
| | 13 | 33698 | 52.3 | 19 | 1 | 1312 | - | - |
| | 14 | 186023 | 74.1 | 19 | 2 | 1915 | 1200 | - |
| | 15 | 339327 | 54.9 | 19 | 1 | 1479 | - | - |
| | 16 | 491053 | 76.2 | 19 | 2 | 1376 | 1502 | - |
| | 17 | 14858 | 60.4 | 19 | 1 | 1758 | - | - |
| | 18 | 167387 | 81.5 | 19 | 2 | 1491 | 1103 | - |

| 28 | Type 5 | 12 | 1 | 12 | 5.5645 | | | |
|----|----------|-------------------|------------------|-------------------|----------------------------|------------|------------|------------|
| | Burst ID | Burst Offset (us) | Pulse Width (us) | Chirp Width (MHz) | Number of Pulses per Burst | PRI-1 (us) | PRI-2 (us) | PRI-3 (us) |
| | 0 | 507709 | 50.5 | 10 | 1 | 1857 | - | - |
| | 1 | 750249 | 55.7 | 10 | 1 | 1246 | - | - |
| | 2 | 989003 | 85.8 | 10 | 3 | 1774 | 1002 | 1967 |
| | 3 | 235634 | 76.9 | 10 | 2 | 1125 | 1474 | - |
| | 4 | 477675 | 75.1 | 10 | 2 | 1254 | 1052 | - |
| | 5 | 718312 | 92.3 | 10 | 3 | 1180 | 1486 | 1492 |
| | 6 | 960895 | 78.1 | 10 | 2 | 1301 | 1757 | - |
| | 7 | 205370 | 92.2 | 10 | 3 | 1898 | 1252 | 1713 |
| | 8 | 446940 | 89 | 10 | 3 | 1280 | 1706 | 1411 |
| | 9 | 689225 | 70.9 | 10 | 2 | 1578 | 1620 | - |
| | 10 | 932305 | 63.1 | 10 | 1 | 1782 | - | - |
| | 11 | 176231 | 55.3 | 10 | 1 | 1522 | - | - |

| Trial ID | Radar Type | Number of Bursts | Burst Period(s) | Wave from Length (s) | Center Frequency(GHz) | - | | |
|----------|------------|-------------------|------------------|----------------------|----------------------------|------------|------------|------------|
| 29 | Type 5 | 18 | 0.666667 | 12 | 5.5617 | | | |
| | Burst ID | Burst Offset (us) | Pulse Width (us) | Chirp Width (MHz) | Number of Pulses per Burst | PRI-1 (us) | PRI-2 (us) | PRI-3 (us) |
| | 0 | 277485 | 83.4 | 17 | 3 | 1454 | 1205 | 1801 |
| | 1 | 437880 | 97.3 | 17 | 3 | 1319 | 1826 | 1635 |
| | 2 | 598445 | 90.4 | 17 | 3 | 1079 | 1996 | 1674 |
| | 3 | 97088 | 91.8 | 17 | 3 | 1563 | 1151 | 1802 |
| | 4 | 257251 | 98.2 | 17 | 3 | 1876 | 1977 | 1766 |
| | 5 | 419893 | 59.5 | 17 | 1 | 1952 | - | - |
| | 6 | 580724 | 80 | 17 | 2 | 1253 | 1137 | - |
| | 7 | 77366 | 86.5 | 17 | 3 | 1054 | 1128 | 1828 |
| | 8 | 238032 | 91.1 | 17 | 3 | 1105 | 1599 | 1442 |
| | 9 | 398605 | 93.5 | 17 | 3 | 1867 | 1373 | 1087 |
| | 10 | 562025 | 60.7 | 17 | 1 | 1033 | - | - |
| | 11 | 57684 | 67.2 | 17 | 2 | 1288 | 1405 | - |
| | 12 | 219083 | 61.8 | 17 | 1 | 1585 | - | - |
| | 13 | 379234 | 79.4 | 17 | 2 | 1933 | 1667 | - |
| | 14 | 540896 | 81.4 | 17 | 2 | 1096 | 1464 | - |
| | 15 | 37916 | 65.7 | 17 | 1 | 1496 | - | - |
| | 16 | 198794 | 76 | 17 | 2 | 1733 | 1255 | - |
| | 17 | 359754 | 81 | 17 | 2 | 1326 | 1668 | - |

Radar Singal 6

| Trial ID | Radar Type | Pulse Width (us) | PRI (us) | Number of Pulses | Waveform Legth (us) | Pulse Repection Frequency (Pulses Per Second) | Pulse Repection Interval (Microseconds) |
|----------|------------|------------------|----------|------------------|---------------------|---|---|
| 0 | Type 6 | 1 | 333.3 | 9 | 0.3333 | 3000 | 17 |
| 1 | Type 6 | 1 | 333.3 | 9 | 0.3333 | 3000 | 13 |
| 2 | Type 6 | 1 | 333.3 | 9 | 0.3333 | 3000 | 14 |
| 3 | Type 6 | 1 | 333.3 | 9 | 0.3333 | 3000 | 19 |
| 4 | Type 6 | 1 | 333.3 | 9 | 0.3333 | 3000 | 11 |
| 5 | Type 6 | 1 | 333.3 | 9 | 0.3333 | 3000 | 13 |
| 6 | Type 6 | 1 | 333.3 | 9 | 0.3333 | 3000 | 13 |
| 7 | Type 6 | 1 | 333.3 | 9 | 0.3333 | 3000 | 17 |
| 8 | Type 6 | 1 | 333.3 | 9 | 0.3333 | 3000 | 15 |
| 9 | Type 6 | 1 | 333.3 | 9 | 0.3333 | 3000 | 17 |
| 10 | Type 6 | 1 | 333.3 | 9 | 0.3333 | 3000 | 16 |
| 11 | Type 6 | 1 | 333.3 | 9 | 0.3333 | 3000 | 23 |
| 12 | Type 6 | 1 | 333.3 | 9 | 0.3333 | 3000 | 22 |
| 13 | Type 6 | 1 | 333.3 | 9 | 0.3333 | 3000 | 16 |
| 14 | Type 6 | 1 | 333.3 | 9 | 0.3333 | 3000 | 15 |
| 15 | Type 6 | 1 | 333.3 | 9 | 0.3333 | 3000 | 21 |
| 16 | Type 6 | 1 | 333.3 | 9 | 0.3333 | 3000 | 14 |
| 17 | Type 6 | 1 | 333.3 | 9 | 0.3333 | 3000 | 22 |
| 18 | Type 6 | 1 | 333.3 | 9 | 0.3333 | 3000 | 12 |
| 19 | Type 6 | 1 | 333.3 | 9 | 0.3333 | 3000 | 17 |
| 20 | Type 6 | 1 | 333.3 | 9 | 0.3333 | 3000 | 20 |
| 21 | Type 6 | 1 | 333.3 | 9 | 0.3333 | 3000 | 18 |
| 22 | Type 6 | 1 | 333.3 | 9 | 0.3333 | 3000 | 23 |
| 23 | Type 6 | 1 | 333.3 | 9 | 0.3333 | 3000 | 14 |
| 24 | Type 6 | 1 | 333.3 | 9 | 0.3333 | 3000 | 13 |
| 25 | Type 6 | 1 | 333.3 | 9 | 0.3333 | 3000 | 16 |
| 26 | Type 6 | 1 | 333.3 | 9 | 0.3333 | 3000 | 15 |
| 27 | Type 6 | 1 | 333.3 | 9 | 0.3333 | 3000 | 19 |
| 28 | Type 6 | 1 | 333.3 | 9 | 0.3333 | 3000 | 18 |
| 29 | Type 6 | 1 | 333.3 | 9 | 0.3333 | 3000 | 15 |

Channel Move Time & Channel Closing Transmission Time

IEEE 802.11ac

Channel 58 / 5290 MHz

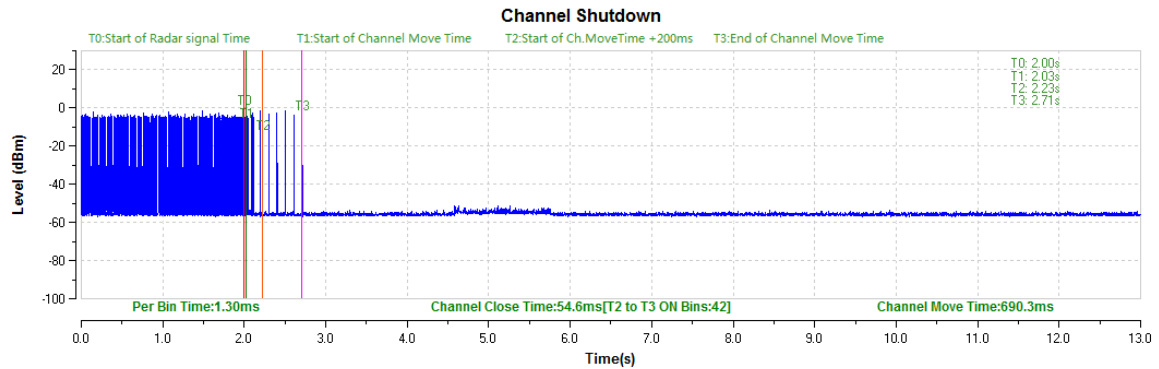

| Channel Move Time | Limit |
|--------------------|-------|
| 0.690s | 10s |
| Channel Close Time | Limit |
| 54.6ms | 60ms |

IEEE 802.11ac

Channel 106 / 5530 MHz

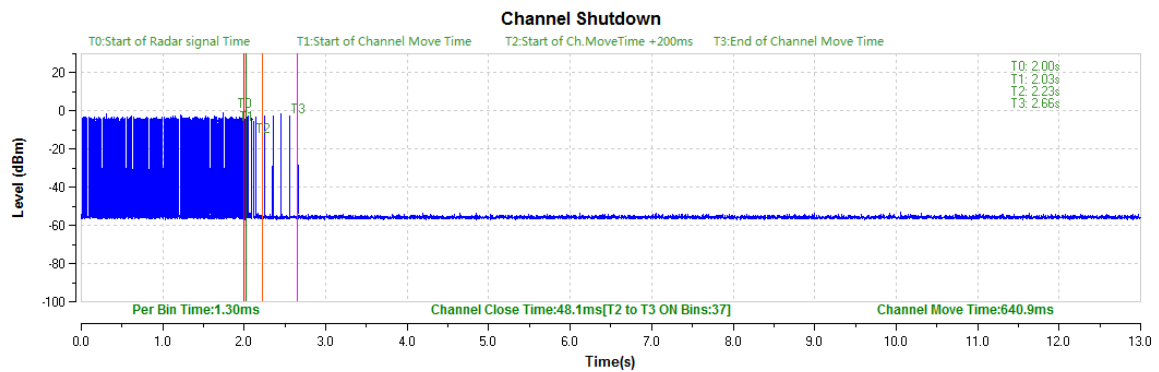

| Channel Move Time | Limit |
|--------------------|-------|
| 0.641s | 10s |
| Channel Close Time | Limit |
| 48.1ms | 60ms |

Notes: A20/N40/AC 80 were tested, the report recorded the worst result of AC mode.

9. LIST OF MEASURING EQUIPMENTS

| Item | Model / Equipment | Manufacturer | Serial No. | Cal Date | Due Date |
|------|--|------------------------|-----------------------------------|------------|------------|
| 1 | WEA453e / Wireless AP (Master Device) | SAMSUNG ELECTRONICS | S2LF812265 (FCC ID:A3LWEA453E) | N/A | N/A |
| 2 | PXI/DFS Measurement System(S/G) | ADLINK | 302581/735 | 2020-11-17 | 2021-11-16 |
| 3 | PXI/DFS Measurement System(S/A) | ADLINK | 303582/113 | 2020-11-17 | 2021-11-16 |
| 4 | N9020A / Signal Analyzer | Agilent | MY52090906 | 2020-11-17 | 2021-11-16 |
| 5 | 11636B/Power Divider | Hewlett Packard | 0531 | 2020-11-17 | 2021-11-16 |
| 6 | 11667B / Power Splitter | Hewlett Packard | 05001 | 2020-11-17 | 2021-11-16 |
| 7 | 8493C / Attenuator(10 dB) | Agilent | 07560 | 2020-11-17 | 2021-11-16 |
| 8 | 2-3 / Attenuator(3 dB) | WEINSCHEL | BR0617 | 2020-11-17 | 2021-11-16 |
| 9 | AF9003-69-31 / Step Attenuator | Weinschel | 5701 | 2020-11-17 | 2021-11-16 |
| 10 | CDPU5260404K / 4 Way Power Divider | Cernex | 14695 | 2020-11-17 | 2021-11-16 |
| 11 | 4426-4 / 4 Way Power Divider | Narda | 11927 | 2020-11-27 | 2021-11-26 |

10. TEST SETUP PHOTOGRAPHS OF EUT

Please refer to separated files for Test Setup Photos of the EUT.

11. EXTERIOR PHOTOGRAPHS OF THE EUT

Please refer to separated files for External Photos of the EUT.

12. INTERIOR PHOTOGRAPHS OF THE EUT

Please refer to separated files for Internal Photos of the EUT.

-----THE END OF REPORT-----