



FCC Test Report

Report No: FCS202104050W01

Issued for

Applicant:	Shenzhen Engot Electronic Technology Co.,Ltd
Address:	E207 hedong mansion haoyunlai square xixiang road baoan area, Shenzhen, Guangdong, China
Product Name:	UHF wireless microphone system
Brand Name:	BOMGE
Model Name:	BG-250U
Series Model:	BG-260U,BG-280U,BG-228U,BG-210U,U-260,U-250,U-280,U-210,U-220
FCC ID:	2AZWQ-BG250U
Issued By: Flux Compliance Service Laboratory Add: Room 105 Floor Bao hao Technology Building 1 NO.15 Gong ye West Road Hi-Tech Industrial, Song shan lake Dongguan Tel: 769-27280901 Fax:769-27280901 http://www.fcs-lab.com	

TEST RESULT CERTIFICATION

Applicant's Name.....: Shenzhen Engot Electronic Technology Co.,Ltd
Address.....: E207 hedong mansion haoyunlai square xixiang road baoan area,
Shenzhen, Guangdong, China
Manufacture's Name.....: Enping Xiehe Audio Equipment Factory
Address.....: Enping Xiehe Professional Audio Equipment Factory, DongAn Industrial
Zone, Enping City, Guangdong Province, China,529400

Product Description

Product Name.....: UHF wireless microphone system
Brand Name: BOMGE
Model Name.....: BG-250U
Series Model.....: BG-260U,BG-280U,BG-228U,BG-210U,U-260,U-250,U-280,
U-210,U-220
Test Standards.....: FCC Rules and Regulations Part 15 Subpart C section 15.236
Test Procedure.....: ANSI C63.10:2013

This device described above has been tested FCS, the test results show that the equipment under test (EUT) is in compliance with the FCC requirements. And it is applicable only to the tested sample identified in the report.

This report shall not be reproduced except in full, without the written approval of FCS, this document may be altered or revised by FCS, personal only, and shall be noted in the revision of the document..

Date of Test.....:

Date (s) of performance of tests.: 15 May. 2021 ~ 03 Jun. 2021

Date of Issue.....: 03 Jun. 2021

Test Result.....: Pass

Tested by

:

Scott Shen

(Scott Shen)

Reviewed by

:

Duke Qian

(Duke Qian)

Approved by

:

Kait Chen

(Kait Chen)

Table of Contents

	Page
1. SUMMARY OF TEST RESULTS	5
1.1 TEST FACTORY	6
1.2 MEASUREMENT UNCERTAINTY	6
2. GENERAL INFORMATION	7
2.1 GENERAL DESCRIPTION OF THE EUT	7
2.2 DESCRIPTION OF THE TEST MODES	9
2.3 DESCRIPTION OF NECESSARY ACCESSORIES AND SUPPORT UNITS	10
2.4 EQUIPMENTS LIST	11
3 MAXIMUM RADIATED POWER	12
3.1 LIMIT	12
3.3 TEST SETUP	12
3.4 TEST RESULTS	12
4. OCCUPIED BANDWIDTH	13
4.1 LIMIT	13
4.2 TEST PROCEDURE	13
.4.3 TEST SETUP	13
4.4 TEST RESULTS	14
5 NECESSARY BANDWIDTH	15
5.1 LIMIT	15
5.2 TEST PROCEDURE	15
5.3 TEST SETUP	15
6. TRANSMITTER UNWANTED EMISSIONS	17
6.1 LIMIT	17
5.2 TEST PROCEDURE	17
5.3 TEST SETUP	17
6.4 TEST RESULTS	18
7. FREQUENCY STABILITY	22
7.1 LIMIT	22
7.2 TEST PROCEDURE	22
7.3 TEST SETUP	22
7.4 TEST RESULTS	23

Revision History

Rev.	Issue Date	Effect Page	Contents
00	03 Jun. 2021	All	Initial Issue

1. SUMMARY OF TEST RESULTS

FCC Part 15 Subpart C section 15.236			
Standard Section	Test Item	Judgment	Remark
FCC Part 15.236(d)	Maximum Radiated Power	PASS	--
FCC Part 15.236(f)(2)	Occupied Bandwidth	PASS	--
FCC Part 15.236(g)	Necessary bandwidth	PASS	--
FCC Part 15.236(f)(3)	Frequency stability	PASS	--
FCC Part 15.236(g)	Emission within the band and outside this band	PASS	--
FCC Part 207(a)	Conducted Emission	NA	--

NOTE:

- (1) "N/A" denotes test is not applicable in this Test Report
- (2) All tests are according to ANSI C63.10:2013

1.1 TEST FACTORY

Company Name:	Flux Compliance Service Laboratory
Address:	Room 105 Floor Bao hao Technology Building 1 NO.15 Gong ye West Road Hi-Tech Industrial, Song shan lake Dongguan
Telephone:	+86-769-27280901
Fax:	+86-769-27280901
FCC Test Firm Registration Number: 514908 Designation number: CN0127 A2LA accreditation number: 5545.01	

1.2 MEASUREMENT UNCERTAINTY

The reported uncertainty of measurement $y \pm U$, where expanded uncertainty U is based on a standard uncertainty multiplied by a coverage factor of $k=2$, providing a level of confidence of approximately **95** %.

No.	Item	Uncertainty
1	RF output power, conducted	± 0.71 dB
2	Unwanted Emissions, conducted	± 2.98 dB
3	Conducted Emission (9KHz-150KHz)	± 4.13 dB
4	Conducted Emission (150KHz-30MHz)	± 4.74 dB
5	All emissions,radiated(<1G) 30MHz-1000MHz	± 3.2 dB
6	All emissions,radiated (1GHz -18GHz)	± 3.66 dB
7	All emissions,radiated (18GHz -40GHz)	± 4.31 dB

2. GENERAL INFORMATION

2.1 GENERAL DESCRIPTION OF THE EUT

Product Name	UHF wireless microphone system
Brand Name	BOMGE
Model Name	BG-250U
Series Model	BG-260U,BG-280U,BG-228U,BG-210U,U-260,U-250,U-280,U-210,U-220
Channel List	Please refer to the Note 2.
Operation frequency	Channel: 470MHz- 608MHz
Modulation Type	FM
Antenna Type	PCB Antenna
Antenna Gain (dBi)	1
Power Supply	Input: DC 3V (2 X 1.5AA)
Hardware version number	V1.1
Software version number	V1.1
Connecting I/O Port(s)	Please refer to the User's Manual

Note:

1. For a more detailed features description, please refer to the manufacturer's specifications or the User's Manual.

2. Channel List

Channel					
Channel	Frequency (MHz)	Channel	Frequency (MHz)	Channel	Frequency (MHz)
01	470.032	19	524.398	37	578.752
02	473.052	20	527.410	38	581.792
03	476.072	21	530.432	39	584.812
04	479.092	22	533.454	40	587.832
05	482.112	23	536.476	41	590.852
06	485.132	24	539.498	42	593.872
07	488.152	25	542.510	43	596.892
08	491.172	26	545.532	44	599.912
09	494.192	27	548.554	45	602.932
10	497.212	28	551.576	46	605.952
11	500.232	29	554.598	47	607.962
12	503.252	30	557.610		
13	506.272	31	560.632		
14	509.292	32	563.654		
15	512.312	33	566.676		
16	515.332	34	569.698		
17	518.352	35	572.710		
18	521.372	36	575.732		

Ant.	Atnenna Brand	Antenna Model Name	Antenna Type	Connector	Gain (dBi)	NOTE
1	N/A	FGDE	PCB Antenna	N/A	1.0	Antenna

2.2 DESCRIPTION OF THE TEST MODES

To investigate the maximum EMI emission characteristics generated from EUT, the test system was pre-scanning tested based on the consideration of following EUT operation mode or test configuration mode which possibly have effect on EMI emission level. Each of these EUT operation mode(s) or test configuration mode(s) mentioned above was evaluated respectively.

Test software:FCC tools

The test software was used to control EUT work in continuous TX mode, and select test channel, Wireless mode as below table, the following operating modes were applied for the related test items. All test modes were tested, only the result of the worst case was recorded in the report.

Tested mode, channel , information		
Mode	Channel	Frequency (MHz)
Channel	CH 01	470.032
	CH 24	539.498
	CH 47	607.962

2.3 DESCRIPTION OF NECESSARY ACCESSORIES AND SUPPORT UNITS

The EUT has been tested as an independent unit together with other necessary accessories or support units. The following support units or accessories were used to form a representative test configuration during the tests.

Necessary accessories

Item	Equipment	Mfr/Brand	Model/Type No.	Serial No.	Note

Support units

Item	Equipment	Mfr/Brand	Model/Type No.	Serial No.	Note

Note:

- (1) The support equipment was authorized by Declaration of Confirmation.
- (2) For detachable type I/O cable should be specified the length in cm in 『Length』 column.
- (3) “YES” is means “shielded” “with core”; “NO” is means “unshielded” “without core”.

2.4 EQUIPMENTS LIST

Radiation Test equipment

Kind of Equipment	Manufacturer	Type No.	Company No.	Last calibration	Calibrated until
EMI Test Receiver	R&S	ESRP 3	FCS-E001	2020.10.10	2021.10.09
Signal Analyzer	R&S	FSV40-N	FCS-E012	2020.10.10	2021.10.09
Active loop Antenna	ZHINAN	ZN30900C	FCS-E013	2020.10.10	2021.10.09
Bilog Antenna	SCHWARZBECK	VULB 9168	FCS-E002	2020.10.10	2021.10.09
Horn Antenna	SCHWARZBECK	BBHA 9120D	FCS-E003	2020.10.10	2021.10.09
SHF-EHF Horn Antenna (18G-40GHz)	A-INFO	LB-180400-KF	FCS-E018	2020.10.10	2021.10.09
Pre-Amplifier(0.1M-3G Hz)	EMCI	EM330N	FCS-E004	2020.10.10	2021.10.09
Pre-Amplifier (1G-18GHz)	N/A	TSAMP-0518SE	FCS-E014	2020.10.10	2021.10.09
Pre-Amplifier (18G-40GHz)	TERA-MW	TRLA-0400	FCS-E019	2020.10.10	2021.10.09
Temperature & Humidity	HTC-1	victor	FCS-E005	2020.10.10	2021.10.09

Conduction Test equipment

Kind of Equipment	Manufacturer	Type No.	Company No.	Last calibration	Calibrated until
EMI Test Receiver	R&S	ESPI	FCS-E020	2020.10.10	2021.10.09
LISN	R&S	ENV216	FCS-E007	2020.10.10	2021.10.09
LISN	ETS	3810/2NM	FCS-E009	2020.10.10	2021.10.09
Temperature & Humidity	HTC-1	victor	FCS-E008	2020.10.10	2021.10.09

RF Connected Test

Kind of Equipment	Manufacturer	Type No.	Company No.	Last calibration	Calibrated until
Spectrum Analyzer	Keysight	N9020A	FCS-E015	2020.10.10	2021.10.09
Spectrum Analyzer	Agilent	E4447A	MY50180039	2020.10.10	2021.10.09
Spectrum Analyzer	R&S	FSV-40	101499	2020.10.10	2021.10.09

3 MAXIMUM RADIATED POWER

3.1 LIMIT

Refer to FCC 15.236(d)

In the bands allocated and assigned for broadcast television and in the 600 MHz service band: 50 mW EIRP

3.2 TEST PROCEDURE

A · Connect each EUT's antenna output to power sensor by RF cable and attenuator

3.3 TEST SETUP



3.4 TEST RESULTS

Test mode	Channel	Frequency (MHz)	Peak Output Power (dBm)	Antenna Gain (dBi)	EIRP(dBm)	Limit(dBm)	Verdict
Channel	01	470.032	8.324	1.0	9.324	16.99dBm	PASS
	24	539.498	8.935	1.0	9.935		
	47	607.962	8.164	1.0	9.164		

4. OCCUPIED BANDWIDTH

4.1 LIMIT

One or more adjacent 25 kHz segments within the assignable frequencies may be combined to form a channel whose maximum bandwidth shall not exceed 200 kHz. The operating bandwidth shall not exceed 200 kHz

4.2 TEST PROCEDURE

Parameter	Setting
Detector	Peak/AV
Sweep time	Auto
Resolution bandwidth	1 % to 5 % of the occupied bandwidth
Video bandwidth:	3 x resolution bandwidth
Span:	2 x emission bandwidth
Trace mode:	Max. hold
Analyzer function:	99% power occupied bandwidth function
EUT:	Modulated signal with max. frequency deviation

4.3 TEST SETUP

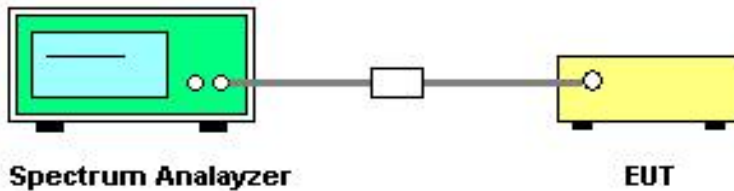

4.4 TEST RESULTS

Test mode	Channel	Frequency (MHz)	99% Bandwidth (KHz)	Limit(KHz)	Verdict
Channel	Low CH	470.032	63.762KHz	200	PASS
	Middle CH	539.498	58.994KHz		
	High CH	607.962	64.285KHz		

Channel

Low CH

Center Freq: 470.032000 MHz
 Occupied Bandwidth: 63.762 kHz
 Total Power: 6.35 dBm
 Transmit Freq Error: -2.843 kHz
 x dB Bandwidth: 71.11 kHz

Middle CH

Center Freq: 539.498000 MHz
 Occupied Bandwidth: 58.994 kHz
 Total Power: 5.70 dBm
 Transmit Freq Error: -1.251 kHz
 x dB Bandwidth: 68.05 kHz

High CH

Center Freq: 607.962000 MHz
 Occupied Bandwidth: 64.285 kHz
 Total Power: 6.44 dBm
 Transmit Freq Error: -6.220 kHz
 x dB Bandwidth: 74.26 kHz

5 NECESSARY BANDWIDTH

5.1 LIMIT

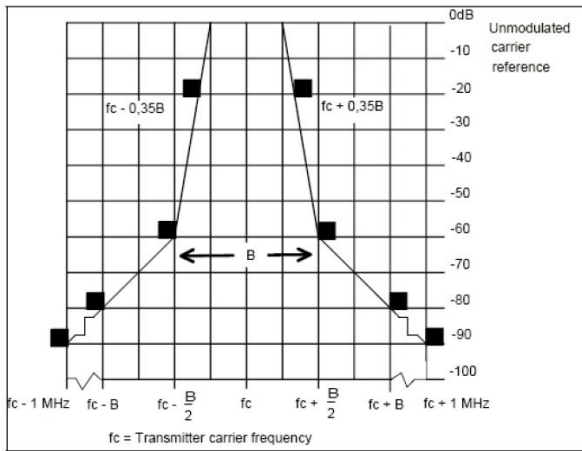
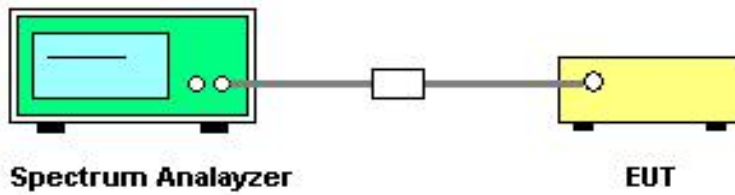

Figure 1: Spectrum mask for analogue systems in all bands

5.2 TEST PROCEDURE

EN300422-1 V1.4.2 Clause 8.3.

5.3 TEST SETUP



5.4 TEST RESULT

Emission Mask
Channel
Low CH

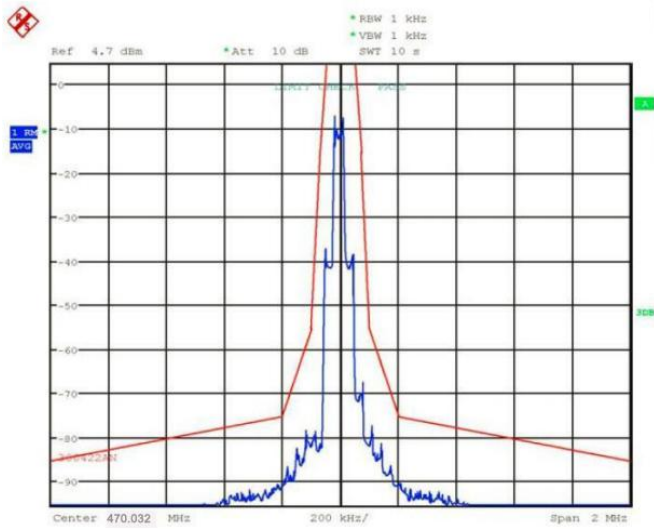

Middle CH

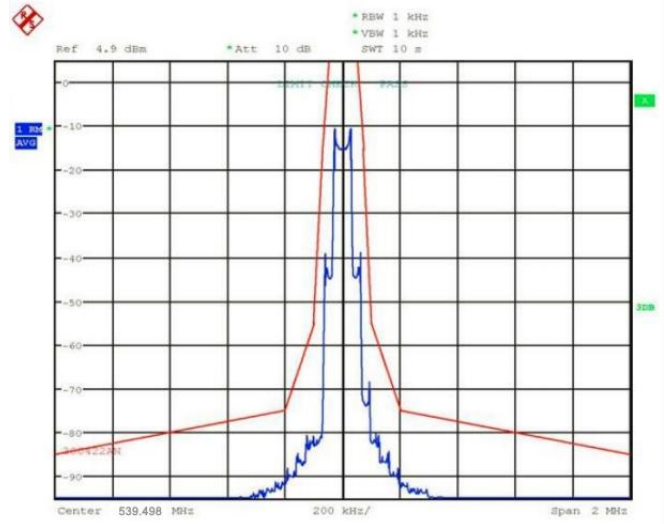

High CH

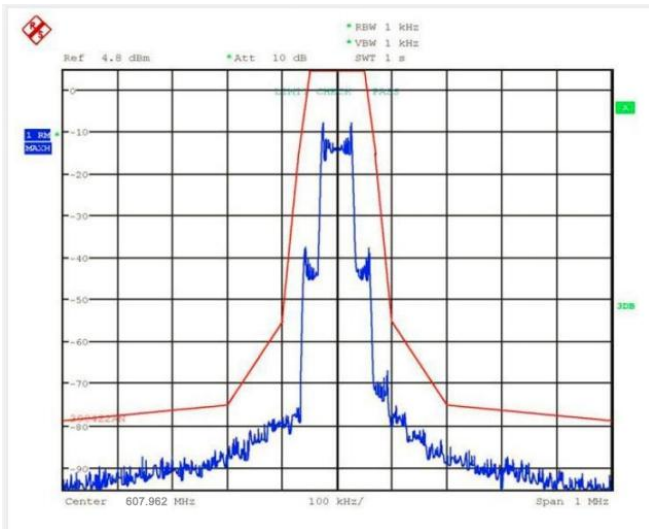

6. TRANSMITTER UNWANTED EMISSIONS

6.1 LIMIT

Spurious emissions are emissions outside the frequency range(s) of the equipment. The power of the spurious emissions shall not exceed the limits of table as below:

State	Frequency		
	47MHz to 74MHz, 87.5MHz to 137MHz 174MHz to 230MHz, 470MHz to 862MHz	Other Frequencies below 1000MHz	Frequencies above 1000MHz
Operation	4nW	250nW	1uW
Standby	2nW	2nW	20nW

5.2 TEST PROCEDURE

1. The transmitter output was connected to the spectrum analyzer through an attenuator. Set spectrum analyzer start 2400MHz to 2483.5MHz with 100 KHz RBW and 300 KHz VBW
2. Please refer to ETSI EN 300 422-1 V1.4.2 (2011-08) clause 6.1 for the test conditions.
3. Please refer to ETSI EN 300 422-1 V1.4.2 (2011-08) clause 8.4.2 for the measurement method.

5.3 TEST SETUP

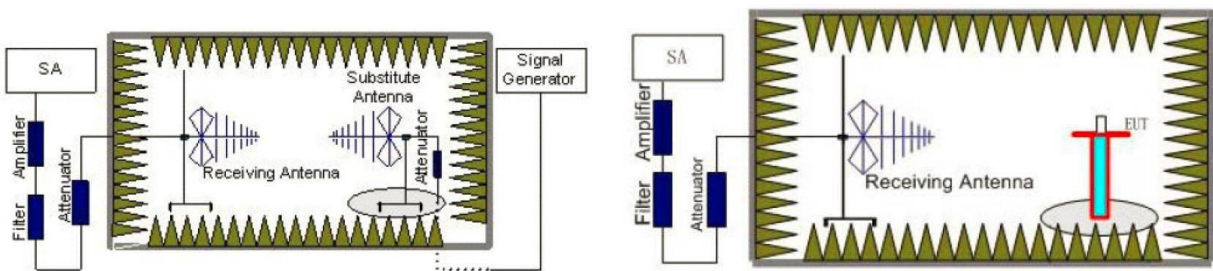

6.4 TEST RESULTS

CHANNEL -LOW CH-30MHZ-1000MHZ

Horizontal

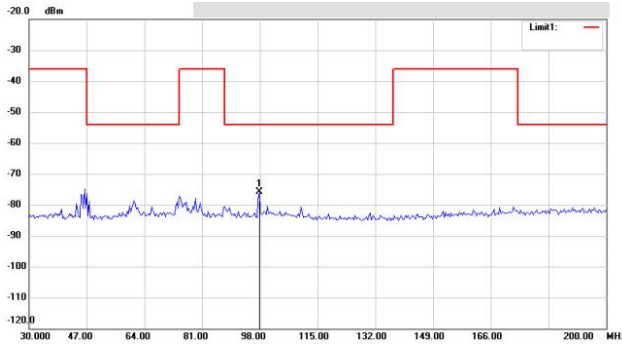

Mk.	Frequency (MHz)	Reading (dBm)	Detector	Corr. factor (dB)	Result (dBm)	Limit (dBm)	Ant.Pos (cm)	Tab.Pos (deg.)	Margin (dB)
*	97.7956	-97.42	peak	21.44	-75.98	-54.00	150	50	-21.98

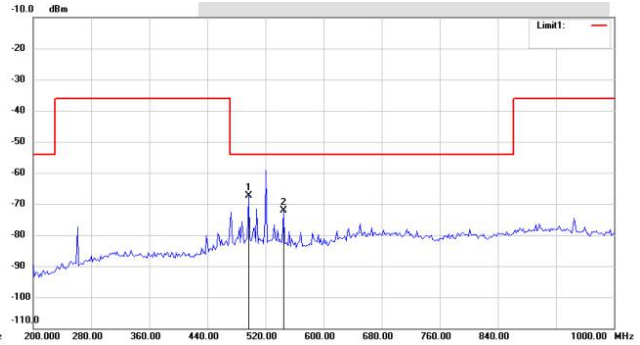

Mk.	Frequency (MHz)	Reading (dBm)	Detector	Corr. factor (dB)	Result (dBm)	Limit (dBm)	Ant.Pos (cm)	Tab.Pos (deg.)	Margin (dB)
*	496.5932	-58.05	peak	-9.23	-67.28	-54.00	150	250	-13.28
	544.6893	-64.37	peak	-7.76	-72.13	-54.00	150	130	-18.13

Vertical

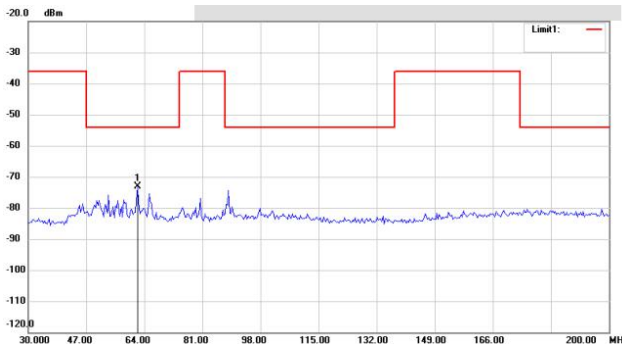

Mk.	Frequency (MHz)	Reading (dBm)	Detector	Corr. factor (dB)	Result (dBm)	Limit (dBm)	Ant.Pos (cm)	Tab.Pos (deg.)	Margin (dB)
*	62.0240	-94.60	peak	21.47	-73.13	-54.00	150	100	-19.13

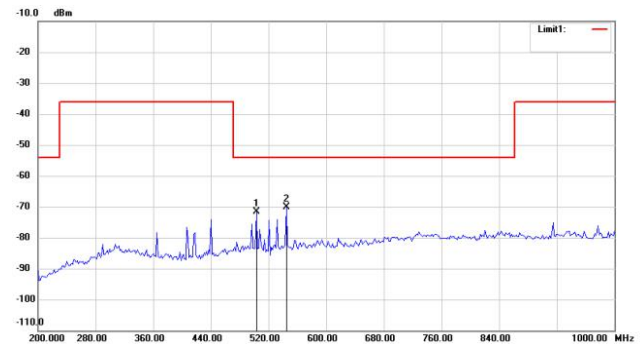

Mk.	Frequency (MHz)	Reading (dBm)	Detector	Corr. factor (dB)	Result (dBm)	Limit (dBm)	Ant.Pos (cm)	Tab.Pos (deg.)	Margin (dB)
	503.0060	-64.91	peak	-6.68	-71.59	-54.00	150	120	-17.59
*	544.6893	-63.88	peak	-6.20	-70.08	-54.00	150	300	-16.08

CHNNEL -MIDDLE CH-30MHZ-1000MHZ

Horizontal

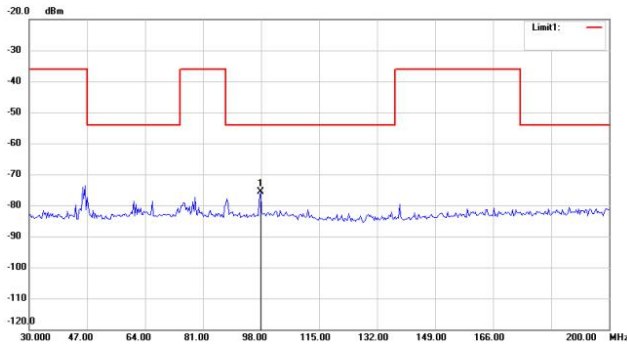

Mk.	Frequency (MHz)	Reading (dBm)	Detector	Corr. factor (dB)	Result (dBm)	Limit (dBm)	Ant.Pos (cm)	Tab.Pos (deg.)	Margin (dB)
*	97.7956	-97.16	peak	21.44	-75.72	-54.00	150	230	-21.72

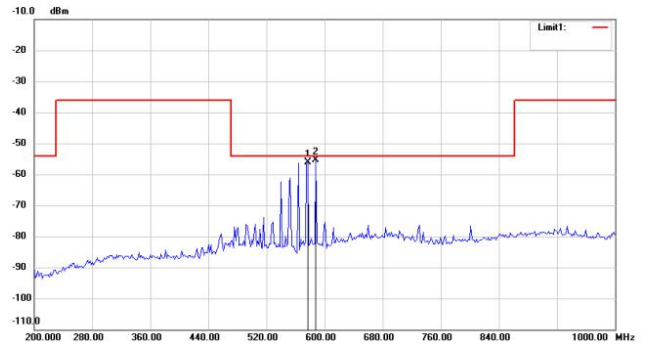

Mk.	Frequency (MHz)	Reading (dBm)	Detector	Corr. factor (dB)	Result (dBm)	Limit (dBm)	Ant.Pos (cm)	Tab.Pos (deg.)	Margin (dB)
	576.7535	-49.39	peak	-6.73	-56.12	-54.00	150	120	-2.12
*	587.9760	-48.99	peak	-6.37	-55.36	-54.00	150	300	-1.36

Vertical

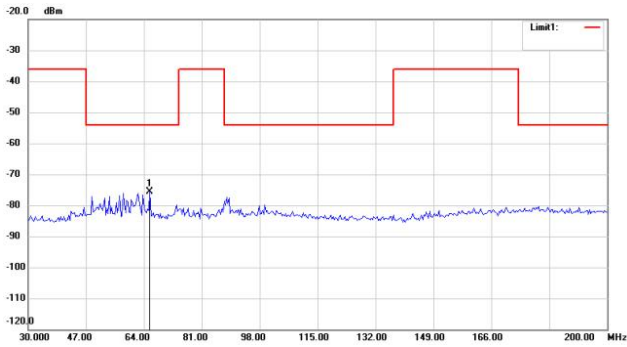

Mk.	Frequency (MHz)	Reading (dBm)	Detector	Corr. factor (dB)	Result (dBm)	Limit (dBm)	Ant.Pos (cm)	Tab.Pos (deg.)	Margin (dB)
*	65.7715	-96.86	peak	21.24	-75.62	-54.00	150	210	-21.62

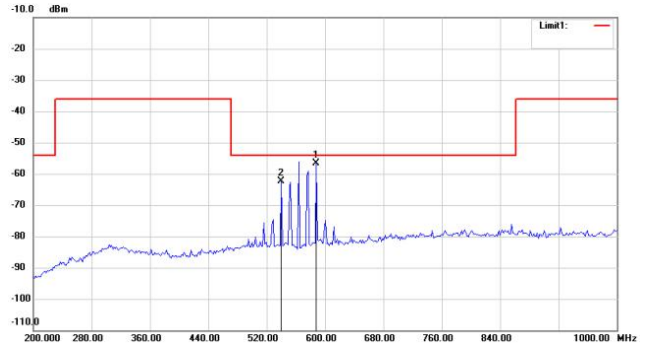

Mk.	Frequency (MHz)	Reading (dBm)	Detector	Corr. factor (dB)	Result (dBm)	Limit (dBm)	Ant.Pos (cm)	Tab.Pos (deg.)	Margin (dB)
*	587.9760	-50.85	peak	-5.72	-56.57	-54.00	150	300	-2.57
	539.8798	-56.18	peak	-6.26	-62.44	-54.00	150	210	-8.44

CHNNEL -HIGH CH-30MHZ-1000MHZ

Horizontal

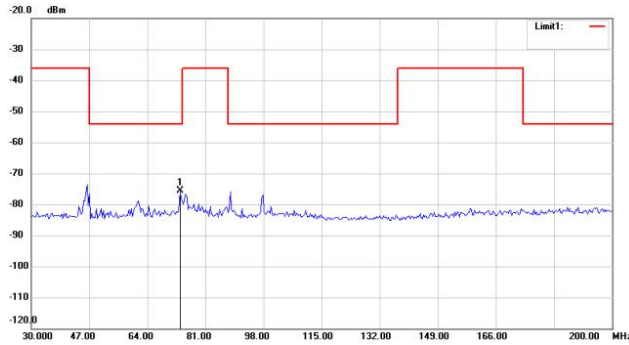

Mk.	Frequency (MHz)	Reading (dBm)	Detector	Corr. factor (dB)	Result (dBm)	Limit (dBm)	Ant.Pos (cm)	Tab.Pos (deg.)	Margin (dB)
*	73.6071	-97.07	peak	21.55	-75.52	-54.00	150	250	-21.52

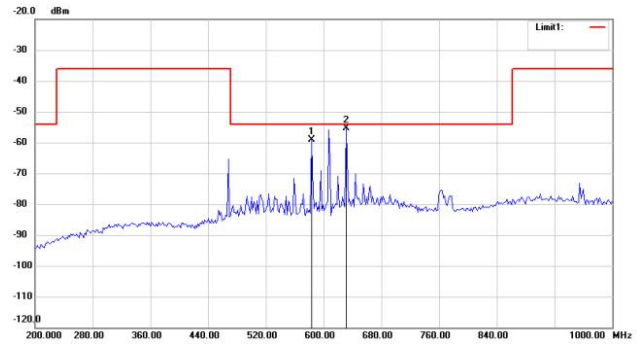

Mk.	Frequency (MHz)	Reading (dBm)	Detector	Corr. factor (dB)	Result (dBm)	Limit (dBm)	Ant.Pos (cm)	Tab.Pos (deg.)	Margin (dB)
	583.1663	-52.64	peak	-6.55	-59.19	-54.00	150	15	-5.19
*	631.2625	-51.16	peak	-4.09	-55.25	-54.00	150	30	-1.25

Vertical

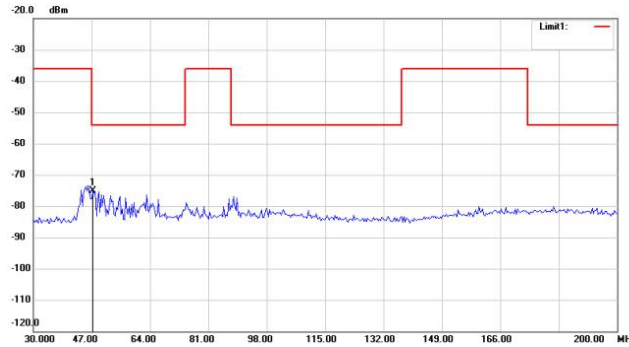

Mk.	Frequency (MHz)	Reading (dBm)	Detector	Corr. factor (dB)	Result (dBm)	Limit (dBm)	Ant.Pos (cm)	Tab.Pos (deg.)	Margin (dB)
*	47.3746	-96.39	peak	21.17	-75.22	-54.00	150	210	-21.22

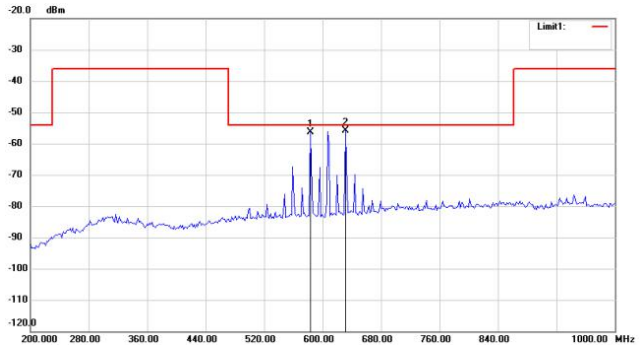

Mk.	Frequency (MHz)	Reading (dBm)	Detector	Corr. factor (dB)	Result (dBm)	Limit (dBm)	Ant.Pos (cm)	Tab.Pos (deg.)	Margin (dB)
	583.1662	-50.71	peak	-5.77	-56.48	-54.00	150	120	-2.48
*	631.2625	-50.96	peak	-4.87	-55.83	-54.00	150	320	-1.83

CHANNEL 1GHZ-6GHZ

Test Channel (MHz)	Frequency (MHz)	Ant. Pol. (H/V)	SG Reading (dBm)	Cable Loss (dB)	Substitute Antenna Gain (dBi)	EIRP (dBm)	Limit (dBm)	Margin (dB)
470.072	1885.00	H	-63.02	3.40	10.44	-55.98	-30.00	-25.98
	2329.00	H	-60.43	3.79	9.81	-54.41	-30.00	-24.41
	2820.75	H	-62.61	4.15	11.30	-55.46	-30.00	-25.46
	1410.38	V	-60.62	3.02	8.09	-55.55	-30.00	-25.55
	1996.00	V	-58.97	3.49	10.34	-52.12	-30.00	-22.12
	2656.00	V	-58.18	4.03	10.88	-51.33	-30.00	-21.33
539.498	1327.00	H	-60.14	2.87	7.61	-55.40	-30.00	-25.40
	2952.75	H	-62.99	4.22	11.49	-55.72	-30.00	-25.72
	4921.00	H	-54.53	5.56	12.62	-47.47	-30.00	-17.47
	1968.50	V	-64.65	3.46	10.38	-57.73	-30.00	-27.73
	2952.75	V	-61.02	4.22	11.49	-53.75	-30.00	-23.75
	4921.00	V	-54.92	5.56	12.62	-47.86	-30.00	-17.86
607.962	1542.00	H	-64.53	3.08	9.09	-58.52	-30.00	-28.52
	3084.00	H	-62.20	4.32	11.64	-54.88	-30.00	-24.88
	3598.00	H	-62.76	4.68	12.56	-54.88	-30.00	-24.88
	2056.00	V	-63.87	3.56	9.87	-57.56	-30.00	-27.56
	2665.00	V	-59.57	4.01	10.90	-52.68	-30.00	-22.68
	3598.00	V	-62.90	4.68	12.56	-55.02	-30.00	-25.02

7. FREQUENCY STABILITY

7.1 LIMIT

The frequency tolerance of the carrier signal shall be maintained within $\pm 0.005\%$ of the operating frequency over a temperature variation of -20 degrees to $+50$ degrees C at normal supply voltage, and for a variation in the primary supply voltage from 85% to 115% of the rated supply voltage at a temperature of 20 degrees C

7.2 TEST PROCEDURE

- a. The EUT was connected to an external DC power supply and the RF output was connected to a frequency counter via feed through attenuators. The EUT was placed inside the temperature chamber. The DC leads and the RF output cable, exited the chamber through an opening made for that purpose.
After the temperature stabilized the frequency output was recorded form the counter. An external variable DC power supply was connected to the battery terminals of the equipment under test.
- b. For hand carried, battery powered equipment primary supply voltage was reduced to the battery operating end point as specified by the manufacturer. The output frequency was recorded for each battery voltage.

7.3 TEST SETUP

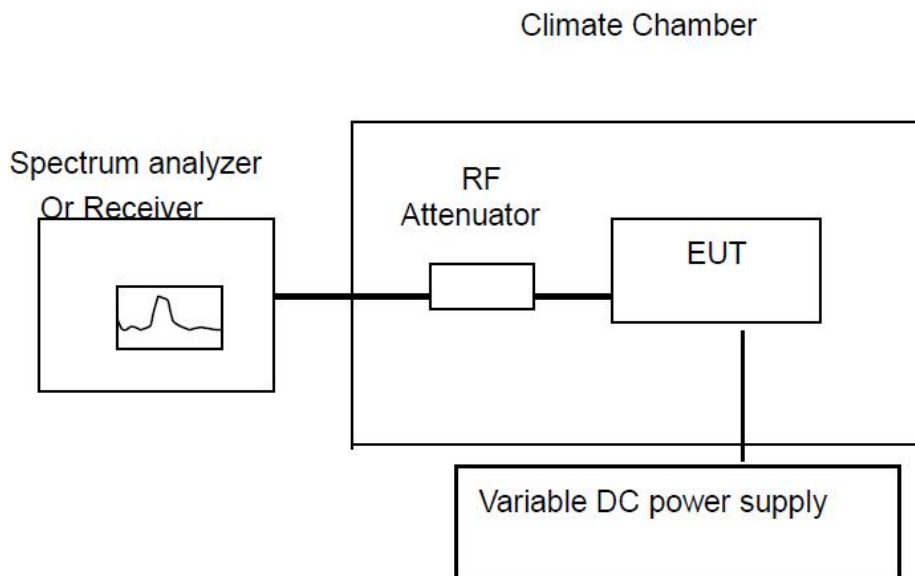

7.4 TEST RESULTS

- (1) Frequency stability versus input voltage (Supply Nominal voltage is DC 3V)
- (2) Frequency stability versus input voltage (Supply battery operating end point which shall be specified by the manufacturer DC 2.7V)

Refernce Frequency: 470.032MHz			
Power supply	Environment Temperature(°C)	Frequency Error (Hz)	Frequency Error (%)
DC 2.55V	20	248	0.000527
DC 3.0V	20	264	0.000561
DC 3.45V	20	231	0.000491

Refernce Frequency: 470.032MHz				
Frequency Deviation measured with time Elapse(30 minutes)				
Environment Temperature(°C)	Frequency Error (Hz)	Frequency Error (%)	Limit (%)	Results
50	264	0.000561	0.005	Pass
40	248	0.000527		
30	264	0.000561		
20	264	0.000561		
10	231	0.000491		
0	248	0.000527		
-10	231	0.000491		
-20	264	0.000561		
-30	231	0.000491		

Refernce Frequency: 539.498MHz			
Power supply	Environment Temperature(°C)	Frequency Error (Hz)	Frequency Error (%)
DC 2.55V	20	236	0.000330
DC 3.0V	20	247	0.000345
DC 3.45V	20	259	0.000362

Refernce Frequency: 539.498MHz				
Frequency Deviation measured with time Elapse(30 minutes)				
Environment Temperature(°C)	Frequency Error (Hz)	Frequency Error (%)	Limit (%)	Results
50	247	0.000345	0.005	Pass
40	247	0.000345		
30	236	0.000330		
20	259	0.000362		
10	236	0.000330		
0	259	0.000362		
-10	259	0.000362		
-20	247	0.000345		
-30	259	0.000362		

Refernce Frequency: 607.962MHz			
Power supply	Environment Temperature(°C)	Frequency Error (Hz)	Frequency Error (%)
DC 2.55V	20	235	0.000245
DC 3.0V	20	254	0.000264
DC 3.45V	20	286	0.000298

Refernce Frequency: 607.962MHz				
Frequency Deviation measured with time Elapse(30 minutes)				
Environment Temperature(°C)	Frequency Error (Hz)	Frequency Error (%)	Limit (%)	Results
50	235	0.000245	0.00500	Pass
40	235	0.000245		
30	254	0.000264		
20	286	0.000298		
10	254	0.000264		
0	235	0.000245		
-10	235	0.000245		
-20	254	0.000264		
-30	286	0.000298		

*****END OF THE REPORT*****