

**SmallRig**

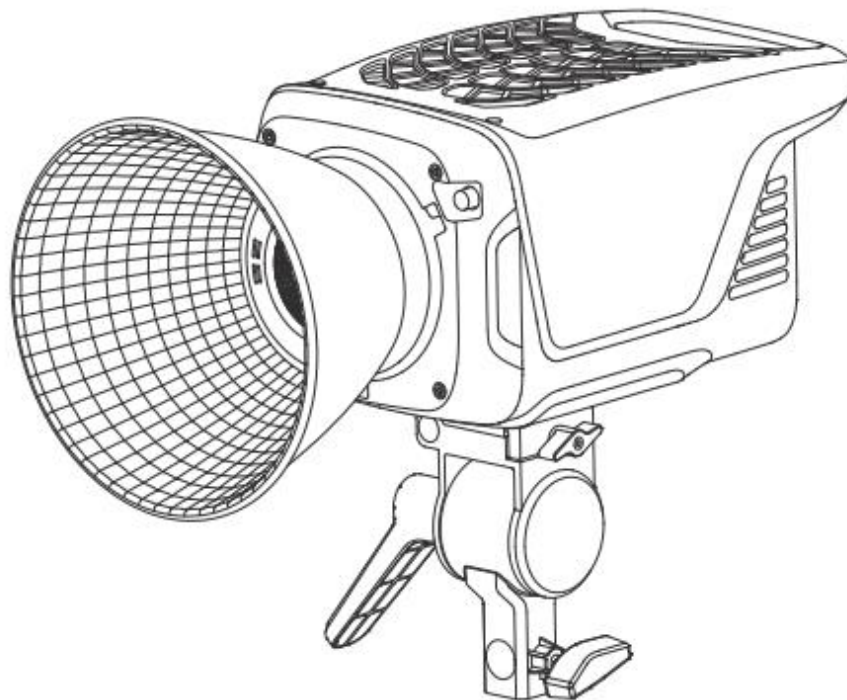

**RC 350D / RC 450D  
COB LED Video Light**

- User Manual -

## Foreword

Thank you for choosing SmallRig COB LED Video Light.

EN

## Warnings

1. Please read this User Manual carefully.
2. Keep this User Manual and always include it when passing the product onto the third party.
3. Heed all warnings and follow all instructions in this User Manual.
4. Close supervision is necessary when any fixture is used by or near children. Do not leave the fixture unattended while in use.
5. Care must be taken as burns can occur from touching hot surfaces.
6. Do not operate the fixture if a cord is damaged or if the fixture has been dropped or damaged until it has been examined by qualified service personnel.
7. Position any power cables so that they will not be tripped over, pulled or put into contact with hot surfaces.
8. If an extension cord is necessary, a cord with an amperage rating at least equal to that of the fixture should be used. Cords rated for less amperage than the fixture may overheat.
9. Always unplug the lighting fixture from the electrical outlet before cleaning and servicing or when not in use. Never yank the cord to remove the plug from the outlet.
10. Let the lighting fixture cool completely before storing.
11. To reduce the risk of electric shock, do not immerse this fixture in water or any other liquids.
12. To reduce the risk of fire or electric shock, do not disassemble this fixture. Contact [smallrig@smallrig.com](mailto:smallrig@smallrig.com) or take it to qualified service personnel when service or repair work is required.
13. The use of an accessory attachment not recommended by the manufacturer may increase the risk of fire, electric shock, or injury to any person operating the fixture.
14. Power this fixture by connecting it to a grounded outlet.
15. Please remove the protection cover before powering the light.
16. Please remove the EVA protection cover before using the reflector.
17. Please do not block the ventilation and do not look at the light directly when it is powered on.
18. Please do not place the LED lighting fixture near any liquids or other flammable objects.
19. Only use a dry microfiber cloth to clean the product.
20. Please have the product checked by an authorized service personnel agent if your product has a problem.
21. The malfunctions caused by unauthorized disassembly are not covered under the warranty.
22. We recommend only using the original SmallRig cable accessories. Please note that our warranty for this product does not apply to any repairs required due to any malfunctions of unauthorized SmallRig accessories, although you may request such repairs for a fee.
23. This product is certified by CE, RoHS, UKCA, FCC, IC, KC, RCM, TELEC, PSE. Please operate the product in full compliance with the operation standards. Please note that this warranty does not apply to repairs arising from malfunctions, although you may request such repairs on a chargeable basis.
24. The instructions and information in this manual are based on thorough, controlled company testing procedures. Further notice will not be given if the design or specifications change.



**Please do not disassemble the product. If you have any question, please contact the seller to apply after-sales service.**

## FCC Compliance Statement

This device complies with Part 15 of the FCC Rules. Operation is subject to the following two conditions:

(1) This device may not cause harmful interference.

(2) This device must accept any interference received, including interference that may cause undesired operation.

### [Warning]

Changes or modifications not expressly approved by the party responsible for compliance could void the user's authority to operate the equipment.

### [Note]

This equipment has been tested and found to comply with the limits for a Class B digital device, pursuant to Part 15 of the FCC Rules. These limits are designed to provide reasonable protection against harmful interference in a residential installation. This equipment generates, uses and can radiate radio frequency energy, if not installed and used in accordance with the instructions, may cause harmful interference to radio communications.

However, there is no guarantee that interference will not occur in a particular installation. If this equipment does cause harmful interference to radio or television reception, which can be determined by turning the equipment off and on, the user is encouraged to try reorient or relocate the receiving antenna.

- Increase the separation between the equipment and receiver.
- Connect the equipment to an outlet in a different circuit than the receiver is connected to.
- Consult the dealer or an experienced radio / TV technician for help.

**FCC ID: 2AZWI-3960LEQI**

## RF Warning Statement

The equipment complies with FCC Radiation exposure limits set forth for uncontrolled environment. This equipment should be installed and operated with minimum distance 20cm between the radiator and your body.

EN

## In the Box

When you unbox the product, please make sure all the items below are included. Otherwise, contact with the seller immediately.

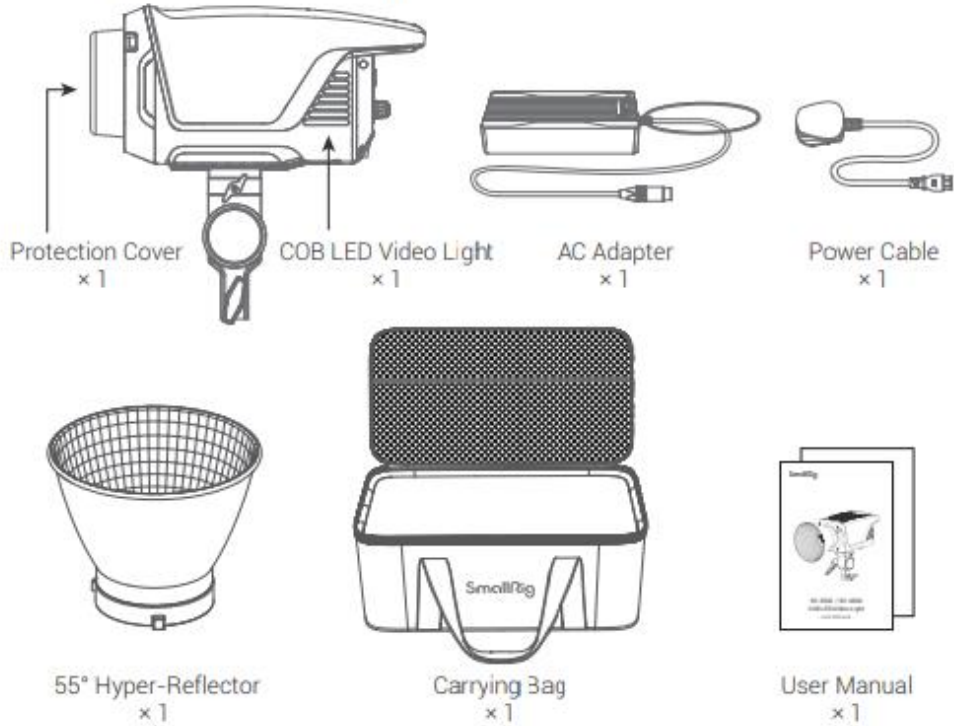

## Product Details

### Light

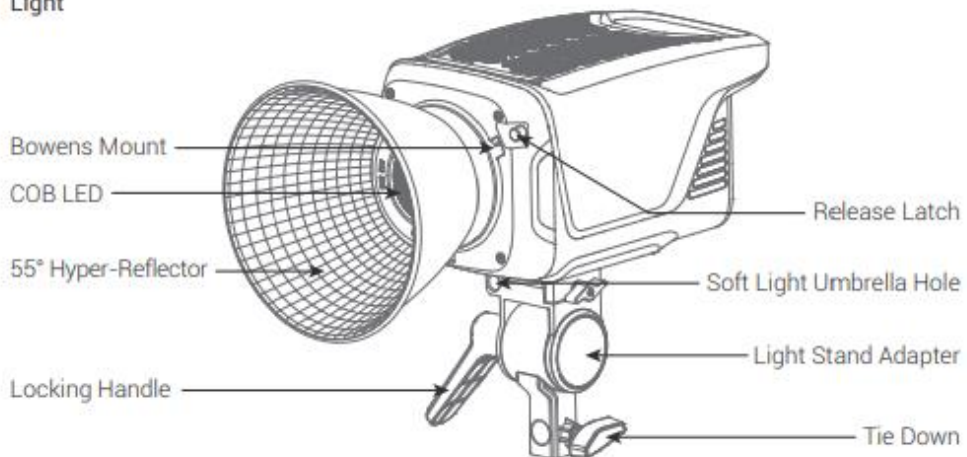

EN

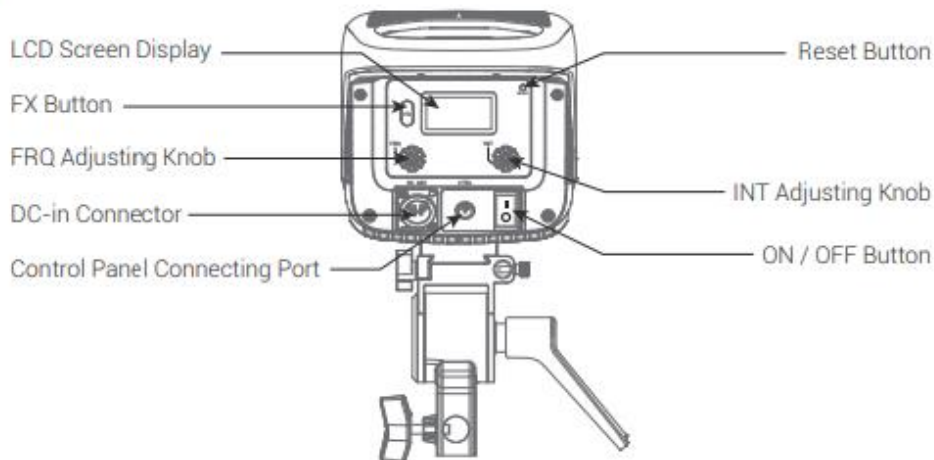

## Installations

### 1. Attaching / Detaching the protection cover

Push the handle of the lever in the direction of the arrow shown in the picture, and rotate the cover to pull it out. Reverse rotation will put into the protection cover.

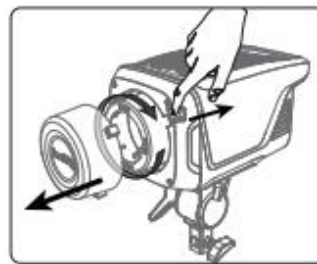
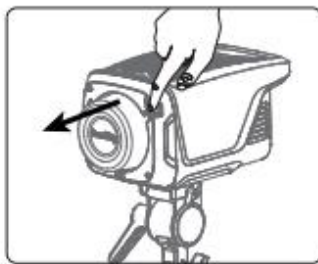

\* Notice: Always remove the protection cover prior to turning on the light.  
Always reinstall the cover when packing it away.

### 2. Installation and removal of the reflector

Push the lever handle according to the arrow direction shown in the picture and rotate the reflector into it. Rotating in the opposite direction pulls out the reflector.

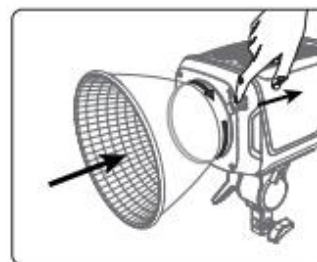
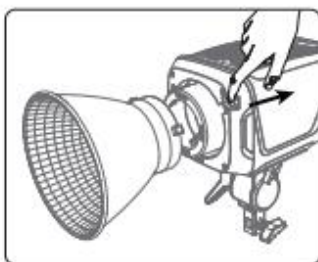

\* Notice: The installation of other Bowens Mount modifiers are the same.



### 3. Setting up the light

Connect and tighten the stand adapter with the light through the Arca-type clamp and mount plate, rotate the tie-down knob to fix the stand adapter on the light stand. Please remember to lock the stand adapter with the locking handle once you've adjusted the light to the required angle.

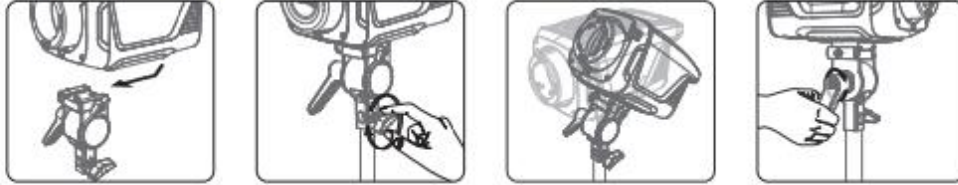

### 4. Soft light umbrella installation

Insert the soft light handle into the hole and lock the knob on the hole.

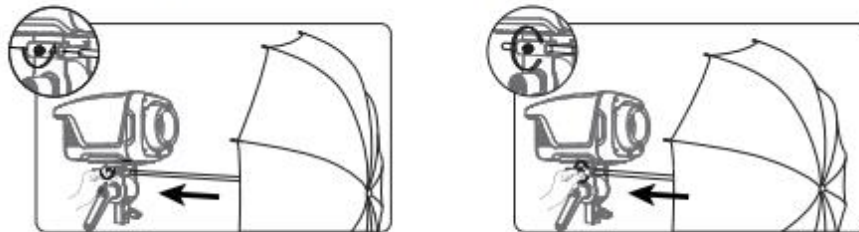

## The Power Supply

Powered by AC

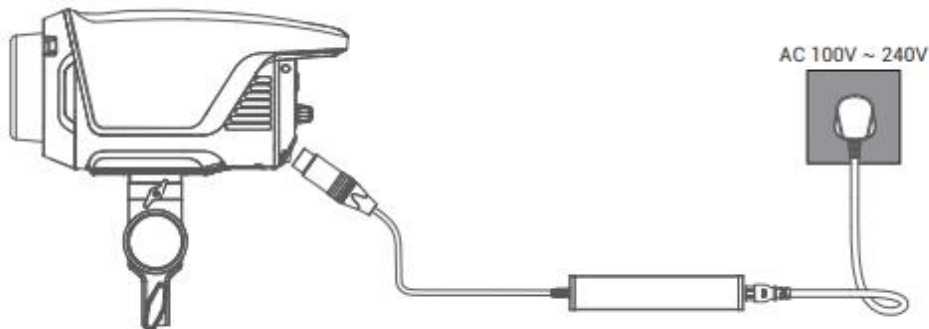

• Notice: Please press the spring-loaded lock button on the power cord to remove the cord. Do not pull it out forcibly.

## Operations

1. Press the power button to turn the light on and off.

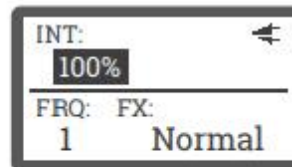
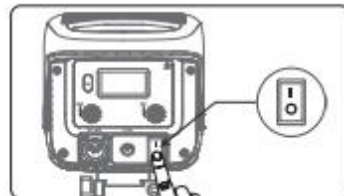

EN

## 2. Manual control

### 2.1 Brightness adjustment

Rotate the INT adjusting knob to adjust the brightness with 1% variable and the brightness change range is 0 ~ 100%, the change of the brightness will be displayed in real time on the light body.

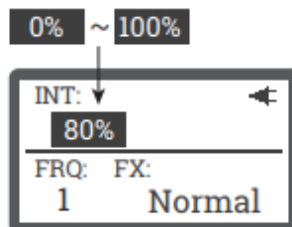

### 2.2 FX and FRQ adjusting control

- Press the FX button to get Normal and Paparazzi / TV / Fault Bulb / Lightning / Breath / Party / Flash / Flame / Firework, nine kinds of FX.
- Rotate the FRQ knob then switch to the frequency adjustment, the change range is 1 ~ 10.

\* Notice: The brightness and FRQ of every FX can be set separately.

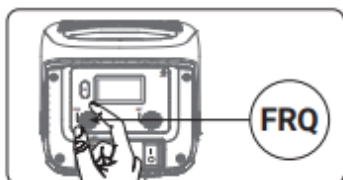
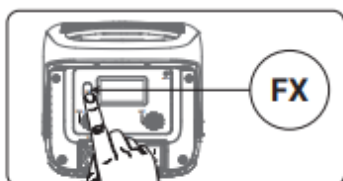

Normal / Paparazzi / TV / Fault bulb /  
Lightning / Breath / Party / Flash / Flame / Firework

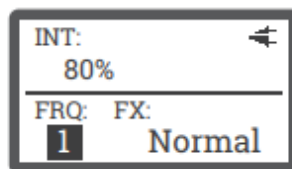
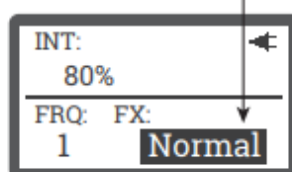

## 3. BLE reset

- Long press the Reset button for 3 seconds, the BLE icon will appear in the upper right of the LCD display. The icon flashes 6 times and the BLE is reset.
- Then you can reconnect the light through SmallGoGo App on your smart device.

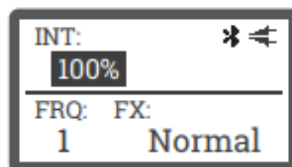
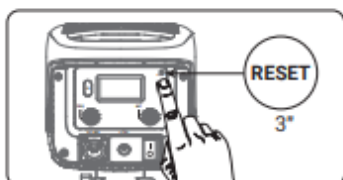

#### 4. App control

The user can download the SmallGoGo App and connect the the device named 350D-xxxxxx / 450D-xxxxxx. After the light is controlled by the App, the BLE icon will be displayed on the upper right of the light LCD.

• Notice: Please enable the mobile location function when using the App.

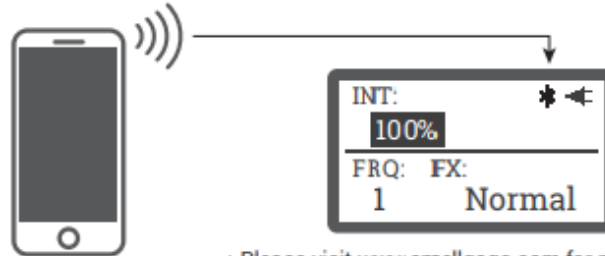

• Please visit [www.smallgogo.com](http://www.smallgogo.com) for more details regarding how to use the App to control you lights.

#### 5. OTA mode

Firmware updates can be updated online via the SmallGoGo App for OTA updates.

#### 6. Using the SmallGoGo App

You can download the SmallGoGo App from the iOS App or Google Play Store for enhancing the functionality of the light. Please visit [www.smallgogo.com](http://www.smallgogo.com) for more details regarding how to use the app to control your lights.



Operation Manual



App Download

#### 7. Panel control

- a. Connect the control panel with the light.
- b. The operation interface is the same as that on the light.

• Notice: The control panel is not standard configuration and need to buy separately.

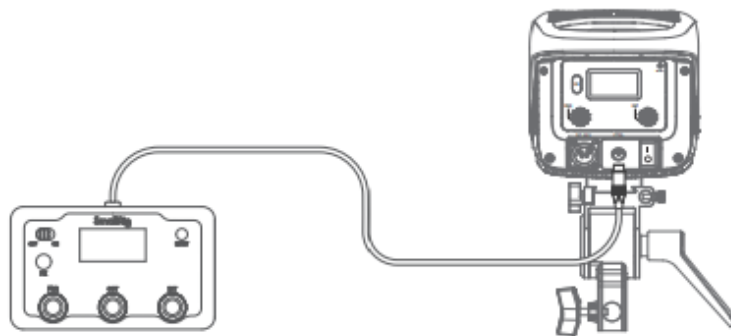

(RC 350D)

EN

## Specifications

Light Operating Current	8.4A @ 48V	Power Consumption	403.2W
Light Power Supply	DC 48V	Cooling Mode	Active Cooling
Adapter Power Supply	AC100 ~ 240V 50 / 60Hz	CRI	96+
TLCI	97+	App Control Type	BLE
Color Temperature	5600K ± 200K	Remote Ability	≤100m
Radio Frequency	2.4GHz	Power Supply	AC
Size	11.43 × 5.7 × 5.7in	Weight	7.27 Pound

## Photometrics

CCT / INT	Distance	1m	3m	5m
	Illumination			
100%	Bare Bulb	1580 fc	182 fc	68 fc
		17000 lux	1960 lux	730 lux
	Hyper-Reflector	13848 fc	1059 fc	352 fc
		149000 lux	11400 lux	3790 lux

\* This is an averaged result, the number might be slightly different on each light.



FCC Warning:

This equipment has been tested and found to comply with the limits for a Class B digital device, pursuant to part 15 of the FCC Rules. These limits are designed to provide reasonable protection against harmful interference in a residential installation. This equipment generates, uses and can radiate radio frequency energy and, if not installed and used in accordance with the instructions, may cause harmful interference to radio communications. However, there is no guarantee that interference will not occur in a particular installation. If this equipment does cause harmful interference to radio or television reception, which can be determined by turning the equipment off and on, the user is encouraged to try to correct the interference by one or more of the following measures:

- Reorient or relocate the receiving antenna.
- Increase the separation between the equipment and receiver.
- Connect the equipment into an outlet on a circuit different from that to which the receiver is connected.
- Consult the dealer or an experienced radio/TV technician for help.

Caution: Any changes or modifications to this device not explicitly approved by manufacturer could void your authority to operate this equipment.

This device complies with part 15 of the FCC Rules. Operation is subject to the following two conditions:

(1) This device may not cause harmful interference, and (2) this device must accept any interference received, including interference that may cause undesired operation.

This equipment complies with FCC radiation exposure limits set forth for an uncontrolled environment. This equipment should be installed and operated with minimum distance 20cm between the radiator and your body.

## ISED Statement

- English: This device complies with Industry Canada license-exempt RSS standard(s). Operation is subject to the following two conditions: (1) This device may not cause interference, and (2) This device must accept any interference, including interference that may cause undesired operation of the device.

The digital apparatus complies with Canadian CAN ICES-3 (B)/NMB-3(B).

- French: Le présent appareil est conforme aux CNR d'Industrie Canada applicables aux appareils radio exempts de licence. L'exploitation est autorisée aux deux conditions suivantes: (1) l'appareil ne doit pas produire de brouillage, et (2) l'utilisateur de l'appareil doit accepter tout brouillage radioélectrique subi, même si le brouillage est susceptible d'en compromettre le fonctionnement. L'appareil numérique du CIEM conforme canadien peut - 3 (b) / nmb - 3 (b).

This device meets the exemption from the routine evaluation limits in section 2.5 of RSS 102 and compliance with RSS 102 RF exposure, users can obtain Canadian information on RF exposure and compliance.

Cet appareil est conforme à l'exemption des limites d'évaluation courante dans la section 2.5 du CNR - 102 et conformité avec RSS 102 de l'exposition aux RF, les utilisateurs peuvent obtenir des données canadiennes sur l'exposition aux champs RF et la conformité.

This equipment complies with Canada radiation exposure limits set forth for an uncontrolled environment.

This equipment should be installed and operated with minimum distance 20cm between the radiator & your body.

Cet équipement est conforme Canada limites d'exposition aux radiations dans un environnement non contrôlé.

Cet équipement doit être installé et utilisé avec une distance minimale de 20 cm entre le radiateur et votre corps.

**IC: 27649-3960LEQI**

### **Guarantee Card**

Serial No.	
Item Name	
Purchase Date	
User Name	
Mobile	
Address	
Receipt	

### **Service Warranty**

Please keep your original receipt and guarantee card. Be sure the dealer has written on it the date of purchase and SN of the product. These are required for warranty service.

#### **After-sale warranty terms**

1. 7 Days DOA Return Policy: Within 7 days from the date of the package receipt, return or replacement can be done if the item received is malfunctioning or physical damaged (not caused by human abused), return shipping cost will be on SmallRig's charge.
2. 1-Year Warranty: Within 1-year from the date of the package receipt, defective product which is not caused by human abused is eligible to get repair / replacement for free; defective product which is caused by human abused, repair / replacement will be charged based on the damage level.

#### **This warranty does not cover:**

1. Defect caused by users' violation of the "Warnings".
2. The product identification or SN label is removed or defaced in any way.
3. The product is serviced or repaired by any one other than our company or the service agency authorized by our company.

Manufacturer: Shenzhen Leqi Network Technology Co., Ltd.

[www.smallrig.com](http://www.smallrig.com)

Add: Rooms 103, 501 and 601, Building 5, Fenghe Industrial Park,  
Nos. 1301-50 Guangang Road, Longhua District, Shenzhen,  
Guangdong, China.

Made in China