

Star Ocean Projection Lamp

User Manual

Product Description:

1. Star projector lamp is an ungraded version of the mini projection lamp that can be projection on ceiling. Using the colored light to create a romantic casual and comfortable atmosphere.
2. This item adopted Bluetooth 5.0, it has various functions including remote control, built-in 11 relax hypnosis musics. Integrate ocean and starry sky projection multiple lighting mode switching, you can easily switch the light mode and a vibrant colors light mode according to your mood.

Package Content:

- 1 x Night Light Projector
- 1 x TYPE-C Charging Cable
- 1 x Hand Strap
- 1 x User Operation Manual

Technical Parameters:

Audio input method: Bluetooth, Local Storage Music

Bluetooth version: 5.0

Bluetooth distance: $\geq 10\text{m}$

Power supply: DC5V 1A

Built-in lithium battery voltage: 3.7V

Batteries capacity: 2000mAh

Output power: 1.5W

Frequency response range: 100 Hz-20 kHz

SNR: $\geq 70\text{dB}$

Speaker impedance: 4Ω



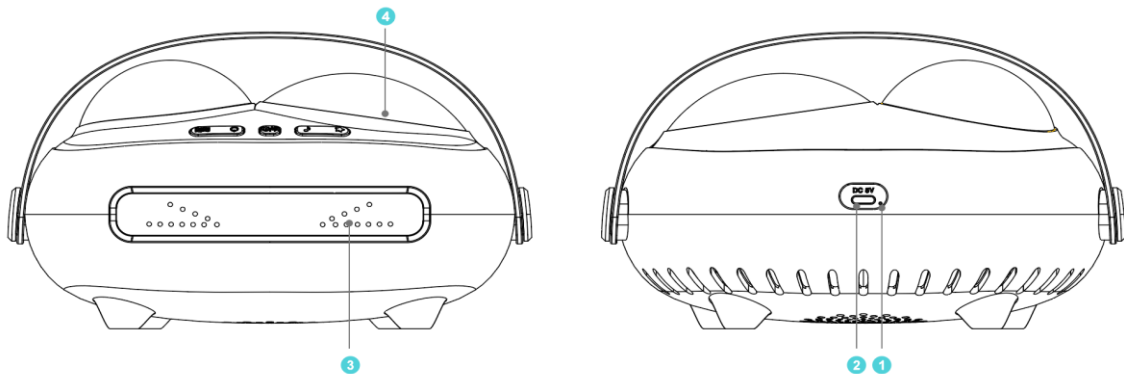

Working temperature: $0^{\circ}\text{C}-45^{\circ}\text{C}$

I. Description of buttons and operation:

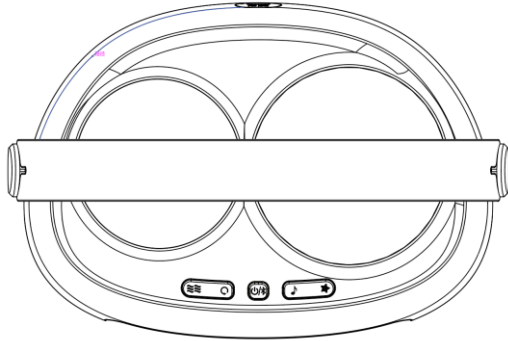

1. Charging indicator
2. TYPE-C USB charging port
3. Blue-eyes Decorative light
4. Remote IR receiver



1.  : Short press to turn on/off, the default mode is Bluetooth receiving mode, long press for 2 seconds to Bluetooth re-pairing mode.
2.  : Without Bluetooth connection, short press to play with its own music, short press again to play next song; In Bluetooth mode, short press to play or pause, long press to adjust the volume cyclically.
3.  : Short press to turn on/off the ocean light and switch 10 kinds of lights color in turn; Connected to Bluetooth playback and press this button twice, the ocean wave light will flash with the rhythm of the music.
4.  : Short press to turn on or off the star projector lamp and switch the 4 light modes in turn; Connected to Bluetooth playback and press this button twice, the star light will flash with the rhythm of the music.
5.  : short press to switch the wave rotation mode(slow, fast, shut off cycle of three states)

II. Bluetooth pairing:

- 1) When the device is power on, the default is bluetooth mode, enter the pairing connection state, it will automatically connected the last connected Bluetooth device. and there will be the voice prompt "bluetooth connected";
- 2) Turn on the Bluetooth on the device to search and add a new device: Select "CH186" in the Bluetooth list and connect it; (Please input "0000" if it is required to input the password)
- 3) After the first successful pairing, the projector will automatically connect the last connected device after entering Bluetooth pairing mode (please guarantee that the Bluetooth is turned on and within the connection range).

4) If it is required to disconnect the device, please disconnect it manually via your Bluetooth device. you will hear the voice prompt "disconnected";

Notes on pairing

1) Bluetooth interruption to connect to other Bluetooth devices: When the Bluetooth is connected,

press  for 2 seconds to enter the Bluetooth re-pairing state or short press the Bluetooth

button  on the remote control, the blue-eyes decorative light will flashes alternately, and it stays on after the connection is successful.

2) The effective distance for Bluetooth connection is 10m. Please guarantee that relevant device is within the range and a solid wall between them may be disconnected.

III. Music playing:



Bluetooth mode

In Bluetooth connection mode, the projector has connect with bluetooth "CH186", it can realize multiple music playing effects on any connected device.

1) Play/pause: After Bluetooth connected, shortly press the button  to directly play/pause the music in the default player of relevant device.

2) Volume+/volume-: Long press the button  to adjust the volume.

Local Music mode:

Shortly press  to turn on the projector (without blue tooth connected), Shortly press  to

play with its own relax music and shortly press  again to play next song.

IV. Charging

1) The projector lamp charging indicator is red during charging, and the red light will turns off when the charging is finished.

2) There will be a voice prompt "Low battery" when the power is too low, and it will automatically shut off when it is no power at all;

3) If the product is not used for a long time, we suggest to charge the product once a quarter to extend the life of the lithium battery.

V. Description of Remote control button function:

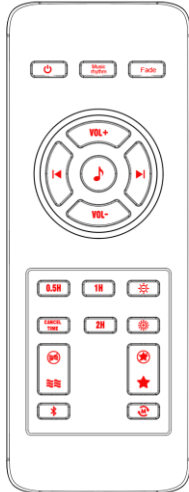

: Short press to standby or power on. (Press the POWER button on the projector to turn on this button to be effective)

Music rhythm

: Short press to turn on/off the flashing with the rhythm of the music;

Fade

: Short press to turn on/off the breathing mode;

VOL+

: Short press to increase the volume;

VOL-

: Short press to decrease the volume;



: Short press to play or pause music;



: Short press to play the previous song;



: Short press to play the next song;

0.5H

: Short press for 0.5 hours to play;

1H

: Short press for 1 hours to play;

2H

: Short press for 2 hours to play;

CANCEL TIME button: Short press to cancel the timer function;



: Short press to decrease the brightness.



: Short press to increase brightness.



Button: Short press the ocean wave light to switch.



Key: Short press the ocean light mode to switch.



Button: Short press the starry sky light to switch.



Key: Short press the starry sky light mode to switch.



Key: short press Bluetooth to re-pair (in any state of power on)



Key: Short press to turn off/on the ocean light motor. (slow, fast, off three state cycles)

VI. Safety Notes:

- 1) This product must be used under the rated voltage.
- 2) Do not put this product in a high temperature or humid environment, please put it in a dry place.
- 3) During maintenance, please wipe the product with a dry cloth. Do not clean it with water, alcohol, gasoline, acid or alkaline detergent. If metal objects or liquid are spilled into the product accidentally, please take off the power supply immediately, and the product can be used after inspection by a professional.
- 4) This product cannot be disassembled at will. If you need to repair it, please contact our after-sales customer service.
- 5) This product is for indoor use only. Operating temperature range: $-10^{\circ}\text{C}\sim 45^{\circ}\text{C}$; humidity range: $30\sim 70\%RH$.
- 6) If USB cable is inserted for charging, it is prohibited to use the projector in bathroom, bathtub or water to avoid electric shocks.

FCC warning:

—

Any Changes or modifications not expressly approved by the party responsible for compliance could void the user's authority to operate the equipment.

—

Note: This equipment has been tested and found to comply with the limits for a Class B digital device, pursuant to part 15 of the FCC Rules. These limits are designed to provide reasonable protection against harmful interference in a residential installation. This equipment generates uses and can radiate radio frequency energy and, if not installed and used in accordance with the instructions, may cause harmful interference to radio communications. However, there is no guarantee that interference will not occur in a particular installation. If this equipment does cause harmful interference to radio or television reception, which can be determined by turning the equipment off and on, the user is encouraged to try to correct the interference by one or more of the following measures:

-Reorient or relocate the receiving antenna.

-Increase the separation between the equipment and receiver.

-Connect the equipment into an outlet on a circuit different from that to which the receiver is connected.

-Consult the dealer or an experienced radio/TV technician for help.

—

This device complies with part 15 of the FCC Rules. Operation is subject to the following two conditions: (1) This device may not cause harmful interference, and (2) this device must accept any interference received, including interference that may cause undesired operation.