



FCC TEST REPORT

Test report

On Behalf of

Shenzhen Kangmingrui Technology Co., Ltd

For

Bluetooth headset

**Model No.: G01, G02, G03, G04, G05, G06, G07, G08, G09, G10,
G11, G12, G13, G14, G15, G16, G17, G18, G19, G20**

FCC ID: 2AZV6-G01

Prepared For : Shenzhen Kangmingrui Technology Co., Ltd

**Floor 3, Building 7, Huayisheng Industrial Park, Fuyong Street, Bao'an District,
Shenzhen, China**

Prepared By : Shenzhen HUAK Testing Technology Co., Ltd.

**1-2/F., Building B2, Junfeng Zhongcheng Zhizao Innovation Park, Heping, Fuhai
Street, Bao'an District, Shenzhen, Guangdong, China**

Date of Test: May. 08, 2021 ~ May. 14, 2021

Date of Report: May. 14, 2021

Report Number: HK2105111458-E



TEST RESULT CERTIFICATION

Applicant's name : Shenzhen Kangmingrui Technology Co., Ltd
Address : Floor 3, Building 7, Huayisheng Industrial Park, Fuyong Street,
 Bao'an District, Shenzhen, China
Manufacture's Name..... : Shenzhen Kangmingrui Technology Co., Ltd
Address : Floor 3, Building 7, Huayisheng Industrial Park, Fuyong Street,
 Bao'an District, Shenzhen, China

Product description

Trade Mark: N/A
Product name : Bluetooth headset
Model and/or type reference : G01, G02, G03, G04, G05, G06, G07, G08, G09, G10, G11, G12,
 G13, G14, G15, G16, G17, G18, G19, G20
Standards : FCC Rules and Regulations Part 15 Subpart C Section 15.249
 ANSI C63.10: 2013

This publication may be reproduced in whole or in part for non-commercial purposes as long as the Shenzhen HUAK Testing Technology Co., Ltd. is acknowledged as copyright owner and source of the material. Shenzhen HUAK Testing Technology Co., Ltd. takes no responsibility for and will not assume liability for damages resulting from the reader's interpretation of the reproduced material due to its placement and context.

Date of Test :
Date (s) of performance of tests : May. 08, 2021 ~ May. 14, 2021
Date of Issue..... : May. 14, 2021
Test Result..... : **Pass**

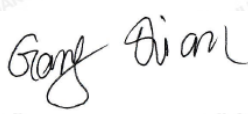
Testing Engineer : 

 (Gary Qian)

Technical Manager : 

Authorized Signatory : 

 (Jason Zhou)

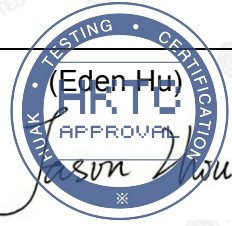

**Table of Contents****Page**

1 . TEST SUMMARY	5
2 . GENERAL INFORMATION	6
2.1 General Description Of Eut	6
2.2 Operation of EUT during testing	7
2.3 Description Of Test Setup	8
2.4 Measurement Instruments List	9
3 . CONDUCTED EMISSIONS TEST	10
3.1 Conducted Power Line Emission Limit	10
3.2 Test Setup	10
3.3 Test Procedure	10
3.4 Test Result	10
4. RADIATED EMISSION TEST	13
4.1 Radiation Limit	13
4.2 Test Setup	13
4.3 Test Procedure	14
4.4 Test Result	15
5. BAND EDGE	23
5.1 Limits	23
5.2 Test Procedure	23
5.3 Test Result	23
6. OCCUPIED BANDWIDTH MEASUREMENT	26
6.1 Test Setup	26
6.2 Test Procedure	26
6.3 Measurement Equipment Used	26
6.4 Test Result	26
7. ANTENNA REQUIREMENT	30
8. PHOTOGRAPH OF TEST	31
9. PHOTOS OF THE EUT	33



**** Modified History ****

Revision	Description	Issued Data	Remark
Revision 1.0	Initial Test Report Release	May. 14, 2021	Jason Zhou

The results shown in this test report refer only to the sample(s) tested unless otherwise stated and the sample(s) are retained for 30 days only. The document is issued by HUAK, this document cannot be reproduced except in full with our prior written permission. The more details and the authenticity of the report will be confirmed at <http://www.cer-mark.com>.

HUAK Testing Lab TEL : +86-755 2302 9901 FAX : +86-755 2302 9901 E-mail : service@cer-mark.com

1-2/F., Building B2, Junfeng Zhongcheng Zhizao Innovation Park, Heping, Fuhai Street, Bao'an District, Shenzhen, Guangdong, China



1. TEST SUMMARY

1.1 Test Procedures And Results

DESCRIPTION OF TEST	SECTION NUMBER	RESULT
CONDUCTED EMISSIONS TEST	15.207	COMPLIANT
RADIATED EMISSION TEST	15.249(a) /15.209	COMPLIANT
BAND EDGE	15.249(d)/15.205	COMPLIANT
OCCUPIED BANDWIDTH MEASUREMENT	15.215 (c)	COMPLIANT
ANTENNA REQUIREMENT	15.203	COMPLIANT

1.2 Test Facility

Test Firm : Shenzhen HUAKE Testing Technology Co., Ltd.

Address : 1-2/F., Building B2, Junfeng Zhongcheng Zhizao Innovation Park, Heping, Fuhai Street, Bao'an District, Shenzhen, Guangdong, China

1.3 Measurement Uncertainty

Measurement Uncertainty

- Conducted Emission Expanded Uncertainty = ±2.71dB, k=2
- Radiated emission expanded uncertainty(9kHz-30MHz) = ±3.90dB, k=2
- Radiated emission expanded uncertainty(30MHz-1000MHz) = ±3.90dB, k=2
- Radiated emission expanded uncertainty(Above 1GHz) = ±4.28dB, k=2

The results shown in this test report refer only to the sample(s) tested unless otherwise stated and the sample(s) are retained for 30 days only. The document is issued by HUAKE, this document cannot be reproduced except in full with our prior written permission. The more details and the authenticity of the report will be confirmed at <http://www.cer-mark.com>.



2. GENERAL INFORMATION

2.1 General Description Of Eut

Equipment:	Bluetooth headset
Model Name:	G01
Serial No.:	G02, G03, G04, G05, G06, G07, G08, G09, G10, G11, G12, G13, G14, G15, G16, G17, G18, G19, G20
Model Difference:	All model's the function, software and electric circuit are the same, only with a product color, appearance and model named different. Test sample model: G01.
FCC ID:	2AZV6-G01
Antenna Type:	Ceramic Antenna
Antenna Gain:	2dBi
BT Operation frequency:	2402-2480MHz
Number of Channels:	79CH
Modulation Type:	GFSK, $\pi/4$ DQPSK
Power Source:	DC 3.7V from battery or DC 5V from USB
Power Rating:	DC 3.7V from battery or DC 5V from USB

The results shown in this test report refer only to the sample(s) tested unless otherwise stated and the sample(s) are retained for 30 days only. The document is issued by HUAK, this document cannot be reproduced except in full with our prior written permission. The more details and the authenticity of the report will be confirmed at <http://www.cer-mark.com>.



2.1.1 Carrier Frequency of Channels

Channel List					
Channel	Frequency (MHz)	Channel	Frequency (MHz)	Channel	Frequency (MHz)
00	2402	27	2429	54	2456
01	2403	28	2430	55	2457
02	2404	29	2431	56	2458
03	2405	30	2432	57	2459
04	2406	31	2433	58	2460
05	2407	32	2434	59	2461
06	2408	33	2435	60	2462
07	2409	34	2436	61	2463
08	2410	35	2437	62	2464
09	2411	36	2438	63	2465
10	2412	37	2439	64	2466
11	2413	38	2440	65	2467
12	2414	39	2441	66	2468
13	2415	40	2442	67	2469
14	2416	41	2443	68	2470
15	2417	42	2444	69	2471
16	2418	43	2445	70	2472
17	2419	44	2446	71	2473
18	2420	45	2447	72	2474
19	2421	46	2448	73	2475
20	2422	47	2449	74	2476
21	2423	48	2450	75	2477
22	2424	49	2451	76	2478
23	2425	50	2452	77	2479
24	2426	51	2453	78	2480
25	2427	52	2454		
26	2428	53	2455		

2.2 Operation of EUT during testing

Operating Mode

The mode is used: **Transmitting mode**

Low Channel: 2402MHz

Middle Channel: 2441MHz

High Channel: 2480MHz



2.3 Description Of Test Setup

Operation of EUT during conducted testing:

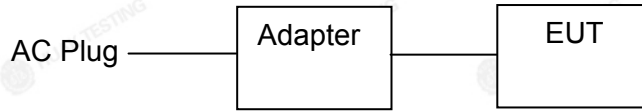

Operation of EUT during radiation below 1GHz and above 1GHz testing:

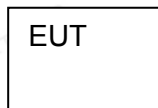

Adapter information

Model: HW-059200CHQ

Input: 100-240V, 50-60Hz, 0.5A

Output: 5VDC, 2A

The sample was placed (0.8m below 1GHz, 1.5m above 1GHz) above the ground plane of 3m chamber. Measurements in both horizontal and vertical polarities were performed. During the test, each emission was maximized by: having the EUT continuously working, investigated all operating modes, rotated about all 3 axis (X, Y & Z) and considered typical configuration to obtain worst position, manipulating interconnecting cables, rotating the turntable, varying antenna height from 1m to 4m in both horizontal and vertical polarizations. The emissions worst-case are shown in Test Results of the following pages. The worst case is X position.



2.4 Measurement Instruments List

Item	Equipment	Manufacturer	Model No.	Serial No.	Last Cal.	Cal. Interval
1.	L.I.S.N. Artificial Mains Network	R&S	ENV216	HKE-002	Jun. 18, 2020	1 Year
2.	Receiver	R&S	ESCI 7	HKE-010	Jun. 18, 2020	1 Year
3.	RF automatic control unit	Tonscend	JS0806-2	HKE-060	Jun. 18, 2020	1 Year
4.	Spectrum analyzer	R&S	FSP40	HKE-025	Jun. 18, 2020	1 Year
5.	Spectrum analyzer	Agilent	N9020A	HKE-048	Jun. 18, 2020	1 Year
6.	Preamplifier	Schwarzbeck	BBV 9743	HKE-006	Jun. 18, 2020	1 Year
7.	EMI Test Receiver	Rohde & Schwarz	ESCI 7	HKE-010	Jun. 18, 2020	1 Year
8.	Bilog Broadband Antenna	Schwarzbeck	VULB9163	HKE-012	Jun. 18, 2020	1 Year
9.	Loop Antenna	Schwarzbeck	FMZB 1519 B	HKE-014	Jun. 18, 2020	1 Year
10.	Horn Antenna	Schwarzbeck	9120D	HKE-013	Jun. 18, 2020	1 Year
11.	Pre-amplifier	EMCI	EMC051845 SE	HKE-015	Jun. 18, 2020	1 Year
12.	Pre-amplifier	Agilent	83051A	HKE-016	Jun. 18, 2020	1 Year
13.	EMI Test Software EZ-EMC	Tonscend	JS1120-B Version	HKE-083	Jun. 18, 2020	N/A
14.	Power Sensor	Agilent	E9300A	HKE-086	Jun. 18, 2020	1 Year
15.	Spectrum analyzer	Agilent	N9020A	HKE-048	Jun. 18, 2020	1 Year
16.	Signal generator	Agilent	N5182A	HKE-029	Jun. 18, 2020	1 Year
17.	Signal Generator	Agilent	83630A	HKE-028	Jun. 18, 2020	1 Year
18.	Shielded room	Shiel Hong	4*3*3	HKE-039	Dec. 17, 2020	3 Year
19.	Power meter	Agilent	E4419B	HKE-085	Jun. 18, 2020	1 Year
20.	Horn Antenna	Schwarzbeck	BBHA 9170	HKE-017	Jun. 18, 2020	1 Year

The calibration interval was one year.

3. CONDUCTED EMISSIONS TEST

3.1 Conducted Power Line Emission Limit

For unintentional device, according to § 15.107(a) Line Conducted Emission Limits is as following.

Frequency (MHz)	Maximum RF Line Voltage (dBµV)			
	CLASS A		CLASS B	
	Q.P.	Ave.	Q.P.	Ave.
0.15 - 0.50	79	66	66-56*	56-46*
0.50 - 5.00	73	60	56	46
5.00 - 30.0	73	60	60	50

* Decreasing linearly with the logarithm of the frequency

For intentional device, according to §15.207(a) Line Conducted Emission Limit is same as above table.

3.2 Test Setup

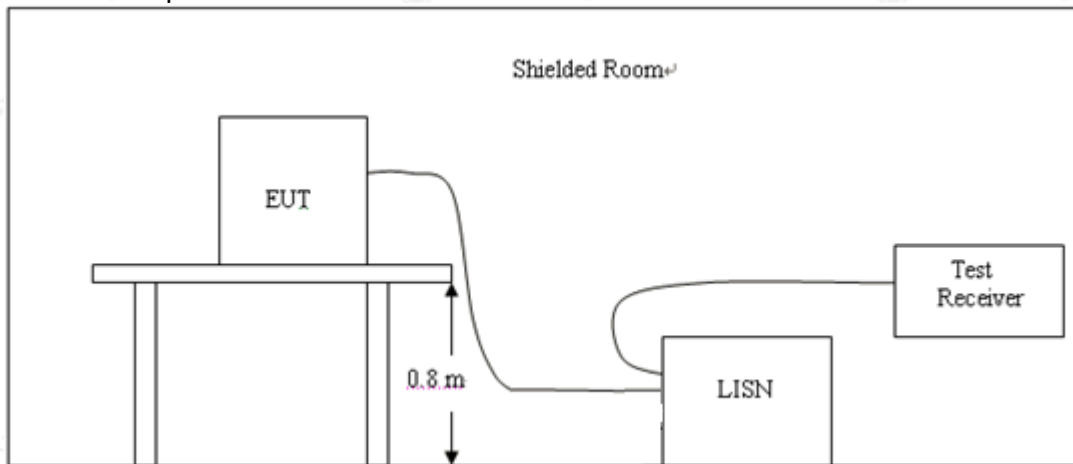

3.3 Test Procedure

1. The equipment was set up as per the test configuration to simulate typical actual usage per the user's manual. The EUT is a tabletop system, a wooden table with a height of 0.1 meters is used and is placed on the ground plane as per ANSI C63.10.
2. Support equipment, if needed, was placed as per ANSI C63.10.
3. All I/O cables were positioned to simulate typical actual usage as per ANSI C63.10.
4. If a EUT received DC power from the USB Port of Notebook PC, the PC's adapter received AC120V/60Hz power through a Line Impedance Stabilization Network (LISN) which supplied power source and was grounded to the ground plane.
5. All support equipments received AC power from a second LISN, if any.
6. The EUT test program was started. Emissions were measured on each current carrying line of the EUT using a spectrum Analyzer / Receiver connected to the LISN powering the EUT. The LISN has two monitoring points: Line 1 (Hot Side) and Line 2 (Neutral Side). Two scans were taken: one with Line 1 connected to Analyzer / Receiver and Line 2 connected to a 50 ohm load; the second scan had Line 1 connected to a 50 ohm load and Line 2 connected to the Analyzer / Receiver.
7. Analyzer / Receiver scanned from 150 KHz to 30MHz for emissions in each of the test modes.

3.4 Test Result

PASS

All the test modes completed for test. only the worst result of (GFSK High Channel) was reported as below:

The results shown in this test report refer only to the sample(s) tested unless otherwise stated and the sample(s) are retained for 30 days only. The document is issued by HUAKE, this document cannot be reproduced except in full with our prior written permission. The more details and the authenticity of the report will be confirmed at <http://www.cer-mark.com>.



Test Specification: Line

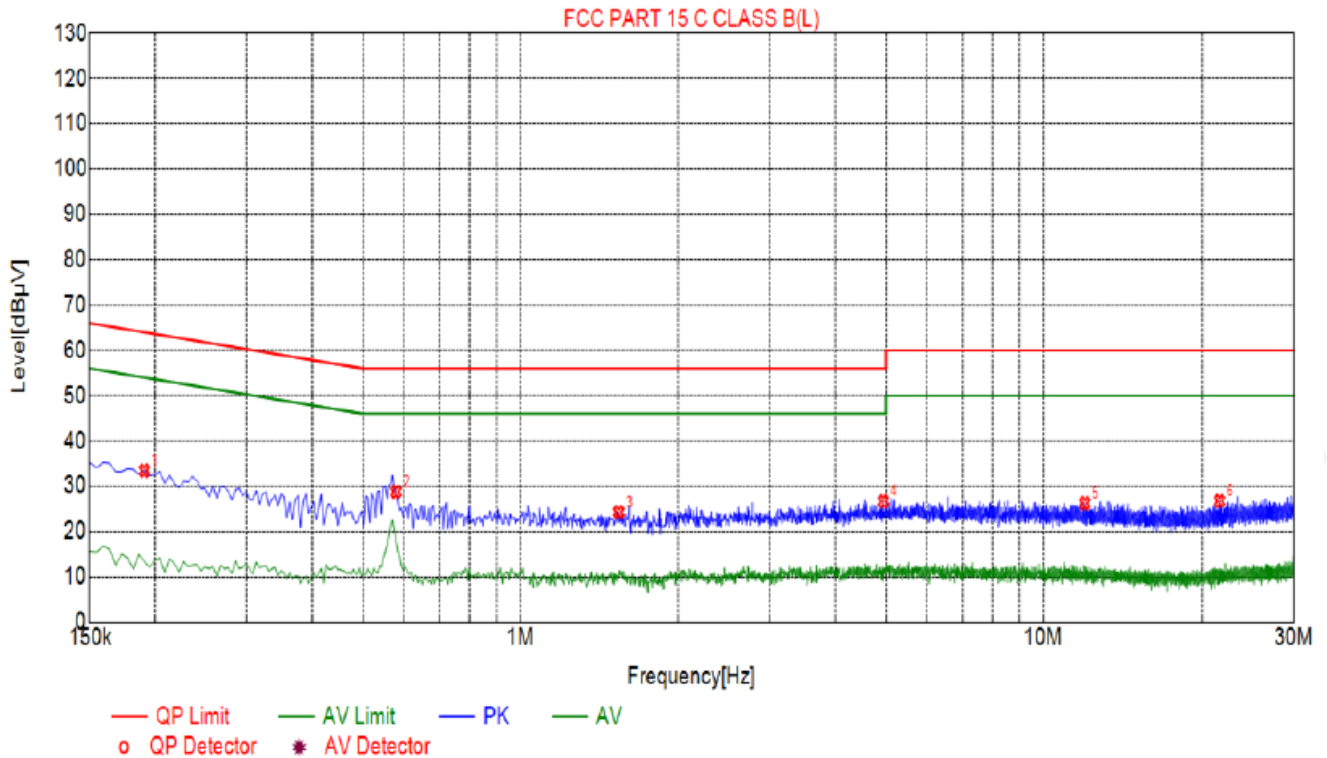

Suspected List								
NO.	Freq. [MHz]	Level [dBµV]	Factor [dB]	Limit [dBµV]	Margin [dB]	Reading [dBµV]	Detector	Type
1	0.1905	33.42	20.04	64.01	30.59	13.38	PK	L
2	0.5775	28.75	20.05	56.00	27.25	8.70	PK	L
3	1.5405	24.28	20.11	56.00	31.72	4.17	PK	L
4	4.9425	26.65	20.26	56.00	29.35	6.39	PK	L
5	12.0165	26.23	19.99	60.00	33.77	6.24	PK	L
6	21.6195	26.73	20.15	60.00	33.27	6.58	PK	L

Remark: Margin = Limit – Level

Correction factor = Cable lose + LISN insertion loss

Level=Test receiver reading + correction factor



Test Specification: Neutral

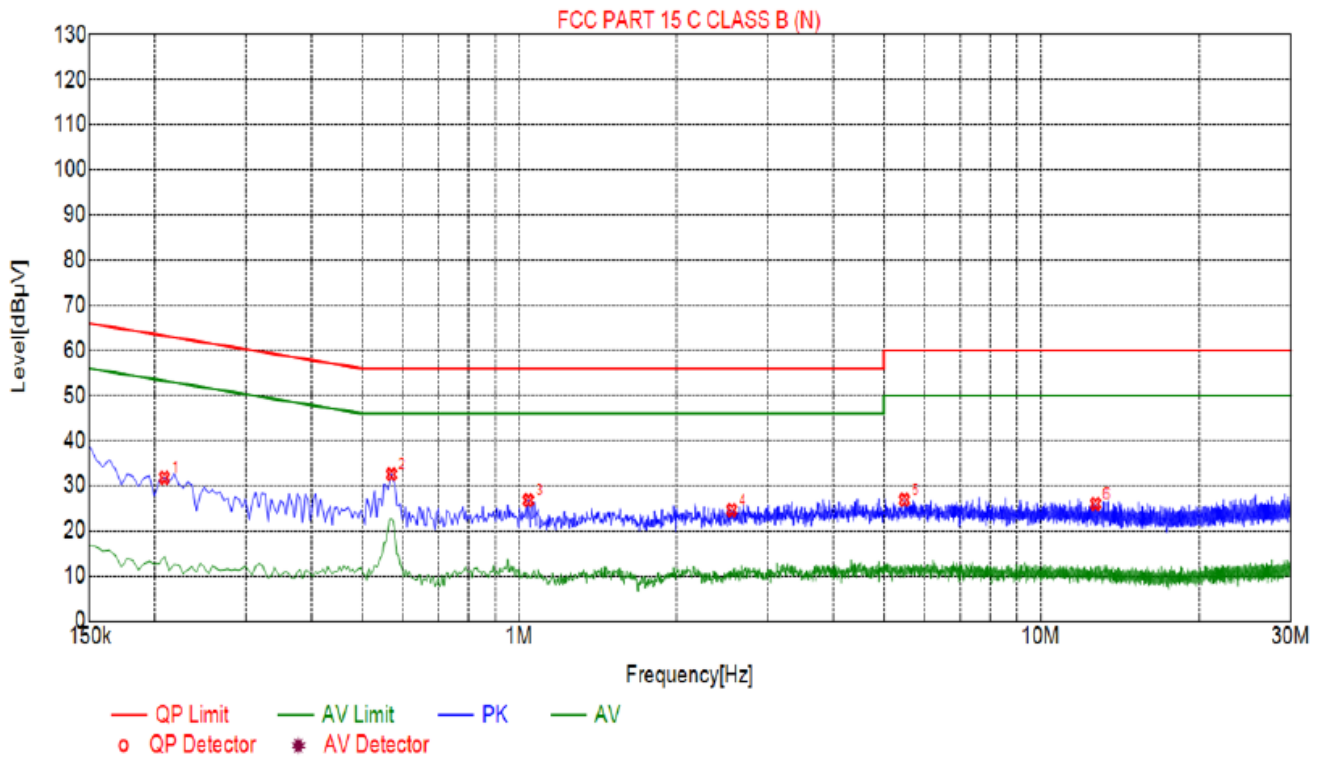

Suspected List								
NO.	Freq. [MHz]	Level [dBµV]	Factor [dB]	Limit [dBµV]	Margin [dB]	Reading [dBµV]	Detector	Type
1	0.2085	31.77	20.04	63.26	31.49	11.73	PK	N
2	0.5685	32.52	20.05	56.00	23.48	12.47	PK	N
3	1.0410	26.74	20.07	56.00	29.26	6.67	PK	N
4	2.5575	24.58	20.20	56.00	31.42	4.38	PK	N
5	5.4825	26.85	20.26	60.00	33.15	6.59	PK	N
6	12.7410	25.96	19.97	60.00	34.04	5.99	PK	N

Remark: Margin = Limit – Level

Correction factor = Cable lose + LISN insertion loss

Level=Test receiver reading + correction factor

4. RADIATED EMISSION TEST

4.1 Radiation Limit

For unintentional device, according to § 15.109(a), except for Class A digital devices, the field strength of radiated emissions from unintentional radiators at a distance of 3 meters shall not exceed the following values:

Frequency (MHz)	Distance (Meters)	Radiated (dBµV/m)	Radiated (µV/m)
0.009-0.49	3	$20\log(2400/F(\text{KHz}))+40\log(300/3)$	$2400/F(\text{KHz})$
0.49-1.705	3	$20\log(24000/F(\text{KHz}))+40\log(30/3)$	$24000/F(\text{KHz})$
1.705-30	3	$20\log(30)+40\log(30/3)$	30
30-88	3	40.0	100
88-216	3	43.5	150
216-960	3	46.0	200
Above 960	3	54.0	500

For intentional device, according to § 15.209(a), the general requirement of field strength of radiated emissions from intentional radiators at a distance of 3 meters shall not exceed the above table.

4.2 Test Setup

(1) Radiated Emission Test-Up Frequency Below 30MHz

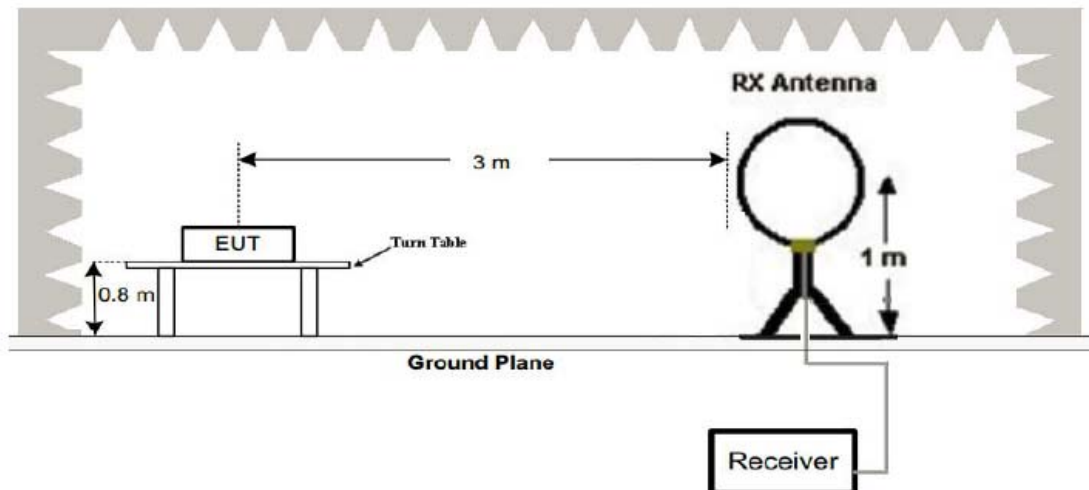

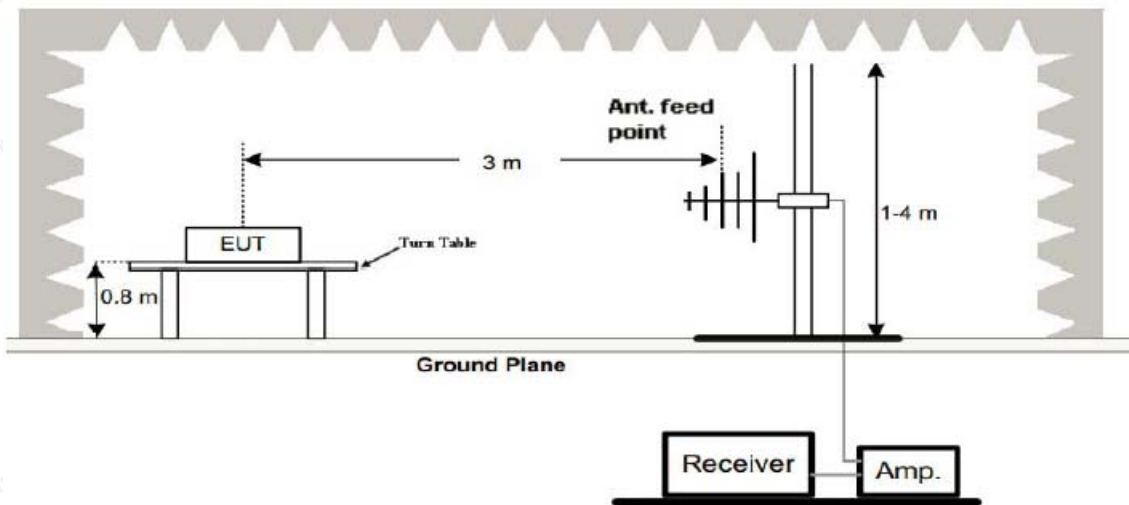
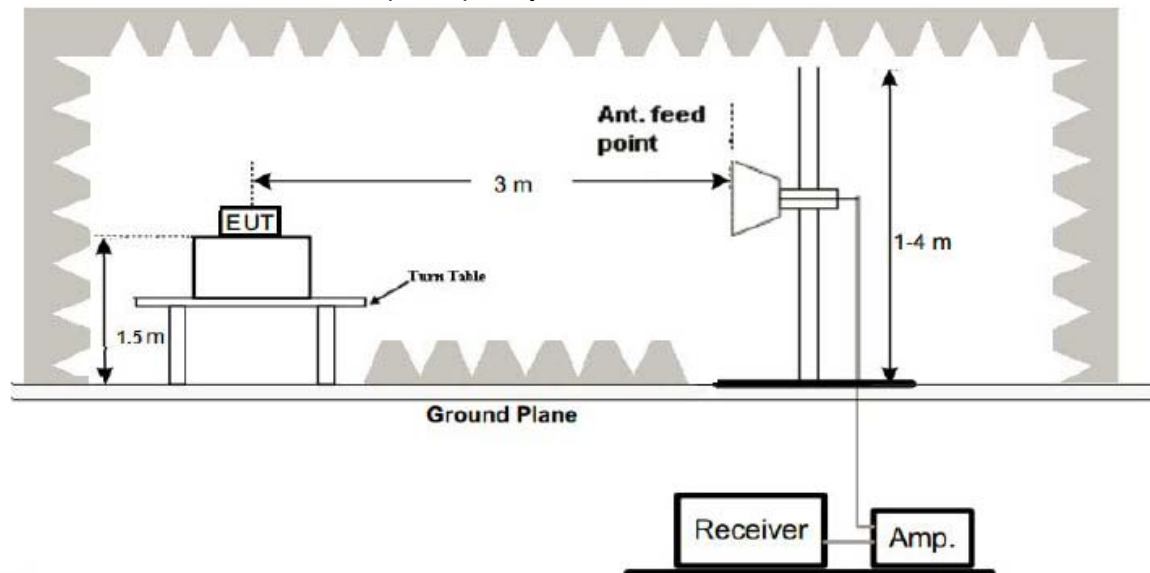
(2) Radiated Emission Test-Up Frequency 30MHz~1GHz**(3) Radiated Emission Test-Up Frequency Above 1GHz****4.3 Test Procedure**

1. Below 1GHz measurement the EUT is placed on turntable which is 0.8m above ground plane. And above 1GHz measurement EUT was placed on low permittivity and low tangent turn table which is 1.5m above ground plane.
2. The turntable shall be rotated for 360 degrees to determine the position of maximum emission level.
3. EUT is set 3m away from the receiving antenna, which is varied from 1m to 4m to find out the highest emissions.
4. Maximum procedure was performed on the six highest emissions to ensure EUT compliance.
5. And also, each emission was to be maximized by changing the polarization of receiving antenna both horizontal and vertical.
6. Repeat above procedures until the measurements for all frequencies are complete.
7. The test frequency range from 9KHz to 25GHz per FCC PART 15.33(a).

Note:

For battery operated equipment, the equipment tests shall be performed using a new battery.



4.4 Test Result

PASS

All the test modes completed for test. only the worst result of 8DPSK Low Channel was reported as below:

Below 1GHz Test Results:

Antenna polarity: H

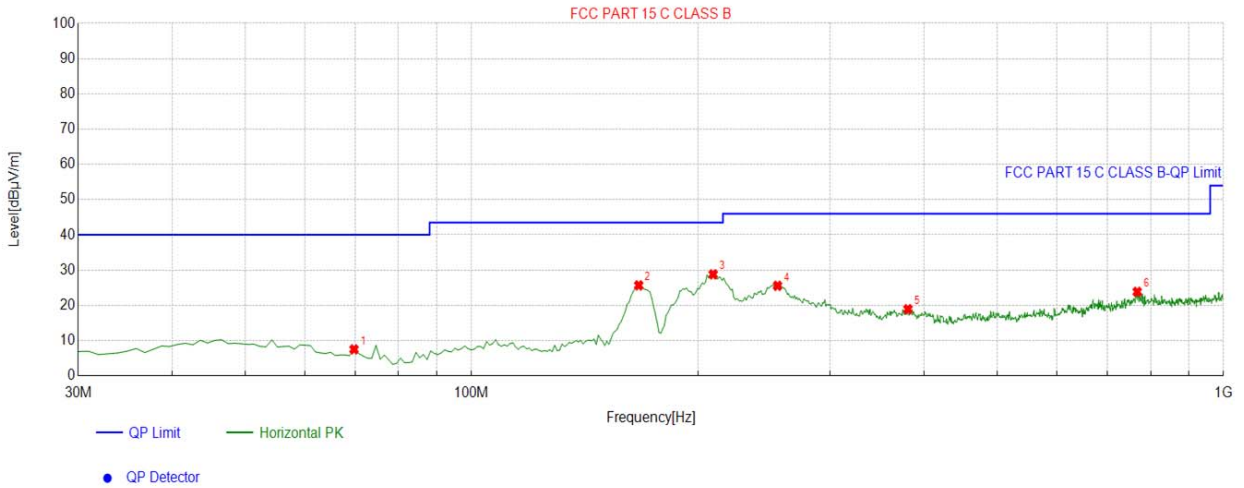

Suspected List									
NO.	Freq. [MHz]	Factor [dB]	Reading [dBµV/m]	Level [dBµV/m]	Limit [dBµV/m]	Margin [dB]	Height [cm]	Angle [°]	Polarity
1	69.8098	-17.62	25.13	7.51	40.00	32.49	100	281	Horizontal
2	166.9069	-17.58	43.25	25.67	43.50	17.83	100	12	Horizontal
3	209.6296	-14.81	43.60	28.79	43.50	14.71	100	352	Horizontal
4	255.2653	-13.46	39.01	25.55	46.00	20.45	100	170	Horizontal
5	380.5205	-10.82	29.73	18.91	46.00	27.09	100	21	Horizontal
6	767.9379	-3.30	27.14	23.84	46.00	22.16	100	123	Horizontal

Remark: Factor = Cable loss + Antenna factor - Pre-amplifier; Level = Reading + Factor; Margin = Limit - Level



Antenna polarity: V

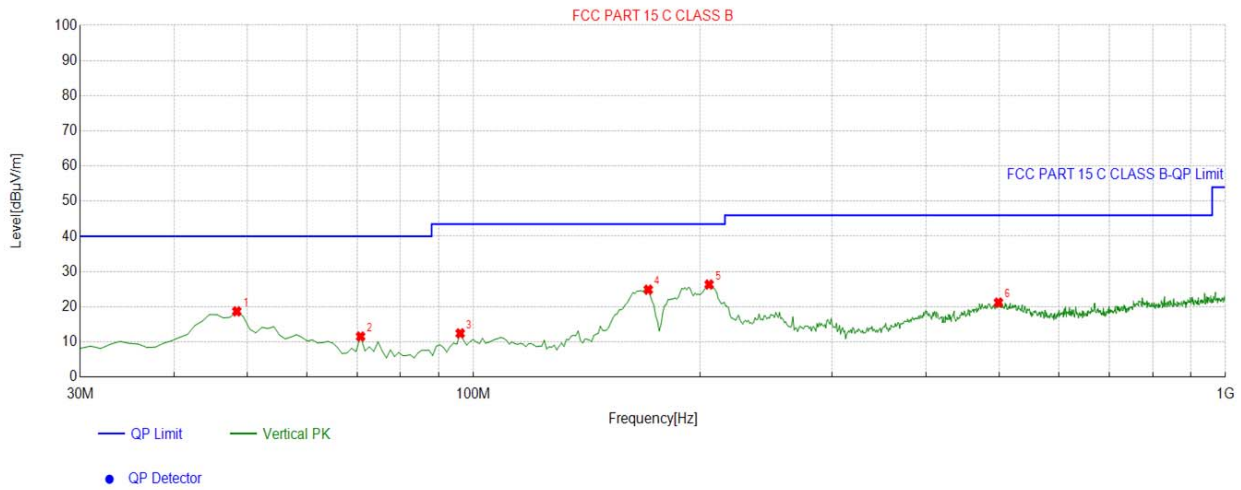

Suspected List									
NO.	Freq. [MHz]	Factor [dB]	Reading [dBµV/m]	Level [dBµV/m]	Limit [dBµV/m]	Margin [dB]	Height [cm]	Angle [°]	Polarity
1	48.4484	-13.65	32.33	18.68	40.00	21.32	100	177	Vertical
2	70.7808	-17.81	29.33	11.52	40.00	28.48	100	98	Vertical
3	96.0260	-16.06	28.48	12.42	43.50	31.08	100	35	Vertical
4	170.7908	-17.26	42.10	24.84	43.50	18.66	100	248	Vertical
5	205.7457	-14.91	41.23	26.32	43.50	17.18	100	237	Vertical
6	498.9790	-8.33	29.51	21.18	46.00	24.82	100	130	Vertical

Remark: Factor = Cable loss + Antenna factor - Pre-amplifier; Level = Reading + Factor; Margin = Limit - Level

Harmonics and Spurious Emissions

Frequency Range (9kHz-30MHz)

Frequency (MHz)	Level@3m (dBµV/m)	Limit@3m (dBµV/m)
--	--	--
--	--	--
--	--	--
--	--	--

Note: 1. Emission Level=Reading+ Cable loss+ Antenna factor-Amp factor.

2. The emission levels are 20 dB below the limit value, which are not reported. It is deemed to comply with the requirement.



Above 1 GHz Test Results:

GFSK:

CH Low (2402MHz)

Horizontal:

Frequency	Meter Reading	Factor	Emission Level	Limits	Margin	Detector Type
(MHz)	(dBμV)	(dB)	(dBμV/m)	(dBμV/m)	(dB)	
2402	111.19	-5.81	105.38	114.00	-8.62	peak
2402	85.34	-5.81	79.53	94.00	-14.47	AVG
4804	56.76	-3.65	53.11	74.00	-20.89	peak
4804	45.44	-3.65	41.79	54.00	-12.21	AVG
7206	57.21	-0.95	56.26	74.00	-17.74	peak
7206	41.81	-0.95	40.86	54.00	-13.14	AVG

Remark: Factor = Antenna Factor + Cable Loss – Pre-amplifier.

Vertical:

Frequency	Meter Reading	Factor	Emission Level	Limits	Margin	Detector Type
(MHz)	(dBμV)	(dB)	(dBμV/m)	(dBμV/m)	(dB)	
2402	111.22	-5.81	105.41	114.00	-8.59	peak
2402	86.75	-5.81	80.94	94.00	-13.06	AVG
4804	55.91	-3.65	52.26	74.00	-21.74	peak
4804	45.66	-3.65	42.01	54.00	-11.99	AVG
7206	56.47	-0.95	55.52	74.00	-18.48	peak
7206	41.97	-0.95	41.02	54.00	-12.98	AVG

Remark: Factor = Antenna Factor + Cable Loss – Pre-amplifier.

The results shown in this test report refer only to the sample(s) tested unless otherwise stated and the sample(s) are retained for 30 days only. The document is issued by HUAKE, this document cannot be reproduced except in full with our prior written permission. The more details and the authenticity of the report will be confirmed at <http://www.cer-mark.com>.



CH Middle (2441MHz)

Horizontal:

Frequency (MHz)	Meter Reading (dBμV)	Factor (dB)	Emission Level (dBμV/m)	Limits (dBμV/m)	Margin (dB)	Detector Type
2441	110.71	-5.73	104.98	114.00	-9.02	peak
2441	85.49	-5.73	79.76	94.00	-14.24	AVG
4882	55.03	-3.54	51.49	74.00	-22.51	peak
4882	45.53	-3.54	41.99	54.00	-12.01	AVG
7323	57.12	-0.81	56.31	74.00	-17.69	peak
7323	40.68	-0.81	39.87	54.00	-14.13	AVG

Remark: Factor = Antenna Factor + Cable Loss – Pre-amplifier.

Vertical:

Frequency (MHz)	Meter Reading (dBμV)	Factor (dB)	Emission Level (dBμV/m)	Limits (dBμV/m)	Margin (dB)	Detector Type
2441	110.57	-5.73	104.84	114.00	-9.16	peak
2441	85.28	-5.73	79.55	94.00	-14.45	AVG
4882	54.68	-3.54	51.14	74.00	-22.86	peak
4882	45.34	-3.54	41.80	54.00	-12.20	AVG
7323	56.88	-0.81	56.07	74.00	-17.93	peak
7323	40.76	-0.81	39.95	54.00	-14.05	AVG

Remark: Factor = Antenna Factor + Cable Loss – Pre-amplifier.



CH High (2480MHz)

Horizontal:

Frequency	Meter Reading	Factor	Emission Level	Limits	Margin	Detector Type
(MHz)	(dBμV)	(dB)	(dBμV/m)	(dBμV/m)	(dB)	
2480	110.24	-5.63	104.61	114.00	-9.39	peak
2480	83.66	-5.63	78.03	94.00	-15.97	AVG
4960	55.79	-3.43	52.36	74.00	-21.64	peak
4960	44.94	-3.44	41.50	54.00	-12.50	AVG
7440	55.78	-0.77	55.01	74.00	-18.99	peak
7440	39.12	-0.77	38.35	54.00	-15.65	AVG

Remark: Factor = Antenna Factor + Cable Loss – Pre-amplifier.

Vertical:

Frequency	Meter Reading	Factor	Emission Level	Limits	Margin	Detector Type
(MHz)	(dBμV)	(dB)	(dBμV/m)	(dBμV/m)	(dB)	
2480	108.93	-5.63	103.30	114.00	-10.70	peak
2480	84.59	-5.63	78.96	94.00	-15.04	AVG
4960	54.45	-3.43	51.02	74.00	-22.98	peak
4960	44.51	-3.44	41.07	54.00	-12.93	AVG
7440	54.14	-0.77	53.37	74.00	-20.63	peak
7440	38.67	-0.77	37.90	54.00	-16.10	AVG

Remark: Factor = Antenna Factor + Cable Loss – Pre-amplifier.

Remark :

- (1) Measuring frequencies from 1 GHz to the 25 GHz.
- (2) "F" denotes fundamental frequency; "H" denotes spurious frequency; "E" denotes band edge frequency.
- (3) * denotes emission frequency which appearing within the Restricted Bands specified in provision of 15.205, then the general radiated emission limits in 15.209 apply.
- (4) The emissions are attenuated more than 20dB below the permissible limits are not recorded in the report.
- (5) The IF bandwidth of EMI Test Receiver between 30MHz to 1GHz was 120KHz, 1 MHz for measuring above 1 GHz, below 30MHz was 10KHz. The resolution bandwidth of test receiver/spectrum analyzer is 1MHz and video bandwidth is 3MHz for peak measurement with peak detector at frequency above 1GHz. The resolution bandwidth of test receiver/spectrum analyzer is 1MHz and video bandwidth is 10Hz for Average measurement with peak detection at frequency above 1GHz.
- (6) When the test results of Peak Detected below the limits of Average Detected, the Average Detected is not need completed. For example: Top Channel at Fundamental 73.16dBuV/m(PK Value) <93.98(AV Limit), at harmonic 53.20 dBuV/m(PK Value) <54 dBuV/m(AV Limit), the Average Detected not need to completed.
- (7) All modes of operation were investigated and the worst-case emissions are reported.



π/4DQPSK:
CH Low (2402MHz)
Horizontal:

Frequency	Meter Reading	Factor	Emission Level	Limits	Margin	Detector Type
(MHz)	(dBμV)	(dB)	(dBμV/m)	(dBμV/m)	(dB)	
2402	111.69	-5.81	105.88	114.00	-8.12	peak
2402	86.18	-5.81	80.37	94.00	-13.63	AVG
4804	55.58	-3.65	51.93	74.00	-22.07	peak
4804	45.76	-3.65	42.11	54.00	-11.89	AVG
7206	57.64	-0.95	56.69	74.00	-17.31	peak
7206	41.74	-0.95	40.79	54.00	-13.21	AVG

Remark: Factor = Antenna Factor + Cable Loss – Pre-amplifier.

Vertical:

Frequency	Meter Reading	Factor	Emission Level	Limits	Margin	Detector Type
(MHz)	(dBμV)	(dB)	(dBμV/m)	(dBμV/m)	(dB)	
2402	110.05	-5.81	104.24	114.00	-9.76	peak
2402	84.92	-5.81	79.11	94.00	-14.89	AVG
4804	54.69	-3.65	51.04	74.00	-22.96	peak
4804	44.99	-3.65	41.34	54.00	-12.66	AVG
7206	55.18	-0.95	54.23	74.00	-19.77	peak
7206	40.35	-0.95	39.40	54.00	-14.60	AVG

Remark: Factor = Antenna Factor + Cable Loss – Pre-amplifier.



CH Middle (2441MHz)

Horizontal:

Frequency (MHz)	Meter Reading (dBμV)	Factor (dB)	Emission Level (dBμV/m)	Limits (dBμV/m)	Margin (dB)	Detector Type
2441	110.28	-5.73	104.55	114.00	-9.45	peak
2441	85.02	-5.73	79.29	94.00	-14.71	AVG
4882	55.32	-3.54	51.78	74.00	-22.22	peak
4882	44.42	-3.54	40.88	54.00	-13.12	AVG
7323	56.13	-0.81	55.32	74.00	-18.68	peak
7323	41.02	-0.81	40.21	54.00	-13.79	AVG

Remark: Factor = Antenna Factor + Cable Loss – Pre-amplifier.

Vertical:

Frequency (MHz)	Meter Reading (dBμV)	Factor (dB)	Emission Level (dBμV/m)	Limits (dBμV/m)	Margin (dB)	Detector Type
2441	109.42	-5.73	103.69	114.00	-10.31	peak
2441	84.51	-5.73	78.78	94.00	-15.22	AVG
4882	54.33	-3.54	50.79	74.00	-23.21	peak
4882	44.57	-3.54	41.03	54.00	-12.97	AVG
7323	56.46	-0.81	55.65	74.00	-18.35	peak
7323	38.57	-0.81	37.76	54.00	-16.24	AVG

Remark: Factor = Antenna Factor + Cable Loss – Pre-amplifier.



CH High (2480MHz)

Horizontal:

Frequency (MHz)	Meter Reading (dBμV)	Factor (dB)	Emission Level (dBμV/m)	Limits (dBμV/m)	Margin (dB)	Detector Type
2480	110.22	-5.63	104.59	114.00	-9.41	peak
2480	83.18	-5.63	77.55	94.00	-16.45	AVG
4960	55.07	-3.43	51.64	74.00	-22.36	peak
4960	43.95	-3.44	40.51	54.00	-13.49	AVG
7440	55.46	-0.77	54.69	74.00	-19.31	peak
7440	37.38	-0.77	36.61	54.00	-17.39	AVG

Remark: Factor = Antenna Factor + Cable Loss – Pre-amplifier.

Vertical:

Frequency (MHz)	Meter Reading (dBμV)	Factor (dB)	Emission Level (dBμV/m)	Limits (dBμV/m)	Margin (dB)	Detector Type
2480	108.64	-5.63	103.01	114.00	-10.99	peak
2480	84.34	-5.63	78.71	94.00	-15.29	AVG
4960	52.45	-3.43	49.02	74.00	-24.98	peak
4960	45.13	-3.44	41.69	54.00	-12.31	AVG
7440	55.67	-0.77	54.90	74.00	-19.10	peak
7440	40.36	-0.77	39.59	54.00	-14.41	AVG

Remark: Factor = Antenna Factor + Cable Loss – Pre-amplifier.

Remark :

- (1) Measuring frequencies from 1 GHz to the 25 GHz.
- (2) "F" denotes fundamental frequency; "H" denotes spurious frequency; "E" denotes band edge frequency.
- (3) * denotes emission frequency which appearing within the Restricted Bands specified in provision of 15.205, then the general radiated emission limits in 15.209 apply.
- (4) The emissions are attenuated more than 20dB below the permissible limits are not recorded in the report.
- (5) The IF bandwidth of EMI Test Receiver between 30MHz to 1GHz was 120KHz, 1 MHz for measuring above 1 GHz, below 30MHz was 10KHz. The resolution bandwidth of test receiver/spectrum analyzer is 1MHz and video bandwidth is 3MHz for peak measurement with peak detector at frequency above 1GHz. The resolution bandwidth of test receiver/spectrum analyzer is 1MHz and video bandwidth is 10Hz for Average measurement with peak detection at frequency above 1GHz.
- (6) When the test results of Peak Detected below the limits of Average Detected, the Average Detected is not need completed. For example: Top Channel at Fundamental 73.16dBuV/m(PK Value) <93.98(AV Limit), at harmonic 53.20 dBuV/m(PK Value) <54 dBuV/m(AV Limit), the Average Detected not need to completed.
- (7) All modes of operation were investigated and the worst-case emissions are reported.



5. BAND EDGE

5.1 Limits

FCC PART 15.249(d) Emissions radiated outside of the specified frequency bands, except for harmonics, shall be attenuated by at least 50 dB below the level of the fundamental or to the general radiated emission limits in §15.209, whichever is the lesser attenuation.

5.2 Test Procedure

The band edge compliance of RF radiated emission should be measured by following the guidance in ANSI C63.10 with respect to maximizing the emission by rotating the EUT, measuring the emission while the EUT is situated in three orthogonal planes (if appropriate), adjusting the measurement antenna height and polarization etc. Set RBW to 1MHz and VBM to 3MHz to measure the peak field strength and set RBW to 1MHz and VBW to 10Hz to measure the average radiated field strength. The conducted RF band edge was measured by using a spectrum analyzer. Set span wide enough to capture the highest in-band emission and the emission at the band edge. Set RBW to 1MHz and VBW to 3MHz, to measure the conducted peak band edge.

5.3 Test Result

PASS

All the test modes completed for test. The worst case of Band Edge is GFSK; the test data of this mode was reported.



Radiated Band Edge Test:

Operation Mode: TX CH Low (2402MHz)

Horizontal (Worst case)

Frequency (MHz)	Meter Reading (dBμV)	Factor (dB)	Emission Level (dBμV/m)	Limits (dBμV/m)	Margin (dB)	Detector Type
2310	55.28	-5.81	49.47	74	-24.53	peak
2310	/	-5.81	/	54	/	AVG
2390	54.19	-5.84	48.35	74	-25.65	peak
2390	/	-5.84	/	54	/	AVG
2400	54.67	-5.84	48.83	74	-25.17	peak
2400	/	-5.84	/	54	/	AVG

Vertical:

Frequency (MHz)	Meter Reading (dBμV)	Factor (dB)	Emission Level (dBμV/m)	Limits (dBμV/m)	Margin (dB)	Detector Type
2310	54.11	-5.81	48.3	74	-25.7	peak
2310	/	-5.81	/	54	/	AVG
2390	53.66	-5.84	47.82	74	-26.18	peak
2390	/	-5.84	/	54	/	AVG
2400	53.87	-5.84	48.03	74	-25.97	peak
2400	/	-5.84	/	54	/	AVG

Remark: Factor = Antenna Factor + Cable Loss – Pre-amplifier.



Operation Mode: TX CH High (2480MHz)

Horizontal (Worst case)

Frequency (MHz)	Meter Reading (dBμV)	Factor (dB)	Emission Level (dBμV/m)	Limits (dBμV/m)	Margin (dB)	Detector Type
2483.50	55.23	-5.81	49.42	74	-24.58	peak
2483.50	/	-5.81	/	54	/	AVG
2500.00	53.68	-6.06	47.62	74	-26.38	peak
2500.00	/	-6.06	/	54	/	AVG

Remark: Factor = Antenna Factor + Cable Loss – Pre-amplifier.

Vertical:

Frequency (MHz)	Meter Reading (dBμV)	Factor (dB)	Emission Level (dBμV/m)	Limits (dBμV/m)	Margin (dB)	Detector Type
2483.50	54.26	-5.81	48.45	74	-25.55	peak
2483.50	/	-5.81	/	54	/	AVG
2500.00	53.77	-6.06	47.71	74	-26.29	peak
2500.00	/	-6.06	/	54	/	AVG

Remark: Factor = Antenna Factor + Cable Loss – Pre-amplifier.

Remark: All the other emissions not reported were too low to read and deemed to comply with FCC limit.



6. OCCUPIED BANDWIDTH MEASUREMENT

6.1 Test Setup

Same as Radiated Emission Measurement

6.2 Test Procedure

1. The EUT was placed on a turn table which is 0.8m above ground plane.
2. Set EUT as normal operation.
3. Based on ANSI C63.10 section 6.9.2: RBW= 30KHz. VBW= 100 KHz, Span=3MHz.
4. The useful radiated emission from the EUT was detected by the spectrum analyzer with peak detector.

6.3 Measurement Equipment Used

Same as Radiated Emission Measurement

6.4 Test Result

PASS

Test Mode	Frequency	20dB Bandwidth (MHz)	Result
GFSK	2402 MHz	0.9476	PASS
	2441 MHz	0.9509	PASS
	2480 MHz	0.9482	PASS
$\pi/4$ DQPSK	2402 MHz	1.308	PASS
	2441 MHz	1.310	PASS
	2480 MHz	1.308	PASS



Test Mode: GFSK

CH: 2402MHz

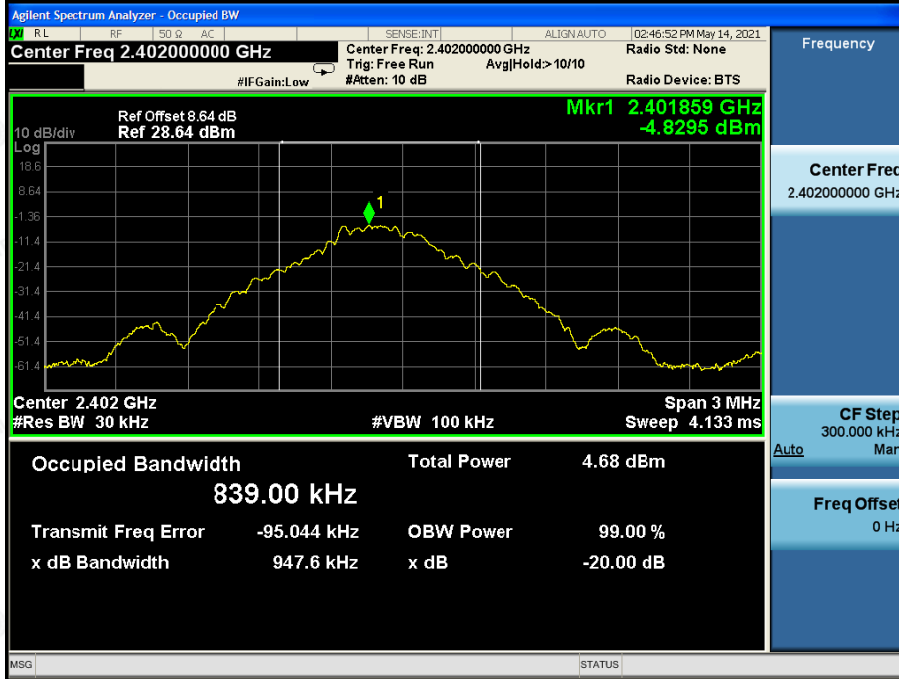

CH: 2441MHz

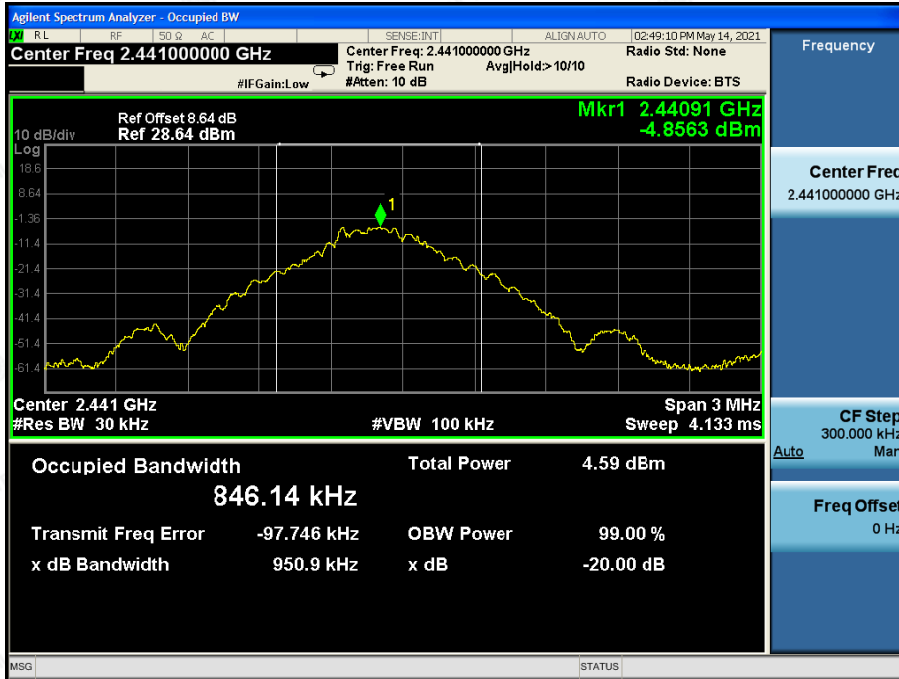

The results shown in this test report refer only to the sample(s) tested unless otherwise stated and the sample(s) are retained for 30 days only. The document is issued by HUAJAK, this document cannot be reproduced except in full with our prior written permission. The more details and the authenticity of the report will be confirmed at <http://www.cer-mark.com>.



CH: 2480MHz

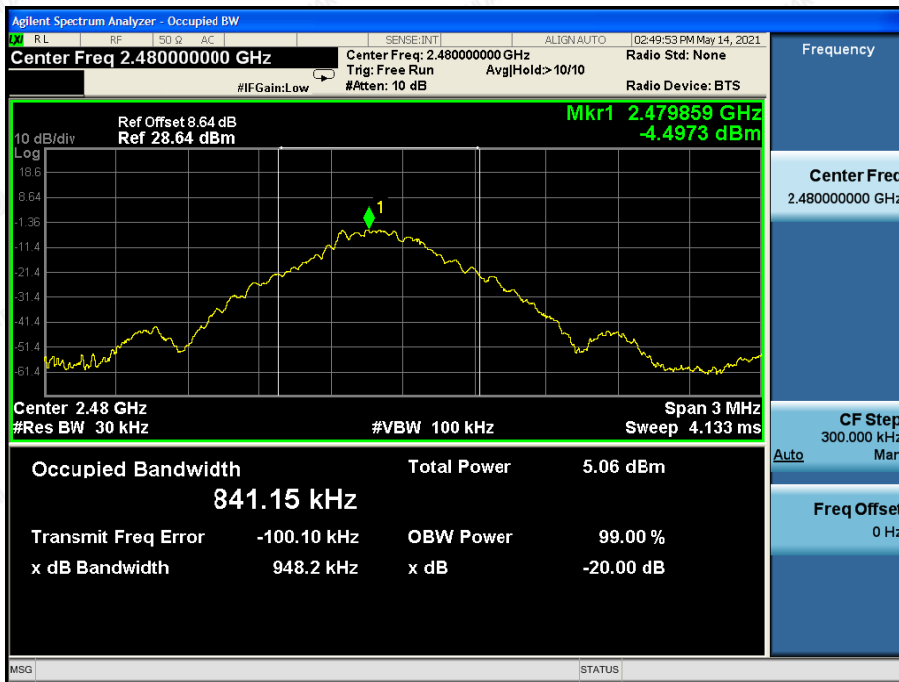

Test Mode: $\pi/4$ DQPSK

CH: 2402MHz

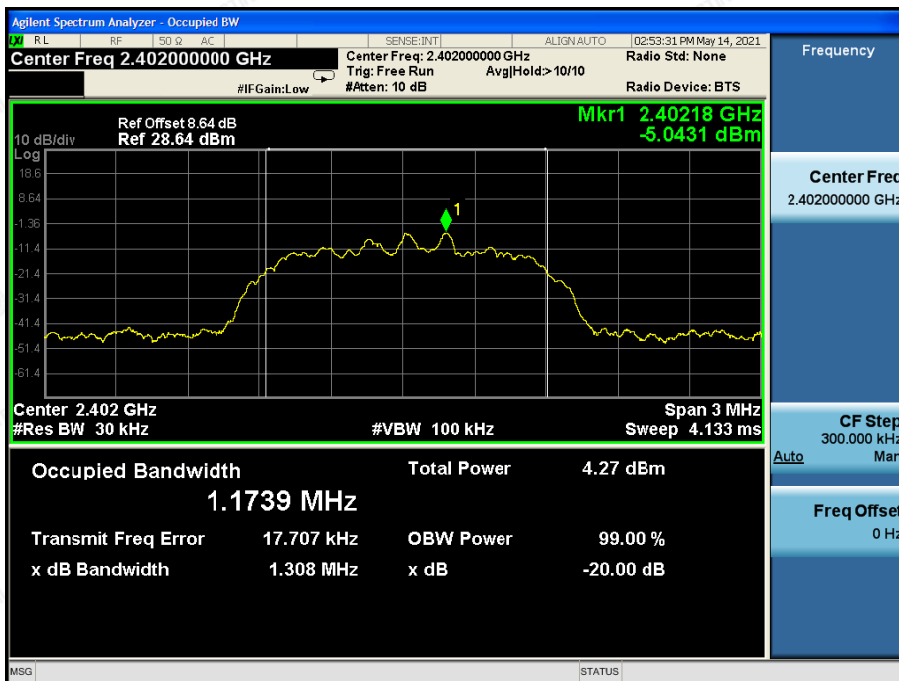

The results shown in this test report refer only to the sample(s) tested unless otherwise stated and the sample(s) are retained for 30 days only. The document is issued by HUAKE, this document cannot be reproduced except in full with our prior written permission. The more details and the authenticity of the report will be confirmed at <http://www.cer-mark.com>.



CH: 2441MHz

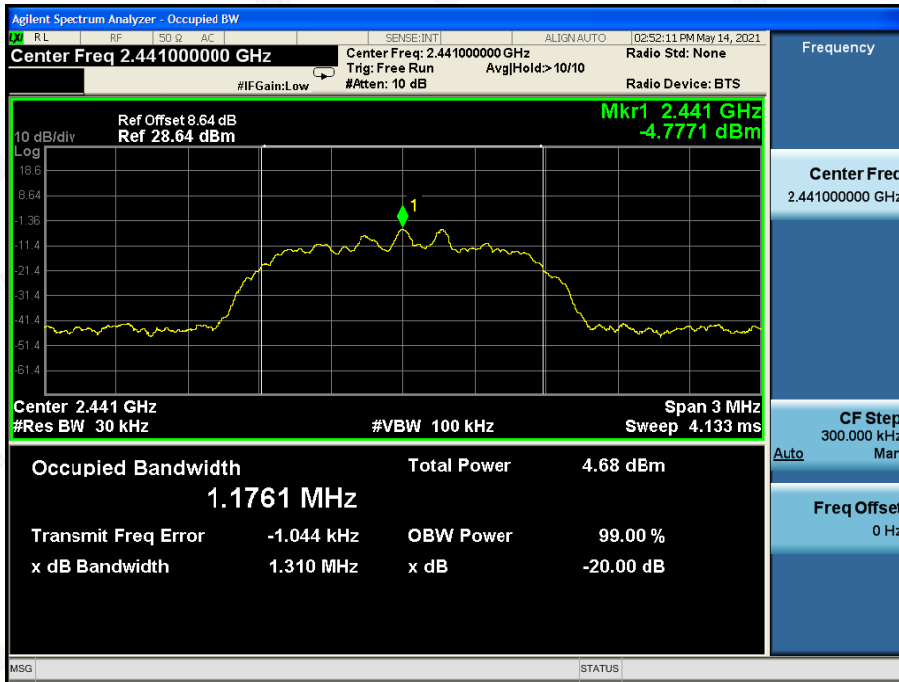

CH: 2480MHz

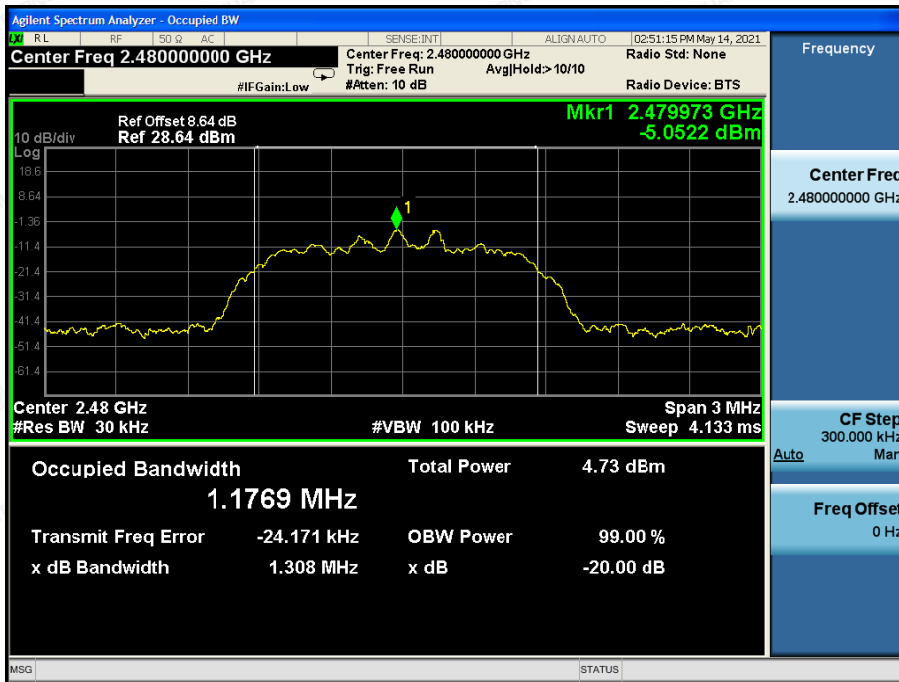

The results shown in this test report refer only to the sample(s) tested unless otherwise stated and the sample(s) are retained for 30 days only. The document is issued by HUAKE, this document cannot be reproduced except in full with our prior written permission. The more details and the authenticity of the report will be confirmed at <http://www.cer-mark.com>.

7. ANTENNA REQUIREMENT

Standard Applicable

For intentional device, according to FCC 47 CFR Section 15.203, an intentional radiator shall be designed to ensure that no antenna other than that furnished by the responsible party shall be used with the device. And according to FCC 47 CFR Section 15.249, if transmitting antennas of directional gain greater than 6dBi are used, the power shall be reduced by the amount in dB that the directional gain of the antenna exceeds 6dBi.

Antenna Connected Construction

The antenna used in this product is a Ceramic Antenna, which permanently attached. It conforms to the standard requirements. The directional gains of antenna used for transmitting is 2dBi.

ANTENNA

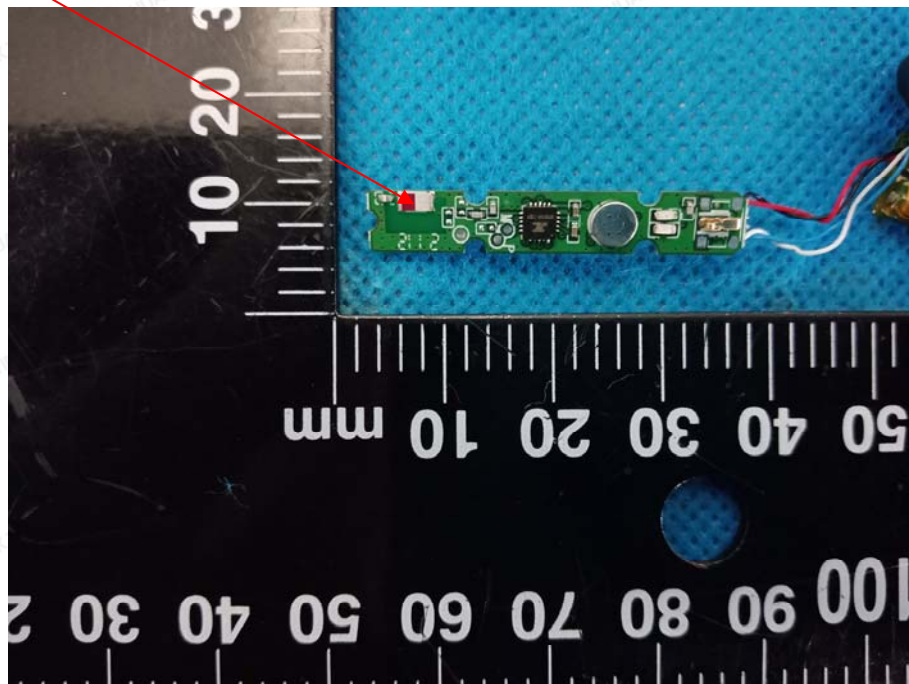



8. PHOTOGRAPH OF TEST

Radiated Emission

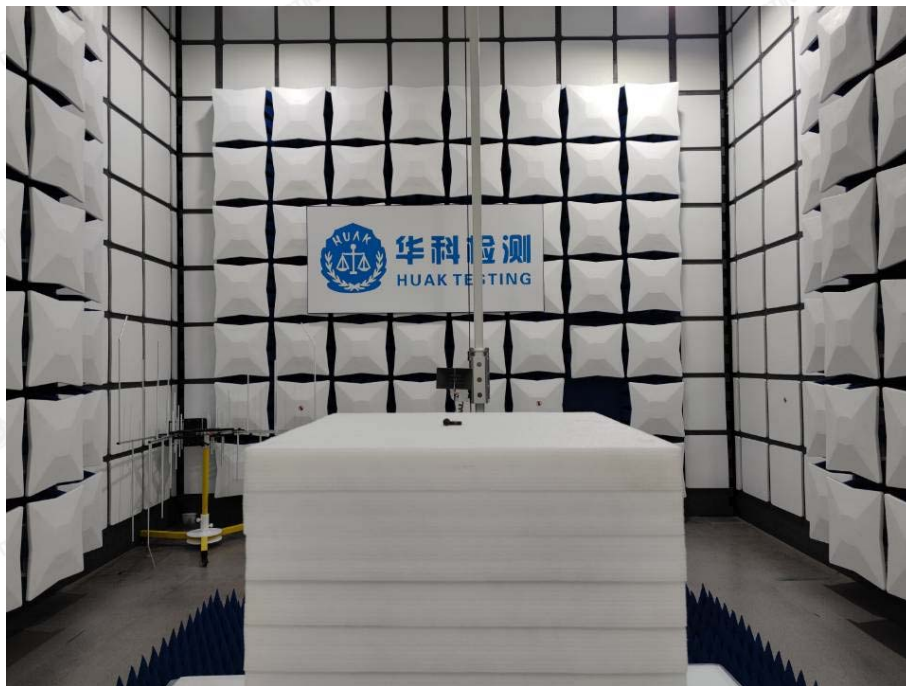
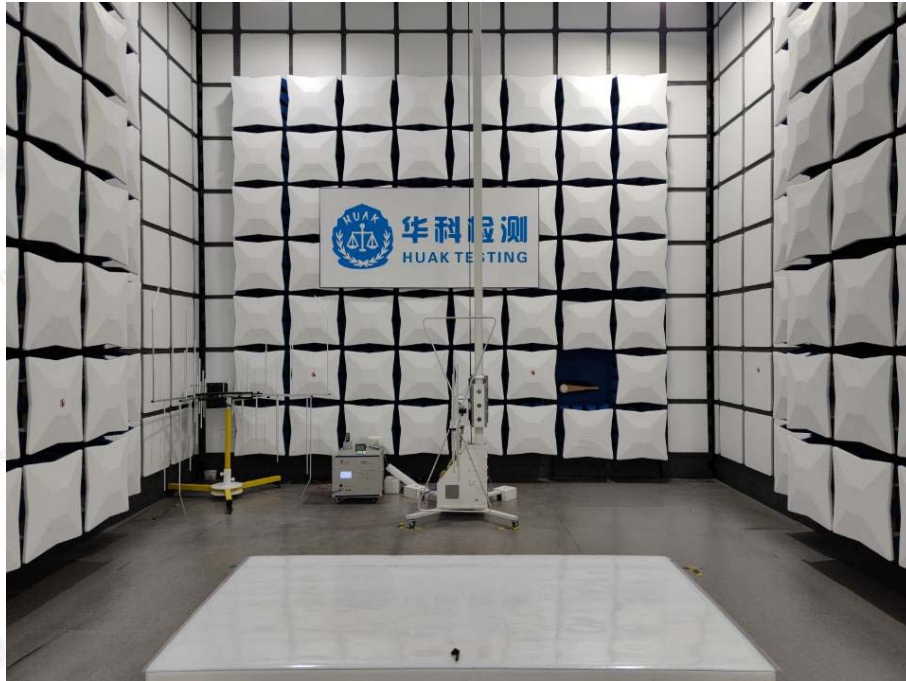

The results shown in this test report refer only to the sample(s) tested unless otherwise stated and the sample(s) are retained for 30 days only. The document is issued by HUAK, this document cannot be reproduced except in full with our prior written permission. The more details and the authenticity of the report will be confirmed at <http://www.cer-mark.com>.

HUAK Testing Lab TEL : +86-755 2302 9901 FAX : +86-755 2302 9901 E-mail : service@cer-mark.com

1-2/F., Building B2, Junfeng Zhongcheng Zhizao Innovation Park, Heping, Fuhai Street, Bao'an District, Shenzhen, Guangdong, China



Conducted Emission



The results shown in this test report refer only to the sample(s) tested unless otherwise stated and the sample(s) are retained for 30 days only. The document is issued by HUAK, this document cannot be reproduced except in full with our prior written permission. The more details and the authenticity of the report will be confirmed at <http://www.cer-mark.com>.

HUAK Testing Lab TEL : +86-755 2302 9901 FAX : +86-755 2302 9901 E-mail : service@cer-mark.com

1-2/F., Building B2, Junfeng Zhongcheng Zhizao Innovation Park, Heping, Fuhai Street, Bao'an District, Shenzhen, Guangdong, China



9. PHOTOS OF THE EUT

Reference to the report: ANNEX A of external photos and ANNEX B of internal photos.

-----End of test report-----