

FCC TEST REPORT

FCC ID: 2AZUX-S02

Report Number : ZKT-210427L1534E

Date of Test Apr. 25, 2021 to May. 10, 2021

Date of issue : May. 10, 2021

Total number of pages 55

Test Result : PASS

Testing Laboratory : **Shenzhen ZKT Technology Co., Ltd.**

Address : 1/F, No. 101, Building B, No. 6, Tangwei Community Industrial Avenue,
Fuhai Street, Bao'an District, Shenzhen, China

Applicant's name : Shenzhen Anran Security Technology Co., Ltd

Address : No.290, Jihua Road, Jihua street, Longgang District, Shenzhen,
No.112

Manufacturer's name : Shenzhen Anran Security Technology Co., Ltd

Address : No.290, Jihua Road, Jihua street, Longgang District, Shenzhen,
No.112

Test specification:

Standard : FCC CFR Title 47 Part 15 Subpart C Section 15.247
ANSI C63.10:2013

Test procedure : /

Non-standard test method : N/A

Test Report Form No. : TRF-EL-110_V0

Test Report Form(s) Originator : ZKT Testing

Master TRF : Dated: 2020-01-06

This device described above has been tested by ZKT, and the test results show that the equipment under test (EUT) is in compliance with the FCC requirements. And it is applicable only to the tested sample identified in the report.

This report shall not be reproduced except in full, without the written approval of ZKT, this document may be altered or revised by ZKT, personal only, and shall be noted in the revision of the document.

Product name : IP Camera with Battery

Trademark : N/A

Model/Type reference : S02

S01, S02J, S03, S06, N01, N02, N03, M01, M02, Q01, Q02

Ratings : DC 3.7V from battery

DC 5V from charger

Testing procedure and testing location:

Testing Laboratory.....: **Shenzhen ZKT Technology Co., Ltd.**

Address.....: 1/F, No. 101, Building B, No. 6, Tangwei Community Industrial Avenue, Fuhai Street, Bao'an District, Shenzhen, China

Tested by (name + signature): Alen He



Reviewer (name + signature).....: Joe Liu



Approved (name + signature): Lake Xie



Table of Contents

	Page
1. VERSION	5
2. SUMMARY OF TEST RESULTS.....	6
2.1 TEST FACILITY	7
2.2 MEASUREMENT UNCERTAINTY	7
3. GENERAL INFORMATION	8
3.1 GENERAL DESCRIPTION OF EUT.....	8
3.2 DESCRIPTION OF TEST MODES.....	9
3.3 BLOCK DIGRAM SHOWING THE CONFIGURATION OF SYSTEM TESTED.....	9
3.4 DESCRIPTION OF SUPPORT UNITS(CONDUCTED MODE).....	9
3.5EQUIPMENTS LIST FOR ALL TEST ITEMS.....	10
4. EMC EMISSION TEST	11
4.1 CONDUCTED EMISSION MEASUREMENT	11
4.1.1 POWER LINE CONDUCTED EMISSION Limits	11
4.1.2 TEST PROCEDURE.....	11
4.1.3 DEVIATION FROM TEST STANDARD.....	11
4.1.4 TEST SETUP.....	11
4.1.5 EUT OPERATING CONDITIONS.....	11
4.1.6 TEST RESULT.....	12
4.2 RADIATED EMISSION MEASUREMENT	14
4.2.1 RADIATED EMISSION LIMITS.....	14
4.2.2 TEST PROCEDURE.....	14
4.2.3 DEVIATION FROM TEST STANDARD.....	15
4.2.4 TEST SETUP.....	15
4.2.5 EUT OPERATING CONDITIONS.....	16
4.2.6 TEST RESULTS	17
5.RADIATED BAND EMISSIONMEASUREMENT	28
5.1 TEST REQUIREMENT:.....	28
5.2 TEST PROCEDURE	28
5.3 DEVIATION FROM TEST STANDARD	28
5.4 TEST SETUP.....	29
5.5 EUT OPERATING CONDITIONS.....	29
5.6 TEST RESULT	30
6.POWER SPECTRAL DENSITY TEST	32
6.1 APPLIED PROCEDURES / LIMIT.....	32
6.2 TEST PROCEDURE	32
6.3 DEVIATION FROM STANDARD.....	32
6.4 TEST SETUP	32
6.5 EUT OPERATION CONDITIONS.....	32

6.6 TEST RESULT	33
7. CHANNEL BANDWIDTH& 99% OCCUPY BANDWIDTH	41
7.1 APPLIED PROCEDURES / LIMIT.....	41
7.2 TEST PROCEDURE	41
7.3 DEVIATION FROM STANDARD.....	41
7.4 TEST SETUP	41
7.5 EUT OPERATION CONDITIONS.....	41
7.6 TEST RESULT	42
8.PEAK OUTPUT POWER TEST	45
8.1 APPLIED PROCEDURES/LIMIT.....	45
8.2 TEST PROCEDURE	45
8.3 DEVIATION FROM STANDARD.....	45
8.4 TEST SETUP	45
8.5 EUT OPERATION CONDITIONS.....	45
8.6 TEST RESULT	46
9. CONDUCTED BAND EDGE AND SPURIOUS EMISSION	47
9.1 APPLICABLE STANDARD.....	47
9.2 TEST PROCEDURE	47
9.3 DEVIATION FROM STANDARD.....	47
9.4 TEST SETUP	47
9.5 EUT OPERATION CONDITIONS.....	47
9.6 TEST RESULTS	47
10.ANTENNA REQUIREMENT.....	54
11. TEST SETUP PHOTO	55
12. EUT CONSTRUCTIONAL DETAILS.....	55

1. VERSION

Report No.	Version	Description	Approved
ZKT-210427L1534E	Rev.01	Initial issue of report	May. 10, 2021

2. SUMMARY OF TEST RESULTS

Test procedures according to the technical standards:

FCC Part15 (15.247) , Subpart C			
Standard Section	Test Item	Result	Remark
FCC part 15.203/15.247 (c)	Antenna requirement	PASS	
FCC part 15.207	AC Power Line Conducted Emission	PASS	
FCC part 15.247 (b)(3)	Conducted Peak Output Power	PASS	
FCC part 15.247 (a)(2)	Channel Bandwidth& 99% OCB	PASS	
FCC part 15.247 (e)	Power Spectral Density	PASS	
FCC part 15.247(d)	Band Edge	PASS	
FCC part 15.205/15.209	Spurious Emission	PASS	

NOTE:

(1)" N/A" denotes test is not applicable in this Test Report

2.1 TEST FACILITY

Shenzhen ZKT Technology Co., Ltd.

Add. : 1/F, No. 101, Building B, No. 6, Tangwei Community Industrial Avenue, Fuhai Street, Bao'an District, Shenzhen, China

FCC Test Firm Registration Number: 692225

Designation Number: CN1299

IC Registered No.: 27033

2.2 MEASUREMENT UNCERTAINTY

The reported uncertainty of measurement $y \pm U$ · where expanded uncertainty U is based on a standard uncertainty multiplied by a coverage factor of $k=2$ · providing a level of confidence of approximately 95 % ·

No.	Item	Uncertainty
1	Conducted Emission Test	$\pm 1.38\text{dB}$
2	RF power conducted	$\pm 0.16\text{dB}$
3	Spurious emissions conducted	$\pm 0.21\text{dB}$
4	All emissions radiated(<1G)	$\pm 4.68\text{dB}$
5	All emissions radiated(>1G)	$\pm 4.89\text{dB}$
6	Temperature	$\pm 0.5^\circ\text{C}$
7	Humidity	$\pm 2\%$

3. GENERAL INFORMATION

3.1 GENERAL DESCRIPTION OF EUT

Product Name:	IP Camera with Battery
Model No.:	S02 S01, S02J, S03, S06, N01, N02, N03, M01, M02, Q01, Q02
Model Different.:	The product's different for model number and appearance color.
Serial No.:	N/A
Hardware Version:	H1.0
Software Version:	S1.0
Sample(s) Status:	Engineer sample
Channel numbers:	802.11b/802.11g /802.11n(HT20):11 802.11n(HT40):7
Channel separation:	5MHz
Modulation technology:	802.11b: Direct Sequence Spread Spectrum(DSSS) 802.11g/802.11n(H20)/802.11n(HT40): Orthogonal Frequency Division Multiplexing(OFDM)
Antenna Type:	External antenna
Antenna gain:	3.5dBi
Power supply:	DC 3.7V from battery DC 5V from charger

Operation Frequency each of channel

Channel	Frequency	Chann el	Frequency	Chann el	Frequency	Chann el	Frequency
1	2412MHz	4	2427MHz	7	2442MHz	10	2457MHz
2	2417MHz	5	2432MHz	8	2447MHz	11	2462MHz
3	2422MHz	6	2437MHz	9	2452MHz	X	

Note:

In section 15.31(m), regards to the operating frequency range over 10 MHz, the Lowest frequency, the middle frequency, and the highest frequency of channel were selected to perform the test, and the selected channel see below:

Test channel	Frequency (MHz)	
	802.11b/802.11g/802.11n(HT20)	802.11n(HT40)
Lowest channel	2412MHz	2422MHz
Middle channel	2437MHz	2437MHz
Highest channel	2462MHz	2452MHz

3.2 DESCRIPTION OF TEST MODES

Transmitting mode	Keep the EUT in continuously transmitting mode
Remark: During the test, the duty cycle >98%, the test voltage was tuned from 85% to 115% of the nominal rated supply voltage, and found that the worst case was under the nominal rated supply condition. So the report just shows that condition's data.	

We have verified the construction and function in typical operation. All the test modes were carried out with the EUT in transmitting operation, which was shown in this test report and defined as follows:				
Pre-scan all kind of data rate in lowest channel, and found the follow list which it was worst case.				
Mode	802.11b	802.11g	802.11n(HT20)	802.11n(HT40)
Data rate	1Mbps	6Mbps	6.5Mbps	13Mbps

Test Software	Realtek Test Tool
Power level setup	<8dBm

3.3 BLOCK DIGRAM SHOWING THE CONFIGURATION OF SYSTEM TESTED

Conducted Emission

EUT

Radiated Emission

EUT

Conducted Spurious

EUT

3.4 DESCRIPTION OF SUPPORT UNITS(CONDUCTED MODE)

The EUT has been tested as an independent unit together with other necessary accessories or support units. The following support units or accessories were used to form a representative test configuration during the tests.

Item	Equipment	Mfr/Brand	Model/Type No.	Series No.	Note
E-1	IP Camera with Battery	N/A	S02	N/A	EUT

Item	Shielded Type	Ferrite Core	Length	Note

Note:

- (1) The support equipment was authorized by Declaration of Confirmation.
- (2) For detachable type I/O cable should be specified the length in cm in 『Length』 column.

3.5EQUIPMENTS LIST FOR ALL TEST ITEMS
Radiation Test equipment

Item	Equipment	Manufacturer	Type No.	Serial No.	Last calibration	Calibrated until
1	Spectrum Analyzer (9kHz-26.5GHz)	KEYSIGHT	9020A	MY45109572	Sep. 22, 2020	Sep. 21, 2021
2	Spectrum Analyzer (1GHz-40GHz)	Agilent	E4446A	100363	Sep. 22, 2020	Sep. 21, 2021
3	Test Receiver (9kHz-7GHz)	R&S	ESC17	101169	Sep. 22, 2020	Sep. 21, 2021
4	Bilog Antenna (30MHz-1400MHz)	Schwarzbeck	VULB9168	00877	Sep. 22, 2020	Sep. 21, 2021
5	Horn Antenna (1GHz-18GHz)	SCHWARZBEC K	BBHA9120D	1541	Sep. 22, 2020	Sep. 21, 2021
6	Horn Antenna (18GHz-40GHz)	A.H. System	SAS-574	588	Sep. 22, 2020	Sep. 21, 2021
7	Amplifier (30-1000MHz)	EM Electronics	EM330 Amplifier	N/A	Sep. 22, 2020	Sep. 21, 2021
8	Amplifier (1GHz-40GHz)	全聚达	DLE-161	097	Sep. 22, 2020	Sep. 21, 2021
9	Loop Antenna (9kHz-30MHz)	SCHWARZBEC K	FMZB1519B	014	Sep. 22, 2020	Sep. 21, 2021
10	RF cables1 (9kHz-30MHz)	N/A	9kHz-30MHz	N/A	Sep. 22, 2020	Sep. 21, 2021
11	RF cables2 (30MHz-1GHz)	N/A	30MHz-1GHz	N/A	Sep. 22, 2020	Sep. 21, 2021
12	RF cables3 (1GHz-40GHz)	N/A	1GHz-40GHz	N/A	Sep. 22, 2020	Sep. 21, 2021
13	CMW500 Test	R&S	CMW500	106504	Sep. 22, 2020	Sep. 21, 2021
14	ESG Signal Generator	Agilent	E4421B	GB40051203	Sep. 22, 2020	Sep. 21, 2021
15	Signal Generator	Agilent	N5182A	MY47420215	Sep. 22, 2020	Sep. 21, 2021
16	Power meter	Yokogama	WT210	91MB28517	Sep. 22, 2020	Sep. 21, 2021
17	D.C. Power Supply	LongWei	TPR-6405D	\	\	\
18	Software	Frad	EZ-EMC	FA-03A2 RE	\	\

Conduction Test equipment

Item	Kind of Equipment	Manufacturer	Type No.	Serial No.	Last calibration	Calibrated until
1	LISN	R&S	ENV216	101471	Sep. 22, 2020	Sep. 21, 2021
2	LISN	CYBERTEK	EM5040A	E185040014 9	Sep. 22, 2020	Sep. 21, 2021
3	Test Cable	N/A	C01	N/A	Sep. 22, 2020	Sep. 21, 2021
4	Test Cable	N/A	C02	N/A	Sep. 22, 2020	Sep. 21, 2021
5	EMI Test Receiver	R&S	ESRP3	101946	Sep. 22, 2020	Sep. 21, 2021
6	Absorbing Clamp	DZ	ZN23201	N/A	Sep. 22, 2020	Sep. 21, 2021

4. EMC EMISSION TEST

4.1 CONDUCTED EMISSION MEASUREMENT

Test Requirement:	FCC Part15 C Section 15.207
Test Method:	ANSI C63.10:2013
Test Frequency Range:	150KHz to 30MHz
Receiver setup:	RBW=9KHz, VBW=30KHz, Sweep time=auto

4.1.1 POWER LINE CONDUCTED EMISSION Limits

FREQUENCY (MHz)	Limit (dBuV)		Standard
	Quasi-peak	Average	
0.15 -0.5	66 - 56 *	56 - 46 *	FCC
0.50 -5.0	56.00	46.00	FCC
5.0 -30.0	60.00	50.00	FCC

Note:

(1) *Decreases with the logarithm of the frequency.

4.1.2 TEST PROCEDURE

- The EUT was placed 0.1 meters from the horizontal ground plane with EUT being connected to the power mains through a line impedance stabilization network (LISN). All other support equipments powered from additional LISN(s). The LISN provide 50 Ohm/ 50uH of coupling impedance for the measuring instrument.
- Interconnecting cables that hang closer than 40 cm to the ground plane shall be folded back and forth in the center forming a bundle 30 to 40 cm long.
- I/O cables that are not connected to a peripheral shall be bundled in the center. The end of the cable may be terminated, if required, using the correct terminating impedance. The overall length shall not exceed 1 m.
- LISN at least 80 cm from nearest part of EUT chassis.
- For the actual test configuration, please refer to the related Item –EUT Test Photos.

4.1.3 DEVIATION FROM TEST STANDARD

No deviation

4.1.4 TEST SETUP

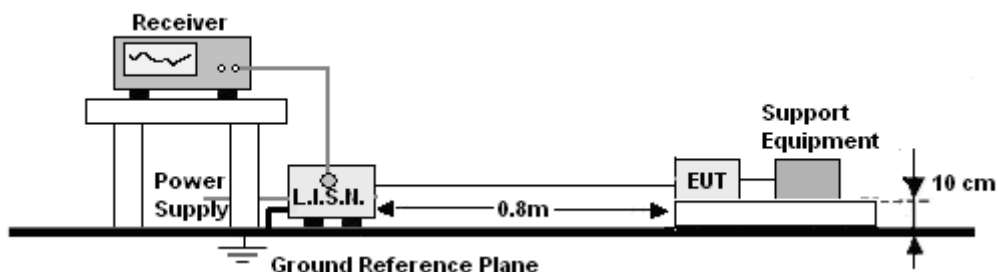

4.1.5 EUT OPERATING CONDITIONS

The EUT was configured for testing in a typical fashion (as a customer would normally use it). The EUT has been programmed to continuously transmit during test. This operating condition was tested and used to collect the included data.

Both high and low voltages have been tested to show only the worst low voltages test data.

4.1.6 TEST RESULT

Temperature :	26 °C	Relative Humidity :	54%
Pressure :	101kPa	Phase :	L
Test Voltage :	AC 120V/60Hz	Test Mode :	Mode 1

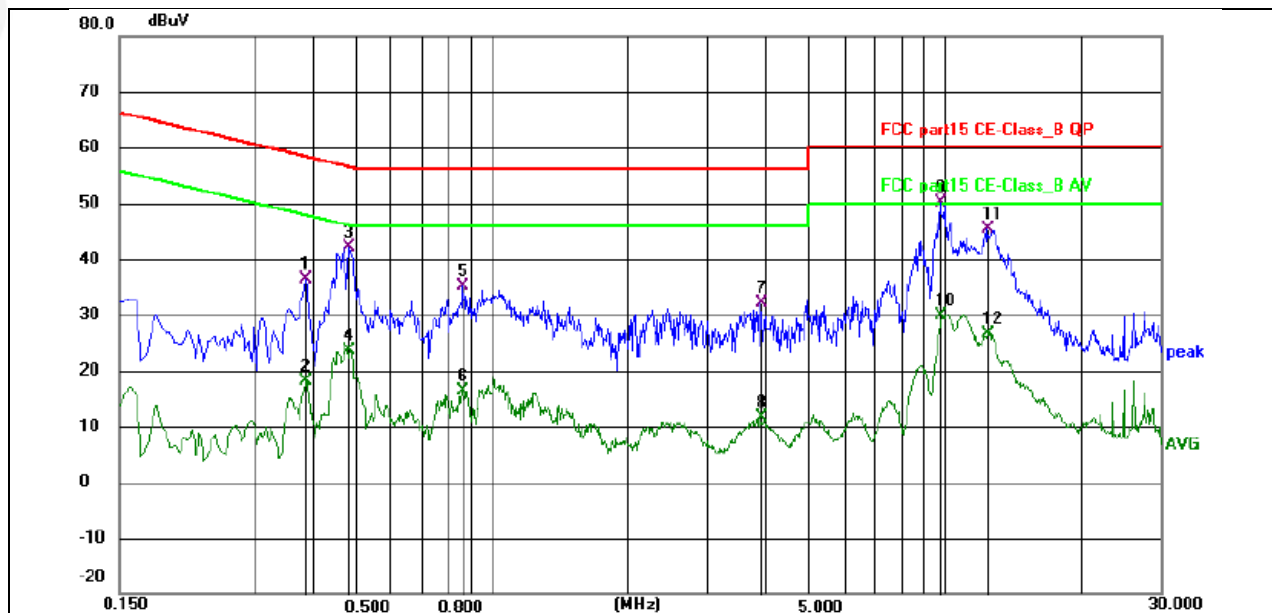

Remark:

1. All readings are Quasi-Peak and Average values.
2. Factor = Insertion Loss + Cable Loss.

No.	Frequency (MHz)	Reading (dBuV)	Factor (dB)	Level (dBuV)	Limit (dBuV)	Margin (dB)	Detector	P/F	Remark
1	0.3885	27.14	9.29	36.43	58.10	21.67	QP	P	
2	0.3885	8.95	9.29	18.24	48.10	29.86	AVG	P	
3	0.4830	32.76	9.34	42.10	56.29	14.19	QP	P	
4	0.4830	14.37	9.34	23.71	46.29	22.58	AVG	P	
5	0.8609	25.57	9.50	35.07	56.00	20.93	QP	P	
6	0.8609	6.82	9.50	16.32	46.00	29.68	AVG	P	
7	3.9120	22.38	9.67	32.05	56.00	23.95	QP	P	
8	3.9120	1.84	9.67	11.51	46.00	34.49	AVG	P	
9 *	9.8025	40.09	9.99	50.08	60.00	9.92	QP	P	
10	9.8025	19.91	9.99	29.90	50.00	20.10	AVG	P	
11	12.4170	35.22	10.10	45.32	60.00	14.68	QP	P	
12	12.4170	16.44	10.10	26.54	50.00	23.46	AVG	P	

Temperature :	26 °C	Relative Humidity :	54%
Pressure :	101kPa	Phase :	N
Test Voltage :	AC 120V/60Hz	Test Mode :	Mode 1

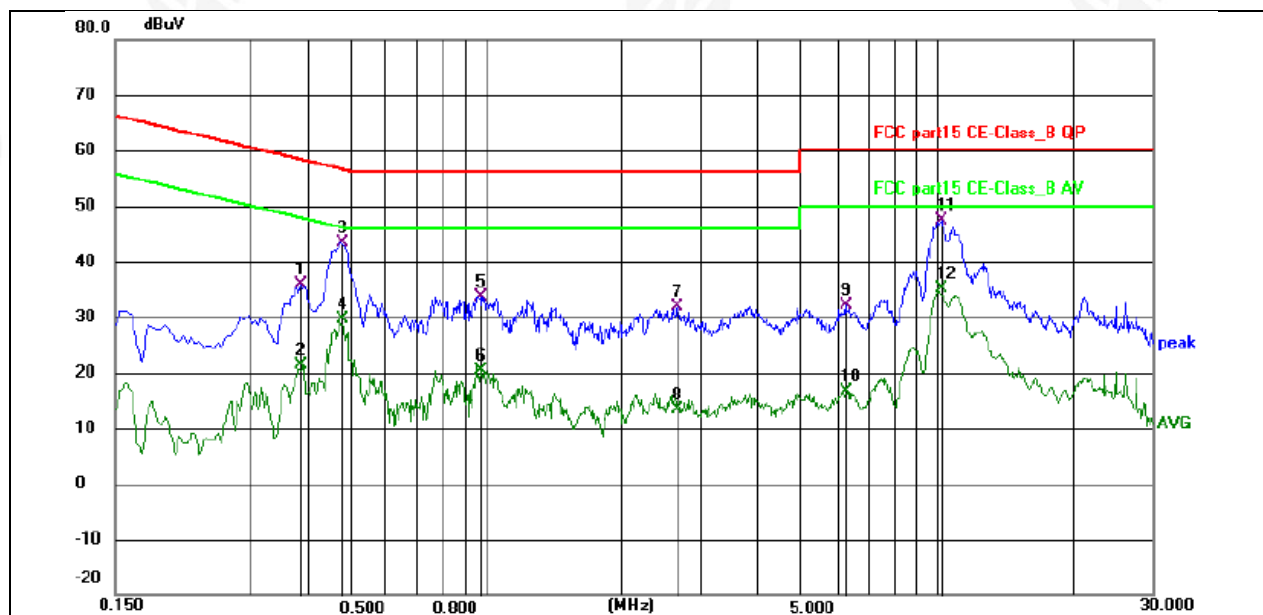

Remark:

1. All readings are Quasi-Peak and Average values.
2. Factor = Insertion Loss + Cable Loss.

No.	Frequency (MHz)	Reading (dBuV)	Factor (dB)	Level (dBuV)	Limit (dBuV)	Margin (dB)	Detector	P/F	Remark
1	0.3885	26.51	9.39	35.90	58.10	22.20	QP	P	
2	0.3885	11.92	9.39	21.31	48.10	26.79	AVG	P	
3	0.4785	33.90	9.52	43.42	56.37	12.95	QP	P	
4	0.4785	20.14	9.52	29.66	46.37	16.71	AVG	P	
5	0.9689	24.15	9.55	33.70	56.00	22.30	QP	P	
6	0.9689	10.83	9.55	20.38	46.00	25.62	AVG	P	
7	2.6610	21.96	9.98	31.94	56.00	24.06	QP	P	
8	2.6610	3.49	9.98	13.47	46.00	32.53	AVG	P	
9	6.2745	22.26	9.97	32.23	60.00	27.77	QP	P	
10	6.2745	6.56	9.97	16.53	50.00	33.47	AVG	P	
11 *	10.2120	37.19	10.20	47.39	60.00	12.61	QP	P	
12	10.2120	24.86	10.20	35.06	50.00	14.94	AVG	P	

4.2 RADIATED EMISSION MEASUREMENT

Test Requirement:	FCC Part15 C Section 15.209				
Test Method:	ANSI C63.10:2013				
Test Frequency Range:	9kHz to 25GHz				
Test site:	Measurement Distance: 3m				
Receiver setup:	Frequency	Detector	RBW	VBW	Value
	9KHz-150KHz	Quasi-peak	200Hz	600Hz	Quasi-peak
	150KHz-30MHz	Quasi-peak	9KHz	30KHz	Quasi-peak
	30MHz-1GHz	Quasi-peak	100KHz	300KHz	Quasi-peak
	Above 1GHz	Peak	1MHz	3MHz	Peak
Peak		1MHz	10Hz	Average	

4.2.1 RADIATED EMISSION LIMITS

Frequencies (MHz)	Field Strength (micorvolts/meter)	Measurement Distance (meters)
0.009~0.490	2400/F(KHz)	300
0.490~1.705	24000/F(KHz)	30
1.705~30.0	30	30
30~88	100	3
88~216	150	3
216~960	200	3
Above 960	500	3

LIMITS OF RADIATED EMISSION MEASUREMENT

FREQUENCY (MHz)	Limit (dBuV/m) (at 3M)	
	PEAK	AVERAGE
Above 1000	74	54

Notes:

- (1) The limit for radiated test was performed according to FCC PART 15C.
- (2) The tighter limit applies at the band edges.
- (3) Emission level (dBuV/m)=20log Emission level (uV/m).

4.2.2 TEST PROCEDURE

Below 1GHz test procedure as below:

- a. The EUT was placed on the top of a rotating table 0.1 meters above the ground at a 3 meter semi-anechoiccamber. The table was rotated 360 degrees to determine the position of the highest radiation.
- b. The EUT was set 3 meters away from the interference-receiving antenna, which was mounted on the top of variable-height antenna tower.

- c. The antenna height is varied from one meter to four meters above the ground to determine the maximum value of the field strength. Both horizontal and vertical polarizations of the antenna are set to make the measurement.
- d. For each suspected emission, the EUT was arranged to its worst case and then the antenna was tuned to heights from 1 meter to 4 meters (for the test frequency of below 30MHz, the antenna was tuned to heights 1 meter) and the rotatable table was turned from 0 degrees to 360 degrees to find the maximum reading.
- e. The test-receiver system was set to Peak Detect Function and Specified Bandwidth with Maximum Hold Mode.
- f. If the emission level of the EUT in peak mode was 10dB lower than the limit specified, then testing could be stopped and the peak values of the EUT would be reported. Otherwise the emissions that did not have 10dB margin would be re-tested one by one using peak, quasi-peak or average method as specified and then reported in a data sheet.

Above 1GHz test procedure as below:

- g. Different between above is the test site, change from Semi- Anechoic Chamber to fully Anechoic Chamber and change from table 0.8 metre to 1.5 metre (Above 18GHz the distance is 1 meter and table is 1.5 metre).
- h. Test the EUT in the lowest channel, the middle channel, the Highest channel

Note:

Both horizontal and vertical antenna polarities were tested and performed pretest to three orthogonal axis. The worst case emissions were reported

4.2.3 DEVIATION FROM TEST STANDARD

No deviation

4.2.4 TEST SETUP

(A) Radiated Emission Test-Up Frequency Below 30MHz

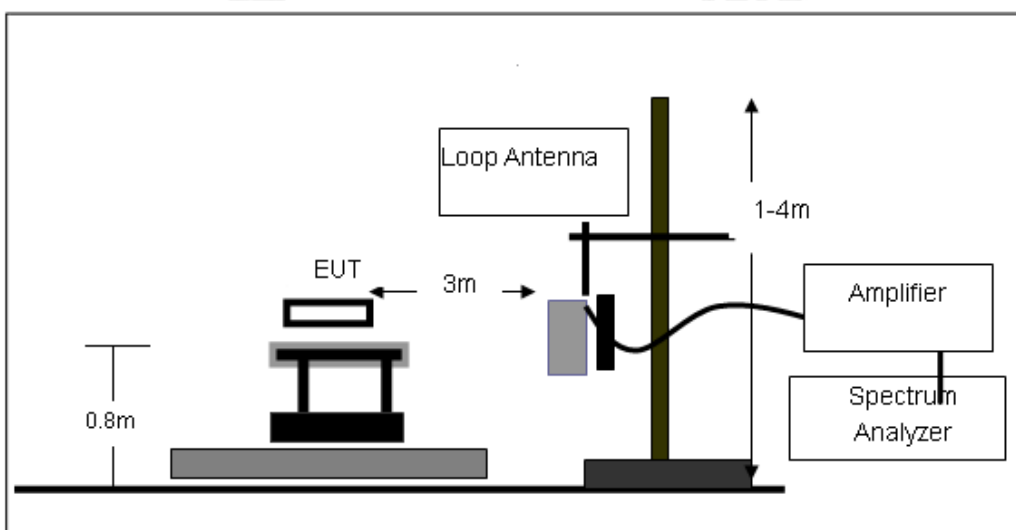

(B) Radiated Emission Test-Up Frequency 30MHz~1GHz

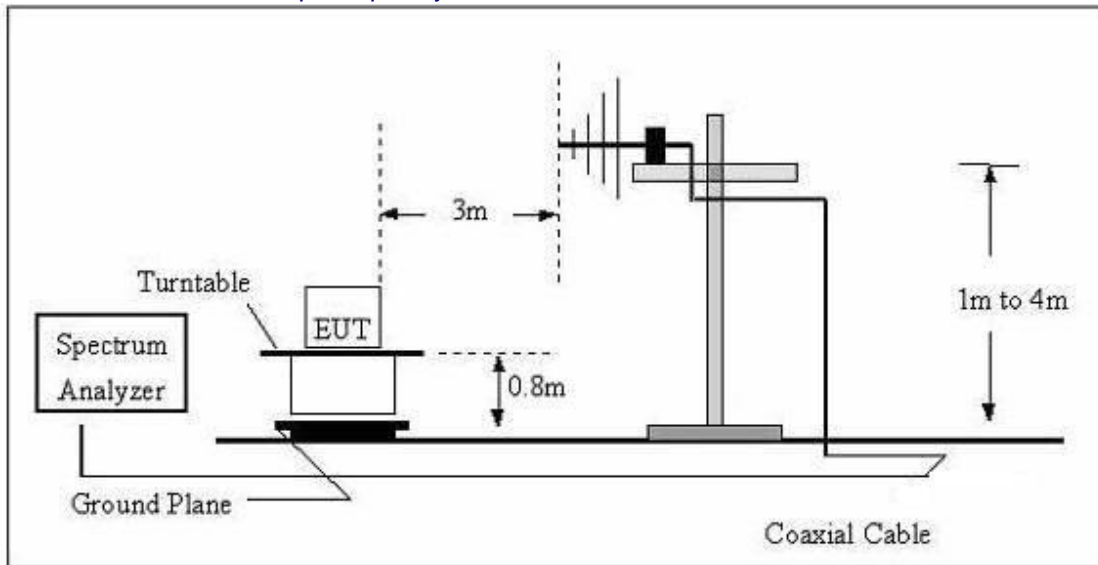

(C) Radiated Emission Test-Up Frequency Above 1GHz

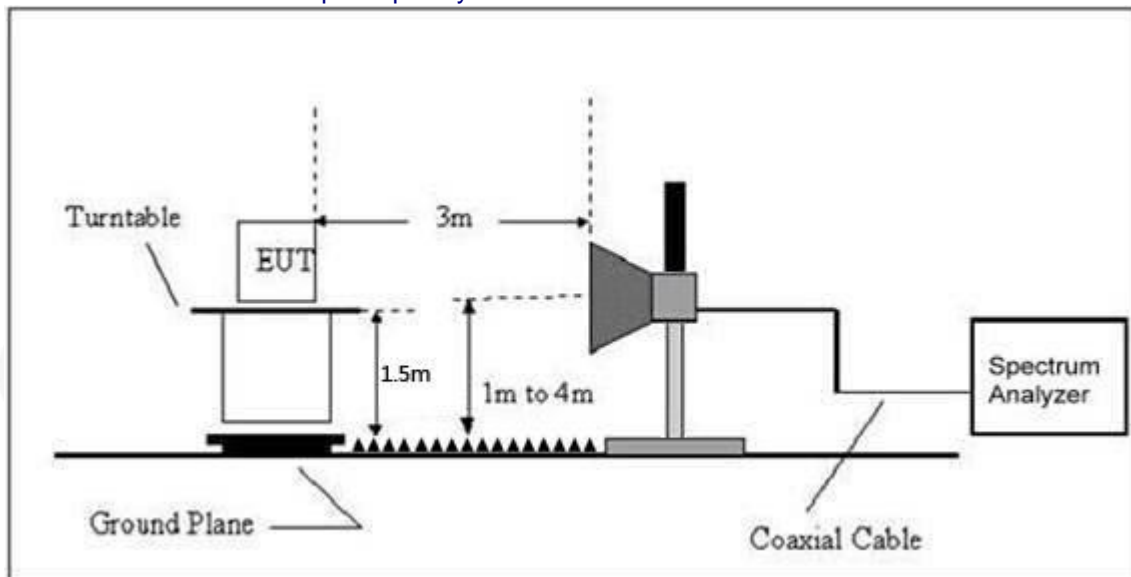

4.2.5 EUT OPERATING CONDITIONS

The EUT tested system was configured as the statements of 2.4 Unless otherwise a special operating condition is specified in the follows during the testing.
Both high and low voltages have been tested to show only the worst low voltages test data.

4.2.6 TEST RESULTS

Between 9KHz – 30MHz

The emission from 9 kHz to 30MHz was pre-tested and found the result was 20dB lower than the limit, and according to 15.31(o) & RSS-Gen 6.13, the test result no need to reported.

Between 30MHz – 1GHz

Temperature:	26°C	Relative Humidity:	54%
Pressure:	101 kPa	Polarization:	Horizontal
Test Voltage:	AC 120V/60Hz		

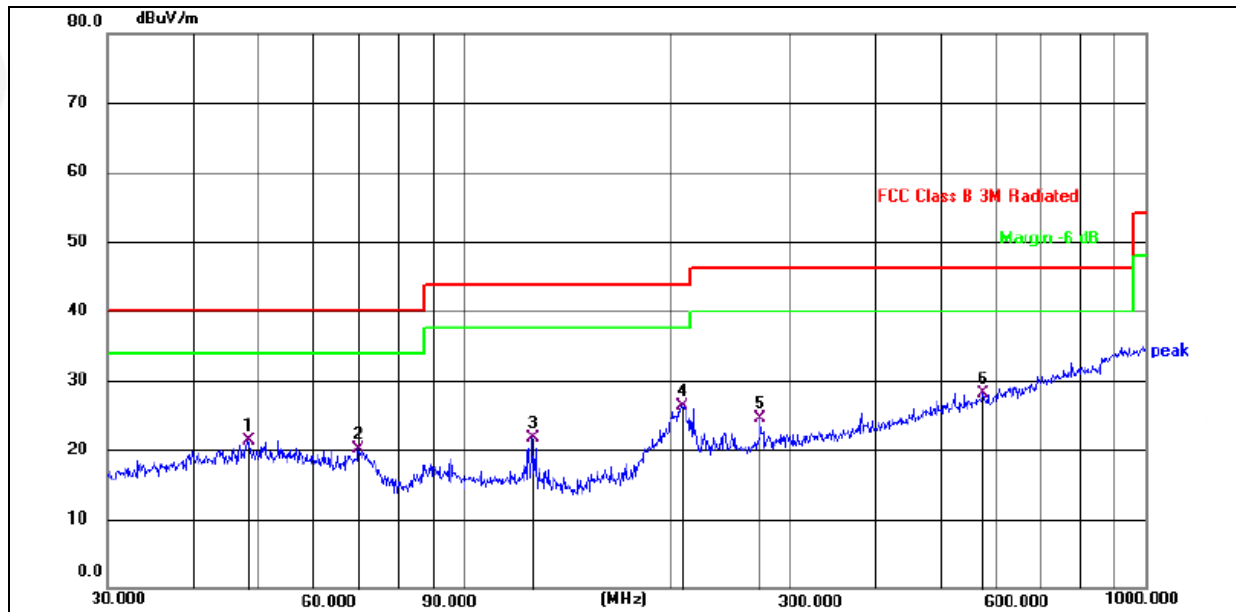

No.	Mk.	Freq. MHz	Reading Level dBuV	Correct Factor dB	Measure- ment dBuV/m	Limit dB/m	Over dB	Detector
1		48.1626	34.83	-13.48	21.35	40.00	18.65	QP
2		69.8450	37.34	-17.21	20.13	40.00	19.87	QP
3		125.8864	39.95	-18.21	21.74	43.50	21.76	QP
4	*	208.5803	41.93	-15.63	26.30	43.50	17.20	QP
5		272.2776	37.78	-13.29	24.49	46.00	21.51	QP
6		576.6443	35.07	-7.05	28.02	46.00	17.98	QP

Temperature:	26°C	Relative Humidity:	54%
Pressure:	101kPa	Polarization:	Vertical
Test Voltage:	AC 120V/60Hz		

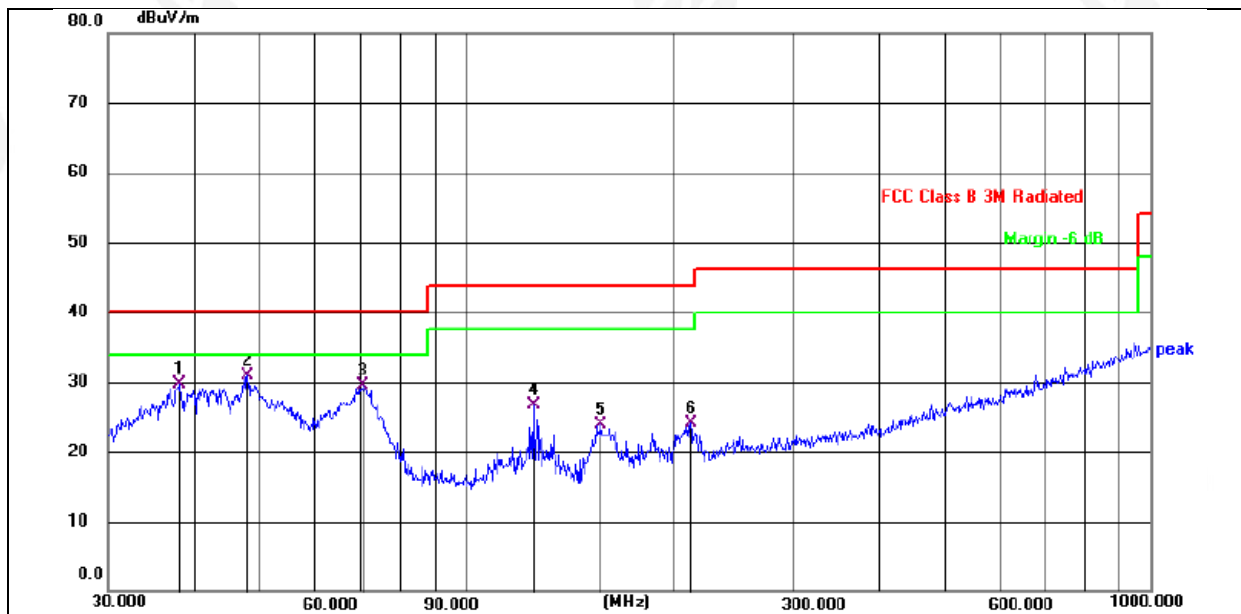

No.	Mk.	Freq. MHz	Reading Level dBuV	Correct Factor dB	Measure- ment dBuV/m	Limit dB/m	Over dB	Detector
1		38.0783	44.36	-14.63	29.73	40.00	10.27	QP
2	*	47.9940	44.32	-13.50	30.82	40.00	9.18	QP
3		70.5836	46.94	-17.39	29.55	40.00	10.45	QP
4		125.4457	44.98	-18.19	26.79	43.50	16.71	QP
5		157.5588	42.54	-18.70	23.84	43.50	19.66	QP
6		213.0151	39.47	-15.45	24.02	43.50	19.48	QP

Remarks:

1. Final Level = Receiver Read level + Antenna Factor + Cable Loss – Preamplifier Factor
2. The emission levels of other frequencies are very lower than the limit and not show in test report.
3. The test data shows only the worst case 802.11b mode

1GHz~25GHz

802.11b

Polar (H/V)	Frequency	Meter Reading	Pre-amplifier	Cable Loss	Antenna Factor	Emission Level	Limits	Margin	Detect or Type
	(MHz)	(dBuV)	(dB)	(dB)	(dB)	(dBuV/m)	(dBuV/m)	(dB)	
Low Channel:2412MHz									
V	4824.00	52.36	30.55	5.77	24.66	52.24	74.00	-21.76	PK
V	4824.00	42.24	30.55	5.77	24.66	42.12	54.00	-11.88	AV
V	7236.00	50.32	30.33	6.32	24.55	50.86	74.00	-23.14	PK
V	7236.00	43.24	30.33	6.32	24.55	43.78	54.00	-10.22	AV
V	9648.00	51.11	30.85	7.45	24.69	52.40	74.00	-21.60	PK
V	9648.00	42.32	30.85	7.45	24.69	43.61	54.00	-10.39	AV
V	12060.00	51.23	31.02	8.99	25.57	54.77	74.00	-19.23	PK
V	12060.00	42.45	31.02	8.99	25.57	45.99	54.00	-8.01	AV
H	4824.00	52.53	30.55	5.77	24.66	52.41	74.00	-21.59	PK
H	4824.00	42.12	30.55	5.77	24.66	42.00	54.00	-12.00	AV
H	7236.00	51.21	30.33	6.32	24.55	51.75	74.00	-22.25	PK
H	7236.00	42.38	30.33	6.32	24.55	42.92	54.00	-11.08	AV
H	9648.00	51.77	30.85	7.45	24.69	53.06	74.00	-20.94	PK
H	9648.00	42.56	30.85	7.45	24.69	43.85	54.00	-10.15	AV
H	12060.00	51.35	31.02	8.99	25.57	54.89	74.00	-19.11	PK
H	12060.00	41.23	31.02	8.99	25.57	44.77	54.00	-9.23	AV

Polar (H/V)	Frequency	Meter Reading	Pre-amplifier	Cable Loss	Antenna Factor	Emission Level	Limits	Margin	Detect or Type
	(MHz)	(dBuV)	(dB)	(dB)	(dB)	(dBuV/m)	(dBuV/m)	(dB)	
Middle Channel:2437MHz									
V	4874.00	51.33	30.55	5.77	24.66	51.21	74.00	-22.79	PK
V	4874.00	42.22	30.55	5.77	24.66	42.10	54.00	-11.90	AV
V	7311.00	50.43	30.33	6.32	24.55	50.97	74.00	-23.03	PK
V	7311.00	42.35	30.33	6.32	24.55	42.89	54.00	-11.11	AV
V	9748.00	50.54	30.85	7.45	24.69	51.83	74.00	-22.17	PK
V	9748.00	42.42	30.85	7.45	24.69	43.71	54.00	-10.29	AV
V	12185.00	50.32	31.02	8.99	25.57	53.86	74.00	-20.14	PK
V	12185.00	42.44	31.02	8.99	25.57	45.98	54.00	-8.02	AV
H	4874.00	52.17	30.55	5.77	24.66	52.05	74.00	-21.95	PK
H	4874.00	42.36	30.55	5.77	24.66	42.24	54.00	-11.76	AV
H	7311.00	53.48	30.33	6.32	24.55	54.02	74.00	-19.98	PK
H	7311.00	42.55	30.33	6.32	24.55	43.09	54.00	-10.91	AV
H	9748.00	53.36	30.85	7.45	24.69	54.65	74.00	-19.35	PK
H	9748.00	42.23	30.85	7.45	24.69	43.52	54.00	-10.48	AV
H	12185.00	54.41	31.02	8.99	25.57	57.95	74.00	-16.05	PK
H	12185.00	42.14	31.02	8.99	25.57	45.68	54.00	-8.32	AV

Polar (H/V)	Frequency	Meter Reading	Pre-ampli fier	Cable Loss	Antenna Factor	Emission Level	Limits	Margin	Detect or Type
	(MHz)	(dBuV)	(dB)	(dB)	(dB)	(dBuV/m)	(dBuV/ m)	(dB)	
High Channel:2462MHz									
V	4924.00	51.23	30.55	5.77	24.66	51.11	74.00	-22.89	PK
V	4924.00	42.35	30.55	5.77	24.66	42.23	54.00	-11.77	AV
V	7386.00	53.21	30.33	6.32	24.55	53.75	74.00	-20.25	PK
V	7386.00	43.13	30.33	6.32	24.55	43.67	54.00	-10.33	AV
V	9848.00	53.46	30.85	7.45	24.69	54.75	74.00	-19.25	PK
V	9848.00	43.37	30.85	7.45	24.69	44.66	54.00	-9.34	AV
V	12310.00	53.18	31.02	8.99	25.57	56.72	74.00	-17.28	PK
V	12310.00	42.76	31.02	8.99	25.57	46.30	54.00	-7.70	AV
H	4924.00	51.35	30.55	5.77	24.66	51.23	74.00	-22.77	PK
H	4924.00	42.12	30.55	5.77	24.66	42.00	54.00	-12.00	AV
H	7386.00	52.43	30.33	6.32	24.55	52.97	74.00	-21.03	PK
H	7386.00	43.38	30.33	6.32	24.55	43.92	54.00	-10.08	AV
H	9848.00	53.16	30.85	7.45	24.69	54.45	74.00	-19.55	PK
H	9848.00	43.25	30.85	7.45	24.69	44.54	54.00	-9.46	AV
H	12310.00	53.53	31.02	8.99	25.57	57.07	74.00	-16.93	PK
H	12310.00	43.25	31.02	8.99	25.57	46.79	54.00	-7.21	AV

Remark:

1. Emission Level = Meter Reading + Antenna Factor + Cable Loss – Pre-amplifier,

Margin= Emission Level - Limit

2. If peak below the average limit, the average emission was no test.

3. The amplitude of spurious emissions which are attenuated by more than 20dB below the permissible value has no need to be reported.

802.11g

Polar (H/V)	Frequency	Meter Reading	Pre-amplifier	Cable Loss	Antenna Factor	Emission Level	Limits	Margin	Detect or Type
	(MHz)	(dBuV)	(dB)	(dB)	(dB)	(dBuV/m)	(dBuV/m)	(dB)	
Low Channel:2412MHz									
V	4824.00	52.43	30.55	5.77	24.66	52.31	74.00	-21.69	PK
V	4824.00	42.31	30.55	5.77	24.66	42.19	54.00	-11.81	AV
V	7236.00	50.24	30.33	6.32	24.55	50.78	74.00	-23.22	PK
V	7236.00	43.15	30.33	6.32	24.55	43.69	54.00	-10.31	AV
V	9648.00	50.56	30.85	7.45	24.69	51.85	74.00	-22.15	PK
V	9648.00	42.35	30.85	7.45	24.69	43.64	54.00	-10.36	AV
V	12060.00	50.13	31.02	8.99	25.57	53.67	74.00	-20.33	PK
V	12060.00	42.47	31.02	8.99	25.57	46.01	54.00	-7.99	AV
H	4824.00	52.55	30.55	5.77	24.66	52.43	74.00	-21.57	PK
H	4824.00	42.41	30.55	5.77	24.66	42.29	54.00	-11.71	AV
H	7236.00	51.63	30.33	6.32	24.55	52.17	74.00	-21.83	PK
H	7236.00	42.77	30.33	6.32	24.55	43.31	54.00	-10.69	AV
H	9648.00	51.32	30.85	7.45	24.69	52.61	74.00	-21.39	PK
H	9648.00	42.35	30.85	7.45	24.69	43.64	54.00	-10.36	AV
H	12060.00	51.34	31.02	8.99	25.57	54.88	74.00	-19.12	PK
H	12060.00	41.61	31.02	8.99	25.57	45.15	54.00	-8.85	AV

Polar (H/V)	Frequency	Meter Reading	Pre-amplifier	Cable Loss	Antenna Factor	Emission Level	Limits	Margin	Detect or Type
	(MHz)	(dBuV)	(dB)	(dB)	(dB)	(dBuV/m)	(dBuV/m)	(dB)	
Middle Channel:2437MHz									
V	4874.00	51.24	30.55	5.77	24.66	51.12	74.00	-22.88	PK
V	4874.00	42.33	30.55	5.77	24.66	42.21	54.00	-11.79	AV
V	7311.00	50.32	30.33	6.32	24.55	50.86	74.00	-23.14	PK
V	7311.00	42.51	30.33	6.32	24.55	43.05	54.00	-10.95	AV
V	9748.00	50.63	30.85	7.45	24.69	51.92	74.00	-22.08	PK
V	9748.00	42.14	30.85	7.45	24.69	43.43	54.00	-10.57	AV
V	12185.00	50.33	31.02	8.99	25.57	53.87	74.00	-20.13	PK
V	12185.00	42.52	31.02	8.99	25.57	46.06	54.00	-7.94	AV
H	4874.00	52.63	30.55	5.77	24.66	52.51	74.00	-21.49	PK
H	4874.00	42.44	30.55	5.77	24.66	42.32	54.00	-11.68	AV
H	7311.00	53.34	30.33	6.32	24.55	53.88	74.00	-20.12	PK
H	7311.00	42.32	30.33	6.32	24.55	42.86	54.00	-11.14	AV
H	9748.00	53.33	30.85	7.45	24.69	54.62	74.00	-19.38	PK
H	9748.00	42.25	30.85	7.45	24.69	43.54	54.00	-10.46	AV
H	12185.00	54.53	31.02	8.99	25.57	58.07	74.00	-15.93	PK
H	12185.00	42.41	31.02	8.99	25.57	45.95	54.00	-8.05	AV

Polar (H/V)	Frequency	Meter Reading	Pre-amplifier	Cable Loss	Antenna Factor	Emission Level	Limits	Margin	Detect or Type
	(MHz)	(dBuV)	(dB)	(dB)	(dB)	(dBuV/m)	(dBuV/m)	(dB)	
High Channel:2462MHz									
V	4924.00	51.24	30.55	5.77	24.66	51.12	74.00	-22.88	PK
V	4924.00	42.35	30.55	5.77	24.66	42.23	54.00	-11.77	AV
V	7386.00	53.12	30.33	6.32	24.55	53.66	74.00	-20.34	PK
V	7386.00	43.53	30.33	6.32	24.55	44.07	54.00	-9.93	AV
V	9848.00	53.55	30.85	7.45	24.69	54.84	74.00	-19.16	PK
V	9848.00	43.11	30.85	7.45	24.69	44.40	54.00	-9.60	AV
V	12310.00	53.74	31.02	8.99	25.57	57.28	74.00	-16.72	PK
V	12310.00	42.56	31.02	8.99	25.57	46.10	54.00	-7.90	AV
H	4924.00	51.33	30.55	5.77	24.66	51.21	74.00	-22.79	PK
H	4924.00	42.51	30.55	5.77	24.66	42.39	54.00	-11.61	AV
H	7386.00	52.65	30.33	6.32	24.55	53.19	74.00	-20.81	PK
H	7386.00	43.43	30.33	6.32	24.55	43.97	54.00	-10.03	AV
H	9848.00	53.25	30.85	7.45	24.69	54.54	74.00	-19.46	PK
H	9848.00	43.16	30.85	7.45	24.69	44.45	54.00	-9.55	AV
H	12310.00	53.24	31.02	8.99	25.57	56.78	74.00	-17.22	PK
H	12310.00	43.33	31.02	8.99	25.57	46.87	54.00	-7.13	AV

Remark:

1. Emission Level = Meter Reading + Antenna Factor + Cable Loss – Pre-amplifier,

Margin= Emission Level - Limit

2. If peak below the average limit, the average emission was no test.

3. The amplitude of spurious emissions which are attenuated by more than 20dB below the permissible value has no need to be reported.

802.11n20

Polar (H/V)	Frequency	Meter Reading	Pre-amplifier	Cable Loss	Antenna Factor	Emission Level	Limits	Margin	Detect or Type
	(MHz)	(dBuV)	(dB)	(dB)	(dB)	(dBuV/m)	(dBuV/m)	(dB)	
Low Channel:2412MHz									
V	4824.00	52.31	30.55	5.77	24.66	52.19	74.00	-21.81	PK
V	4824.00	42.45	30.55	5.77	24.66	42.33	54.00	-11.67	AV
V	7236.00	49.23	30.33	6.32	24.55	49.77	74.00	-24.23	PK
V	7236.00	43.31	30.33	6.32	24.55	43.85	54.00	-10.15	AV
V	9648.00	50.42	30.85	7.45	24.69	51.71	74.00	-22.29	PK
V	9648.00	42.44	30.85	7.45	24.69	43.73	54.00	-10.27	AV
V	12060.00	50.85	31.02	8.99	25.57	54.39	74.00	-19.61	PK
V	12060.00	42.23	31.02	8.99	25.57	45.77	54.00	-8.23	AV
H	4824.00	52.24	30.55	5.77	24.66	52.12	74.00	-21.88	PK
H	4824.00	42.33	30.55	5.77	24.66	42.21	54.00	-11.79	AV
H	7236.00	51.31	30.33	6.32	24.55	51.85	74.00	-22.15	PK
H	7236.00	42.43	30.33	6.32	24.55	42.97	54.00	-11.03	AV
H	9648.00	51.25	30.85	7.45	24.69	52.54	74.00	-21.46	PK
H	9648.00	42.23	30.85	7.45	24.69	43.52	54.00	-10.48	AV
H	12060.00	51.15	31.02	8.99	25.57	54.69	74.00	-19.31	PK
H	12060.00	41.25	31.02	8.99	25.57	44.79	54.00	-9.21	AV

Polar (H/V)	Frequency	Meter Reading	Pre-amplifier	Cable Loss	Antenna Factor	Emission Level	Limits	Margin	Detect or Type
	(MHz)	(dBuV)	(dB)	(dB)	(dB)	(dBuV/m)	(dBuV/m)	(dB)	
Middle Channel:2437MHz									
V	4874.00	51.23	30.55	5.77	24.66	51.11	74.00	-22.89	PK
V	4874.00	42.54	30.55	5.77	24.66	42.42	54.00	-11.58	AV
V	7311.00	49.35	30.33	6.32	24.55	49.89	74.00	-24.11	PK
V	7311.00	41.71	30.33	6.32	24.55	42.25	54.00	-11.75	AV
V	9748.00	50.35	30.85	7.45	24.69	51.64	74.00	-22.36	PK
V	9748.00	42.55	30.85	7.45	24.69	43.84	54.00	-10.16	AV
V	12185.00	50.34	31.02	8.99	25.57	53.88	74.00	-20.12	PK
V	12185.00	42.33	31.02	8.99	25.57	45.87	54.00	-8.13	AV
H	4874.00	52.14	30.55	5.77	24.66	52.02	74.00	-21.98	PK
H	4874.00	42.16	30.55	5.77	24.66	42.04	54.00	-11.96	AV
H	7311.00	53.37	30.33	6.32	24.55	53.91	74.00	-20.09	PK
H	7311.00	42.52	30.33	6.32	24.55	43.06	54.00	-10.94	AV
H	9748.00	53.36	30.85	7.45	24.69	54.65	74.00	-19.35	PK
H	9748.00	42.53	30.85	7.45	24.69	43.82	54.00	-10.18	AV
H	12185.00	54.24	31.02	8.99	25.57	57.78	74.00	-16.22	PK
H	12185.00	42.41	31.02	8.99	25.57	45.95	54.00	-8.05	AV

Polar (H/V)	Frequency	Meter Reading	Pre-ampl ifier	Cable Loss	Antenna Factor	Emission Level	Limits	Margin	Detect or Type
	(MHz)	(dBuV)	(dB)	(dB)	(dB)	(dBuV/m)	(dBuV/ m)	(dB)	
High Channel:2462MHz									
V	4924.00	51.51	30.55	5.77	24.66	51.39	74.00	-22.61	PK
V	4924.00	42.35	30.55	5.77	24.66	42.23	54.00	-11.77	AV
V	7386.00	53.53	30.33	6.32	24.55	54.07	74.00	-19.93	PK
V	7386.00	43.24	30.33	6.32	24.55	43.78	54.00	-10.22	AV
V	9848.00	53.24	30.85	7.45	24.69	54.53	74.00	-19.47	PK
V	9848.00	43.32	30.85	7.45	24.69	44.61	54.00	-9.39	AV
V	12310.00	53.15	31.02	8.99	25.57	56.69	74.00	-17.31	PK
V	12310.00	42.64	31.02	8.99	25.57	46.18	54.00	-7.82	AV
H	4924.00	51.26	30.55	5.77	24.66	51.14	74.00	-22.86	PK
H	4924.00	42.35	30.55	5.77	24.66	42.23	54.00	-11.77	AV
H	7386.00	52.41	30.33	6.32	24.55	52.95	74.00	-21.05	PK
H	7386.00	43.28	30.33	6.32	24.55	43.82	54.00	-10.18	AV
H	9848.00	53.44	30.85	7.45	24.69	54.73	74.00	-19.27	PK
H	9848.00	43.37	30.85	7.45	24.69	44.66	54.00	-9.34	AV
H	12310.00	53.35	31.02	8.99	25.57	56.89	74.00	-17.11	PK
H	12310.00	43.33	31.02	8.99	25.57	46.87	54.00	-7.13	AV

Remark:

1. Emission Level = Meter Reading + Antenna Factor + Cable Loss – Pre-amplifier,
Margin= Emission Level - Limit
2. If peak below the average limit, the average emission was no test.
3. The amplitude of spurious emissions which are attenuated by more than 20dB below the permissible value has no need to be reported.

802.11n40

Polar (H/V)	Frequency	Meter Reading	Pre-amplifier	Cable Loss	Antenna Factor	Emission Level	Limits	Margin	Detect or Type
	(MHz)	(dBuV)	(dB)	(dB)	(dB)	(dBuV/m)	(dBuV/m)	(dB)	
Low Channel:2422MHz									
V	4844.00	51.25	30.55	5.77	24.66	51.13	74.00	-22.87	PK
V	4844.00	42.41	30.55	5.77	24.66	42.29	54.00	-11.71	AV
V	7266.00	53.48	30.33	6.32	24.55	54.02	74.00	-19.98	PK
V	7266.00	43.26	30.33	6.32	24.55	43.80	54.00	-10.20	AV
V	9688.00	53.26	30.85	7.45	24.69	54.55	74.00	-19.45	PK
V	9688.00	43.33	30.85	7.45	24.69	44.62	54.00	-9.38	AV
V	12110.00	53.74	31.02	8.99	25.57	57.28	74.00	-16.72	PK
V	12110.00	42.34	31.02	8.99	25.57	45.88	54.00	-8.12	AV
H	4844.00	51.54	30.55	5.77	24.66	51.42	74.00	-22.58	PK
H	4844.00	42.31	30.55	5.77	24.66	42.19	54.00	-11.81	AV
H	7266.00	52.46	30.33	6.32	24.55	53.00	74.00	-21.00	PK
H	7266.00	43.25	30.33	6.32	24.55	43.79	54.00	-10.21	AV
H	9688.00	53.37	30.85	7.45	24.69	54.66	74.00	-19.34	PK
H	9688.00	43.42	30.85	7.45	24.69	44.71	54.00	-9.29	AV
H	12110.00	53.13	31.02	8.99	25.57	56.67	74.00	-17.33	PK
H	12110.00	43.25	31.02	8.99	25.57	46.79	54.00	-7.21	AV

Polar (H/V)	Frequency	Meter Reading	Pre-amplifier	Cable Loss	Antenna Factor	Emission Level	Limits	Margin	Detect or Type
	(MHz)	(dBuV)	(dB)	(dB)	(dB)	(dBuV/m)	(dBuV/m)	(dB)	
Middle Channel:2437MHz									
V	4874.00	51.13	30.55	5.77	24.66	51.01	74.00	-22.99	PK
V	4874.00	42.54	30.55	5.77	24.66	42.42	54.00	-11.58	AV
V	7311.00	53.15	30.33	6.32	24.55	53.69	74.00	-20.31	PK
V	7311.00	43.51	30.33	6.32	24.55	44.05	54.00	-9.95	AV
V	9748.00	53.28	30.85	7.45	24.69	54.57	74.00	-19.43	PK
V	9748.00	43.33	30.85	7.45	24.69	44.62	54.00	-9.38	AV
V	12185.00	53.14	31.02	8.99	25.57	56.68	74.00	-17.32	PK
V	12185.00	42.31	31.02	8.99	25.57	45.85	54.00	-8.15	AV
H	4874.00	51.26	30.55	5.77	24.66	51.14	74.00	-22.86	PK
H	4874.00	42.51	30.55	5.77	24.66	42.39	54.00	-11.61	AV
H	7311.00	52.43	30.33	6.32	24.55	52.97	74.00	-21.03	PK
H	7311.00	43.36	30.33	6.32	24.55	43.90	54.00	-10.10	AV
H	9748.00	53.21	30.85	7.45	24.69	54.50	74.00	-19.50	PK
H	9748.00	43.26	30.85	7.45	24.69	44.55	54.00	-9.45	AV
H	12185.00	53.27	31.02	8.99	25.57	56.81	74.00	-17.19	PK
H	12185.00	43.13	31.02	8.99	25.57	46.67	54.00	-7.33	AV

Polar (H/V)	Frequency	Meter Reading	Pre-amp lifier	Cable Loss	Antenna Factor	Emission Level	Limits	Margin	Detect or Type
	(MHz)	(dBuV)	(dB)	(dB)	(dB)	(dBuV/m)	(dBuV/ m)	(dB)	
High Channel:2452MHz									
V	4904.00	51.34	30.55	5.77	24.66	51.22	74.00	-22.78	PK
V	4904.00	42.52	30.55	5.77	24.66	42.40	54.00	-11.60	AV
V	7356.00	53.21	30.33	6.32	24.55	53.75	74.00	-20.25	PK
V	7356.00	43.45	30.33	6.32	24.55	43.99	54.00	-10.01	AV
V	9808.00	53.66	30.85	7.45	24.69	54.95	74.00	-19.05	PK
V	9808.00	43.34	30.85	7.45	24.69	44.63	54.00	-9.37	AV
V	12260.00	53.24	31.02	8.99	25.57	56.78	74.00	-17.22	PK
V	12260.00	42.51	31.02	8.99	25.57	46.05	54.00	-7.95	AV
H	4904.00	51.37	30.55	5.77	24.66	51.25	74.00	-22.75	PK
H	4904.00	42.75	30.55	5.77	24.66	42.63	54.00	-11.37	AV
H	7356.00	52.62	30.33	6.32	24.55	53.16	74.00	-20.84	PK
H	7356.00	43.35	30.33	6.32	24.55	43.89	54.00	-10.11	AV
H	9808.00	53.23	30.85	7.45	24.69	54.52	74.00	-19.48	PK
H	9808.00	43.21	30.85	7.45	24.69	44.50	54.00	-9.50	AV
H	12260.00	53.24	31.02	8.99	25.57	56.78	74.00	-17.22	PK
H	12260.00	43.25	31.02	8.99	25.57	46.79	54.00	-7.21	AV

Remark:

1. Emission Level = Meter Reading + Antenna Factor + Cable Loss – Pre-amplifier,

Margin= Emission Level - Limit

2. If peak below the average limit, the average emission was no test.

3. The amplitude of spurious emissions which are attenuated by more than 20dB below the permissible value has no need to be reported.

5. RADIATED BAND EMISSION MEASUREMENT

5.1 TEST REQUIREMENT:

Test Requirement:	FCC Part15 C Section 15.209 and 15.205				
Test Method:	ANSI C63.10: 2013				
Test Frequency Range:	All of the restrict bands were tested, only the worst band's (2310MHz to 2500MHz) data was showed.				
Test site:	Measurement Distance: 3m				
Receiver setup:	Frequency	Detector	RBW	VBW	Value
	Above 1GHz	Peak	1MHz	3MHz	Peak
		Average	1MHz	3MHz	Average

LIMITS OF RADIATED EMISSION MEASUREMENT (Above 1000MHz)

FREQUENCY (MHz)	Class B (dBuV/m) (at 3M)	
	PEAK	AVERAGE
Above 1000	74	54

Notes:

- (1) The limit for radiated test was performed according to FCC PART 15C.
- (2) The tighter limit applies at the band edges.
- (3) Emission level (dBuV/m)=20log Emission level (uV/m).

5.2 TEST PROCEDURE

Above 1GHz test procedure as below:

- a. 1. The EUT was placed on the top of a rotating table 1.5 meters above the ground at a 3 meter camber. The table was rotated 360 degrees to determine the position of the highest radiation.
- b. The EUT was set 3 meters away from the interference-receiving antenna, which was mounted on the top of a variable-height antenna tower.
- c. The antenna height is varied from one meter to four meters above the ground to determine the maximum value of the field strength. Both horizontal and vertical polarizations of the antenna are set to make the measurement.
- d. For each suspected emission, the EUT was arranged to its worst case and then the antenna was tuned to heights from 1 meter to 4 meters and the rota table was turned from 0 degrees to 360 degrees to find the maximum reading.
- e. The test-receiver system was set to Peak Detect Function and Specified Bandwidth with Maximum Hold Mode.
- f. If the emission level of the EUT in peak mode was 10dB lower than the limit specified, then testing could bestopped and the peak values of the EUT would be reported. Otherwise the emissions that did not have 10dBmargin would be re-tested one by one using peak, quasi-peak or average method as specified and then reportedin a data sheet.
- g. Test the EUT in the lowest channel,the Highest channel

Note:

Both horizontal and vertical antenna polarities were tested and performed pretest to three orthogonal axis. The worst case emissions were reported

5.3 DEVIATION FROM TEST STANDARD

No deviation

5.4 TEST SETUP

Radiated Emission Test-Up Frequency Above 1GHz

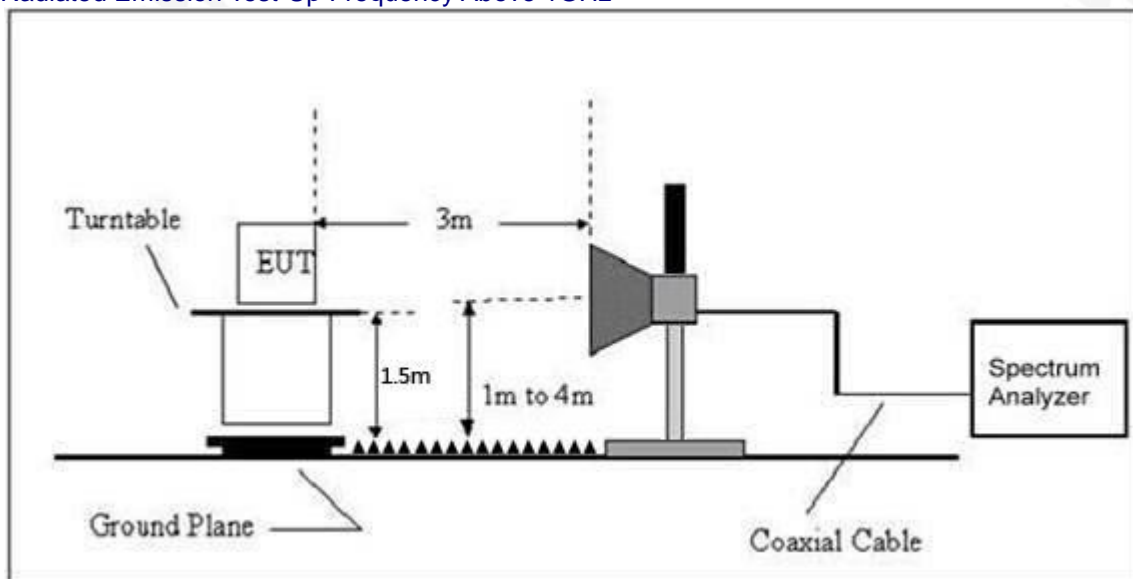

5.5 EUT OPERATING CONDITIONS

The EUT tested system was configured as the statements of 2.3 Unless otherwise a special operating condition is specified in the follows during the testing.

5.6 TEST RESULT

	Polar (H/V)	Frequency (MHz)	Meter Reading (dBuV)	Pre-amplifier (dB)	Cable Loss (dB)	Antenna Factor (dB/m)	Emission level (dBuV/m)	Limit (dBuV/m)	Detector Type	Result
802.11b	Low Channel 2412MHz									
	H	2390.00	60.45	30.22	4.85	23.98	59.06	74.00	PK	PASS
	H	2390.00	52.13	30.22	4.85	23.98	50.74	54.00	AV	PASS
	H	2400.00	62.35	30.22	4.85	23.98	60.96	74.00	PK	PASS
	H	2400.00	52.11	30.22	4.85	23.98	50.72	54.00	AV	PASS
	V	2390.00	60.32	30.22	4.85	23.98	58.93	74.00	PK	PASS
	V	2390.00	52.23	30.22	4.85	23.98	50.84	54.00	AV	PASS
	V	2400.00	62.15	30.22	4.85	23.98	60.76	74.00	PK	PASS
	V	2400.00	52.23	30.22	4.85	23.98	50.84	54.00	AV	PASS
	High Channel 2462MHz									
	H	2483.50	60.25	30.22	4.85	23.98	58.86	74.00	PK	PASS
	H	2485.50	51.33	30.22	4.85	23.98	49.94	54.00	AV	PASS
	H	2483.50	61.55	30.22	4.85	23.98	60.16	74.00	PK	PASS
	H	2485.50	52.12	30.22	4.85	23.98	50.73	54.00	AV	PASS
V	2483.50	61.05	30.22	4.85	23.98	59.66	74.00	PK	PASS	
V	2485.50	52.33	30.22	4.85	23.98	50.94	54.00	AV	PASS	
V	2483.50	61.22	30.22	4.85	23.98	59.83	74.00	PK	PASS	
V	2485.50	52.11	30.22	4.85	23.98	50.72	54.00	AV	PASS	
802.11g	Low Channel 2412MHz									
	H	2390.00	60.64	30.22	4.85	23.98	59.25	74.00	PK	PASS
	H	2390.00	52.25	30.22	4.85	23.98	50.86	54.00	AV	PASS
	H	2400.00	62.34	30.22	4.85	23.98	60.95	74.00	PK	PASS
	H	2400.00	52.14	30.22	4.85	23.98	50.75	54.00	AV	PASS
	V	2390.00	60.51	30.22	4.85	23.98	59.12	74.00	PK	PASS
	V	2390.00	52.15	30.22	4.85	23.98	50.76	54.00	AV	PASS
	V	2400.00	62.03	30.22	4.85	23.98	60.64	74.00	PK	PASS
	V	2400.00	52.05	30.22	4.85	23.98	50.66	54.00	AV	PASS
	High Channel 2462MHz									
	H	2483.50	60.45	30.22	4.85	23.98	59.06	74.00	PK	PASS
	H	2485.50	52.03	30.22	4.85	23.98	50.64	54.00	AV	PASS
	H	2483.50	62.31	30.22	4.85	23.98	60.92	74.00	PK	PASS
	H	2485.50	52.22	30.22	4.85	23.98	50.83	54.00	AV	PASS
V	2483.50	60.23	30.22	4.85	23.98	58.84	74.00	PK	PASS	
V	2485.50	52.14	30.22	4.85	23.98	50.75	54.00	AV	PASS	
V	2483.50	62.32	30.22	4.85	23.98	60.93	74.00	PK	PASS	
V	2485.50	52.35	30.22	4.85	23.98	50.96	54.00	AV	PASS	
802.11n20	Low Channel 2412MHz									
	H	2390.00	59.25	30.22	4.85	23.98	57.86	74.00	PK	PASS
	H	2390.00	51.81	30.22	4.85	23.98	50.42	54.00	AV	PASS
	H	2400.00	61.63	30.22	4.85	23.98	60.24	74.00	PK	PASS
	H	2400.00	51.25	30.22	4.85	23.98	49.86	54.00	AV	PASS
	V	2390.00	59.57	30.22	4.85	23.98	58.18	74.00	PK	PASS
	V	2390.00	51.15	30.22	4.85	23.98	49.76	54.00	AV	PASS
	V	2400.00	62.16	30.22	4.85	23.98	60.77	74.00	PK	PASS
	V	2400.00	51.18	30.22	4.85	23.98	49.79	54.00	AV	PASS
	High Channel 2462MHz									
	H	2483.50	59.26	30.22	4.85	23.98	57.87	74.00	PK	PASS
	H	2485.50	51.13	30.22	4.85	23.98	49.74	54.00	AV	PASS
	H	2483.50	61.04	30.22	4.85	23.98	59.65	74.00	PK	PASS
	H	2485.50	51.28	30.22	4.85	23.98	49.89	54.00	AV	PASS
V	2483.50	59.13	30.22	4.85	23.98	57.74	74.00	PK	PASS	
V	2485.50	51.75	30.22	4.85	23.98	50.36	54.00	AV	PASS	
V	2483.50	62.26	30.22	4.85	23.98	60.87	74.00	PK	PASS	

802.11n40	V	2485.50	51.12	30.22	4.85	23.98	49.73	54.00	AV	PASS	
	LowChannel 2422MHz										
	H	2390.00	59.25	30.22	4.85	23.98	57.86	74.00	PK	PASS	
	H	2390.00	51.13	30.22	4.85	23.98	49.74	54.00	AV	PASS	
	H	2400.00	61.25	30.22	4.85	23.98	59.86	74.00	PK	PASS	
	H	2400.00	51.36	30.22	4.85	23.98	49.97	54.00	AV	PASS	
	V	2390.00	59.43	30.22	4.85	23.98	58.04	74.00	PK	PASS	
	V	2390.00	51.27	30.22	4.85	23.98	49.88	54.00	AV	PASS	
	V	2400.00	61.15	30.22	4.85	23.98	59.76	74.00	PK	PASS	
	V	2400.00	51.06	30.22	4.85	23.98	49.67	54.00	AV	PASS	
	High Channel 2452MHz										
	H	2483.50	59.84	30.22	4.85	23.98	58.45	74.00	PK	PASS	
	H	2485.50	51.26	30.22	4.85	23.98	49.87	54.00	AV	PASS	
	H	2483.50	61.13	30.22	4.85	23.98	59.74	74.00	PK	PASS	
	H	2485.50	51.05	30.22	4.85	23.98	49.66	54.00	AV	PASS	
	V	2483.50	59.22	30.22	4.85	23.98	57.83	74.00	PK	PASS	
	V	2485.50	51.13	30.22	4.85	23.98	49.74	54.00	AV	PASS	
	V	2483.50	62.31	30.22	4.85	23.98	60.92	74.00	PK	PASS	
V	2485.50	51.55	30.22	4.85	23.98	50.16	74.00	AV	PASS		

Remark:

1. Emission Level = Meter Reading + Antenna Factor + Cable Loss – Pre-amplifier, Margin= Emission Level - Limit

6. POWER SPECTRAL DENSITY TEST

Test Requirement:	FCC Part15 C Section 15.247 (e)
Test Method:	KDB558074 D0115.247 Meas Guidance v 05r02

6.1 APPLIED PROCEDURES / LIMIT

FCC Part15 (15.247) , Subpart C				
Section	Test Item	Limit	Frequency Range (MHz)	Result
15.247	Power Spectral Density	8dBm/3kHz	2400-2483.5	PASS

6.2 TEST PROCEDURE

1. Set analyzer center frequency to DTS channel center frequency.
2. Set the span to 1.5 times the DTS bandwidth.
3. Set the RBW to: $3 \text{ kHz} \leq \text{RBW} \leq 100 \text{ kHz}$.
4. Set the VBW $\geq 3 \times \text{RBW}$.
5. Detector = peak.
6. Sweep time = auto couple.
7. Trace mode = max hold.
8. Allow trace to fully stabilize.
9. Use the peak marker function to determine the maximum amplitude level within the RBW.
10. If measured value exceeds limit, reduce RBW (no less than 3 kHz) and repeat.

6.3 DEVIATION FROM STANDARD

No deviation.

6.4 TEST SETUP



6.5 EUT OPERATION CONDITIONS

The EUT tested system was configured as the statements of 2.1 Unless otherwise a special operating condition is specified in the follows during the testing.

6.6 TEST RESULT

Temperature :	26°C	Relative Humidity :	54%
Pressure :	101kPa	Test Voltage :	DC 3.7V
Test Mode :	TX b Mode		

Frequency	Power Spectral Density (dBm/3kHz)	Limit (dBm/3kHz)	Result
2412 MHz	-9.284	8	PASS
2437 MHz	-10.261	8	PASS
2462 MHz	-9.881	8	PASS

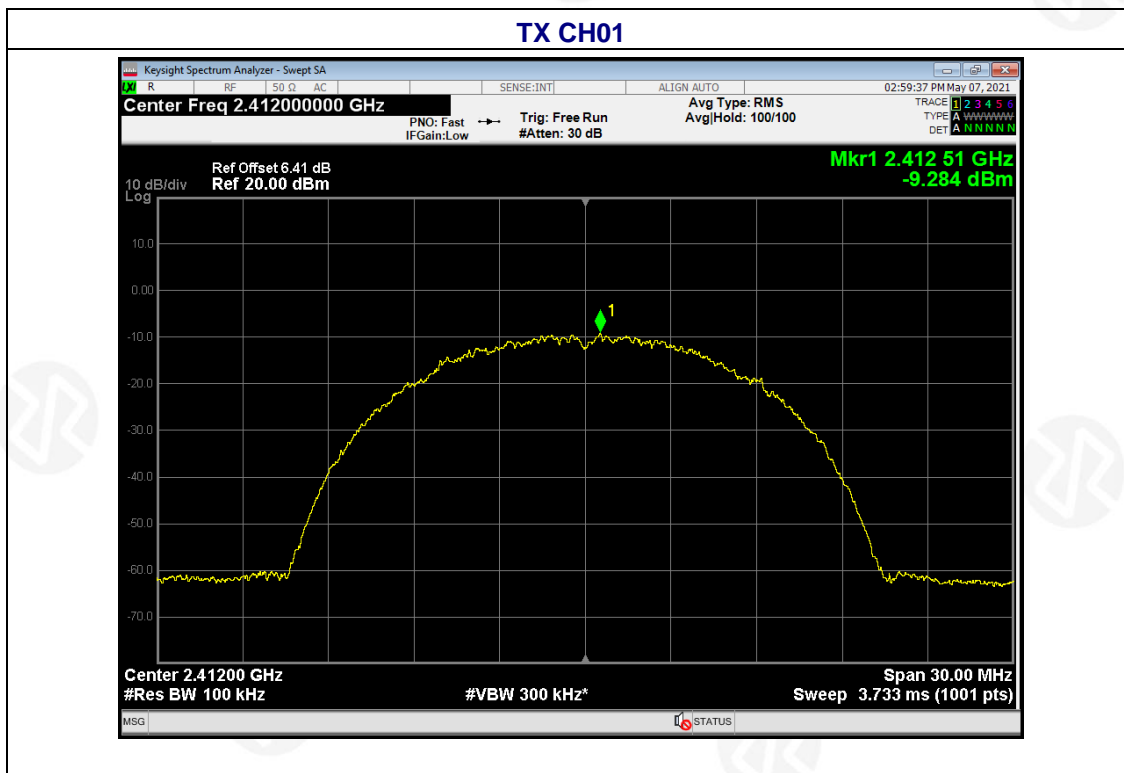

TX CH06

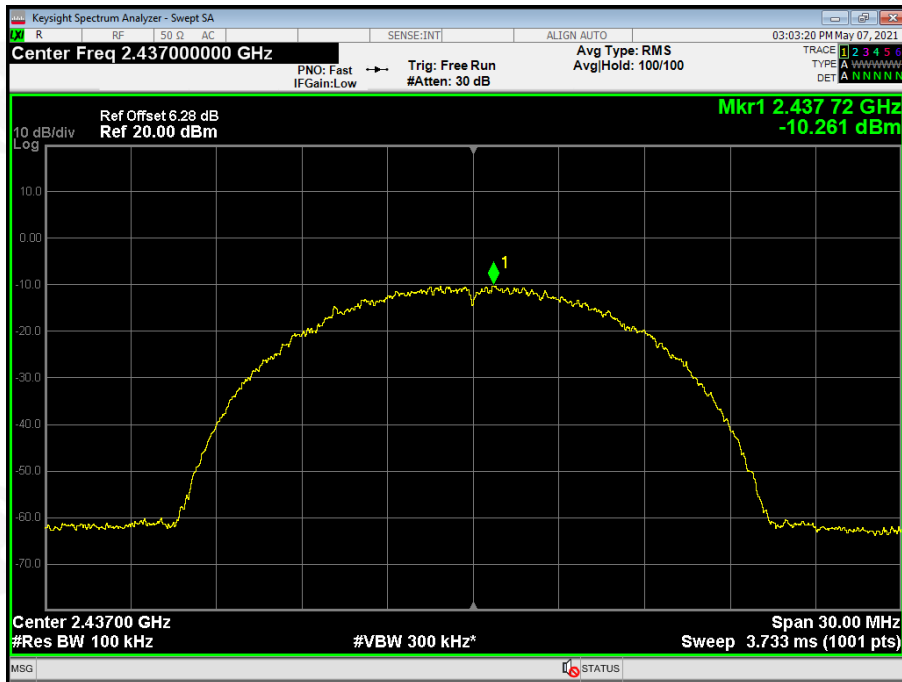

TX CH11

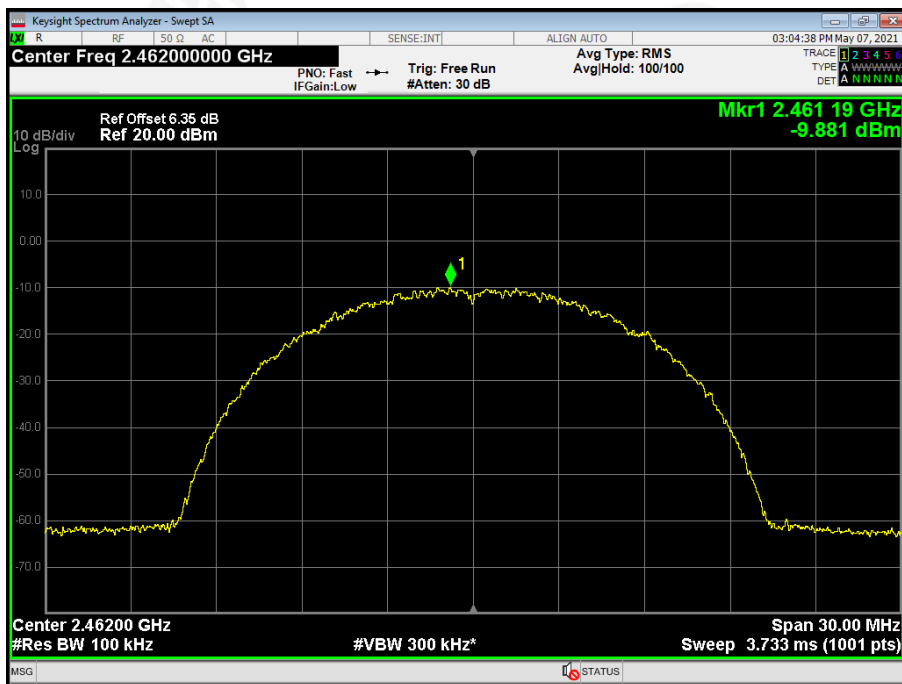

Temperature :	26°C	Relative Humidity :	54%
Pressure :	101kPa	Test Voltage :	DC 3.7V
Test Mode :	TX g Mode		

Frequency	Power Spectral Density (dBm/3kHz)	Limit (dBm/3kHz)	Result
2412 MHz	-13.842	8	PASS
2437 MHz	-14.734	8	PASS
2462 MHz	-4.996	8	PASS

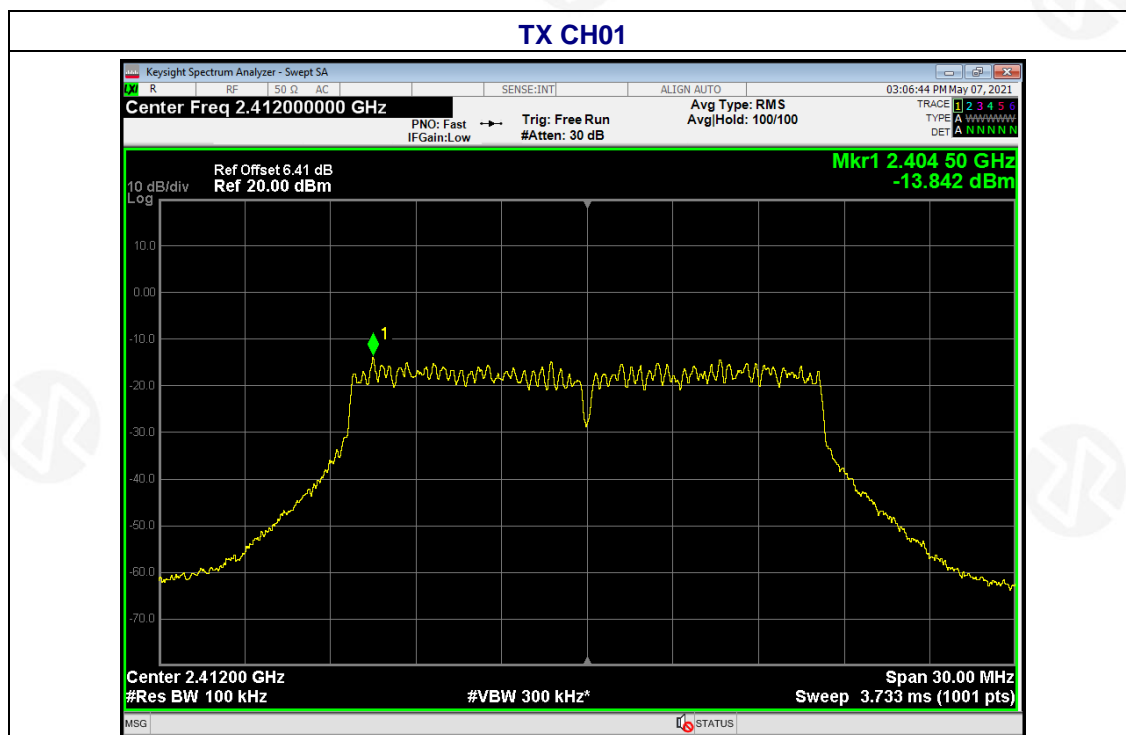

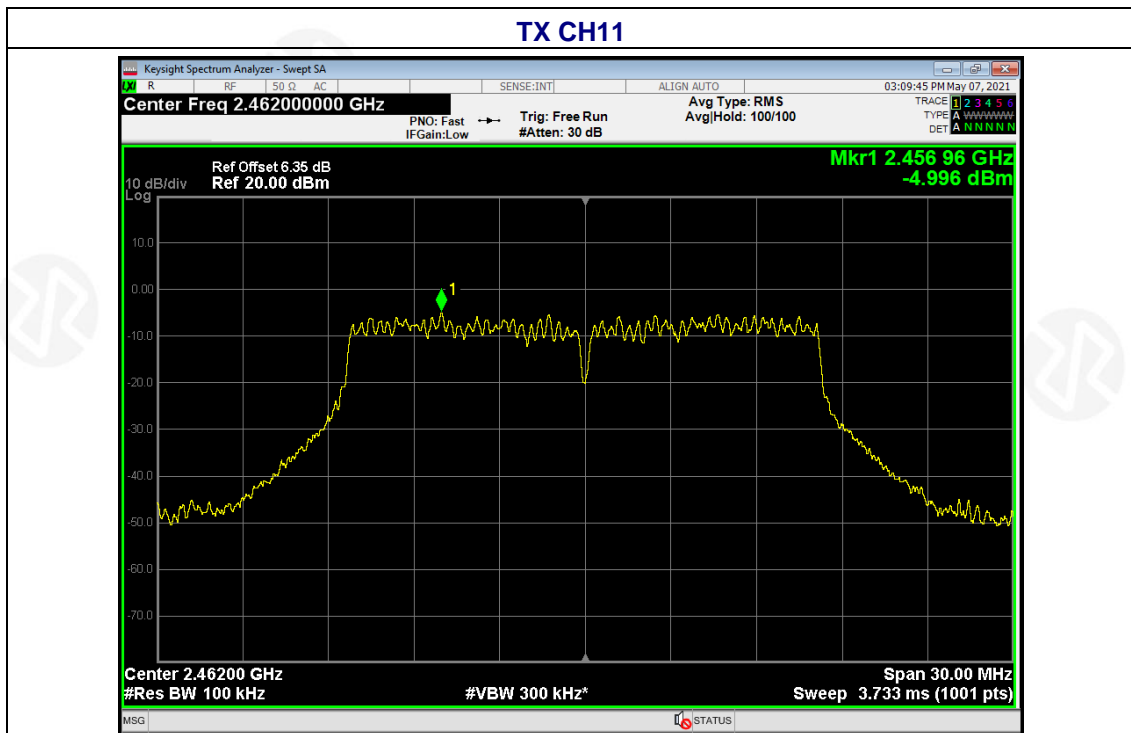
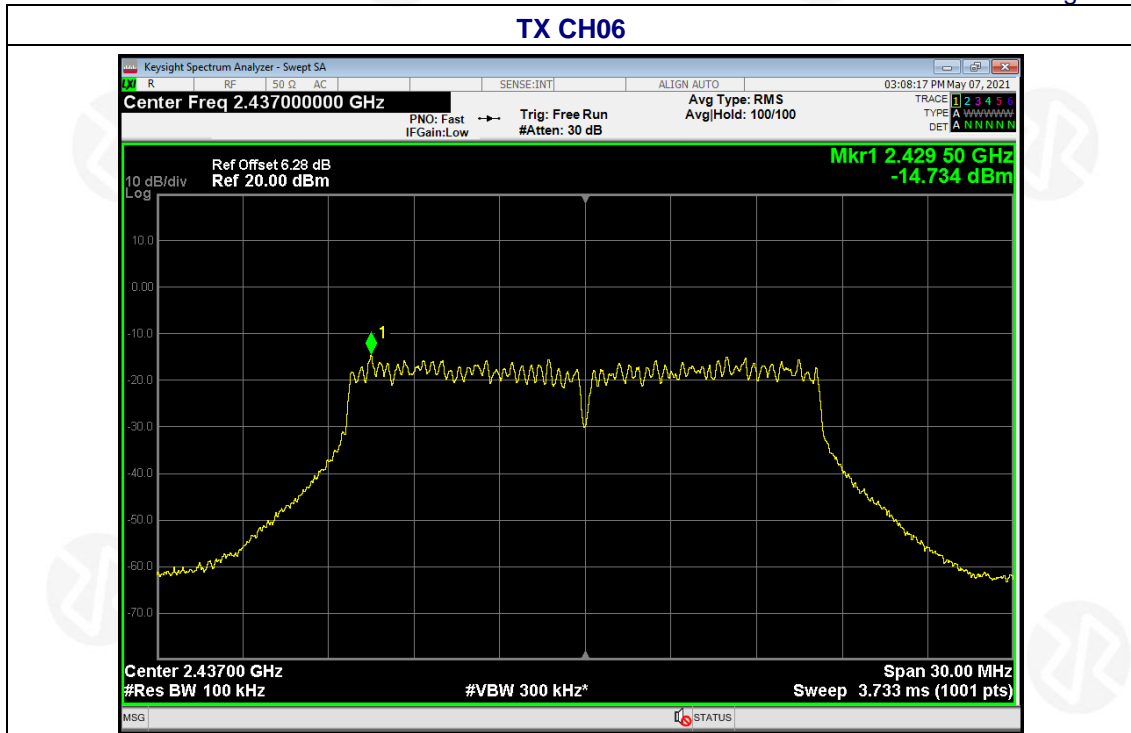

Temperature :	26°C	Relative Humidity :	54%
Pressure :	101kPa	Test Voltage :	DC 3.7V
Test Mode :	TX n Mode(20M)		

Frequency	Power Spectral Density (dBm/3kHz)	Limit (dBm/3kHz)	Result
2412 MHz	-3.899	8	PASS
2437 MHz	-4.781	8	PASS
2462 MHz	-4.374	8	PASS

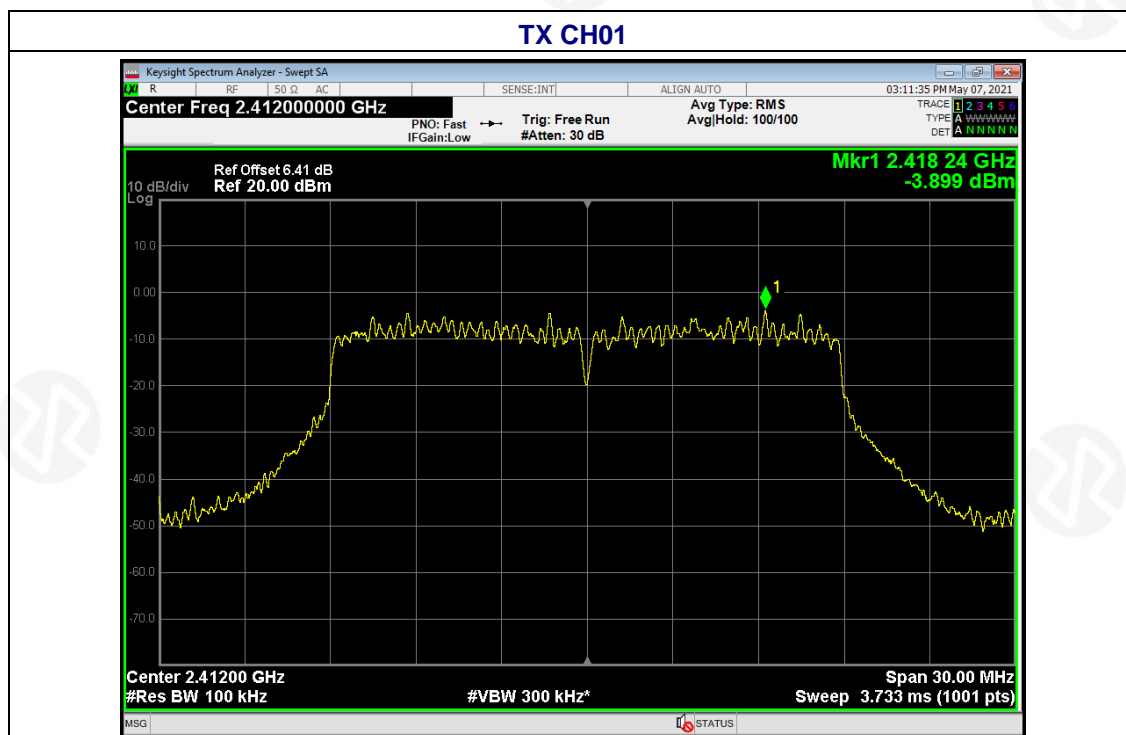

TX CH06

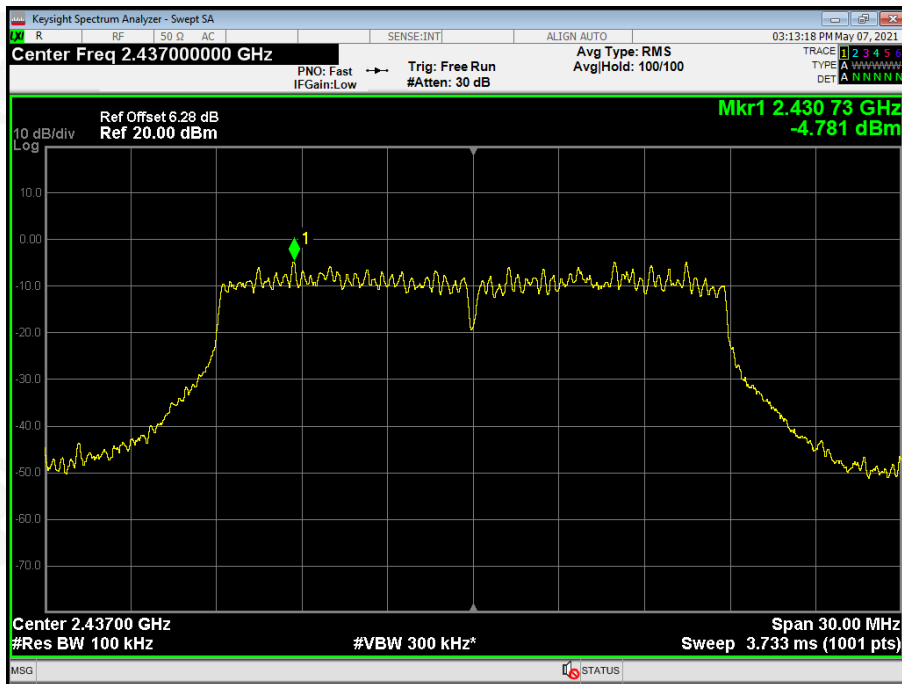

TX CH11

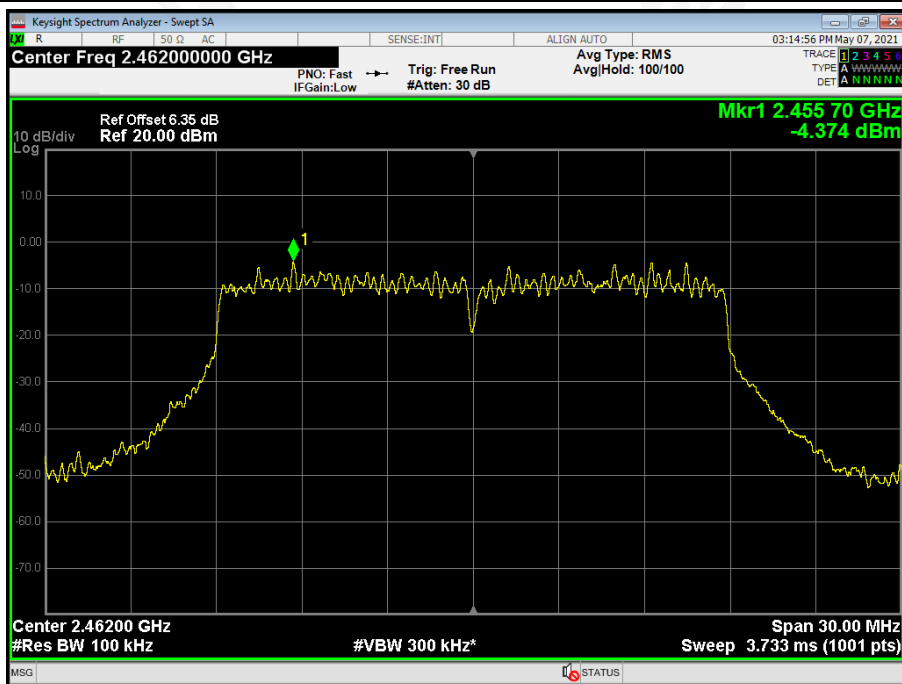

Temperature :	26°C	Relative Humidity :	54%
Pressure :	101kPa	Test Voltage :	DC 3.7V
Test Mode :	TX n Mode(40M)		

Frequency	Power Spectral Density (dBm/3kHz)	Limit (dBm/3kHz)	Result
2422 MHz	-6.52	8	PASS
2437 MHz	-7.547	8	PASS
2452 MHz	-7.273	8	PASS

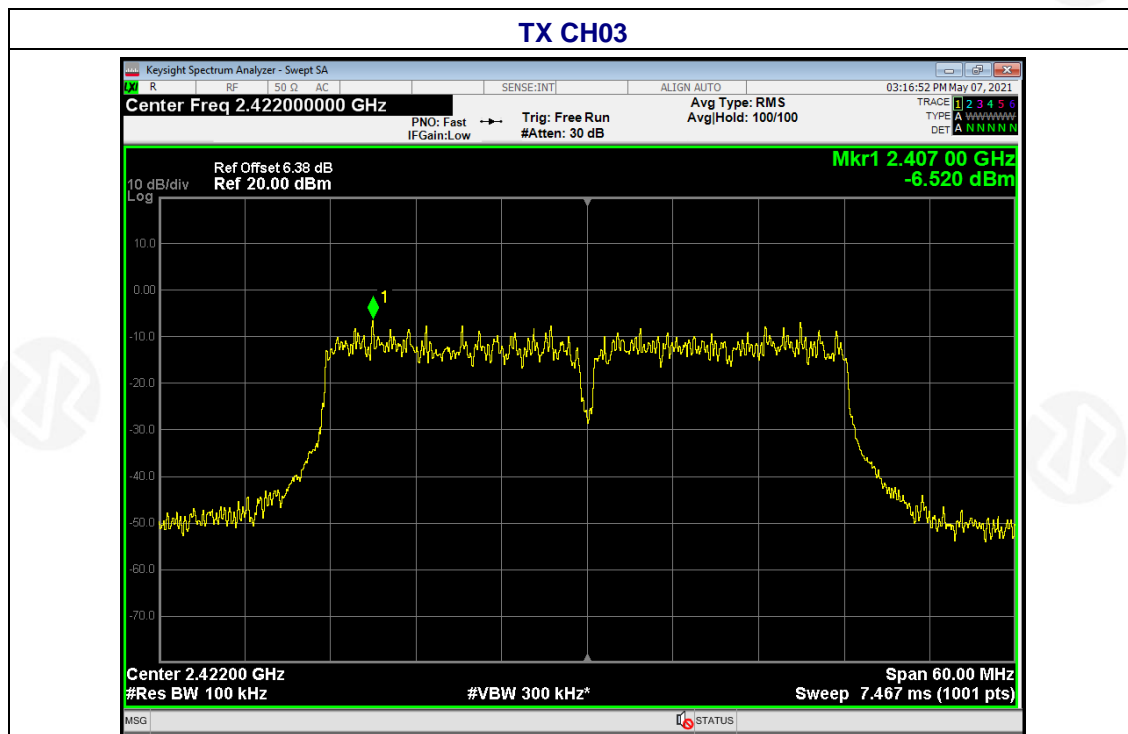

TX CH06

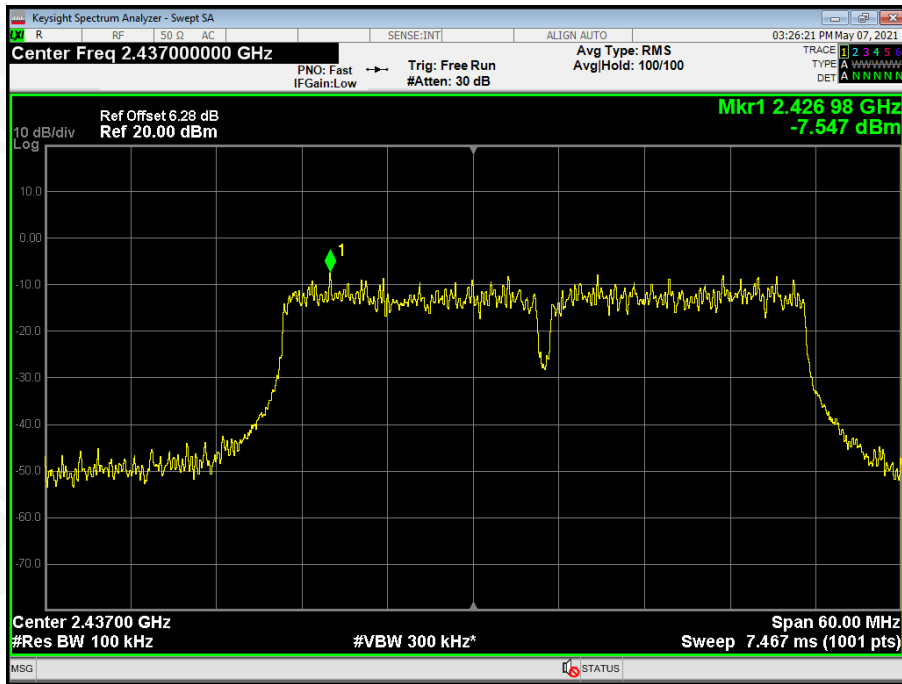

TX CH09

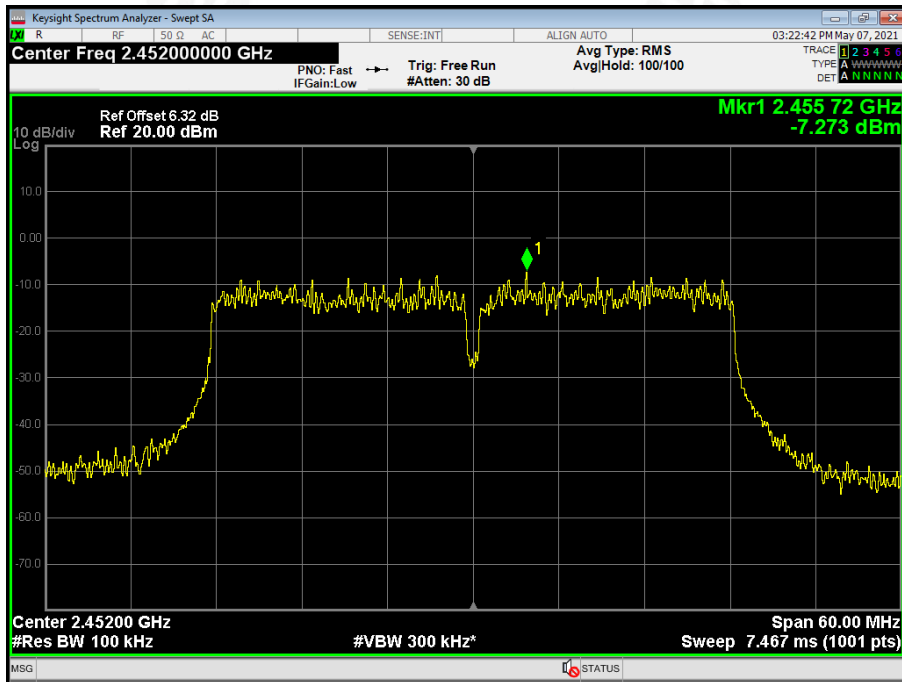

7. CHANNEL BANDWIDTH& 99% OCCUPY BANDWIDTH

Test Requirement:	FCC Part15 C Section 15.247 (a)(2)
Test Method:	KDB558074 D0115.247 Meas Guidance v05r02

7.1 APPLIED PROCEDURES / LIMIT

FCC Part15 (15.247) , Subpart C				
Section	Test Item	Limit	Frequency Range (MHz)	Result
15.247(a)(2)	Bandwidth	$\geq 500\text{KHz}$ (6dB bandwidth)	2400-2483.5	PASS

7.2 TEST PROCEDURE

1. Set RBW = 100 kHz.
2. Set the video bandwidth (VBW) $\geq 3 \times \text{RBW}$.
3. Detector = Peak.
4. Trace mode = max hold.
5. Sweep = auto couple.
6. Allow the trace to stabilize.
7. Measure the maximum width of the emission that is constrained by the frequencies associated with the two outermost amplitude points (upper and lower frequencies) that are attenuated by 6 dB relative to the maximum level measured in the fundamental emission.

7.3 DEVIATION FROM STANDARD

No deviation.

7.4 TEST SETUP



7.5 EUT OPERATION CONDITIONS

The EUT tested system was configured as the statements of 2.4 Unless otherwise a special operating condition is specified in the follows during the testing.

7.6 TEST RESULT

Temperature :	26°C	Relative Humidity :	54%
Pressure :	101kPa	Test Voltage :	DC 3.7V
Test Mode :	TX b Mode		

Test CH	Channel Bandwidth (MHz)				Limit(KHz)	Result
	802.11b	802.11g	802.11n(HT20)	802.11n(HT40)		
Lowest	8.902	16.371	17.61	35.552	>500	Pass
Middle	9.259	16.358	17.607	35.745		
Highest	9.359	16.373	17.61	35.779		

Test CH	99% Occupy Bandwidth (MHz)				Result
	802.11b	802.11g	802.11n(HT20)	802.11n(HT40)	
Lowest	13.575	16.361	17.583	35.923	Pass
Middle	13.495	16.367	17.584	35.957	
Highest	13.559	16.358	17.581	35.945	

Test plot as follows:

802.11b

802.11g

Lowest channel

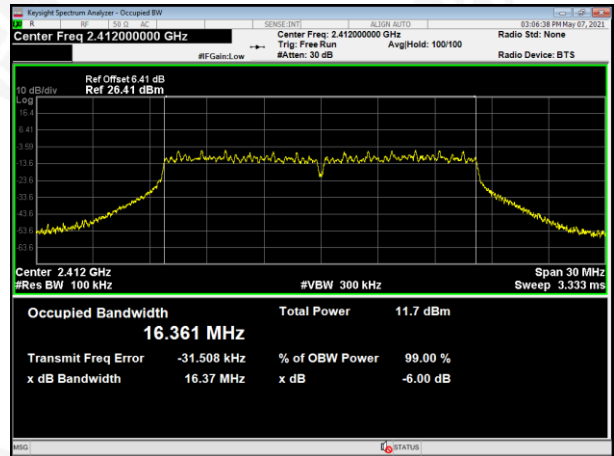
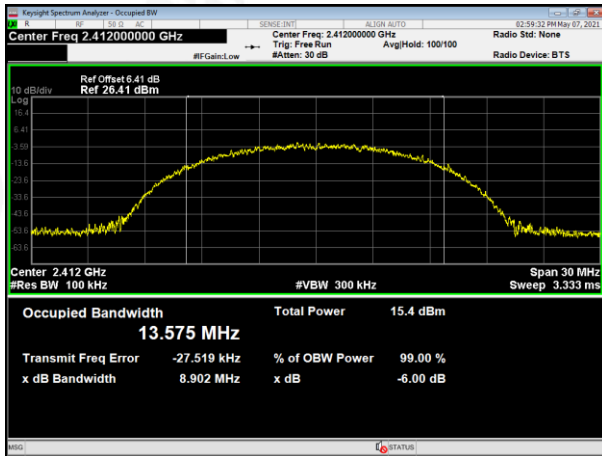

Middle channel

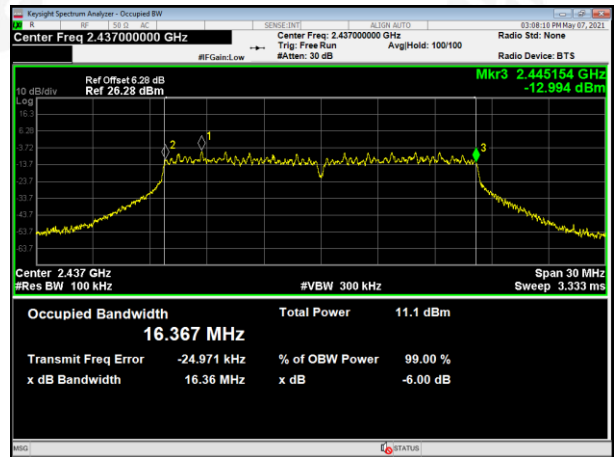
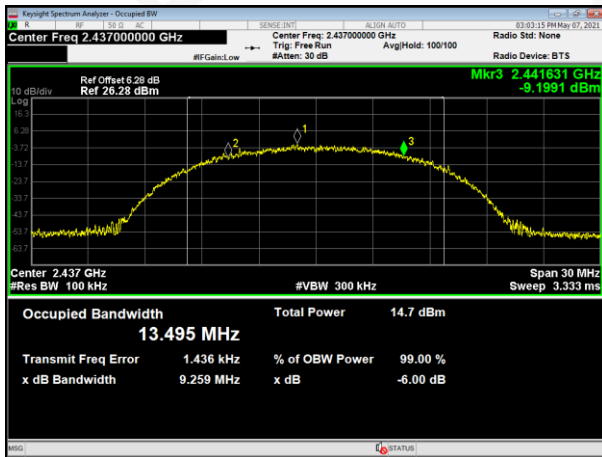

Highest channel

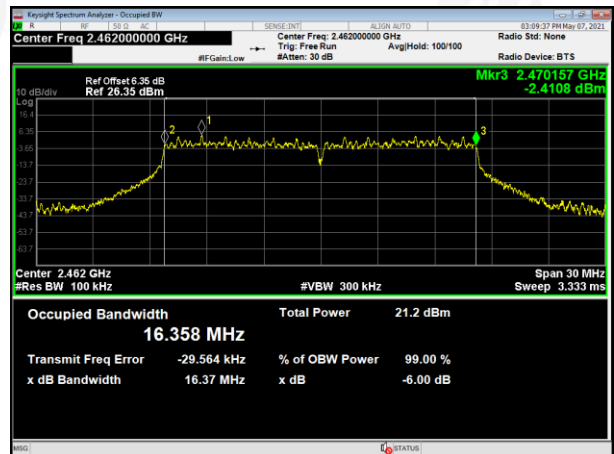
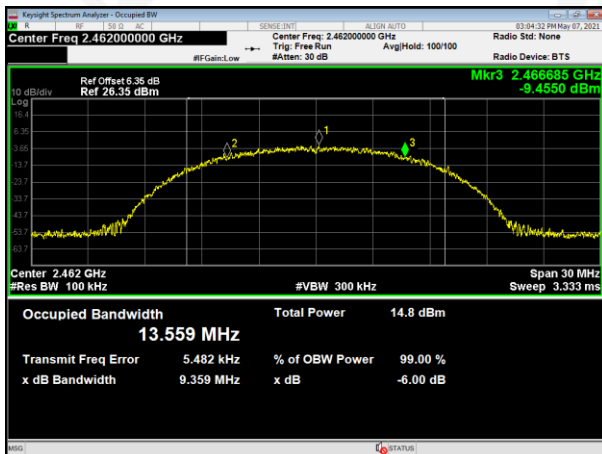

802.11n20

801.11n40

Lowest channel

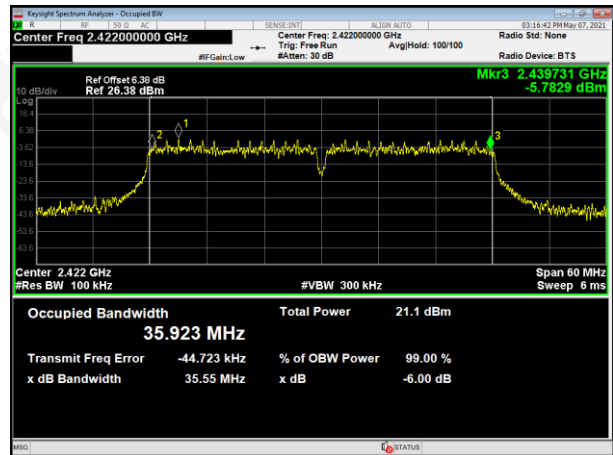
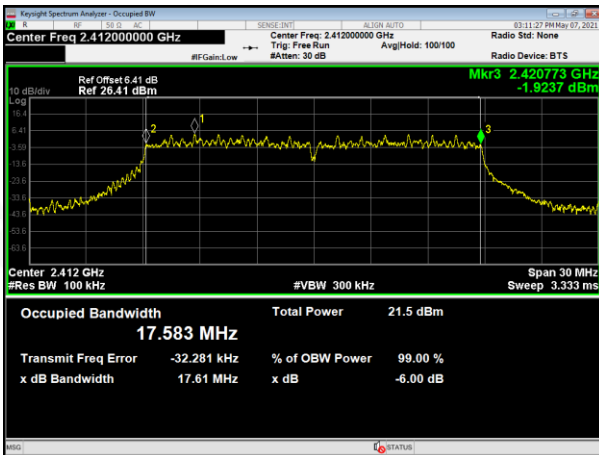

Middle channel

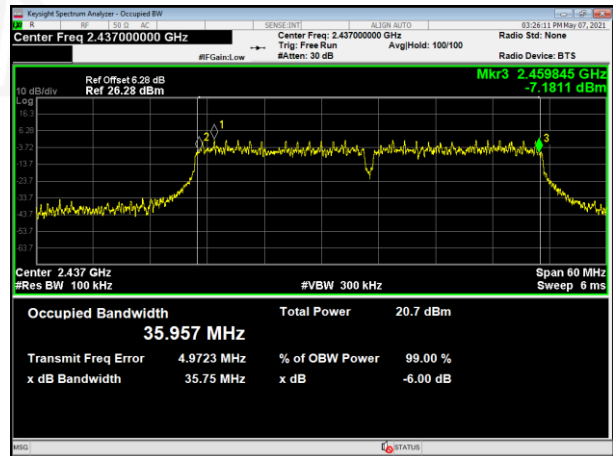
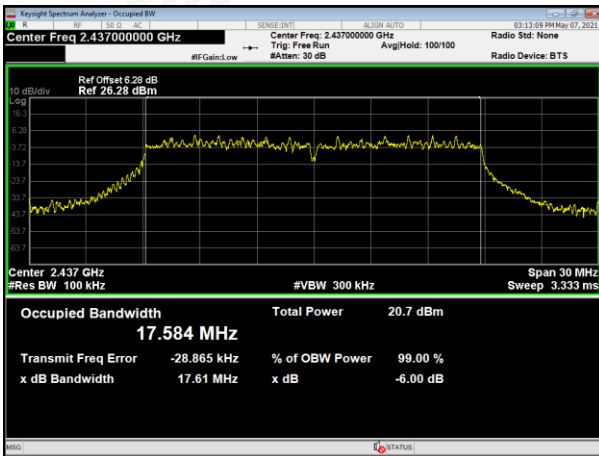

Highest channel

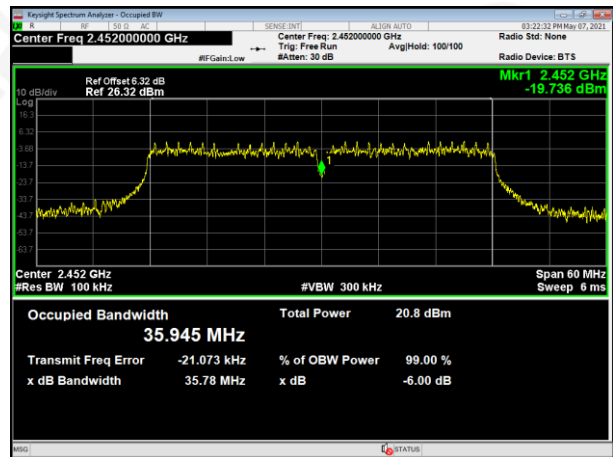
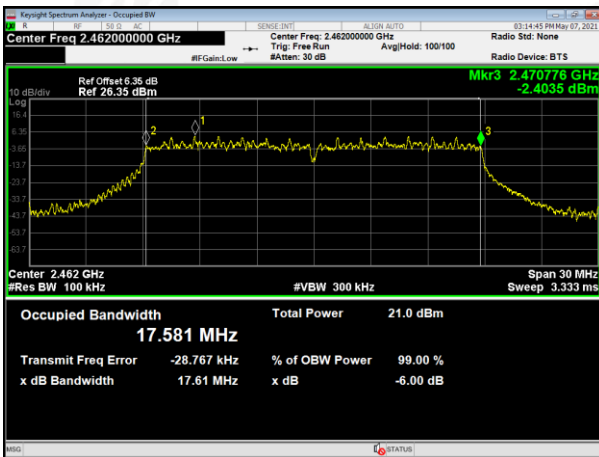

8. PEAK OUTPUT POWER TEST

Test Requirement:	FCC Part15 C Section 15.247 (b)(3)
Test Method:	KDB558074 D0115.247 Meas Guidance v05r02

8.1 APPLIED PROCEDURES/LIMIT

FCC Part15 (15.247) , Subpart C				
Section	Test Item	Limit	Frequency Range (MHz)	Result
15.247(b)(3)	Peak Output Power	1 watt or 30dBm	2400-2483.5	PASS

8.2 TEST PROCEDURE

- a. The EUT was directly connected to the Power meter

8.3 DEVIATION FROM STANDARD

No deviation.

8.4 TEST SETUP



8.5 EUT OPERATION CONDITIONS

The EUT tested system was configured as the statements of 2.4 Unless otherwise a special operating condition is specified in the follows during the testing.

8.6 TEST RESULT

Temperature :	26°C	Relative Humidity :	54%
Pressure :	101kPa	Test Voltage :	DC 3.7V

Test CH	Peak Output Power (dBm)				Limit(dBm)	Result
	802.11b	802.11g	802.11n(HT20)	802.11n(HT40)		
Lowest	8.351	7.402	7.094	6.275	30.00	Pass
Middle	7.596	7.863	6.351	6.406		
Highest	7.788	7.033	6.495	6.887		

9. CONDUCTED BAND EDGE AND SPURIOUS EMISSION

Test Requirement:	FCC Part15 C Section 15.247 (d)
Test Method:	KDB558074 D0115.247 Meas Guidance v05r02

9.1 APPLICABLE STANDARD

in any 100 kHz bandwidth outside the frequency bands in which the spread spectrum intentional radiator is operating, the radio frequency power that is produced by the intentional radiator shall be at least 20dB below that in the 100kHz bandwidth within the band that contains the highest level of the desired power, In addition, radiated emissions which fall in the restricted bands, as defined in§15.205(a), must also comply with the radiated emission limits specified in15.209(a).

9.2 TEST PROCEDURE

Using the following spectrum analyzer setting:

- A) Set the RBW = 100KHz.
- B) Set the VBW = 300KHz.
- C) Sweep time = auto couple.
- D) Detector function = peak.
- E) Trace mode = max hold.
- F) Allow trace to fully stabilize.

9.3 DEVIATION FROM STANDARD

No deviation.

9.4 TEST SETUP

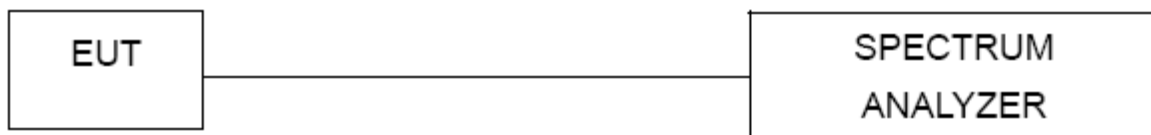

9.5 EUT OPERATION CONDITIONS

The EUT tested system was configured as the statements of 2.4 Unless otherwise a special operating condition is specified in the follows during the testing.

9.6 TEST RESULTS

Test plot as follows:

Test mode: 802.11b

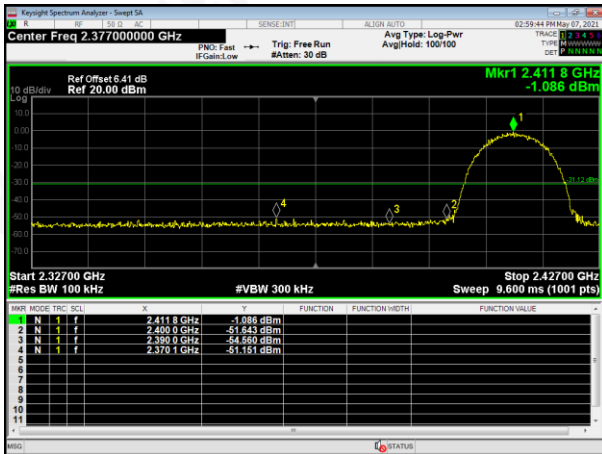

Lowest channel

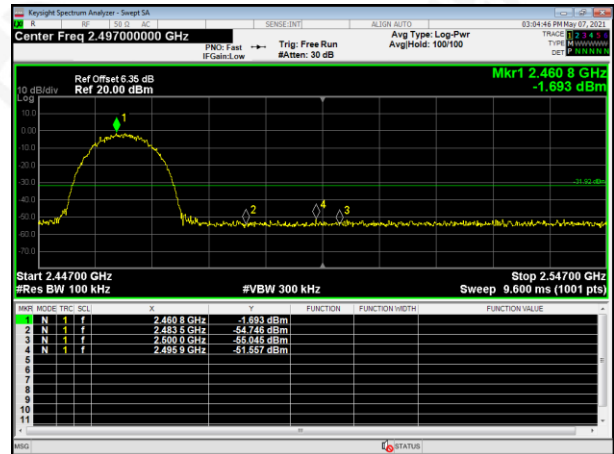

Highest channel

Test mode: 802.11g

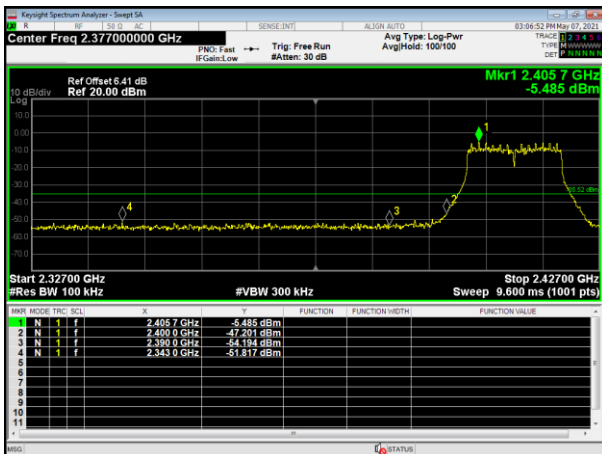

Lowest channel

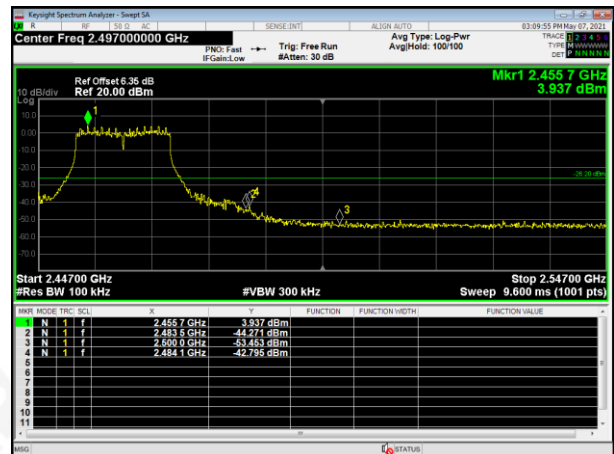

Highest channel

Test mode: 802.11n(HT20)

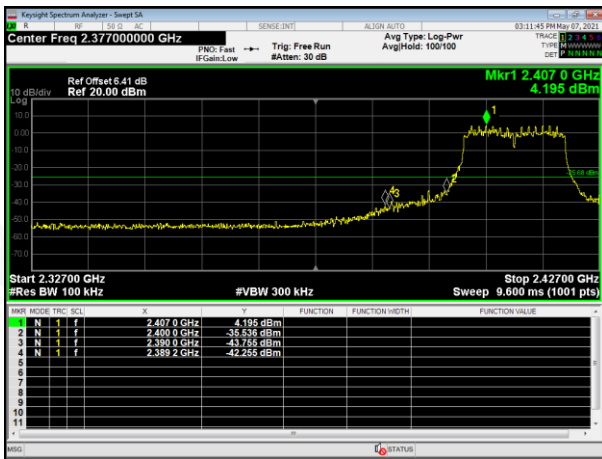

Lowest channel

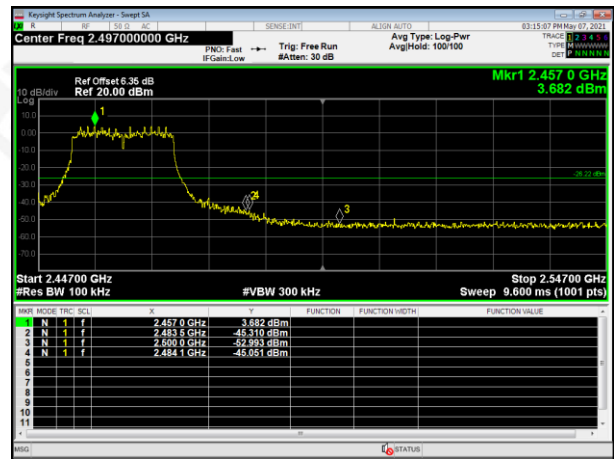

Highest channel

Test mode: 802.11n(HT40)

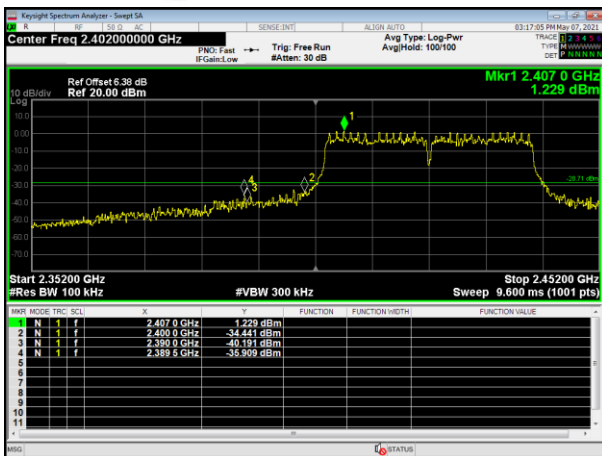

Lowest channel

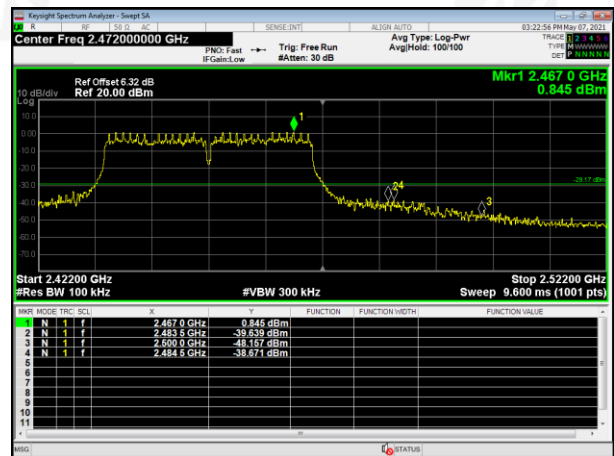

Highest channel

Test plot as follows:

802.11b
Lowest channel

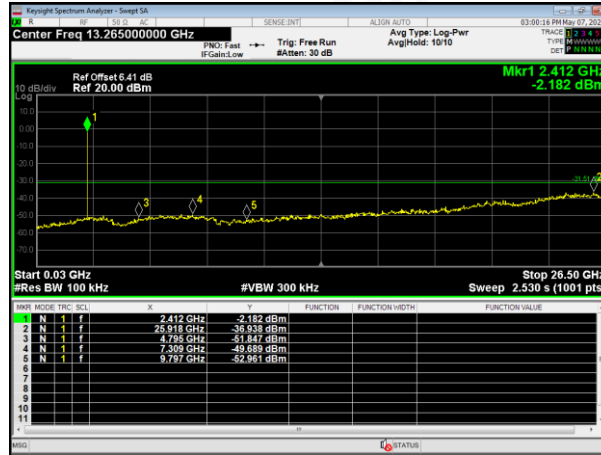

Middle channel

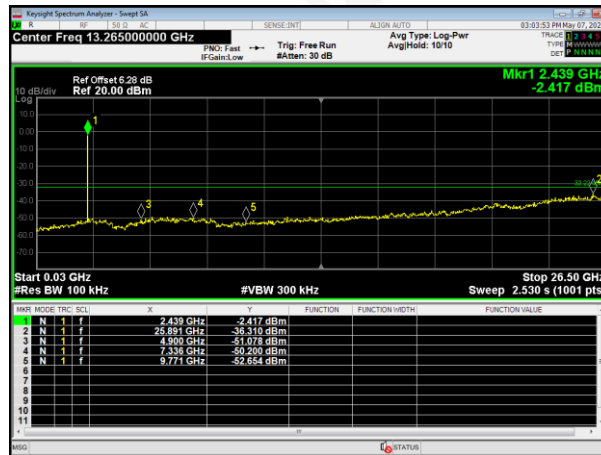

Highest channel

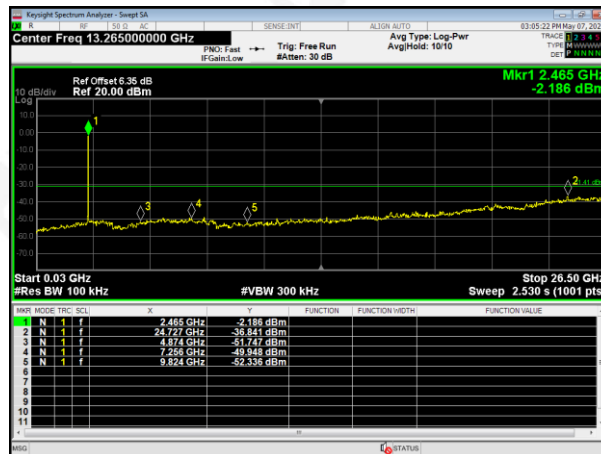

802.11g
Lowest channel

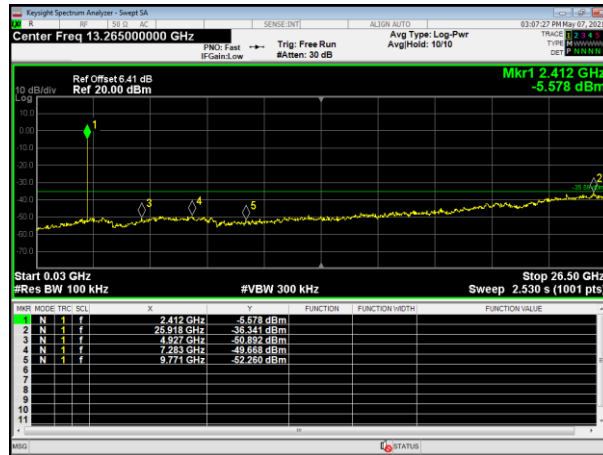

Middle channel

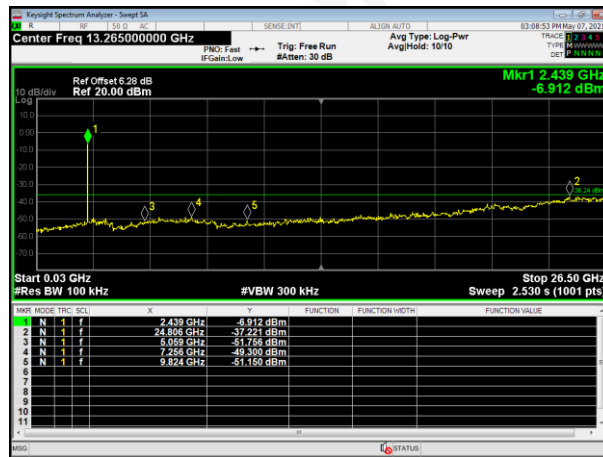

Highest channel

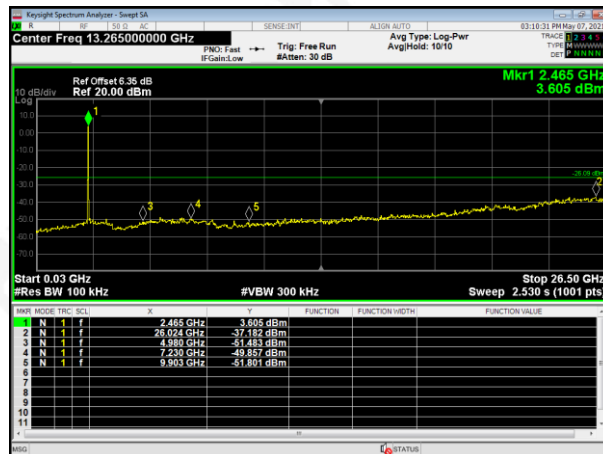

802.11n(HT20)
Lowest channel

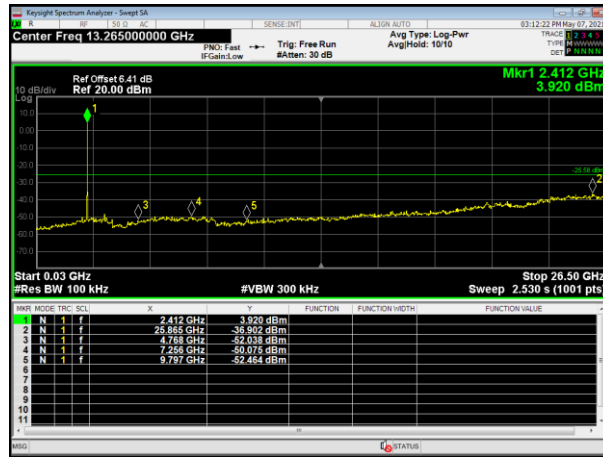

Middle channel

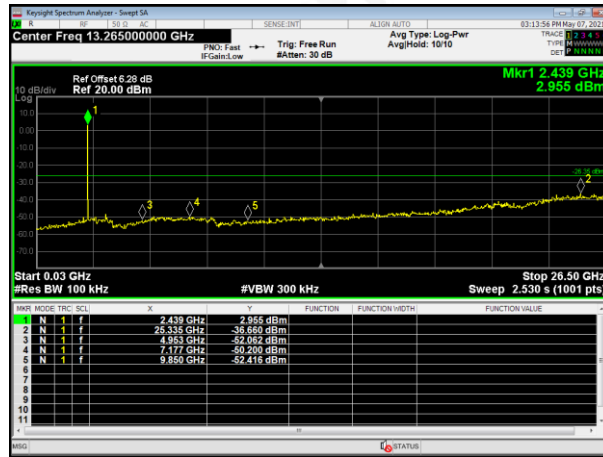

Highest channel

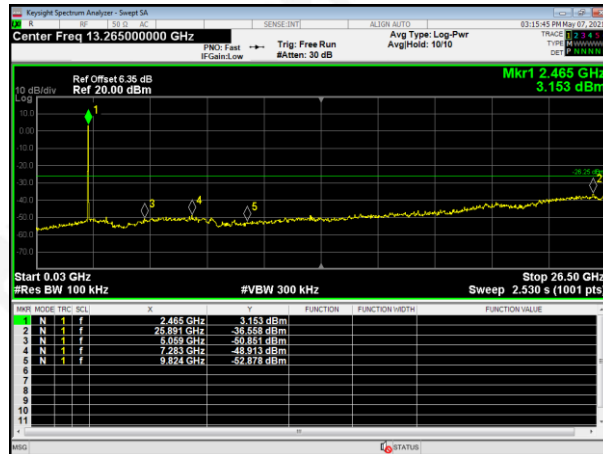

802.11n(HT40)
Lowest channel

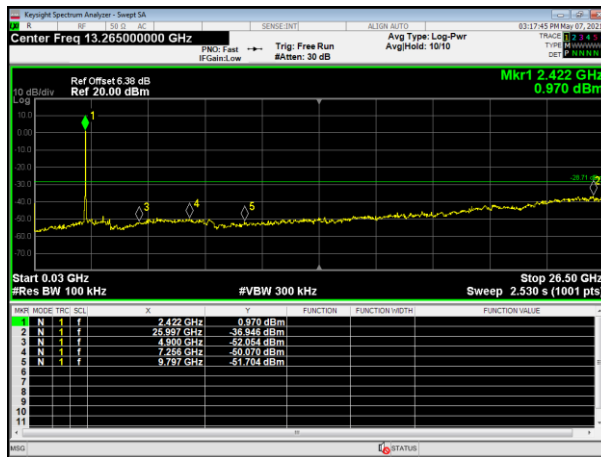

Middle channel

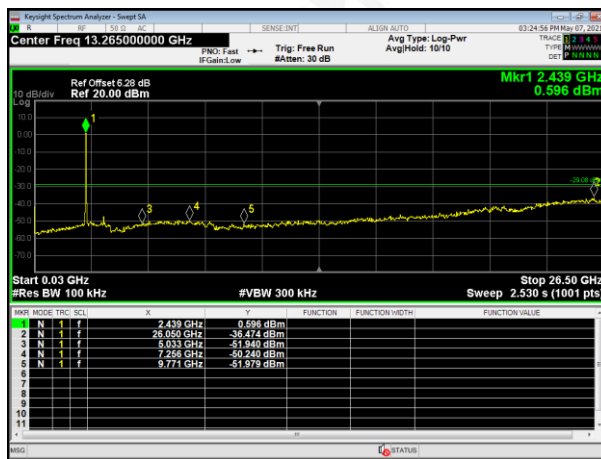

Highest channel

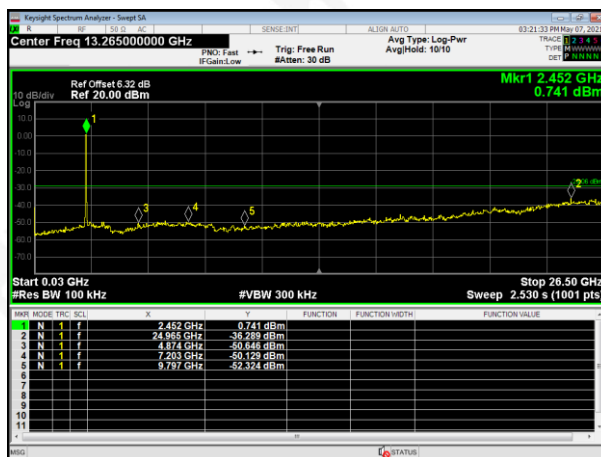

10. ANTENNA REQUIREMENT

Standard requirement:	FCC Part15 C Section 15.203 /247(c)
<p>15.203 requirement: An intentional radiator shall be designed to ensure that no antenna other than that furnished by the responsible party shall be used with the device. The use of a permanently attached antenna or of an antenna that uses a unique coupling to the intentional radiator, the manufacturer may design the unit so that a broken antenna can be replaced by the user, but the use of a standard antenna jack or electrical connector is prohibited.</p> <p>15.247(c) (1)(i) requirement: (i) Systems operating in the 2400-2483.5 MHz band that is used exclusively for fixed. Point-to-point operations may employ transmitting antennas with directional gain greater than 6dBi provided the maximum conducted output power of the intentional radiator is reduced by 1 dB for every 3 dB that the directional gain of the antenna exceeds 6dBi.</p>	
EUT Antenna:	
The antennas are External antenna, the best case gain of the antennas are 3.5dBi, reference to the appendix II for details	

11. TEST SETUP PHOTO

Reference to the appendix I for details.

12. EUT CONSTRUCTIONAL DETAILS

Reference to the appendix II for details.

***** END OF REPORT *****