

# FCC and ISED Test Report

SECO S.p.A.

Wireless Network Device, Model: SYS-C60-LMC1

In accordance with FCC 47 CFR Part 15C, ISED  
RSS-247 and ISED RSS-GEN (2.4 GHz WLAN)

Prepared for: La Marzocco  
Via La Torre 14/H  
Loc. La Torre  
50038  
Scarperia (FI)  
Italy



Add value.  
Inspire trust.

FCC ID: 2AZUJ-SYS-C60-LMC1 IC: 27093-SYSC60LMC1

## COMMERCIAL-IN-CONFIDENCE

Document 75951487-06 Issue 01

### SIGNATURE

NAME	JOB TITLE	RESPONSIBLE FOR	ISSUE DATE
Steve Marshall	Senior Engineer	Authorised Signatory	10 June 2021

Signatures in this approval box have checked this document in line with the requirements of TÜV SÜD document control rules.

### ENGINEERING STATEMENT

The measurements shown in this report were made in accordance with the procedures described on test pages. All reported testing was carried out on a sample equipment to demonstrate limited compliance with FCC 47 CFR Part 15C, ISED RSS-247 and ISED RSS-GEN. The sample tested was found to comply with the requirements defined in the applied rules.

RESPONSIBLE FOR	NAME	DATE	SIGNATURE
Testing	Anthony Hubbard	10 June 2021	

FCC Accreditation  
90987 Octagon House, Fareham Test Laboratory

ISED Accreditation  
12669A Octagon House, Fareham Test Laboratory

### EXECUTIVE SUMMARY

A sample of this product was tested and found to be compliant with FCC 47 CFR Part 15C: 2019, ISED RSS-247: Issue 2 (02-2017) ISED RSS-GEN: Issue 5 (04-2018) + A1 (03-2019) for the tests detailed in section 1.3.



### DISCLAIMER AND COPYRIGHT

This non-binding report has been prepared by TÜV SÜD with all reasonable skill and care. The document is confidential to the potential Client and TÜV SÜD. No part of this document may be reproduced without the prior written approval of TÜV SÜD. © 2021 TÜV SÜD. This report relates only to the actual item/items tested.

### ACCREDITATION

Our UKAS Accreditation does not cover opinions and interpretations and any expressed are outside the scope of our UKAS Accreditation. Results of tests not covered by our UKAS Accreditation Schedule are marked NUA (Not UKAS Accredited).

TÜV SÜD  
is a trading name of TÜV SÜD Ltd  
Registered in Scotland at East Kilbride,  
Glasgow G75 0QF, United Kingdom  
Registered number: SC215164

TÜV SÜD Ltd is a  
TÜV SÜD Group Company

Phone: +44 (0) 1489 558100  
Fax: +44 (0) 1489 558101  
[www.tuvsud.com/en](http://www.tuvsud.com/en)

TÜV SÜD  
Octagon House  
Concorde Way  
Fareham  
Hampshire PO15 5RL  
United Kingdom



## Contents

<b>1</b>	<b>Report Summary .....</b>	<b>2</b>
1.1	Report Modification Record.....	2
1.2	Introduction.....	2
1.3	Brief Summary of Results .....	3
1.4	Application Form .....	4
1.5	Product Information .....	7
1.6	Deviations from the Standard.....	7
1.7	EUT Modification Record .....	7
1.8	Test Location .....	7
<b>2</b>	<b>Test Details .....</b>	<b>8</b>
2.1	Spurious Radiated Emissions .....	8
2.2	ERP/EIRP Verification.....	19
<b>3</b>	<b>Measurement Uncertainty .....</b>	<b>21</b>



# 1 Report Summary

## 1.1 Report Modification Record

Alterations and additions to this report will be issued to the holders of each copy in the form of a complete document.

Issue	Description of Change	Date of Issue
1	First Issue	10 June 2021

**Table 1**

## 1.2 Introduction

Applicant	La Marzocco
Manufacturer	SECO S.p.A.
Model Number(s)	SYS-C60-LMC1
Serial Number(s)	210151871
Hardware Version(s)	SYS-C60-LMC1
Software Version(s)	HEDGEHOG 1.0
Number of Samples Tested	1
Test Specification/Issue/Date	FCC 47 CFR Part 15C: 2019 ISED RSS-247: Issue 2 (02-2017) ISED RSS-GEN: Issue 5 (04-2018) + A1 (03-2019)
Order Number	200057729
Date	24-February-2021
Date of Receipt of EUT	03-March-2021
Start of Test	10-March-2021
Finish of Test	13-March-2021
Name of Engineer(s)	Anthony Hubbard
Related Document(s)	ANSI C63.4 (2014) ANSI C63.10 (2013) KDB 996369 D04 Module Integration Guide v02



### 1.3 Brief Summary of Results

A brief summary of the tests carried out in accordance with FCC 47 CFR Part 15C, ISED RSS-247 and ISED RSS-GEN is shown below.

Section	Specification Clause			Test Description	Result	Comments/Base Standard
	Part 15C	RSS-247	RSS-GEN			
Configuration and Mode: 2.4 GHz WLAN						
2.1	15.247 (d) and 15.205	3.3 and 5.5	6.13	Spurious Radiated Emissions	Pass	Measurements as per KDB 996369 D04, clause 3.4 only.
2.2	15.247 (b)	5.4	6.12	ERP/EIRP Verification	Pass	Measurements as per KDB 996369 D04, clause 3.4 only.

**Table 2**



## 1.4 Application Form

### Equipment Description

Technical Description: <i>(Please provide a brief description of the intended use of the equipment including the technologies the product supports)</i>	Wireless Network device equipped with one Dual-Band Module–Wi-Fi, Bluetooth, and Bluetooth Low Energy (LE) and one LTE, WCDMA, GSM module.
Manufacturer:	SECO S.p.A. Via Achille Grandi, 20 - 52100 Arezzo, ITALY
Model:	SYS-C60-LMC1
Part Number:	
Hardware Version:	SYS-C60-LMC1
Software Version:	HEDGEHOG 1.0
FCC ID of the product under test – <a href="#">see guidance here</a>	2AZUJ-SYS-C60-LMC1
IC ID of the product under test – <a href="#">see guidance here</a>	27093-SYSC60LMC1

**Table 3**

### Intentional Radiators

Technology	BT	WiFi	LTE FDD Band 12	GSM 850 /WCDMA FDD V / LTE FDD Band 5	LTE FDD Band 4	PCS1900 / WCDMA FDD II / LTE FDD Band 2	LTE FDD Band 7
Frequency Range (MHz to MHz)	2400-2483.5	2400-2483.5 5150-5250, 5250-5350, 5470-5725, 5725-5850	699-716	824-849	1710-1755	1850-1910	2500-2570
Conducted Declared Output Power (dBm)	11,7	17.3/18	25	35/25	25	32/25	25
Antenna Gain (dBi)	2.7	1.6	1.3	2.8	0.3	2.9	0.3
Supported Bandwidth(s) (MHz) (e.g 1 MHz, 20 MHz, 40 MHz)	1	20, 40, 80	1.4, 3, 5, 10	0.2	1.4, 3, 5, 10, 15, 20	0.2, 1.4, 3, 5, 10, 15, 20	5, 10, 15, 20
Modulation Scheme(s) (e.g GFSK, QPSK etc)	GFSK, $\pi/4$ DQPSK, 8DPSK	DSSS/ OFDM	QPSK/ QAM	GMSK/ QPSK/ QAM	QPSK/ QAM	GMSK/ QPSK/ QAM	QPSK/ QAM
ITU Emission Designator ( <a href="#">see guidance here</a> )	1M00GD	20M0GD	1M40GD 3M00GD 5M00GD 10M0GD	200KGD 1M40GD 3M00GD 5M00GD 10M0GD	1M40GD 3M00GD 5M00GD 10M0GD 15M0GD 20M0GD	200KGD 1M40GD 3M00GD 5M00GD 10M0GD 15M0GD 20M0GD	5M00GD 10M0GD 15M0GD 20M0GD
Bottom Frequency (MHz)	2402	5180	699.7	824.2	1710.7	1850.2	2502.5
Middle Frequency (MHz)	2440	5500	707.5	836.6	1732.6	1950.0	2535.0
Top Frequency (MHz)	2480	5825	715.3	848.8	1754.3	1909.8	2567.5

**Table 4**



Un-intentional Radiators

Highest frequency generated or used in the device or on which the device operates or tunes	1 GHz
Lowest frequency generated or used in the device or on which the device operates or tunes	32.768 kHz
Class A Digital Device (Use in commercial, industrial or business environment) <input type="checkbox"/>	
Class B Digital Device (Use in residential environment only) <input checked="" type="checkbox"/>	

**Table 5**

DC Power Source

Nominal voltage:	24	V
Extreme upper voltage:	25.2	V
Extreme lower voltage:	22.8	V
Max current:	0.5	A

**Table 6**

Charging

Can the EUT transmit whilst being charged	Yes <input checked="" type="checkbox"/> No <input type="checkbox"/>
---	---

**Table 7**

Temperature

Minimum temperature:	5	°C
Maximum temperature:	32	°C

**Table 8**



Antenna Characteristics

Antenna connector <input checked="" type="checkbox"/> Type: SMA MALE RP			State impedance	50	Ohm
Temporary antenna connector <input type="checkbox"/>			State impedance		Ohm
Integral antenna <input type="checkbox"/>	Type:		Gain		dBi
External antenna <input checked="" type="checkbox"/>	Type:	Dipole	Gain	2.9 dBi (@1900MHz)	dBi
For external antenna only: Standard Antenna Jack <input type="checkbox"/> If yes, describe how user is prohibited from changing antenna (if not professional installed): Equipment is only ever professionally installed <input checked="" type="checkbox"/> Non-standard Antenna Jack <input checked="" type="checkbox"/>					

**Table 9**

Ancillaries (if applicable)

Manufacturer:		Part Number:	
Model:		Country of Origin:	

**Table 10**

I hereby declare that the information supplied is correct and complete.

Name: Tommaso Berna

Position held: Testing Manager

Date: 30-Mar-2021



**1.5 Product Information**

**1.5.1 Technical Description**

Wireless Network device equipped with one Dual-Band Module–Wi-Fi, Bluetooth, and Bluetooth Low Energy (LE) and one LTE, WCDMA, GSM module.

**1.6 Deviations from the Standard**

No deviations from the applicable test standard were made during testing.

**1.7 EUT Modification Record**

The table below details modifications made to the EUT during the test programme.

The modifications incorporated during each test are recorded on the appropriate test pages.

Modification State	Description of Modification still fitted to EUT	Modification Fitted By	Date Modification Fitted
Model: SYS-C60-LMC1, Serial Number: 210151871			
0	As supplied by the customer	Not Applicable	Not Applicable

**Table 11**

**1.8 Test Location**

TÜV SÜD conducted the following tests at our Fareham Test Laboratory.

Test Name	Name of Engineer(s)	Accreditation
Configuration and Mode: 2.4 GHz WLAN		
Spurious Radiated Emissions	Anthony Hubbard	UKAS
ERP/EIRP Verification	Anthony Hubbard	UKAS

**Table 12**

Office Address:

TÜV SÜD  
Octagon House  
Concorde Way  
Fareham  
Hampshire  
PO15 5RL  
United Kingdom





## 2 Test Details

### 2.1 Spurious Radiated Emissions

#### 2.1.1 Specification Reference

FCC 47 CFR Part 15C, Clause 15.247 (d) and 15.205  
ISED RSS-247, Clause 3.3  
ISED RSS-GEN, Clause 6.13

#### 2.1.2 Equipment Under Test and Modification State

SYS-C60-LMC1, S/N: 210151871 - Modification State 0

#### 2.1.3 Date of Test

10-March-2021 to 11-March-2021

#### 2.1.4 Test Method

This test was performed in accordance with ANSI C63.10, clause 6.3, 6.5 and 6.6. Measurements were only performed over the frequency range specified in FCC Part 15.35(b) as required by KDB 996369 D04, clause 3.4. In addition, measurements were only performed on the worst case channel and modulation as identified in the modular test report.

The EUT was placed on the non-conducting platform in a manner typical of a normal installation. Ports on the EUT were terminated with loads as described in ANSI C63.4 clause 6.2.4.

For frequencies > 1 GHz, plots for average measurements were taken in accordance with ANSI C63.10, clause 4.1.4.2.5 to characterize the EUT. Where emissions were detected, final average measurements were taken in accordance with ANSI C63.10, clause 4.1.4.2.2.

The plots shown are the characterisation of the EUT. The limits on the plots represent the most stringent case for restricted bands, (74/54 dBuV/m) when compared to 20 dBc outside restricted bands. The limits shown have been used as a threshold to determine where further measurements are necessary. Where results are within 10 dB of the limits shown on the plots, further investigation was carried out and reported in results tables.

The following conversion can be applied to convert from dB $\mu$ V/m to  $\mu$ V/m:  
 $10^{(\text{Field Strength in dB}\mu\text{V/m}/20)}$ .

Where formal measurements have been necessary, the results have been presented in the emissions table.

### 2.1.5 Example Test Setup Diagram

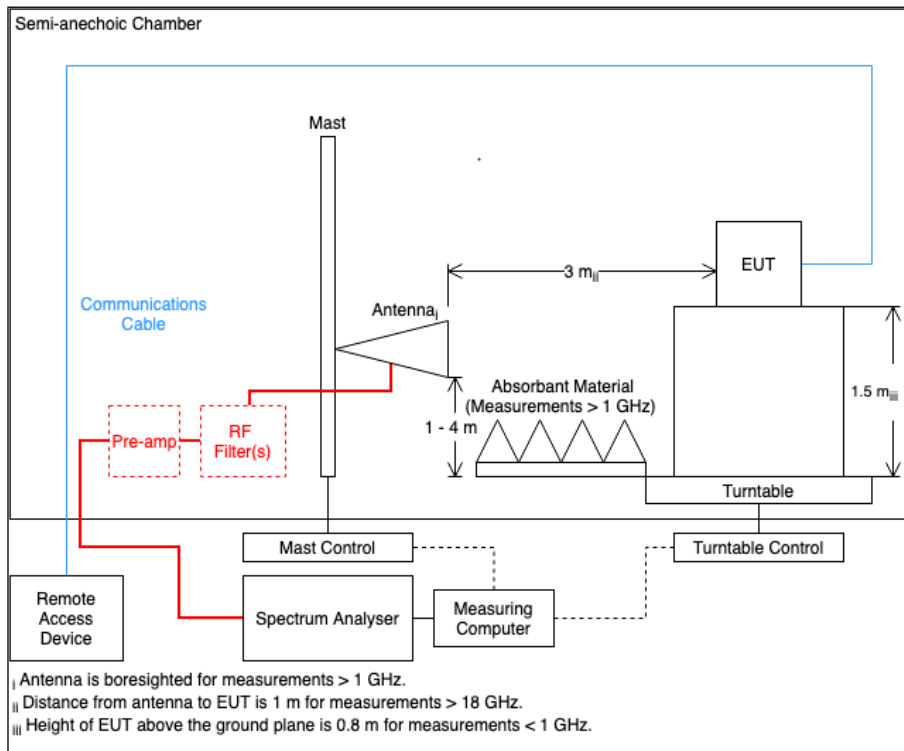


Figure 1

### 2.1.6 Environmental Conditions

Ambient Temperature 22.4 °C  
Relative Humidity 29.5 %



**2.1.7 Test Results**

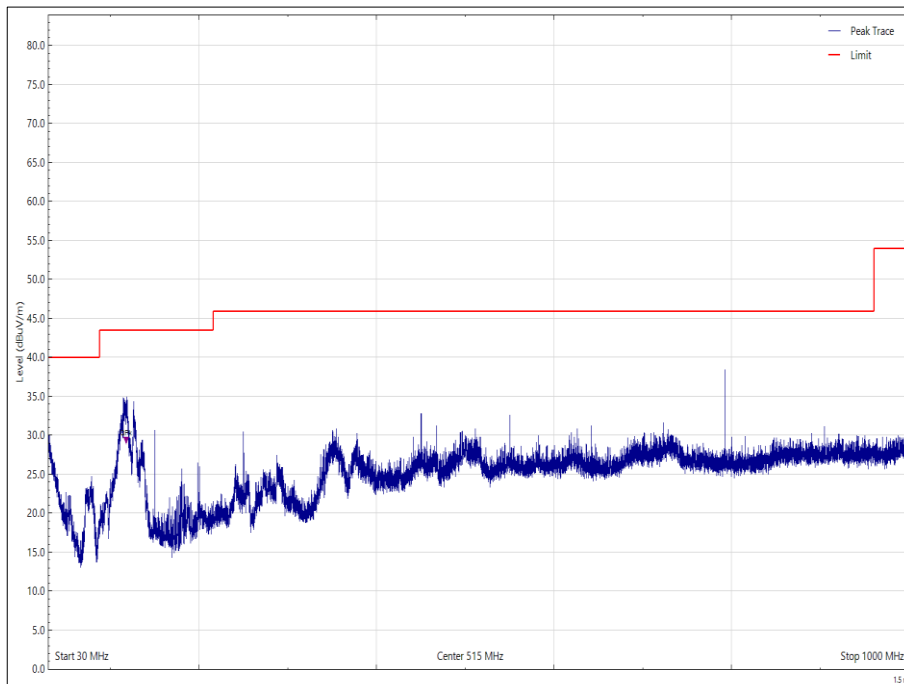
2.4 GHz WLAN

Testing was performed on the configurations and Data Rate which resulted in the highest conducted output power and highest power spectral density as stated in ANSI C63.10, clause 5.6.2.2 (b). The Data Rate used during testing was 6 Mbps.

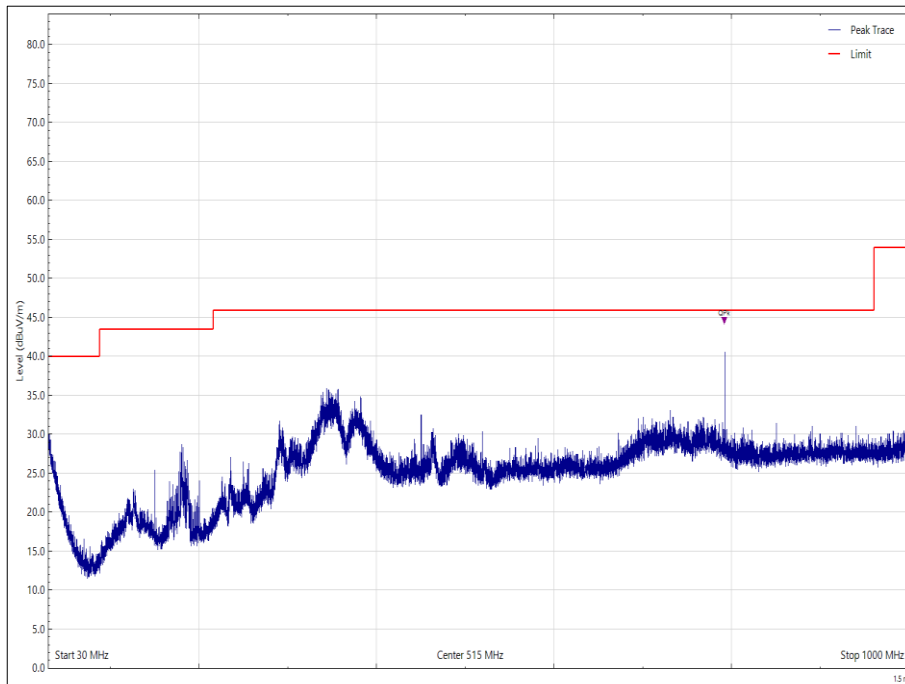
Frequency (MHz)	Level (dBµV/m)	Limit (dBµV/m)	Margin (dB)	Detector	Angle (°)	Height (cm)	Polarisation	Orientation
118.098	28.65	46.00	-17.35	Q-Peak	356	110	Vertical	-
791.992	43.96	46.00	-2.04	Q-Peak	220	102	Horizontal	-

**Table 13 - 2412 MHz, 30 MHz to 1 GHz**

No other emissions were detected within 10 dB of the limit.



**Figure 2 - 2412 MHz, 30 MHz to 1 GHz, Vertical**



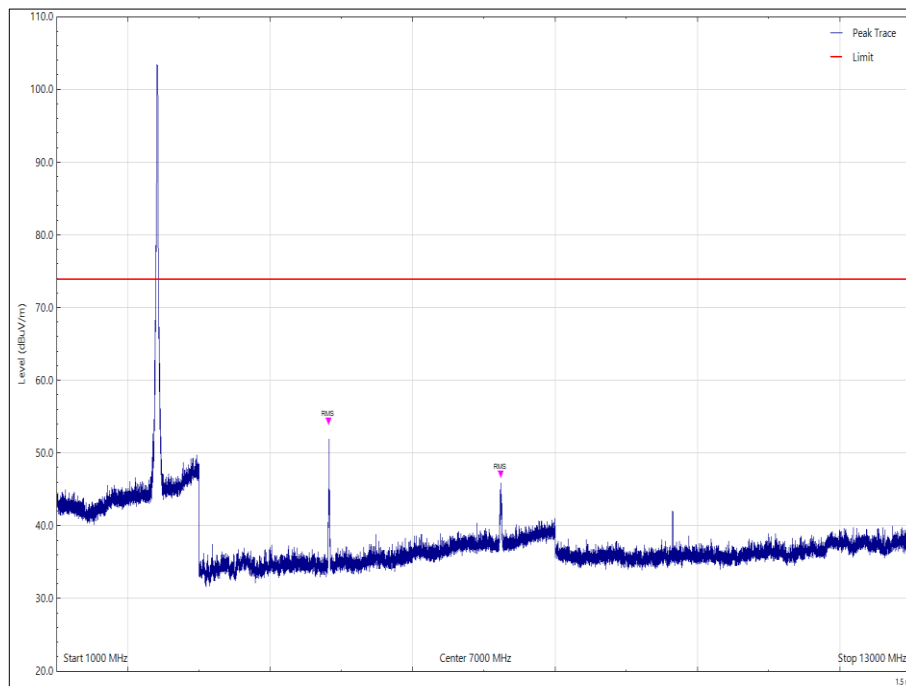
**Figure 3 - 2412 MHz, 30 MHz to 1 GHz, Horizontal**



Frequency (MHz)	Level (dBµV/m)	Limit (dBµV/m)	Margin (dB)	Detector	Angle (°)	Height (cm)	Polarisation	Orientation
4824.040	53.61	53.98	-0.37	RMS	181	110	Vertical	-
4824.118	49.79	53.98	-4.19	RMS	111	100	Horizontal	-
7240.269	46.41	53.98	-7.57	RMS	177	224	Vertical	-

**Table 14 - 2412 MHz, 1 GHz to 13 GHz**

No other emissions were detected within 10 dB of the limit.



**Figure 4 - 2412 MHz, 1 GHz to 13 GHz, Vertical - Peak**

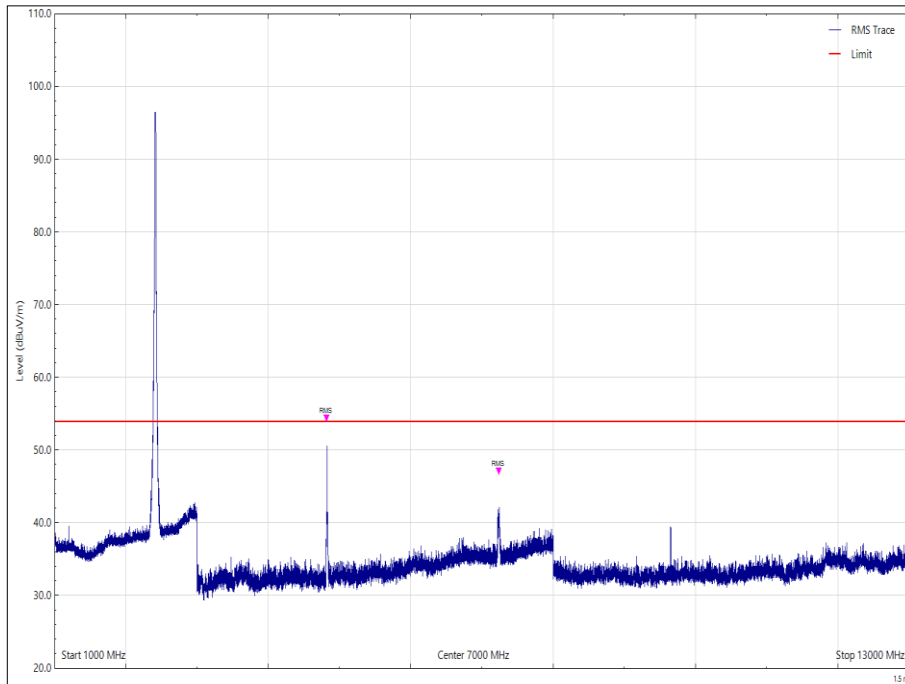


Figure 5 - 2412 MHz, 1 GHz to 13 GHz, Vertical - Average

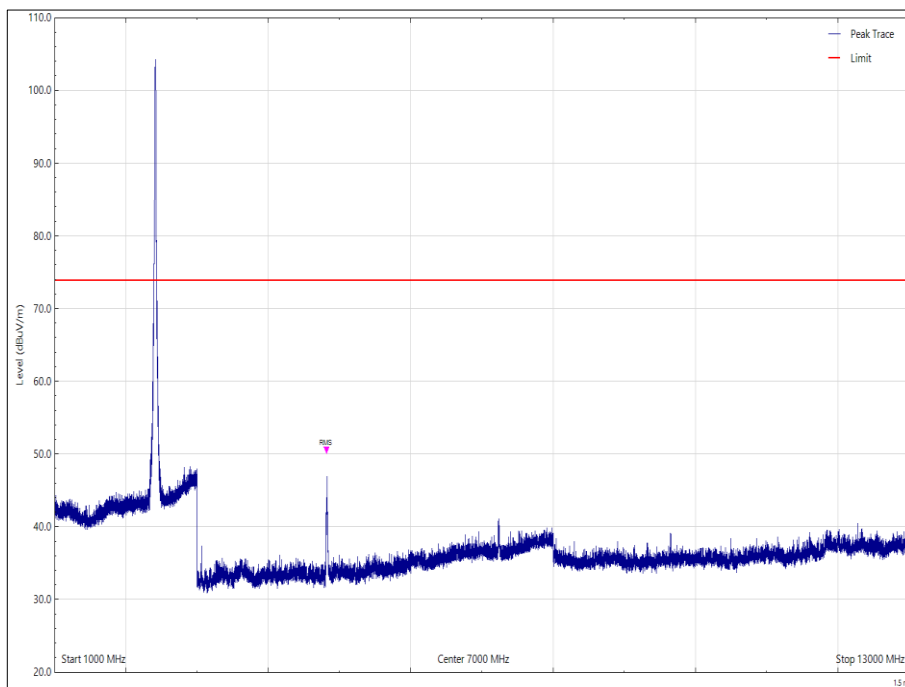
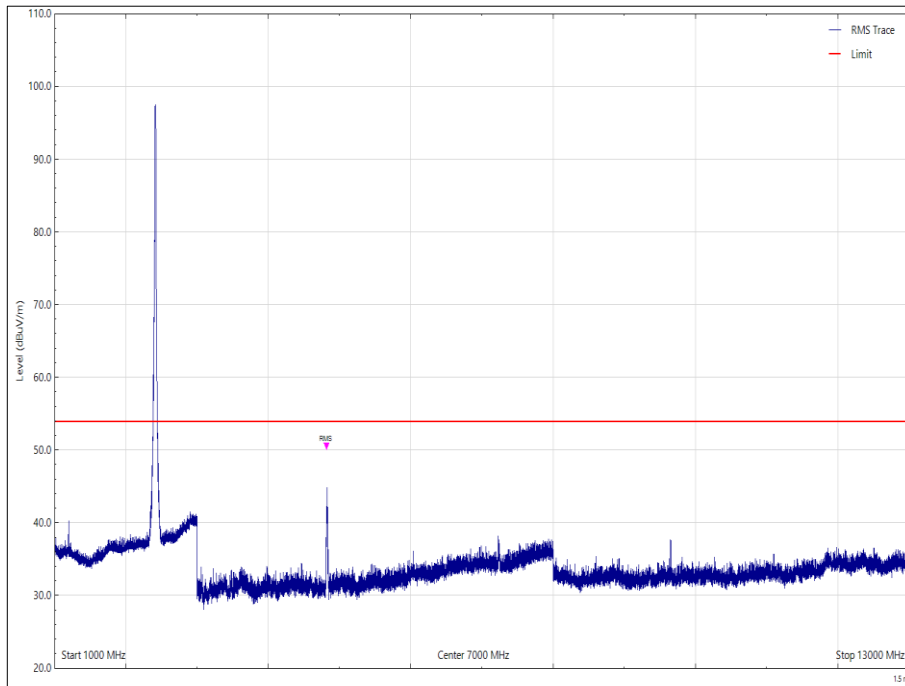
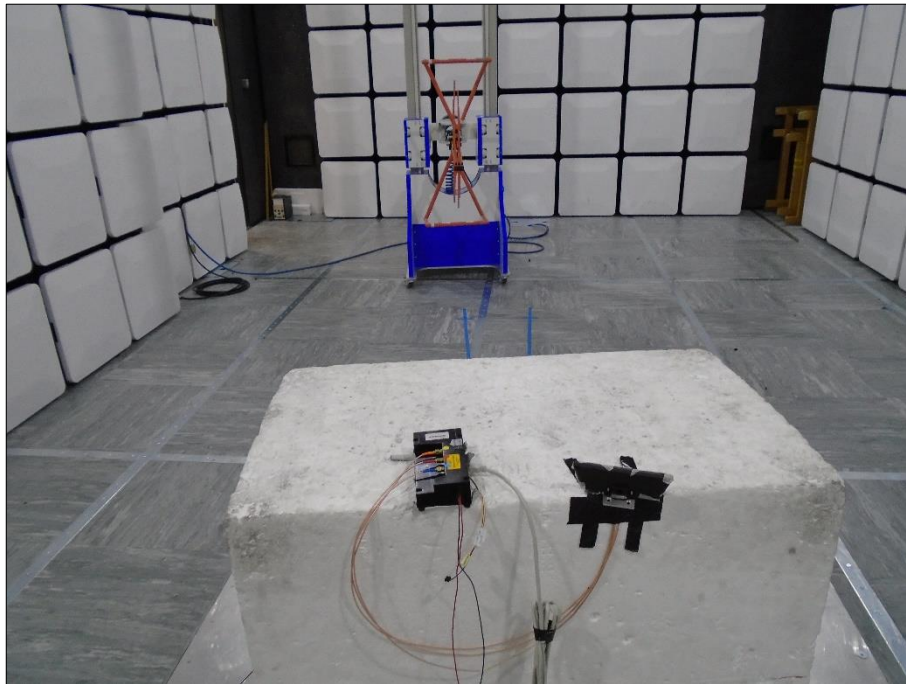


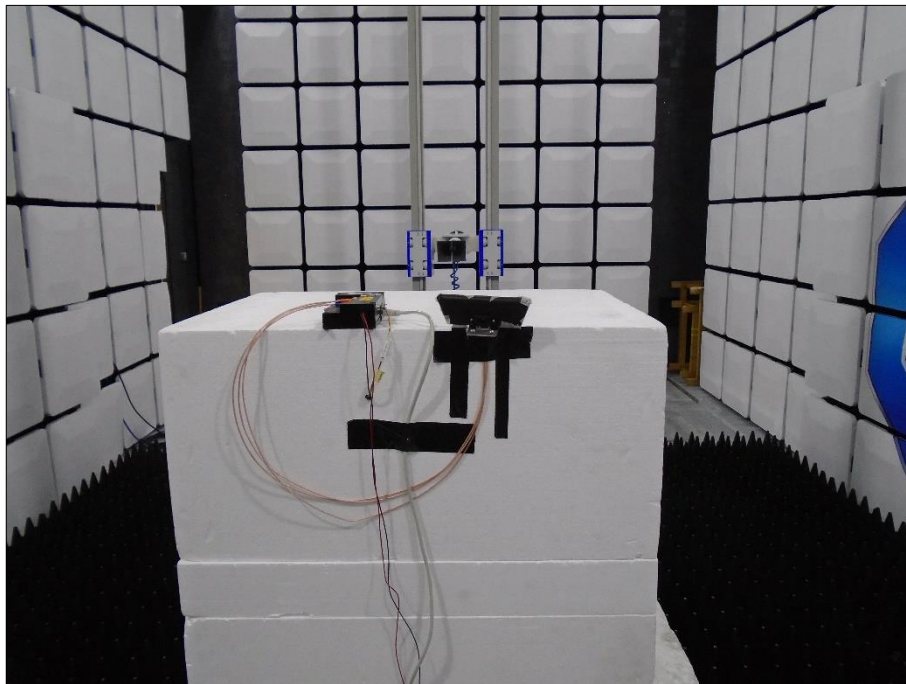
Figure 6 - 2412 MHz, 1 GHz to 13 GHz, Horizontal - Peak



**Figure 7 - 2412 MHz, 1 GHz to 13 GHz, Horizontal - Average**

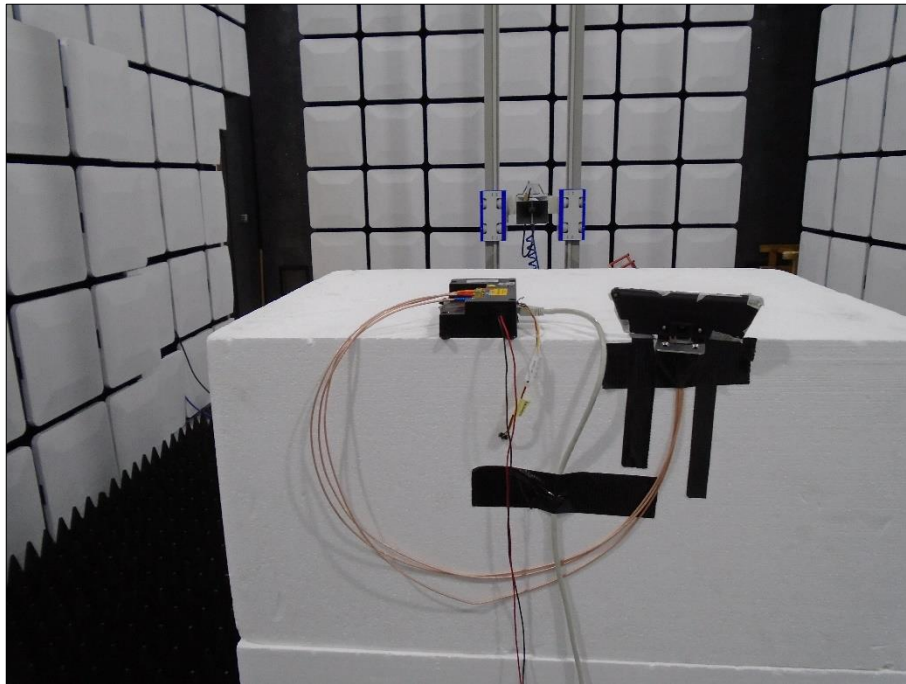


**Figure 8 - Test Setup - 30 MHz to 1 GHz**

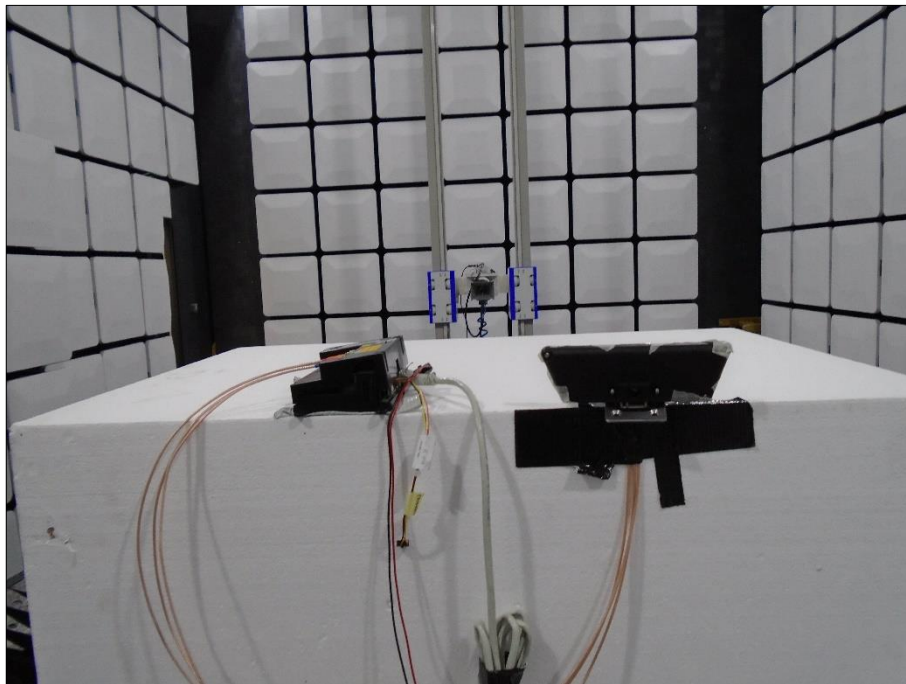


**Figure 9 - Test Setup - 1 GHz to 3 GHz**





**Figure 10 - Test Setup - 3 GHz to 8 GHz**



**Figure 11 - Test Setup - 8 GHz to 13 GHz**



FCC 47 CFR Part 15, Limit Clause 15.247 (d)

In any 100 kHz bandwidth outside the frequency band in which the spread spectrum or digitally modulated intentional radiator is operating, the radio frequency power that is produced by the intentional radiator shall be at least 20 dB below that in the 100 kHz bandwidth within the band that contains the highest level of the desired power, based on either an RF conducted or a radiated measurement, provided the transmitter demonstrates compliance with the peak conducted power limits. If the transmitter complies with the conducted power limits based on the use of RMS averaging over a time interval, as permitted under paragraph (b)(3) of this section, the attenuation required under this paragraph shall be 30 dB instead of 20 dB.

Attenuation below the general limits specified in § 15.209(a) is not required. In addition, radiated emissions which fall in the restricted bands, as defined in § 15.205(a), must also comply with the radiated emission limits specified in 15.209(a)

ISED RSS-247, Limit Clause 5.5

In any 100 kHz bandwidth outside the frequency band in which the spread spectrum or digitally modulated device is operating, the RF power that is produced shall be at least 20 dB below that in the 100 kHz bandwidth within the band that contains the highest level of the desired power, based on either an RF conducted or a radiated measurement, provided that the transmitter demonstrates compliance with the peak conducted power limits. If the transmitter complies with the conducted power limits based on the use of root-mean-square averaging over a time interval, as permitted under Section 5.4(4), the attenuation required shall be 30 dB instead of 20 dB. Attenuation below the general field strength limits specified in RSS-Gen is not required.



### 2.1.8 Test Location and Test Equipment Used

This test was carried out in EMC Chamber 12.

Instrument	Manufacturer	Type No	TE No	Calibration Period (months)	Calibration Expires
Antenna with permanent attenuator (Bilog)	Schaffner	CBL6143	287	24	14-Oct-2022
Pre-Amplifier, (8 GHz to 18 GHz)	Phase One	PS04-0086	1533	12	05-Feb-2022
Power Supply	Hewlett Packard	6104A	1948	-	O/P Mon
Multimeter	Fluke	177	3833	12	14-Dec-2021
EmX Emissions Software	TUV SUD	V2.1.1	5125	-	Software
Preamplifier (30dB 1GHz to 18GHz)	Schwarzbeck	BBV 9718 C	5350	12	21-Sep-2021
EMI Test Receiver	Rohde & Schwarz	ESW44	5382	12	18-Feb-2022
3.5 mm 1m Cable	Junkosha	MWX221-01000DMS	5418	12	22-Jun-2021
3.5 mm 2m Cable	Junkosha	MWX221-02000DMS	5428	12	15-Oct-2021
Thermo-Hygro-Barometer	PCE Instruments	PCE-THB-40	5481	12	18-Mar-2021
1m -SMA Cabl have added in 1948 and 3833 le	Junkosha	MWX221-01000AMSAMS/A	5514	12	01-Apr-2021
1m -SMA Cable	Junkosha	MWX221-01000AMSAMS/A	5515	12	01-Apr-2021
8m N Type Cable	Junkosha	MWX221-08000NMSNMS/B	5519	12	24-Mar-2021
3 GHz High pass Filter	Wainwright	WHKX12-2580-3000-18000-80SS	5548	12	05-May-2021
DRG Horn Antenna (7.5-18GHz)	Schwarzbeck	HWRD750	5610	12	22-Sep-2021
Broadband Horn Antenna (1-10 GHz)	Schwarzbeck	BBHA 9120 B	5611	12	22-Sep-2021
Turntable & Mast Controller	Maturo Gmbh	NCD/498/2799.01	5612	-	TU
Tilt Antenna Mast TAM 4.0-P	Maturo Gmbh	TAM 4.0-P	5613	-	TU
Turntable	Maturo Gmbh	Turntable 1.5 SI-2t	5614	-	TU
3m Semi Anechoic Chamber	MVG	EMC-3	5621	36	11-Aug-2023

Table 15

TU - Traceability Unscheduled



**2.2 ERP/EIRP Verification**

**2.2.1 Specification Reference**

FCC 47 CFR Part 15C, Clause 15.247 (b)  
ISED RSS-247, Clause 5.4  
ISED RSS-GEN, Clause 6.12

**2.2.2 Equipment Under Test and Modification State**

SYS-C60-LMC1, S/N: 210151871 - Modification State 0

**2.2.3 Date of Test**

13-March-2021

**2.2.4 Test Method**

The following test was performed to check the fundamental of the integrated module was not adversely affected when integrated into the host device as required by KDB 996369 D04, clause 3.4.

This test was performed in accordance with ANSI C63.10 clause 6.3 and clause 11.9.2.2.5 (AVGSA-2A).

**2.2.5 Environmental Conditions**

Ambient Temperature 21.7 °C  
Relative Humidity 34.0 %

**2.2.6 Test Results**

2.4 GHz WLAN

The worst-case mode was identified as:

22 MHz Bandwidth, 2412 MHz (CH1), 802.11g, 6 Mbps

Frequency (MHz)	Result	Limit	Unit
2412	12.43	34.80	dBm

**Table 16 - EIRP Verification Results**



**2.2.7 Test Location and Test Equipment Used**

This test was carried out in EMC Chamber 12.

Instrument	Manufacturer	Type No	TE No	Calibration Period (months)	Calibration Expires
Power Supply	Hewlett Packard	6104A	1948	-	O/P Mon
Multimeter	Fluke	177	3833	12	14-Dec-2021
EmX Emissions Software	TUV SUD	V2.1.1	5125	-	Software
EMI Test Receiver	Rohde & Schwarz	ESW44	5382	12	18-Feb-2022
3.5 mm 2m Cable	Junkosha	MWX221-02000DMS	5428	12	15-Oct-2021
Thermo-Hygro-Barometer	PCE Instruments	PCE-THB-40	5481	12	18-Mar-2021
8m N Type Cable	Junkosha	MWX221-08000NMSNMS/B	5519	12	24-Mar-2021
Broadband Horn Antenna (1-10 GHz)	Schwarzbeck	BBHA 9120 B	5611	12	22-Sep-2021
Turntable & Mast Controller	Maturo Gmbh	NCD/498/2799.01	5612	-	TU
Tilt Antenna Mast TAM 4.0-P	Maturo Gmbh	TAM 4.0-P	5613	-	TU
Turntable	Maturo Gmbh	Turntable 1.5 SI-2t	5614	-	TU
3m Semi Anechoic Chamber	MVG	EMC-3	5621	36	11-Aug-2023

**Table 17**

TU - Traceability Unscheduled



### 3 Measurement Uncertainty

For a 95% confidence level, the measurement uncertainties for defined systems are:

Test Name	Measurement Uncertainty
Spurious Radiated Emissions	30 MHz to 1 GHz: $\pm 5.2$ dB 1 GHz to 40 GHz: $\pm 6.3$ dB
ERP/EIRP Verification	$\pm 3.2$ dB

**Table 18**

#### Measurement Uncertainty Decision Rule

Determination of conformity with the specification limits is based on the decision rule according to IEC Guide 115: 2007, clause 4.4.3 and 4.5.1.