

FCC and ISED Test Report

SECO S.p.A.

Wireless Network Device, Model: SYS-C60-LMC1

In accordance with FCC 47 CFR Part 2, FCC 47 CFR Part 24, ISED RSS-133 and ISED RSS-GEN

Prepared for: La Marzocco
Via La Torre 14/H
Loc. La Torre
50038
Scarperia (FI)
Italy



Add value.
Inspire trust.

FCC ID: 2AZUJ-SYS-C60-LMC1 IC: 27093-SYSC60LMC1

COMMERCIAL-IN-CONFIDENCE

Document 75951487-03 Issue 01

SIGNATURE

NAME	JOB TITLE	RESPONSIBLE FOR	ISSUE DATE
Steve Marshall	Senior Engineer	Authorised Signatory	10 June 2021

Signatures in this approval box have checked this document in line with the requirements of TÜV SÜD document control rules.

ENGINEERING STATEMENT

The measurements shown in this report were made in accordance with the procedures described on test pages. All reported testing was carried out on a sample equipment to demonstrate limited compliance with FCC 47 CFR Part 2, FCC CFR Part 24, ISED RSS-133 and ISED RSS-GEN . The sample tested was found to comply with the requirements defined in the applied rules.

RESPONSIBLE FOR	NAME	DATE	SIGNATURE
Testing	Graeme Lawler	10 June 2021	

FCC Accreditation
90987 Octagon House, Fareham Test Laboratory

ISED Accreditation
12669A Octagon House, Fareham Test Laboratory

EXECUTIVE SUMMARY

A sample of this product was tested and found to be compliant with FCC 47 CFR Part 2: 2019, FCC 47 CFR Part 24: 2019 and ISED RSS-133 Issue 6 + A1 (2018-01) and RSS-GEN Issue 5 (2018-04) + A1 (2019-03) for the tests detailed in section 1.3.



DISCLAIMER AND COPYRIGHT

This non-binding report has been prepared by TÜV SÜD with all reasonable skill and care. The document is confidential to the potential Client and TÜV SÜD. No part of this document may be reproduced without the prior written approval of TÜV SÜD. © 2021 TÜV SÜD. This report relates only to the actual item/items tested.

ACCREDITATION

Our UKAS Accreditation does not cover opinions and interpretations and any expressed are outside the scope of our UKAS Accreditation. Results of tests not covered by our UKAS Accreditation Schedule are marked NUA (Not UKAS Accredited).

TÜV SÜD
is a trading name of TÜV SÜD Ltd
Registered in Scotland at East Kilbride,
Glasgow G75 0QF, United Kingdom
Registered number: SC215164

TÜV SÜD Ltd is a
TÜV SÜD Group Company

Phone: +44 (0) 1489 558100
Fax: +44 (0) 1489 558101
www.tuvsud.com/en

TÜV SÜD
Octagon House
Concorde Way
Fareham
Hampshire PO15 5RL
United Kingdom



Contents

1	Report Summary	2
1.1	Report Modification Record.....	2
1.2	Introduction.....	2
1.3	Brief Summary of Results	3
1.4	Application Form	4
1.5	Product Information	6
1.6	Deviations from the Standard.....	6
1.7	EUT Modification Record	6
1.8	Test Location	6
2	Test Details	7
2.1	Radiated Spurious Emissions	7
2.2	ERP/EIRP Verification.....	15
3	Photographs	18
3.1	Test Setup Photographs	18
4	Measurement Uncertainty	20



1 Report Summary

1.1 Report Modification Record

Alterations and additions to this report will be issued to the holders of each copy in the form of a complete document.

Issue	Description of Change	Date of Issue
1	First Issue	09-June-2021

Table 1

1.2 Introduction

Applicant	La Marzocco
Manufacturer	SECO S.p.A.
Model Number(s)	SYS-C60-LMC1
Serial Number(s)	210151871
Hardware Version(s)	SYS-C60-LMC1
Software Version(s)	HEDGEHOG 1.0
Number of Samples Tested	1
Test Specification/Issue/Date	FCC CFR Part 2: 2019 FCC 47 CFR Part 24: 2019 ISED RSS-133: Issue 6 + A1 (2018-01) ISED RSS-GEN: Issue 5 (2018-04) + A1 (2019-03)
Order Number	200057729
Date	24-February-2021
Date of Receipt of EUT	03-March-2021
Start of Test	07-March-2021
Finish of Test	07-March-2021
Name of Engineer(s)	Graeme Lawler
Related Document(s)	KDB 996369 D04 Module Integration Guide v02 ANSI C63.26: 2015 SRSP-510: Issue 5 (2009-02)



1.3 Brief Summary of Results

A brief summary of the tests carried out in accordance with FCC 47 CFR Part 2, FCC CFR Part 24, ISED RSS-133 and RSS-GEN is shown below.

Section	Specification Clause				Test Description	Result	Comments/Base Standard
	Part 24	Part 2	RSS-133	RSS-GEN			
Configuration and Mode: PCS 1900							
2.1	24.238 (a)	2.1053	6.5	8.9 and 8.10	Radiated Spurious Emissions	Pass	Measurements as per KDB 996369 D04, clause 3.4 only.
2.2	24.232	-	6.4	6.12	ERP/EIRP Verification	Pass	Measurements as per KDB 996369 D04, clause 3.4 only.
Configuration and Mode: WCDMA FDD Band II							
2.1	24.238 (a)	2.1053	6.5	8.9 and 8.10	Radiated Spurious Emissions	Pass	Measurements as per KDB 996369 D04, clause 3.4 only.
2.2	24.232	-	6.4	6.12	ERP/EIRP Verification	Pass	Measurements as per KDB 996369 D04, clause 3.4 only.
Configuration and Mode: LTE FDD Band 2							
2.1	24.238 (a)	2.1053	6.5	8.9 and 8.10	Radiated Spurious Emissions	Pass	Measurements as per KDB 996369 D04, clause 3.4 only.
2.2	24.232	-	6.4	6.12	ERP/EIRP Verification	Pass	Measurements as per KDB 996369 D04, clause 3.4 only.

Table 2



1.4 Application Form

Equipment Description

Technical Description: <i>(Please provide a brief description of the intended use of the equipment including the technologies the product supports)</i>	Wireless Network device equipped with one Dual-Band Module–Wi-Fi, Bluetooth, and Bluetooth Low Energy (LE) and one LTE, WCDMA, GSM module.
Manufacturer:	SECO
Model:	SYS-C60-LMC1
Part Number:	
Hardware Version:	SYS-C60-LMC1
Software Version:	HEDGEHOG 1.0
FCC ID of the product under test – see guidance here	2AZUJ-SYS-C60-LMC1
IC ID of the product under test – see guidance here	27093-SYSC60LMC1

Table 3

Intentional Radiators

Technology	BT	WiFi	LTE FDD Band 12	GSM 850 /WCDMA FDD V / LTE FDD Band 5	LTE FDD Band 4	PCS1900 / WCDMA FDD II / LTE FDD Band 2	LTE FDD Band 7
Frequency Range (MHz to MHz)	2400-2483.5	2400-2483.5 5150-5250, 5250-5350, 5470-5725, 5725-5850	699-716	824-849	1710-1755	1850-1910	2500-2570
Conducted Declared Output Power (dBm)	11,7	17.3/18	25	35/25	25	32/25	25
Antenna Gain (dBi)	2.7	1.6	1.3	2.8	0.3	2.9	0.3
Supported Bandwidth(s) (MHz) (e.g 1 MHz, 20 MHz, 40 MHz)	1	20, 40, 80	1.4, 3, 5, 10	0.2	1.4, 3, 5, 10, 15, 20	0.2, 1.4, 3, 5, 10, 15, 20	5, 10, 15, 20
Modulation Scheme(s) (e.g GFSK, QPSK etc)	GFSK, $\pi/4$ DQPSK, 8DPSK	DSSS/ OFDM	QPSK/ QAM	GMSK/ QPSK/ QAM	QPSK/ QAM	GMSK/ QPSK/ QAM	QPSK/ QAM
ITU Emission Designator (see guidance here)	1M00GD	20M0GD	1M40GD 3M00GD 5M00GD 10M0GD	200KGD 1M40GD 3M00GD 5M00GD 10M0GD	1M40GD 3M00GD 5M00GD 10M0GD 15M0GD 20M0GD	200KGD 1M40GD 3M00GD 5M00GD 10M0GD 15M0GD 20M0GD	5M00GD 10M0GD 15M0GD 20M0GD
Bottom Frequency (MHz)	2402	5180	699.7	824.2	1710.7	1850.2	2502.5
Middle Frequency (MHz)	2440	5500	707.5	836.6	1732.6	1950.0	2535.0
Top Frequency (MHz)	2480	5825	715.3	848.8	1754.3	1909.8	2567.5

Table 4



Un-intentional Radiators

Highest frequency generated or used in the device or on which the device operates or tunes	1 GHz
Lowest frequency generated or used in the device or on which the device operates or tunes	32.768 kHz
Class A Digital Device (Use in commercial, industrial or business environment) <input type="checkbox"/>	
Class B Digital Device (Use in residential environment only) <input checked="" type="checkbox"/>	

Table 5

DC Power Source

Nominal voltage:	24	V
Extreme upper voltage:	25.2	V
Extreme lower voltage:	22.8	V
Max current:	0.5	A

Table 6

Charging

Can the EUT transmit whilst being charged	Yes <input type="checkbox"/> No <input type="checkbox"/>
---	--

Table 7

Temperature

Minimum temperature:	5	°C
Maximum temperature:	32	°C

Table 8

Antenna Characteristics

Antenna connector <input checked="" type="checkbox"/> Type: SMA MALE RP	State impedance	50	Ohm
Temporary antenna connector <input type="checkbox"/>	State impedance		Ohm
Integral antenna <input type="checkbox"/>	Type:		Gain
External antenna <input checked="" type="checkbox"/>	Type:	Dipole	Gain
For external antenna only: Standard Antenna Jack <input type="checkbox"/> If yes, describe how user is prohibited from changing antenna (if not professional installed): Equipment is only ever professionally installed <input checked="" type="checkbox"/> Non-standard Antenna Jack <input checked="" type="checkbox"/>			

Table 9

Ancillaries (if applicable)

Manufacturer:		Part Number:	
Model:		Country of Origin:	

Table 10

I hereby declare that the information supplied is correct and complete.

Name: Tommaso Berna
 Position held: Testing Manager
 Date: 30/03/2021



1.5 Product Information

1.5.1 Technical Description

Wireless Network device equipped with one Dual-Band Module–Wi-Fi, Bluetooth, and Bluetooth Low Energy(LE) and one LTE, WCDMA,GSM module.

1.6 Deviations from the Standard

No deviations from the applicable test standard were made during testing.

1.7 EUT Modification Record

The table below details modifications made to the EUT during the test programme.

The modifications incorporated during each test are recorded on the appropriate test pages.

Modification State	Description of Modification still fitted to EUT	Modification Fitted By	Date Modification Fitted
Model: SYS-C60-LMC1, Serial Number: 210151871			
0	As supplied by the customer	Not Applicable	Not Applicable

Table 11

1.8 Test Location

TÜV SÜD conducted the following tests at our Fareham Test Laboratory.

Test Name	Name of Engineer(s)	Accreditation
Configuration and Mode: PCS 1900		
Radiated Spurious Emissions	Graeme Lawler	UKAS
ERP/EIRP Verification	Graeme Lawler	UKAS
Configuration and Mode: WCDMA FDD Band II		
Radiated Spurious Emissions	Graeme Lawler	UKAS
ERP/EIRP Verification	Graeme Lawler	UKAS
Configuration and Mode: LTE FDD Band 2		
Radiated Spurious Emissions	Graeme Lawler	UKAS
ERP/EIRP Verification	Graeme Lawler	UKAS

Table 12

Office Address:

TÜV SÜD
 Octagon House
 Concorde Way
 Fareham
 Hampshire
 PO15 5RL
 United Kingdom



2 Test Details

2.1 Radiated Spurious Emissions

2.1.1 Specification Reference

FCC 47 CFR Part 24, Clause 24.238 (a)
FCC CFR Part 2, Clause 2.1053
ISED RSS-133, Clause 6.5
ISED RSS-GEN, Clause 8.9 and 8.10

2.1.2 Equipment Under Test and Modification State

SYS-C60-LMC1, S/N: 210151871 - Modification State 0

2.1.3 Date of Test

07-March-2021

2.1.4 Test Method

A preliminary profile of the Radiated Spurious Emissions was obtained up to the 5th harmonic, as required by KDB 996369 D04, clause 3.2, by operating the EUT on a remotely controlled turntable within a semi-anechoic chamber.

Measurements of emissions from the EUT were obtained with the Measurement Antenna in both Horizontal and Vertical Polarisations. The profiling produced a list of the worst-case emissions together with the EUT azimuth and antenna polarisation.

Testing was performed in accordance with ANSI C63.26, Clause 5.5.

Prescans and final measurements were performed using the direct field strength method.

2.1.1 Example Test Setup Diagram

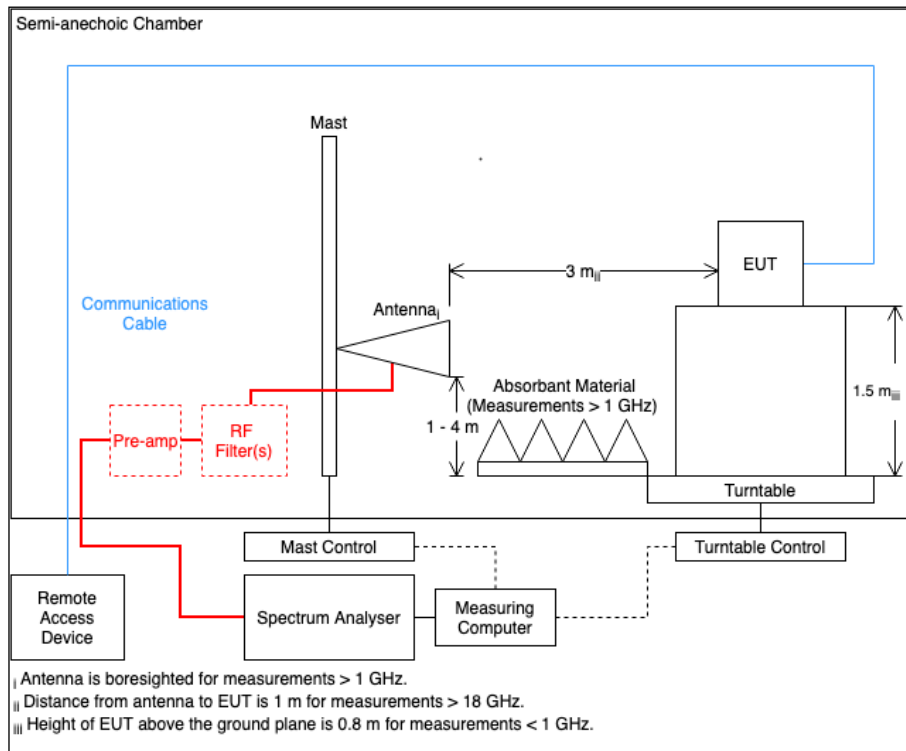

Figure 1

2.1.2 Environmental Conditions

Ambient Temperature 18.2 °C
Relative Humidity 23.9 %



2.1.3 Test Results

PCS 1900

Frequency (MHz)	Level (dBm)	Angle	Height	Polarisation	Orientation
*					

Table 13 - Radiated Emissions Results

*No emissions were detected within 10 dB of the limit.

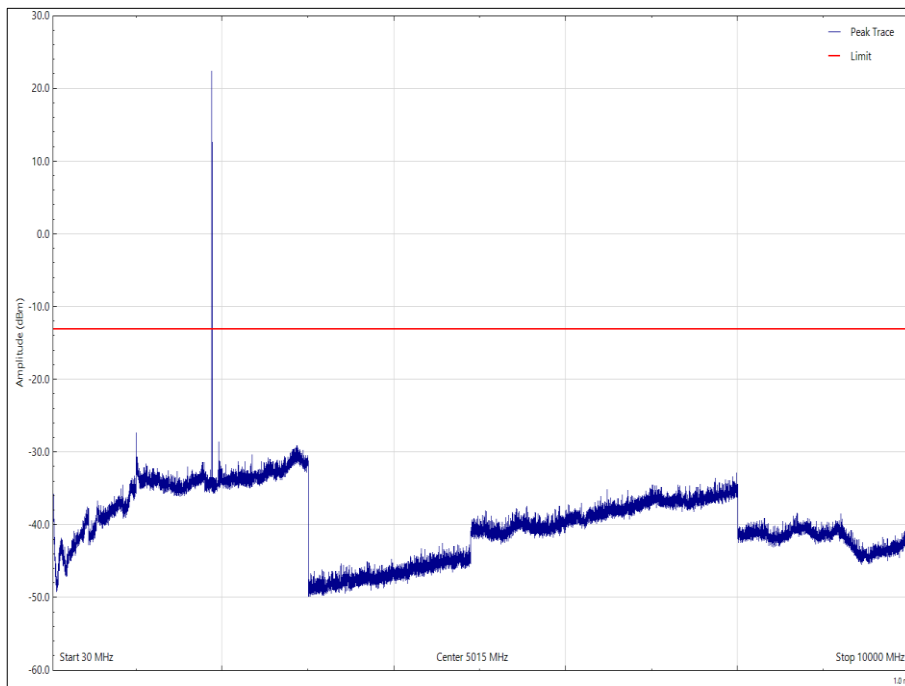

Figure 2 - 30 MHz to 10 GHz – Vertical

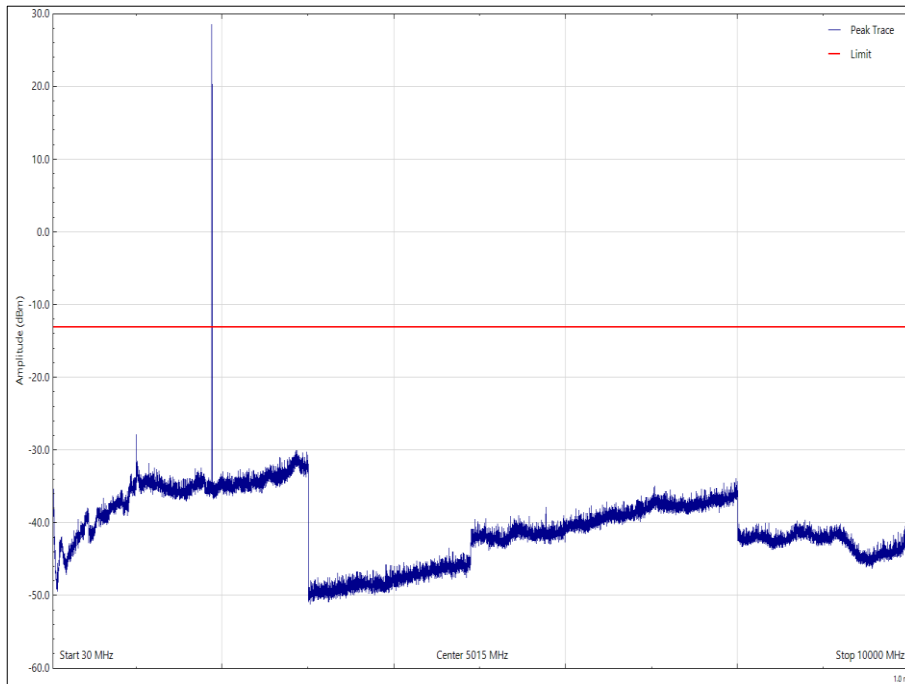

Figure 3 - 30 MHz to 10 GHz - Horizontal



WCDMA FDD Band II

Frequency (MHz)	Level (dBm)	Angle	Height	Polarisation	Orientation
*					

Table 14 - Radiated Emissions Results

*No emissions were detected within 10 dB of the limit.

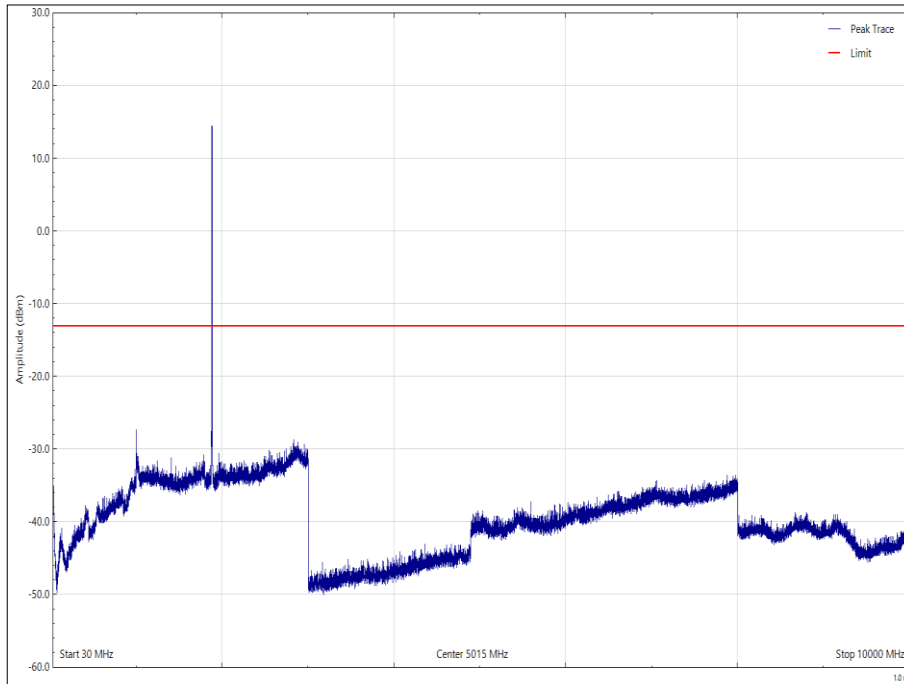

Figure 4 - 30 MHz to 10 GHz - Vertical

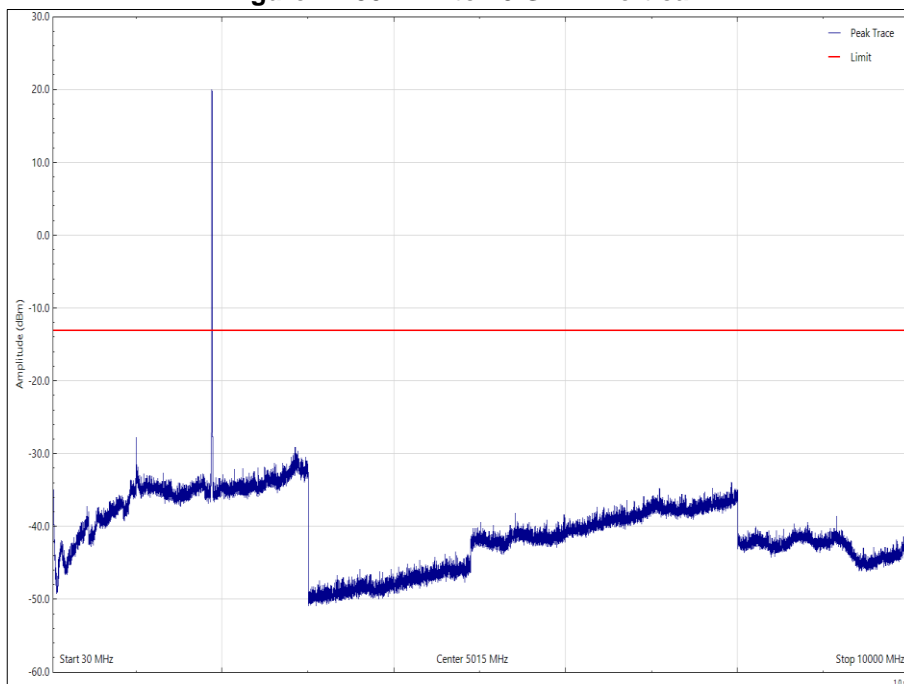

Figure 5 - 30 MHz to 10 GHz - Horizontal



LTE FDD Band 2

Frequency (MHz)	Level (dBm)	Angle	Height	Polarisation	Orientation
*					

Table 15 - Radiated Emissions Results

*No emissions were detected within 10 dB of the limit.

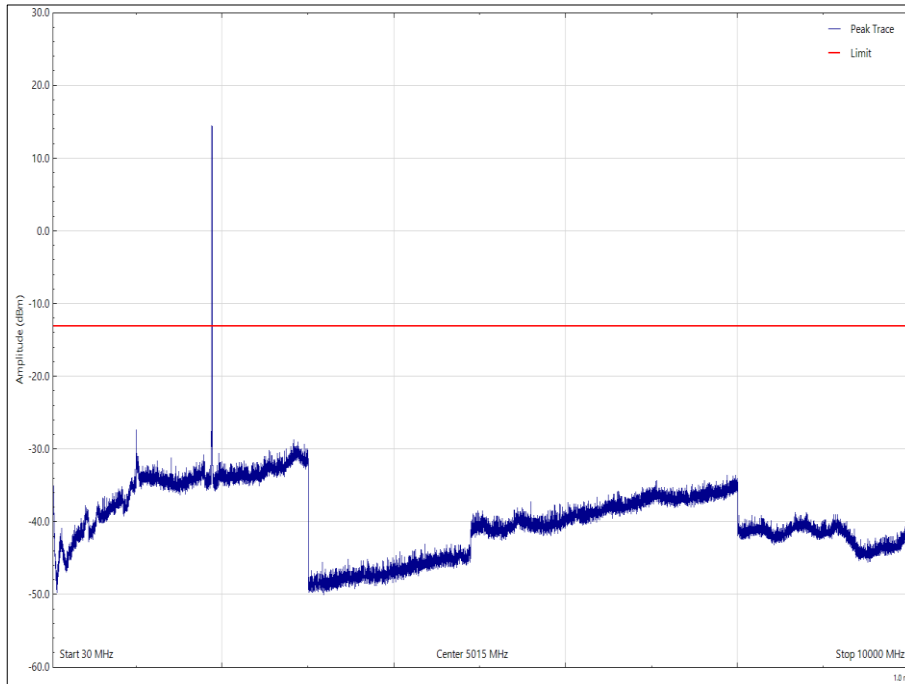

Figure 6 - 30 MHz to 10 GHz – Vertical

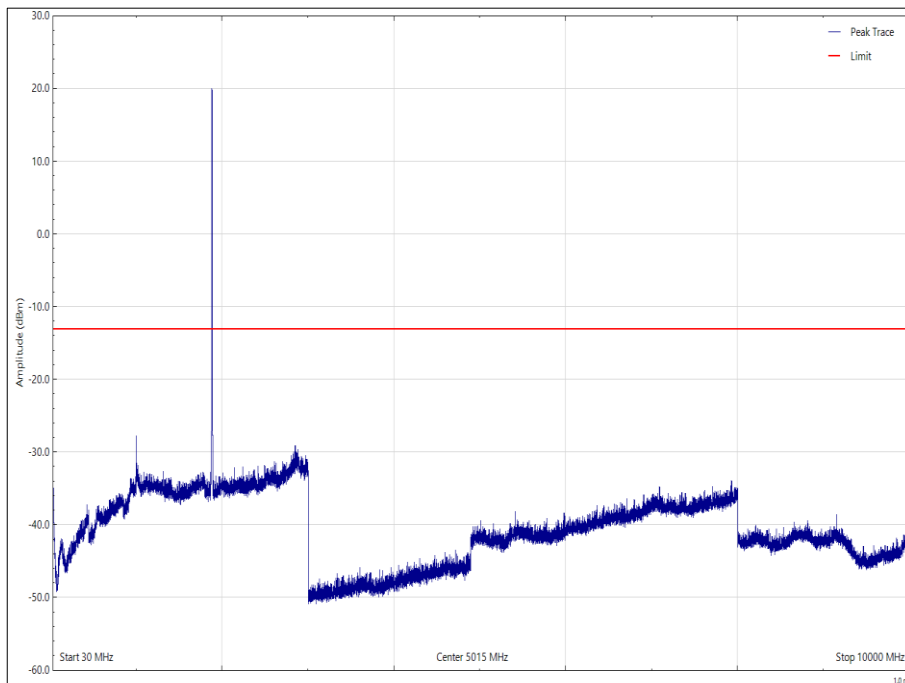

Figure 7 - 30 MHz to 10 GHz - Horizontal



FCC 47 CFR Part 24, Limit Clause 24.238 (a)

The power of any emission outside of the authorized operating frequency ranges must be attenuated below the transmitting power (P) by a factor of at least $43 + 10 \log(P)$ dB.

ISED RSS-133, Limit Clause 6.5

In the first 1.0 MHz band immediately outside and adjacent to each of the sub-bands specified in Section 5.1, the power of emissions per any 1% of the occupied bandwidth shall be attenuated (in dB) below the transmitter output power P (dBW) by at least $43 + 10 \log_{10} p$ (watts).

After the first 1.0 MHz immediately outside and adjacent to each of the sub-bands, the power of emissions in any 100 kHz bandwidth shall be attenuated (in dB) below the transmitter output power P (dBW) by at least $43 + 10 \log_{10} p$ (watts). If the measurement is performed using 1% of the occupied bandwidth, power integration over 100 kHz is required.



2.1.4 Test Location and Test Equipment Used

This test was carried out in EMC Chamber 12.

Instrument	Manufacturer	Type No	TE No	Calibration Period (months)	Calibration Expires
Antenna with permanent attenuator (Bilog)	Schaffner	CBL6143	287	24	14-Oct-2022
Radio Communications Test Set	Rohde & Schwarz	CMU 200	442	12	23-Apr-2021
Power Supply	Hewlett Packard	6104A	1948	-	O/P Mon
True RMS Multimeter	Fluke	179	4006	12	26-Mar-2021
Comb Generator	Schaffner	RSG1000	3034	-	TU
Wideband Radio Test Set	Rohde & Schwarz	CMW500	4546	12	10-Dec-2021
EmX Emissions Software	TUV SUD	V2.1.1	5125	-	Software
Test Receiver	Rohde & Schwarz	ESW44	5379	12	15-Dec-2021
3.5 mm 2m Cable	Junkosha	MWX221-02000DMS	5428	12	15-Oct-2021
Thermo-Hygro-Barometer	PCE Instruments	PCE-THB-40	5481	12	18-Mar-2021
8m N Type Cable	Junkosha	MWX221-08000NMSNMS/B	5519	12	24-Mar-2021
3 GHz High pass Filter	Wainwright	WHKX12-2580-3000-18000-80SS	5548	12	05-May-2021
Broadband Horn Antenna (1-10 GHz)	Schwarzbeck	BBHA 9120 B	5611	12	22-Sep-2021
Turntable & Mast Controller	Maturo Gmbh	NCD/498/2799.01	5612	-	TU
Tilt Antenna Mast TAM 4.0-P	Maturo Gmbh	TAM 4.0-P	5613	-	TU
Turntable	Maturo Gmbh	Turntable 1.5 SI-2t	5614	-	TU
3m Semi Anechoic Chamber	MVG	EMC-3	5621	36	11-Aug-2023

Table 16

TU - Traceability Unscheduled



2.2 ERP/EIRP Verification

2.2.1 Specification Reference

FCC 47 CFR Part 24, Clause 24.232
ISED RSS-133, Clause 6.4
ISED RSS-GEN, Clause 6.12

2.2.2 Equipment Under Test and Modification State

SYS-C60-LMC1, S/N: 210151871 - Modification State 0

2.2.3 Date of Test

07-March-2021

2.2.4 Test Method

The following test was performed to check the fundamental of the integrated module was not adversely affected when integrated into the host device as required by KDB 996369 D04, clause 3.4.

This test was performed in accordance with ANSI C63.26 clause 5.2.3.3 and 5.2.7.

2.2.5 Environmental Conditions

Ambient Temperature 18.2 °C
Relative Humidity 23.9 %

2.2.6 Test Results

PCS 1900

The worst-case mode was identified as:

GPRS, Single Time Slot, Channel 661

Frequency (MHz)	Result	Limit	Unit
1880.0	32.24	33.00	dBm

Table 17 - EIRP Verification Results

WCDMA FDD Band II

The worst-case mode was identified as:

RMC – 12.2 kbps, UARFCN: 9400

Frequency (MHz)	Result	Limit	Unit
1880.0	28.32	33.00	dBm

Table 18 - EIRP Verification Results



LTE FDD Band 2

The worst-case mode was identified as:

10 MHz Bandwidth, QPSK, 1 RB, Mid Offset, Channel 18900

Frequency (MHz)	Result	Limit	Unit
1880.0	28.82	33.00	dBm

Table 19 - EIRP Verification Results

FCC 47 CFR Part 24, Limit Clause 24.232(c)

Mobile and portable stations are limited to 2 watts EIRP and the equipment must employ a means for limiting power to the minimum necessary for successful communications.

ISED RSS-133, Limit Clause 6.4.

The equivalent isotropically radiated power (e.i.r.p.) for transmitters shall not exceed the limits given in SRSP-510.

ISED SRSP-510 Limit Clause 5.12

Mobile stations and hand-held portables are limited to 2 watts maximum e.i.r.p. The equipment shall employ means to limit the power to the minimum necessary for successful communication.



2.2.7 Test Location and Test Equipment Used

This test was carried out in EMC Chamber 12.

Instrument	Manufacturer	Type No	TE No	Calibration Period (months)	Calibration Expires
Radio Communications Test Set	Rohde & Schwarz	CMU 200	442	12	23-Apr-2021
Power Supply	Hewlett Packard	6104A	1948	-	O/P Mon
True RMS Multimeter	Fluke	179	4006	12	26-Mar-2021
Comb Generator	Schaffner	RSG1000	3034	-	TU
Wideband Radio Test Set	Rohde & Schwarz	CMW500	4546	12	10-Dec-2021
EmX Emissions Software	TUV SUD	V2.1.1	5125	-	Software
Test Receiver	Rohde & Schwarz	ESW44	5379	12	15-Dec-2021
3.5 mm 2m Cable	Junkosha	MWX221-02000DMS	5428	12	15-Oct-2021
Thermo-Hygro-Barometer	PCE Instruments	PCE-THB-40	5481	12	18-Mar-2021
8m N Type Cable	Junkosha	MWX221-08000NMSNMS/B	5519	12	24-Mar-2021
Broadband Horn Antenna (1-10 GHz)	Schwarzbeck	BBHA 9120 B	5611	12	22-Sep-2021
Turntable & Mast Controller	Maturo Gmbh	NCD/498/2799.01	5612	-	TU
Tilt Antenna Mast TAM 4.0-P	Maturo Gmbh	TAM 4.0-P	5613	-	TU
Turntable	Maturo Gmbh	Turntable 1.5 SI-2t	5614	-	TU
3m Semi Anechoic Chamber	MVG	EMC-3	5621	36	11-Aug-2023

Table 20

TU - Traceability Unscheduled

3 Photographs

3.1 Test Setup Photographs

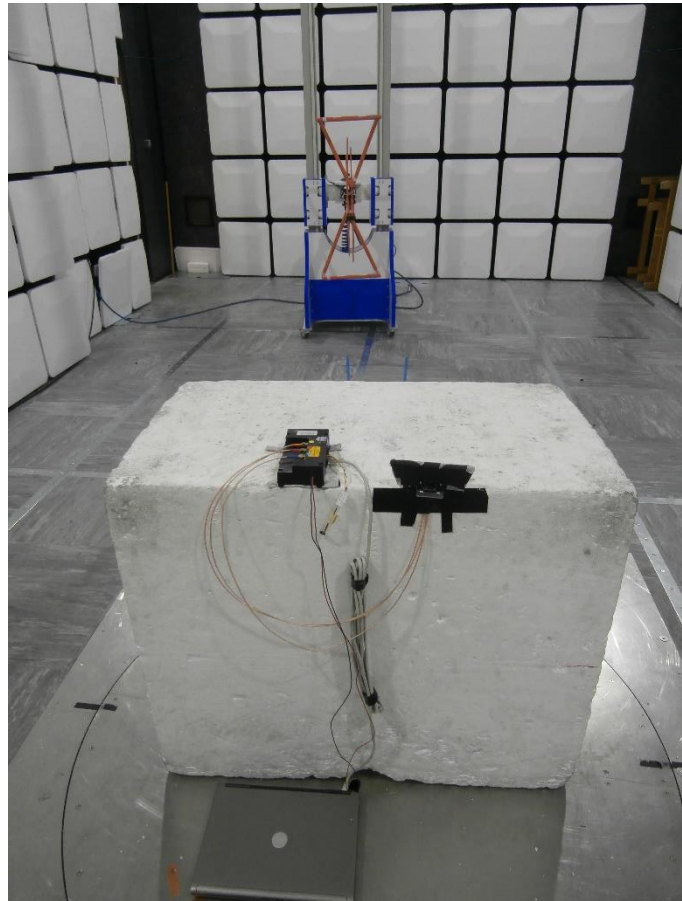

Figure 8 – Test Setup Photo, 30 MHz to 1 GHz



Figure 9 – Test Setup Photo, 1 GHz to 10 GHz



4 Measurement Uncertainty

For a 95% confidence level, the measurement uncertainties for defined systems are:

Test Name	Measurement Uncertainty
Radiated Spurious Emissions	30 MHz to 1 GHz: ± 5.2 dB 1 GHz to 40 GHz: ± 6.3 dB
ERP/EIRP Verification	± 3.2 dB

Table 21

Measurement Uncertainty Decision Rule

Determination of conformity with the specification limits is based on the decision rule according to IEC Guide 115: 2007, clause 4.4.3 and 4.5.1.