

Ultra thin needle antenna remote control motion sensor switch



PRODUCT.: Ultra thin needle antenna remote control motion sensor switch

MODEL NO.: MD012R

SPEC NO.: _____

R & D DEPARTMENT		
WRITED BY	CHECKED	APPROVED

Features

- » 5.8GHz ISM Band frequency.
- » Build in with daylight sensor.
- » Ultra thin and needle antenna config design.
- » IR remote control setting design, easy for using.
- » Integrated microwave RF solution for stable detection range.
- » 5 years warranty.

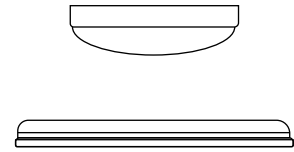

Technical data

Input	Operating voltage	100-277VAC 50/60Hz
	Switching capacity	Max. 100W @220VAC
	Stand-by power	<0.5W
Output	Output	ON/OFF
Sensor Parameters	Microwave frequency	5.8GHz±75MHz
	Microwave power	<0.3mW
	Sensitivity	100%/75%/50%/25%
	Hold time	5s/1min/3min/10min
	Daylight threshold	Disable/50Lux/25Lux/10Lux
	Mounting height	Max.5m (Ceiling mounted)
	Detection range	Radius Max.6m (Ceiling mounted 3m)
Other	Detection Angle	30°-150°
	Operating temperature	-35°C~70°C
	IP rating	IP20
	size (L*W*H)	77*40*28mm
Warranty	5 years	
Note	Default setting: Sensitivity 100%, Hold time 5s, Daylight threshold Disable.	

Mechanical structure

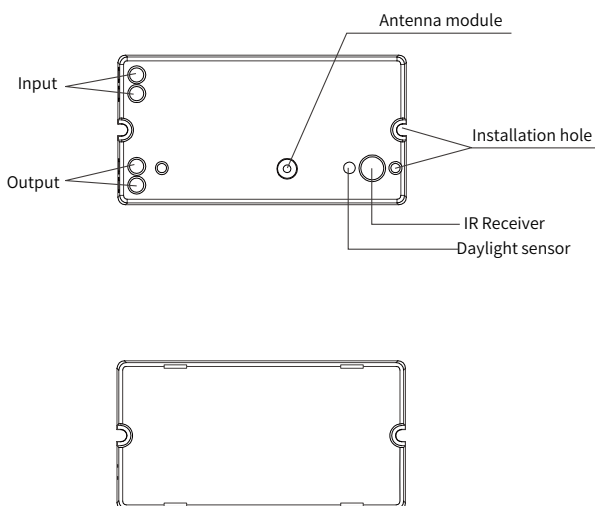

Detection coverage

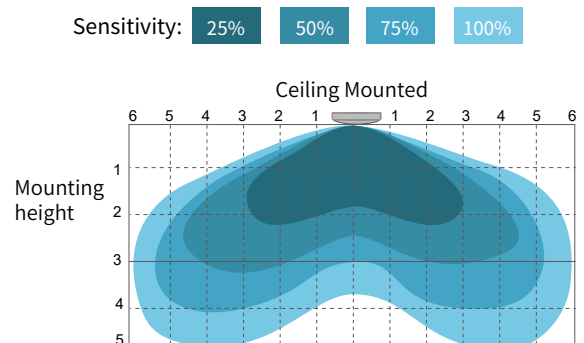

Dimension (Unit: mm)

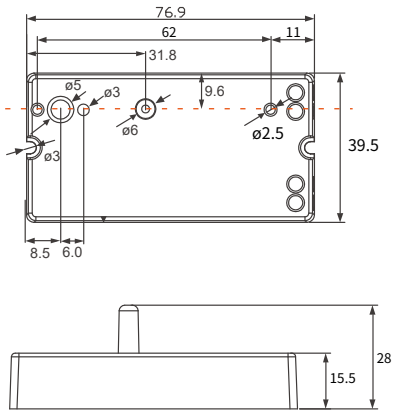

Wiring diagram

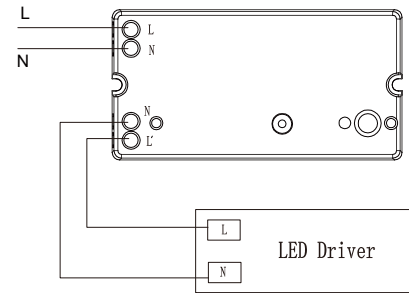

Application

The daylight threshold is set to "10Lux/25Lux/50Lux".

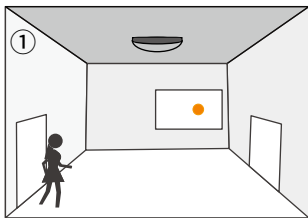

With sufficient daylight, even when motion detected, light remains OFF.

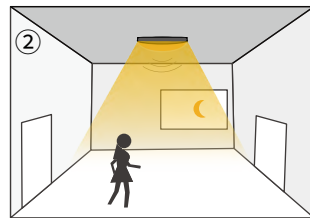

With insufficient daylight, when motion detected, light ON.

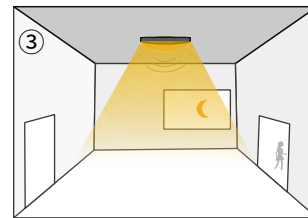

After people leave the detection area, light remains 100% brightness within hold time.

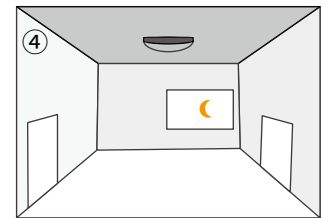

After the last detection and the preset hold time elapsed, light OFF.

The daylight threshold is set to "Disable". Light on when detect movement, After people leave, Light off after Hold-time.

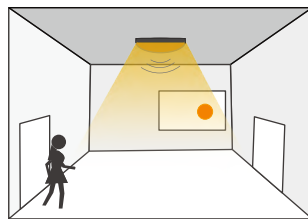

When motion is detected, the sensor will switch on the light to 100% brightness.

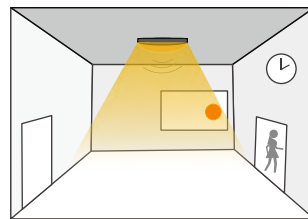

After people leave the detection area, light remains 100% brightness within hold time.

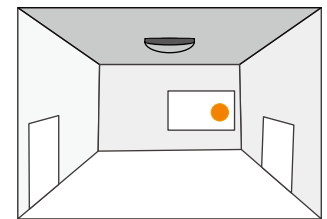

After the last detection and the present hold time elapsed, light OFF.

Installation precautions

- » Wiring must be strictly in accordance with the wiring diagram to avoid short circuit.
- » The detected surface cannot be shielded by metal objects.
- » Microwave sensor can be installed in any lamp except the one with full metal shell.
- » Should be kept away from the driver to avoid interference generation and lamp flashing.
- » Shall not be installed next to large operating machines such as ventilator/ceiling fan to avoid false triggering caused by machine vibration.
- » Suitable for indoor installation to avoid false triggering due to external factors such as rain, wind or tree swing.
- » Wiring must be strictly in accordance with the wiring diagram to avoid short circuit.

FCC Warning

This device complies with part 15 of the FCC Rules. Operation is subject to the following two conditions: (1) This device may not cause harmful interference, and (2) this device must accept any interference received, including interference that may cause undesired operation.

Note: This equipment has been tested and found to comply with the limits for a Class B digital device, pursuant to part 15 of the FCC Rules. These limits are designed to provide reasonable protection against harmful interference in a residential installation. This equipment generates, uses and can radiate radio frequency energy and, if not installed and used in accordance with the instructions, may cause harmful interference to radio communications. However, there is no guarantee that interference will not occur in a particular installation. If this equipment does cause harmful interference to radio or television reception, which can be determined by turning the equipment off and on, the user is encouraged to try to correct the interference by one or more of the following measures:

- Reorient or relocate the receiving antenna.
- Increase the separation between the equipment and receiver.
- Connect the equipment into an outlet on a circuit different from that to which the receiver is connected.
- Consult the dealer or an experienced radio/TV technician for help.

Note: The Grantee is not responsible for any changes or modifications not expressly approved by the party responsible for compliance. such modifications could void the user's authority to operate the equipment.

The device has been evaluated to meet general RF exposure requirement.

To maintain compliance with FCC's RF exposure guidelines, the distance must be at least 20 cm between the radiator and your body, and fully supported by the operating and installation