

FCC SAR EVALUATION REPORT

In accordance with the requirements of
FCC 47 CFR Part 2(2.1093), ANSI/IEEE C95.1-1992 and
IEEE Std 1528-2013

Product Name : Nreal Streaming Box

Trademark : **nreal**

Model Name : NR-7101AGL

Family Model : N/A

Report No. : S22032100201001

FCC ID : 2AZU3-7101AGL

Prepared for

Matrixed Reality Technology Co., Ltd.

No.6, Xingchuang 2nd Rd., Xinwu Dist., Wuxi, Jiangsu, PRC

Prepared by

Shenzhen NTEK Testing Technology Co., Ltd.

1/F, Building E, Fenda Science Park, Sanwei Community, Xixiang Street,

Bao'an District, Shenzhen 518126 P.R.China.

Tel. 400-800-6106, 0755-2320 0050, 0755-2320 0090

Website: <http://www.ntek.org.cn>

TEST RESULT CERTIFICATION

Applicant's name: Matrixed Reality Technology Co., Ltd.
 Address.....: No.6, Xingchuang 2nd Rd., Xinwu Dist., Wuxi, Jiangsu, PRC
Manufacturer's Name.....: Matrixed Reality Technology Co., Ltd.
 Address.....: No.6, Xingchuang 2nd Rd., Xinwu Dist., Wuxi, Jiangsu, PRC

Product description

Product name.....: Nreal Streaming Box
 Trademark: **nreal**
 Model Name: NR-7101AGL
 Family Model.....: N/A

FCC 47 CFR Part 2(2.1093)
 ANSI/IEEE C95.1-1992
Standards: IEEE Std 1528-2013
 Published RF exposure KDB procedures

This device described above has been tested by Shenzhen NTEK. In accordance with the measurement methods and procedures specified in IEEE Std 1528-2013 and KDB 865664 D01. Testing has shown that this device is capable of compliance with localized specific absorption rate (SAR) specified in FCC 47 CFR Part 2(2.1093) and ANSI/IEEE C95.1-1992. The test results in this report apply only to the tested sample of the stated device/equipment. Other similar device/equipment will not necessarily produce the same results due to production tolerance and measurement uncertainties.

This report shall not be reproduced except in full, without the written approval of Shenzhen NTEK, this document may be altered or revised by Shenzhen NTEK, personal only, and shall be noted in the revision of the document.

Date of Test

Date (s) of performance of tests: Mar. 24, 2022 ~ Mar. 30, 2022
 Date of Issue: Apr. 08, 2022
 Test Result.....: **Pass**

Prepared By : Jacob.chen
 (Test Engineer) : (Jacob Chen)

Approved By : Alex
 (Lab Manager) : (Alex Li)

※ ※ **Revision History** ※ ※

REV.	DESCRIPTION	ISSUED DATE	REMARK
Rev.1.0	Initial Test Report Release	Apr. 08, 2022	Jacob Chen

TABLE OF CONTENTS

1. General Information	6
1.1. RF exposure limits	6
1.2. Statement of Compliance.....	7
1.3. EUT Description	7
1.4. Test specification(s)	8
1.5. Ambient Condition	8
2. SAR Measurement System	9
2.1. SATIMO SAR Measurement Set-up Diagram	9
2.2. Robot	10
2.3. E-Field Probe	11
2.3.1. E-Field Probe Calibration.....	11
2.4. SAM phantoms	12
2.4.1. Technical Data	13
2.5. Device Holder	14
2.6. Test Equipment List	15
3. SAR Measurement Procedures	17
3.1. Power Reference.....	17
3.2. Area scan & Zoom scan	17
3.3. Description of interpolation/extrapolation scheme	19
3.4. Volumetric Scan	19
3.5. Power Drift	19
4. System Verification Procedure.....	20
4.1. Tissue Verification.....	20
4.1.1. Tissue Dielectric Parameter Check Results	21
4.2. System Verification Procedure	22
4.2.1. System Verification Results	23
5. SAR Measurement variability and uncertainty	24
5.1. SAR measurement variability	24
5.2. SAR measurement uncertainty.....	24
6. RF Exposure Positions	25
6.1. Body Worn Accessory	25
6.2. Wireless Router Devices	25
7. RF Output Power	27
7.1. WLAN & Bluetooth Output Power	27
7.1.1. Output Power Results Of WLAN	27
7.1.2. Output Power Results Of Bluetooth	29
8. Stand-alone SAR test exclusion	30
9. SAR Results	30
9.1. SAR measurement results	30

9.1.1.	SAR measurement Result of WLAN 2.4G	30
9.1.2.	SAR measurement Result of WLAN 5.2G	31
9.1.3.	SAR measurement Result of WLAN 5.3G	31
9.1.4.	SAR measurement Result of WLAN 5.6G	32
9.1.5.	SAR measurement Result of WLAN 5.8G	32
9.2.	Simultaneous Transmission Analysis	33
10.	Appendix A. Photo documentation	34
11.	Appendix B. System Check Plots	34
12.	Appendix C. Plots of High SAR Measurement	43
13.	Appendix D. Calibration Certificate	54

1. General Information

1.1. RF exposure limits

(A).Limits for Occupational/Controlled Exposure (W/kg)

Whole-Body	Partial-Body	Hands, Wrists, Feet and Ankles
0.4	8.0	20.0

(B).Limits for General Population/Uncontrolled Exposure (W/kg)

Whole-Body	Partial-Body	Hands, Wrists, Feet and Ankles
0.08	1.6	4.0

NOTE: **Whole-Body SAR** is averaged over the entire body, **partial-body SAR** is averaged over any 1 gram of tissue defined as a tissue volume in the shape of a cube. **SAR for hands, wrists, feet and ankles** is averaged over any 10 grams of tissue defined as a tissue volume in the shape of a cube.

Occupational/Controlled Environments:

Are defined as locations where there is exposure that may be incurred by people who are aware of the potential for exposure, (i.e. as a result of employment or occupation).

General Population/Uncontrolled Environments:

Are defined as locations where there is the exposure of individuals who have no knowledge or control of their exposure.

NOTE
TRUNK LIMIT
1.6 W/kg
APPLIED TO THIS EUT

1.2. Statement of Compliance

The maximum results of Specific Absorption Rate (SAR) found during testing for NR-7101AGL are as follows.

RF Exposure Conditions	Max SAR Value(W/kg)	
	1-g Body-Worn (Separation distance of 10mm)	1-g Hotspot (Separation distance of 10mm)
	0.298	0.355

Note: This device is in compliance with Specific Absorption Rate (SAR) for general population / uncontrolled exposure limits (1.6 W/kg) specified in FCC 47 CFR Part 2(2.1093) and ANSI/IEEE C95.1-1992, and had been tested in accordance with the measurement methods and procedures specified in IEEE Std 1528-2013 & KDB 865664 D01.

1.3. EUT Description

Device Information			
Product Name	Nreal Streaming Box		
Trade Name	nreal		
Model Name	NR-7101AGL		
Family Model	N/A		
FCC ID	2AZU3-7101AGL		
Device Phase	Identical Prototype		
Exposure Category	General population / Uncontrolled environment		
Antenna	IFA Antenna		
Battery Information	5000mAh		
Hardware version:	P3		
Software version	early_202111190649_20		
Device Operating Configurations			
Supporting Mode(s)	WLAN 2.4G/5G, Bluetooth		
Test Modulation	WLAN(DSSS/OFDM), Bluetooth(GFSK, $\pi/4$ -DQPSK, 8DPSK)		
Device Class	B		
Operating Frequency Range(s)	Band	Tx (MHz)	Rx (MHz)
	WLAN 2.4G	2412-2462	
	WLAN 5.2G	5180-5240	
	WLAN 5.3G	5260-5320	
	WLAN 5.6G	5500-5700	
	WLAN 5.8G	5745-5825	
	Bluetooth	2402-2480	

1.4. Test specification(s)

FCC 47 CFR Part 2(2.1093)
ANSI/IEEE C95.1-1992
IEEE Std 1528-2013
KDB 865664 D01 SAR measurement 100 MHz to 6 GHz
KDB 865664 D02 RF Exposure Reporting
KDB 447498 D01 General RF Exposure Guidance
KDB 248227 D01 802.11 Wi-Fi SAR
KDB 941225 D06 Hotspot SAR

1.5. Ambient Condition

Ambient temperature	20°C – 24°C
Relative Humidity	30% – 70%

2. SAR Measurement System

2.1. SATIMO SAR Measurement Set-up Diagram

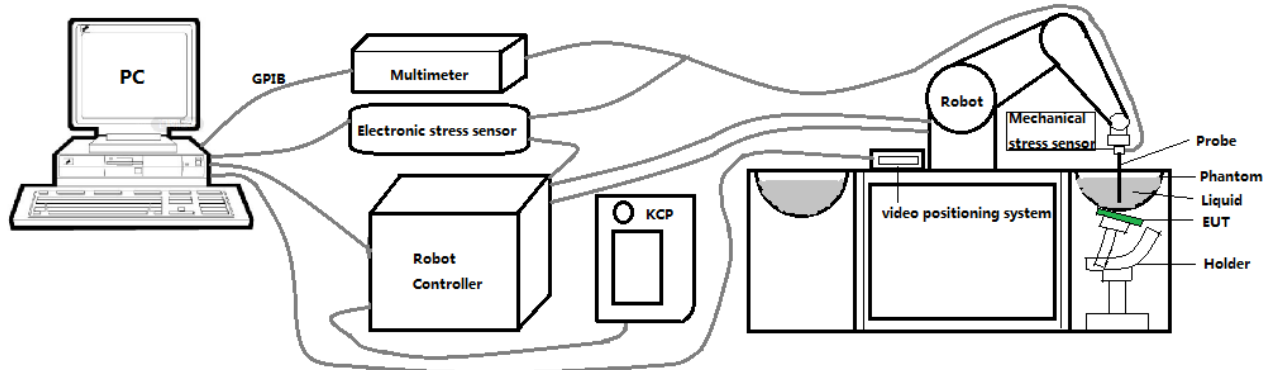

These measurements were performed with the automated near-field scanning system OPENSAR from SATIMO. The system is based on a high precision robot (working range: 901 mm), which positions the probes with a positional repeatability of better than ± 0.03 mm. The SAR measurements were conducted with dosimetric probe (manufactured by SATIMO), designed in the classical triangular configuration and optimized for dosimetric evaluation.

The first step of the field measurement is the evaluation of the voltages induced on the probe by the device under test. Probe diode detectors are nonlinear. Below the diode compression point, the output voltage is proportional to the square of the applied E-field; above the diode compression point, it is linear to the applied E-field. The compression point depends on the diode, and a calibration procedure is necessary for each sensor of the probe.

The Keithley multimeter reads the voltage of each sensor and send these three values to the PC. The corresponding E field value is calculated using the probe calibration factors, which are stored in the working directory. This evaluation includes linearization of the diode characteristics. The field calculation is done separately for each sensor. Each component of the E field is displayed on the "Dipole Area Scan Interface" and the total E field is displayed on the "3D Interface"

2.2. Robot

The SATIMO SAR system uses the high precision robots from KUKA. For the 6-axis controller system, the robot controller version (KUKA) from KUKA is used. The KUKA robot series have many features that are important for our application:



- High precision (repeatability ± 0.03 mm)
- High reliability (industrial design)
- Jerk-free straight movements
- Low ELF interference (the closed metallic construction shields against motor control fields)

2.3. E-Field Probe

This E-field detection probe is composed of three orthogonal dipoles linked to special Schottky diodes with low detection thresholds. The probe allows the measurement of electric fields in liquids such as the one defined in the IEEE and CENELEC standards.

For the measurements the Specific Dosimetric E-Field Probe SN 08/16 EPGO287 with following specifications is used



- Dynamic range: 0.01-100 W/kg
 - Tip Diameter : 2.5 mm
 - Distance between probe tip and sensor center: 1 mm
 - Distance between sensor center and the inner phantom surface: 2 mm (repeatability better than ± 1 mm).
 - Probe linearity: ± 0.08 dB
 - Axial isotropy: ± 0.01 dB
 - Hemispherical Isotropy: ± 0.01 dB
 - Calibration range: 650MHz to 5900MHz for head & body simulating liquid.
 - Lower detection limit: 8mW/kg
- Angle between probe axis (evaluation axis) and surface normal line: less than 30° .

2.3.1. E-Field Probe Calibration

Each probe needs to be calibrated according to a dosimetric assessment procedure with accuracy better than $\pm 10\%$. The spherical isotropy shall be evaluated and within ± 0.25 dB. The sensitivity parameters (Norm X, Norm Y, and Norm Z), the diode compression parameter (DCP) and the conversion factor (Conv F) of the probe are tested. The calibration data can be referred to appendix D of this report.

2.4. SAM phantoms

Photo of SAM phantom SN 16/15 SAM119



The SAM phantom is used to measure the SAR relative to people exposed to electro-magnetic field radiated by mobile phones.

2.4.1. Technical Data

Serial Number	Shell thickness	Filling volume	Dimensions	Positionner Material	Permittivity	Loss Tangent
SN 16/15 SAM119	2 mm ±0.2 mm	27 liters	Length:1000 mm Width:500 mm Height:200 mm	Gelcoat with fiberglass	3.4	0.02

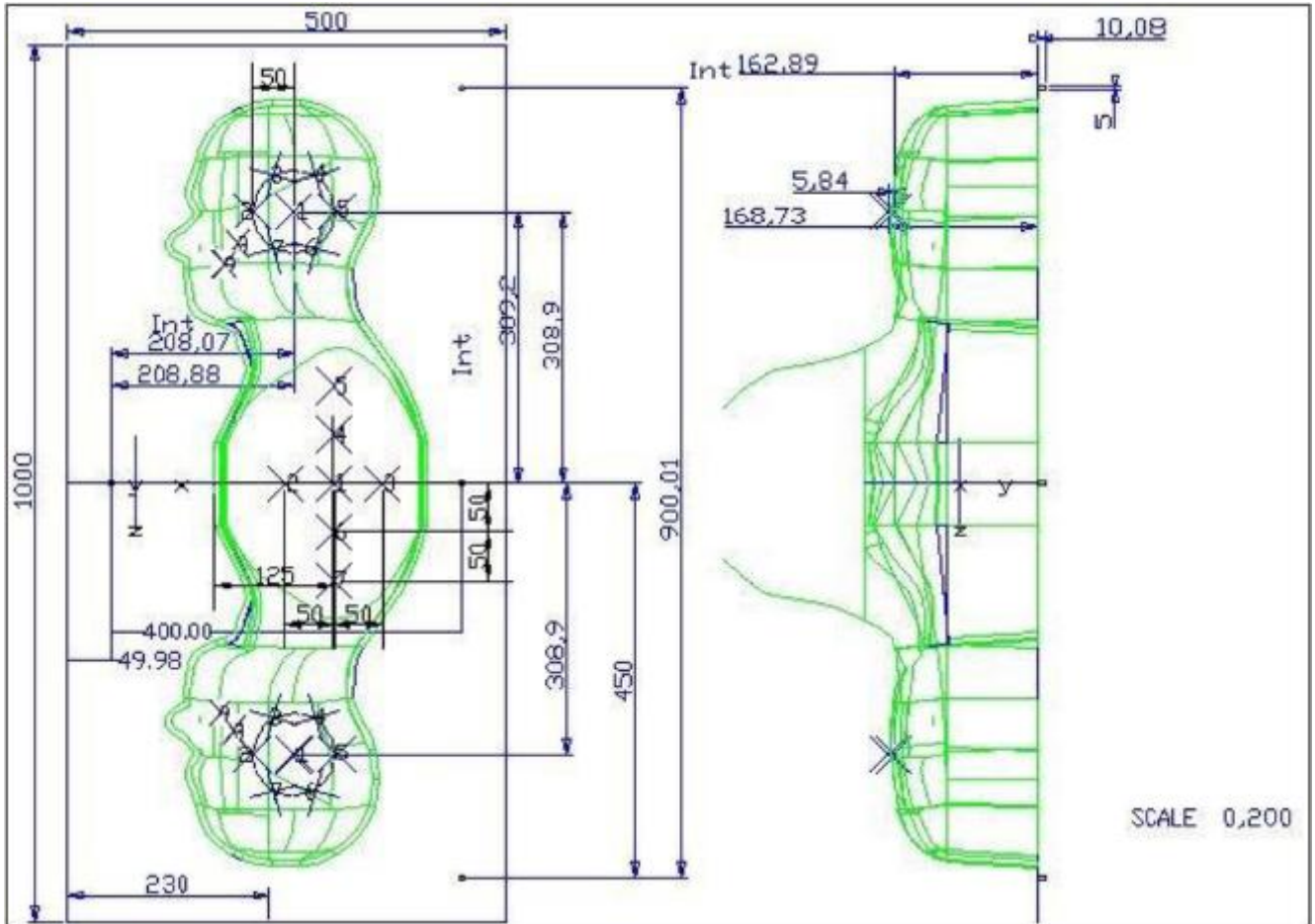

Serial Number	Left Head(mm)		Right Head(mm)		Flat Part(mm)	
	1	2	1	2	1	2
SN 16/15 SAM119	2	2.02	2	2.08	1	2.09
	3	2.05	3	2.06	2	2.06
	4	2.07	4	2.07	3	2.08
	5	2.08	5	2.08	4	2.10
	6	2.05	6	2.07	5	2.10
	7	2.05	7	2.05	6	2.07
	8	2.07	8	2.06	7	2.07
	9	2.08	9	2.06	-	-

The test, based on ultrasonic system, allows measuring the thickness with an accuracy of 10 µm.

2.5. Device Holder

The positioning system allows obtaining cheek and tilting position with a very good accuracy. In compliance with CENELEC, the tilt angle uncertainty is lower than 1 degree.

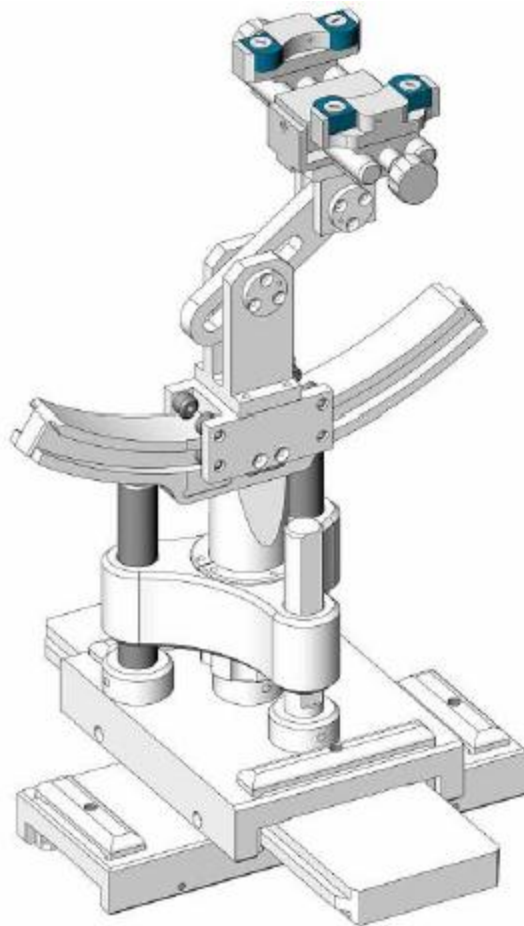

Serial Number	Holder Material	Permittivity	Loss Tangent
SN 16/15 MSH100	Delrin	3.7	0.005

2.6. Test Equipment List

This table gives a complete overview of the SAR measurement equipment.

Devices used during the test described are marked

	Manufacturer	Name of Equipment	Type/Model	Serial Number	Calibration	
					Last Cal.	Due Date
<input checked="" type="checkbox"/>	MVG	E FIELD PROBE	SSE2	SN 08/16 EPGO287	Feb. 28, 2022	Jan. 31, 2023
<input type="checkbox"/>	MVG	750 MHz Dipole	SID750	SN 03/15 DIP 0G750-355	Mar. 01, 2021	Feb. 28, 2024
<input type="checkbox"/>	MVG	835 MHz Dipole	SID835	SN 03/15 DIP 0G835-347	Mar. 01, 2021	Feb. 28, 2024
<input type="checkbox"/>	MVG	900 MHz Dipole	SID900	SN 03/15 DIP 0G900-348	Mar. 01, 2021	Feb. 28, 2024
<input type="checkbox"/>	MVG	1800 MHz Dipole	SID1800	SN 03/15 DIP 1G800-349	Mar. 01, 2021	Feb. 28, 2024
<input type="checkbox"/>	MVG	1900 MHz Dipole	SID1900	SN 03/15 DIP 1G900-350	Mar. 01, 2021	Feb. 28, 2024
<input type="checkbox"/>	MVG	2000 MHz Dipole	SID2000	SN 03/15 DIP 2G000-351	Mar. 01, 2021	Feb. 28, 2024
<input checked="" type="checkbox"/>	MVG	2450 MHz Dipole	SID2450	SN 03/15 DIP 2G450-352	Mar. 01, 2021	Feb. 28, 2024
<input type="checkbox"/>	MVG	2600 MHz Dipole	SID2600	SN 03/15 DIP 2G600-356	Mar. 01, 2021	Feb. 28, 2024
<input checked="" type="checkbox"/>	MVG	5000 MHz Dipole	SWG5500	SN 13/14 WGA 33	Mar. 01, 2021	Feb. 28, 2024
<input checked="" type="checkbox"/>	MVG	Liquid measurement Kit	SCLMP	SN 21/15 OCPG 72	NCR	NCR
<input checked="" type="checkbox"/>	MVG	Power Amplifier	N.A	AMPLISAR_28/14_003	NCR	NCR
<input checked="" type="checkbox"/>	KEITHLEY	Millivoltmeter	2000	4072790	NCR	NCR
<input type="checkbox"/>	R&S	Universal radio communication tester	CMU200	117858	Jul. 01, 2021	Jun. 30, 2022
<input type="checkbox"/>	R&S	Wideband radio communication tester	CMW500	103917	Jul. 01, 2021	Jun. 30, 2022
<input checked="" type="checkbox"/>	HP	Network Analyzer	8753D	3410J01136	Jul. 01, 2021	Jun. 30, 2022
<input checked="" type="checkbox"/>	Agilent	PSG Analog Signal Generator	E8257D	MY51110112	Jul. 01, 2021	Jun. 30, 2022

<input checked="" type="checkbox"/>	Agilent	Power meter	E4419B	MY45102538	Jul. 01, 2021	Jun. 30, 2022
<input checked="" type="checkbox"/>	Agilent	Power sensor	E9301A	MY41495644	Jul. 01, 2021	Jun. 30, 2022
<input checked="" type="checkbox"/>	Agilent	Power sensor	E9301A	US39212148	Jul. 01, 2021	Jun. 30, 2022
<input checked="" type="checkbox"/>	MCLI/USA	Directional Coupler	CB11-20	0D2L51502	Jul. 17, 2020	Jul. 16, 2023

3. SAR Measurement Procedures

The measurement procedures are as follows:

<Conducted power measurement>

- (a) For WWAN power measurement, use base station simulator to configure EUT WWAN transmission in conducted connection with RF cable, at maximum power in each supported wireless interface and frequency band.
- (b) Read the WWAN RF power level from the base station simulator.
- (c) For WLAN/Bluetooth power measurement, use engineering software to configure EUT WLAN/Bluetooth continuously transmission, at maximum RF power in each supported wireless interface and frequency band.
- (d) Connect EUT RF port through RF cable to the power meter, and measure WLAN/Bluetooth output power.

<SAR measurement>

- (a) Use base station simulator to configure EUT WWAN transmission in radiated connection, and engineering software to configure EUT WLAN/Bluetooth continuously transmission, at maximum RF power, in the highest power channel.
- (b) Place the EUT in the positions as Appendix A demonstrates.
- (c) Set scan area, grid size and other setting on the OPENSAR software.
- (d) Measure SAR results for the highest power channel on each testing position.
- (e) Find out the largest SAR result on these testing positions of each band.
- (f) Measure SAR results for other channels in worst SAR testing position if the reported SAR of highest power channel is larger than 0.8 W/kg.

According to the test standard, the recommended procedure for assessing the peak spatial-average SAR value consists of the following steps:

- (a) Power reference measurement
- (b) Area scan
- (c) Zoom scan
- (d) Power drift measurement

3.1. Power Reference

The Power Reference Measurement and Power Drift Measurements are for monitoring the power drift of the device under test in the batch process. The minimum distance of probe sensors to surface determines the closest measurement point to phantom surface. This distance cannot be smaller than the distance of sensor calibration points to probe tip as defined in the probe properties.

3.2. Area scan & Zoom scan

The area scan is a 2D scan to find the hot spot location on the DUT. The zoom scan is a 3D scan above the hot spot to calculate the 1g and 10g SAR value.

Measurement of the SAR distribution with a grid of 8 to 16 mm * 8 to 16 mm and a constant distance to the inner surface of the phantom. Since the sensors cannot directly measure at the inner phantom surface, the values between the sensors and the inner phantom surface are extrapolated. With these values the area of the maximum SAR is calculated by an interpolation scheme. Around this point, a cube of 30 * 30 * 30 mm or 32 * 32 * 32 mm is assessed by measuring 5 or 8 * 5 or 8 * 4 or 5 mm. With these data, the peak spatial-average SAR value can be calculated.

From the scanned SAR distribution, identify the position of the maximum SAR value, in addition identify the positions of any local maxima with SAR values within 2 dB of the maximum value that will not be within the zoom scan of other peaks; additional peaks shall be measured only when the primary peak is within 2 dB of the SAR compliance limit (e.g., 1 W/kg for 1,6 W/kg 1 g limit, or 1,26 W/kg for 2 W/kg, 10 g limit).

Area scan & Zoom scan scan parameters extracted from FCC KDB 865664 D01 SAR measurement 100 MHz to 6 GHz.

		≤ 3 GHz	> 3 GHz	
Maximum distance from closest measurement point (geometric center of probe sensors) to phantom surface		5 ± 1 mm	½·δ·ln(2) ± 0.5 mm	
Maximum probe angle from probe axis to phantom surface normal at the measurement location		30° ± 1°	20° ± 1°	
Maximum area scan spatial resolution: Δx _{Area} , Δy _{Area}		≤ 2 GHz: ≤ 15 mm 2 – 3 GHz: ≤ 12 mm	3 – 4 GHz: ≤ 12 mm 4 – 6 GHz: ≤ 10 mm	
		When the x or y dimension of the test device, in the measurement plane orientation, is smaller than the above, the measurement resolution must be ≤ the corresponding x or y dimension of the test device with at least one measurement point on the test device.		
Maximum zoom scan spatial resolution: Δx _{Zoom} , Δy _{Zoom}		≤ 2 GHz: ≤ 8 mm 2 – 3 GHz: ≤ 5 mm*	3 – 4 GHz: ≤ 5 mm* 4 – 6 GHz: ≤ 4 mm*	
Maximum zoom scan spatial resolution, normal to phantom surface	uniform grid: Δz _{Zoom} (n)	≤ 5 mm	3 – 4 GHz: ≤ 4 mm 4 – 5 GHz: ≤ 3 mm 5 – 6 GHz: ≤ 2 mm	
	graded grid	Δz _{Zoom} (1): between 1 st two points closest to phantom surface	≤ 4 mm	3 – 4 GHz: ≤ 3 mm 4 – 5 GHz: ≤ 2.5 mm 5 – 6 GHz: ≤ 2 mm
		Δz _{Zoom} (n>1): between subsequent points	≤ 1.5·Δz _{Zoom} (n-1)	
Minimum zoom scan volume	x, y, z	≥ 30 mm	3 – 4 GHz: ≥ 28 mm 4 – 5 GHz: ≥ 25 mm 5 – 6 GHz: ≥ 22 mm	

Note: δ is the penetration depth of a plane-wave at normal incidence to the tissue medium; see draft standard IEEE P1528-2011 for details.

* When zoom scan is required and the *reported* SAR from the *area scan based 1-g SAR estimation* procedures of KDB 447498 is ≤ 1.4 W/kg, ≤ 8 mm, ≤ 7 mm and ≤ 5 mm zoom scan resolution may be applied, respectively, for 2 GHz to 3 GHz, 3 GHz to 4 GHz and 4 GHz to 6 GHz.

3.3. Description of interpolation/extrapolation scheme

The local SAR inside the phantom is measured using small dipole sensing elements inside a probe body. The probe tip must not be in contact with the phantom surface in order to minimise measurements errors, but the highest local SAR will occur at the surface of the phantom.

An extrapolation is used to determine these highest local SAR values. The extrapolation is based on a fourth-order least-square polynomial fit of measured data. The local SAR value is then extrapolated from the liquid surface with a 1 mm step.

The measurements have to be performed over a limited time (due to the duration of the battery) so the step of measurement is high. It could vary between 5 and 8 mm. To obtain an accurate assessment of the maximum SAR averaged over 10 grams and 1 gram requires a very fine resolution in the three dimensional scanned data array.

3.4. Volumetric Scan

The volumetric scan consists of a full 3D scan over a specific area. This 3D scan is useful for multi Tx SAR measurement. Indeed, it is possible with OpenSAR to add, point by point, several volumetric scans to calculate the SAR value of the combined measurement as it is defined in the standard IEEE1528 and IEC62209.

3.5. Power Drift

All SAR testing is under the EUT installed with a full charged battery and transmit maximum output power. In OpenSAR measurement software, the power reference measurement and power drift measurement procedures are used for monitoring the power drift of EUT during SAR test. Both these procedures measure the field at a specified reference position before and after the SAR testing. The software will calculate the field difference in V/m. If the power drifts more than $\pm 5\%$, the SAR will be retested.

4. System Verification Procedure

4.1. Tissue Verification

The following tissue formulations are provided for reference only as some of the parameters have not been thoroughly verified. The composition of ingredients may be modified accordingly to achieve the desired target tissue parameters required for routine SAR evaluation.

Ingredients (% of weight)	Head Tissue									
	750	835	900	1800	1900	2000	2450	2600	5200	5800
Frequency Band (MHz)										
Water	34.40	34.40	34.40	55.36	55.36	57.87	57.87	57.87	65.53	65.53
NaCl	0.79	0.79	0.79	0.35	0.35	0.16	0.16	0.16	0.00	0.00
1,2-Propanediol	64.81	64.81	64.81	0.00	0.00	0.00	0.00	0.00	0.00	0.00
Triton X-100	0.00	0.00	0.00	30.45	30.45	19.97	19.97	19.97	24.24	24.24
DGBE	0.00	0.00	0.00	13.84	13.84	22.00	22.00	22.00	10.23	10.23

For SAR measurement of the field distribution inside the phantom, the phantom must be filled with homogeneous tissue simulating liquid to a depth of at least 15 cm. For head SAR testing, the liquid depth from the ear reference point (ERP) of the phantom to the liquid top surface is larger than 15 cm.

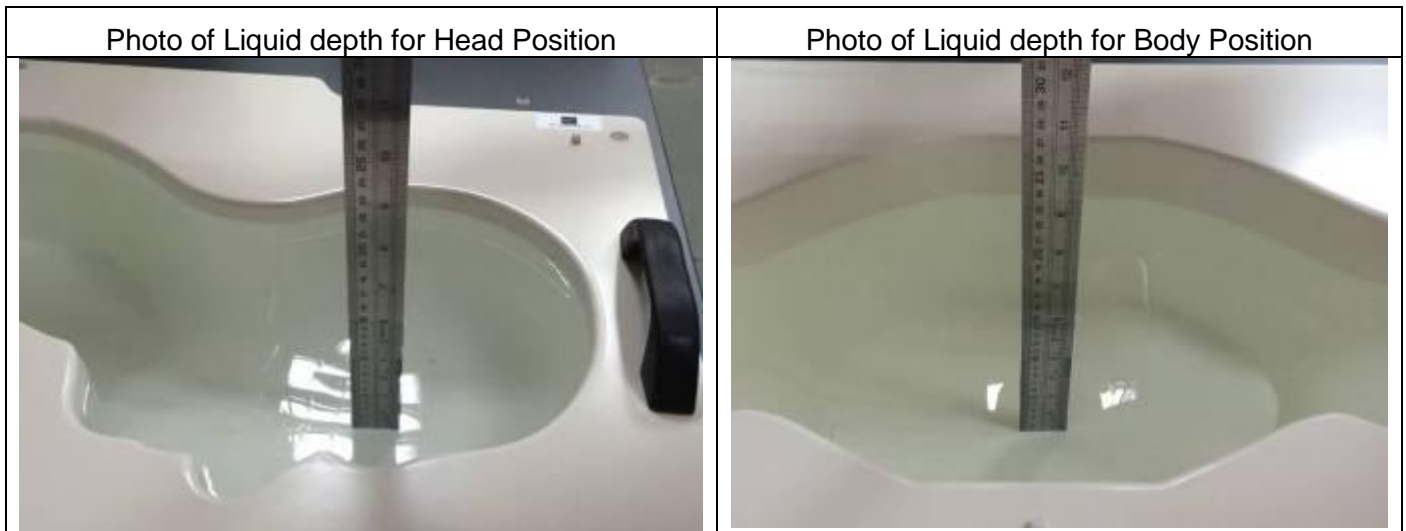

4.1.1. Tissue Dielectric Parameter Check Results

The simulating liquids should be checked at the beginning of a series of SAR measurements to determine if the dielectric parameters are within the tolerances of the specified target values. The measured conductivity and relative permittivity should be within $\pm 5\%$ of the target values.

Tissue Type	Measured Frequency (MHz)	Target Tissue		Measured Tissue		Liquid Temp.	Test Date
		ϵ_r ($\pm 5\%$)	σ (S/m) ($\pm 5\%$)	ϵ_r	σ (S/m)		
Head 2450	2450	39.20 (37.24~41.16)	1.80 (1.71~1.89)	38.61	1.81	21.6 °C	Mar. 26, 2022
Head 5200	5200	36.00 (34.20~37.80)	4.66 (4.43~4.89)	36.56	4.81	21.3 °C	Mar. 28, 2022
Head 5600	5600	35.50 (33.73~37.28)	5.07 (4.82~5.32)	36.08	5.02	21.6 °C	Mar. 30, 2022
Head 5800	5800	35.30 (33.54~37.07)	5.27 (5.01~5.53)	35.52	5.42	21.8 °C	Mar. 24, 2022

NOTE: The dielectric parameters of the tissue-equivalent liquid should be measured under similar ambient conditions and within 2 °C of the conditions expected during the SAR evaluation to satisfy protocol requirements.

4.2. System Verification Procedure

The system verification is performed for verifying the accuracy of the complete measurement system and performance of the software. The dipole is connected to the signal source consisting of signal generator and amplifier via a directional coupler, N-connector cable and adaption to SMA. It is fed with a power of 100mW (below 5GHz) or 100mW (above 5GHz). To adjust this power a power meter is used. The power sensor is connected to the cable before the system verification to measure the power at this point and do adjustments at the signal generator. At the outputs of the directional coupler both return loss as well as forward power are controlled during the system verification to make sure that emitted power at the dipole is kept constant. This can also be checked by the power drift measurement after the test (result on plot).

The system verification is shown as below picture:

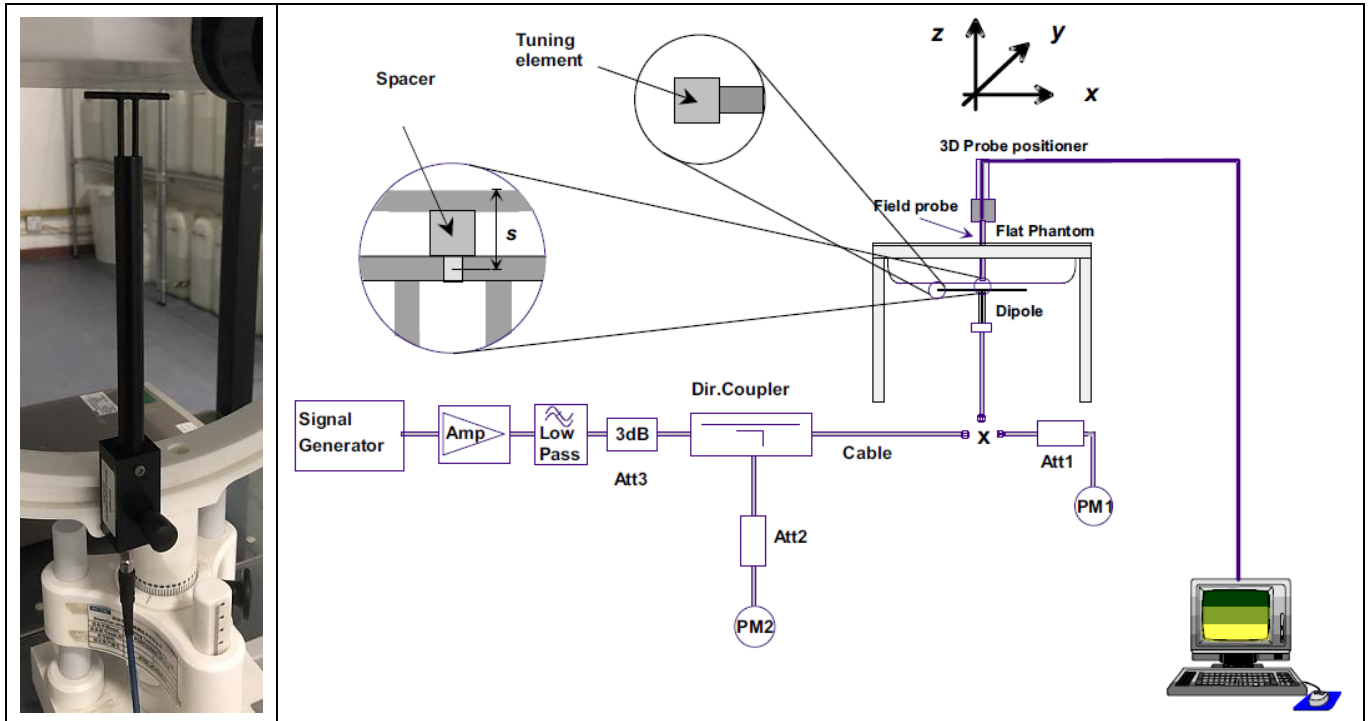

4.2.1. System Verification Results

Comparing to the original SAR value provided by SATIMO, the verification data should be within its specification of $\pm 10\%$. Below table shows the target SAR and measured SAR after normalized to 1W input power. The table below indicates the system performance verification can meet the variation criterion and the plots can be referred to Appendix B of this report.

System Verification	Target SAR (1W) ($\pm 10\%$)		Measured SAR (Normalized to 1W)		Liquid Temp.	Test Date
	1-g (W/Kg)	10-g (W/Kg)	1-g (W/Kg)	10-g (W/Kg)		
2450MHz	53.69 (48.33~59.05)	23.94 (21.55~26.33)	52.73	22.09	21.6 °C	Mar. 26, 2022
5200MHz	162.34 (146.11~178.57)	55.42 (49.88~60.96)	152.94	54.69	21.3 °C	Mar. 28 2022
5600MHz	174.92 (157.43~192.41)	58.63 (52.77~64.49)	176.96	60.57	21.6 °C	Mar. 30, 2022
5800MHz	178.89 (161.01~196.77)	59.32 (53.39~65.25)	163.55	56.96	21.8 °C	Mar. 24, 2022

5. SAR Measurement variability and uncertainty

5.1. SAR measurement variability

Per KDB865664 D01 SAR measurement 100 MHz to 6 GHz, SAR measurement variability must be assessed for each frequency band, which is determined by the SAR probe calibration point and tissue-equivalent medium used for the device measurements. The additional measurements are repeated after the completion of all measurements requiring the same head or body tissue-equivalent medium in a frequency band. The test device should be returned to ambient conditions (normal room temperature) with the battery fully charged before it is re-mounted on the device holder for the repeated measurement(s) to minimize any unexpected variations in the repeated results.

- 1) Repeated measurement is not required when the original highest measured SAR is < 0.80 W/kg; steps 2) through 4) do not apply.
- 2) When the original highest measured SAR is ≥ 0.80 W/kg, repeat that measurement once.
- 3) Perform a second repeated measurement only if the ratio of largest to smallest SAR for the original and first repeated measurements is > 1.20 or when the original or repeated measurement is ≥ 1.45 W/kg (~ 10% from the 1-g SAR limit).
- 4) Perform a third repeated measurement only if the original, first or second repeated measurement is ≥ 1.5 W/kg and the ratio of largest to smallest SAR for the original, first and second repeated measurements is > 1.20 .

5.2. SAR measurement uncertainty

Per KDB865664 D01 SAR Measurement 100 MHz to 6 GHz, when the highest measured 1-g SAR within a frequency band is < 1.5 W/kg, the extensive SAR measurement uncertainty analysis described in IEEE Std 1528-2013 is not required in SAR reports submitted for equipment approval. The equivalent ratio (1.5/1.6) is applied to extremity and occupational exposure conditions.

6. RF Exposure Positions

6.1. Body Worn Accessory

1. Body-worn operating configurations are tested with the belt-clips and holsters attached to the device and positioned against a flat phantom in a normal use configuration (see Figure 6.4.1). Per KDB 648474 D04, body-worn accessory exposure is typically related to voice mode operations when handsets are carried in body-worn accessories. The body-worn accessory procedures in FCC KDB 447498 D01 should be used to test for body-worn accessory SAR compliance, without a headset connected to it. This enables the test results for such configuration to be compatible with that required for hotspot mode when the body-worn accessory test separation distance is greater than or equal to that required for hotspot mode, when applicable. When the reported SAR for body-worn accessory, measured without a headset connected to the handset is $< 1.2 \text{ W/kg}$, the highest reported SAR configuration for that wireless mode and frequency band should be repeated for that body-worn accessory with a headset attached to the handset.
2. Accessories for body-worn operation configurations are divided into two categories: those that do not contain metallic components and those that do contain metallic components. When multiple accessories that do not contain metallic components are supplied with the device, the device is tested with only the accessory that dictates the closest spacing to the body. Then multiple accessories that contain metallic components are test with the device with each accessory. If multiple accessories share an identical metallic component (i.e. the same metallic belt-chip used with different holsters with no other metallic components) only the accessory that dictates the closest spacing to the body is tested.

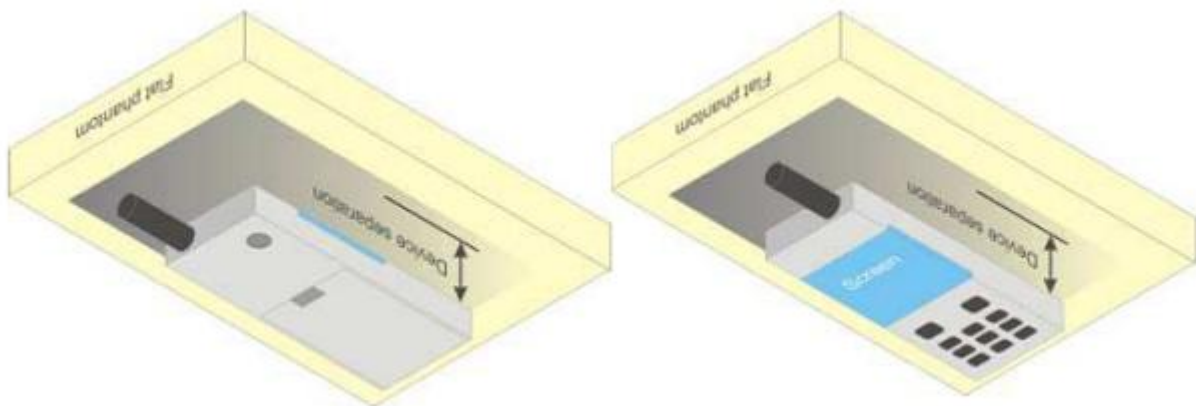

Figure 6.4.1 – Test positions for body-worn devices

6.2. Wireless Router Devices

Some battery-operated handsets have the capability to transmit and receive user through simultaneous transmission of WLAN simultaneously with a separate licensed transmitter. The FCC has provided guidance in FCC KDB Publication 941225 D06 where SAR test considerations for handsets ($L \times W \geq 9 \text{ cm} \times 5 \text{ cm}$) are based on a composite test separation distance of 10mm from the front, back

and edges of the device containing transmitting antennas within 2.5cm of their edges, determined from general mixed use conditions for this type of devices. Since the hotspot SAR results may overlap with the body-worn accessory SAR requirements, the more conservative configurations can be considered, thus excluding some body-worn accessory SAR tests.

When the user enables the personal wireless router functions for the handset, actual operations include simultaneous transmission of both the WLAN transmitter and another licensed transmitter. Both transmitters often do not transmit at the same transmitting frequency and thus cannot be evaluated for SAR under actual use conditions due to the limitations of the SAR assessment probes. Therefore, SAR must be evaluated for each frequency transmission and mode separately and spatially summed with the WLAN transmitter according to FCC KDB Publication 447498 D01 publication procedures. The “Portable Hotspot” feature on the handset was NOT activated during SAR assessments, to ensure the SAR measurements were evaluated for a single transmission frequency RF signal at a time.

7. RF Output Power

7.1. WLAN & Bluetooth Output Power

7.1.1. Output Power Results Of WLAN

Mode	Channel	Frequency (MHz)	Tune-up (dBm)	Output Power (dBm)
802.11b	1	2412	15.50	15.46
	6	2437	15.50	15.43
	11	2462	15.50	15.28
802.11g	1	2412	13.50	13.15
	6	2437	13.50	13.08
	11	2462	13.50	12.92
802.11n HT20	1	2412	12.50	12.16
	6	2437	12.50	12.10
	11	2462	12.50	11.90
802.11n HT40	3	2422	12.50	12.37
	6	2437	12.50	12.36
	9	2452	12.50	12.30

NOTE: Power measurement results of WLAN 2.4G.

Mode	Channel	Frequency (MHz)	Tune-up	Output Power (dBm)
802.11a	36	5180	13.00	11.86
	40	5200	13.00	12.24
	48	5240	13.00	12.54
802.11n HT20	36	5180	13.00	11.84
	40	5200	13.00	12.18
	48	5240	13.00	12.50
802.11n HT40	38	5190	12.50	11.98
	46	5230	12.50	12.39
802.11ac VHT20	36	5180	13.00	11.96
	40	5200	13.00	12.28
	48	5240	13.00	12.51
802.11ac VHT40	38	5190	13.00	12.16
	46	5230	13.00	12.57
802.11ac VHT80	42	5210	12.50	12.29

NOTE: Power measurement results of WLAN 5.2G.

Mode	Channel	Frequency (MHz)	Tune-up	Output Power (dBm)
802.11a	52	5260	12.50	12.13
	56	5280	12.50	12.01
	64	5320	12.50	11.92
802.11n HT20	52	5260	12.00	11.94
	56	5280	12.00	11.78
	64	5320	12.00	11.72
802.11n HT40	54	5270	12.00	11.95
	62	5310	12.00	11.80
802.11ac VHT20	52	5260	12.50	12.10
	56	5280	12.50	12.02
	64	5320	12.50	11.93
802.11ac VHT40	54	5270	12.50	12.15
	62	5310	12.50	11.99
802.11ac VHT80	58	5290	12.00	11.98

NOTE: Power measurement results of WLAN 5.3G.

Mode	Channel	Frequency (MHz)	Tune-up	Output Power (dBm)
802.11a	100	5500	12.50	12.37
	120	5600	12.50	12.29
	140	5700	12.50	12.38
802.11n (HT20)	100	5500	12.50	12.14
	120	5600	12.50	12.02
	140	5700	12.50	12.11
802.11n (HT40)	102	5510	12.50	12.23
	118	5590	12.50	12.08
	134	5670	12.50	12.20
802.11ac (VHT20)	100	5500	12.50	12.40
	120	5600	12.50	12.32
	140	5700	12.50	12.34
802.11ac (VHT40)	102	5510	12.50	12.02
	118	5590	12.50	11.94
	134	5670	12.50	12.05
802.11ac (VHT80)	106	5530	12.50	12.11

NOTE: Power measurement results of WLAN 5.6G.

Mode	Channel	Frequency (MHz)	Tune-up	Output Power (dBm)
802.11a	149	5745	10.50	10.32
	157	5785	10.50	10.24
	165	5825	10.50	9.95
802.11n HT20	149	5745	10.50	10.26
	157	5785	10.50	10.17
	165	5825	10.50	9.87
802.11n HT40	151	5755	10.50	10.24
	159	5795	10.50	10.04
802.11ac VHT20	149	5745	10.50	10.30
	157	5785	10.50	10.23
	165	5825	10.50	9.92
802.11ac VHT40	151	5755	10.50	10.07
	159	5795	10.50	9.90
802.11ac VHT80	155	5775	10.00	9.90

NOTE: Power measurement results of WLAN 5.8G.

7.1.2. Output Power Results Of Bluetooth

	Mode	Channel/Frequency(MHz)	Tune - up	Output Power (dBm)
	BR+EDR	GFSK	0/2402	3.00
39/2441			3.00	1.70
78/2480			3.00	1.05
Pi/4 DQPSK		0/2402	1.00	0.80
		39/2441	1.00	0.34
		78/2480	1.00	-0.29
8DPSK		0/2402	1.00	0.83
		39/2441	1.00	0.35
		78/2480	1.00	-0.27

BLE	Channel	Tune-up	Output Power (dBm)
	0CH	3.00	2.99
	19CH	2.00	1.91
	39CH	2.00	1.59

NOTE: Power measurement results of Bluetooth.

8. Stand-alone SAR test exclusion

Refer to FCC KDB 447498D01, the 1-g SAR and 10-g SAR test exclusion thresholds for 100 MHz to 6 GHz at test separation distances ≤ 50 mm are determined by:

$$[(\text{max. power of channel, including tune-up tolerance, mW}) / (\text{min. test separation distance, mm})] \cdot [\sqrt{f_{\text{(GHz)}}}] \leq 3.0 \text{ for 1-g SAR and } \leq 7.5 \text{ for 10-g extremity SAR, where:}$$

- $f_{\text{(GHz)}}$ is the RF channel transmit frequency in GHz
- Power and distance are rounded to the nearest mW and mm before calculation
- The result is rounded to one decimal place for comparison

When the minimum test separation distance is < 5 mm, a distance of 5 mm is applied to determine SAR test exclusion.

Mode	P_{max} (dBm)	P_{max} (mW)	Distance (mm)	f (GHz)	Calculation Result	SAR Exclusion threshold	SAR test exclusion
Bluetooth	3.00	2.00	10	2.480	0.63	3.00	Yes

NOTE: Standalone SAR test exclusion for Bluetooth.

9. SAR Results

9.1. SAR measurement results

9.1.1. SAR measurement Result of WLAN 2.4G

Test Position of Body-Worn with 10mm	Test channel /Freq.	Test Mode	SAR Value (W/kg)		Power Drift ($\pm 5\%$)	Conducted power (dBm)	Tune-up power (dBm)	Scaled SAR 1g (W/Kg)	Date
			1g	10g					
Front Side	6/2437	802.11b	0.214	0.102	-2.84	15.43	15.50	0.217	2022/3/26
Back Side	6/2437	802.11b	0.058	0.029	0.93	15.43	15.50	0.059	2022/3/26

NOTE: Body-Worn SAR test results of WLAN 2.4G

Test Position of Hotspot with 10mm	Test channel /Freq.	Test Mode	SAR Value (W/kg)		Power Drift ($\pm 5\%$)	Conducted power (dBm)	Tune-up power (dBm)	Scaled SAR 1g (W/Kg)	Date
			1g	10g					
Front Side	6/2437	802.11b	0.214	0.102	-2.84	15.43	15.50	0.217	2022/3/26
Back Side	6/2437	802.11b	0.058	0.029	0.93	15.43	15.50	0.059	2022/3/26
Left Side	6/2437	802.11b	0.252	0.127	-0.62	15.43	15.50	0.256	2022/3/26
Right Side	6/2437	802.11b	0.026	0.016	3.56	15.43	15.50	0.026	2022/3/26
Top Side	6/2437	802.11b	0.049	0.026	-2.35	15.43	15.50	0.050	2022/3/26
Bottom Side	6/2437	802.11b	0.023	0.012	-4.47	15.43	15.50	0.023	2022/3/26

NOTE: Hotspot SAR test results of WLAN 2.4G

9.1.2. SAR measurement Result of WLAN 5.2G

Test Position of Body-Worn with 10mm	Test channel /Freq.	Test Mode	SAR Value (W/kg)		Power Drift (±5%)	Conducted power (dBm)	Tune-up power (dBm)	Scaled SAR 1g (W/Kg)	Date
			1g	10g					
Front Side	40/5200	802.11a	0.192	0.093	1.83	12.24	13.00	0.229	2022/3/28
Back Side	40/5200	802.11a	0.050	0.025	-1.56	12.24	13.00	0.060	2022/3/28

NOTE: Body-Worn SAR test results of WLAN 5.2G

Test Position of Hotspot with 10mm	Test channel /Freq.	Test Mode	SAR Value (W/kg)		Power Drift (±5%)	Conducted power (dBm)	Tune-up power (dBm)	Scaled SAR 1g (W/Kg)	Date
			1g	10g					
Front Side	40/5200	802.11a	0.192	0.093	1.83	12.24	13.00	0.229	2022/3/28
Back Side	40/5200	802.11a	0.050	0.025	-1.56	12.24	13.00	0.060	2022/3/28
Left Side	40/5200	802.11a	0.229	0.099	-1.79	12.24	13.00	0.273	2022/3/28
Right Side	40/5200	802.11a	0.024	0.015	-3.34	12.24	13.00	0.029	2022/3/28
Top Side	40/5200	802.11a	0.046	0.023	1.77	12.24	13.00	0.055	2022/3/28
Bottom Side	40/5200	802.11a	0.025	0.018	0.34	12.24	13.00	0.030	2022/3/28

NOTE: Hotspot SAR test results of WLAN 5.2G

9.1.3. SAR measurement Result of WLAN 5.3G

Test Position of Body-Worn with 10mm	Test channel /Freq.	Test Mode	SAR Value (W/kg)		Power Drift (±5%)	Conducted power (dBm)	Tune-up power (dBm)	Scaled SAR 1g (W/Kg)	Date
			1g	10g					
Front Side	56/5280	802.11a	0.266	0.107	3.31	12.01	12.50	0.298	2022/3/28
Back Side	56/5280	802.11a	0.065	0.033	-2.76	12.01	12.50	0.073	2022/3/28

NOTE: Body-Worn SAR test results of WLAN 5.3G

Test Position of Hotspot with 10mm	Test channel /Freq.	Test Mode	SAR Value (W/kg)		Power Drift (±5%)	Conducted power (dBm)	Tune-up power (dBm)	Scaled SAR 1g (W/Kg)	Date
			1g	10g					
Front Side	56/5280	802.11a	0.266	0.107	3.31	12.01	12.50	0.298	2022/3/28
Back Side	56/5280	802.11a	0.065	0.033	-2.76	12.01	12.50	0.073	2022/3/28
Left Side	56/5280	802.11a	0.317	0.129	0.82	12.01	12.50	0.355	2022/3/28
Right Side	56/5280	802.11a	0.034	0.021	2.34	12.01	12.50	0.038	2022/3/28
Top Side	56/5280	802.11a	0.056	0.030	1.48	12.01	12.50	0.063	2022/3/28

Bottom Side	56/5280	802.11a	0.030	0.019	-4.37	12.01	12.50	0.034	2022/3/28
-------------	---------	---------	-------	-------	-------	-------	-------	-------	-----------

NOTE: Hotspot SAR test results of WLAN 5.3G

9.1.4. SAR measurement Result of WLAN 5.6G

Test Position of Body-Worn with 10mm	Test channel /Freq.	Test Mode	SAR Value (W/kg)		Power Drift (±5%)	Conducted power (dBm)	Tune-up power (dBm)	Scaled SAR 1g (W/Kg)	Date
			1g	10g					
Front Side	120/5600	802.11a	0.201	0.091	-1.49	12.29	12.50	0.211	2022/3/30
Back Side	120/5600	802.11a	0.047	0.021	-0.30	12.29	12.50	0.049	2022/3/30

NOTE: Body-Worn SAR test results of WLAN 5.6G

Test Position of Hotspot with 10mm	Test channel /Freq.	Test Mode	SAR Value (W/kg)		Power Drift (±5%)	Conducted power (dBm)	Tune-up power (dBm)	Scaled SAR 1g (W/Kg)	Date
			1g	10g					
Front Side	120/5600	802.11a	0.201	0.091	-1.49	12.29	12.50	0.211	2022/3/30
Back Side	120/5600	802.11a	0.047	0.021	-0.30	12.29	12.50	0.049	2022/3/30
Left Side	120/5600	802.11a	0.237	0.109	-3.93	12.29	12.50	0.249	2022/3/30
Right Side	120/5600	802.11a	0.025	0.019	-2.79	12.29	12.50	0.026	2022/3/30
Top Side	120/5600	802.11a	0.043	0.024	0.56	12.29	12.50	0.045	2022/3/30
Bottom Side	120/5600	802.11a	0.022	0.017	1.28	12.29	12.50	0.023	2022/3/30

NOTE: Hotspot SAR test results of WLAN 5.6G

9.1.5. SAR measurement Result of WLAN 5.8G

Test Position of Body-Worn with 10mm	Test channel /Freq.	Test Mode	SAR Value (W/kg)		Power Drift (±5%)	Conducted power (dBm)	Tune-up power (dBm)	Scaled SAR 1g (W/Kg)	Date
			1g	10g					
Front Side	157/5785	802.11a	0.245	0.097	3.06	10.24	10.50	0.260	2022/3/24
Back Side	157/5785	802.11a	0.055	0.022	3.66	10.24	10.50	0.058	2022/3/24

NOTE: Body-Worn SAR test results of WLAN 5.8G

Test Position of Hotspot with 10mm	Test channel /Freq.	Test Mode	SAR Value (W/kg)		Power Drift (±5%)	Conducted power (dBm)	Tune-up power (dBm)	Scaled SAR 1g (W/Kg)	Date
			1g	10g					
Front Side	157/5785	802.11a	0.245	0.097	3.06	10.24	10.50	0.260	2022/3/24
Back Side	157/5785	802.11a	0.055	0.022	3.66	10.24	10.50	0.058	2022/3/24
Left Side	157/5785	802.11a	0.292	0.121	-0.82	10.24	10.50	0.310	2022/3/24

Right Side	157/5785	802.11a	0.029	0.012	-1.39	10.24	10.50	0.031	2022/3/24
Top Side	157/5785	802.11a	0.049	0.020	1.24	10.24	10.50	0.052	2022/3/24
Bottom Side	157/5785	802.11a	0.022	0.013	-1.70	10.24	10.50	0.023	2022/3/24

NOTE: Hotspot SAR test results of WLAN 5.8G

9.2. Simultaneous Transmission Analysis

NO simultaneous transmissions are possible for this device of Bluetooth, 2.4G Wi-Fi and 5G Wi-Fi.

10. Appendix A. Photo documentation

Refer to appendix Test Setup photo---SAR

11. Appendix B. System Check Plots

Table of contents
MEASUREMENT 1 System Performance Check - 2450MHz
MEASUREMENT 2 System Performance Check - 5200MHz
MEASUREMENT 3 System Performance Check - 5600MHz
MEASUREMENT 4 System Performance Check - 5800MHz

MEASUREMENT 1

Date of measurement: 26/3/2022

A. Experimental conditions.

Area Scan	<u>dx=12mm dy=12mm, h= 5.00 mm</u>
ZoomScan	<u>7x7x7, dx=5mm dy=5mm dz=5mm</u>
Phantom	<u>Validation plane</u>
Device Position	<u>Dipole</u>
Band	<u>CW2450</u>
Channels	<u>Middle</u>
Signal	<u>CW (Crest factor: 1.0)</u>

B. SAR Measurement Results

Frequency (MHz)	2450.000000
Relative permittivity (real part)	38.612082
Relative permittivity (imaginary part)	13.282752
Conductivity (S/m)	1.807930
Variation (%)	0.140000

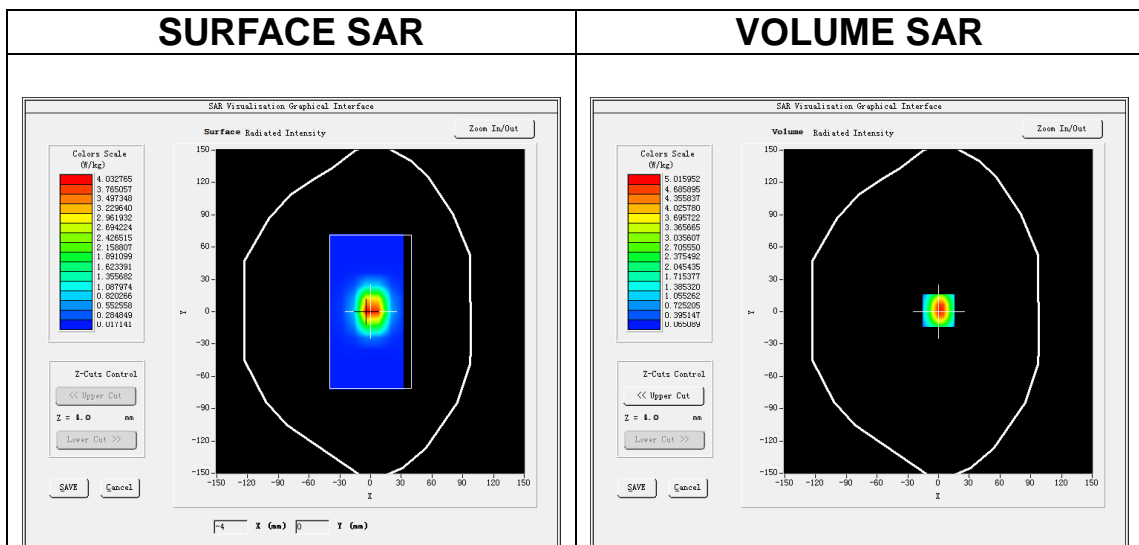

Maximum location: X=0.00, Y=1.00

SAR Peak: 8.14 W/kg

SAR 10g (W/Kg)	2.209104
SAR 1g (W/Kg)	5.273173

Z (mm)	0.00	4.00	9.00	14.00	19.00	24.00	29.00
SAR (W/Kg)	8.0338	5.0122	2.6913	1.4807	0.8382	0.4674	0.2687

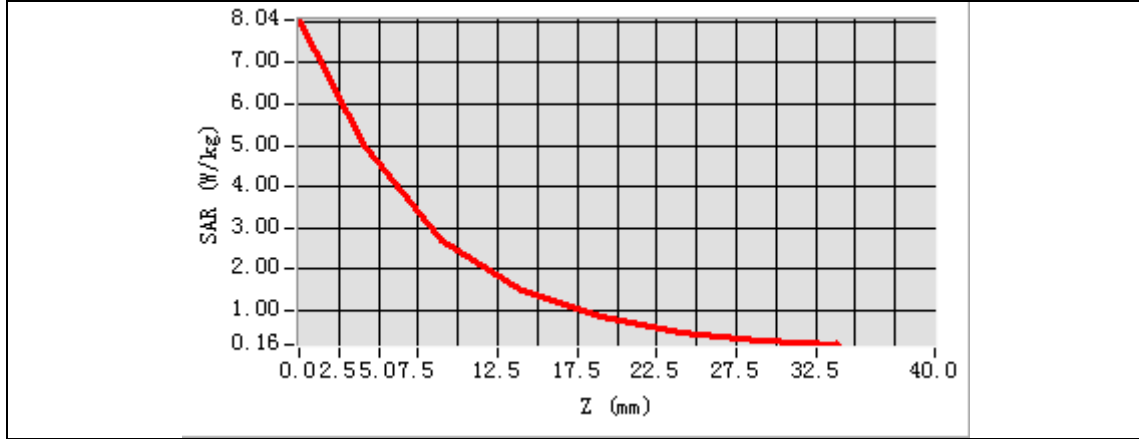

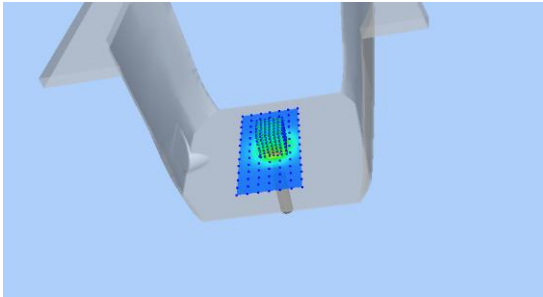
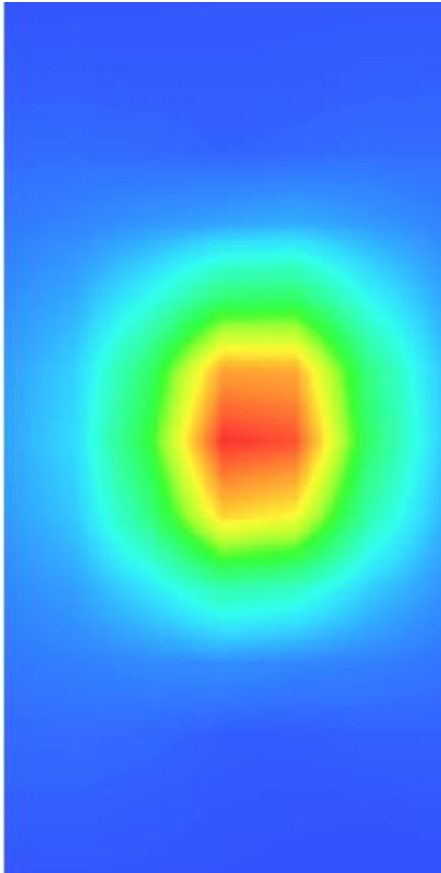
3D screen shot	Hot spot position
	

MEASUREMENT 2

Date of measurement: 28/3/2022

A. Experimental conditions.

Area Scan	<u>dx=10mm dy=10mm, h= 2.00 mm</u>
ZoomScan	<u>7x7x12,dx=4mm dy=4mm dz=2mm</u>
Phantom	<u>Validation plane</u>
Device Position	<u>Dipole</u>
Band	<u>CW5200</u>
Channels	<u>Middle</u>
Signal	<u>CW (Crest factor: 1.0)</u>

B. SAR Measurement Results

Frequency (MHz)	5200.000000
Relative permittivity (real part)	36.557546
Relative permittivity (imaginary part)	16.634934
Conductivity (S/m)	4.805648
Variation (%)	2.390000

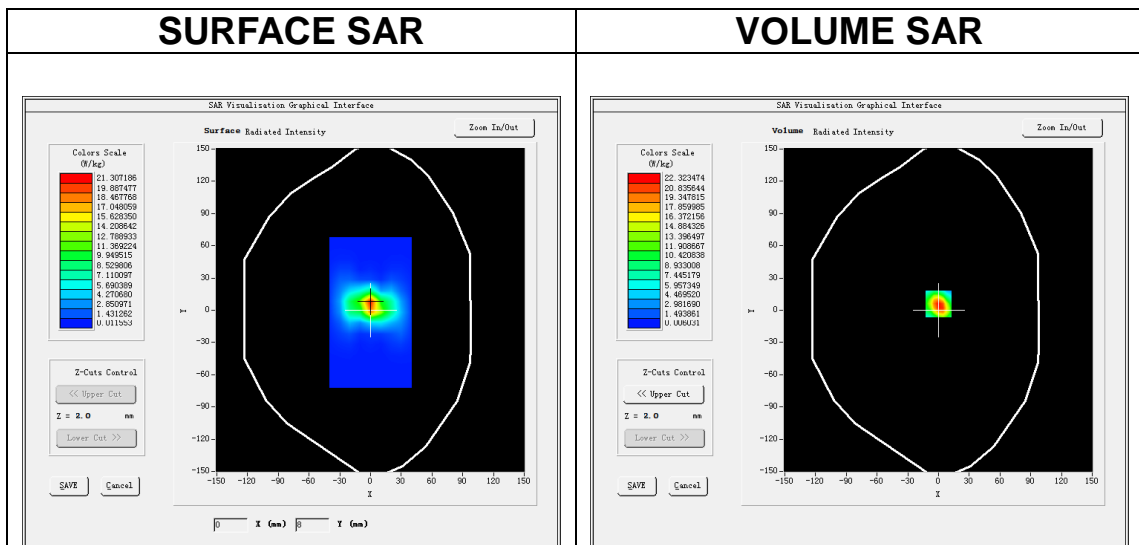

Maximum location: X=0.00, Y=6.00

SAR Peak: 40.06 W/kg

SAR 10g (W/Kg)	5.469316
SAR 1g (W/Kg)	15.294329

Z (m)	0.00	2.00	4.00	6.00	8.00	10.00	12.00	14.00	16.00	18.00	20.00	22.00
SAR (W/Kg)	37.815	22.392	11.391	5.6696	2.8259	1.4052	0.7180	0.3647	0.1823	0.1035	0.0525	0.0320

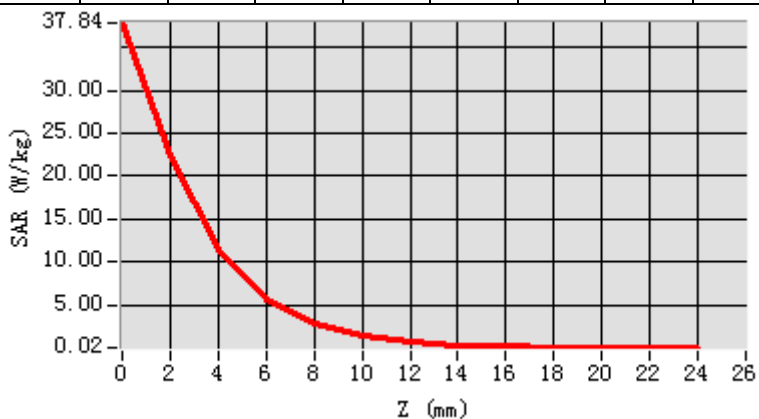

3D screen shot

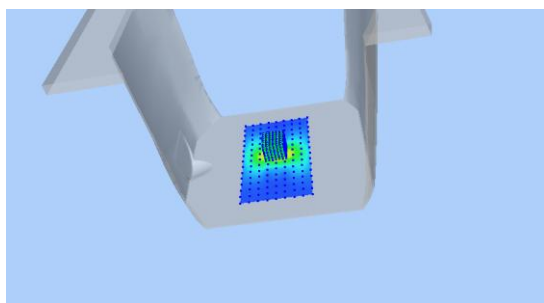

Hot spot position

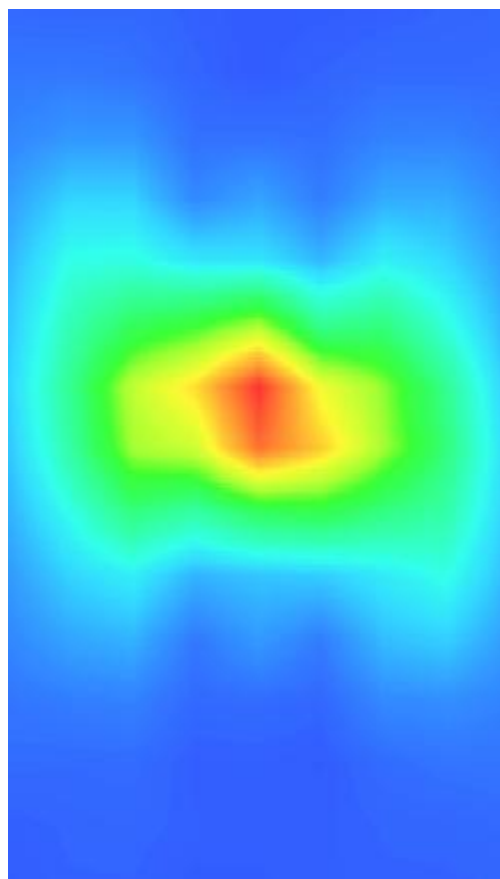

MEASUREMENT 3

Date of measurement: 30/3/2022

A. Experimental conditions.

Area Scan	<u>dx=10mm dy=10mm, h= 2.00 mm</u>
ZoomScan	<u>7x7x12,dx=4mm dy=4mm dz=2mm</u>
Phantom	<u>Validation plane</u>
Device Position	<u>Dipole</u>
Band	<u>CW5600</u>
Channels	<u>Middle</u>
Signal	<u>CW (Crest factor: 1.0)</u>

B. SAR Measurement Results

Frequency (MHz)	5600.000000
Relative permittivity (real part)	36.082672
Relative permittivity (imaginary part)	16.144519
Conductivity (S/m)	5.022739
Variation (%)	2.770000

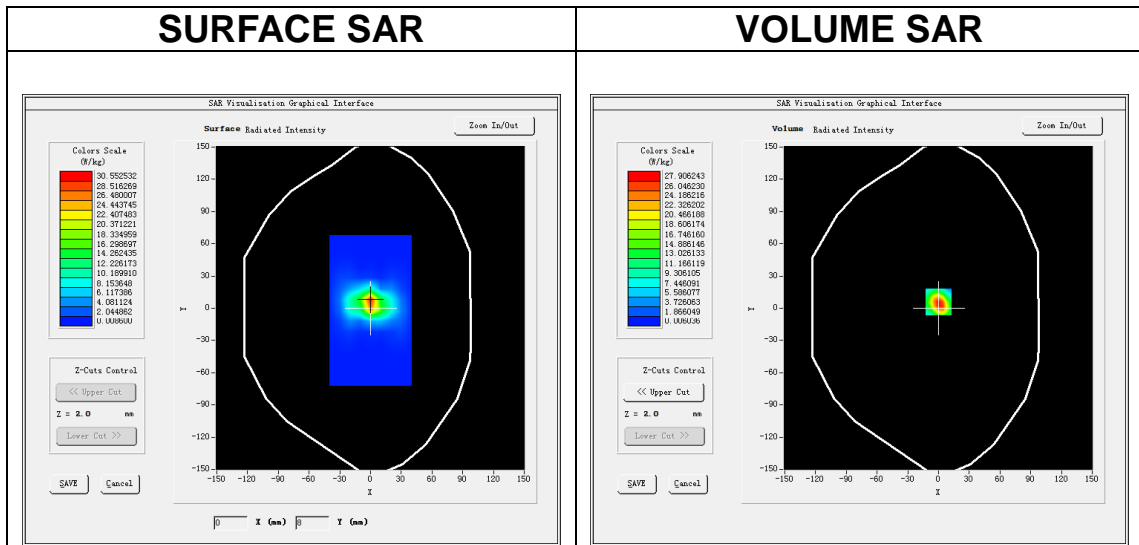

Maximum location: X=0.00, Y=6.00

SAR Peak: 51.23 W/kg

SAR 10g (W/Kg)	6.057001
SAR 1g (W/Kg)	17.696119

Z (m m)	0.00	2.00	4.00	6.00	8.00	10.0	12.0	14.0	16.0	18.0	20.0	22.0
SAR (W/ Kg)	54.1 44	31.9 78	16.3 31	8.17 34	4.08 16	3.81 02	1.03 65	0.46 19	0.27 40	0.13 42	0.07 78	0.05 81

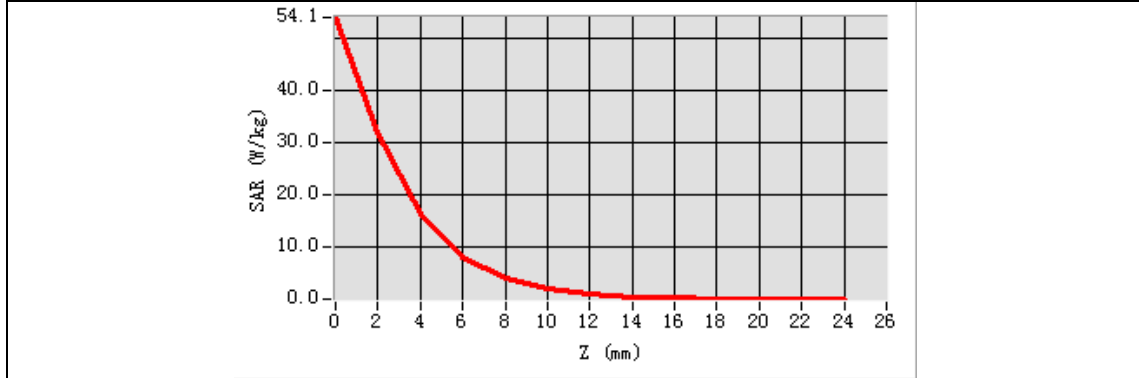

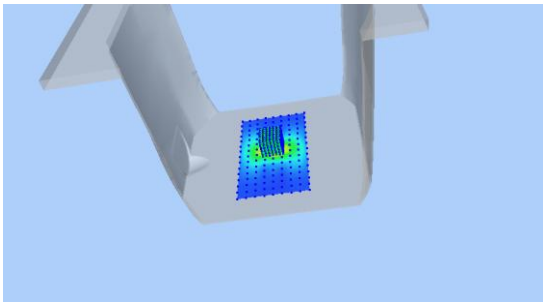
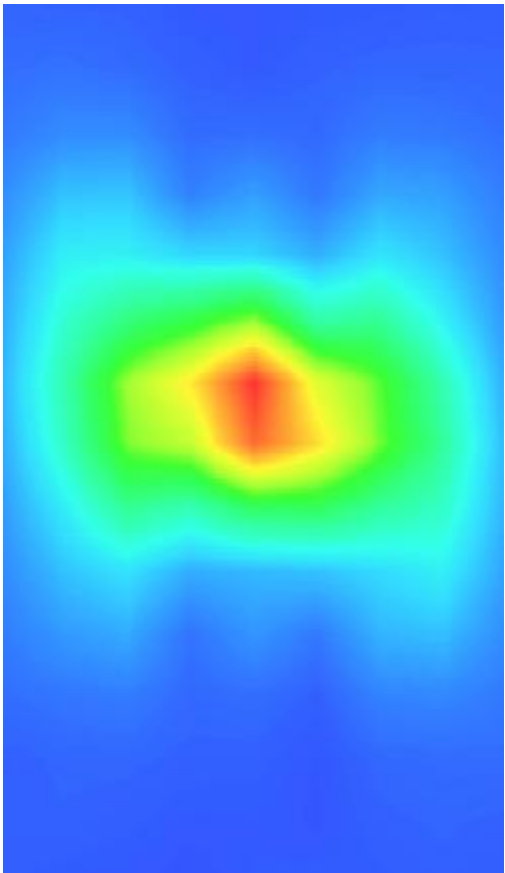
3D screen shot	Hot spot position
	

MEASUREMENT 4

Date of measurement: 24/3/2022

A. Experimental conditions.

Area Scan	<u>dx=10mm dy=10mm, h= 2.00 mm</u>
ZoomScan	<u>7x7x12,dx=4mm dy=4mm dz=2mm</u>
Phantom	<u>Validation plane</u>
Device Position	<u>Dipole</u>
Band	<u>CW5800</u>
Channels	<u>Middle</u>
Signal	<u>CW (Crest factor: 1.0)</u>

B. SAR Measurement Results

Frequency (MHz)	5800.000000
Relative permittivity (real part)	35.517083
Relative permittivity (imaginary part)	16.822688
Conductivity (S/m)	5.420644
Variation (%)	2.980000

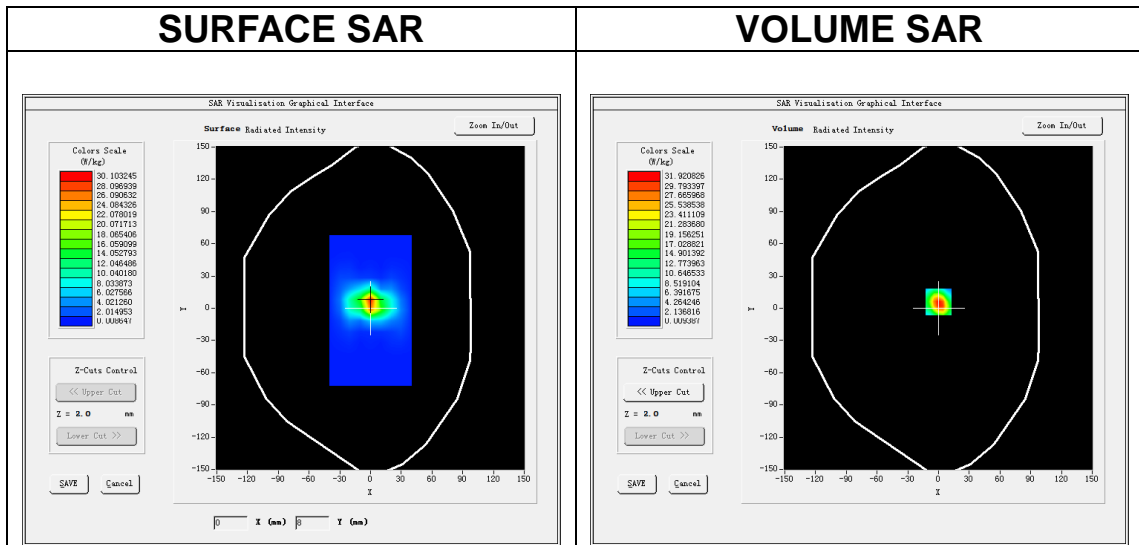

Maximum location: X=0.00, Y=6.00

SAR Peak: 57.37 W/kg

SAR 10g (W/Kg)	5.696399
SAR 1g (W/Kg)	16.355348

Z (m m)	0.00	2.00	4.00	6.00	8.00	10.0	12.0	14.0	16.0	18.0	20.0	22.0
SAR (W/ Kg)	54.0 57	31.9 12	16.1 08	8.17 77	4.08 34	2.05 58	1.03 52	0.51 23	0.27 53	0.15 54	0.07 50	0.04 52

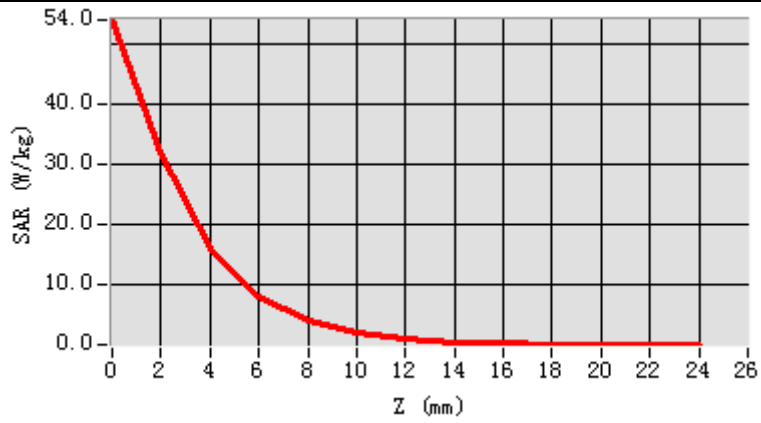

3D screen shot

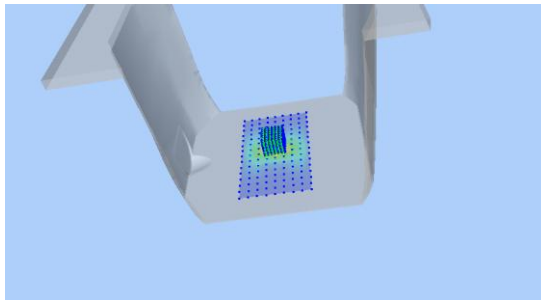

Hot spot position

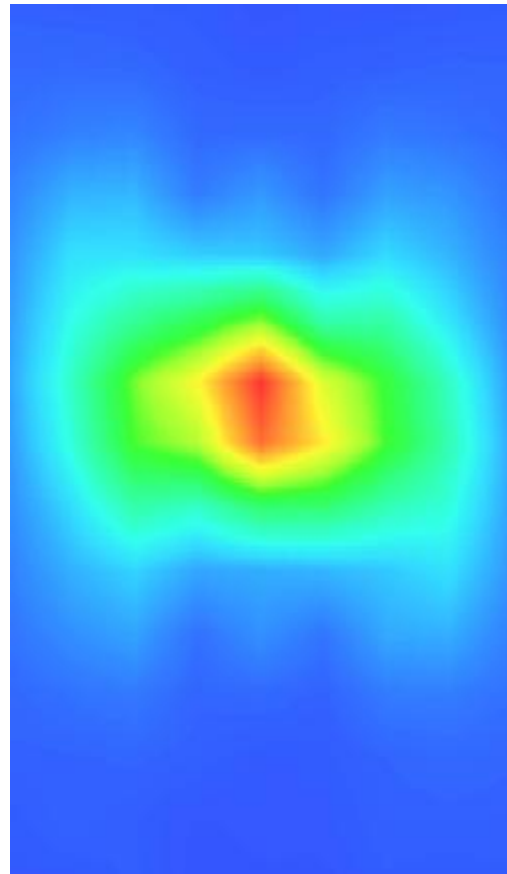

12. Appendix C. Plots of High SAR Measurement

Table of contents
MEASUREMENT 1 WLAN 5.2G Body
MEASUREMENT 2 WLAN 5.3G Body
MEASUREMENT 3 WLAN 5.6G Body
MEASUREMENT 4 WLAN 5.8G Body
MEASUREMENT 5 WLAN 2.4G Body

MEASUREMENT 1

Date of measurement: 28/3/2022

A. Experimental conditions.

Area Scan	<u>dx=10mm dy=10mm, h= 2.00 mm</u>
ZoomScan	<u>7x7x12,dx=4mm dy=4mm dz=2mm</u>
Phantom	<u>Validation plane</u>
Device Position	<u>Body</u>
Band	<u>IEEE 802.11a U-NII</u>
Channels	<u>Middle</u>
Signal	<u>IEEE802.11a (Crest factor: 1.0)</u> <u>Duty Cycle: 1:1</u>

B. SAR Measurement Results

Frequency (MHz)	5200.000000
Relative permittivity (real part)	36.557545
Relative permittivity (imaginary part)	16.634933
Conductivity (S/m)	4.805648
Variation (%)	-1.790000

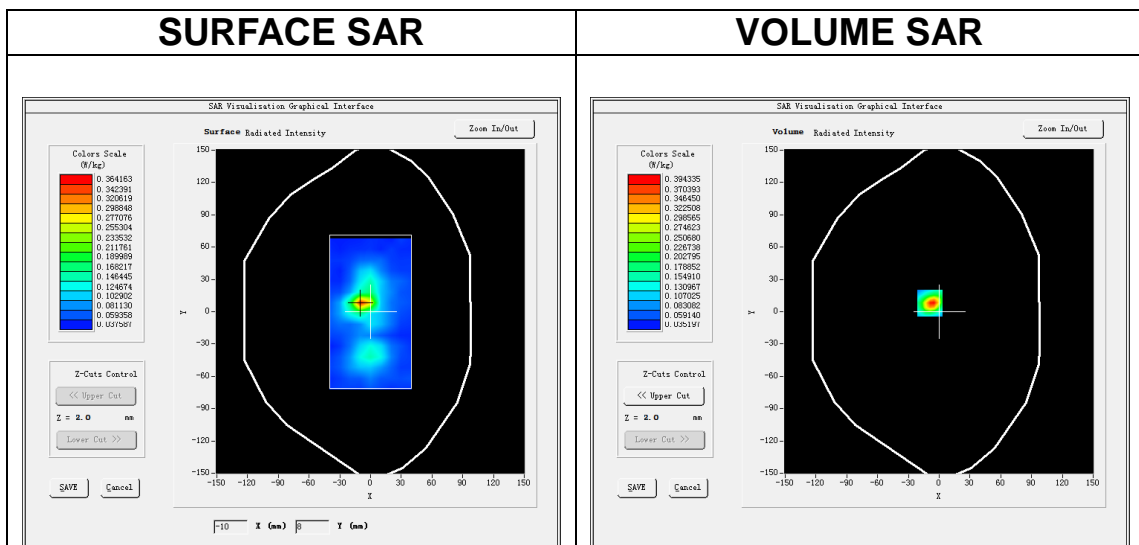

Maximum location: X=-9.00, Y=8.00
SAR Peak: 0.69 W/kg

SAR 10g (W/Kg)	0.098628
SAR 1g (W/Kg)	0.228891

Z (m)	0.00	2.00	4.00	6.00	8.00	10.0	12.0	14.0	16.0	18.0	20.0	22.0
SAR (W/Kg)	0.6529	0.3943	0.1745	0.1287	0.0772	0.0725	0.0497	0.0463	0.0440	0.0420	0.0384	0.0428

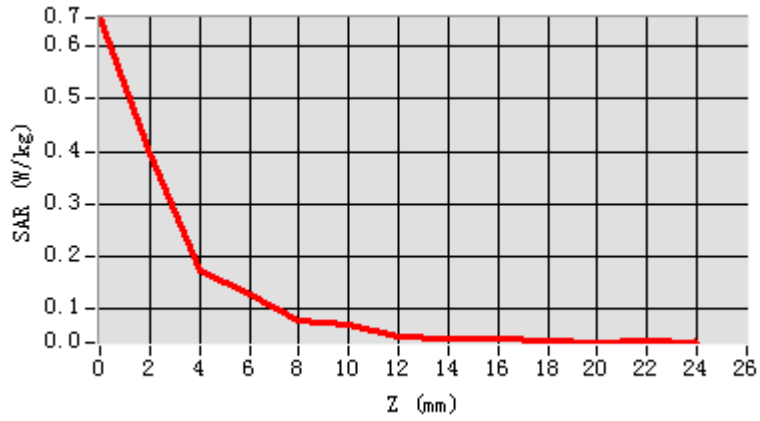

3D screen shot

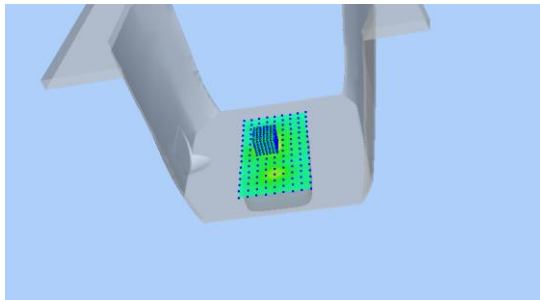

Hot spot position

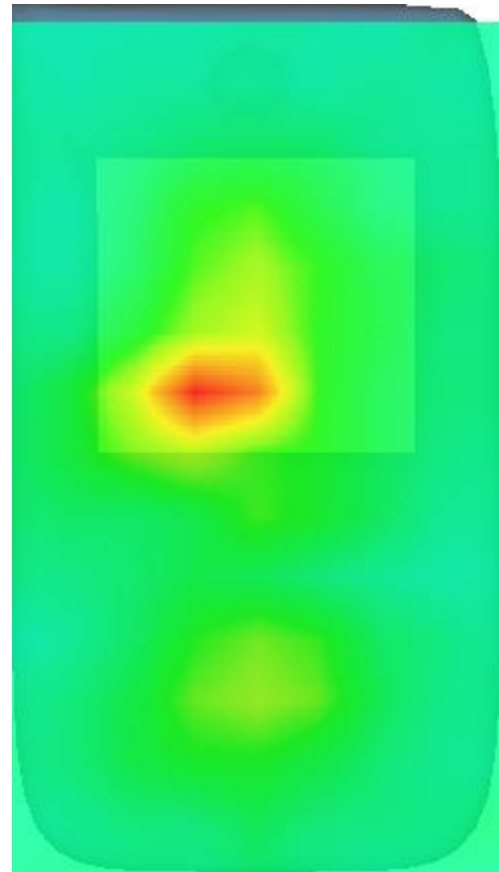

MEASUREMENT 2

Date of measurement: 28/3/2022

A. Experimental conditions.

Area Scan	<u>dx=10mm dy=10mm, h= 2.00 mm</u>
ZoomScan	<u>7x7x12,dx=4mm dy=4mm dz=2mm</u>
Phantom	<u>Validation plane</u>
Device Position	<u>Body</u>
Band	<u>IEEE 802.11a U-NII</u>
Channels	<u>Middle</u>
Signal	<u>IEEE802.11a (Crest factor: 1.0)</u> <u>Duty Cycle: 1:1</u>

B. SAR Measurement Results

Frequency (MHz)	5280.000000
Relative permittivity (real part)	36.448353
Relative permittivity (imaginary part)	16.720093
Conductivity (S/m)	4.904561
Variation (%)	0.820000

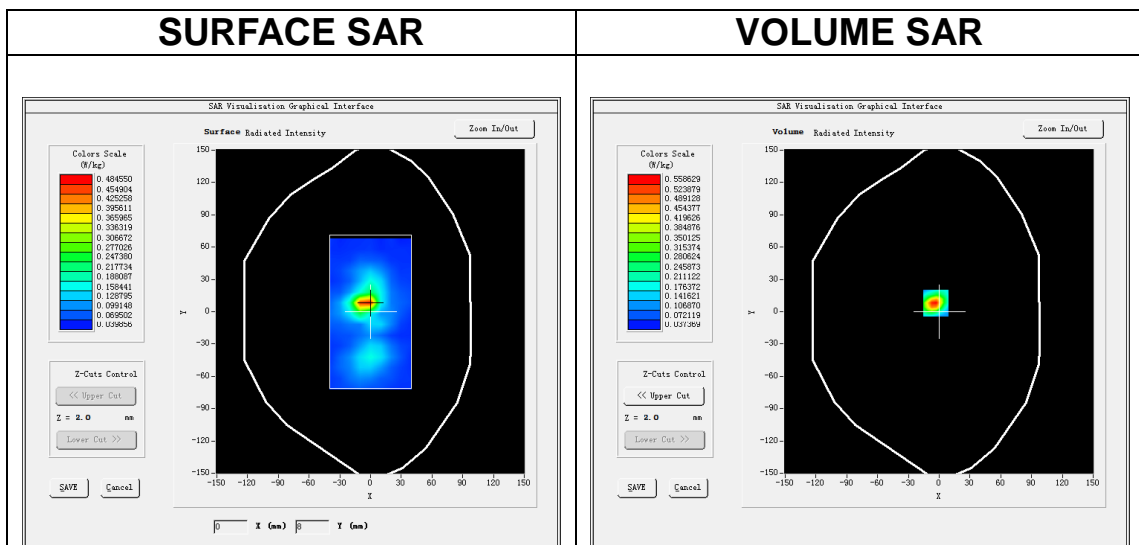

Maximum location: X=-3.00, Y=8.00
SAR Peak: 0.97 W/kg

SAR 10g (W/Kg)	0.128676
SAR 1g (W/Kg)	0.316990

Z (m m)	0.00	2.00	4.00	6.00	8.00	10.0	12.0	14.0	16.0	18.0	20.0	22.0
SAR (W/ Kg)	0.9236	0.5586	0.3044	0.1710	0.1056	0.0762	0.0634	0.0509	0.0464	0.0478	0.0429	0.0421

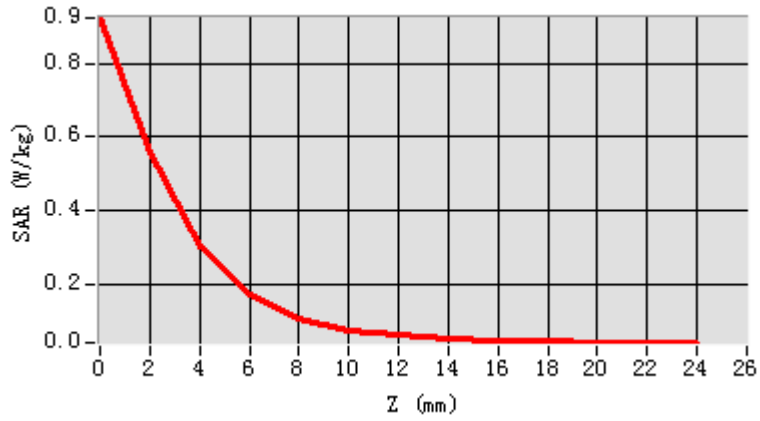

3D screen shot

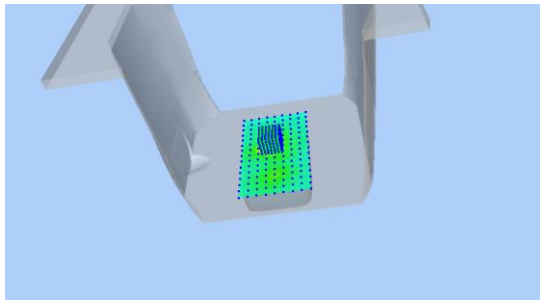

Hot spot position

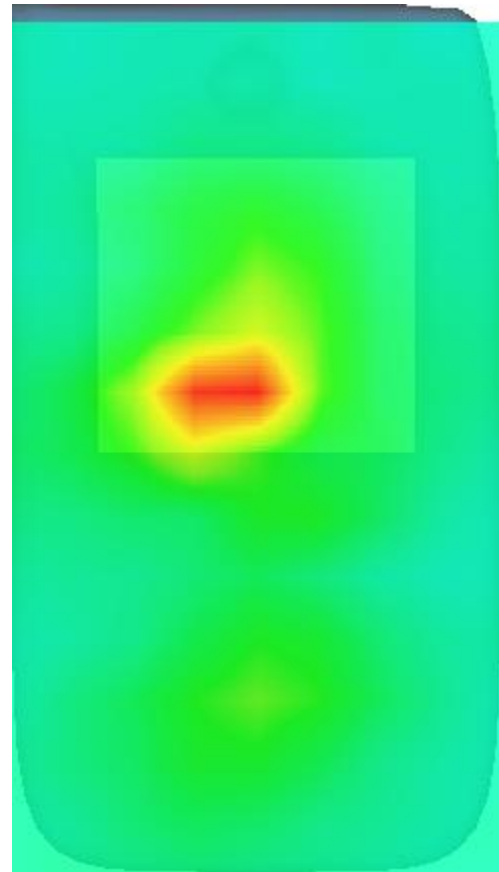

MEASUREMENT 3

Date of measurement: 30/3/2022

A. Experimental conditions.

Area Scan	<u>dx=10mm dy=10mm, h= 2.00 mm</u>
ZoomScan	<u>7x7x12,dx=4mm dy=4mm dz=2mm</u>
Phantom	<u>Validation plane</u>
Device Position	<u>Body</u>
Band	<u>IEEE 802.11a U-NII</u>
Channels	<u>Middle</u>
Signal	<u>IEEE802.11a (Crest factor: 1.0) Duty Cycle: 1:1</u>

B. SAR Measurement Results

Frequency (MHz)	5600.000000
Relative permittivity (real part)	36.082672
Relative permittivity (imaginary part)	16.144520
Conductivity (S/m)	5.022739
Variation (%)	-3.930000

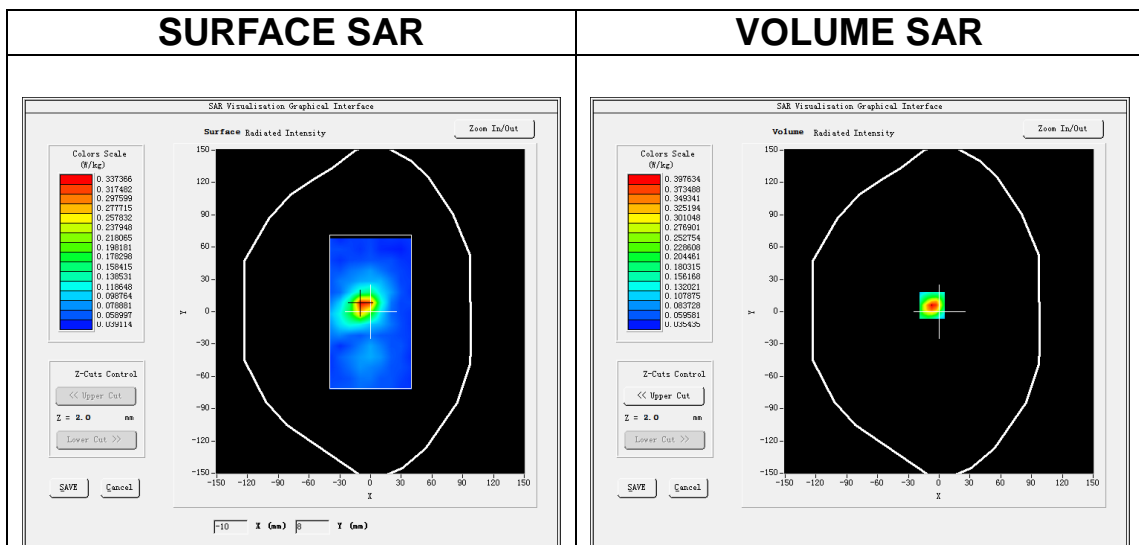

Maximum location: X=-7.00, Y=6.00
SAR Peak: 0.68 W/kg

SAR 10g (W/Kg)	0.109452
SAR 1g (W/Kg)	0.236650

Z (m)	0.00	2.00	4.00	6.00	8.00	10.0	12.0	14.0	16.0	18.0	20.0	22.0
SAR (W/Kg)	0.6478	0.3976	0.2211	0.1334	0.0867	0.0681	0.0527	0.0544	0.0498	0.0499	0.0483	0.0450

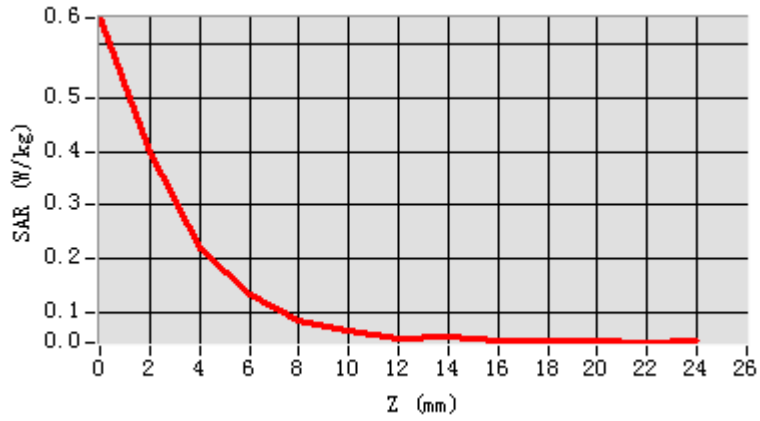

3D screen shot

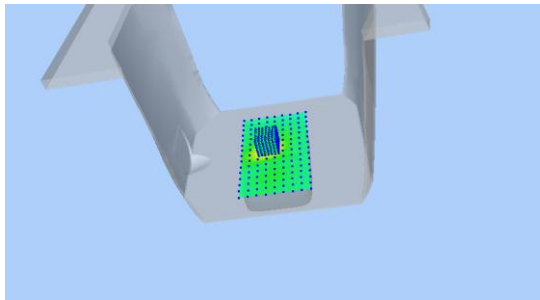

Hot spot position

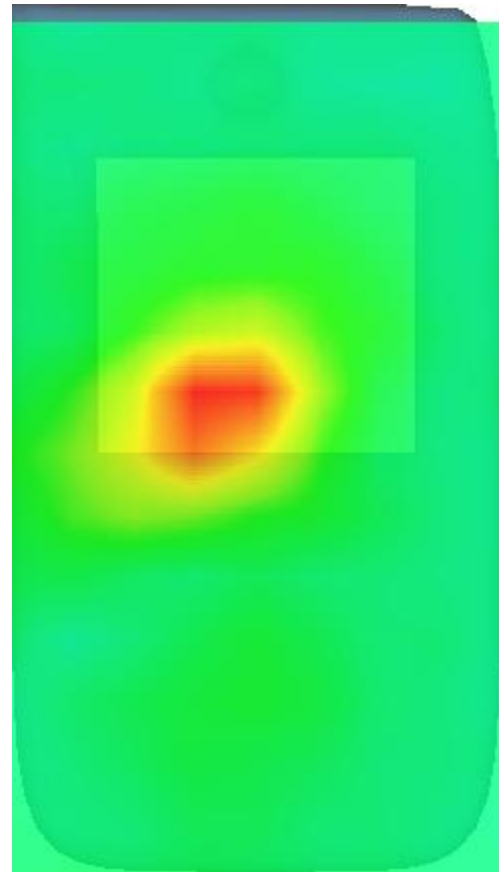

MEASUREMENT 4

Date of measurement: 24/3/2022

A. Experimental conditions.

Area Scan	<u>dx=10mm dy=10mm, h= 2.00 mm</u>
ZoomScan	<u>7x7x12,dx=4mm dy=4mm dz=2mm</u>
Phantom	<u>Validation plane</u>
Device Position	<u>Body</u>
Band	<u>IEEE 802.11a U-NII</u>
Channels	<u>Middle</u>
Signal	<u>IEEE802.11a (Crest factor: 1.0)</u> <u>Duty Cycle: 1:1</u>

B. SAR Measurement Results

Frequency (MHz)	5785.000000
Relative permittivity (real part)	35.593034
Relative permittivity (imaginary part)	16.698245
Conductivity (S/m)	5.366630
Variation (%)	-0.820000

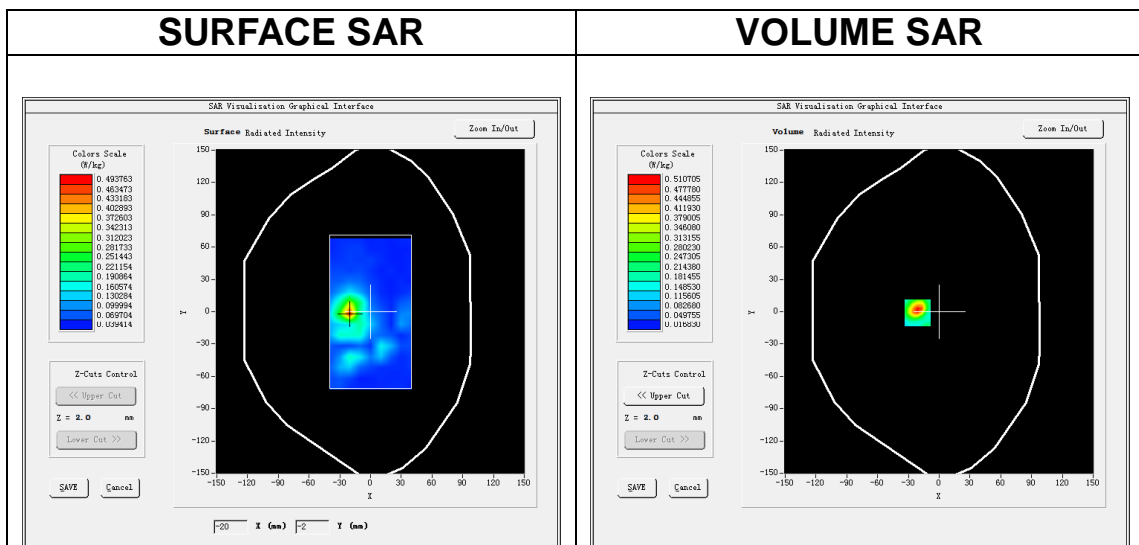

Maximum location: X=-21.00, Y=-1.00
SAR Peak: 0.94 W/kg

SAR 10g (W/Kg)	0.121379
SAR 1g (W/Kg)	0.292473

Z (m m)	0.00	2.00	4.00	6.00	8.00	10.00	12.00	14.00	16.00	18.00	20.00	22.00
SAR (W/Kg)	0.8980	0.5107	0.1586	0.1367	0.0677	0.0605	0.0474	0.0439	0.0467	0.0168	0.0414	0.0461

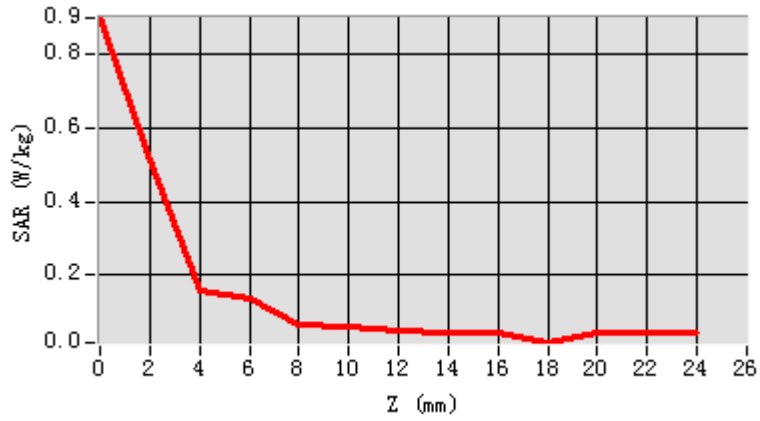

3D screen shot

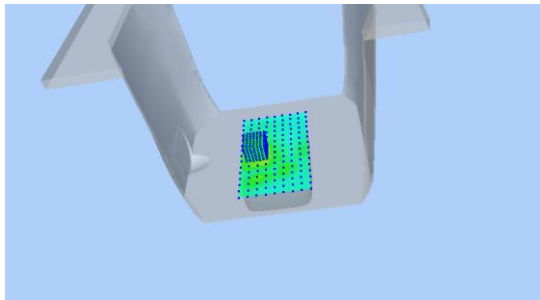

Hot spot position

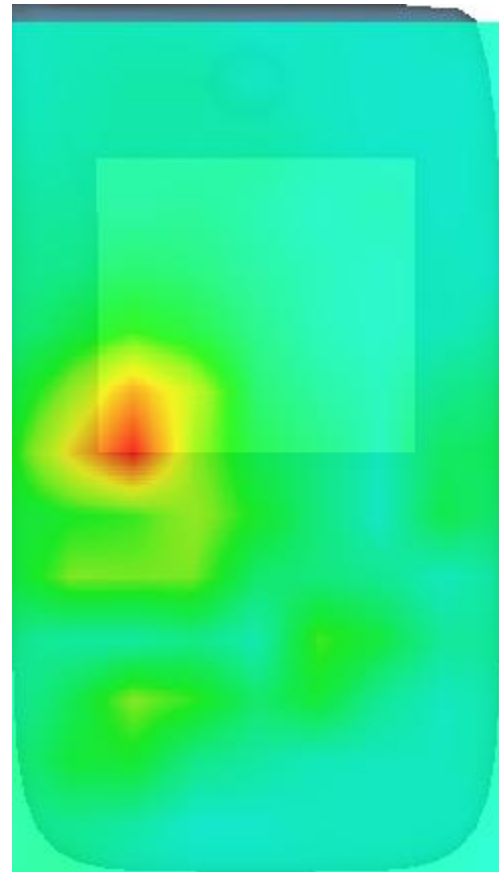

MEASUREMENT 5

Date of measurement: 26/3/2022

A. Experimental conditions.

Area Scan	<u>dx=12mm dy=12mm, h= 5.00 mm</u>
ZoomScan	<u>7x7x7, dx=5mm dy=5mm dz=5mm</u>
Phantom	<u>Validation plane</u>
Device Position	<u>Body</u>
Band	<u>IEEE 802.11b ISM</u>
Channels	<u>Middle</u>
Signal	<u>IEEE802.11b (Crest factor: 1.0)</u> <u>Duty Cycle: 1:1</u>

B. SAR Measurement Results

Frequency (MHz)	2437.000000
Relative permittivity (real part)	38.664181
Relative permittivity (imaginary part)	13.201252
Conductivity (S/m)	1.787303
Variation (%)	-0.620000

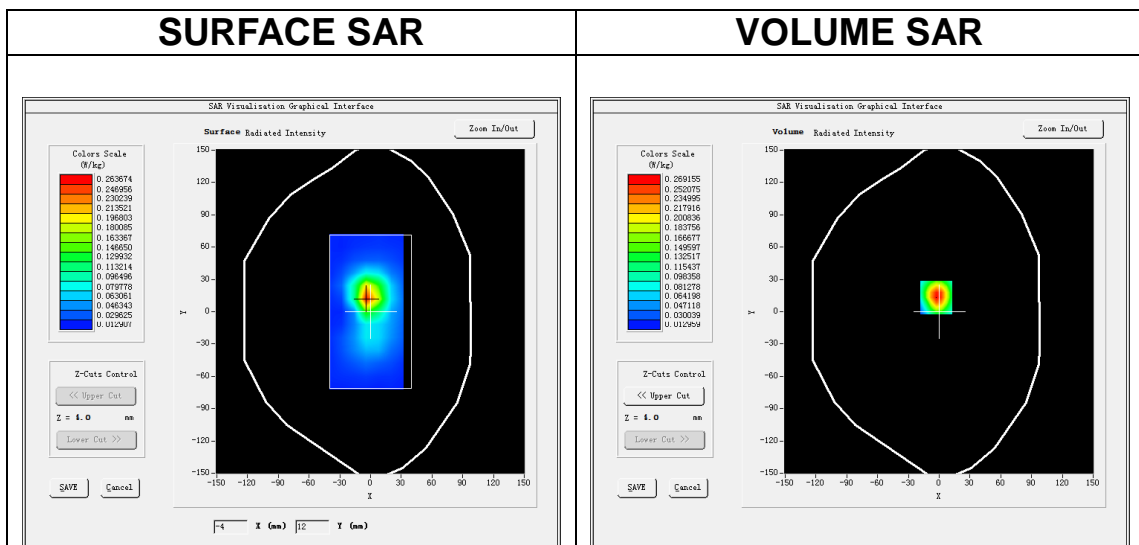

Maximum location: X=-3.00, Y=13.00
SAR Peak: 0.43 W/kg

SAR 10g (W/Kg)	0.127096
SAR 1g (W/Kg)	0.251729

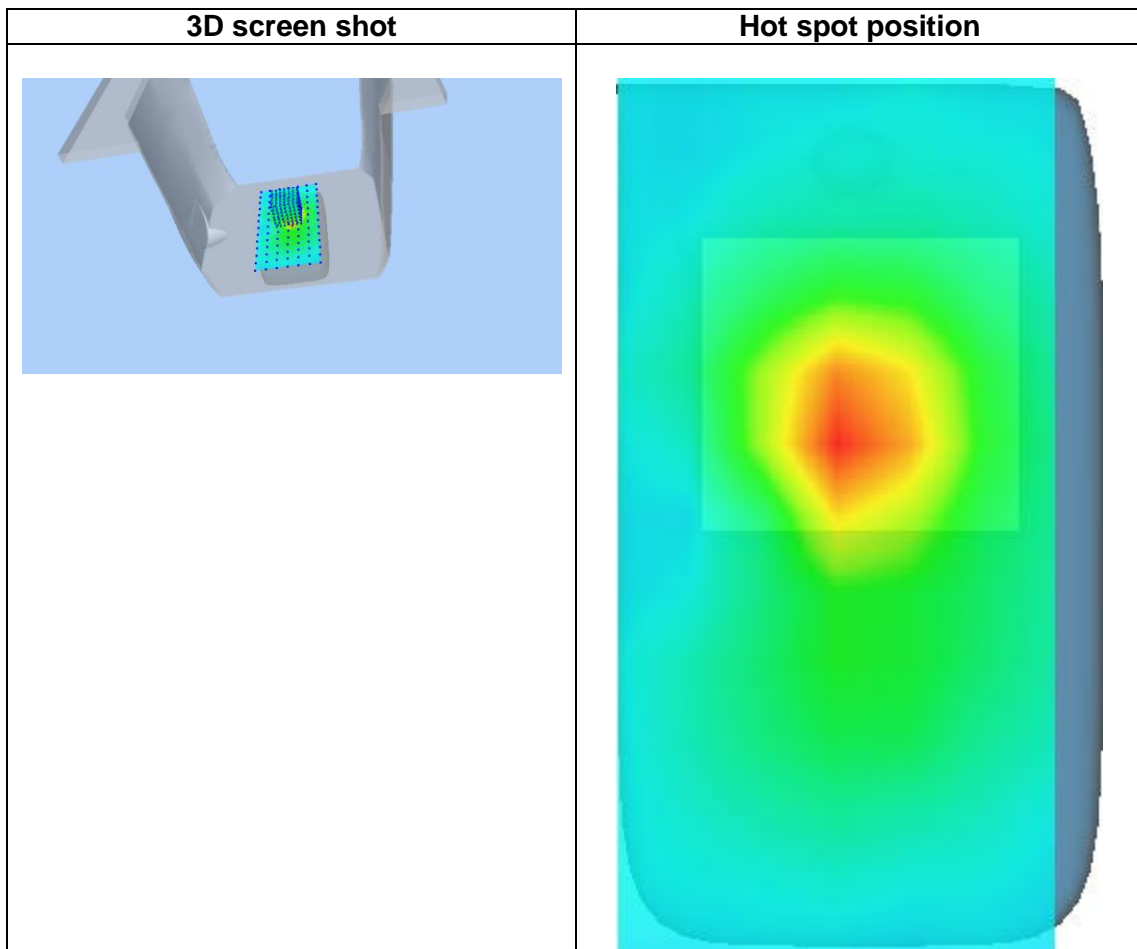
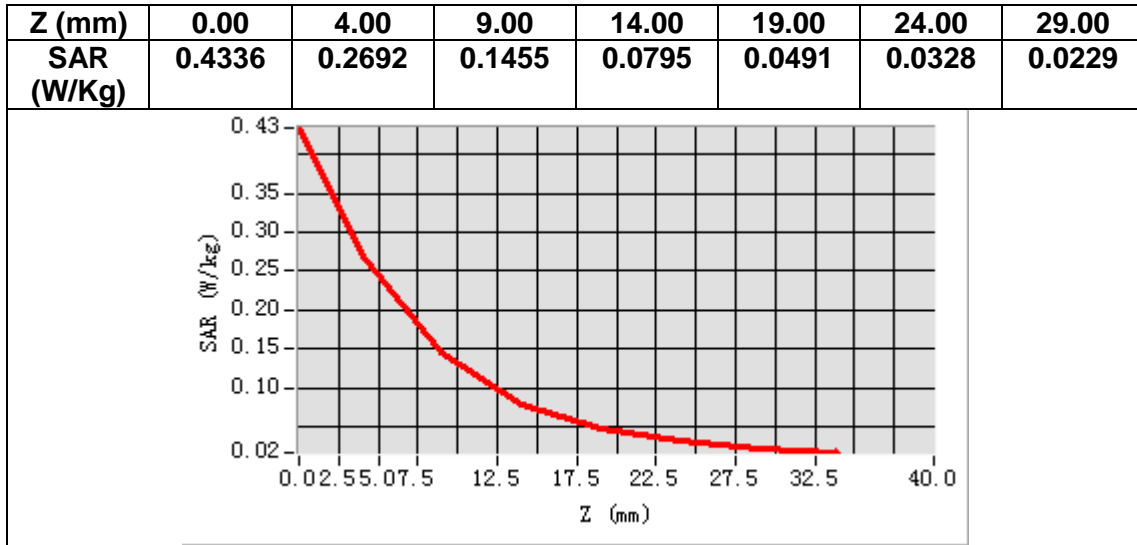

13. Appendix D. Calibration Certificate

Table of contents
E Field Probe - SN 08/16 EPGO287
2450 MHz Dipole - SN 03/15 DIP 2G450-352
5000-6000 MHz Dipole - SN 13/14 WGA 33
Extended Calibration Certificate



COMOSAR E-Field Probe Calibration Report

Ref : ACR.60.1.21.MVGB.A

**SHENZHEN NTEK TESTING TECHNOLOGY
CO., LTD.**

**BUILDING E, FENDA SCIENCE PARK, SANWEI
COMMUNITY, XIXIANG STREET,
BAO'AN DISTRICT, SHENZHEN GUANGDONG, CHINA
MVG COMOSAR DOSIMETRIC E-FIELD PROBE
SERIAL NO.: SN 08/16 EPGO287**

Calibrated at MVG

Z.I. de la pointe du diable

**Technopôle Brest Iroise – 295 avenue Alexis de Rochon
29280 PLOUZANE - FRANCE**

Calibration date: 02/01/2022



Accreditations #2-6789 and #2-6814
Scope available on www.cofrac.fr

Summary:

This document presents the method and results from an accredited COMOSAR E-Field Probe calibration performed at MVG, using the CALIPROBE test bench, for use with a MVG COMOSAR system only. The test results covered by accreditation are traceable to the International System of Units (SI).



COMOSAR E-FIELD PROBE CALIBRATION REPORT

Ref: ACR.60.1.21.MVGB.A

	Name	Function	Date	Signature
Prepared by :	Jérôme Luc	Technical Manager	2/1/2022	<i>JS</i>
Checked by :	Jérôme Luc	Technical Manager	2/1/2022	<i>JS</i>
Approved by :	Yann Toutain	Laboratory Director	2/1/2022	<i>Yann Toutain</i>

Mode d'emploi
2022.02.0
1 10:07:13
+01'00'

PHILIPS

	Customer Name
Distribution :	SHENZHEN NTEK TESTING TECHNOLOGY CO., LTD.

Issue	Name	Date	Modifications
A	Jérôme Luc	2/1/2022	Initial release



COMOSAR E-FIELD PROBE CALIBRATION REPORT

Ref. ACR.60.1.21.MVGB.A

TABLE OF CONTENTS

1	Device Under Test	4
2	Product Description	4
2.1	General Information	4
3	Measurement Method	4
3.1	Linearity	4
3.2	Sensitivity	5
3.3	Lower Detection Limit	5
3.4	Isotropy	5
3.1	Boundary Effect	5
4	Measurement Uncertainty	6
5	Calibration Measurement Results	6
5.1	Sensitivity in air	6
5.2	Linearity	7
5.3	Sensitivity in liquid	8
5.4	Isotropy	9
6	List of Equipment	10



COMOSAR E-FIELD PROBE CALIBRATION REPORT

Ref: ACR.60.1.21.MVGB.A

1 DEVICE UNDER TEST

Device Under Test	
Device Type	COMOSAR DOSIMETRIC E FIELD PROBE
Manufacturer	MVG
Model	SSE2
Serial Number	SN 08/16 EPGO287
Product Condition (new / used)	Used
Frequency Range of Probe	0.15 GHz-6GHz
Resistance of Three Dipoles at Connector	Dipole 1: R1=0.211 MΩ Dipole 2: R2=0.199 MΩ Dipole 3: R3=0.199 MΩ

2 PRODUCT DESCRIPTION

2.1 GENERAL INFORMATION

MVG’s COMOSAR E field Probes are built in accordance to the IEEE 1528, FCC KDB865664 D01, CENELEC EN62209 and CEI/IEC 62209 standards.



Figure 1 – MVG COMOSAR Dosimetric E field Dipole

Probe Length	330 mm
Length of Individual Dipoles	2 mm
Maximum external diameter	8 mm
Probe Tip External Diameter	2.5 mm
Distance between dipoles / probe extremity	1 mm

3 MEASUREMENT METHOD

The IEEE 1528, FCC KDB865664 D01, CENELEC EN62209 and CEI/IEC 62209 standards provide recommended practices for the probe calibrations, including the performance characteristics of interest and methods by which to assess their affect. All calibrations / measurements performed meet the fore mentioned standards.

3.1 LINEARITY

The evaluation of the linearity was done in free space using the waveguide, performing a power sweep to cover the SAR range 0.01W/kg to 100W/kg.



COMOSAR E-FIELD PROBE CALIBRATION REPORT

Ref: ACR.60.1.21.MVGB.A

3.2 SENSITIVITY

The sensitivity factors of the three dipoles were determined using a two step calibration method (air and tissue simulating liquid) using waveguides as outlined in the standards.

3.3 LOWER DETECTION LIMIT

The lower detection limit was assessed using the same measurement set up as used for the linearity measurement. The required lower detection limit is 10 mW/kg.

3.4 ISOTROPY

The axial isotropy was evaluated by exposing the probe to a reference wave from a standard dipole with the dipole mounted under the flat phantom in the test configuration suggested for system validations and checks. The probe was rotated along its main axis from 0 to 360 degrees in 15-degree steps. The hemispherical isotropy is determined by inserting the probe in a thin plastic box filled with tissue-equivalent liquid, with the plastic box illuminated with the fields from a half wave dipole. The dipole is rotated about its axis (0°–180°) in 15° increments. At each step the probe is rotated about its axis (0°–360°).

3.1 BOUNDARY EFFECT

The boundary effect is defined as the deviation between the SAR measured data and the expected exponential decay in the liquid when the probe is oriented normal to the interface. To evaluate this effect, the liquid filled flat phantom is exposed to fields from either a reference dipole or waveguide. With the probe normal to the phantom surface, the peak spatial average SAR is measured and compared to the analytical value at the surface.

The boundary effect uncertainty can be estimated according to the following uncertainty approximation formula based on linear and exponential extrapolations between the surface and $d_{be} + d_{step}$ along lines that are approximately normal to the surface:

$$SAR_{uncertainty} [\%] = \Delta SAR_{be} \frac{(d_{be} + d_{step})^2}{2d_{step}} \frac{(e^{-d_{be}/\delta})}{\delta/2} \text{ for } (d_{be} + d_{step}) < 10 \text{ mm}$$

where

- $SAR_{uncertainty}$ is the uncertainty in percent of the probe boundary effect
- d_{be} is the distance between the surface and the closest *zoom-scan* measurement point, in millimetre
- Δ_{step} is the separation distance between the first and second measurement points that are closest to the phantom surface, in millimetre, assuming the boundary effect at the second location is negligible
- δ is the minimum penetration depth in millimetres of the head tissue-equivalent liquids defined in this standard, i.e., $\delta \approx 14$ mm at 3 GHz;
- ΔSAR_{be} in percent of SAR is the deviation between the measured SAR value, at the distance d_{be} from the boundary, and the analytical SAR value.



COMOSAR E-FIELD PROBE CALIBRATION REPORT

Ref: ACR.60.1.21.MVGB.A

The measured worst case boundary effect SARuncertainty[%] for scanning distances larger than 4mm is 1.0% Limit ,2%).

4 MEASUREMENT UNCERTAINTY

The guidelines outlined in the IEEE 1528, OET 65 Bulletin C, CENELEC EN50361 and CEI/IEC 62209 standards were followed to generate the measurement uncertainty associated with an E-field probe calibration using the waveguide technique. All uncertainties listed below represent an expanded uncertainty expressed at approximately the 95% confidence level using a coverage factor of k=2, traceable to the Internationally Accepted Guides to Measurement Uncertainty.

Uncertainty analysis of the probe calibration in waveguide					
ERROR SOURCES	Uncertainty value (%)	Probability Distribution	Divisor	ci	Standard Uncertainty (%)
Expanded uncertainty 95 % confidence level k = 2					14 %

5 CALIBRATION MEASUREMENT RESULTS

Calibration Parameters	
Liquid Temperature	20 +/- 1 °C
Lab Temperature	20 +/- 1 °C
Lab Humidity	30-70 %

5.1 SENSITIVITY IN AIR

Normx dipole 1 (µV/(V/m) ²)	Normy dipole 2 (µV/(V/m) ²)	Normz dipole 3 (µV/(V/m) ²)
0.72	0.66	0.77

DCP dipole 1 (mV)	DCP dipole 2 (mV)	DCP dipole 3 (mV)
107	110	110

Calibration curves ei=f(V) (i=1,2,3) allow to obtain E-field value using the formula:

$$E = \sqrt{E_1^2 + E_2^2 + E_3^2}$$



COMOSAR E-FIELD PROBE CALIBRATION REPORT

Ref: ACR.60.1.21.MVGB.A

Calibration curves

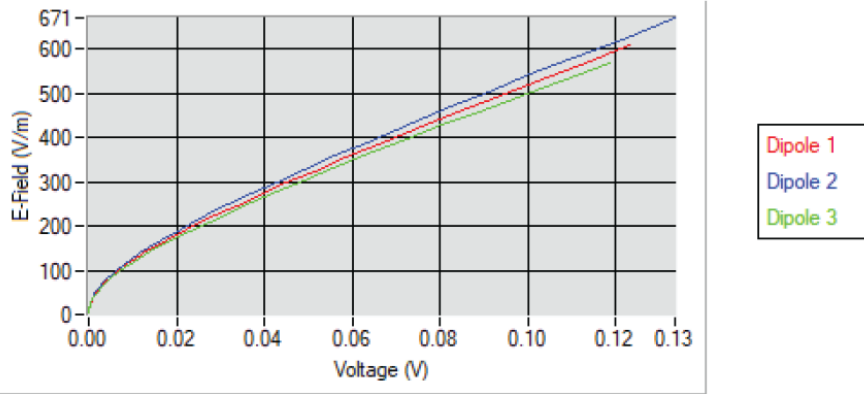

5.2 LINEARITY

Linearity

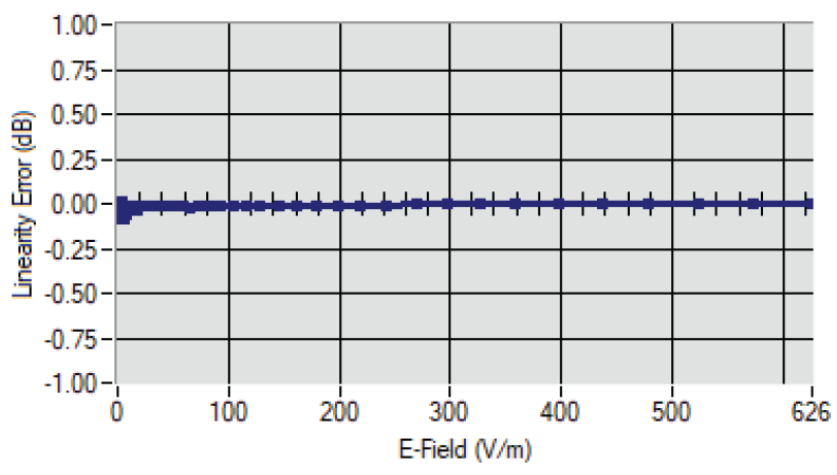

Linearity: +/- 1.90% (+/- 0.08dB)



COMOSAR E-FIELD PROBE CALIBRATION REPORT

Ref: ACR.60.1.21.MVGB.A

5.3 SENSITIVITY IN LIQUID

Liquid	Frequency (MHz +/- 100MHz)	ConvF
HL750	750	1.49
HL850	835	1.50
HL900	900	1.61
HL1800	1800	1.73
HL1900	1900	1.91
HL2000	2000	1.97
HL2300	2300	1.92
HL2450	2450	1.98
HL2600	2600	1.87
HL3300	3300	1.79
HL3500	3500	1.85
HL3700	3700	1.79
HL3900	3900	2.07
HL4200	4200	2.21
HL4600	4600	2.25
HL4900	4900	2.05
HL5200	5200	1.80
HL5400	5400	2.05
HL5600	5600	2.16
HL5800	5800	2.07

LOWER DETECTION LIMIT: 8mW/kg



COMOSAR E-FIELD PROBE CALIBRATION REPORT

Ref: ACR.60.1.21.MVGB.A

5.4 ISOTROPY

HL1800 MHz

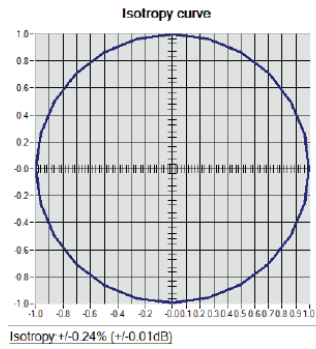



COMOSAR E-FIELD PROBE CALIBRATION REPORT

Ref: ACR.60.1.21.MVGB.A

6 LIST OF EQUIPMENT

Equipment Summary Sheet				
Equipment Description	Manufacturer / Model	Identification No.	Current Calibration Date	Next Calibration Date
Flat Phantom	MVG	SN-20/09-SAM71	Validated. No cal required.	Validated. No cal required.
COMOSAR Test Bench	Version 3	NA	Validated. No cal required.	Validated. No cal required.
Network Analyzer	Rohde & Schwarz ZVM	100203	05/2019	05/2022
Network Analyzer – Calibration kit	Rohde & Schwarz ZV-Z235	101223	05/2019	05/2022
Multimeter	Keithley 2000	1160271	02/2020	02/2023
Signal Generator	Rohde & Schwarz SMB	106589	04/2019	04/2022
Amplifier	Aethercomm	SN 046	Characterized prior to test. No cal required.	Characterized prior to test. No cal required.
Power Meter	NI-USB 5680	170100013	05/2019	05/2022
Directional Coupler	Narda 4216-20	01386	Characterized prior to test. No cal required.	Characterized prior to test. No cal required.
Waveguide	Mega Industries	069Y7-158-13-712	Validated. No cal required.	Validated. No cal required.
Waveguide Transition	Mega Industries	069Y7-158-13-701	Validated. No cal required.	Validated. No cal required.
Waveguide Termination	Mega Industries	069Y7-158-13-701	Validated. No cal required.	Validated. No cal required.
Temperature / Humidity Sensor	Testo 184 H1	44220687	05/2020	05/2023



SAR Reference Dipole Calibration Report

Ref : ACR.60.8.21.MVGB.A

**SHENZHEN NTEK TESTING TECHNOLOGY
CO., LTD.**

**BUILDING E, FENDA SCIENCE PARK, SANWEI
COMMUNITY, XIXIANG STREET,
BAO'AN DISTRICT, SHENZHEN GUANGDONG, CHINA
MVG COMOSAR REFERENCE DIPOLE**

FREQUENCY: 2450 MHZ

SERIAL NO.: SN 03/15 DIP2G450-352

Calibrated at MVG

Z.I. de la pointe du diable

**Technopôle Brest Iroise – 295 avenue Alexis de Rochon
29280 PLOUZANE - FRANCE**

Calibration date: 03/01/2021



Accreditations #2-6789 and #2-6814
Scope available on www.cofrac.fr

Summary:

This document presents the method and results from an accredited SAR reference dipole calibration performed at MVG, using the COMOSAR test bench. The test results covered by accreditation are traceable to the International System of Units (SI).



SAR REFERENCE DIPOLE CALIBRATION REPORT

Ref: ACR.60.8.21.MVGB.A

	<i>Name</i>	<i>Function</i>	<i>Date</i>	<i>Signature</i>
<i>Prepared by :</i>	Jérôme LUC	Technical Manager	3/1/2021	<i>JLS</i>
<i>Checked by :</i>	Jérôme LUC	Technical Manager	3/1/2021	<i>JLS</i>
<i>Approved by :</i>	Yann Toutain	Laboratory Director	3/1/2021	<i>Yann Toutain</i>

Make Entry 2021.03.01
 13:13:40
PREP +01'00'

	<i>Customer Name</i>
<i>Distribution :</i>	SHENZHEN NTEK TESTING TECHNOLOGY CO., LTD.

<i>Issue</i>	<i>Name</i>	<i>Date</i>	<i>Modifications</i>
A	Jérôme LE GALL	3/1/2021	Initial release



SAR REFERENCE DIPOLE CALIBRATION REPORT

Ref. ACR.60.8.21.MVGB.A

TABLE OF CONTENTS

1	Introduction.....	4
2	Device Under Test	4
3	Product Description	4
3.1	General Information	4
4	Measurement Method	5
4.1	Return Loss Requirements	5
4.2	Mechanical Requirements	5
5	Measurement Uncertainty.....	5
5.1	Return Loss	5
5.2	Dimension Measurement	5
5.3	Validation Measurement	5
6	Calibration Measurement Results.....	6
6.1	Return Loss and Impedance	6
6.2	Mechanical Dimensions	6
7	Validation measurement	7
7.1	Measurement Condition	7
7.2	Head Liquid Measurement	7
7.3	Measurement Result	8
8	List of Equipment	10



SAR REFERENCE DIPOLE CALIBRATION REPORT

Ref: ACR.60.8.21.MVGB.A

1 INTRODUCTION

This document contains a summary of the requirements set forth by the IEEE 1528, FCC KDBs and CEI/IEC 62209 standards for reference dipoles used for SAR measurement system validations and the measurements that were performed to verify that the product complies with the fore mentioned standards.

2 DEVICE UNDER TEST

Device Under Test	
Device Type	COMOSAR 2450 MHz REFERENCE DIPOLE
Manufacturer	MVG
Model	SID2450
Serial Number	SN 03/15 DIP2G450-352
Product Condition (new / used)	Used

3 PRODUCT DESCRIPTION

3.1 GENERAL INFORMATION

MVG’s COMOSAR Validation Dipoles are built in accordance to the IEEE 1528, FCC KDBs and CEI/IEC 62209 standards. The product is designed for use with the COMOSAR test bench only.



Figure 1 – MVG COMOSAR Validation Dipole



SAR REFERENCE DIPOLE CALIBRATION REPORT

Ref: ACR.60.8.21.MVGB.A

4 MEASUREMENT METHOD

The IEEE 1528, FCC KDBs and CEI/IEC 62209 standards provide requirements for reference dipoles used for system validation measurements. The following measurements were performed to verify that the product complies with the fore mentioned standards.

4.1 RETURN LOSS REQUIREMENTS

The dipole used for SAR system validation measurements and checks must have a return loss of -20 dB or better. The return loss measurement shall be performed against a liquid filled phantom, with the phantom constructed as outlined in the fore mentioned standards. A direct method is used with a network analyser and its calibration kit, both with a valid ISO17025 calibration.

4.2 MECHANICAL REQUIREMENTS

The IEEE Std. 1528 and CEI/IEC 62209 standards specify the mechanical components and dimensions of the validation dipoles, with the dimension's frequency and phantom shell thickness dependent. The COMOSAR test bench employs a 2 mm phantom shell thickness therefore the dipoles sold for use with the COMOSAR test bench comply with the requirements set forth for a 2 mm phantom shell thickness. A direct method is used with a ISO17025 calibrated caliper.

5 MEASUREMENT UNCERTAINTY

All uncertainties listed below represent an expanded uncertainty expressed at approximately the 95% confidence level using a coverage factor of k=2, traceable to the Internationally Accepted Guides to Measurement Uncertainty.

5.1 RETURN LOSS

The following uncertainties apply to the return loss measurement:

Frequency band	Expanded Uncertainty on Return Loss
400-6000MHz	0.08 LIN

5.2 DIMENSION MEASUREMENT

The following uncertainties apply to the dimension measurements:

Length (mm)	Expanded Uncertainty on Length
0 - 300	0.20 mm
300 - 450	0.44 mm

5.3 VALIDATION MEASUREMENT

The guidelines outlined in the IEEE 1528, FCC KDBs, CENELEC EN50361 and CEI/IEC 62209 standards were followed to generate the measurement uncertainty for validation measurements.

Scan Volume	Expanded Uncertainty



SAR REFERENCE DIPOLE CALIBRATION REPORT

Ref: ACR.60.8.21.MVGB.A

1 g	19 % (SAR)
10 g	19 % (SAR)

6 CALIBRATION MEASUREMENT RESULTS

6.1 RETURN LOSS AND IMPEDANCE

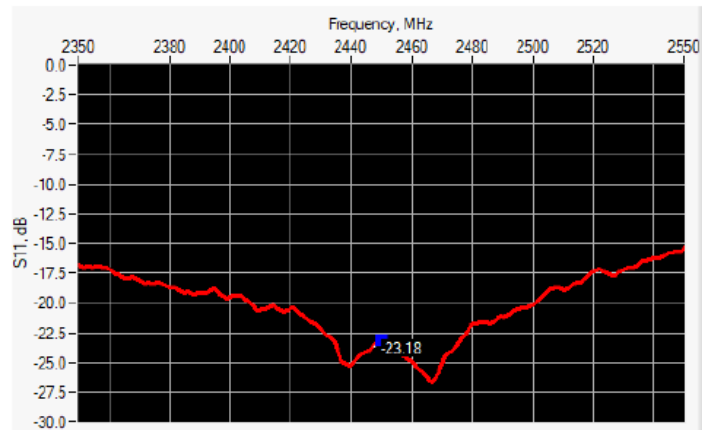

Frequency (MHz)	Return Loss (dB)	Requirement (dB)	Impedance
2450	-23.18	-20	56.3 Ω - 2.9 jΩ

6.2 MECHANICAL DIMENSIONS

Frequency MHz	L mm		h mm		d mm	
	required	measured	required	measured	required	measured
300	420.0 ±1 %.		250.0 ±1 %.		6.35 ±1 %.	
450	290.0 ±1 %.		166.7 ±1 %.		6.35 ±1 %.	
750	176.0 ±1 %.		100.0 ±1 %.		6.35 ±1 %.	
835	161.0 ±1 %.		89.8 ±1 %.		3.6 ±1 %.	
900	149.0 ±1 %.		83.3 ±1 %.		3.6 ±1 %.	
1450	89.1 ±1 %.		51.7 ±1 %.		3.6 ±1 %.	
1500	80.5 ±1 %.		50.0 ±1 %.		3.6 ±1 %.	
1640	79.0 ±1 %.		45.7 ±1 %.		3.6 ±1 %.	
1750	75.2 ±1 %.		42.9 ±1 %.		3.6 ±1 %.	
1800	72.0 ±1 %.		41.7 ±1 %.		3.6 ±1 %.	
1900	68.0 ±1 %.		39.5 ±1 %.		3.6 ±1 %.	
1950	66.3 ±1 %.		38.5 ±1 %.		3.6 ±1 %.	
2000	64.5 ±1 %.		37.5 ±1 %.		3.6 ±1 %.	
2100	61.0 ±1 %.		35.7 ±1 %.		3.6 ±1 %.	
2300	55.5 ±1 %.		32.6 ±1 %.		3.6 ±1 %.	
2450	51.5 ±1 %.	-	30.4 ±1 %.	-	3.6 ±1 %.	-



SAR REFERENCE DIPOLE CALIBRATION REPORT

Ref. ACR.60.8.21.MVGB.A

2600	48.5 ±1 %.		28.8 ±1 %.		3.6 ±1 %.	
3000	41.5 ±1 %.		25.0 ±1 %.		3.6 ±1 %.	
3500	37.0±1 %.		26.4 ±1 %.		3.6 ±1 %.	
3700	34.7±1 %.		26.4 ±1 %.		3.6 ±1 %.	

7 VALIDATION MEASUREMENT

The IEEE Std. 1528, FCC KDBs and CEI/IEC 62209 standards state that the system validation measurements must be performed using a reference dipole meeting the fore mentioned return loss and mechanical dimension requirements. The validation measurement must be performed against a liquid filled flat phantom, with the phantom constructed as outlined in the fore mentioned standards. Per the standards, the dipole shall be positioned below the bottom of the phantom, with the dipole length centered and parallel to the longest dimension of the flat phantom, with the top surface of the dipole at the described distance from the bottom surface of the phantom.

7.1 MEASUREMENT CONDITION

Software	OPENSAR V5
Phantom	SN 13/09 SAM68
Probe	SN 41/18 EPGO333
Liquid	Head Liquid Values: eps' : 41.9 sigma : 1.88
Distance between dipole center and liquid	10.0 mm
Area scan resolution	dx=8mm/dy=8mm
Zoon Scan Resolution	dx=5mm/dy=5mm/dz=5mm
Frequency	24502450 MHz
Input power	20 dBm
Liquid Temperature	20 +/- 1 °C
Lab Temperature	20 +/- 1 °C
Lab Humidity	30-70 %

7.2 HEAD LIQUID MEASUREMENT

Frequency MHz	Relative permittivity (ε _r)		Conductivity (σ) S/m	
	required	measured	required	measured
300	45.3 ±10 %		0.87 ±10 %	
450	43.5 ±10 %		0.87 ±10 %	
750	41.9 ±10 %		0.89 ±10 %	
835	41.5 ±10 %		0.90 ±10 %	
900	41.5 ±10 %		0.97 ±10 %	
1450	40.5 ±10 %		1.20 ±10 %	
1500	40.4 ±10 %		1.23 ±10 %	
1640	40.2 ±10 %		1.31 ±10 %	
1750	40.1 ±10 %		1.37 ±10 %	
1800	40.0 ±10 %		1.40 ±10 %	
1900	40.0 ±10 %		1.40 ±10 %	
1950	40.0 ±10 %		1.40 ±10 %	
2000	40.0 ±10 %		1.40 ±10 %	



SAR REFERENCE DIPOLE CALIBRATION REPORT

Ref: ACR.60.8.21.MVGB.A

2100	39.8 ±10 %		1.49 ±10 %	
2300	39.5 ±10 %		1.67 ±10 %	
2450	39.2 ±10 %	41.9	1.80 ±10 %	1.88
2600	39.0 ±10 %		1.96 ±10 %	
3000	38.5 ±10 %		2.40 ±10 %	
3500	37.9 ±10 %		2.91 ±10 %	

7.3 MEASUREMENT RESULT

The IEEE Std. 1528 and CEI/IEC 62209 standards state that the system validation measurements should produce the SAR values shown below (for phantom thickness of 2 mm), within the uncertainty for the system validation. All SAR values are normalized to 1 W forward power. In bracket, the measured SAR is given with the used input power.

Frequency MHz	1 g SAR (W/kg/W)		10 g SAR (W/kg/W)	
	required	measured	required	measured
300	2.85		1.94	
450	4.58		3.06	
750	8.49		5.55	
835	9.56		6.22	
900	10.9		6.99	
1450	29		16	
1500	30.5		16.8	
1640	34.2		18.4	
1750	36.4		19.3	
1800	38.4		20.1	
1900	39.7		20.5	
1950	40.5		20.9	
2000	41.1		21.1	
2100	43.6		21.9	
2300	48.7		23.3	
2450	52.4	53.69 (5.37)	24	23.94 (2.39)
2600	55.3		24.6	
3000	63.8		25.7	
3500	67.1		25	



SAR REFERENCE DIPOLE CALIBRATION REPORT

Ref: ACR.60.8.21.MVGB.A

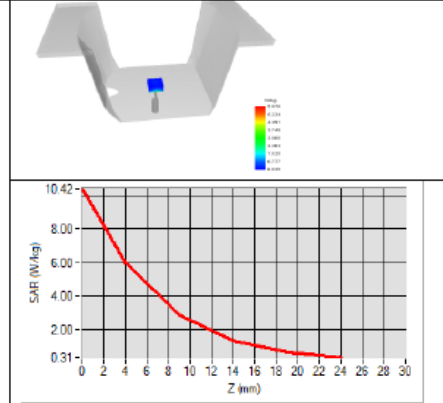
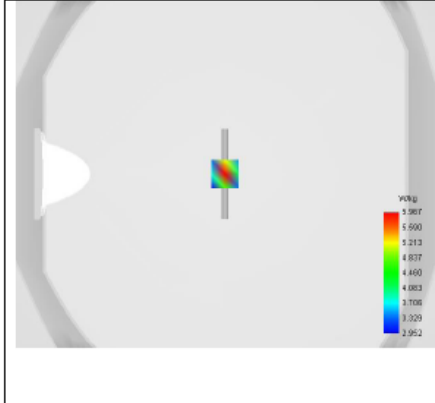



SAR REFERENCE DIPOLE CALIBRATION REPORT

Ref: ACR.60.8.21.MVGB.A

8 LIST OF EQUIPMENT

Equipment Summary Sheet				
Equipment Description	Manufacturer / Model	Identification No.	Current Calibration Date	Next Calibration Date
SAM Phantom	MVG	SN-13/09-SAM68	Validated. No cal required.	Validated. No cal required.
COMOSAR Test Bench	Version 3	NA	Validated. No cal required.	Validated. No cal required.
Network Analyzer	Rohde & Schwarz ZVM	100203	05/2019	05/2022
Network Analyzer – Calibration kit	Rohde & Schwarz ZV-Z235	101223	05/2019	05/2022
Calipers	Mitutoyo	SN 0009732	10/2019	10/2022
Reference Probe	MVG	EPGO333 SN 41/18	05/2020	05/2021
Multimeter	Keithley 2000	1160271	02/2020	02/2023
Signal Generator	Rohde & Schwarz SMB	106589	04/2019	04/2022
Amplifier	Aethercomm	SN 046	Characterized prior to test. No cal required.	Characterized prior to test. No cal required.
Power Meter	NI-USB 5680	170100013	05/2019	05/2022
Directional Coupler	Narda 4216-20	01386	Characterized prior to test. No cal required.	Characterized prior to test. No cal required.
Temperature / Humidity Sensor	Testo 184 H1	44220687	05/2020	05/2023



SAR Reference Waveguide Calibration Report

Ref : ACR.60.10.21.MVGB.A

SHENZHEN NTEK TESTING TECHNOLOGY CO., LTD.

BUILDING E, FENDA SCIENCE PARK, SANWEI
COMMUNITY, XIXIANG STREET,
BAO'AN DISTRICT, SHENZHEN GUANGDONG, CHINA
SATIMO COMOSAR REFERENCE WAVEGUIDE

FREQUENCY: 5000-6000 MHZ

SERIAL NO.: SN 13/14 WGA33

Calibrated at MVG

Z.I. de la pointe du diable

Technopôle Brest Iroise – 295 avenue Alexis de Rochon

29280 PLOUZANE - FRANCE

Calibration date: 03/01/2021



Accreditations #2-6789 and #2-6814
Scope available on www.cofrac.fr

Summary:

This document presents the method and results from an accredited SAR reference waveguide calibration performed at MVG, using the COMOSAR test bench. The test results covered by accreditation are traceable to the International System of Units (SI).



SAR REFERENCE WAVEGUIDE CALIBRATION REPORT

Ref: ACR.60.10.21.MVGB.A

	<i>Name</i>	<i>Function</i>	<i>Date</i>	<i>Signature</i>
<i>Prepared by :</i>	Jérôme Luc	Technical Manager	3/1/2021	<i>JLS</i>
<i>Checked by :</i>	Jérôme Luc	Technical Manager	3/1/2021	<i>JLS</i>
<i>Approved by :</i>	Yann Toutain	Laboratory Director	3/1/2021	<i>Yann Toutain</i>

Yann Toutain
Made in France
 2021.03.0
 1 13:15:44
 +01'00'
PHILIPS

	<i>Customer Name</i>
<i>Distribution :</i>	SHENZHEN NTEK TESTING TECHNOLOGY CO., LTD.

<i>Issue</i>	<i>Name</i>	<i>Date</i>	<i>Modifications</i>
A	Jérôme Luc	3/1/2021	Initial release



SAR REFERENCE WAVEGUIDE CALIBRATION REPORT

Ref: ACR.60.10.21.MVGB.A

TABLE OF CONTENTS

1	Introduction.....	4
2	Device Under Test	4
3	Product Description	4
3.1	General Information	4
4	Measurement Method	4
4.1	Return Loss Requirements	4
4.2	Mechanical Requirements	4
5	Measurement Uncertainty.....	5
5.1	Return Loss	5
5.2	Dimension Measurement	5
5.3	Validation Measurement	5
6	Calibration Measurement Results.....	5
6.1	Return Loss	5
6.2	Mechanical Dimensions	6
7	Validation measurement	6
7.1	Head Liquid Measurement	8
7.2	Measurement Result	8
8	List of Equipment	11



SAR REFERENCE WAVEGUIDE CALIBRATION REPORT

Ref: ACR.60.10.21.MVGB.A

1 INTRODUCTION

This document contains a summary of the requirements set forth by the IEEE 1528 and CEI/IEC 62209 standards for reference waveguides used for SAR measurement system validations and the measurements that were performed to verify that the product complies with the fore mentioned standards.

2 DEVICE UNDER TEST

Device Under Test	
Device Type	COMOSAR 5000-6000 MHz REFERENCE WAVEGUIDE
Manufacturer	MVG
Model	SWG5500
Serial Number	SN 13/14 WGA33
Product Condition (new / used)	Used

3 PRODUCT DESCRIPTION

3.1 GENERAL INFORMATION

MVG's COMOSAR Validation Waveguides are built in accordance to the IEEE 1528 and CEI/IEC 62209 standards.

4 MEASUREMENT METHOD

The IEEE 1528 and CEI/IEC 62209 standards provide requirements for reference waveguides used for system validation measurements. The following measurements were performed to verify that the product complies with the fore mentioned standards.

4.1 RETURN LOSS REQUIREMENTS

The waveguide used for SAR system validation measurements and checks must have a return loss of -8 dB or better. The return loss measurement shall be performed with matching layer placed in the open end of the waveguide, with the waveguide and matching layer in direct contact with the phantom shell as outlined in the fore mentioned standards. A direct method is used with a network analyser and its calibration kit, both with a valid ISO17025 calibration.

4.2 MECHANICAL REQUIREMENTS

The IEEE 1528 and CEI/IEC 62209 standards specify the mechanical dimensions of the validation waveguide, the specified dimensions are as shown in Section 6.2. Figure 1 shows how the dimensions relate to the physical construction of the waveguide. A direct method is used with a ISO17025 calibrated caliper.



SAR REFERENCE WAVEGUIDE CALIBRATION REPORT

Ref: ACR.60.10.21.MVGB.A

5 MEASUREMENT UNCERTAINTY

All uncertainties listed below represent an expanded uncertainty expressed at approximately the 95% confidence level using a coverage factor of k=2, traceable to the Internationally Accepted Guides to Measurement Uncertainty.

5.1 RETURN LOSS

The following uncertainties apply to the return loss measurement:

Frequency band	Expanded Uncertainty on Return Loss
400-6000MHz	0.08 LIN

5.2 DIMENSION MEASUREMENT

The following uncertainties apply to the dimension measurements:

Length (mm)	Expanded Uncertainty on Length
0 - 300	0.20 mm

5.3 VALIDATION MEASUREMENT

The guidelines outlined in the IEEE 1528 and CEI/IEC 62209 standards were followed to generate the measurement uncertainty for validation measurements.

Scan Volume	Expanded Uncertainty
1 g	19 % (SAR)
10 g	19 % (SAR)

6 CALIBRATION MEASUREMENT RESULTS

6.1 RETURN LOSS

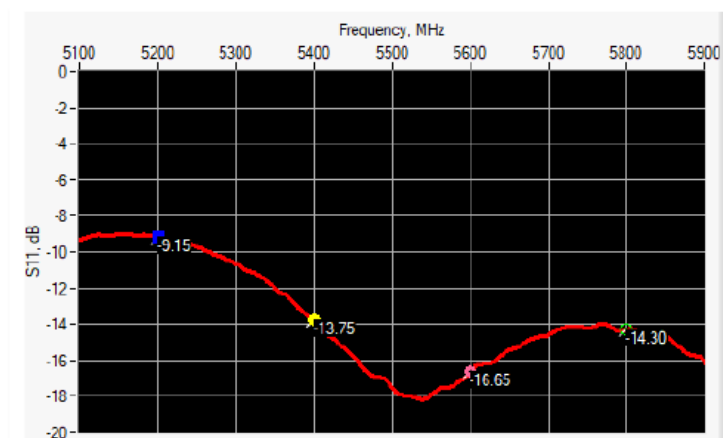



SAR REFERENCE WAVEGUIDE CALIBRATION REPORT

Ref: ACR.60.10.21.MVGB.A

Frequency (MHz)	Return Loss (dB)	Requirement (dB)	Impedance
5200	-9.15	-8	$21.17 \Omega + 13.26 j\Omega$
5400	-13.75	-8	$68.57 \Omega + 6.68 j\Omega$
5600	-16.65	-8	$35.76 \Omega - 2.15 j\Omega$
5800	-14.30	-8	$54.74 \Omega + 18.27 j\Omega$

6.2 MECHANICAL DIMENSIONS

Frequency (MHz)	L (mm)		W (mm)		L _f (mm)		W _f (mm)	
	Required	Measured	Required	Measured	Required	Measured	Required	Measured
5800	40.39 ± 0.13	-	20.19 ± 0.13	-	81.03 ± 0.13	-	61.98 ± 0.13	-

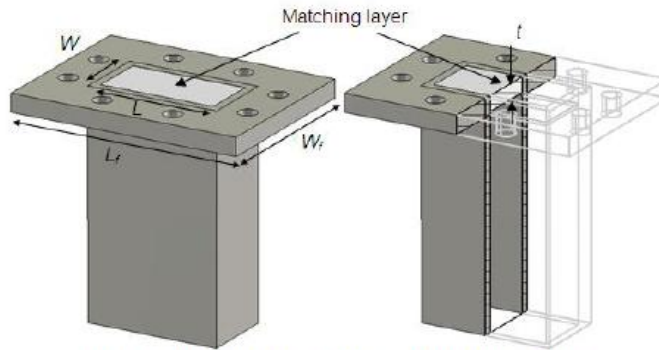

Figure 1: Validation Waveguide Dimensions

7 VALIDATION MEASUREMENT

The IEEE Std. 1528 and CEI/IEC 62209 standards state that the system validation measurements must be performed using a reference waveguide meeting the fore mentioned return loss and mechanical dimension requirements. The validation measurement must be performed with the matching layer placed in the open end of the waveguide, with the waveguide and matching layer in direct contact with the phantom shell.



SAR REFERENCE WAVEGUIDE CALIBRATION REPORT

Ref: ACR.60.10.21.MVGB.A

Measurement Condition

Software	OPENSAR V5
Phantom	SN 13/09 SAM68
Probe	SN 41/18 EPGO333
Liquid	Head Liquid Values 5200 MHz: eps' :34.06 sigma : 4.70 Head Liquid Values 5400 MHz: eps' :33.39 sigma : 4.91 Head Liquid Values 5600 MHz: eps' :32.77 sigma : 5.13 Head Liquid Values 5800 MHz: eps' :32.40 sigma : 5.34
Distance between dipole waveguide and liquid	0 mm
Area scan resolution	dx=8mm/dy=8mm
Zoon Scan Resolution	dx=4mm/dy=4m/dz=2mm
Frequency	5200 MHz 5400 MHz 5600 MHz 5800 MHz
Input power	20 dBm
Liquid Temperature	20 +/- 1 °C
Lab Temperature	20 +/- 1 °C
Lab Humidity	30-70 %



SAR REFERENCE WAVEGUIDE CALIBRATION REPORT

Ref: ACR.60.10.21.MVGB.A

7.1 HEAD LIQUID MEASUREMENT

Frequency MHz	Relative permittivity (ϵ_r')		Conductivity (σ) S/m	
	required	measured	required	measured
5000	36.2 ±10 %		4.45 ±10 %	
5100	36.1 ±10 %		4.56 ±10 %	
5200	36.0 ±10 %	34.06	4.66 ±10 %	4.70
5300	35.9 ±10 %		4.76 ±10 %	
5400	35.8 ±10 %	33.39	4.86 ±10 %	4.91
5500	35.6 ±10 %		4.97 ±10 %	
5600	35.5 ±10 %	32.77	5.07 ±10 %	5.13
5700	35.4 ±10 %		5.17 ±10 %	
5800	35.3 ±10 %	32.40	5.27 ±10 %	5.34
5900	35.2 ±10 %		5.38 ±10 %	
6000	35.1 ±10 %		5.48 ±10 %	

7.2 MEASUREMENT RESULT

At those frequencies, the target SAR value can not be generic. Hereunder is the target SAR value defined by Satimo, within the uncertainty for the system validation. All SAR values are normalized to 1 W net power. In bracket, the measured SAR is given with the used input power.

Frequency (MHz)	1 g SAR (W/kg)		10 g SAR (W/kg)	
	required	measured	required	measured
5200	159.00	162.34 (16.23)	56.90	55.42 (5.54)
5400	166.40	168.48 (16.85)	58.43	57.03 (5.70)
5600	173.80	174.92 (17.49)	59.97	58.63 (5.86)
5800	181.20	178.89 (17.89)	61.50	59.32 (5.93)



SAR REFERENCE WAVEGUIDE CALIBRATION REPORT

Ref: ACR.60.10.21.MVGB.A

SAR MEASUREMENT PLOTS @ 5200 MHz

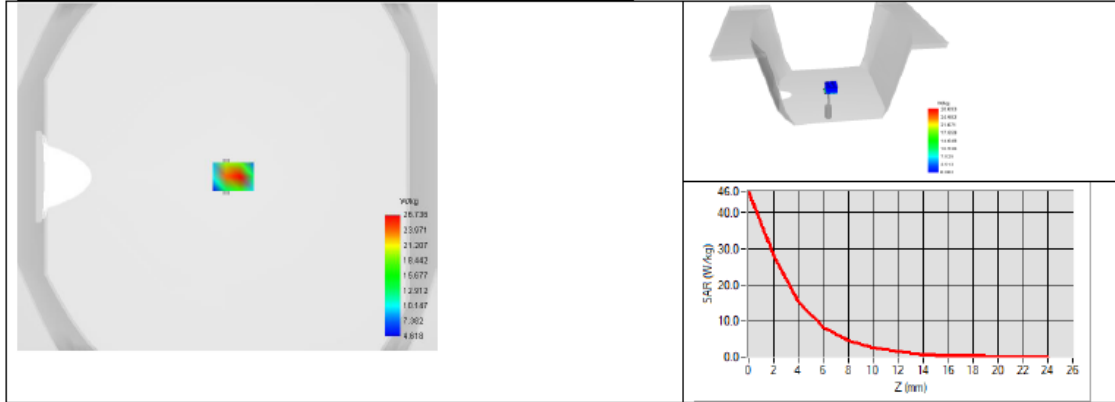

SAR MEASUREMENT PLOTS @ 5400 MHz

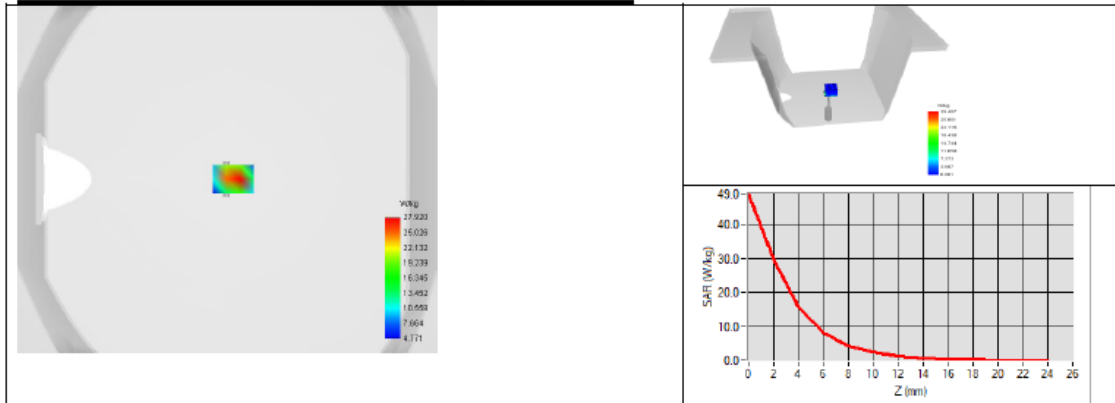

SAR MEASUREMENT PLOTS @ 5600 MHz

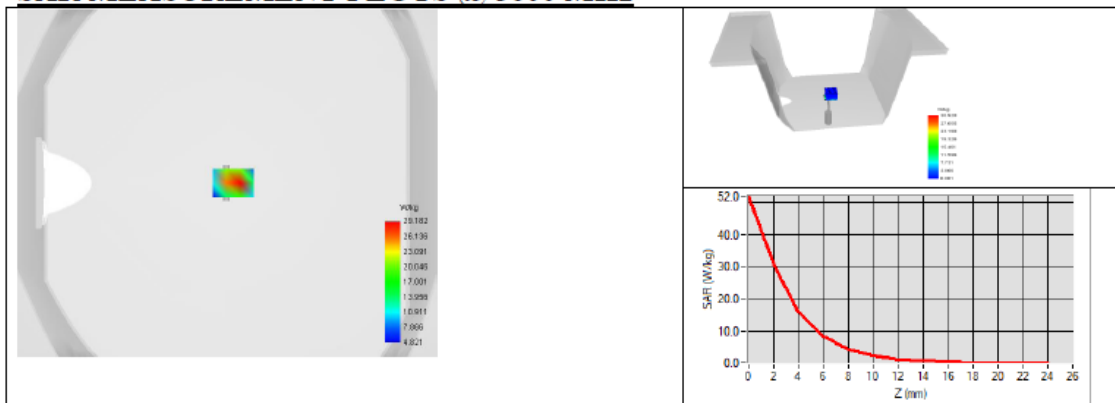



SAR REFERENCE WAVEGUIDE CALIBRATION REPORT

Ref. ACR.60.10.21.MVGB.A

SAR MEASUREMENT PLOTS @ 5800 MHz

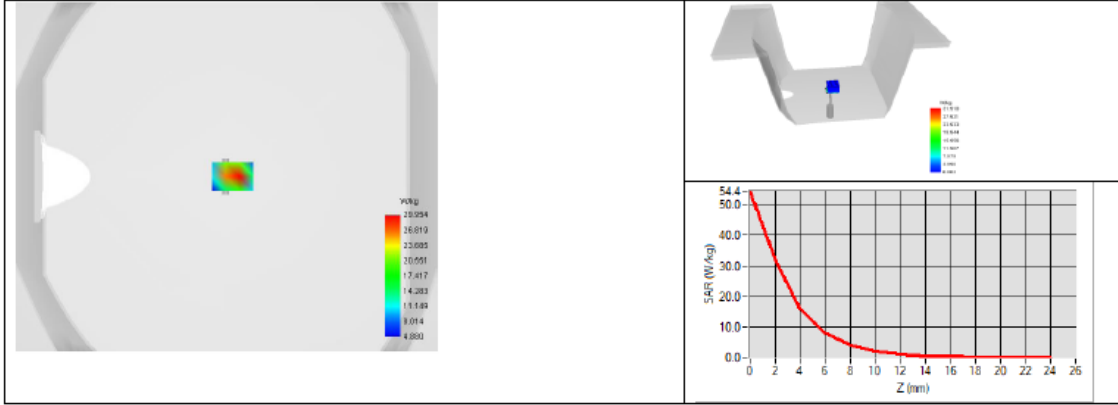



SAR REFERENCE WAVEGUIDE CALIBRATION REPORT

Ref. ACR.60.10.21.MVGB.A

8 LIST OF EQUIPMENT

Equipment Summary Sheet				
Equipment Description	Manufacturer / Model	Identification No.	Current Calibration Date	Next Calibration Date
Flat Phantom	MVG	SN-13/09-SAM68	Validated. No cal required.	Validated. No cal required.
COMOSAR Test Bench	Version 3	NA	Validated. No cal required.	Validated. No cal required.
Network Analyzer	Rohde & Schwarz ZVM	100203	05/2019	05/2022
Network Analyzer – Calibration kit	Rohde & Schwarz ZV-Z235	101223	05/2019	05/2022
Calipers	Mitutoyo	SN 0009732	10/2019	10/2022
Reference Probe	MVG	EPGO333 SN 41/18	05/2020	05/2021
Multimeter	Keithley 2000	1160271	02/2020	02/2023
Signal Generator	Rohde & Schwarz SMB	106589	04/2019	04/2022
Amplifier	Aethercomm	SN 046	Characterized prior to test. No cal required.	Characterized prior to test. No cal required.
Power Meter	NI-USB 5680	170100013	05/2019	05/2022
Directional Coupler	Narda 4216-20	01386	Characterized prior to test. No cal required.	Characterized prior to test. No cal required.
Temperature / Humidity Sensor	Testo 184 H1	44220687	05/2020	05/2023

<Justification of the extended calibration>

If dipoles are verified in return loss (<-20dB, within 20% of prior calibration for below 3GHz, and <-8dB, within 20% of prior calibration for 5GHz to 6GHz), and in impedance (within 5 ohm of prior calibration), the annual calibration is not necessary and the calibration interval can be extended.

<Head 2450MHz>

Return Loss (dB)	Delta (%)	Impedance	Delta(ohm)	Date of Measurement
-23.18	-	56.30	-	Mar. 01, 2021
-23.39	0.91	56.342	0.042	Feb. 28, 2022

The return loss is <-20dB, within 20% of prior calibration; the impedance is within 5 ohm of prior calibration. Therefore the verification result should support extended calibration.

Dipole Verification Data

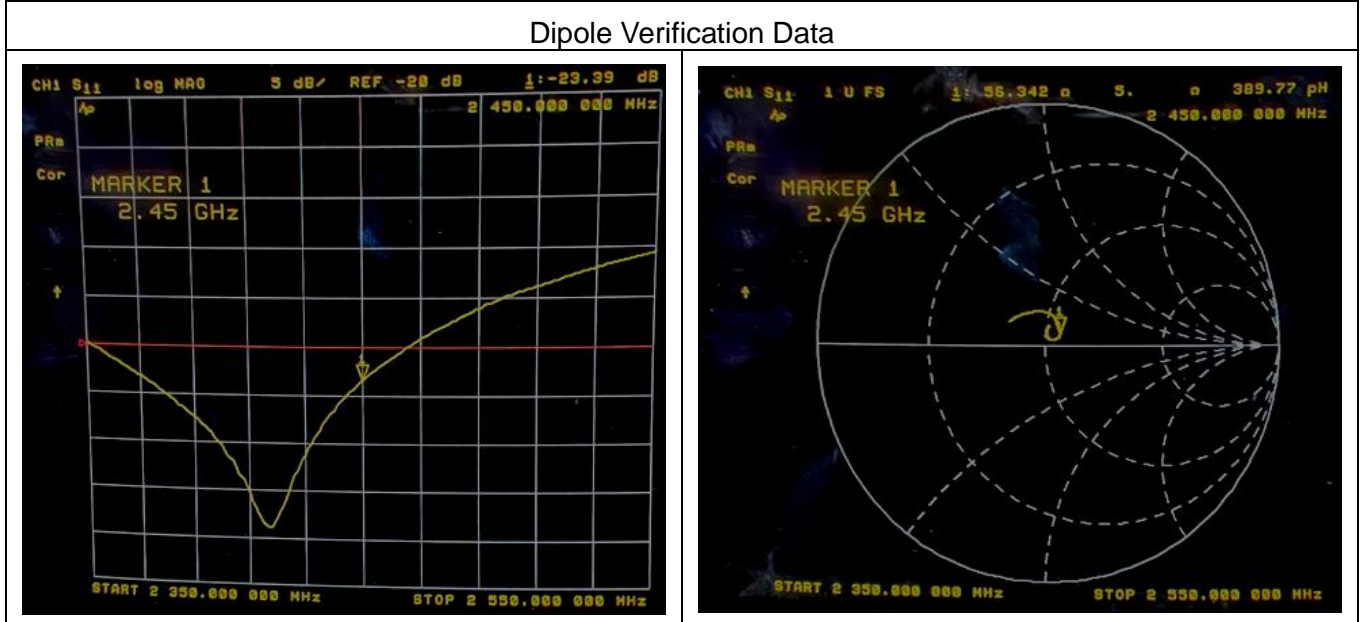

<Head 5200MHz>

Return Loss (dB)	Delta (%)	Impedance	Delta(ohm)	Date of Measurement
-9.15	-	21.17	-	Mar. 01, 2021
-9.1819	0.35	21.191	0.021	Feb. 28, 2022

The return loss is <-8dB, within 20% of prior calibration; the impedance is within 5 ohm of prior calibration. Therefore the verification result should support extended calibration.

Dipole Verification Data

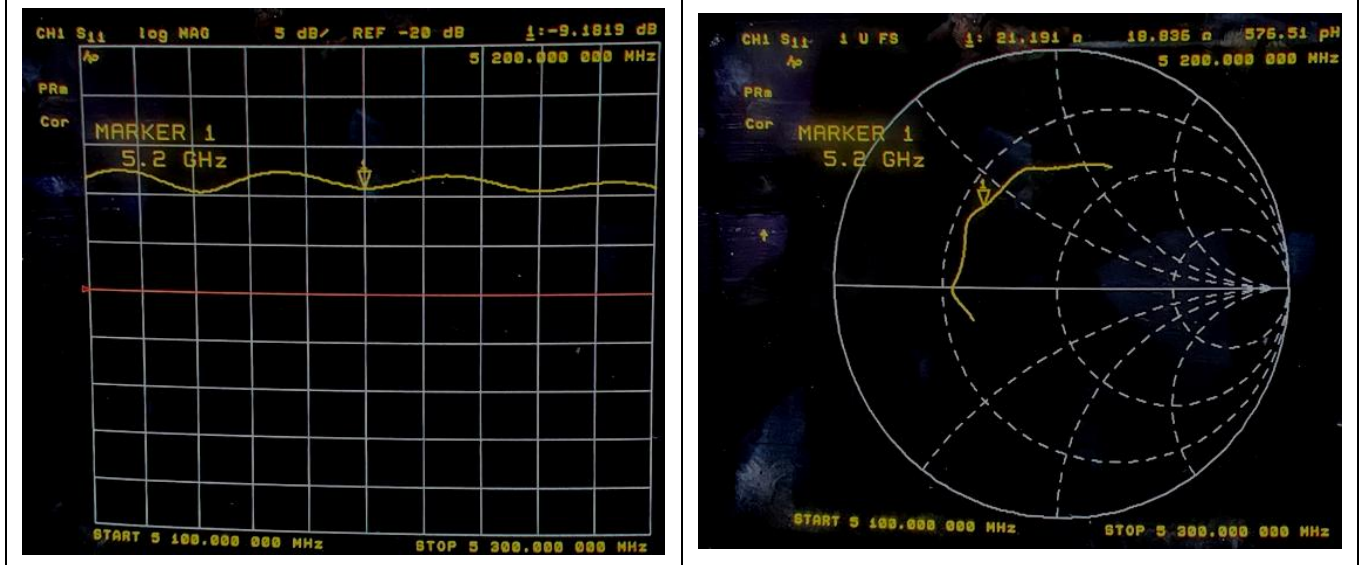

<Head 5600MHz>

Return Loss (dB)	Delta (%)	Impedance	Delta(ohm)	Date of Measurement
-16.65	-	35.76	-	Mar. 01, 2021
-16.249	2.41	35.146	0.614	Feb. 28, 2022

The return loss is <-8dB, within 20% of prior calibration; the impedance is within 5 ohm of prior calibration. Therefore the verification result should support extended calibration.

Dipole Verification Data

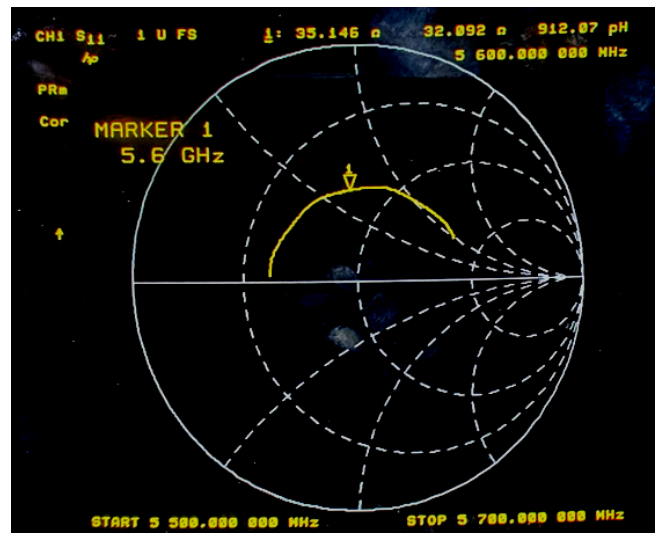
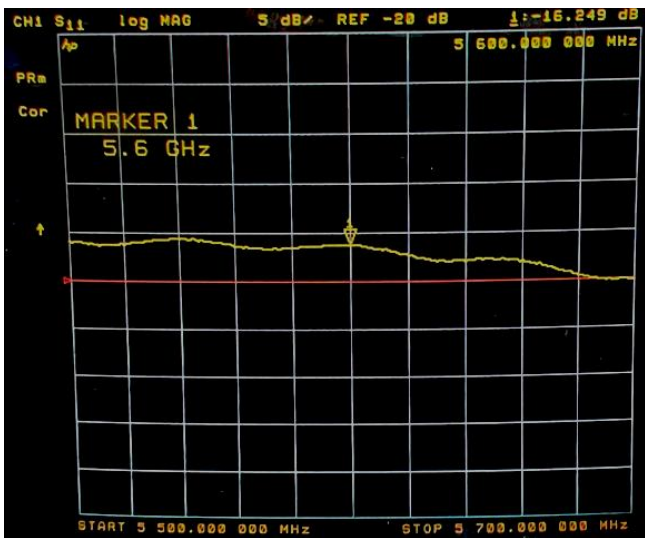

<Head 5800MHz>

Return Loss (dB)	Delta (%)	Impedance	Delta(ohm)	Date of Measurement
-14.30	-	54.74	-	Mar. 01, 2021
-14.349	0.34	55.115	0.375	Feb. 28, 2022

The return loss is <-8dB, within 20% of prior calibration; the impedance is within 5 ohm of prior calibration. Therefore the verification result should support extended calibration.

Dipole Verification Data

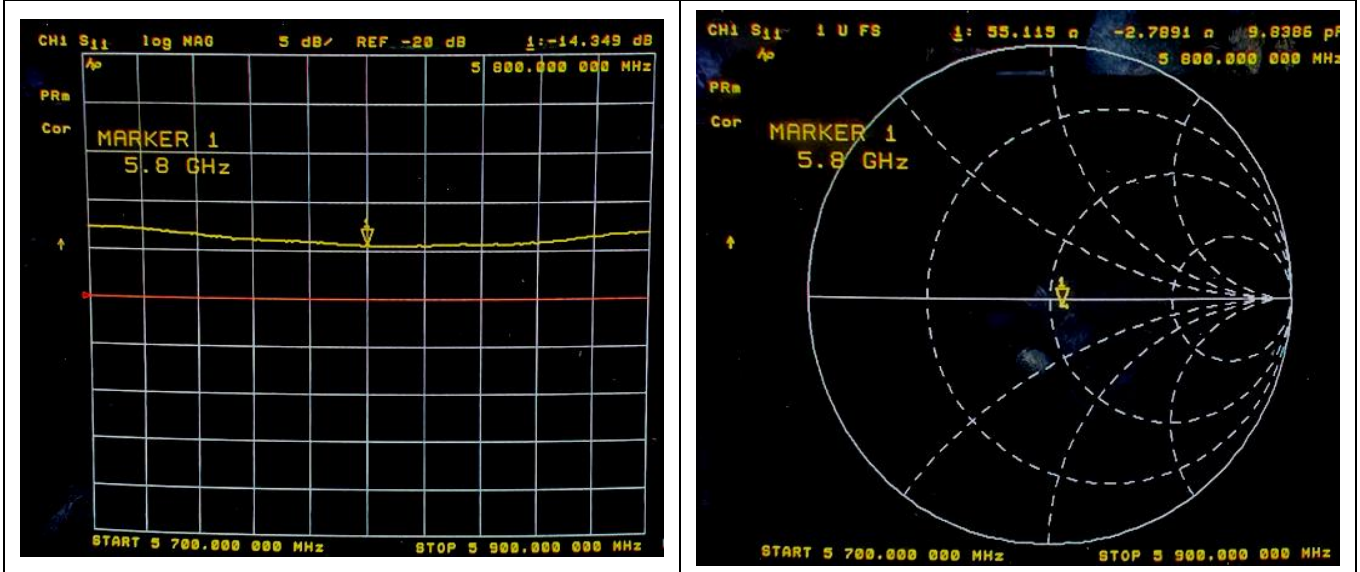

END