



Sylvox
SEE THE FUTURE

2.0 Channel Outdoor Soundbar Elf S2



HDMI™
HIGH-DEFINITION MULTIMEDIA INTERFACE

 **Bluetooth®**

USER'S MANUAL





Before using the soundbar, please read this manual thoroughly and retain it for future reference.

Contents

1. Important Safety Instructions	1
1.1 Safety.....	1
1.2 Warning.....	2
2. What's in the Box	4
3. Specifications	4
4. Identifying the Parts	5
4.1 Main Unit	5
4.2 Remote Control	5
5. Preparations	6
5.1 Prepare the Remote Control.....	6
5.2 Replace the Remote Control Battery	6
5.3 Placement and Mounting	6
5.4 Place the Soundbar on the TV rack	6
6. Connections	8
6.1 Waterproof protection cap.....	8
6.2 Use the HDMI ARC Socket.....	8
6.3 Use the OPTICAL Socket.....	8
6.4 Use the COAXIAL Socket	8
6.5 Connect Power	9
7. General Operation	9
7.1 Standby/ON	9
7.2 Automatic Power Off Function	9
7.3 Select Modes.....	9
7.4 Adjust the Volume	9
7.5 Select Equalizer (EQ) Effect.....	9
8. OPTICAL / COAXIAL / HDMI ARC Operation	9
9. Bluetooth Operation	10
10. USB Operation	10
11. Troubleshooting	11

1. Important Safety Instructions

	CAUTION RISK OF ELECTRIC SHOCK DO NOT OPEN	
CAUTION: TO REDUCE THE RISK OF ELECTRIC SHOCK, DO NOT REMOVE COVER (OR BACK). NO USER-SERVICEABLE PARTS INSIDE. REFER SERVICING TO QUALIFIED SERVICE PERSONNEL.		



The lightning flash with arrowhead symbol, within an equilateral triangle, is intended to alert the user to the presence of uninsulated "dangerous voltage" within the product's enclosure that may be of sufficient magnitude as to constitute a risk of electric shock to persons.



The exclamation point within an equilateral triangle is intended to alert the user to the presence of important operating and maintenance (servicing) instructions in the literature accompanying the appliance.

1.1 Safety

- 1 Read these instructions** – All the safety and operating instructions should be read before this product is operated.
- 2 Keep these instructions** – The safety and operating instructions should be retained for future reference.
- 3 Heed all warnings** – All warnings on the appliance and in the operating instructions should be adhered to.
- 4 Follow all instructions** – All operating and usage instructions should be followed.
- 5 Do not use this apparatus near water** – The appliance should not be used near water or moisture – for example, in a wet basement or near a swimming pool and the like.
- 6 Clean only with a dry cloth.**
- 7 Do not block any ventilation openings.** Install in accordance with the manufacturer's instructions.
- Do not install near any heat sources such as radiators, heaters, stoves, or other apparatus (including amplifiers) that produce heat.
- Do not defeat the safety purpose of the polarized or grounding plug. A polarized plug has two blades with one wider than the other. A grounding plug has two blades and a third grounding prong. The wide blade or the third prong is provided for your safety. If the provided plug does not fit into your outlet, consult an electrician for replacement of the obsolete outlet.
- Protect the power cord from being walked on or pinched particularly at plugs, convenience receptacles, and the point where they exit from the apparatus.
- Only use attachments/accessories specified by the manufacturer.
-  Use only with the cart, stand, tripod, bracket or table specified by the manufacturer, or sold with the apparatus. When a cart or rack is used, use caution when moving the cart/apparatus combination to avoid injury from tip-over.
- Unplug the apparatus during lightning storms or when unused for long periods of time.
- Refer all servicing to qualified personnel. Servicing is required when the apparatus has been damaged in any way, such as power supply cord or plug is damaged, liquid has been spilled or objects have fallen into the apparatus, the unit has been exposed to rain or moisture, does not operate normally, or has been dropped.
- This equipment is a Class II or double insulated electrical appliance. It has been designed in such a way that it does not require a safety connection to electrical earth.
- The apparatus shall not be exposed to dripping or splashing. No objects filled with liquids, such as vases, shall be placed on the apparatus.
- Minimum distance around the apparatus for sufficient ventilation is 5cm.
- The ventilation should not be impeded by covering the ventilation openings with items, such as newspapers, table-cloths, curtains, etc...
- No naked flame sources, such as lighted candles, should be placed on the apparatus.
- Batteries should be recycled or disposed of as per state and local guidelines.
- The use of apparatus in moderate climates.

Caution:

- Use of controls or adjustments or performance of procedures other than those described herein, may result in hazardous radiation exposure or other unsafe operation.
- To reduce the risk of fire or electric shock, do not expose this apparatus to rain or moisture. The apparatus must not be exposed to dripping or splashing and objects filled with liquids, such as vases, must not be placed on apparatus.
- The mains plug/appliance coupler is used as the disconnect device, the disconnect device must remain readily operable.
- Danger of explosion if battery is incorrectly replaced. Replace only with the same or equivalent type.

1.2 Warning

- The battery (batteries or battery pack) shall not be exposed to excessive heat such as sunshine, fire or the like.
- Before operating this system, check the voltage of this system to see if it is identical to the voltage of your local power supply.
- Do not place this unit close to strong magnetic fields.
- Do not place this unit on the amplifier or receiver.
- If any solid object or liquid falls into the system, unplug the system and have it checked by qualified personnel before operating it any further.
- Do not attempt to clean the unit with chemical solvents as this may damage the finish. Use a clean, dry or slightly damp cloth.
- When removing the power plug from the wall outlet, always pull directly on the plug, never yank on the cord.
- Changes or modifications to this unit not expressly approved by the party responsible for compliance will void the user's authority to operate the equipment.

- The rating label is pasted on the bottom or back of the equipment.

~AC voltage: This symbol indicates that the rated voltage marked with the symbol is AC voltage.

Battery usage CAUTION

To prevent battery leakage which may result in bodily injury, property damage, or damage to the apparatus:

- Install all batteries correctly, + and - as marked on the apparatus.
- Do not mix old and new batteries.
- Do not mix alkaline, standard (Carbon-Zinc) or rechargeable (Ni-Cd, Ni-MH, etc.) batteries.
- Remove batteries when the unit is not used for a long time.



Correct Disposal of this product. This marking indicates that this product should not be disposed with other household wastes throughout the EU.

To prevent possible harm to the environment or human health from uncontrolled waste disposal, recycle it responsibly to promote the sustainable reuse of material resources. To return your used device, please use the return and collection systems or contact the retailer where the product was purchased. They can take this product for environmental safe recycling.



We hereby declares that this product is in compliance with the essential requirements and other relevant provisions of RED Directive 2014/53/ EU and UK Radio Equipment Regulations 2017.



The Bluetooth® word mark and logos are registered trademarks owned by Bluetooth SIG, Inc. and any use of such marks by Sylvox. is under license. Other trademarks and trade names are those of their respective owners.



The Adopted Trademarks HDMI, HDMI High-Definition Multimedia Interface, HDMI trade dress and the HDMI Logos are trademarks or registered trademarks of HDMI Licensing Administrator, Inc. in the United States and other countries.



FCC Caution:

- Changes or modifications not expressly approved by the party responsible for compliance could void the user's authority to operate the equipment.
- This equipment complies with FCC and IC radiation exposure limits set forth for an uncontrolled environment. This equipment should be installed and operated with minimum distance 20cm between the radiator & your body.
- Shielded cables must be used with this unit to ensure compliance with the Class B FCC limits.

California Prop 65 Warning :



This product can expose you to chemicals including Lead, which is known to the State of California to cause cancer.
For more information go to: www.P65Warnings.ca.gov.

2. What's in the Box

Soundbar	x1	USB transfer cable	x1
Remote Control (AAA Batteries x 2)	x1	Wall mount kit	x1
HDMI Cable	x1	User Manual	x1
Optical Cable	x1	Warranty Card	x1
Coaxial Cable	x1		

3. Specifications

Soundbar	
Power supply	100-240V~ 50/60Hz
Power consumption	20 W / < 0.5 W (StandBy)
USB	5V \equiv 500mA Hi-Speed USB (2.0) / FAT32 / FAT16 32G (max) , MP3
Dimension (WxHxD)	975 x 65 x 76 mm
Net weight	2.0 kg
Audio input sensitivity	700mV
Frequency response	40Hz - 20KHz
Amplifier	60 W (Max. output power)
Speaker Impedance	8 Ω x 2
Wireless Specification	
Bluetooth version /profiles	V 4.2 (A2DP, AVRCP)
Maximum power transmitted (EIRP)	\leq 5 dBm
Bluetooth frequency bands	2402 MHz ~ 2480 MHz
Remote Control	
Distance / Angle	6m / 30 $^{\circ}$
Battery type	AAA (1.5V X 2)

- Power cord quantity and plug type vary by regions.
- Images, illustrations and drawings shown on this User Manual are for reference only. Actual product may vary in appearance.

4. Identifying the Parts

4.1 Main Unit

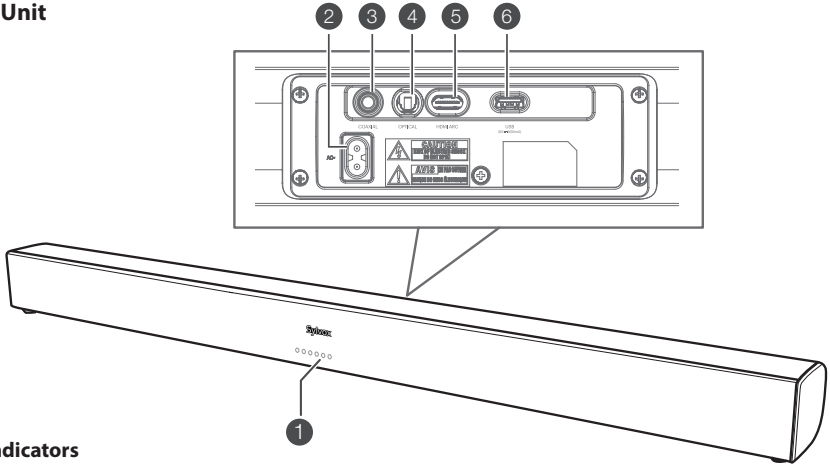

① LED Indicators

- Red indicator : **STANDBY** mode
- Yellow indicator : **COAXIAL** mode
- Blue indicator : **Bluetooth** mode
- Orange indicator : **OPTICAL** mode
- White indicator : **HDMI ARC** mode
- Green indicator : **USB** mode

② AC~ Socket

Connect power cord.

③ COAXIAL Socket

Use to connect to the COAXIAL OUT socket on an external device.

④ OPTICAL Socket

Use to connect to the OPTICAL OUT socket on an external device.

⑤ HDMI ARC Socket

Connect to a TV via HDMI cable.

⑥ USB Socket

Insert the USB device to play music.

4.2 Remote Control

- ① Switch the unit between ON and STANDBY mode.
- ② Select the play function.
- ③ Increase/decrease the volume level.
- ④ Select Equalizer (EQ) Effect.
SPORT
MUSIC
NEWS
MOVIE
- ⑤ Mute or resume the sound.
- ⑥ Skip to previous/next track in Bluetooth/USB mode.
- ⑦ Play/pause/resume playback in Bluetooth/USB mode. Press and hold to activate the pairing function in Bluetooth mode or disconnect the existing paired Bluetooth device.

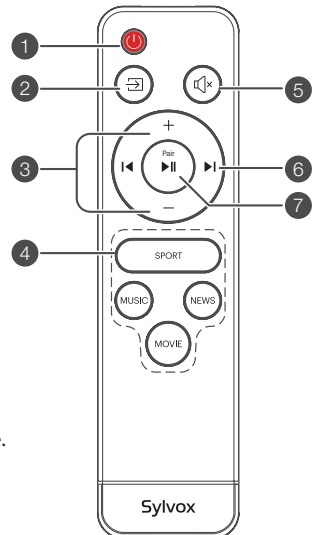

5. Preparations

5.1 Prepare the Remote Control

The provided remote control allows the unit to be operated from a distance.

- Even if the remote control is operated within the effective range 19.7 feet (6m), remote control operation may be impossible if there are any obstacles between the unit and the remote control.
- If the remote control is operated near other products which generate infrared rays, or if other remote control devices using infra-red rays are used near the unit, it may operate incorrectly. Conversely, the other products may operate incorrectly.

5.2 Replace the Remote Control Battery

- 1 Press and slide the back cover to open the battery compartment of the remote control.
- 2 Insert two **AAA** size batteries (included). Make sure the (+) and (-) ends of the batteries match the (+) and (-) ends indicated in the battery compartment.
- 3 Close the battery compartment cover.

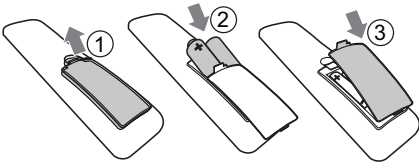

Precautions Concerning Batteries

- Be sure to insert the batteries with correct positive “⊕” and negative “⊖” polarities.
- Use batteries of the same type. Never use different types of batteries together.
- Either rechargeable or non-rechargeable batteries can be used. Refer to the precautions on their labels.
- Be aware of your fingernails when removing the battery cover and the battery.
- Do not drop the remote control.
- Do not allow anything to impact the remote control.
- Do not spill water or any liquid on the remote control.
- Do not place the remote control on a wet object.
- Do not place the remote control under direct sunlight or near sources of excessive heat.

- Remove the battery from the remote control when not in use for a long period of time, as corrosion or battery leakage may occur and result in physical injury, and/or property damage, and/or fire.
- Do not use any batteries other than those specified.
- Do not mix new batteries with old ones.
- Never recharge a battery unless it is confirmed to be a rechargeable type.

5.3 Placement and Mounting

Placement

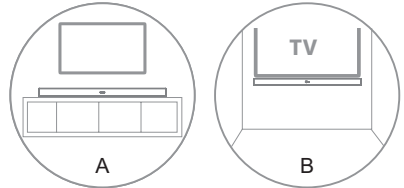

- A If your TV is placed on a table, you can place the unit on the table directly in front of the TV stand, centered with the TV screen.
- B If your TV is attached to a wall, you can mount the unit on the wall directly below the TV screen.

5.4 Place the Soundbar on the TV rack

Note:

- Installation must be carried out by qualified personnel only. Incorrect assembly can result in severe personal injury and property damage (if you intend to install this product yourself, you must check for installations such as electrical wiring and plumbing that may be buried inside the wall). It is the installer's responsibility to verify that the wall will safely support the total load of the unit and wall brackets.
- Additional tools (not included) are required for the installation.
- Do not overtighten screws.
- Keep this instruction manual for future reference.
- Use an electronic stud finder to check the wall type before drilling and mounting.

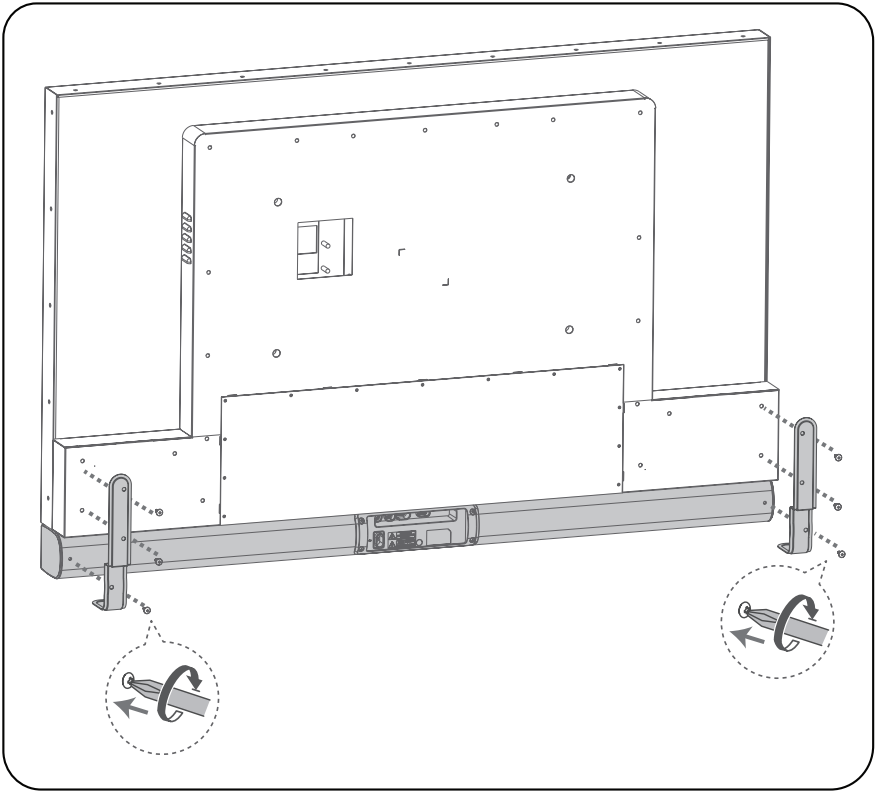

6. Connections

6.1 Waterproof protection cap

Before connections, please remove the waterproof protective cap of the coaxial / optical / HDMI ARC / USB sockets.

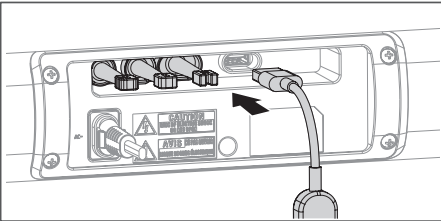
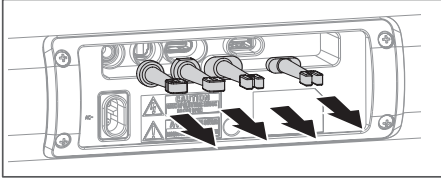

- To ensure that the machine is waterproof, the unconnected ports must be plugged with waterproof protection caps (or do not need to remove the waterproof protection caps for unused port functions). The removed waterproof safety helmet should be kept for future use.

6.2 Use the HDMI ARC Socket

The ARC (Audio Return Channel) function allows you to send audio from your ARC-compliant TV to your sound bar through a single HDMI connection. To enjoy the ARC function, please ensure your TV is both HDMI-CEC and ARC compliant and set up accordingly. When correctly set up, you can use your TV remote control to adjust the volume output (volume +/- and MUTE) of the soundbar.

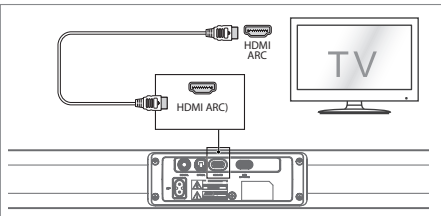

- Connect the HDMI cable from unit's **HDMI (ARC)** socket to the HDMI (ARC) socket on your ARC compliant TV. Then press the remote control to select **HDMI ARC** mode.

Tips:

- Your TV must support the HDMI-CEC and ARC function. HDMI-CEC and ARC must be set to On.
- The setting method of HDMI-CEC and ARC may differ depending on the TV. For details about ARC function, please refer to the owner's manual.
- Only HDMI 1.4 or higher version cable can support the ARC function.

6.3 Use the OPTICAL Socket

- You also can use the OPTICAL cable to the TV's OPTICAL OUT socket and the **OPTICAL** socket on the unit.

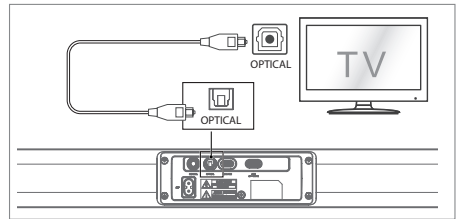

6.4 Use the COAXIAL Socket

- You also can use the COAXIAL cable to connect the TV's COAXIAL OUT socket and COAXIAL socket on the unit.

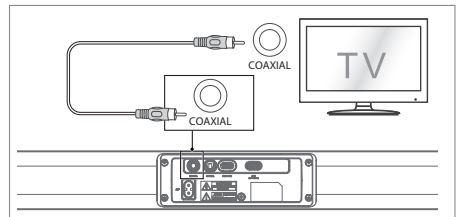

Tip: The Soundbar may not be able to decode all digital audio formats from the input source. In this case, the Soundbar will mute. This is NOT a defect. Ensure that the audio setting of the input source (e.g. TV, game console, DVD player, etc.) is set to **PCM** (Refer to the user manual of the input source device for its audio setting details) with HDMI / OPTICAL / COAXIAL input.

6.5 Connect Power

Risk of product damage!

- Ensure that the power supply voltage corresponds to the voltage printed on the back or the underside of the unit.
- Before connecting the AC power cord, ensure you have completed all other connections.
- Connect the mains cable to the AC~ socket of the main unit and then into a mains socket.

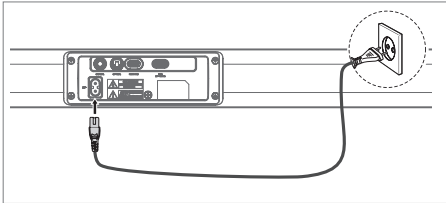



Note:

- If there is no power, ensure the power cord and plug are fully inserted and the power is turned on.
- Power cord quantity and plug type vary by regions.

7. General Operation

7.1 Standby/ON

When you first connect the Soundbar to the mains socket, the Soundbar will be in Standby mode.

- Press the  button on the remote control to switch the Soundbar ON.
- Press the  button again on the remote control to switch the Soundbar back to STANDBY mode. The POWER indicator will light up red.
- Disconnect the mains plug from the mains socket if you want to switch the Soundbar OFF completely.

7.2 Automatic Power Off Function

The Soundbar automatically turns to **Standby** mode after about **15** minutes if the TV or the external unit is disconnected, switched off or the volume is too close to mute.

- To switch the Soundbar off completely, remove the mains plug from the mains socket.
- Please turn the Soundbar off completely to save energy when not in use.

7.3 Select Modes

Press the  button repeatedly to select the **COAXIAL, Bluetooth, OPTICAL, HDMI ARC, USB** mode. The indicator light on the front of the Soundbar will show which mode is currently in use.

- Yellow indicator : **COAXIAL** mode
- Blue indicator : **Bluetooth** mode
- Orange indicator : **OPTICAL** mode
- White indicator : **HDMI ARC** mode
- Green indicator : **USB** mode

7.4 Adjust the Volume

- Press the **+ / - (volume)** buttons on the remote control to adjust the volume.
- If you wish to turn the sound off, press the  button on the remote control. Press this button again or press the **+ / - (volume)** buttons to resume normal listening.

Note: While adjusting the volume, the status LED indicator will flash quickly. When the volume has hit maximum/minimum value level, the status LED indicator will slowly flash 3 times.

7.5 Select Equalizer (EQ) Effect

While playing, press the **SPORT, MUSIC, NEWS, MOVIE** button on the remote control to select preset Equalizers.

8. OPTICAL / COAXIAL / HDMI ARC Operation

- Ensure that the Soundbar is connected to the TV or audio device.
- 1 Press the  button repeatedly to select the **OPTICAL, COAXIAL, HDMI ARC** mode. The indicator light on the front of the Soundbar will show which mode is currently in use.
- 2 Operate your audio device directly for playback features.
- 3 Press the **VOL + / -** buttons to adjust the volume to your desired level.

Tip: The Soundbar may not be able to decode all digital audio formats from the input source. In this case, the Soundbar will mute. This is NOT a defect. Ensure that the audio setting of the input source (e.g. TV, game console, DVD player, etc.) is set to **PCM** (Refer to the user manual of the input source device for its audio setting details) with HDMI / OPTICAL / COAXIAL input.

9. Bluetooth Operation

Pairing the Soundbar with a Bluetooth device to listen to music:

First time pairing

1. Press the  button on the remote control to select Bluetooth mode. The Blue indicator will flash slowly.
2. Activate your Bluetooth device and select the search mode.
3. Select "Sylvox Elf S2" enter "0000" for the password if necessary. After audio prompt, the system is successfully connected and the Blue indicator will light up solidly.

Pairing a new device after first time pairing:

1. In Bluetooth mode, press and hold the **▶/Pair** button to disconnect from current Bluetooth connected devices and enter the Bluetooth pairing mode. You will hear audio prompt and Blue indicator will flash rapidly.
2. Follow step 2-3 in "First time pairing" above to pair your Bluetooth device.

To disconnect the Bluetooth Operation:

- Switch to another function on the Soundbar.
- Disable the function from your Bluetooth device.
- Press and hold the **▶/Pair** button to disconnect from current Bluetooth connected devices and enter the Bluetooth pairing mode. You will hear audio prompt and Blue indicator will flash rapidly.

Listen to Music from Bluetooth device

If your Bluetooth device supports A2DP, play music via your device.

If your Bluetooth device supports AVRCP, use the supplied remote control to control play.

- To increase/decrease the volume, press (volume) **+/-** button.
- To pause/resume playback, press **▶/Pair** button.
- To skip to a track, press **⏮/▶** button.



- In an open space without obstructions. The maximum operational range between the soundbar and a Bluetooth device is approximately 8 meters.
- Before connecting a Bluetooth device to the unit, ensure you know the device's capabilities.
- Compatibility with all Bluetooth devices is not guaranteed.
- Any obstacle between the device and the Soundbar can reduce operational range.
- Keep this player away from other electronic devices that may cause interference.
- The player will also be disconnected when your device is moved beyond the operational range.

10.USB Operation

By connecting a USB mass storage device (e.g. USB flash drive) to this unit, you can enjoy the device's stored music through the unit.

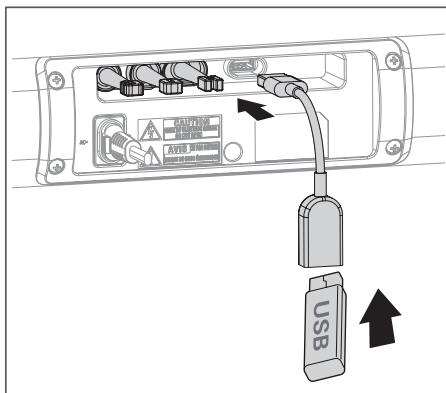

- Ensure that insert USB transfer cable and then insert the USB device.
1. Press the  button on the remote control to select **USB** mode.
 2. Press the **▶/Pair** button to pause/resume playback.
 3. To skip to a track, press **⏮/▶** button.



- The player supports the USB music file format of MP3 only.
- The Soundbar can support USB devices with up to 32 GB of memory.
- The Soundbar may not be compatible with all USB devices, this is not an indication of a problem with the unit.

11.Troubleshooting

To keep the warranty valid, never try to repair the system yourself. If you encounter problems when using this unit, check the following points before requesting service.

Problem	Solution
No power	<ul style="list-style-type: none"> • Ensure that the AC cord of the apparatus is properly connected . • Ensure that there is power at the AC outlet. • Press ⏻ (standby) button to turn the Soundbar on.
Loud hum or noise is heard.	<ul style="list-style-type: none"> • The plugs and sockets are dirty. Wipe them with a cloth slightly moistened with an appropriate non-abrasive cleaning solution.
Remote control does not work	<ul style="list-style-type: none"> • Before you press any playback control button, first select the correct source. • Reduce the distance between the remote control and the unit. • Insert the battery with its polarities ⊕/⊖ aligned as indicated. • Replace the battery. • Aim the remote control directly at the sensor on the front of the unit.
No sound	<ul style="list-style-type: none"> • Make sure that the Soundbar is not muted. Press 🔇 (MUTE) or volume +/- button to resume normal listening. • Press ⏻ button on the remote control to switch the soundbar to standby mode. Then press the ⏻ button again to switch the soundbar on. • Press source buttons to select a different input source. • When using either of the Digital inputs, if there is no audio: <ul style="list-style-type: none"> - Try setting the TV output to PCM or - Connect directly to your Blu-ray/other source, some TVs do not pass through digital audio. • Your TV may be set to variable audio output. Confirm that the audio output setting is set to FIXED or STANDARD, not VARIABLE. Consult your TV's user manual for more detailed information. • If using Bluetooth, ensure that the volume on your source device is turned up and that the device is not muted.
I can't find the Bluetooth name of this unit on my Bluetooth device for Bluetooth pairing	<ul style="list-style-type: none"> • Ensure the Bluetooth function is activated on your Bluetooth device. • Re-pair the Soundbar with your Bluetooth device. • The Soundbar has a Bluetooth® function that can receive a signal within 8 metres. Keep a distance within 8 metres between the Soundbar and your Bluetooth® device.
The Soundbar turns off	<ul style="list-style-type: none"> • When the Soundbar's external input signal level is too low, the Soundbar will be automatically turn off after 15 minutes. Please increase the volume level of your external device.

Warranty

Thank you for purchasing this Sylvox product. We are glad to offer 12 months free warranty for you. If you have any questions, please contact us via our after-sales email or website for assistance.

After-sales email: service@sylvoxtv.com

Website: www.sylvoxtv.com

Customer Service Support:

Email: service@sylvoxtv.com

Service Hotline: 8333-SYLVVOX (Monday-Friday, 9:00 AM-5:00 PM EST)

Warranty Policy:

(1) When returning an item, please note the following:

1. Only items purchased directly from www.sylvoxtv.com and authorized resellers can be returned, such as Amazon, Walmart, Newegg, Wayfair, Aliexpress, etc.
2. We will not accept any return requests for products purchased from unauthorized third-party suppliers.
3. Customer must contact the original vendor with your order ID or purchase proof and the detail of the product issue at service@sylvoxtv.com to request a return/refund/repair/replace before returning products. Sylvox will provide you with the shipping label in the mail.
4. Sylvox are responsible for all return shipping costs for quality problem.
5. If there is no reason to return the product after installation and use, Sylvox shall have the right to charge restocking fees of 20% of the product value. (Only accept applications for no reason return within 7 days after arrival, and freight costs are the responsibility of the customer)
6. Ensure that the item(s) you are returning is repackaged in the original condition with all the documentation and accessories that came with it.
7. If the returned product is not in original packaging: artificial damage causes to affect the second sale, such as its appearance being damaged, the lack of accessories, etc., we will deduct the corresponding expenses according to the situation.
8. We will handle your request once getting your returning item.

(2) How to return a product for a refund? (30 days money-back guarantee)

To return an item to Sylvox, Please contact the Sylvox team at service@sylvoxtv.com to submit an after-sales application, we will provide you with the shipping label in the mail. Please include your original order number or order proof in the email and ensure that the item is returned within 30 days. No refunds will be issued until the item is received in its original packaging (with its documentation and accessories).

(3) Refunds

Once we receive and verify the condition of your product, a refund is initiated. The way your refund is processed depends on your original payment method. For credit or debit cards, refunds will be back to the card-issuing bank within 7-10 business days of receipt of the returned item. Please contact the card-issuing bank with questions about when the credit will be posted to your account.

(4) What does the warranty not cover?

- (a) The wrong way of use and improper repair by the user caused the failure or damage.
- (b) Failure or damage caused by transportation, moving, and falling after purchase.
- (c) Other unavoidable external factors cause failure and damage.
- (d) Improper use of the equipment caused by water or other solution of damage.
- (e) Failure caused by a lightning strike or other electric system reasons
- (f) Damage caused by using power supply other than specified voltage.

Warranty Period:

- * Sylvox repairs the product free of charge under the condition of the normal use of the instruction manual within 12 months.
- * Sylvox warrants that this product conforms to the manufacturer's specifications and will be free of defects in material and workmanship should any defect occur.
- * Sylvox will correct the defect subject to the following conditions:
 - (a) Any defects caused or repairs required as a result of the abusive operation, negligence, accident, shipment damages, improper delivery and installation, application, and use for which this product was not intended as set forth in the user's manual or other applicable Product documentation.
 - (b) Any defects caused or repairs required as a result of any product that has been tampered with, modified, adjusted, or repaired by any person other than Sylvox, a Sylvox authorized service provider or a Sylvox authorized service center or dealer.
 - (c) Any replacement of accessories, glassware, consumable or peripheral items required through normal use of the Product, including but not limited to, earphones, remote controls, batteries, etc.
 - (d) Any cosmetic damage to the Product surface or exterior, including but not limited to that which has been defaced or caused through normal wear and tear, improper shipping and handling, or the use of chemical cleaning agents.
 - (e) Any defects caused or repairs required as a result of damage caused by any external or environmental conditions, including but not limited to, the use of incorrect voltage, fluctuations or surges in transmission line/power line voltage, liquid spillage, or acts of nature or God.
 - (f) Warranty claims for Products returned with the altered, illegible, or missing model, factory serial number, and UL markings.
 - (g) Any Products used for rental, business, or commercial purposes.
 - (h) Any installation, consumer instruction, delivery, setup, adjustment, and/or programming charges.
 - (i) A Product that is not installed following installation instructions is included with the Product.
 - (j) Any signal reception problems (including antenna-related problems), images "burnt" into the screen, signal noise or echo, interference or other signal transmission or delivery problems, availability of third-party provided services or content (including, without limitation, image, audio or video content).

No other entity other than Sylvox is authorized to extend, enlarge or transfer this warranty on behalf of Sylvox.

The express warranties in this limited warranty are, in lieu of and, except to the extent prohibited by applicable law, Sylvox disclaims all other warranties and conditions, express or implied, whether arising by law, statute, by course of dealing, or usage of trade, including, without limitation, implied warranties or conditions of all claims, whether based in contract, negligence, strict liability or otherwise. Some states do not allow the exclusion or limitation of incidental or consequential damages, so the above limitation or exclusion may not apply to you.

For any questions, feel free to contact us via service@sylvoxtv.com at any time!



FCC Warning

This device complies with part 15 of the FCC rules. Operation is subject to the following two conditions: (1) this device may not cause harmful interference, and (2) this device must accept any interference received, including interference that may cause undesired operation.

Changes or modifications not expressly approved by the party responsible for compliance could void the user's authority to operate the equipment.

NOTE: This equipment has been tested and found to comply with the limits for a Class B digital device, pursuant to part 15 of the FCC Rules. These limits are designed to provide reasonable protection against harmful interference in a residential installation. This equipment generates uses and can radiate radio frequency energy and, if not installed and used in accordance with the instructions, may cause harmful interference to radio communications. However, there is no guarantee that interference will not occur in a particular installation. If this equipment does cause harmful interference to radio or television reception, which can be determined by turning the equipment off and on, the user is encouraged to try to correct the interference by one or more of the following measures:

- Reorient or relocate the receiving antenna.
- Increase the separation between the equipment and receiver.
- Connect the equipment into an outlet on a circuit different from that to which the receiver is connected.
- Consult the dealer or an experienced radio/TV technician for help.

Radiation Exposure Statement

This equipment complies with FCC radiation exposure limits set forth for an uncontrolled environment. This equipment should be installed and operated with minimum distance 20cm between the radiator and your body.