

BOOMX-D

2.4G Digital 1-Trigger-2 Wireless Microphone



User Manual

Foreword

Thanks for purchasing COMICA BoomX-D 2.4G Digital 1-Trigger-2 Wireless Microphone.

To ensure bring you a good using experience, please read this manual book carefully before using and correctly install and operate.

Main Features

- . 2.4G Digital Wireless, Global Free Frequency
- . Dual Transmitters Triggered by One Receiver
- . Visual Power, Audio Dynamic Monitor and Other Display Functions
- . Internal and External MIC Two Input Modes
- . Mono/Stereo Switchable Output Modes
- . Real-time Audio Monitor
- . Broadcasting Quality Audio
- . RF Technology, Auto Freq. Adjustment, Stable Transmission
- . Low Latency < 20ms
- . Working Range Up to 50m
- . Designed with Multi-functional Belt Clip and Compact

Notice

- ⚠ Due to 2.4G wireless characteristics, please keep face to face when use it, and don't turn your back to the receiver, otherwise it is easy to generate breakpoints, which is a normal phenomenon
- ⚠ Don't block the antenna position to avoid any poor signal generated
- ⚠ Please attention that it can not realize STEREO function when in one-trigger-one mode
- ⚠ 3.5mm TRS-TRS Audio Cable is suitable for Canon, Nikon and other cameras with low sensitivity
3.5mm TRS-TRS Audio Output Cable with Impedance is suitable for Sony, Panasonic, Fujifilm and other cameras with high sensitivity(3.5mm TRS-TRS Audio Output Cable with Impedance is recommended to be used if there is sound explosive in recording)
- ⚠ When using on mobile phone, please turn off WIFI and Bluetooth to avoid 2.4G wireless interference
- ⚠ This product belongs to high-precision instruments, please avoid falling, collision or pounding
- ⚠ Do not use this equipment in the vicinity of heat source or interference source, such as radiator, oven, refrigerator or air conditioner, smartphone or next to the WIFI AP
- ⚠ If the pick-up distance is close or when used outdoors, please put on the wind muff to prevent sound burst or reduce wind noise
- ⚠ Do not use the equipment in rain or in a damp environment to avoid short-circuit danger
- ⚠ Please keep the product in a dry environment

Please keep face to face when use it, and don't turn your back to the receiver, otherwise it is easy to generate breakpoints.

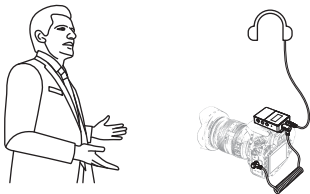

Face to receiver (correct)

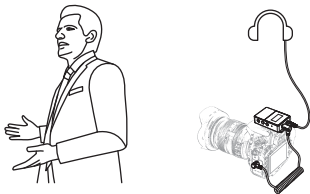

Back to receiver (incorrect)

Don't block the antenna position to avoid any poor signal generated.

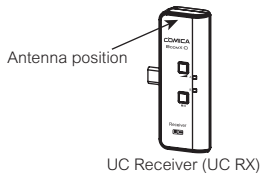
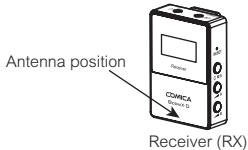
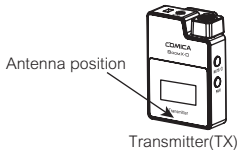

Packing List

Main Parts:



Transmitter(TX)



Receiver (RX)



UC Receiver (UC RX)

Multiple Selections:



D1 = TX + RX



D2 = TX + TX + RX



UC1 = TX + UC RX



UC2 = TX + TX + UC RX

Accessories:

- ① 3.5mm Mic Audio Input Cable
- ② Wind Muff
- ③ 3.5mm TRS-TRRS Audio Cable (For Smartphone)
- ④ 3.5mm TRS-TRS Audio Output Cable (For Canon, Nikon, etc.)
- ⑤ 3.5mm TRS-TRS Audio Output Cable with Impedance(For Sony, Panasonic, Fujifilm, etc.)
- ⑥ USB A-USB C Charging Cable
- ⑦ Reset Pin
- ⑧ User Manual
- ⑨ Warranty Card



The accessories of each combination include:

D1= ① + ② + ③ + ④ + ⑤ + ⑥ + ⑦ + ⑧ + ⑨

D2= ①x2 + ②x2 + ③ + ④ + ⑤ + ⑥ + ⑦ + ⑧ + ⑨

UC1= ① + ② + ⑥ + ⑦ + ⑧ + ⑨

UC2= ①x2 + ②x2 + ⑥ + ⑦ + ⑧ + ⑨

Components and Instruction

Transmitter (TX)

1. External Mic Locking Buckle
2. 3.5mm TRS Port of External Mic
3. Internal Mic
4. Power/Muting Button
5. Pair Button
6. Belt Clip
7. USB-C Charging Port
8. Reset Hole

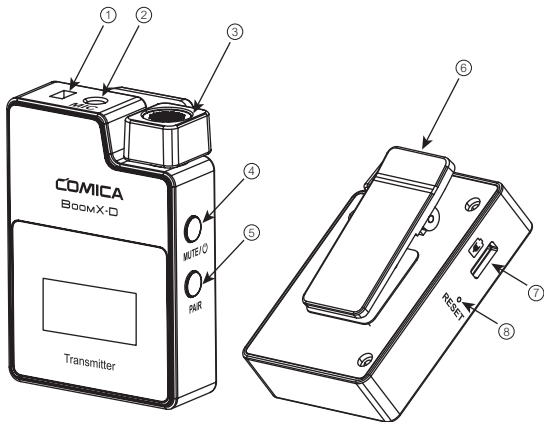

Receiver (RX)

1. 3.5mm TRS/TRRS Monitoring Port
2. 3.5mm TRS Audio Output Port
3. Reset Hole
4. Power and M/S Button
5. A Channel Output Gain Control Button
6. B Channel Output Gain Control Button
7. Belt Clip
8. USB-C Charging Port

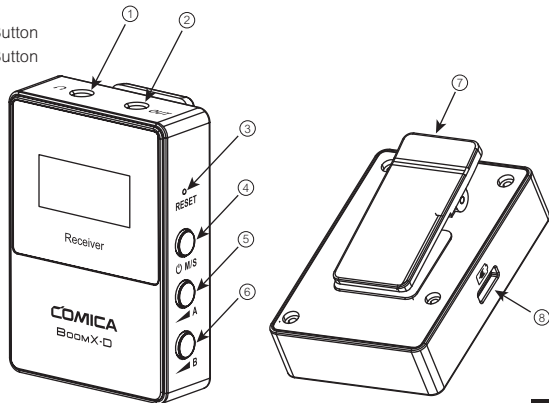

UC Receiver (UC RX)

1. USB-C Connector
2. Output Volume Adjustment Button
3. Group A Working Status Indicator
4. Group B Working Status Indicator
5. M/S Adjustment Button
6. 3.5mm TRS/TRRS Monitoring Port

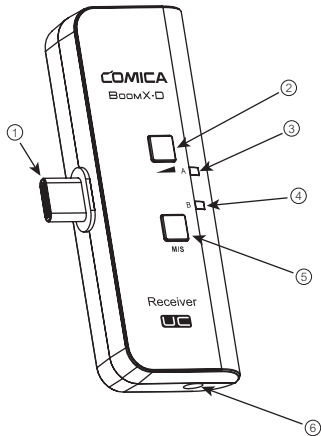

Installation

Transmitter (TX)

1. Use internal microphone :

Install the transmitter on the collar through the belt clip so that the internal microphone points in the direction of the sound source.

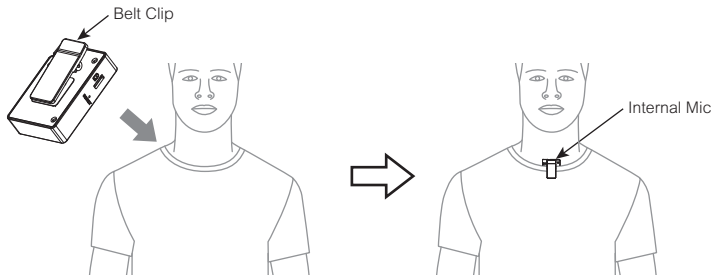

👉 For better concealment during use, it is recommended that the belt clip be fixed and used outwards.

2. Use external microphone:

Insert the 3.5mm TRS microphone input cable into the transmitter's 3.5mm TRS external microphone port and tighten it, then clip the transmitter to the belt through the belt clip and clip the lavalier microphone to your collar.

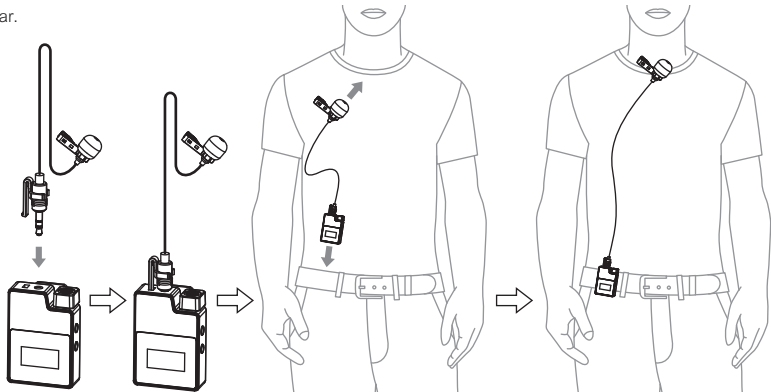

👉 When using an external microphone, the internal microphone is automatically turned off.

Receiver (RX)

1. Work with Camera:

Fix the receiver through the belt clip to the camera's hot shoe mount, then connect the receiver with camera through the 3.5mm TRS-TRS audio cable; Insert the headphone into the monitoring port for monitoring.

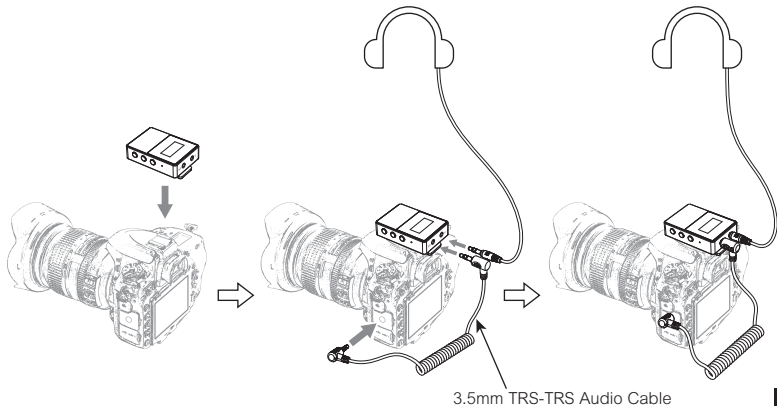

2.Work with Smartphone:

Clip the receiver to the cold shoe mount through the belt clip; Connect the receiver with the mobile phone through the 3.5mm TRS-TRRS audio cable and pay attention to the access to the audio output jack of the receiver is the 3.5mm TRS plug, and the access to the mobile phone is the 3.5mm TRRS plug; Insert the headphone to the 3.5 mm TRS/TRRS monitoring port for monitoring.

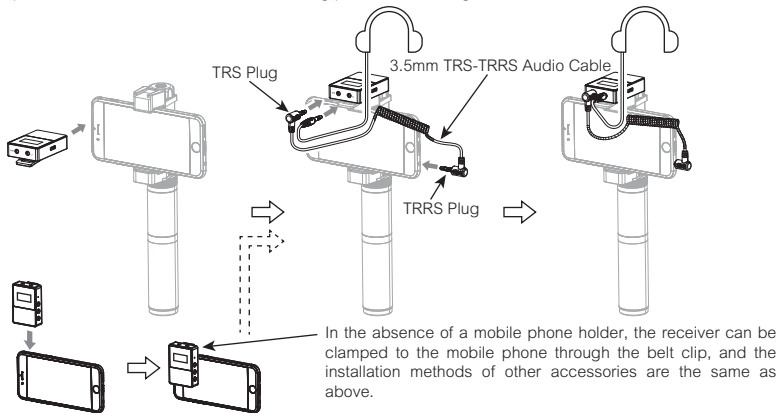

UC Receiver (UC RX)

Insert the UC receiver (UC RX) into the USB-C port of the phone; Insert the headphone into the 3.5mm TRS/TRRS monitoring port for monitoring.

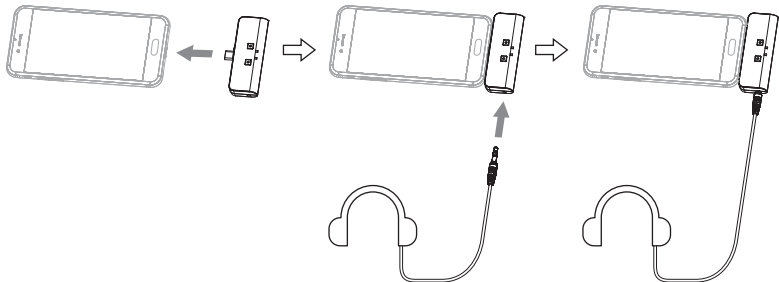

Function and Usage

Transmitter (TX)

1. Screen Display Instruction:

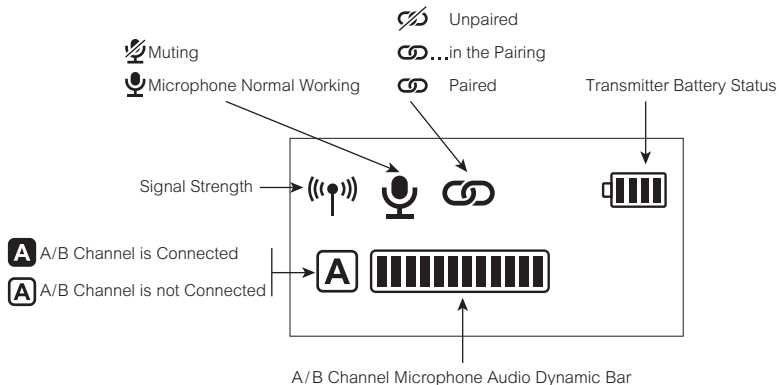

2.Function Introduction:

2.1. Power/Muting Button

Long press for On/Off; Short press for muting switch(Muting switch is available only when the screen is on, if the screen is dimmed, press any button to light up the screen then switch the mute).



2.2. Pair Button

Long press for pairing with receiver (Pairing switch is available only when the screen is on, if the screen is dimmed, press any button to light up the screen then pairing).



2.3. USB-C Charging Port

Connect the transmitter with the power through the USB A-USB C charging cable to charge.

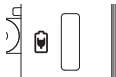

2.4. Reset Hole

If there is an abnormal phenomenon such as the device is crash or unable to turn on it, then insert the reset pin into the reset hole to reset it.



2.5. 3.5mm TRS Microphone Port

Insert the 3.5mm TRS microphone input cable, and you can use the external lavalier microphone for recording. At this time, the internal microphone of this device is turned off.



Receiver (RX)

1. Screen Display Instruction:

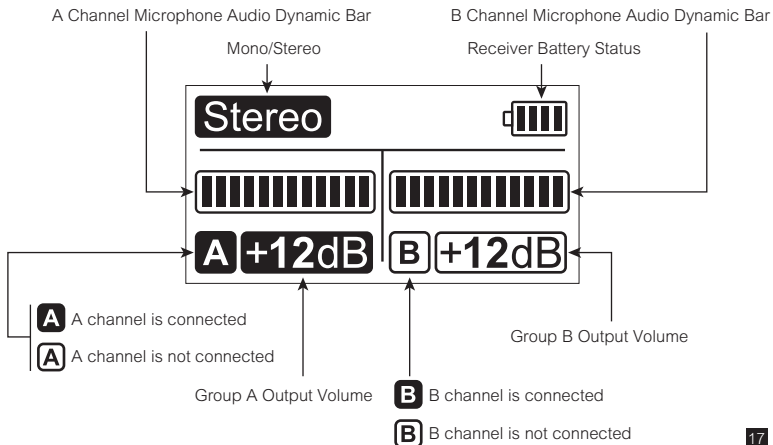

2.Function Introduction:

2.1. Reset Hole

If there is an abnormal phenomenon such as the device is crash or unable to turn on it, then insert the reset pin into the reset hole to reset it.



2.2. Power and M/S Button

Long press for On/Off; Short press for mono and stereo mode switch. Please attention that it can not realize STEREO function when in one-trigger-one mode.

(Mono/Stereo switch is available only when the screen is on, if the screen is dimmed, press any button to light up the screen then switch the M/S)



2.3. A/B Channel Output Volume Adjustment Button

Short press to cyclically adjust the A/ B channel output Volume. It can independently adjust even in the mono mode and is generally adjusted to the consistent output Volume when in use. (The output Volume adjustment is available only when the screen is on, and if the screen is dimmed, press any button to light up the screen and then adjust again).



2.4. USB-C Charging Port

Connect the receiver with the power through the USB A-USB C charging cable to charge.



2.5. 3.5mm TRS Audio Output Port

Connect with mobile phone through the 3.5mm TRS-TRRS audio cable; Connect with camera through the 3.5mm TRS-TRS audio cable (3.5mm TRS-TRS Audio Output Cable with Impedance is recommended to be used if there is sound explosive in recording).



2.6. 3.5mm TRS/TRRS Monitoring Port

Insert headphone to monitor.



UC Receiver (UC RX)

Function Introduction:

1. USB-C Plug

Insert into the USB-C port of phone to use.



2. Output Volume Adjustment Button

Short press to cyclically adjust the Volume, and A/B channel is synchronized.



3. M/S Button

Short press for Mono/Stereo switch. Please attention that it can not realize STEREO function when in one-trigger-one mode.



M/S

4. A/B Working Status Indicator

The indicator is red when unpaired. After paired, the indicator is blue when it's Mono and is purple when it's Stereo.

A

B

5. 3.5mm TRS/TRRS Monitoring Port

Insert headphone to monitor.



Pairing Method

(All have been paired at the factory. If you need to re-pair, please follow the description)

One-trigger-one:

Turn on the transmitter and receiver within one meter, and then press the pair button for pairing when the transmitter screen is highlighted.

The transmitter (TX) is pairing with the receiver (RX)



The screen icon changes from  to  after pairing

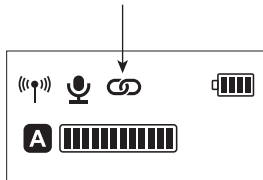

The microphone audio dynamic bar is available after pairing

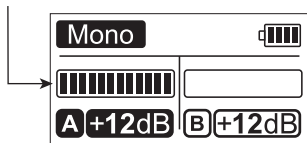

The transmitter (TX) is pairing with UC Receiver (UC RX)

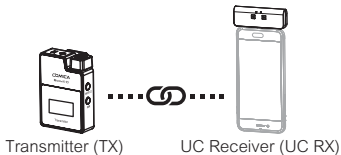

The screen icon changes from  to  after pairing

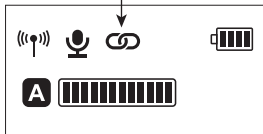

The channel indicator on the UC receiver (UC RX) changes from red to blue or purple after pairing

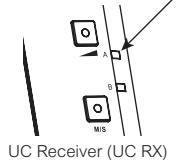

One-trigger-two:

Turn on the transmitter and receiver within one meter, and then long press the pair button of one transmitter to pair the receiver when the transmitter screen is highlighted. After the pairing is successful, the receiver will designate the first paired transmitter as channel A. Then long press the pair button of the second transmitter for pairing, and the receiver will designate the second paired transmitter as channel B after the pairing is successful. Channel A is the left channel, channel B is the right channel.

Two transmitters (TX) are pairing with Receiver (RX)

The first paired transmitter

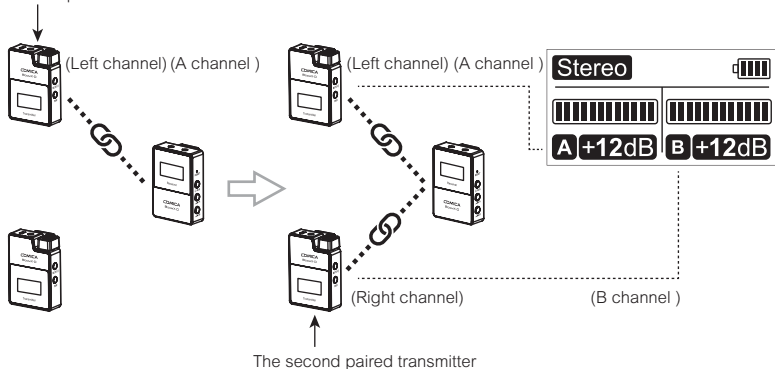

Two transmitters (TX) are pairing with UC Receiver (UC RX)

The first paired transmitter

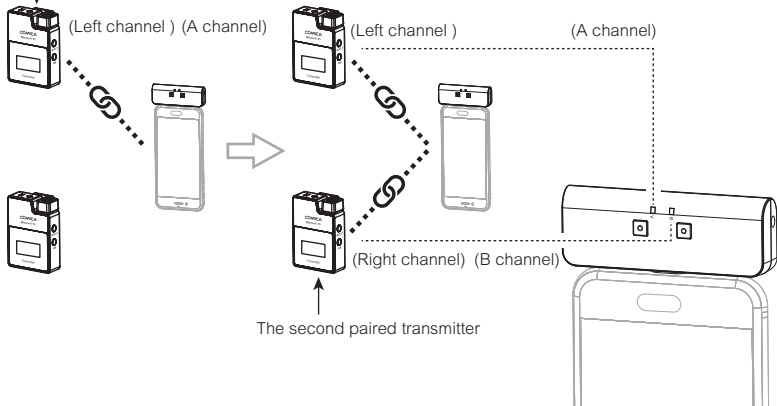

Specification

Transmitter (TX)

Wireless Band	2400 ~ 2483.5MHz
Transmitting Power	+10dBm
Receiving Sensitivity	-86dBm
Antenna	PCB Antenna
Polar Pattern	Omnidirectional
Frequency Response	80Hz ~ 20kHz
Sound Delay	<20ms
External Mic Input Interface	3.5mm TRS
Battery	Built-in Li-ion Battery 300mAh 3.7V
Battery Life	5 Hours
Net Weight	29g
Dimension	39 x 22 x 55mm
Operating Temperature	0°C ~ 50°C

Receiver (RX)

Wireless Band	2400 ~ 2483.5MHz
Receiving Sensitivity	-86dBm
Antenna	PCB Antenna
Audio Output Amplitude	+0dB ~ +12dB
Sound Delay	<20ms
Audio Output Interface	3.5mm TRS
Monitor Interface	3.5mm TRS/TRRS
Battery	Built-in Li-ion Battery 300mAh 3.7V
Battery Life	5 Hours
Net Weight	29g
Dimension	39 x 22 x 55mm
Operating Temperature	0°C ~ 50°C

UC Receiver (UC RX)

Wireless Band	2400 ~ 2483.5MHz
Receiving Sensitivity	-86dBm
Antenna	PCB Antenna
Audio Output Amplitude	+0dB ~ +12dB
Sound Delay	<20ms
Data Interface	USB-C
Monitoring Interface	3.5mm TRS/TRRS
Net Weight	19g
Dimension	33 x 13 x 70mm
Operating Temperature	0°C ~ 50°C



www.comica-audio.com

Email: support@comica-audio.com

The COMICA LOGO is trademark which is registered and owned by Commlite Technology Co.,Ltd

FCC Statement

This device complies with part 15 of the FCC rules. Operation is subject to the following two conditions: (1) this device may not cause harmful interference, and (2) this device must accept any interference received, including interference that may cause undesired operation.

Changes or modifications not expressly approved by the party responsible for compliance could void the user's authority to operate the equipment.

NOTE: This equipment has been tested and found to comply with the limits for a Class B digital device, pursuant to part 15 of the FCC Rules. These limits are designed to provide reasonable protection against harmful interference in a residential installation. This equipment generates uses and can radiate radio frequency energy and, if not installed and used in accordance with the instructions, may cause harmful interference to radio communications. However, there is no guarantee that interference will not occur in a particular installation. If this equipment does cause harmful interference to radio or television reception, which can be determined by turning the equipment off and on, the user is encouraged to try to correct the interference by one or more of the following measures:

- Reorient or relocate the receiving antenna.
- Increase the separation between the equipment and receiver.
- Connect the equipment into an outlet on a circuit different from that to which the receiver is connected.
- Consult the dealer or an experienced radio/TV technician for help.

The device has been evaluated to meet general RF exposure requirement. The device can be used in portable exposure condition without restriction.

ISED Statement

- English: This device complies with Industry Canada license - exempt RSS standard(s). Operation is subject to the following two conditions: (1) This device may not cause interference, and (2) This device must accept any interference, including interference that may cause undesired operation of the device.

The digital apparatus complies with Canadian CAN ICES - 3 (B)/NMB - 3(B).

- French: Le présent appareil est conforme aux CNR d'Industrie Canada applicables aux appareils radio exempts de licence. L'exploitation est autorisée aux deux conditions suivantes: (1) l'appareil ne doit pas produire de brouillage, et (2) l'utilisateur de l'appareil doit accepter tout brouillage radioélectrique subi, même si le brouillage est susceptible d'en compromettre le fonctionnement.

l'appareil numérique du ciem conforme canadien peut - 3 (b) / nmb - 3 (b).

This device meets the exemption from the routine evaluation limits in section 2.5 of RSS 102 and compliance with RSS 102 RF exposure, users can obtain Canadian information on RF exposure and compliance.

cet appareil est conforme à l'exemption des limites d'évaluation courante dans la section 2.5 du cnr - 102 et conformité avec rss 102 de l'exposition aux rf, les utilisateurs peuvent obtenir des données canadiennes sur l'exposition aux champs rf et la conformité.

This equipment complies with Canada radiation exposure limits set forth for an uncontrolled environment. This equipment should be installed and operated with minimum distance 20cm between the radiator & your body.

Cet équipement est conforme Canada limites d'exposition aux radiations dans un environnement non contrôlé. Cet équipement doit être installé et utilisé à distance minimum de 20cm entre le radiateur et votre corps.

This device meets the exemption from the routine evaluation limits in section 2.5 of RSS 102 and compliance with RSS 102 RF exposure, users can obtain Canadian information on RF exposure and compliance.

cet appareil est conforme à l'exemption des limites d'évaluation courante dans la section 2.5 du cnr - 102 et conformité avec rss 102 de l'exposition aux rf, les utilisateurs peuvent obtenir des données canadiennes sur l'exposition aux champs rf et la conformité.

This equipment complies with Canada radiation exposure limits set forth for an uncontrolled environment. This equipment should be installed and operated with minimum distance 0mm between the radiator & your body.

Cet équipement est conforme Canada limites d'exposition aux radiations dans un environnement non contrôlé. Cet équipement doit être installé et utilisé à distance minimum de 0mm entre le radiateur et votre corps.