

# COMICA

PROFESSIONAL AUDIO EQUIPMENT

## CVM-WM100 PLUS

UHF Wireless Microphone



# User Manual

## Foreword

Thanks for purchasing CVM-WM100 PLUS Plus wireless microphone;

WM100 Plus is a wireless microphone with dual-transmitter triggered by one receiver, with two AA batteries. It utilizes UHF wireless FM technology and LCD high-resolution lattice screen, 16-level adjustable volume, and is integrated into LCF(Low cut filter) , Auto IR Channel-match, Stereo / Mono switchable audio mode, RF signal strength adjustment, MIC/LINE IN input dual selection, Power monitoring at receiver end, Sound pickup dynamic display, Backlight adjustment and other functions, at the same time with strong shielding anti-noise performance, it's a high-quality microphone to broadcasting level;

To ensure the smooth use and safety of the product, please carefully read this instruction before using and properly assemble and operate.

## Main Features

- . 1-trigger-2, Perfectly Support Two Transmitters and One Receiver Work Simultaneously
- . Working Distance Up to 100m (Open Area 100m, 60m in area with obstacle)
- . M/S Switch, LCF, 16-levels Adjusted Gain Control, Muting Functions
- . AA Batteries and Support External Charging
- . Support Real-time Monitor
- . Volume Dynamic Monitor
- . Adjusted RF Power
- . Lattice LCD Display, High Resolution



1-Trigger-2



48 Channels



100m Working  
Distance



Real-time  
Monitor



Low Cut Filter



16-Levels  
Adjusted Gain Control



Muting Mode



External Power



Lattice LCD

## Notice

- ⚠ Transmitter should be used more than 10cm from Receiver, when the distance is less than 10cm, Receiver's wireless signal receiving part will take protect action to shut down wireless signal receiving, then audio may be intermittent, which is normal;
- ⚠ When using auto IR sync, please stay within 30cm, otherwise the signal may be so weak that the sync will not be successful;
- ⚠ In the case of stereo/mono mode switch, please preset the mode before using to avoid the transient interference caused by switching during usage;
- ⚠ The antenna will affect the working distance. Please protect the antenna and avoid any man-made damage;
- ⚠ The working distance will be affected by the surrounding environment. Please try to keep the environment open without interference during usage, and close the WIFI of the device itself;
- ⚠ When using this product in a short distance, it is recommended to set RF strength at 'LOW' to reduce the power consumption;
- ⚠ For smartphone shooting, customers must separately purchase a TRS-TRRS audio converting cable, and pay attention to set the mobile phone mode to 'Flight Mode' to avoid incoming call interference (It does not support the partial original recording of android systems, the third-party APP is recommended to be used in this case);
- ⚠ Please keep this product in dry environment;
- ⚠ Do not expose the device in rain or humid environment, otherwise there will be a danger of short circuit;

## Package Contents

### Main Parts:



Lavalier Transmitter (TX)

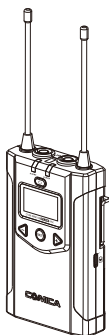

Receiver (RX)

### Accessories:

- ① 3.5mm Mic Audio Input Cable x 2 pcs
- ② 3.5mm-3.5mm Audio Output Cable x 1 pcs
- ③ 3.5mm-XLR Audio Output Cable x 1 pcs
- ④ Belt Clip x 3pcs
- ⑤ Camera mount x 1 pcs
- ⑥ Wind Muff x 2pcs
- ⑦ USB power input cable x 1 pcs
- ⑧ Portable Bag x 1 pcs
- ⑨ User Manual x 1 pcs
- ⑩ Warranty Card x 1 pcs



①



②



③



④



⑤



⑥



⑦



⑧



⑨



⑩

## Components

### Lavalier Transmitter (TX)

- ① Antenna
- ② Working Status Indicator
- ③ On-off / Muting Button
- ④ SET Function Menu
- ⑤ Function Selection Button -
- ⑥ LINE IN External Input
- ⑦ IR Sensor
- ⑧ Mic External Input
- ⑨ IR Status Indicator
- ⑩ Function Selection Button +
- ⑪ Micro USB Port for External Charging
- ⑫ Belt Clip
- ⑬ 1/4 Thread
- ⑭ Battery Tray

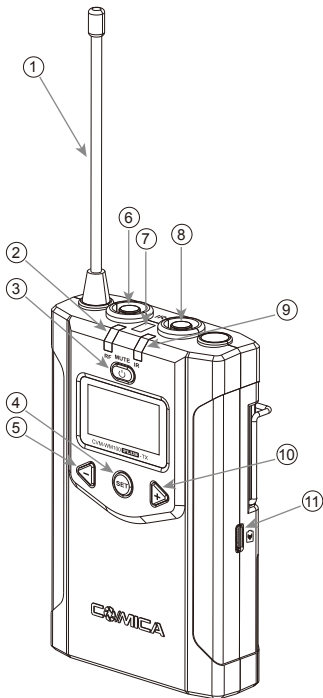
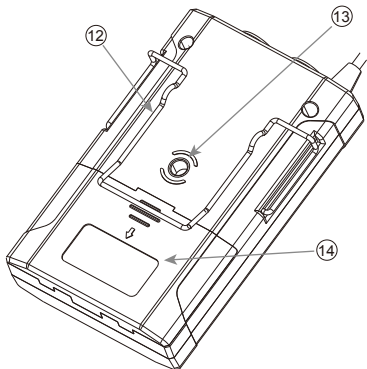





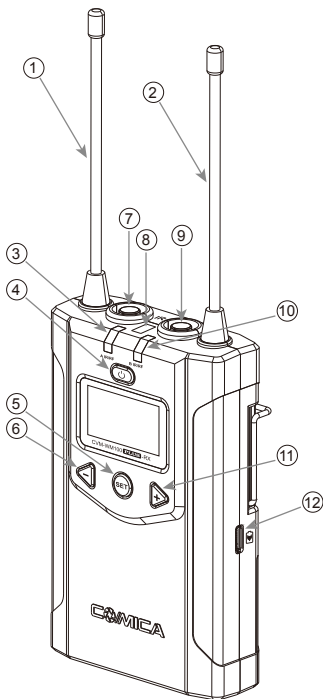
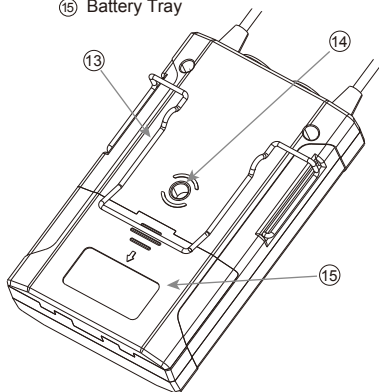

## Receiver (RX)

- ① Group A Antenna
- ② Group B Antenna
- ③ Group A Working Status Indicator
- ④ On-Off Button
- ⑤ SET Function Button
- ⑥ Function Selection Button -
- ⑦ 3.5mm Audio Input Jack
- ⑧ IR Sensor
- ⑨ 3.5mm monitoring Jack
- ⑩ Group B Working Status Indicator
- ⑪ Function Selection Button +
- ⑫ Micro USB Port for External Charging
- ⑬ Belt Clip
- ⑭ 1/4 Thread
- ⑮ Battery Tray



## Function Button Instruction

<p>Lavalier Transmitter / Receiver</p>  	<p>Power / Muting Button</p> 	Long Press	Power On / Off
		Short Press	Muting Mode (the mute function can be activated only when the screen is lighted up )
	<p>SET Function Menu</p> 	Long Press	Enter the function adjustment menu
		Short Press	1.Confirm the selected function 2.Exit the function adjustment menu
	<p>+ Button</p> 	Short Press	Function Adjustment (+)
	<p>- Button</p> 	Short Press	Function Adjustment (-)

### **Low cut function:**

Appropriately cut the low frequency part of the sound, reduce the noise of the low frequency part, to make target sound more clean and clear.

### **Signal strength high/low switching effect:**

With high signal strength, the working distance is up to 60-100m, but high power consumption and short battery life.

With low signal strength, the working distance is up to 30-60m, but low power consumption and long battery life.

## Indicator Light Instruction

Transmitter	RF	Green Light Keeps On	Normal Recording Status ( This state is only for the transmitter, when the channel matches successfully, the receiver can pick up the sound )
		Red Light Keeps On	Muting Mode
		Red Light Flicker	Low-power reminder
	IR	Green Light Keeps On	Channel matches ( No matter the channel matches or not )
		Red Light Flicker	Channel in the match... ( only for IR Sync )
Receiver	A IR/RF	Green Light Keeps On	Normal working status after the channel matches
		Green Light Flicker	Channel doesn't match
	B IR/RF	Red Light Flicker	Channel in the match... ( only for IR Sync )
			Low-power reminder
		Red light keeps on	Group closed



A IR/RF : Group A Working Status Indicator

B IR/RF : Group B Working Status Indicator



### Preparation Before Usage

(Transmitter Operating Steps same with Receiver)

#### 1. Prepare Power Supply

There're two ways of Power Supply, you can optionally choose AA batteries or External charging:

- 1.1 Install two AA batteries into the battery tray according to their positive and negative electrode.

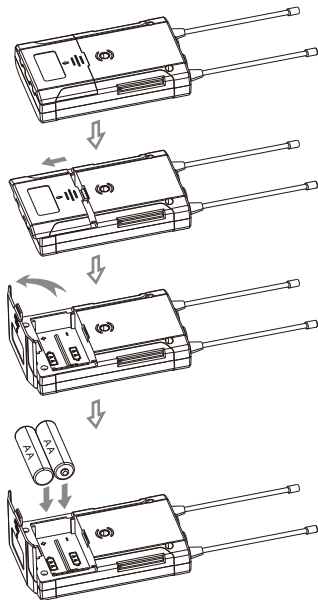

## 1.2 Charging with External Power

Insert micro USB cable to the USB charging port to realize external power charging

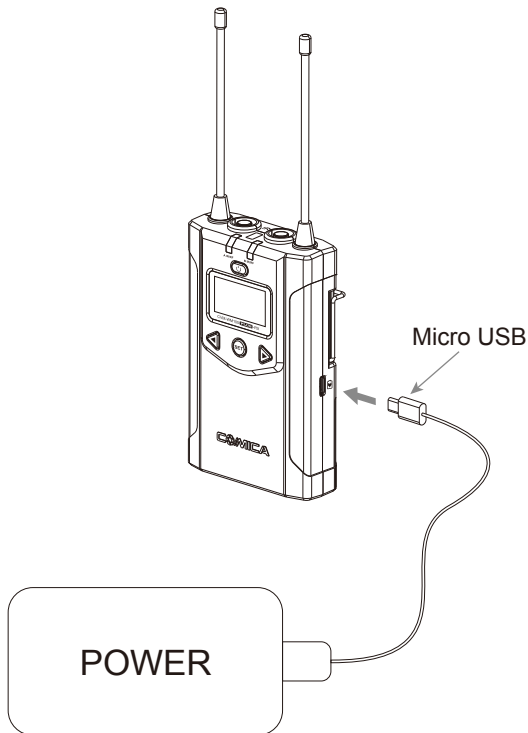

## 2. Belt Clip Installation

Please install the belt clip according to the illustration if you require the way of connection.

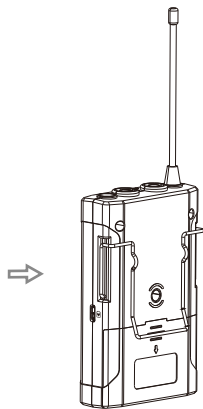
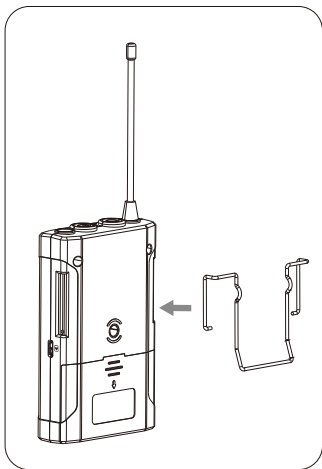

### 3. Lavalier Transmitter Installation

3.1 Insert the 3.5mm audio input line into MIC socket

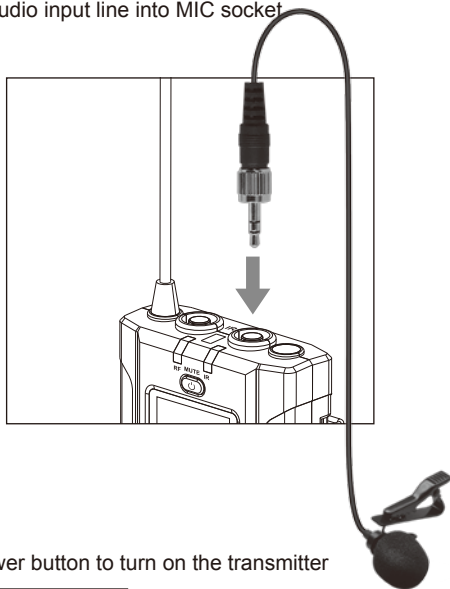

3.2 Long press the power button to turn on the transmitter

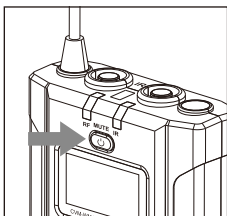

3.3 Target the MIC to the audio source and check the working status according to the volume indicator on the screen

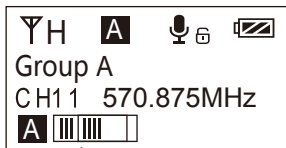
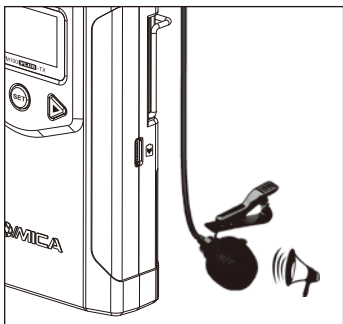

Audio Dynamic Display Bar

3.4 After the channel matching with the receiver, it can be used

 Please refer to screen operation instruction for channel matching.

## 4. Receiver Installation

4.1 Connect receiver to your video equipment through the camera mount

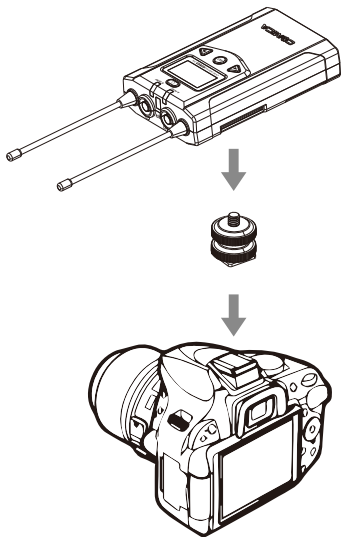

4.2 Connect one end of the 3.5mm-3.5mm audio OUTPUT cable to the OUTPUT port of WM200RX and another end to the AUDIO INPUT port of the camera or camcorder. Insert the headphone into the 3.5mm monitoring port for real-time monitoring and then long press power button to turn on the receiver.

 Most DSLR cameras has 3.5MM port, if you use the XLR camcorder, you need to use the 3.5mm-XLR audio output cable.

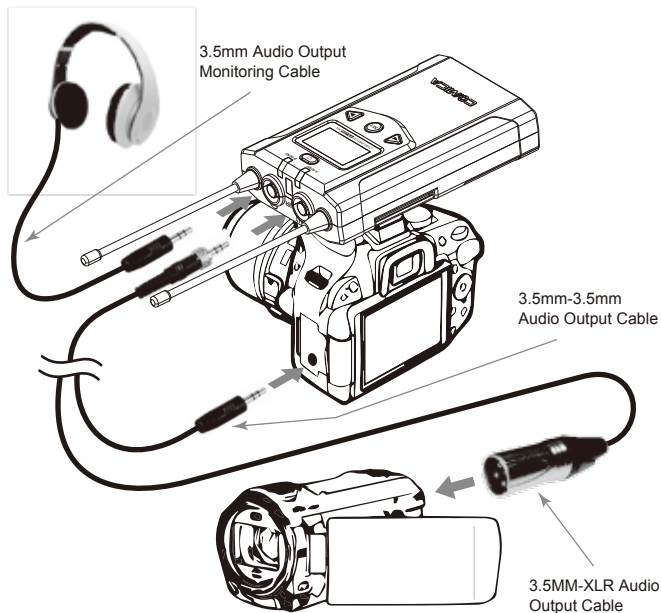

4.3 After the channel matching with the receiver, it can be used

👉 Please refer to screen operation instruction for channel matching.

## Screen Display and Operation Instruction

### Lavalier Transmitter

#### Screen Display Instruction

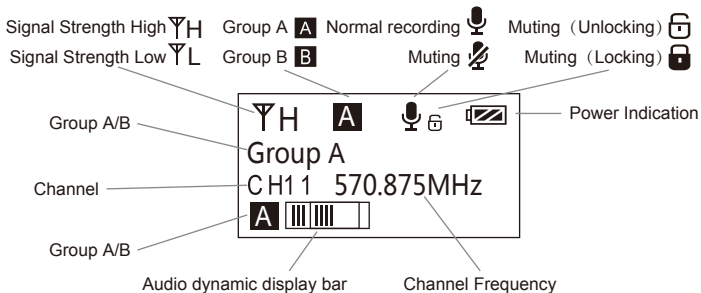

- Mic mode is for Microphone input;
- Line in mode is for external audio input, such as smartphone player;
- Selecting the corresponding input mode will bring you a better audio experience.



## Operation Instruction

### 1.Manually Adjust the Channel of Transmitter

1.1 Long press  button to CH setting display page

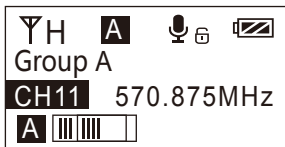

1.2 Short press   button to select the channel

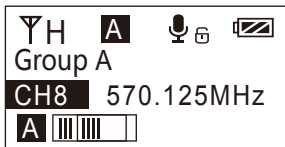

1.3 Short press  button to confirm

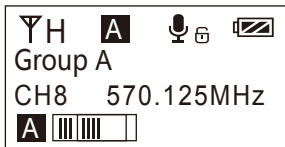

## 2.Group A/B Selection

2.1 Press   button to ' Group Setting ' display page

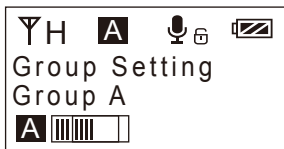

2.2 Long press  button to ' Group Setting ' setting page

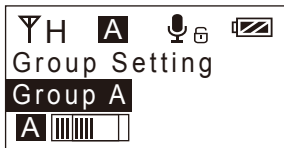

2.3 Press   button to select the group

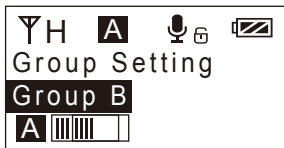

2.4 Short press  button to confirm

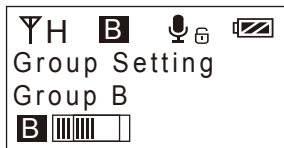

### 3. Low Cut Filter ‘ Low/High/OFF ’ Adjustment

3.1 Press   button to ‘ Low Cut Filter ’ display page



3.2 Long press  button to enter ‘ Low Cut Filter ’ setting page

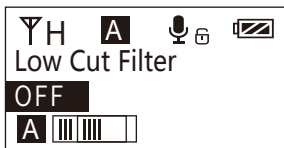

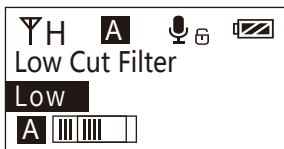

3.3 Press   button to select LCF ‘ Low/High/OFF ’





3.4 Short press  button to confirm

 Low-cut function will filter out the low-frequency part of the audio source, such as the chirping and crowd noise, and the main audio source will be more crisp. Low cut divided into low cut in low range and low cut in high range, low range is to filter out part of the noise, while high range of low cut filter out all noise. Turn off the low cut to restore the true, the main source will be more vigorous, but it can be adjusted according to actual needs.

## 4. Transmitting Signal Strength ' High/Low ' Adjustment

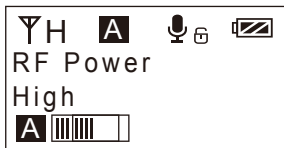
4.1 Press   button to ' RF Power ' display page



4.2 Long press  button to ' RF Power ' setting page

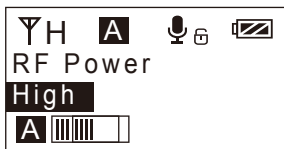

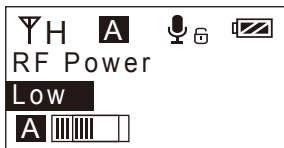

4.3 Press   button to adjust the transmitting signal strength

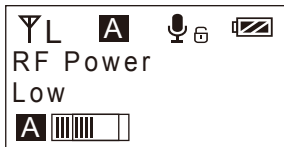

4.4 Short press  button to confirm



## 5. Muting Mode Enable/ Disable

5.1 Press   button to ' Muting ' display page



5.2 Long press  button to ' Muting ' setting page





5.3 Press   button to select Muting mode Enable/ Disable



5.4 Short press  button to confirm



 When set to 'Disable', the muting function cannot be used, the icon is: 

When set to 'Enable', the muting function works, the icon is: 

The muting mode can be controlled only when the screen is on, press any button to light the screen and then press the  button to switch the muting mode.



## 6.Backlight ' Lighting Time/Turn Off ' Adjustment

6.1 Short Press   button to ' Backlight ' display page



6.2 Long press  button to ' Backlight ' setting page



6.3 Short press   button to adjust the backlight lighting time or you can turn it off for power saving



6.4 Short press  button to confirm

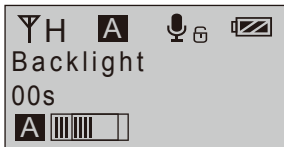



## 7. Reset to Defaults

7.1 Press   button to 'Reset' display page



7.2 Long press  button to enter 'Reset' setting page



7.3 Short press   button to select whether to restore factory Settings



7.4 Short press  button to confirm and restore factory setting





## 8. Version

8.1 Press   button to ' Version ' display page to check the version



# Receiver

## Screen Display Instruction

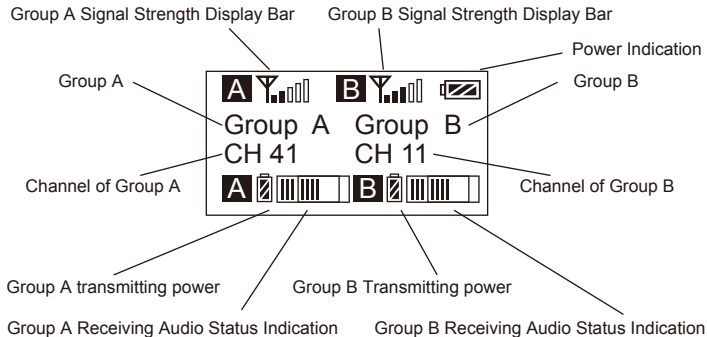

When Group A/B is on, the background color of the channel display icon is black;  
When Group A/B is off, the channel display icon is transparent and no background color.

## Operation Instruction

### 1. Manually Adjust the Channel of Group A/ Group B

- 1.1 Long press  button to 'CH' display page of Group A, and short press again to switch to 'CH' display page of Group B.

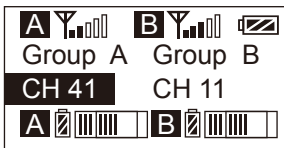

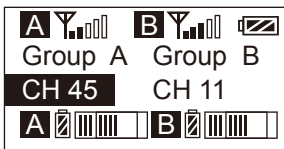

- 1.2 Short press   button to select the channel



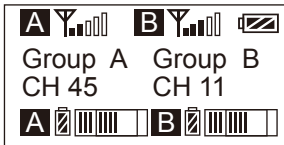

- 1.3 Short press  button to confirm





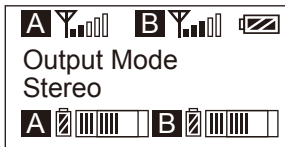

## 2. Audio Output Mode 'Stereo/Mono' Adjustment

2.1 Press   button to ' Output Mode ' display page

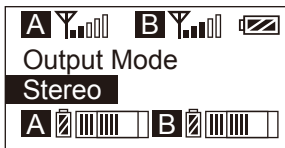

2.2 Long press  button to ' Output Mode ' setting page



2.3 Press   button to select Mono/ Stereo Output Mode, Short press  button to confirm

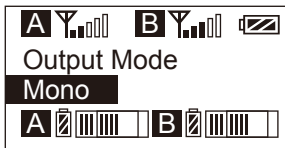

 When one use only one Transmitter (Group A or Group B), the output of Receiver only work in Mono mode.

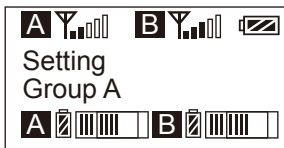

### 3.Group A/B Function Setting

3.1 Press   button to ' Setting ' display page

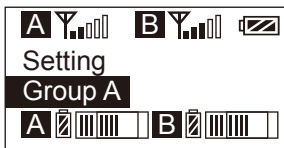

3.2 Long press  button to 'Group A / B Selection' Setting Page



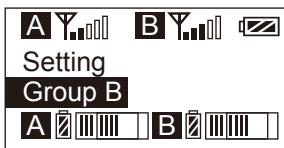

3.3 Press   button to select Group A/B to edit

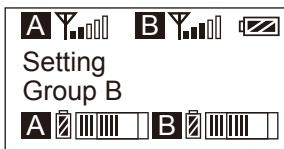

3.4 Short press  button to confirm



## 4.Group A/B ' On/ Off ' Adjustment

4.1 Short Press   button to ' Group A Setting ' display page  
Power ON

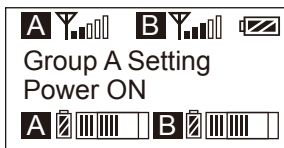

4.2 Long press  button to ' Setting ' setting page

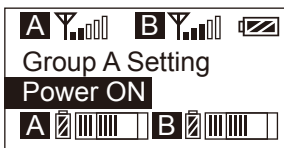

4.3 Short Press   button to select ' Power Off ' or not

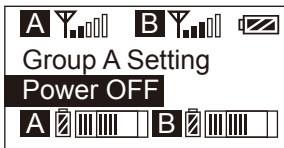

4.4 Short press  button to confirm

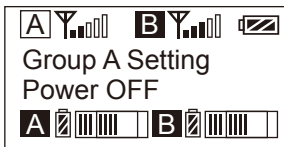

## 5.Group A/B Volume Adjustment

5.1 Short Press   button to ' Group A Setting ' display page  
Volume

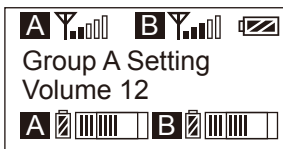

5.2 Long press  button to ' Volume ' setting page

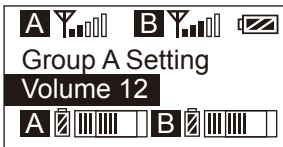

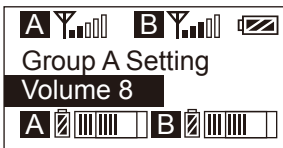

5.3 Short Press   button to adjust the volume

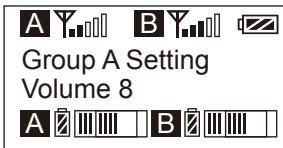

5.4 Short press  button to confirm





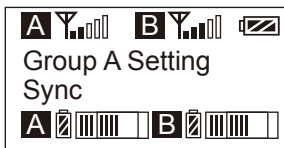

## 6.Group A/B IR Sync

6.1 Short Press   button to 'Group A Setting Sync' display page

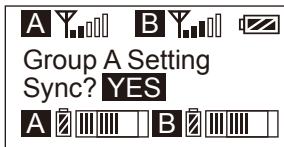

6.2 Long press  button for IR Matching with transmitter



6.3 Use the   button to select whether to match, and short press  to confirm, Matching OK

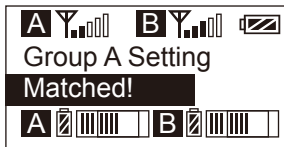
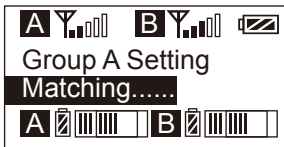



 While in IR matching, please make sure the IR sensor of transmitter and receiver point to point within 30cm, otherwise it may not succeed.



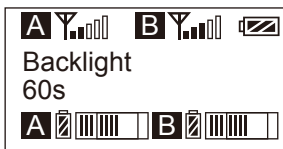

## 7. Backlight ' Lighting Time/Turn Off ' Adjustment

7.1 Short Press   button to ' Backlight ' display page

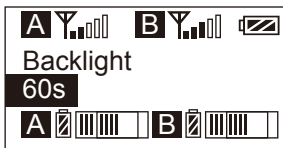

7.2 Long press  button to ' Backlight ' setting page



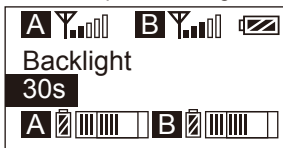

7.3 Short press   button to adjust the backlight lighting time or you can turn it off for power saving





7.4 Short press  button to confirm



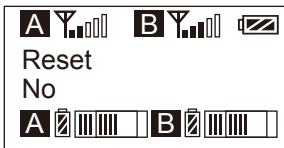

## 8. Reset to Defaults

8.1 Press   button to 'Reset' display page

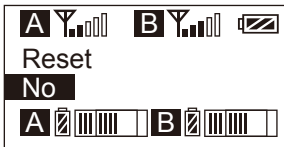

8.2 Long press  button to enter 'Reset' setting page



8.3 Short press   button to select whether to restore factory Settings

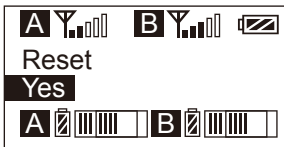

8.4 Short press  button to confirm and restore factory setting

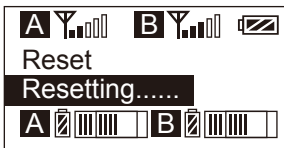

## 9. Version

9.1 Press   button to ' Version ' display page to check the version

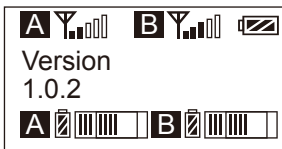

## Specification

### Lavalier Transmitter TX

Duration	6 Hours
Antenna	1/4 Wavelength Wire Antenna
Stray Radiation	< -60dBc
Sound Delay	< 20ms
Audio Distortion	< 0.5%
Signal/Noise	> 65dB
Frequency Response	20Hz~18KHz
Audio Input Socket	3.5mm Socket
Battery	AA batteries×2pcs
External Power	Micro USB 5V/1A
Size	107 x 66 x 26.1mm
Operating Temperature	0°C ~ +50°C
Storage Temperature	-20°C ~ +60°C

## Receiver RX

Duration	6 Hours
Antenna	1/4 Wavelength Wire Antenna
Sensitivity	-90dBm
Sound Delay	< 20ms
Audio Distortion	< 0.5%
Signal/Noise	> 65dB
Frequency Response	20Hz~18KHz
Audio Input Socket	3.5mm Socket
Battery	AA batteries×2pcs
External Power	Micro USB 5V/1A
Size	107 x 66 x 26.1mm
Operating Temperature	0°C ~ +50°C
Storage Temperature	-20°C ~ +60°C

**FCC Statement**

This device complies with part 15 of the FCC rules. Operation is subject to the following two conditions: (1) this device may not cause harmful interference, and (2) this device must accept any interference received, including interference that may cause undesired operation.

Changes or modifications not expressly approved by the party responsible for compliance could void the user's authority to operate the equipment.

NOTE: This equipment has been tested and found to comply with the limits for a Class B digital device, pursuant to part 15 of the FCC Rules. These limits are designed to provide reasonable protection against harmful interference in a residential installation. This equipment generates uses and can radiate radio frequency energy and, if not installed and used in accordance with the instructions, may cause harmful interference to radio communications. However, there is no guarantee that interference will not occur in a particular installation. If this equipment does cause harmful interference to radio or television reception, which can be determined by turning the equipment off and on, the user is encouraged to try to correct the interference by one or more of the following measures:

- Reorient or relocate the receiving antenna.
- Increase the separation between the equipment and receiver.
- Connect the equipment into an outlet on a circuit different from that to which the receiver is connected.
- Consult the dealer or an experienced radio/TV technician for help.

The device has been evaluated to meet general RF exposure requirement. The device can be used in portable exposure condition without restriction.

ISED Statement

- English: This device complies with Industry Canada license - exempt RSS standard(s). Operation is subject to the following two conditions: (1) This device may not cause interference, and (2) This device must accept any interference, including interference that may cause undesired operation of the device.

The digital apparatus complies with Canadian CAN ICES - 3 (B)/NMB - 3(B).

- French: Le présent appareil est conforme aux CNR d'Industrie Canada applicables aux appareils radio exempts de licence. L'exploitation est autorisée aux deux conditions suivantes: (1) l'appareil ne doit pas produire de brouillage, et (2) l'utilisateur de l'appareil doit accepter tout brouillage radioélectrique subi, même si le brouillage est susceptible d'en compromettre le fonctionnement.

l'appareil numérique du CIEM conforme canadien peut - 3 (b) / nmb - 3 (b).

This device meets the exemption from the routine evaluation limits in section 2.5 of RSS 102 and compliance with RSS 102 RF exposure, users can obtain Canadian information on RF exposure and compliance.

cet appareil est conforme à l'exemption des limites d'évaluation courante dans la section 2.5 du CNR - 102 et conformité avec RSS 102 de l'exposition aux RF, les utilisateurs peuvent obtenir des données canadiennes sur l'exposition aux champs RF et la conformité.

This equipment complies with Canada radiation exposure limits set forth for an uncontrolled environment. This equipment should be installed and operated with minimum distance 20cm between the radiator & your body. **( Receiver )**

Cet équipement est conforme Canada limites d'exposition aux radiations dans un environnement non contrôlé. Cet équipement doit être installé et utilisé à distance minimum de 20cm entre le radiateur et votre corps. **( Receiver )**

This device meets the exemption from the routine evaluation limits in section 2.5 of RSS 102 and compliance with RSS 102 RF exposure, users can obtain Canadian information on RF exposure and compliance.

cet appareil est conforme à l'exemption des limites d'évaluation courante dans la section 2.5 du CNR - 102 et conformité avec RSS 102 de l'exposition aux RF, les utilisateurs peuvent obtenir des données canadiennes sur l'exposition aux champs RF et la conformité.

This equipment complies with Canada radiation exposure limits set forth for an uncontrolled environment. This equipment should be installed and operated with minimum distance 0mm between the radiator & your body. **( launcher )**

Cet équipement est conforme Canada limites d'exposition aux radiations dans un environnement non contrôlé. Cet équipement doit être installé et utilisé à distance minimum de 0mm entre le radiateur et votre corps. **( launcher )**

The following text shall be included in the device's user manual:

This device operates on a no-interference, no-protection basis. Should the user seek to obtain protection from other radio services operating in the same TV bands, a radio licence is required. For further details, consult Innovation, Science and Economic Development Canada's Client Procedures Circular CPC-2-1-28, Voluntary Licensing of Licence-Exempt Wireless Microphones in the TV Bands.