



TEST REPORT

FCC PART 15.247

Report Reference No.: CTL2405161091-WF

Compiled by: Happy Guo
(position+printed name+signature) (File administrator)

Tested by: Jack Wang
(position+printed name+signature) (Test Engineer)

Approved by: Ivan Xie
(position+printed name+signature) (Manager)

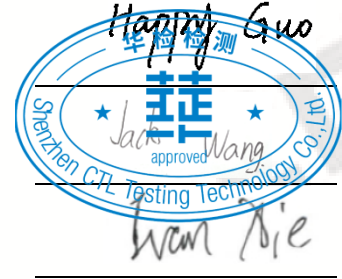

Product Name : 2.4G Wireless Microphone
Model/Type reference : iRay DW40
List Model(s)..... : iRay DW10, Vimo Q, Vimo Me, BooMax, VM40, EJoy Uni Pro, EJoy D10 Pro, Revo S Pro, WM400
Trade Mark..... : 7RYMS /COMICA
FCC ID..... : **2AZSQ-IRAY-DW40**

Applicant's name : **Shenzhen Commlite Technology Co.,LTD.**
Address of applicant : 16th Floor, Ronghu Plaza Innovation Center, Pinghu Street, Long'gang District, Shenzhen, Guangdong Province, China

Test Firm..... : **Shenzhen CTL Testing Technology Co., Ltd.**
Address of Test Firm : Zone A, 1st Floor, Warehouse 2, Baisha Logistics Company, No. 3011 Shahe West Road, Nanshan District, Shenzhen

Test specification..... :
Standard : **FCC Part 15.247:** Operation within the bands 902-928 MHz, 2400-2483.5 MHz and 5725-5850 MHz.
TRF Originator : Shenzhen CTL Testing Technology Co., Ltd.
Master TRF..... : Dated 2011-01

Date of receipt of test item : May. 22, 2024
Date of Test Date..... : May. 22, 2024-June. 27, 2024
Date of Issue : June. 28, 2024

Result..... : **Pass**

Shenzhen CTL Testing Technology Co., Ltd. All rights reserved.

This publication may be reproduced in whole or in part for non-commercial purposes as long as the Shenzhen CTL Testing Technology Co., Ltd. is acknowledged as copyright owner and source of the material. Shenzhen CTL Testing Technology Co., Ltd. takes no responsibility for and will not assume liability for damages resulting from the reader's interpretation of the reproduced material due to its placement and context.

TEST REPORT

Test Report No. : CTL2405161091-WF	June. 28, 2024
	Date of issue

Equipment under Test : 2.4G Wireless Microphone

Sample No : CTL2405161091

Model /Type : iRay DW40

Listed Models : iRay DW10, Vimo Q, Vimo Me, BooMax, VM40, EJoy Uni Pro, EJoy D10 Pro, Revo S Pro, WM400

Applicant : **Shenzhen Commlite Technology Co.,LTD.**

Address : 16th Floor, Ronghu Plaza Innovation Center, Pinghu Street, Long'gang District, Shenzhen, Guangdong Province, China

Manufacturer : **Shenzhen Commlite Technology Co.,LTD.**

Address : 16th Floor, Ronghu Plaza Innovation Center, Pinghu Street, Long'gang District, Shenzhen, Guangdong Province, China

Test result	Pass *
--------------------	---------------

*In the configuration tested, the EUT complied with the standards specified page 5.

The test results presented in this report relate only to the object tested.

This report shall not be reproduced, except in full, without the written approval of the issuing testing laboratory.

Table of Contents

Page

1. SUMMARY	5
1.1. TEST STANDARDS	5
1.2. TEST DESCRIPTION	5
1.3. TEST FACILITY	6
1.4. STATEMENT OF THE MEASUREMENT UNCERTAINTY	6
1.5. AUXILIARY TEST EQUIPMENT INFORMATION	7
2. GENERAL INFORMATION	8
2.1. ENVIRONMENTAL CONDITIONS	8
2.2. GENERAL DESCRIPTION OF EUT	8
2.3. DESCRIPTION OF TEST MODES AND TEST FREQUENCY	9
2.4. EQUIPMENTS USED DURING THE TEST	10
2.5. RELATED SUBMITTAL(S) / GRANT (S)	10
2.6. MODIFICATIONS	10
3. TEST CONDITIONS AND RESULTS	11
3.1. CONDUCTED EMISSIONS TEST	11
3.2. RADIATED EMISSIONS AND BAND EDGE	14
3.3. MAXIMUM PEAK OUTPUT POWER	20
3.4. 20dB BANDWIDTH	21
3.5. FREQUENCY SEPARATION	22
3.6. NUMBER OF HOPPING FREQUENCY	23
3.7. TIME OF OCCUPANCY (DWELL TIME)	24
3.8. OUT-OF-BAND EMISSIONS	25
3.9. PSEUDORANDOM FREQUENCY HOPPING SEQUENCE	26
3.10. ANTENNA REQUIREMENT	27
4. TEST SETUP PHOTOS OF THE EUT	28
5. PHOTOS OF THE EUT	30

1. SUMMARY

1.1. TEST STANDARDS

The tests were performed according to following standards:

[FCC Rules Part 15.247](#): Frequency Hopping, Direct Spread Spectrum and Hybrid SysteKI that are in operation within the bands of 902-928 MHz, 2400-2483.5 MHz, and 5725-5850 MHz

[ANSI C63.10: 2013](#): American National Standard for Testing Unlicensed Wireless Devices

1.2. Test Description

FCC PART 15.247		
FCC Part 15.207	AC Power Conducted Emission	PASS
FCC Part 15.247(a)(1)(i)	20dB Bandwidth	PASS
FCC Part 15.247(d)	Spurious RF Conducted Emission	PASS
FCC Part 15.247(b)	Maximum Peak Output Power	PASS
FCC Part 15.247(b)	Pseudorandom Frequency Hopping Sequence	PASS
FCC Part 15.247(a)(1)(iii)	Number of hopping frequency& Time of Occupancy	PASS
FCC Part 15.247(a)(1)	Frequency Separation	PASS
FCC Part 15.205/15.209	Radiated Emissions	PASS
FCC Part 15.247(d)	Band Edge Compliance of RF Emission	PASS
FCC Part 15.203/15.247 (b)	Antenna Requirement	PASS

1.3. Test Facility

1.3.1 Address of the test laboratory

Shenzhen CTL Testing Technology Co., Ltd.

Zone A, 1st Floor, Warehouse 2, Baisha Logistics Company, No. 3011 Shahe West Road, Nanshan District, Shenzhen

There is one 3m semi-anechoic chamber and two line conducted labs for final test. The Test Sites meet the requirements in documents ANSI C63.10 and CISPR 32/EN 55032 requirements.

1.3.2 Laboratory accreditation

The test facility is recognized, certified, or accredited by the following organizations:

CNAS-Lab Code: L7497

Shenzhen CTL Testing Technology Co., Ltd. has been assessed and proved to be in compliance with CNAS-CL01 Accreditation Criteria for Testing and Calibration Laboratories (identical to ISO/IEC 17025: 2017 General Requirements) for the Competence of Testing and Calibration Laboratories.

A2LA-Lab Cert. No. 4343.01

Shenzhen CTL Testing Technology Co., Ltd, EMC Laboratory has been accredited by A2LA for technical competence in the field of electrical testing, and proved to be in compliance with ISO/IEC 17025: 2017 General Requirements for the Competence of Testing and Calibration Laboratories and any additional program requirements in the identified field of testing.

IC Registration No.: 9618B

CAB identifier: CN0041

The 3m alternate test site of Shenzhen CTL Testing Technology Co., Ltd. EMC Laboratory has been registered by Innovation, Science and Economic Development Canada to test to Canadian radio equipment requirements with Registration No.: 9618B.

FCC-Registration No.: 399832

Designation No.: CN1216

Shenzhen CTL Testing Technology Co., Ltd. EMC Laboratory has been registered and fully described in a report filed with the (FCC) Federal Communications Commission. The acceptance letter from the FCC is maintained in our files. Registration 399832.

1.4. Statement of the measurement uncertainty

The data and results referenced in this document are true and accurate. The reader is cautioned that there may be errors within the calibration limits of the equipment and facilities. The measurement uncertainty was calculated for all measurements listed in this test report acc. to CISPR 16 - 4 "Specification for radio disturbance and immunity measuring apparatus and methods – Part 4: Uncertainty in EMC Measurements" and is documented in the Shenzhen CTL Testing Technology Co., Ltd. quality system acc. to DIN EN ISO/IEC 17025. Furthermore, component and process variability of devices similar to that tested may result in additional deviation. The manufacturer has the sole responsibility of continued compliance of the device.

Hereafter the best measurement capability for CTL laboratory is reported:

Test	Measurement Uncertainty	Notes
Transmitter power conducted	±0.57 dB	(1)
Transmitter power Radiated	±2.20 dB	(1)
Conducted spurious emission 9KHz-40 GHz	±1.60 dB	(1)
Occupied Bandwidth	±0.20ppm	(1)
Radiated Emission 9KHz~30MHz	±3.40dB	(1)

Radiated Emission 30~1000MHz	$\pm 4.10\text{dB}$	(1)
Radiated Emission Above 1GHz	$\pm 4.32\text{dB}$	(1)
Conducted Disturbance 0.15~30MHz	$\pm 3.20\text{dB}$	(1)

- (1) This uncertainty represents an expanded uncertainty expressed at approximately the 95%
(2) confidence level using a coverage factor of $k=2$.

1.5. Auxiliary test equipment information

Manufacturer	Description	Model	Serial Number
HUAWEI TECHNOLOGIES CO.LTD	Adapter	HW-100225C00	---

2. GENERAL INFORMATION

2.1. Environmental conditions

During the measurement the environmental conditions were within the listed ranges:

Normal Temperature:	25°C
Relative Humidity:	55 %
Air Pressure:	101 kPa

2.2. General Description of EUT

Product Name:	2.4G Wireless Microphone
Model/Type reference:	iRay DW40
Power supply:	DC 3.8V from battery 95mAh
Bluetooth:	
Version:	Supported BR/EDR
Modulation:	GFSK, Pi/4DQPSK, 8DPSK
Operation frequency:	2402MHz~2480MHz
Channel number:	79
Channel separation:	1MHz
Antenna type:	Internal Antenna
Antenna gain:	2.00dBi

Note 1: For more details, please refer to the user's manual of the EUT.

Note 2: Antenna gain provided by the applicant.

2.3. Description of Test Modes and Test Frequency

The Applicant provides communication tools software to control the EUT for staying in continuous transmitting (Duty Cycle more than 98%) and receiving mode for testing .There are 79 channels provided to the EUT and Channel 00/39/78 were selected to test.

Operation Frequency :

Channel	Frequency (MHz)
00	2402
01	2403
⋮	⋮
38	2440
39	2441
40	2442
⋮	⋮
77	2479
78	2480

Preliminary tests were performed in each mode and packet length of BT, and found worst case as bellow, finally test were conducted at those mode and recorded in this report.

Test IteKI	Worst case
Conducted Emissions	DH5 Middle channel
Radiated Emissions and Band Edge	DH5
Maximum Conducted Output Power	DH5/2DH5/3DH5
20dB Bandwidth	DH5/2DH5/3DH5
Frequency Separation	DH5/2DH5/3DH5 Middle channel
Number of hopping frequency	DH5/2DH5/3DH5
Time of Occupancy (Dwell Time)	DH1/DH3/DH5 Middle channel 2DH1/2DH3/2DH5 Middle channel 3DH1/3DH3/3DH5 Middle channel
Out-of-band Emissions	DH5/2DH5/3DH5

2.4. Equipments Used during the Test

Test Equipment	Manufacturer	Model No.	Serial No.	Calibration Date	Calibration Due Date
LISN	R&S	ESH2-Z5	860014/010	2024/04/30	2025/04/29
Double cone logarithmic antenna	Schwarzbeck	VULB 9168	824	2023/02/13	2026/02/12
EMI Test Receiver	R&S	ESCI	1166.5950.03	2024/04/30	2025/04/29
Spectrum Analyzer	Agilent	N9020A	US46220290	2024/05/02	2025/05/01
Spectrum Analyzer	Keysight	N9020A	MY53420874	2024/05/02	2025/05/01
Horn Antenna	Sunol Sciences Corp.	DRH-118	A062013	2021/12/23	2024/12/22
Active Loop Antenna	Da Ze	ZN30900A	/	2024/04/30	2025/04/29
Amplifier	Agilent	8449B	3008A02306	2024/04/30	2025/04/29
Amplifier	Brief&Smart	LNA-4018	2104197	2024/05/03	2025/05/02
Temperature/Humidity Meter	Ji Yu	MC501	/	2024/05/04	2025/05/03
Power measurement module	TSTPASS	TSPS2023R	TSCB220016	2024/05/03	2025/05/02
Power Sensor	Agilent	U2021XA	MY53340004	2024/05/04	2025/05/03
Power Sensor	Agilent	U2021XA	MY54080012	2024/05/03	2025/05/02
Spectrum Analyzer	RS	FSP	1164.4391.38	2024/05/03	2025/05/02
Test Software					
Name of Software			Version		
TST-PASS			V2.0		
EZ_EMG(Below 1GHz)			V1.1.4.2		
EZ_EMG((Above 1GHz)			V1.1.4.2		

2.5. Related Submittal(s) / Grant (s)

This submittal(s) (test report) is intended to comply with Section 15.247 of the FCC Part 15, Subpart C Rules.

2.6. Modifications

No modifications were implemented to meet testing criteria.

3. TEST CONDITIONS AND RESULTS

3.1. Conducted Emissions Test

LIMIT

FCC CFR Title 47 Part 15 Subpart C Section 15.207

Frequency range (MHz)	Limit (dBuV)	
	Quasi-peak	Average
0.15-0.5	66 to 56*	56 to 46*
0.5-5	56	46
5-30	60	50

* Decreases with the logarithm of the frequency.

TEST CONFIGURATION

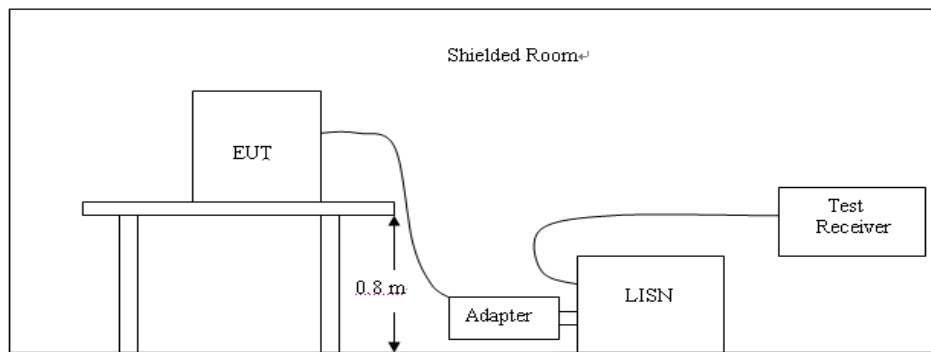

TEST PROCEDURE

1. The equipment was set up as per the test configuration to simulate typical actual usage per the user's manual. The EUT is a Speaker ; a wooden table with a height of 0.8 meters is used and is placed on the ground plane as per ANSI C63.10:2013.
2. Support equipment, if needed, was placed as per ANSI C63.10:2013.
3. All I/O cables were positioned to simulate typical actual usage as per ANSI C63.10:2013.
4. The adapter received AC120V/60Hz power through a Line Impedance Stabilization Network (LISN) which supplied power source and was grounded to the ground plane.
5. All support equipments received AC power from a second LISN, if any.
6. The EUT test program was started. Emissions were measured on each current carrying line of the EUT using a spectrum Analyzer / Receiver connected to the LISN powering the EUT. The LISN has two monitoring points: Line 1 (Hot Side) and Line 2 (Neutral Side). Two scans were taken: one with Line 1 connected to Analyzer / Receiver and Line 2 connected to a 50 ohm load; the second scan had Line 1 connected to a 50 ohm load and Line 2 connected to the Analyzer / Receiver.
7. Analyzer / Receiver scanned from 150 KHz to 30MHz for emissions in each of the test modes.
8. During the above scans, the emissions were maximized by cable manipulation.

TEST RESULTS

Remark: All modes of GFSK, Pi/4 DQPSK, and 8DPSK were test at Low, Middle, and High channel; only the worst result of GFSK Middle Channel was reported as below:

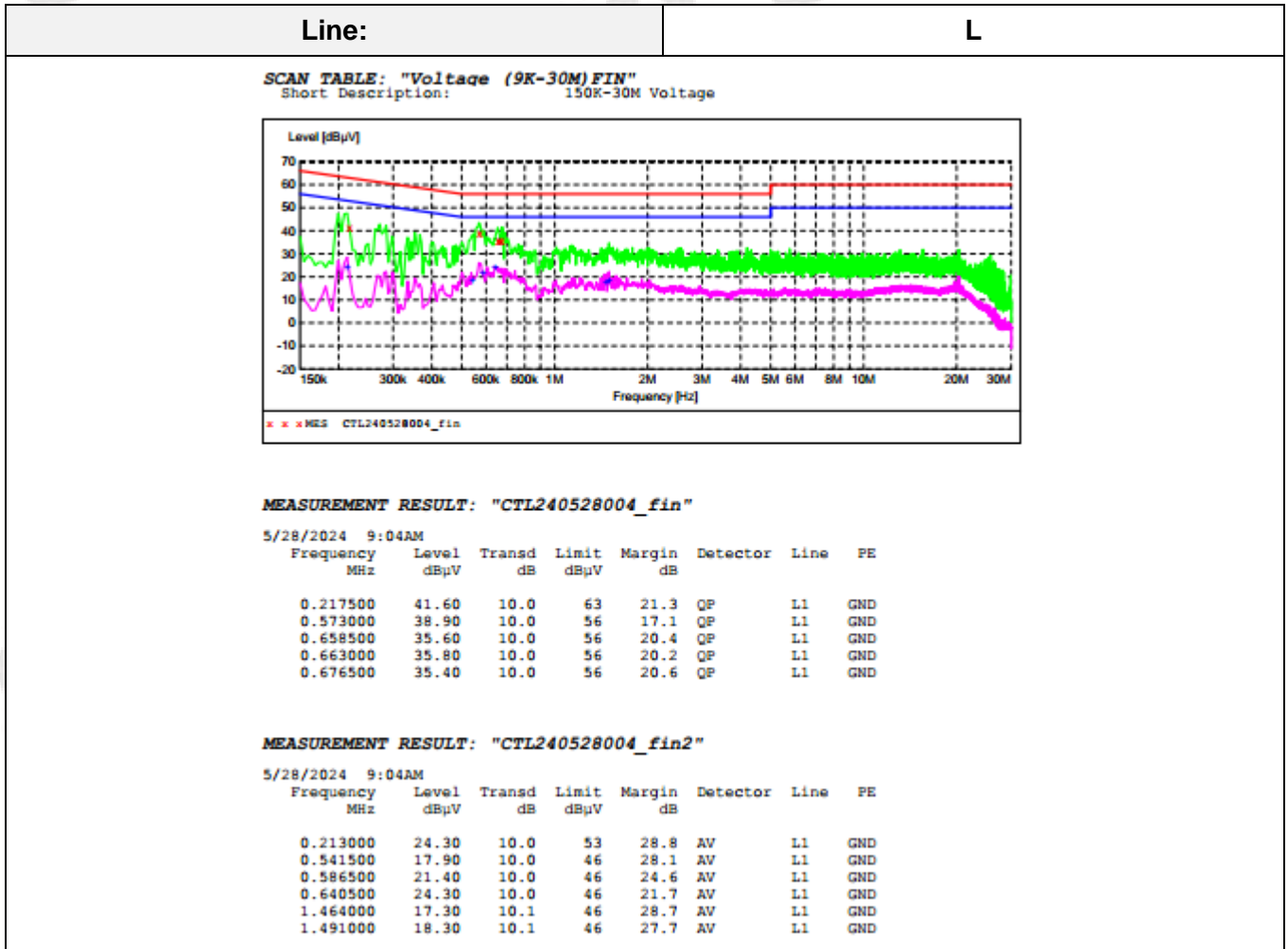

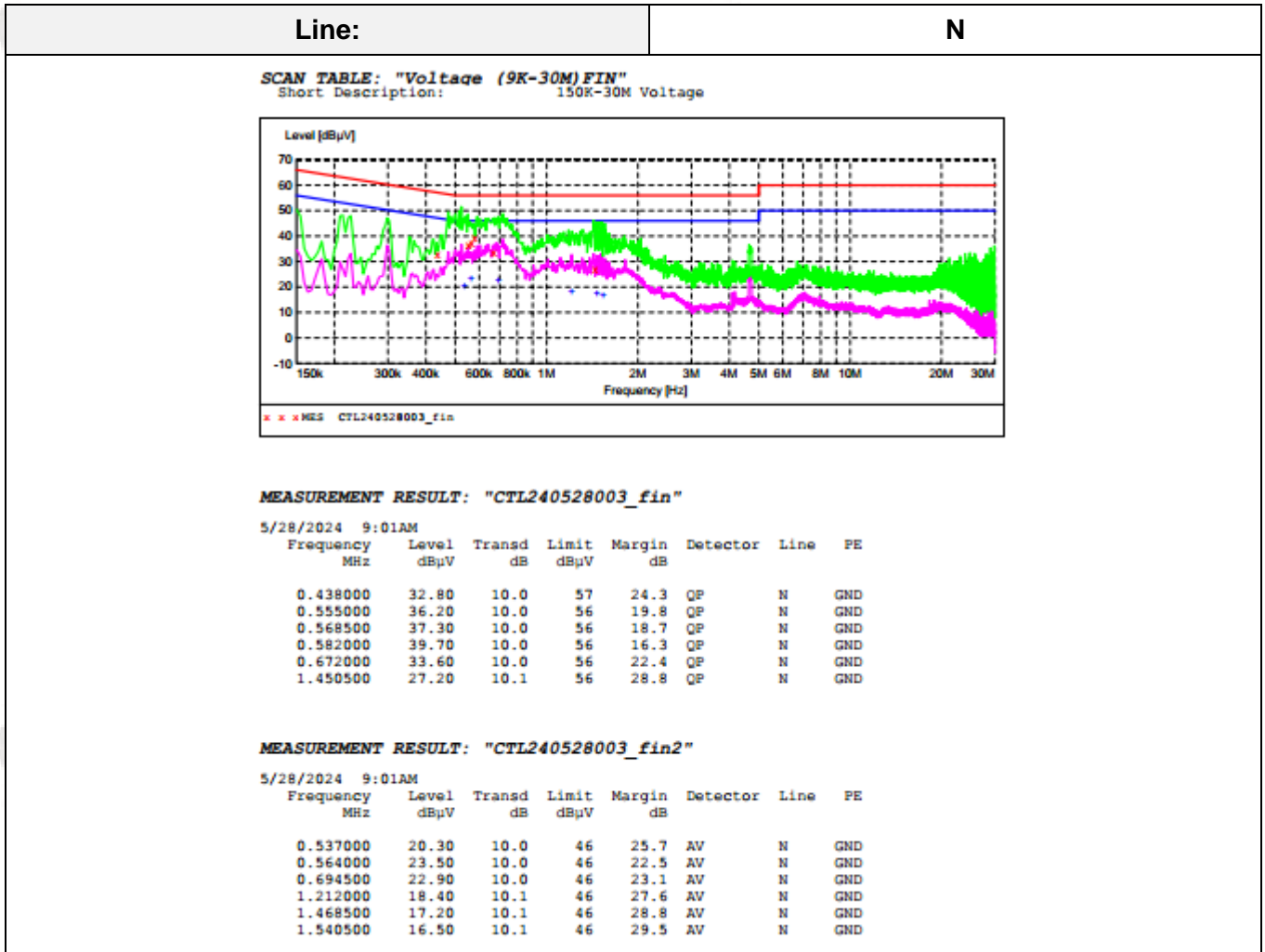

3.2. Radiated Emissions and Band Edge

Limit

For intentional device, according to § 15.209(a), the general requirement of field strength of radiated emission out of authorized band shall not exceed the following table at a 3 meters measurement distance.

In addition, radiated emissions which fall in the restricted bands, as defined in §15.205(a), must also comply with the radiated emission limits specified in §15.209(a)

Radiated emission limits

Frequency (MHz)	Distance (Meters)	Radiated (dB μ V/m)	Radiated (μ V/m)
0.009-0.49	3	$20\log(2400/F(\text{KHz}))+40\log(300/3)$	$2400/F(\text{KHz})$
0.49-1.705	3	$20\log(24000/F(\text{KHz}))+40\log(30/3)$	$24000/F(\text{KHz})$
1.705-30	3	$20\log(30)+40\log(30/3)$	30
30-88	3	40.0	100
88-216	3	43.5	150
216-960	3	46.0	200
Above 960	3	54.0	500

TEST CONFIGURATION

(A) Radiated Emission Test Set-Up, Frequency Below 30MHz

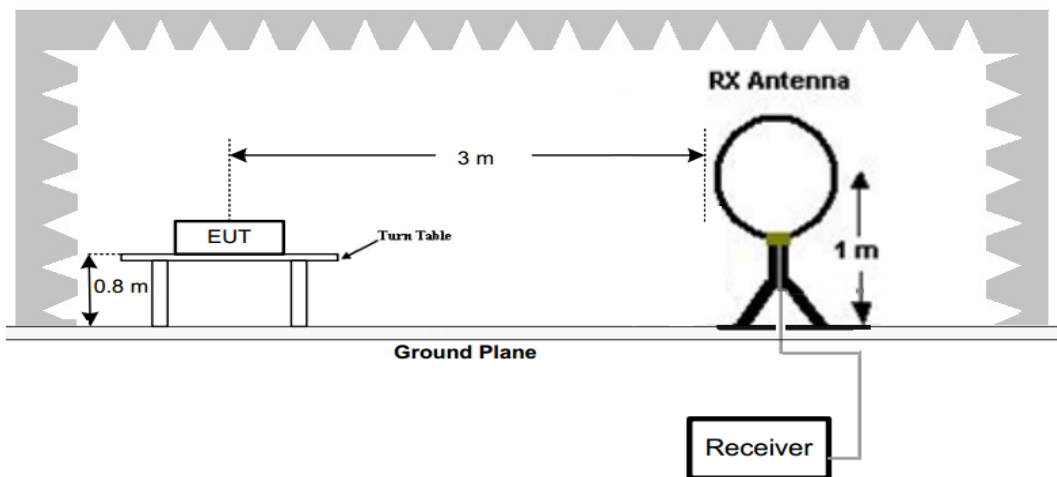

(B) Radiated Emission Test Set-Up, Frequency below 1000MHz

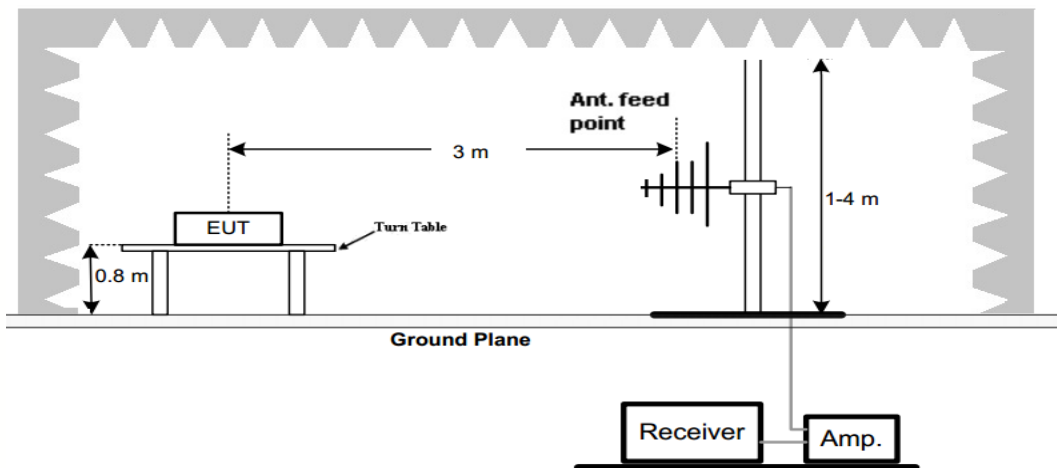

(C) Radiated Emission Test Set-Up, Frequency above 1000MHz

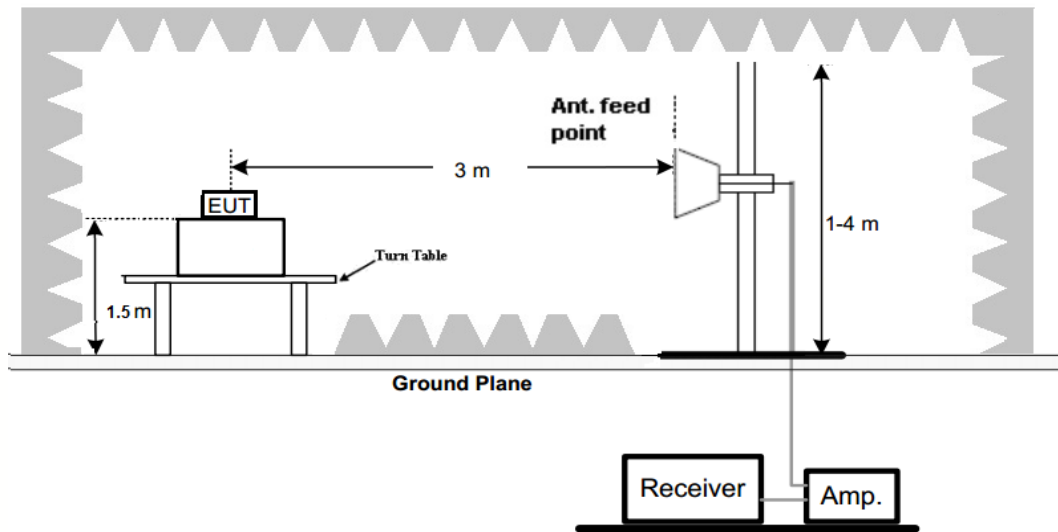

Test Procedure

1. Below 1GHz measurement the EUT is placed on a turntable which is 0.8m above ground plane, and above 1GHz measurement EUT was placed on a low permittivity and low loss tangent turn table which is 1.5m above ground plane.
2. Maximum procedure was performed by raising the receiving antenna from 1m to 4m and rotating the turn table from 0° to 360° to acquire the highest emissions from EUT
3. And also, each emission was to be maximized by changing the polarization of receiving antenna both horizontal and vertical.
4. Repeat above procedures until all frequency measurements have been completed.
5. The EUT was pretested with 3 orientations placed on the table for the radiated emission measurement –X, Y, and Z-plane. The X-plane results were found as the worst case and were shown in this report.

TEST RESULTS

Remark:

1. We measured Radiated Emission at GFSK, $\pi/4$ DQPSK and 8DPSK mode from 9 KHz to 25GHz and recorded worst case at GFSK DH5 mode..
2. For below 1GHz testing recorded worst at GFSK DH5 low channel.
3. Radiated emission test from 9 KHz to 10th harmonic of fundamental was verified, Found the emission level are attenuated 20dB below the limits from 9 kHz to 30MHz, so it does not recorded in report.

For 30MHz-1GHz

Horizontal



Shenzhen CTL Testing Technology Co., Ltd
Tel: +86-755-89486194

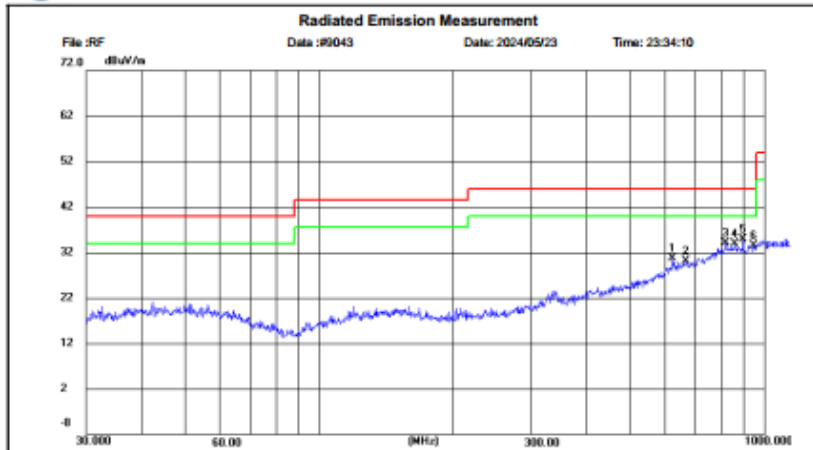

File: RF Data: #9043 Date: 2024/05/23 Time: 23:34:10
 Site: LAB Chamber 2 Polarization: **Horizontal** Temperature: 25(C)
 Limit: FCC Part15 RE-Class C_30-1000MHz Power: Humidity: 50 %
 EUT: / Distance: 3m
 M/N: iRay DW40
 Mode: BT 2402MHz
 Note: Shenzhen Commite Technology Co.,LTD.

No.	Frequency (MHz)	Reading (dBuV)	Factor (dB/m)	Level (dBuV/m)	Limit (dBuV/m)	Margin (dB)	Detector	Height (cm)	Azimuth (deg.)	P/F	Remark
1	624.2566	8.45	22.29	30.74	46.00	15.26	peak	100	0	P	
2	668.4351	7.59	22.60	30.19	46.00	15.81	peak	100	74	P	
3	820.2708	8.06	25.97	34.03	46.00	11.97	peak	100	294	P	
4	859.2815	7.51	26.35	33.86	46.00	12.14	peak	100	317	P	
5	898.5705	8.33	26.56	34.89	46.00	11.11	peak	100	170	P	
6	951.2594	6.38	27.11	33.49	46.00	12.51	peak	100	325	P	

Vertical



Shenzhen CTL Testing Technology Co., Ltd
Tel: +86-755-89486194

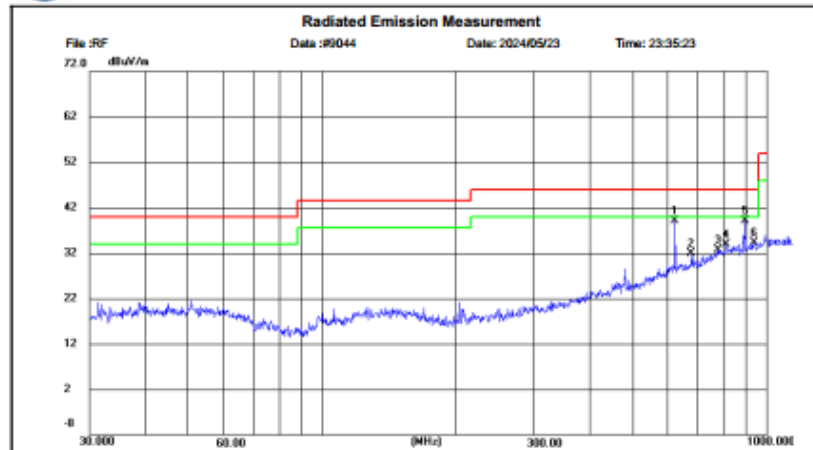

File: RF Data: #9044 Date: 2024/05/23 Time: 23:35:23
 Site: LAB Chamber 2 Polarization: **Vertical** Temperature: 25(C)
 Limit: FCC Part15 RE-Class C_30-1000MHz Power: Humidity: 50 %
 EUT: / Distance: 3m
 M/N: iRay DW40
 Mode: BT 2402MHz
 Note: Shenzhen Commite Technology Co.,LTD.

No.	Frequency (MHz)	Reading (dBuV)	Factor (dB/m)	Level (dBuV/m)	Limit (dBuV/m)	Margin (dB)	Detector	Height (cm)	Azimuth (deg.)	P/F	Remark
1	624.2566	16.87	22.29	39.16	46.00	6.84	peak	100	27	P	
2	677.5798	9.23	22.67	31.90	46.00	14.10	peak	100	149	P	
3	778.9235	7.59	25.18	32.77	46.00	13.23	peak	100	51	P	
4	811.3315	8.07	25.89	33.96	46.00	12.04	peak	100	137	P	
5	896.6034	12.71	26.47	39.18	46.00	6.82	peak	100	283	P	
6	941.7176	7.11	27.10	34.21	46.00	11.79	peak	100	63	P	

For 1GHz to 25GHz

Note : GFSK, Pi/4 DQPSK and 8DPSK all have been tested, only worse case GFSK is reported.

GFSK (above 1GHz)

Frequency(MHz):			2402		Polarity:			HORIZONTAL	
Frequency (MHz)	Emission Level (dBuV/m)		Limit (dBuV/m)	Margin (dB)	Raw Value (dBuV)	Antenna Factor (dB/m)	Cable Factor (dB)	Pre-amplifier (dB)	Correction Factor (dB/m)
4804.00	47.41	PK	74.00	26.59	42.9	33.49	6.91	35.89	4.51
4804.00	--	AV	54.00	--	--	--	--	--	--
5250.00	47.62	PK	74.00	26.38	40.76	34.06	7.04	34.24	6.86
5250.00	--	AV	54.00	--	--	--	--	--	--
7206.00	47.95	PK	74.00	26.05	36.85	36.95	9.18	35.03	11.10
7206.00	--	AV	54.00	--	--	--	--	--	--

Frequency(MHz):			2402		Polarity:			VERTICAL	
Frequency (MHz)	Emission Level (dBuV/m)		Limit (dBuV/m)	Margin (dB)	Raw Value (dBuV)	Antenna Factor (dB/m)	Cable Factor (dB)	Pre-amplifier (dB)	Correction Factor (dB/m)
4804.00	48.85	PK	74.00	25.15	44.34	33.49	6.91	35.89	4.51
4804.00	--	AV	54.00	--	--	--	--	--	--
5374.00	47.97	PK	74.00	26.03	41.11	34.06	7.04	34.24	6.86
5374.00	--	AV	54.00	--	--	--	--	--	--
7206.00	48.18	PK	74.00	25.82	37.08	36.95	9.18	35.03	11.10
7206.00	--	AV	54.00	--	--	--	--	--	--

Frequency(MHz):			2441		Polarity:			HORIZONTAL	
Frequency (MHz)	Emission Level (dBuV/m)		Limit (dBuV/m)	Margin (dB)	Raw Value (dBuV)	Antenna Factor (dB/m)	Cable Factor (dB)	Pre-amplifier (dB)	Correction Factor (dB/m)
4882.00	46.81	PK	74.00	27.19	40.45	33.60	6.95	34.19	6.36
4882.00	--	AV	54.00	--	--	--	--	--	--
5427.00	47.23	PK	74.00	26.77	39.63	34.56	7.15	34.11	7.60
5427.00	--	AV	54.00	--	--	--	--	--	--
7323.00	48.51	PK	74.00	25.49	36.81	37.46	9.23	35.00	11.70
7323.00	--	AV	54.00	--	--	--	--	--	--

Frequency(MHz):			2441		Polarity:			VERTICAL	
Frequency (MHz)	Emission Level (dBuV/m)		Limit (dBuV/m)	Margin (dB)	Raw Value (dBuV)	Antenna Factor (dB/m)	Cable Factor (dB)	Pre-amplifier (dB)	Correction Factor (dB/m)
4882.00	47.32	PK	74.00	26.68	40.96	33.60	6.95	34.19	6.36
4882.00	--	AV	54.00	--	--	--	--	--	--
5382.00	48.26	PK	74.00	25.74	40.66	34.56	7.15	34.11	7.60
5382.00	--	AV	54.00	--	--	--	--	--	--
7323.00	48.85	PK	74.00	25.15	37.15	37.46	9.23	35.00	11.70
7323.00	--	AV	54.00	--	--	--	--	--	--

Frequency(MHz):			2480		Polarity:			HORIZONTAL	
Frequency (MHz)	Emission Level (dBuV/m)		Limit (dBuV/m)	Margin (dB)	Raw Value (dBuV)	Antenna Factor (dB/m)	Cable Factor (dB)	Pre-amplifier (dB)	Correction Factor (dB/m)
4960.00	48.21	PK	74.00	25.79	43.29	33.84	7.00	35.92	4.92
4960.00	--	AV	54.00	--	--	--	--	--	--
5531.00	47.95	PK	74.00	26.05	40.67	34.45	7.12	34.29	7.28
5531.00	--	AV	54.00	--	--	--	--	--	--
7440.00	48.15	PK	74.00	25.85	36.20	37.64	9.28	34.97	11.95
7440.00	--	AV	54.00	--	--	--	--	--	--

Frequency(MHz):			2480		Polarity:			VERTICAL	
Frequency (MHz)	Emission Level (dBuV/m)		Limit (dBuV/m)	Margin (dB)	Raw Value (dBuV)	Antenna Factor (dB/m)	Cable Factor (dB)	Pre-amplifier (dB)	Correction Factor (dB/m)
4960.00	47.59	PK	74.00	26.41	42.67	33.84	7.00	35.92	4.92
4960.00	--	AV	54.00	--	--	--	--	--	--
5614.00	48.51	PK	74.00	25.49	41.23	34.45	7.12	34.29	7.28
5614.00	--	AV	54.00	--	--	--	--	--	--
7440.00	48.48	PK	74.00	25.52	36.53	37.64	9.28	34.97	11.95
7440.00	--	AV	54.00	--	--	--	--	--	--

REMARKS:

1. Emission level (dBuV/m) =Raw Value (dBuV)+Correction Factor (dB/m)
2. Correction Factor (dB/m) = Antenna Factor (dB/m)+Cable Factor (dB)-Pre-amplifier Factor
3. Margin value = Limit value- Emission level.
4. -- Mean the PK detector measured value is below average limit.
5. RBW1MHz VBW3MHz Peak detector is for PK value; RBW 1MHz VBW10Hz Peak detector is for AV value.
6. Other emissions are attenuated 20dB below the limits from 9kHz to 30MHz, so it does not recorded in report.
7. 18GHz-26GHz not recorded for no spurious point have a margin of less than 6 dB with respect to the limits.

Results of Band Edge

Note : All modulations have been tested, only worse case GFSK is reported.

Frequency(MHz):			2402		Polarity:			HORIZONTAL	
Frequency (MHz)	Emission Level (dBuV/m)		Limit (dBuV/m)	Margin (dB)	Raw Value (dBuV)	Antenna Factor (dB/m)	Cable Factor (dB)	Pre-amplifier (dB)	Correction Factor (dB/m)
2402.00	97.21	PK	--	--	63.82	28.78	4.61	0.00	33.39
2402.00	89.54	AV	--	--	56.15	28.78	4.61	0.00	33.39
2371.00	47.49	PK	74.00	26.51	14.41	28.52	4.56	0.00	33.08
2371.00	--	AV	54.00	--	--	--	--	--	--
2390.00	48.78	PK	74.00	25.22	15.46	28.72	4.60	0.00	33.32
2390.00	--	AV	54.00	--	--	--	--	--	--
2400.00	51.56	PK	--	--	18.17	28.78	4.61	0.00	33.39
2400.00	--	AV	--	--	--	--	--	--	--

Frequency(MHz):			2402		Polarity:			VERTICAL	
Frequency (MHz)	Emission Level (dBuV/m)		Limit (dBuV/m)	Margin (dB)	Raw Value (dBuV)	Antenna Factor (dB/m)	Cable Factor (dB)	Pre-amplifier (dB)	Correction Factor (dB/m)
2402.00	96.25	PK	--	--	62.86	28.78	4.61	0.00	33.39
2402.00	87.49	AV	--	--	54.1	28.78	4.61	0.00	33.39
2379.00	47.32	PK	74.00	26.68	14.24	28.52	4.56	0.00	33.08
2379.00	--	AV	54.00	--	--	--	--	--	--
2390.00	49.74	PK	74.00	24.26	16.42	28.72	4.60	0.00	33.32
2390.00	--	AV	54.00	--	--	--	--	--	--
2400.00	50.84	PK	--	--	17.45	28.78	4.61	0.00	33.39
2400.00	--	AV	--	--	--	--	--	--	--

Frequency(MHz):			2480		Polarity:			HORIZONTAL	
Frequency (MHz)	Emission Level (dBuV/m)		Limit (dBuV/m)	Margin (dB)	Raw Value (dBuV)	Antenna Factor (dB/m)	Cable Factor (dB)	Pre-amplifier (dB)	Correction Factor (dB/m)
2480.00	96.95	PK	--	--	63.33	28.92	4.70	0.00	33.62
2480.00	88.28	AV	--	--	54.66	28.92	4.70	0.00	33.62
2483.50	52.41	PK	74.00	21.59	18.78	28.93	4.70	0.00	33.63
2483.50	--	AV	54.00	--	--	--	--	--	--
2486.00	49.75	PK	74.00	24.25	16.09	28.95	4.71	0.00	33.66
2486.00	--	AV	54.00	--	--	--	--	--	--
2500.00	47.95	PK	74.00	26.05	14.27	28.96	4.72	0.00	33.68
2500.00	--	AV	54.00	--	--	--	--	--	--

Frequency(MHz):			2480		Polarity:			VERTICAL	
Frequency (MHz)	Emission Level (dBuV/m)		Limit (dBuV/m)	Margin (dB)	Raw Value (dBuV)	Antenna Factor (dB/m)	Cable Factor (dB)	Pre-amplifier (dB)	Correction Factor (dB/m)
2480.00	97.76	PK	--	--	64.14	28.92	4.70	0.00	33.62
2480.00	90.21	AV	--	--	56.59	28.92	4.70	0.00	33.62
2483.50	51.74	PK	74.00	22.26	18.11	28.93	4.70	0.00	33.63
2483.50	--	AV	54.00	--	--	--	--	--	--
2494.00	48.49	PK	74.00	25.51	14.83	28.95	4.71	0.00	33.66
2494.00	--	AV	54.00	--	--	--	--	--	--
2500.00	49.93	PK	74.00	24.07	16.25	28.96	4.72	0.00	33.68
2500.00	--	AV	54.00	--	--	--	--	--	--

REMARKS:

1. Emission level (dBuV/m) =Raw Value (dBuV)+Correction Factor (dB/m)
2. Correction Factor (dB/m) = Antenna Factor (dB/m)+Cable Factor (dB)-Pre-amplifier Factor
3. Margin value = Limit value- Emission level.
4. -- Mean the PK detector measured value is below average limit.
5. RBW 1MHz VBW 3MHz Peak detector is for PK value; RBW 1MHz VBW 10Hz Peak detector is for AV value.
6. For fundamental frequency, RBW 3MHz VBW 3MHz Peak detector is for PK Value; RKI detector is for AV value.
7. Other emissions are attenuated 20dB below the limits from 9kHz to 30MHz, so it does not recorded in report.

3.3. Maximum Peak Output Power

Limit

For frequency hopping systems operating in the 2400-2483.5 MHz band employing at least 75 non-overlapping hopping channels: 1 watt.

For all other frequency hopping systems in the 2400-2483.5 MHz band: 0.125 watts.

Test Procedure

Remove the antenna from the EUT and then connect a low loss RF cable from the antenna port to the spectrum.

Test Configuration

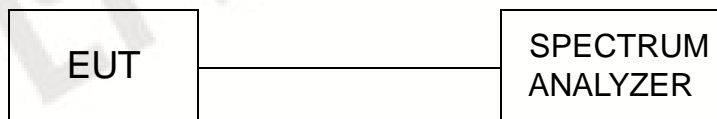

Test Results

Raw data reference to Section 2 from CTL2405161091-WF_Bluetooth_Appendix.

3.4. 20dB Bandwidth

Limit

For frequency hopping systems operating in the 2400MHz-2483.5MHz no limit for 20dB bandwidth.

Test Procedure

The transmitter output was connected to the spectrum analyzer through an attenuator. The bandwidth of the fundamental frequency was measured by spectrum analyzer with 30 KHz RBW and 100 KHz VBW.

The 20dB bandwidth is defined as the total spectrum the power of which is higher than peak power minus 20dB.

The bandwidth occupied is the frequency bandwidth such that the average power below its low frequency limit and above its high frequency limit are each equal to 0.5% of the total average power for a given transmit. The following steps should be used to measure 99% of the power bandwidth :

RBW= 1% to 5% of the OBW

VBW= approximately $3 \times$ RBW

Detector = Peak

Trace mode: Maximum hold

Using the instrument's 99% power bandwidth function to measure the occupied bandwidth and re-code.

Test Configuration

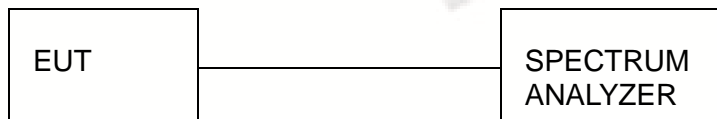

Test Results

Raw data reference to Section 1 from CTL2405161091-WF_Bluetooth_Appendix

3.5. Frequency Separation

LIMIT

According to 15.247(a)(1), frequency hopping systems shall have hopping channel carrier frequencies separated by minimum of 25KHz or the $2/3 \times 20\text{dB}$ bandwidth of the hopping channel, whichever is greater.

TEST PROCEDURE

The transmitter output was connected to the spectrum analyzer through an attenuator. The bandwidth of the fundamental frequency was measured by spectrum analyzer with 300 KHz RBW and 300 KHz VBW.

TEST CONFIGURATION

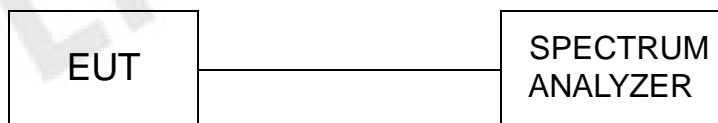

TEST RESULTS

Raw data reference to Section 3 from CTL2405161091-WF_Bluetooth_Appendix.

3.6. Number of hopping frequency

Limit

Frequency hopping systems in the 2400–2483.5 MHz band shall use at least 15 channels.

Test Procedure

The EUT shall have its hopping function enabled. Use the following spectrum analyzer settings:

- a) Span: The frequency band of operation. Depending on the number of channels the device supports , it could be necessary to divide the frequency range of operation across multiple spans, to allow the individual channels to be clearly seen.
- b) RBW: To identify clearly the individual channels, set the RBW to less than 30% of the channel spacing or the 20 dB bandwidth, whichever is smaller.
- c) VBW \geq RBW.
- d) Sweep: No faster than coupled (auto) time.
- e) Detector function: Peak.
- f) Trace: Max-hold.
- g) Allow the trace to stabilize.

Test Configuration



Test Results

Raw data reference to Section 4 from CTL2405161091-WF_Bluetooth_Appendix.

3.7. Time of Occupancy (Dwell Time)

Limit

The average time of occupancy on any channel shall not be greater than 400 milliseconds within a period of 400 milliseconds multiplied by the number of hopping channels employed.

Test Procedure

The transmitter output was connected to the spectrum analyzer through an attenuator. Set center frequency of spectrum analyzer=operating frequency with 1MHz RBW and 1MHz VBW, Span 0Hz.

Test Configuration

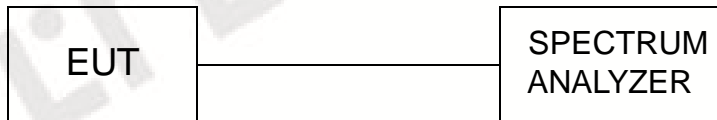

Test Results

Raw data reference to Section 5 from CTL2405161091-WF_Bluetooth_Appendix.

3.8. Out-of-band Emissions

Limit

In any 100 kHz bandwidth outside the frequency band in which the spread spectrum or digitally modulated intentional radiator is operating, the radio frequency power that is produced by the intentional radiator shall be at least 20 dB below that in the 100 kHz bandwidth within the band that contains the highest level of the desired power, based on either an RF conducted or a radiated measurement, provided the transmitter demonstrates compliance with the peak conducted power limits. If the transmitter complies with the conducted power limits based on the use of RFI averaging over a time interval, as permitted under paragraph (b)(3) of this section, the attenuation required under this paragraph shall be 30 dB instead of 20 dB. Attenuation below the general limits specified in §15.209(a) is not required.

Test Procedure

Connect the transmitter output to spectrum analyzer using a low loss RF cable, and set the spectrum analyzer to RBW=100 kHz, VBW= 300 kHz, peak detector, and max hold. Measurements utilizing these settings are made of the in-band reference level, band-edge and out-of-band emissions.

Test Configuration

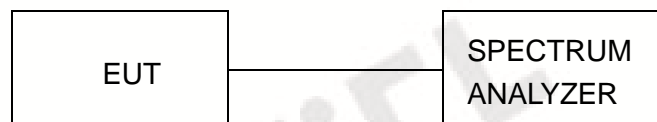

Test Results

Raw data reference to Section 6 from CTL2405161091-WF_Bluetooth_Appendix.

3.9. Pseudorandom Frequency Hopping Sequence

TEST APPLICABLE

For 47 CFR Part 15C section 15.247 (a) (1) requirement:

Frequency hopping systems shall have hopping channel carrier frequencies separated by a minimum of 25 kHz or the 20 dB bandwidth of the hop-ping channel, whichever is greater. Alternatively, frequency hopping systems operating in the 2400–2483.5 MHz band may have hopping channel carrier frequencies that are separated by 25 kHz or two-thirds of the 20 dB bandwidth of the hopping channel, whichever is greater, provided the systems operate with an output power no greater than 125 mW. The system shall hop to channel frequencies that are selected at the system hopping rate from a pseudo randomly ordered list of hopping frequencies. Each frequency must be used equally on the average by each transmitter. The system receivers shall have input bandwidths that match the hop-ping channel bandwidths of their corresponding transmitters and shall shift frequencies in synchronization with the transmitted signals.

EUT Pseudorandom Frequency Hopping Sequence Requirement

The pseudorandom frequency hopping sequence may be generated in a nine-stage shift register whose 5th and 9th stage outputs are added in a modulo-two addition stage. And the result is fed back to the input of the first stage. The sequence begins with the first one of 9 consecutive ones, for example: the shift register is initialized with nine ones.

- Number of shift register stages:9
- Length of pseudo-random sequence:29-1=511 bits
- Longest sequence of zeros:8(non-inverted signal)

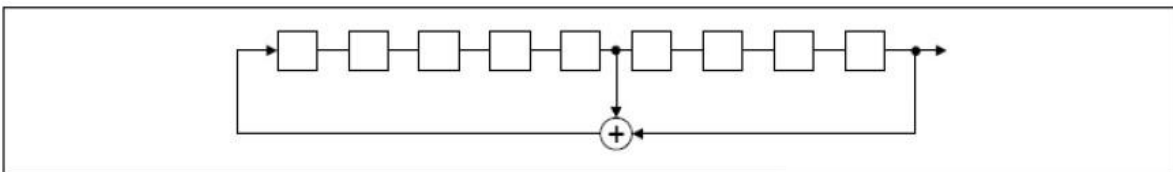

Linear Feedback Shift Register for Generation of the PRBS sequence

An example of pseudorandom frequency hopping sequence as follows:

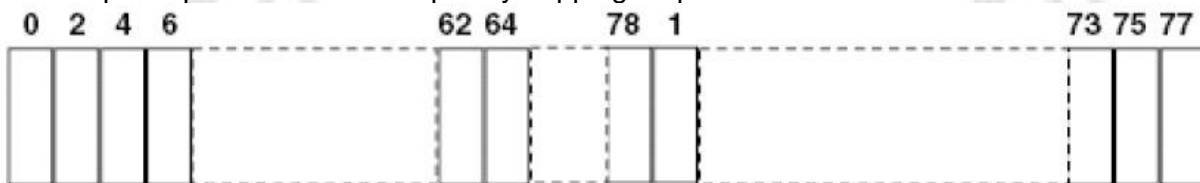

Each frequency used equally one the average by each transmitter.

The system receiver have input bandwidths that match the hopping channel bandwidths of their corresponding transmitter and shift frequencies in synchronization with the transmitted signals.

3.10. Antenna Requirement

Standard Applicable

For intentional device, according to FCC 47 CFR Section 15.203, an intentional radiator shall be designed to ensure that no antenna other than that furnished by the responsible party shall be used with the device.

And according to FCC 47 CFR Section 15.247 (b), if transmitting antennas of directional gain greater than 6dBi are used, the power shall be reduced by the amount in dB that the directional gain of the antenna exceeds 6dBi.

Refer to statement below for compliance

The manufacturer may design the unit so that the user can replace a broken antenna, but the use of a standard antenna jack or electrical connector is prohibited. Further, this requirement does not apply to intentional radiators that must be professionally installed.

Antenna Connected Construction

The maximum gain of antenna was 2.00dBi

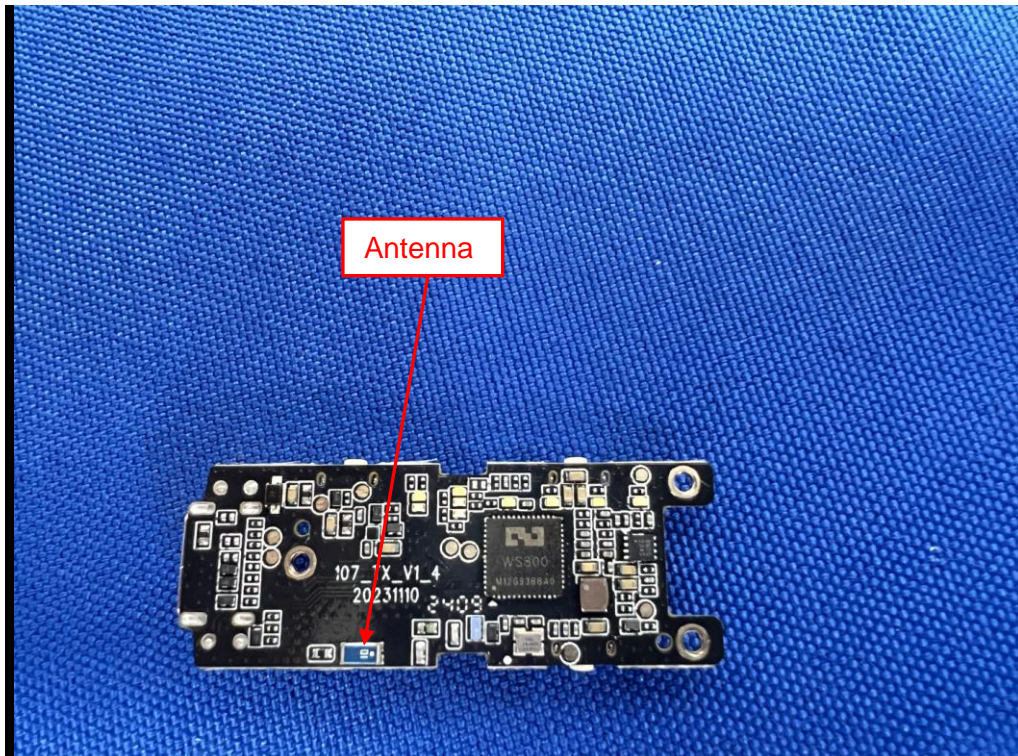

4. Test Setup Photos of the EUT

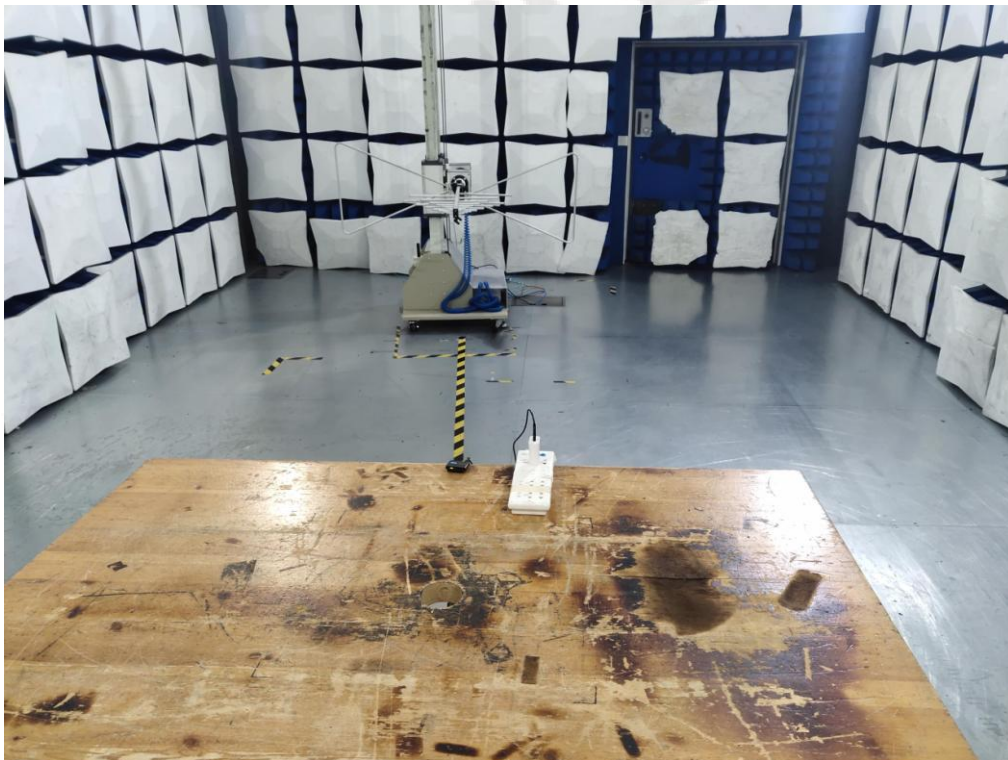



5. Photos of the EUT

External Photos of EUT

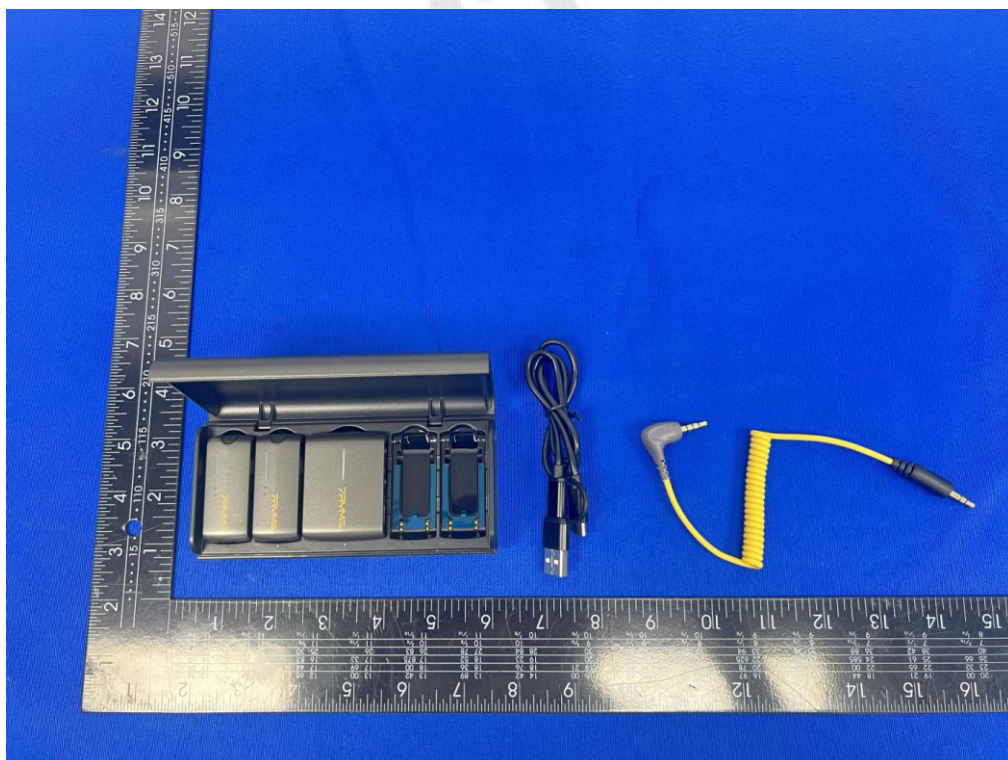
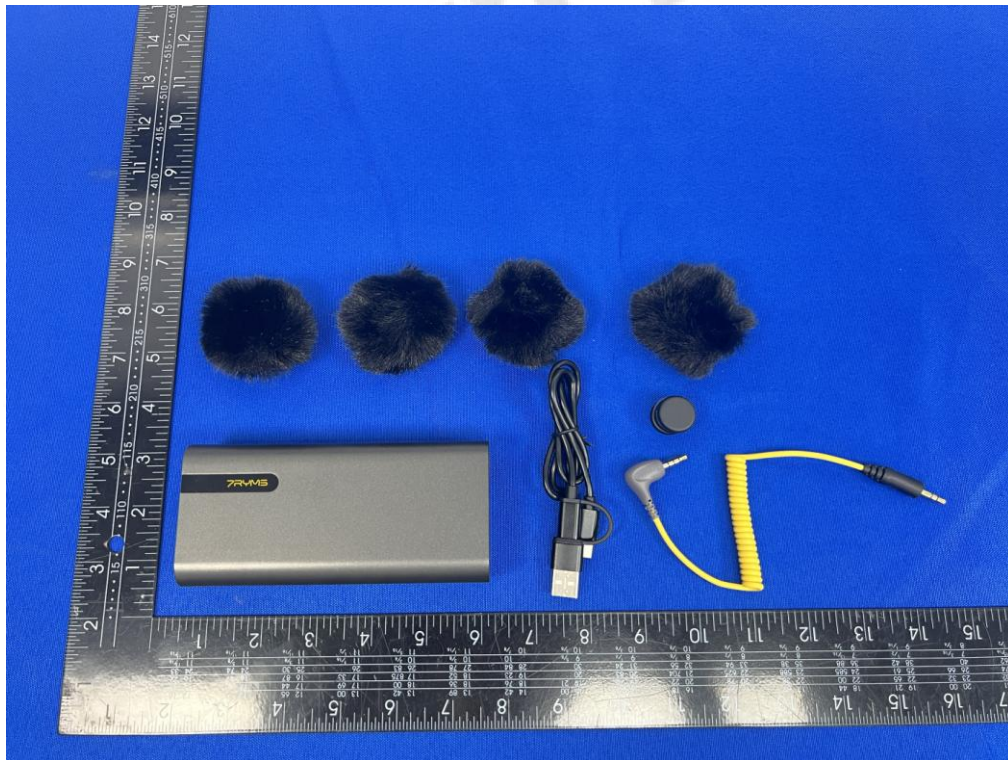

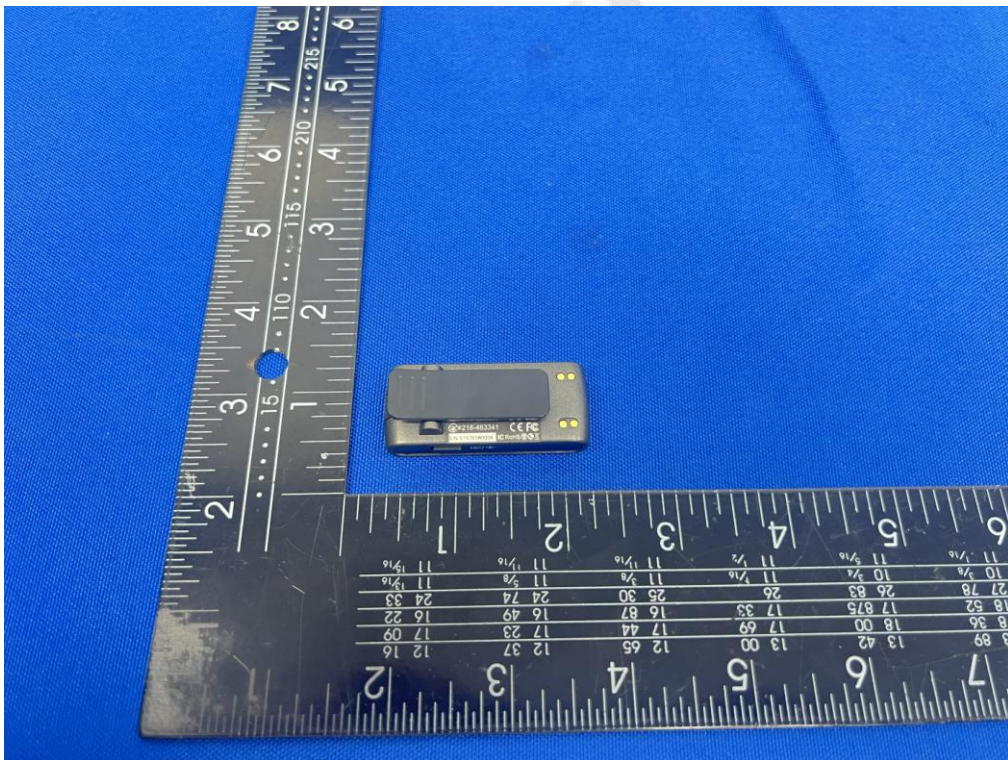
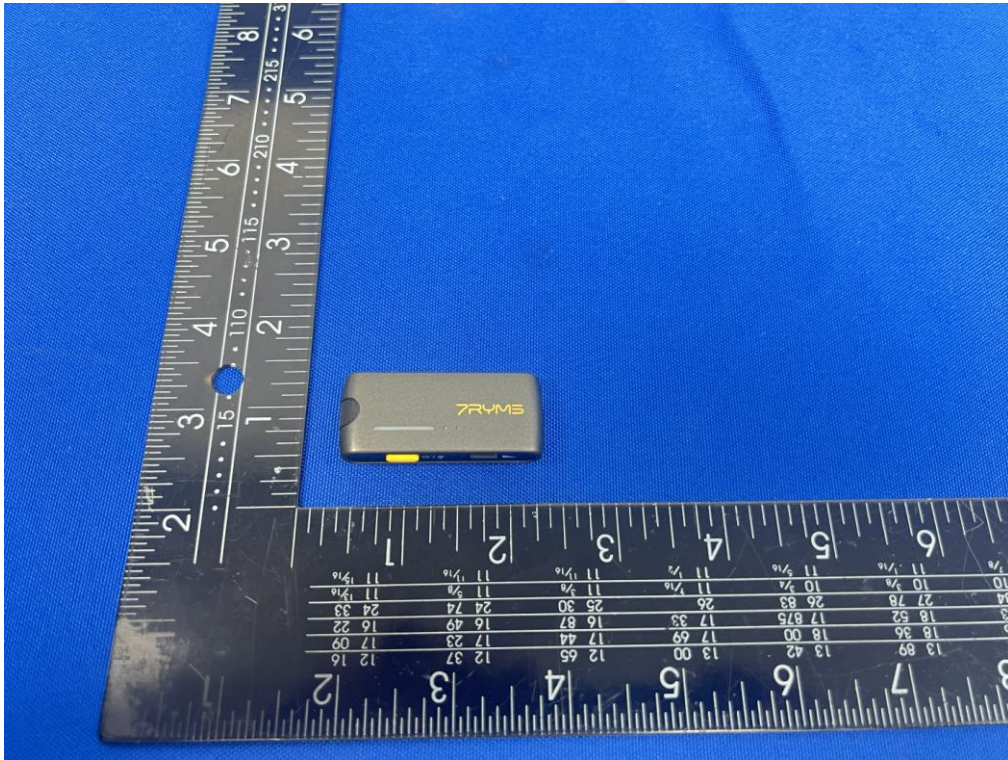

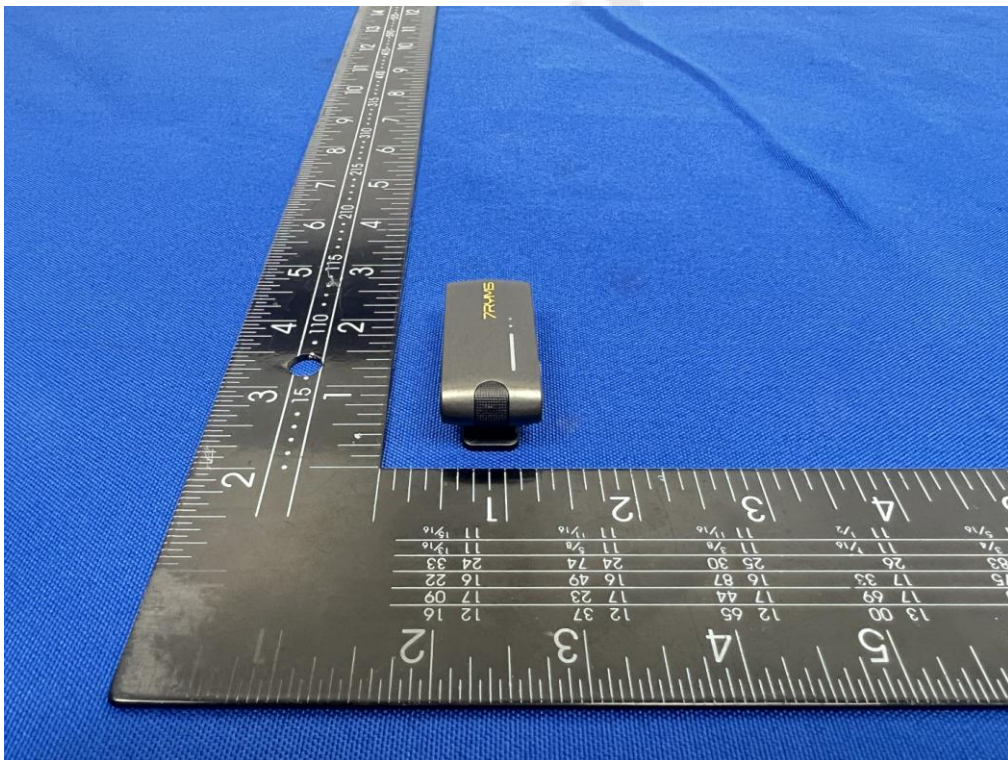
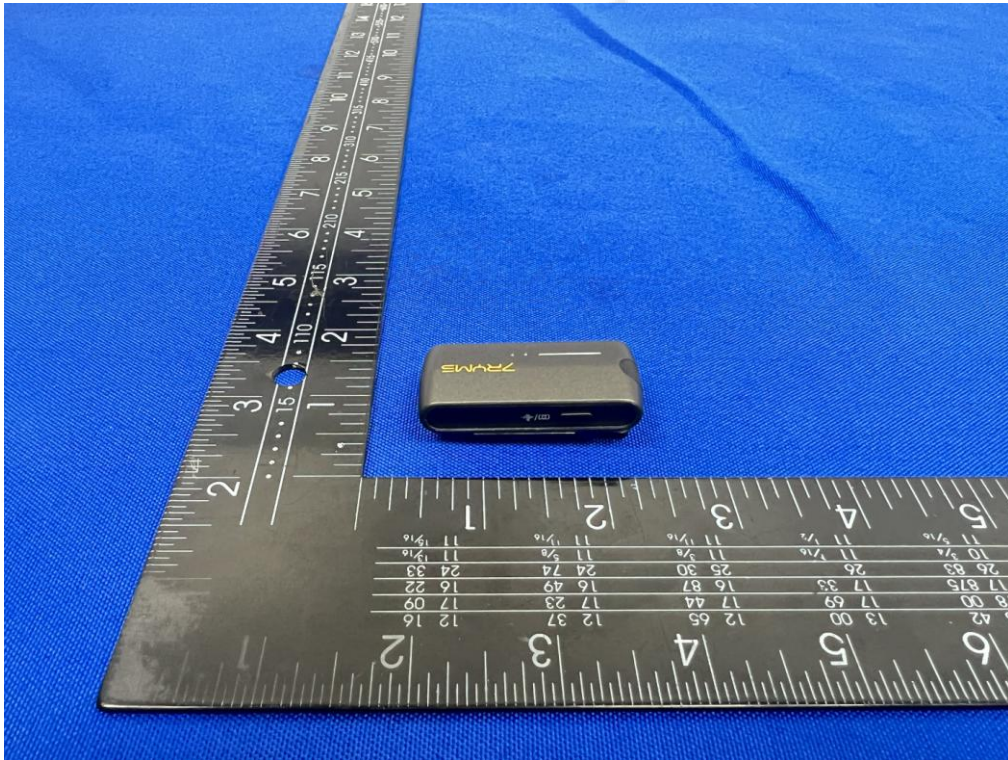

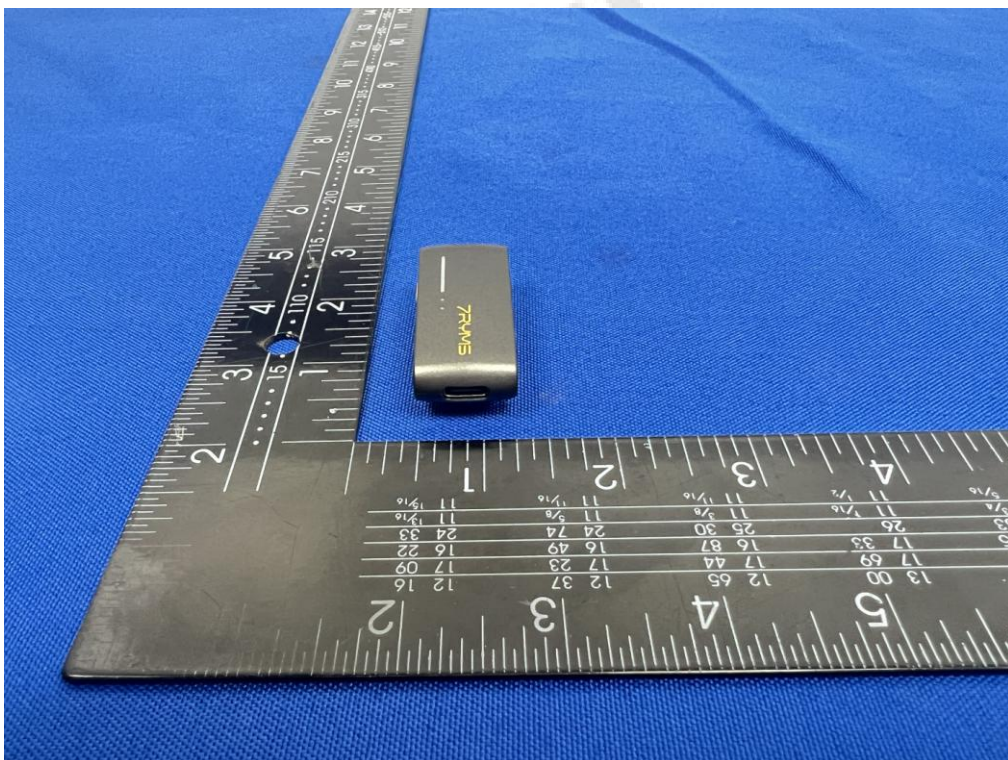
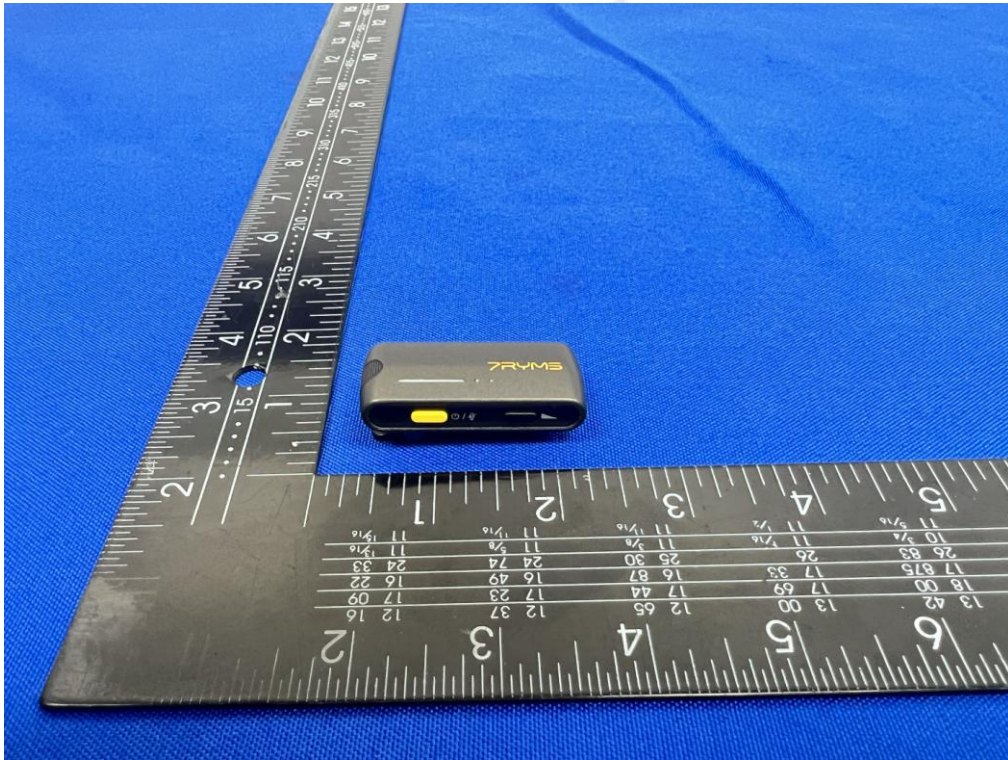

Internal Photos of EUT

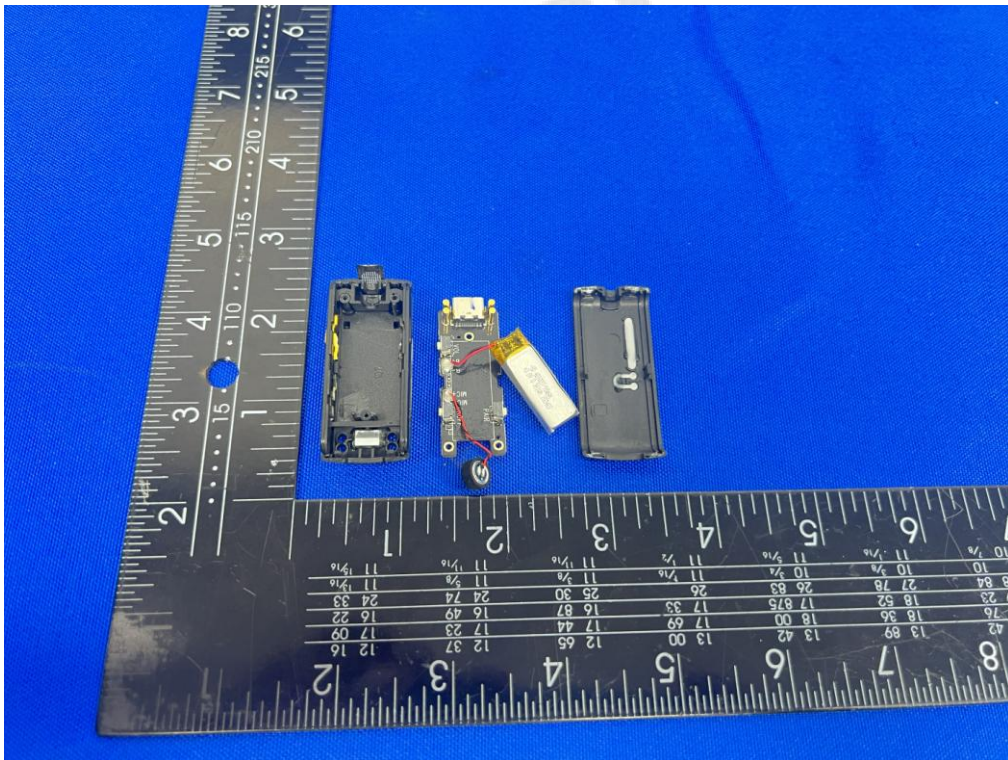
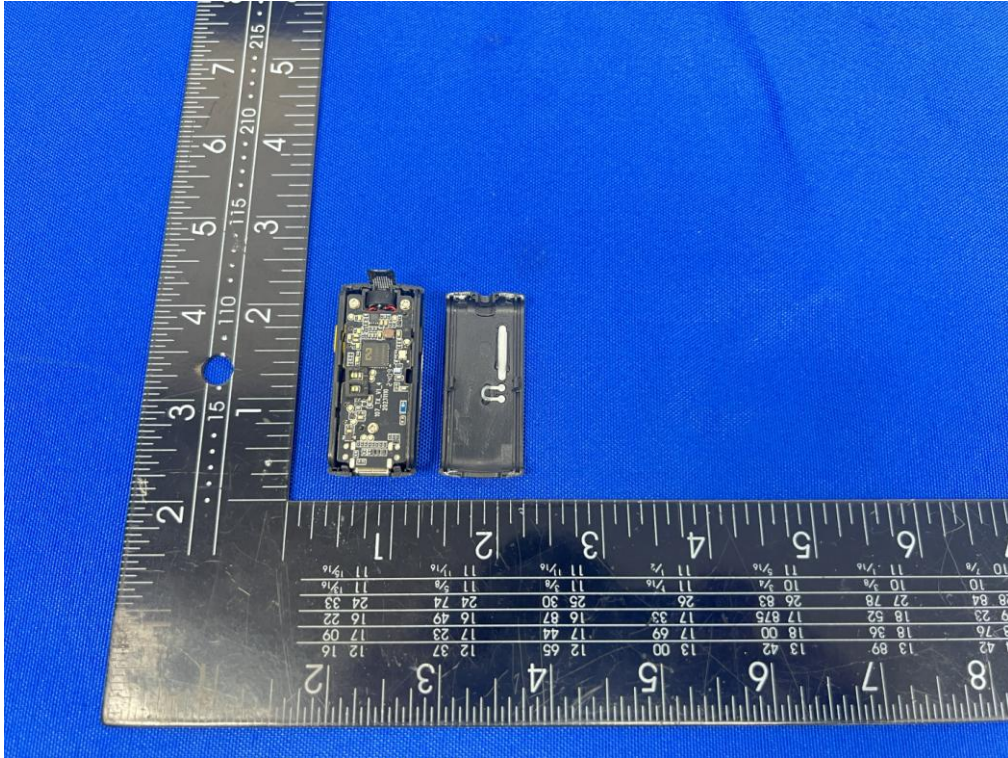

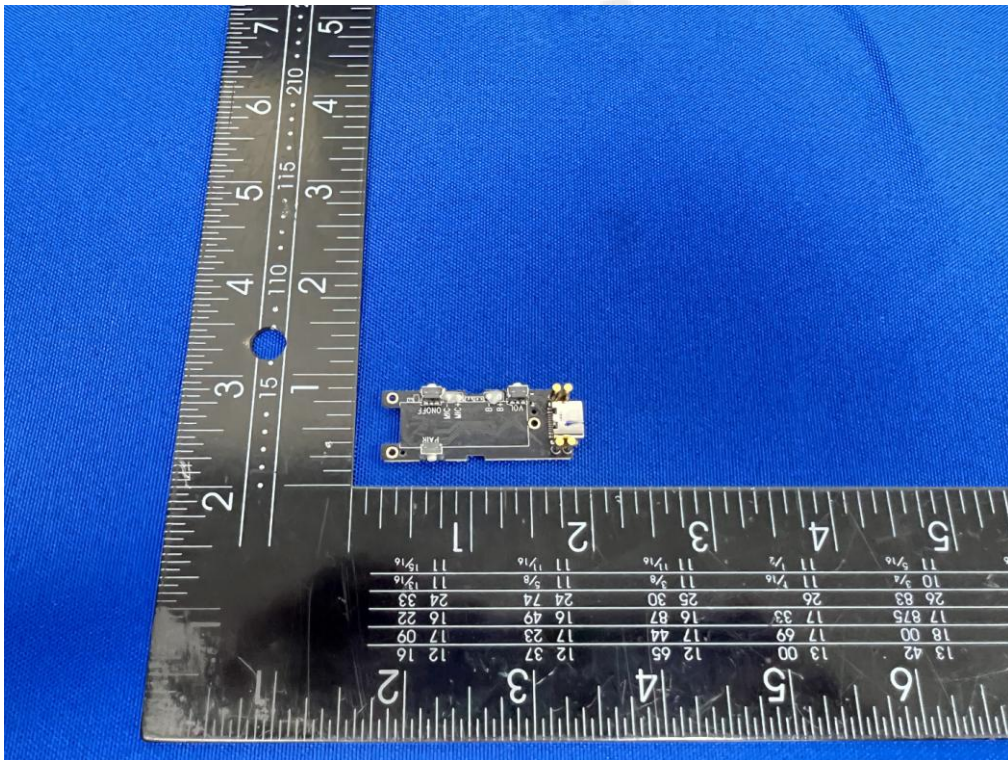
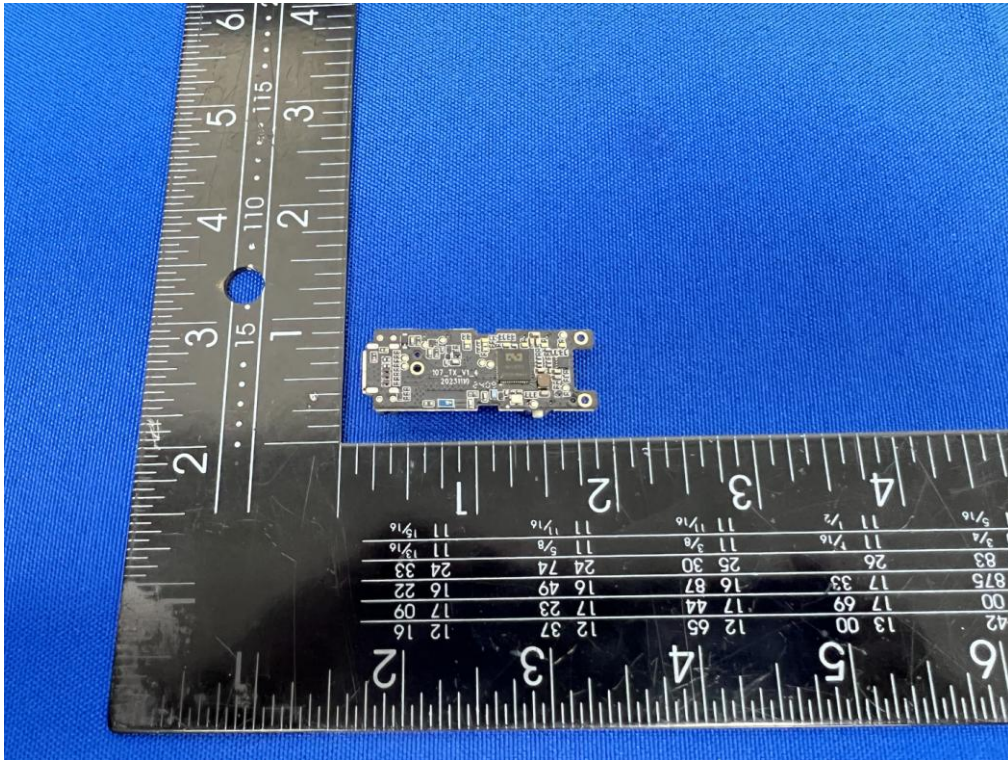

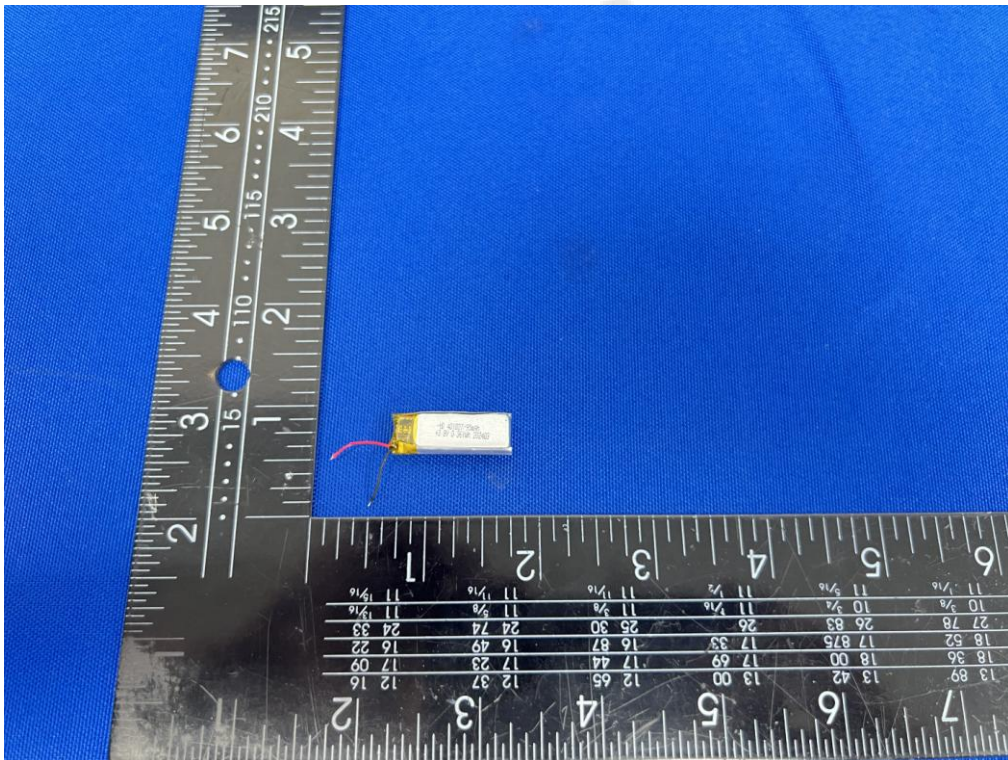
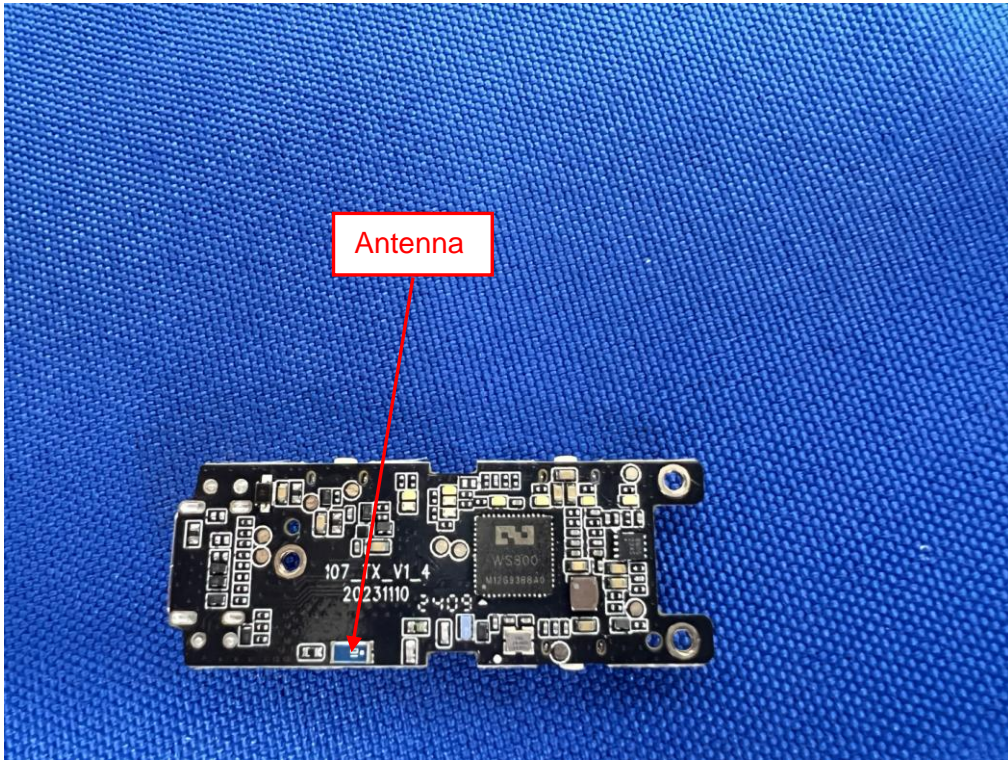

***** End of Report *****