



Shenzhen CTL Testing Technology Co., Ltd.
Tel: +86-755-89486194 E-mail: ctl@ctl-lab.com

TEST REPORT

FOR FCC PART 15 SUBPART C 15.249

Report Reference No. : CTL2302151021-WF

Compiled by: Happy Guo
(position+printed name+signature) (File administrators)

Tested by: Yilia Zhong
(position+printed name+signature) (Test Engineer)

Approved by: Ivan Xie
(position+printed name+signature) (Manager)



Product Name : 2.4G Super Cardioid Condenser Wireless Shotgun Microphone

Model/Type reference : CVM-VM30

List Model(s)..... : N/A

Trade Mark..... : COMICA

FCC ID..... : 2AZSQ-CVM-VM30

Applicant's name : Shenzhen Commlite Technology Co.,LTD.

Address of applicant : 5th Floor, Building B, NO. 167 Pingxin North Road, Pinghu Street,
Long'gang District, Shenzhen, Guangdong Province, China

Test Firm..... : Shenzhen CTL Testing Technology Co., Ltd.

Address of Test Firm : Floor 1-A, Baisha Technology Park, No.3011, Shahexi Road,
Nanshan District, Shenzhen, China 518055

Test specification..... :
Standard : FCC Part 15.249:Operation within the bands 920-928 MHz,
2400-2483.5 MHz, 5725-5850 MHz and 24.0 - 24.25 GHz.

TRF Originator : Shenzhen CTL Testing Technology Co., Ltd.

Master TRF : Dated 2011-01

Date of receipt of test item : Feb. 28, 2023

Date of Test Date..... : Feb. 28, 2023- Mar. 21, 2023

Data of Issue..... : Mar. 22, 2023

Result..... : Pass

Shenzhen CTL Testing Technology Co., Ltd. All rights reserved.

This publication may be reproduced in whole or in part for non-commercial purposes as long as the Shenzhen CTL Testing Technology Co., Ltd. is acknowledged as copyright owner and source of the material. Shenzhen CTL Testing Technology Co., Ltd. takes no responsibility for and will not assume liability for damages resulting from the reader's interpretation of the reproduced material due to its placement and context.

TEST REPORT

Test Report No. :	CTL2302151021-WF	Mar. 22, 2023
		Date of issue

Equipment under Test : 2.4G Super Cardioid Condenser Wireless Shotgun Microphone

Sample No. CTL230215102-1-S001

Model /Type : CVM-VM30

Listed Models : N/A

Applicant : **Shenzhen Commlite Technology Co.,LTD.**

Address : 5th Floor, Building B, NO. 167 Pingxin North Road,
Pinghu Street, Long'gang District, Shenzhen,
Guangdong Province, China

Manufacturer : **Shenzhen Commlite Technology Co.,LTD.**

Address : 5th Floor, Building B, NO. 167 Pingxin North Road,
Pinghu Street, Long'gang District, Shenzhen,
Guangdong Province, China

Test result	Pass *
--------------------	---------------

* In the configuration tested, the EUT complied with the standards specified page 5.

The test results presented in this report relate only to the object tested.

This report shall not be reproduced, except in full, without the written approval of the issuing testing laboratory.

Table of Contents

Page

1. SUMMARY	5
1.1. TEST STANDARDS	5
1.2. TEST DESCRIPTION	5
1.3. TEST FACILITY	6
1.4. STATEMENT OF THE MEASUREMENT UNCERTAINTY	6
2. GENERAL INFORMATION	8
2.1. ENVIRONMENTAL CONDITIONS	8
2.2. GENERAL DESCRIPTION OF EUT	8
2.3. DESCRIPTION OF TEST MODES AND TEST FREQUENCY	8
2.4. EQUIPMENTS USED DURING THE TEST	10
2.5. RELATED SUBMITTAL(S) / GRANT(S)	10
2.6. MODIFICATIONS	10
3. TEST CONDITIONS AND RESULTS	11
3.1. CONDUCTED EMISSIONS TEST	11
3.2. RADIATED EMISSIONS AND BAND EDGE	14
3.3. OCCUPIED BANDWIDTH MEASUREMENT	21
3.4. ANTENNA REQUIREMENT	23
4. TEST SETUP PHOTOS OF THE EUT	24
5. EXTERNAL AND INTERNAL PHOTOS OF THE EUT	26

1. SUMMARY

1.1. TEST STANDARDS

The tests were performed according to following standards:

FCC Rules Part 15.249: Operation within the bands 902 - 928 MHz, 2400 - 2483.5 MHz, 5725 - 5875 MHz, and 24.0 - 24.25 GHz.

ANSI C63.10:2013 : American National Standard for Testing Unlicensed Wireless Devices

1.2. Test Description

FCC PART 15.249		
FCC Part 15.249(a)	Field Strength of Fundamental	PASS
FCC Part 15.209	Spurious Emission	PASS
FCC Part 15.209	Band edge	PASS
FCC Part 15.215(c)	20dB bandwidth	PASS
FCC Part 15.207	Conducted Emission	PASS
FCC Part 15.203	Antenna Requirement	PASS

1.3. Test Facility

1.3.1 Address of the test laboratory

Shenzhen CTL Testing Technology Co., Ltd.

Floor 1-A, Baisha Technology Park, No. 3011, Shahexi Road, Nanshan, Shenzhen 518055 China

There is one 3m semi-anechoic chamber and two line conducted labs for final test. The Test Sites meet the requirements in documents ANSI C63.4 and CISPR 32/EN 55032 requirements.

1.3.2 Laboratory accreditation

The test facility is recognized, certified, or accredited by the following organizations:

CNAS-Lab Code: L7497

Shenzhen CTL Testing Technology Co., Ltd. has been assessed and proved to be in compliance with CNAS-CL01 Accreditation Criteria for Testing and Calibration Laboratories (identical to ISO/IEC 17025: 2005 General Requirements) for the Competence of Testing and Calibration Laboratories.

A2LA-Lab Cert. No. 4343.01

Shenzhen CTL Testing Technology Co., Ltd, EMC Laboratory has been accredited by A2LA for technical competence in the field of electrical testing, and proved to be in compliance with ISO/IEC 17025: 2005 General Requirements for the Competence of Testing and Calibration Laboratories and any additional program requirements in the identified field of testing.

IC Registration No.: 9618B

CAB identifier: CN0041

The 3m alternate test site of Shenzhen CTL Testing Technology Co., Ltd. EMC Laboratory has been registered by Innovation, Science and Economic Development Canada to test to Canadian radio equipment requirements with Registration No.: 9618B on Jan. 22, 2019.

1.4. Statement of the measurement uncertainty

The data and results referenced in this document are true and accurate. The reader is cautioned that there may be errors within the calibration limits of the equipment and facilities. The measurement uncertainty was calculated for all measurements listed in this test report acc. to CISPR 16 - 4 „Specification for radio disturbance and immunity measuring apparatus and methods – Part 4: Uncertainty in EMC Measurements“ and is documented in the Shenzhen CTL Testing Technology Co., Ltd. quality system acc. to DIN EN ISO/IEC 17025. Furthermore, component and process variability of devices similar to that tested may result in additional deviation. The manufacturer has the sole responsibility of continued compliance of the device.

Hereafter the best measurement capability for CTL laboratory is reported:

Test	Measurement Uncertainty	Notes
Transmitter power conducted	±0.57 dB	(1)
Transmitter power Radiated	±2.20 dB	(1)
Conducted spurious emission 9KHz-40 GHz	±2.20 dB	(1)
Occupied Bandwidth	±0.01ppm	(1)
Radiated Emission9KHz~30MHz	±3.40dB	(1)
Radiated Emission30~1000MHz	±4.10dB	(1)
Radiated Emission Above 1GHz	±4.32dB	(1)

Conducted Disturbance0.15~30MHz	$\pm 3.20\text{dB}$	(1)
---------------------------------	---------------------	-----

This uncertainty represents an expanded uncertainty expressed at approximately the 95% confidence level using a coverage factor of $k=2$.

2. GENERAL INFORMATION

2.1. Environmental conditions

During the measurement the environmental conditions were within the listed ranges:

Normal Temperature:	25°C
Relative Humidity:	55 %
Air Pressure:	101 kPa

2.2. General Description of EUT

Product Name:	2.4G Super Cardioid Condenser Wireless Shotgun Microphone
Model/Type reference:	CVM-VM30
Power supply:	DC 3.7V from battery
Hardware Version:	V1.0
Software Version:	V1.0
2.4G	
Modulation:	GFSK
Operation frequency:	2406MHz~2474MHz
Channel number:	18
Channel separation:	4MHz
Antenna type:	Internal Antenna
Antenna gain:	2.00dBi

Note1: For more details, please refer to the user's manual of the EUT.

Note2: Antenna gain provided by the applicant.

Note3: The product cannot be configured to operate outside the current frequency band plan through software configuration, Third parties are not allowed to change any software parameter configuration of the product.

2.3. Description of Test Modes and Test Frequency

The EUT has been tested under typical operating condition. The Applicant provides communication tools software to control the EUT for staying in continuous transmitting and receiving mode for testing. There are 18 channels provided to the EUT and Channel 01/09/18 were selected for testing.

Operation Frequency List :

Channel	Frequency (MHz)
01	2406
02	2410
03	2414
:	:
09	2438
:	:
16	2466
17	2470

18	2474
----	------

Note: The line display in grey is the channel selected to perform test.

2.4. Equipments Used during the Test

Test Equipment	Manufacturer	Model No.	Serial No.	Calibration Date	Calibration Due Date
LISN	R&S	ESH2-Z5	860014/010	2022/05/07	2023/05/06
Bilog Antenna	Sunol Sciences Corp.	JB1	A061713	2020/04/07	2023/04/06
EMI Test Receiver	R&S	ESCI	1166.5950.03	2022/05/07	2023/05/06
Spectrum Analyzer	Agilent	E4407B	MY41440676	2022/05/07	2023/05/06
Spectrum Analyzer	Agilent	N9020A	US46220290	2022/05/07	2023/05/06
Spectrum Analyzer	Keysight	N9020A	MY53420874	2022/05/07	2023/05/06
Controller	EM Electronics	EM 1000	060859	2022/05/07	2023/05/06
Horn Antenna	Sunol Sciences Corp.	DRH-118	A062013	2022/05/07	2023/05/06
Active Loop Antenna	Da Ze	ZN30900A	/	2022/05/07	2023/05/06
Amplifier	Agilent	8449B	3008A02306	2022/05/07	2023/05/06
Amplifier	Agilent	8447D	2944A10176	2022/05/07	2023/05/06
Temperature/Humidity Meter	Gangxing	CTH-608	02	2022/05/07	2023/05/06
Power Sensor	Agilent	U2021XA	MY55130004	2022/05/07	2023/05/06
Power Sensor	Agilent	U2021XA	MY55130006	2022/05/07	2023/05/06
Spectrum Analyzer	RS	FSP	1164.4391.38	2022/05/07	2023/05/06
Test Software					
Name of Software			Version		
TST-PASS			1.0.5		
ES-K1(Below 1GHz)			V1.71		
e3(Above 1GHz)			6.111221a		

The calibration interval was one year

2.5. Related Submittal(s) / Grant(s)

This submittal(s) (test report) is intended to comply with Section 15.249 of the FCC Part 15, Subpart C Rules.

2.6. Modifications

No modifications were implemented to meet testing criteria.

3. TEST CONDITIONS AND RESULTS

3.1. Conducted Emissions Test

LIMIT

FCC CFR Title 47 Part 15 Subpart C Section 15.207

Frequency range (MHz)	Limit (dBuV)	
	Quasi-peak	Average
0.15-0.5	66 to 56*	56 to 46*
0.5-5	56	46
5-30	60	50

* Decreases with the logarithm of the frequency.

TEST CONFIGURATION

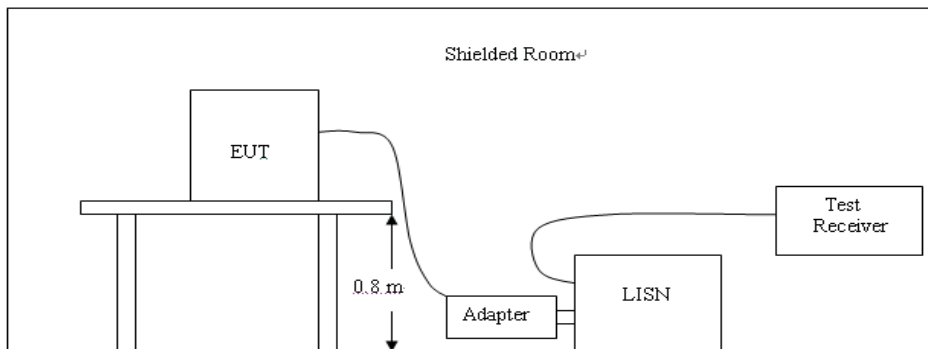

TEST PROCEDURE

1. The equipment was set up as per the test configuration to simulate typical actual usage per the user's manual. The EUT is a tabletop system; a wooden table with a height of 0.8 meters is used and is placed on the ground plane as per ANSI C63.10:2013.
2. Support equipment, if needed, was placed as per ANSI C63.10:2013.
3. All I/O cables were positioned to simulate typical actual usage as per ANSI C63.10:2013.
4. If a EUT received DC power from the USB Port of Notebook PC, the PC's adapter received AC120V/60Hz power through a Line Impedance Stabilization Network (LISN) which supplied power source and was grounded to the ground plane.
5. All support equipments received AC power from a second LISN, if any.
6. The EUT test program was started. Emissions were measured on each current carrying line of the EUT using a spectrum Analyzer / Receiver connected to the LISN powering the EUT. The LISN has two monitoring points: Line 1 (Hot Side) and Line 2 (Neutral Side). Two scans were taken: one with Line 1 connected to Analyzer / Receiver and Line 2 connected to a 50 ohm load; the second scan had Line 1 connected to a 50 ohm load and Line 2 connected to the Analyzer / Receiver.
7. Analyzer / Receiver scanned from 150 KHz to 30MHz for emissions in each of the test modes.
8. During the above scans, the emissions were maximized by cable manipulation.

TEST RESULTS

Remark: All modes were test at Low, Middle, and High channel; only the worst result of High Channel was reported as below:

SCAN TABLE: "Voltage (9K-30M)FIN"
 Short Description: 150K-30M Voltage

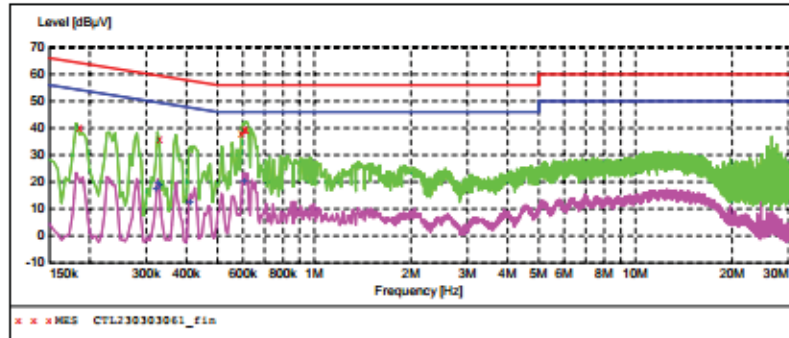

MEASUREMENT RESULT: "CTL230303061_fin"

3/2/2023 9:23PM

Frequency MHz	Level dBuV	Transd dB	Limit dBuV	Margin dB	Detector	Line	FE
0.186000	39.90	10.0	64	24.3	QP	L1	GND
0.330000	36.00	10.1	60	23.5	QP	L1	GND
0.595500	38.10	10.1	56	17.9	QP	L1	GND
0.604500	39.60	10.1	56	16.4	QP	L1	GND
0.613500	39.60	10.1	56	16.4	QP	L1	GND

MEASUREMENT RESULT: "CTL230303061_fin2"

3/2/2023 9:23PM

Frequency MHz	Level dBuV	Transd dB	Limit dBuV	Margin dB	Detector	Line	FE
0.321000	17.50	10.1	50	32.2	AV	L1	GND
0.325500	19.40	10.1	50	30.2	AV	L1	GND
0.330000	18.90	10.1	50	30.6	AV	L1	GND
0.411000	12.20	10.1	48	35.4	AV	L1	GND
0.604500	20.40	10.1	46	25.6	AV	L1	GND

SCAN TABLE: "Voltage (9K-30M) FIN"
 Short Description: 150K-30M Voltage

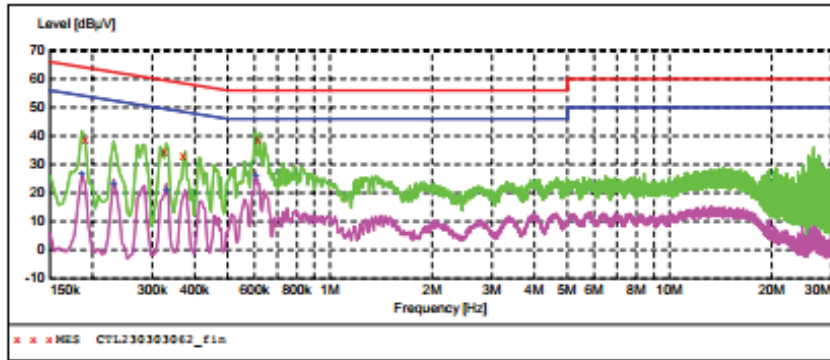

MEASUREMENT RESULT: "CTL230303062_fin"

3/2/2023 9:25PM

Frequency MHz	Level dBuV	Transd dB	Limit dBuV	Margin dB	Detector	Line	FE
0.190500	38.80	10.0	64	25.2	QP	N	GND
0.325500	34.60	10.1	60	25.0	QP	N	GND
0.370500	33.20	10.1	59	25.3	QP	N	GND
0.613500	38.80	10.1	56	17.2	QP	N	GND

MEASUREMENT RESULT: "CTL230303062_fin2"

3/2/2023 9:25PM

Frequency MHz	Level dBuV	Transd dB	Limit dBuV	Margin dB	Detector	Line	FE
0.186000	26.30	10.0	54	27.9	AV	N	GND
0.231000	22.90	10.0	52	29.5	AV	N	GND
0.330000	21.20	10.1	50	28.3	AV	N	GND
0.604500	25.70	10.1	46	20.3	AV	N	GND

3.2. Radiated Emissions and Band Edge

Limit

According 15.249, the field strength of emissions from intentional radiators operated within 2400MHz-2483.5 MHz shall not exceed 94dB μ V/m (50mV/m):

FCC PART 15.249(d) Emissions radiated outside of the specified frequency bands, except for harmonics, shall be attenuated by at least 50 dB below the level of the fundamental or to the general radiated emission limits in §15.209, whichever is the lesser attenuation.

In addition, radiated emissions which fall in the restricted bands, as defined in §15.205(a), must also comply with the radiated emission limits specified in §15.209(a)

Radiated emission limits

Frequency (MHz)	Distance (Meters)	Radiated (dB μ V/m)	Radiated (μ V/m)
0.009-0.49	3	$20\log(2400/F(\text{KHz}))+40\log(300/3)$	$2400/F(\text{KHz})$
0.49-1.705	3	$20\log(24000/F(\text{KHz}))+40\log(30/3)$	$24000/F(\text{KHz})$
1.705-30	3	$20\log(30)+40\log(30/3)$	30
30-88	3	40.0	100
88-216	3	43.5	150
216-960	3	46.0	200
Above 960	3	54.0	500

According to §15.249 (a): Except as provided in paragraph (b) of this section, the field strength of emissions from intentional radiators operated within these frequency bands shall comply with the following:

Fundamental frequency	Field strength of fundamental (millivolts/meter)	Field strength of harmonics (microvolts/meter)
902-928 MHz	50	500
2400-2483.5 MHz	50	500
5725-5875 MHz	50	500
24.0-24.25 GHz	250	2500

* Field strength limits are specified at a distance of 3 meters.

* As shown in §15.35(b), for frequencies above 1000 MHz, the field strength limits in paragraphs (a) and (b) of this section are based on average limits. However, the peak field strength of any emission shall not exceed the maximum permitted average limits specified above by more than 20 dB under any condition of modulation. For point-to-point operation under paragraph (b) of this section, the peak field strength shall not exceed 2500 millivolts/meter at 3 meters along the antenna azimuth.

* Emissions radiated outside of the specified frequency bands, except for harmonics, shall be attenuated by at least 50 dB below the level of the fundamental or to the general radiated emission limits in §15.209, whichever is the lesser attenuation.

TEST CONFIGURATION

(A) Radiated Emission Test Set-Up, Frequency Below 30MHz

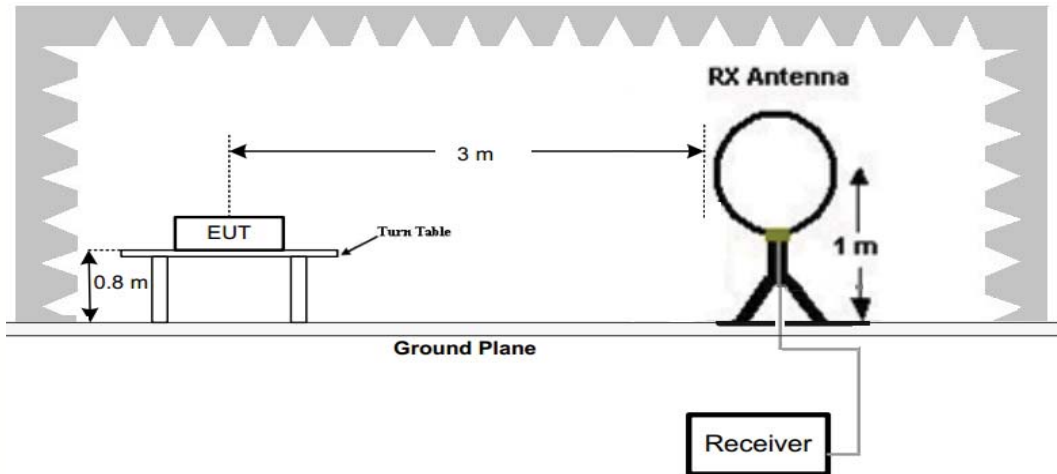

(B) Radiated Emission Test Set-Up, Frequency below 1000MHz

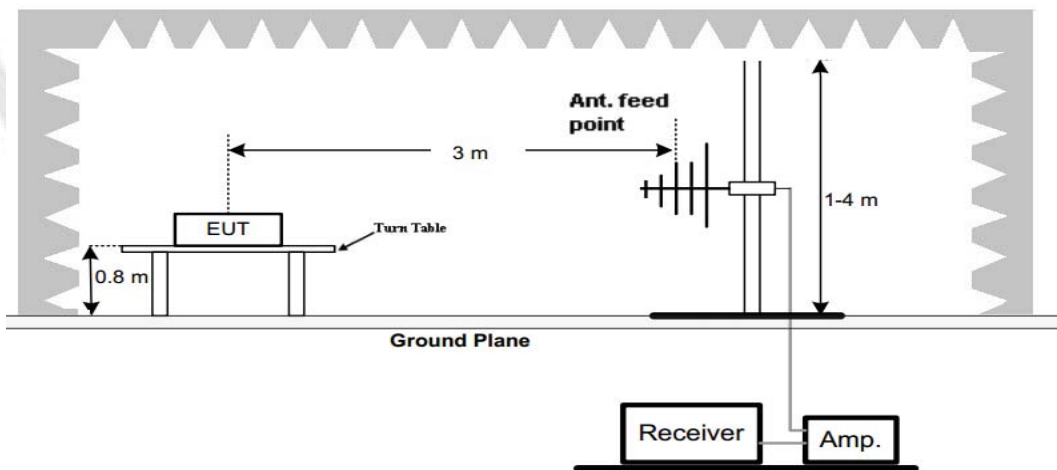

(C) Radiated Emission Test Set-Up, Frequency above 1000MHz

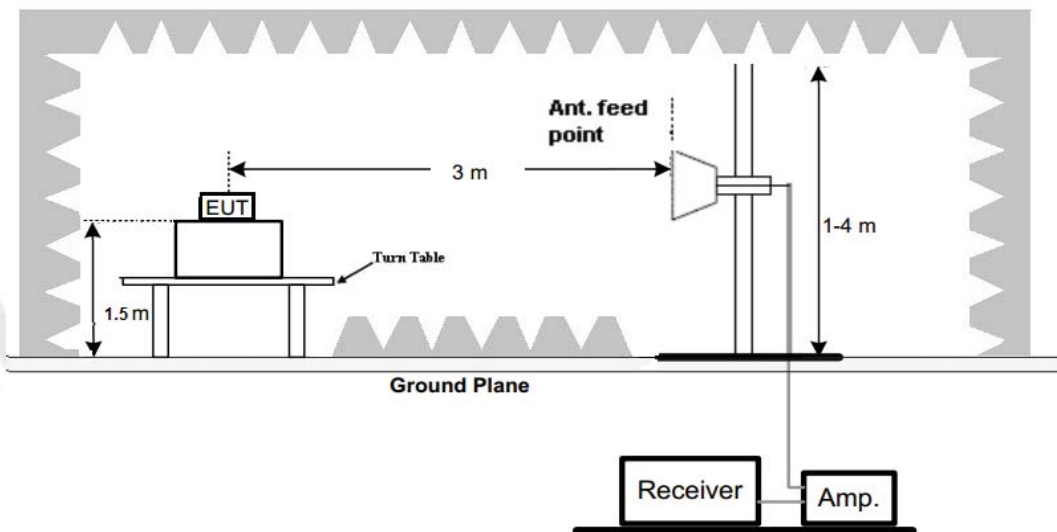

Test Procedure

1. Below 1GHz measurement the EUT is placed on a turntable which is 0.8m above ground plane, and above 1GHz measurement EUT was placed on a low permittivity and low loss tangent turn table which is 1.5m above ground plane.
2. Maximum procedure was performed by raising the receiving antenna from 1m to 4m and rotating the turn table from 0° to 360° to acquire the highest emissions from EUT
3. And also, each emission was to be maximized by changing the polarization of receiving antenna both horizontal and vertical.
4. Repeat above procedures until all frequency measurements have been completed.
5. Radiated emission test frequency band from 9KHz to 25GHz.
6. The distance between test antenna and EUT as following table states:

Test Frequency range	Test Antenna Type	Test Distance
9KHz-30MHz	Active Loop Antenna	3
30MHz-1GHz	Bilog Antenna	3
1GHz-18GHz	Horn Antenna	3
18GHz-25GHz	Horn Antenna	1

7. Setting test receiver/spectrum as following table states:

Test Frequency range	Test Receiver/Spectrum Setting	Detector
9KHz-150KHz	RBW=200Hz/VBW=3KHz, Sweep time=Auto	QP
150KHz-30MHz	RBW=9KHz/VBW=100KHz, Sweep time=Auto	QP
30MHz-1GHz	RBW=120KHz/VBW=1000KHz, Sweep time=Auto	QP
1GHz-40GHz	Peak Value: RBW=1MHz/VBW=3MHz, Sweep time=Auto Average Value: RBW=1MHz/VBW=10Hz, Sweep time=Auto	Peak

TEST RESULTS

Remark:

1. We measured Radiated Emission at GFSK mode from 9 KHz to 25GHz and recorded worst case.
2. For below 1GHz testing recorded worst at GFSK low channel.
3. Radiated emission test from 9 KHz to 10th harmonic of fundamental was verified, and no emission found except system noise floor in 9 KHz to 30MHz and not recorded in this report.

For 30MHz-1GHz

Horizontal

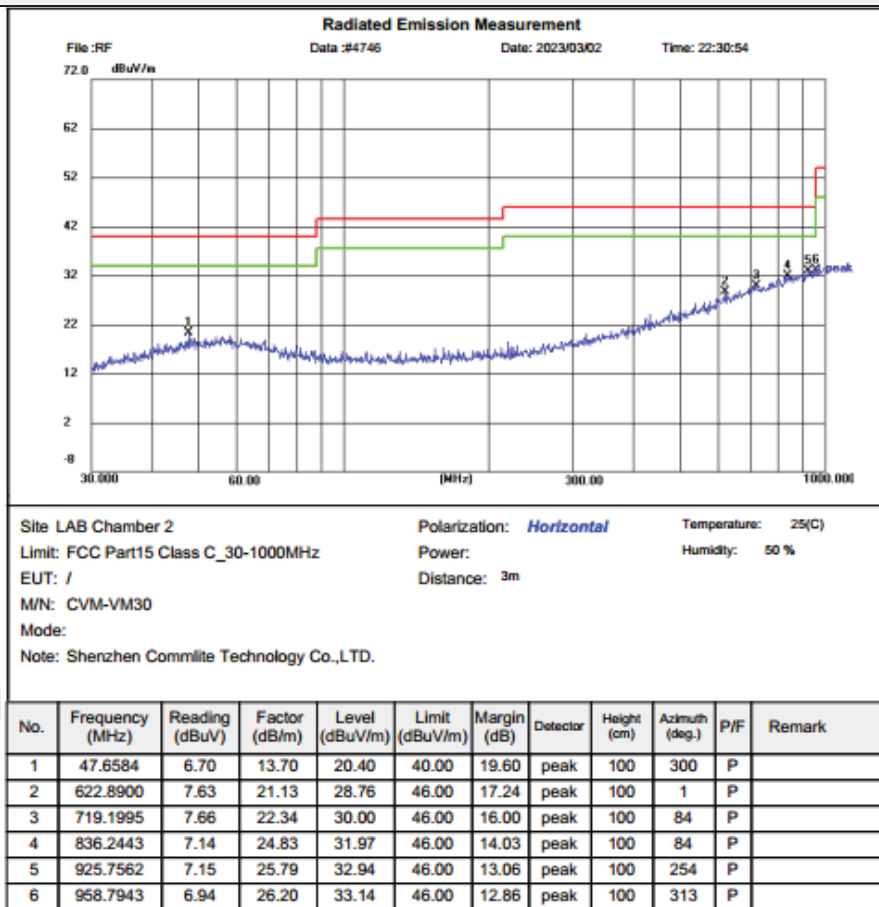

Vertical

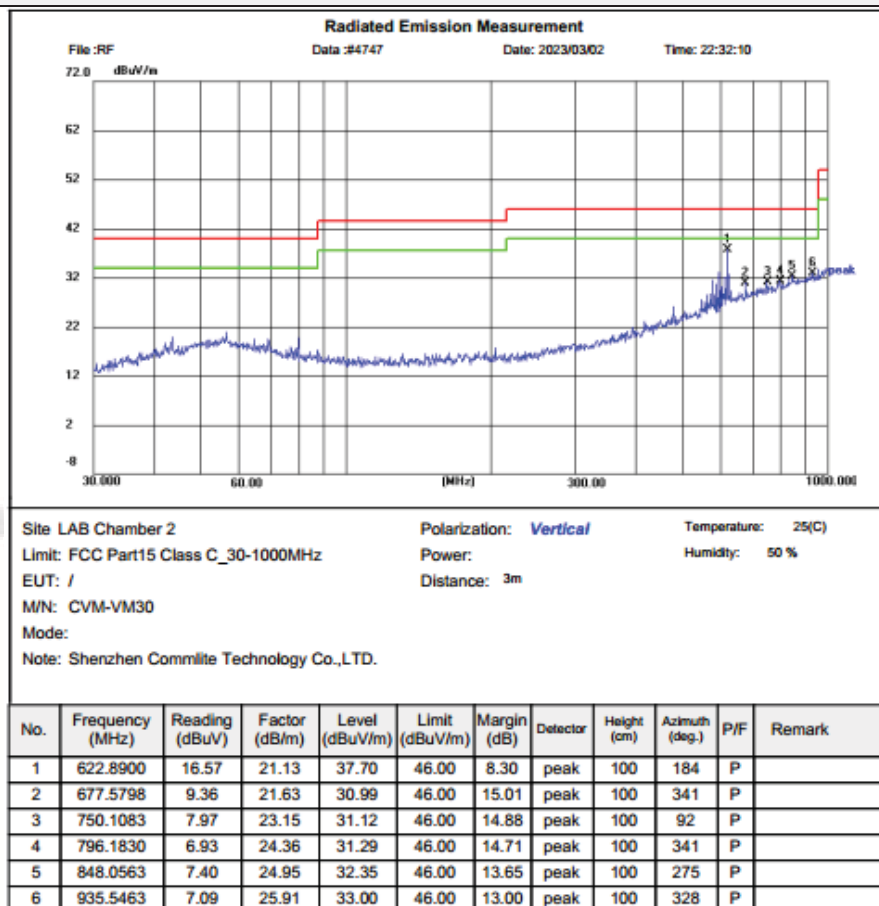

For 1GHz to 25GHz:**. GFSK Mode (above 1GHz)**

Frequency(MHz):				2406		Polarity:			HORIZONTAL	
No.	Frequency (MHz)	Emission Level (dBuV/m)		Limit (dBuV/m)	Margin (dB)	Raw Value (dBuV)	Antenna Factor (dB/m)	Cable Factor (dB)	Pre-amplifier (dB)	Correction Factor (dB/m)
1	2406.00	104.98	PK	114	9.02	71.58	28.79	4.62	0.00	33.40
1	2406.00	93.57	AV	94	0.43	60.17	28.79	4.62	0.00	33.40
2	2390.00	45.85	PK	74	28.15	12.53	28.72	4.60	0.00	33.32
2	2390.00	--	AV	54	--	--	--	--	--	--
3	2400.00	51.23	PK	74	22.77	17.84	28.78	4.61	0.00	33.39
3	2400.00	--	AV	54	--	--	--	--	--	--
4	4812.00	59.53	PK	74	14.47	55.01	33.50	6.92	35.89	4.52
4	4812.00	50.76	AV	54	3.24	46.24	33.50	6.92	35.89	4.52
5	5022.00	47.42	PK	74	26.58	40.60	34.02	7.04	34.23	6.82
5	5022.00	--	AV	54	--	--	--	--	--	--
6	7218.00	51.91	PK	74	22.09	40.75	36.99	9.19	35.02	11.16
6	7218.00	--	AV	54	--	--	--	--	--	--

Frequency(MHz):				2406		Polarity:			VERTICAL	
No.	Frequency (MHz)	Emission Level (dBuV/m)		Limit (dBuV/m)	Margin (dB)	Raw Value (dBuV)	Antenna Factor (dB/m)	Cable Factor (dB)	Pre-amplifier (dB)	Correction Factor (dB/m)
1	2406.00	101.04	PK	114	12.96	67.64	28.79	4.62	0.00	33.40
1	2406.00	91.32	AV	94	2.68	57.92	28.79	4.62	0.00	33.40
2	2390.00	46.86	PK	74	27.14	13.54	28.72	4.60	0.00	33.32
2	2390.00	--	AV	54	--	--	--	--	--	--
3	2400.00	48.70	PK	74	25.3	15.31	28.78	4.61	0.00	33.39
3	2400.00	--	AV	54	--	--	--	--	--	--
4	4812.00	56.50	PK	74	17.50	51.98	33.50	6.92	35.89	4.52
4	4812.00	46.67	AV	54	7.33	42.15	33.50	6.92	35.89	4.52
5	5022.00	45.13	PK	74	28.87	35.02	36.16	9.00	35.05	10.11
5	5022.00	--	AV	54	--	--	--	--	--	--
6	7218.00	48.46	PK	74	25.54	37.30	36.99	9.19	35.02	11.16
6	7218.00	--	AV	54	--	--	--	--	--	--

REMARKS:

1. Emission level (dBuV/m) =Raw Value (dBuV)+Correction Factor (dB/m)
2. Correction Factor (dB/m) = Antenna Factor (dB/m)+Cable Factor (dB)-Pre-amplifier Factor
3. Margin value = Limit value- Emission level.
4. -- Mean the PK detector measured value is below average limit.
5. The other emission levels were very low against the limit.
6. RBW1MHz VBW3MHz Peak detector is for PK value; RBW 1MHz VBW10Hz Peak detector is for AV value.
7. For fundamental frequency, RBW 3MHz VBW 3MHz Peak detector is for PK Value ; RMS detector is for AV value.

Frequency(MHz):				2438		Polarity:			HORIZONTAL	
No.	Frequency (MHz)	Emission Level (dBuV/m)		Limit (dBuV/m)	Margin (dB)	Raw Value (dBuV)	Antenna Factor (dB/m)	Cable Factor (dB)	Pre-amplifier (dB)	Correction Factor (dB/m)
1	2438.00	103.31	PK	114	10.69	69.79	28.86	4.66	0.00	33.52
1	2438.00	92.82	AV	94	1.18	59.30	28.86	4.66	0.00	33.52
2	3422.00	44.85	PK	74	29.15	43.08	31.62	5.74	35.58	1.77
2	3422.00	--	AV	54	--	--	--	--	--	--
3	4876.00	57.40	PK	74	16.60	51.02	33.62	6.96	34.19	6.38
3	4876.00	48.09	AV	54	5.91	41.71	33.62	6.96	34.19	6.38
4	5084.00	46.24	PK	74	27.76	39.16	34.26	7.08	34.26	7.08
4	5084.00	--	AV	54	--	--	--	--	--	--
5	7314.00	49.11	PK	74	24.89	37.38	37.49	9.23	34.99	11.73
5	7314.00	--	AV	54	--	--	--	--	--	--

Frequency(MHz):				2438		Polarity:			VERTICAL	
No.	Frequency (MHz)	Emission Level (dBuV/m)		Limit (dBuV/m)	Margin (dB)	Raw Value (dBuV)	Antenna Factor (dB/m)	Cable Factor (dB)	Pre-amplifier (dB)	Correction Factor (dB/m)
1	2438.00	100.10	PK	114	13.90	66.58	28.86	4.66	0.00	33.52
1	2438.00	90.98	AV	94	3.02	57.46	28.86	4.66	0.00	33.52
2	3422.00	45.36	PK	74	28.64	41.72	32.83	6.59	35.78	3.64
2	3422.00	--	AV	54	--	--	--	--	--	--
3	4876.00	54.90	PK	74	19.10	48.62	33.62	6.96	34.29	6.28
3	4876.00	46.18	AV	54	7.82	39.90	33.62	6.96	34.29	6.28
4	5084.00	47.02	PK	74	26.98	39.61	34.57	7.16	34.31	7.41
4	5084.00	--	AV	54	--	--	--	--	--	--
5	7314.00	47.13	PK	74	26.87	35.40	37.49	9.23	34.99	11.73
5	7314.00	--	AV	54	--	--	--	--	--	--

REMARKS:

1. Emission level (dBuV/m) =Raw Value (dBuV)+Correction Factor (dB/m)
2. Correction Factor (dB/m) = Antenna Factor (dB/m)+Cable Factor (dB)-Pre-amplifier Factor
3. Margin value = Limit value- Emission level.
4. -- Mean the PK detector measured value is below average limit.
5. The other emission levels were very low against the limit.
6. RBW1MHz VBW3MHz Peak detector is for PK value; RBW 1MHz VBW10Hz Peak detector is for AV value.
7. For fundamental frequency, RBW 3MHz VBW 3MHz Peak detector is for PK Value; RMS detector is for AV value.

Frequency(MHz):				2474		Polarity:			HORIZONTAL	
No.	Frequency (MHz)	Emission Level (dBuV/m)		Limit (dBuV/m)	Margin (dB)	Raw Value (dBuV)	Antenna Factor (dB/m)	Cable Factor (dB)	Pre-amplifier (dB)	Correction Factor (dB/m)
1	2474.00	103.25	PK	114	10.75	69.64	28.92	4.69	0.00	33.61
1	2474.00	93.89	AV	94	0.11	60.28	28.92	4.69	0.00	33.61
2	2483.50	48.48	PK	74	25.52	14.85	28.93	4.70	0.00	33.63
2	2483.50	--	AV	54	--	--	--	--	--	--
3	2500.00	44.31	PK	74	29.69	10.63	28.96	4.72	0.00	33.68
3	2500.00	--	AV	54	--	--	--	--	--	--
4	4948.00	58.97	PK	74	15.03	52.43	33.81	7.00	34.26	6.54
4	4948.00	49.73	AV	54	4.27	43.19	33.81	7.00	34.26	6.54
5	6365.00	46.62	PK	74	27.38	38.06	35.18	8.15	34.77	8.56
5	6365.00	--	AV	54	--	--	--	--	--	--
6	7422.00	47.46	PK	74	26.54	35.52	37.64	9.27	34.97	11.94
6	7422.00	--	AV	54	--	--	--	--	--	--

Frequency(MHz):				2474		Polarity:			VERTICAL	
No.	Frequency (MHz)	Emission Level (dBuV/m)		Limit (dBuV/m)	Margin (dB)	Raw Value (dBuV)	Antenna Factor (dB/m)	Cable Factor (dB)	Pre-amplifier (dB)	Correction Factor (dB/m)
1	2474.00	102.32	PK	114	11.68	68.71	28.92	4.69	0.00	33.61
1	2474.00	91.54	AV	94	2.46	57.93	28.92	4.69	0.00	33.61
2	2483.50	48.45	PK	74	25.55	14.82	28.93	4.70	0.00	33.63
2	2483.50	--	AV	54	--	--	--	--	--	--
3	2500.00	42.03	PK	74	31.97	8.35	28.96	4.72	0.00	33.68
3	2500.00	--	AV	54	--	--	--	--	--	--
4	4948.00	55.56	PK	74	18.44	49.02	33.81	7.00	34.26	6.54
4	4948.00	46.38	AV	54	7.62	39.84	33.81	7.00	34.26	6.54
5	6365.00	48.94	PK	74	25.06	41.21	34.79	7.42	34.48	7.73
5	6365.00	--	AV	54	--	--	--	--	--	--
6	7422.00	48.11	PK	74	25.89	36.17	37.64	9.27	34.97	11.94
6	7422.00	--	AV	54	--	--	--	--	--	--

REMARKS:

1. Emission level (dBuV/m) =Raw Value (dBuV)+Correction Factor (dB/m)
2. Correction Factor (dB/m) = Antenna Factor (dB/m)+Cable Factor (dB)-Pre-amplifier Factor
3. Margin value = Limit value- Emission level.
4. -- Mean the PK detector measured value is below average limit.
5. The other emission levels were very low against the limit.
6. RBW1MHz VBW3MHz Peak detector is for PK value; RBW 1MHz VBW10Hz Peak detector is for AV value.
7. For fundamental frequency, RBW 3MHz VBW 3MHz Peak detector is for PK Value; RMS detector is for AV value.

3.3. Occupied Bandwidth Measurement

Limit

N/A

Test Configuration



Test Procedure

The transmitter output was connected to the spectrum analyzer through an attenuator. The bandwidth of the fundamental frequency was measured by spectrum analyzer with 100 KHz RBW and 300 KHz VBW.

The 20dB bandwidth is defined as the total spectrum the power of which is higher than peak power minus 20dB.

Test Results

Modulation	Channel	99% OBW (MHz)	20dB bandwidth (MHz)	Result
GFSK	CH01	3.8234	4.319	Pass
	CH09	3.8140	4.323	
	CH18	3.7893	4.223	

Test plot as follows:

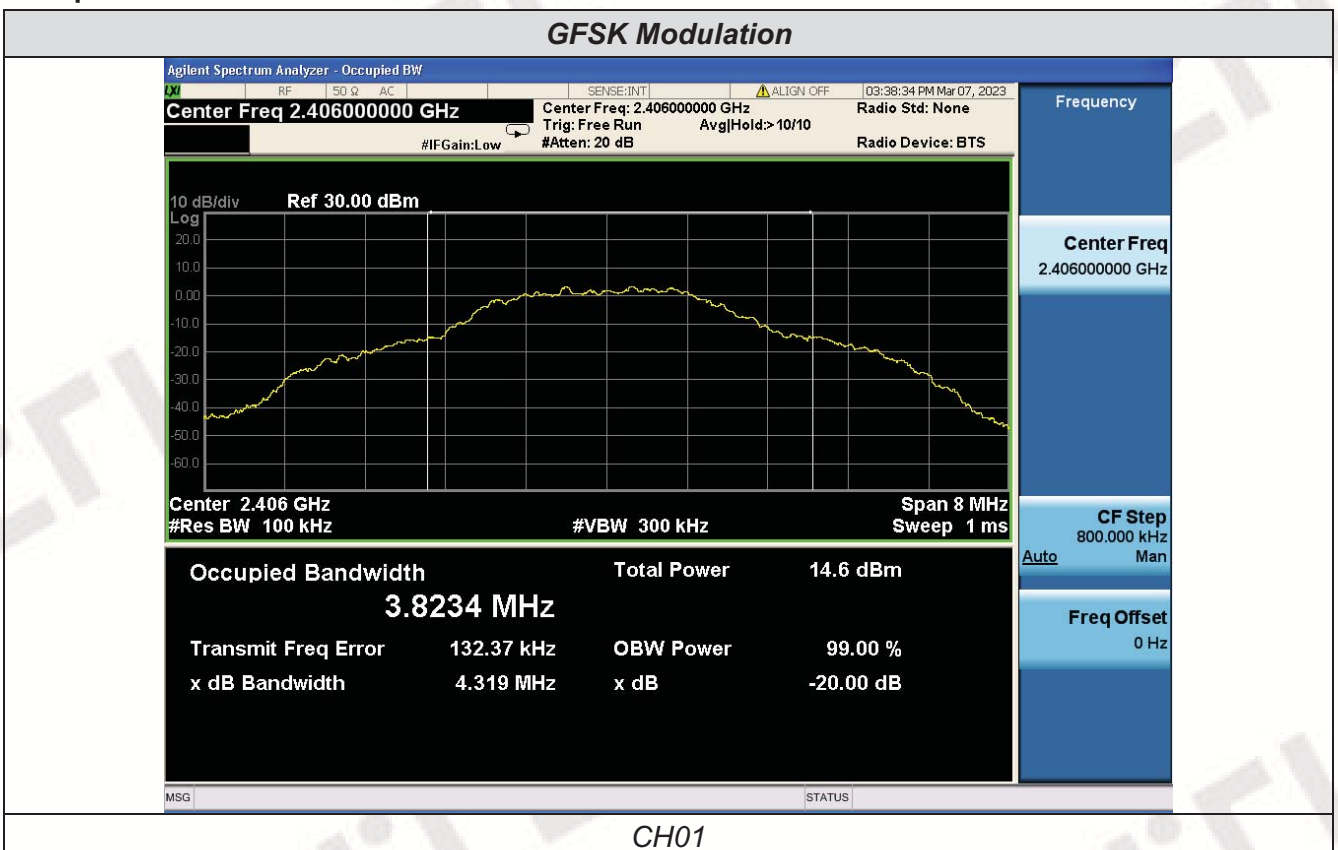

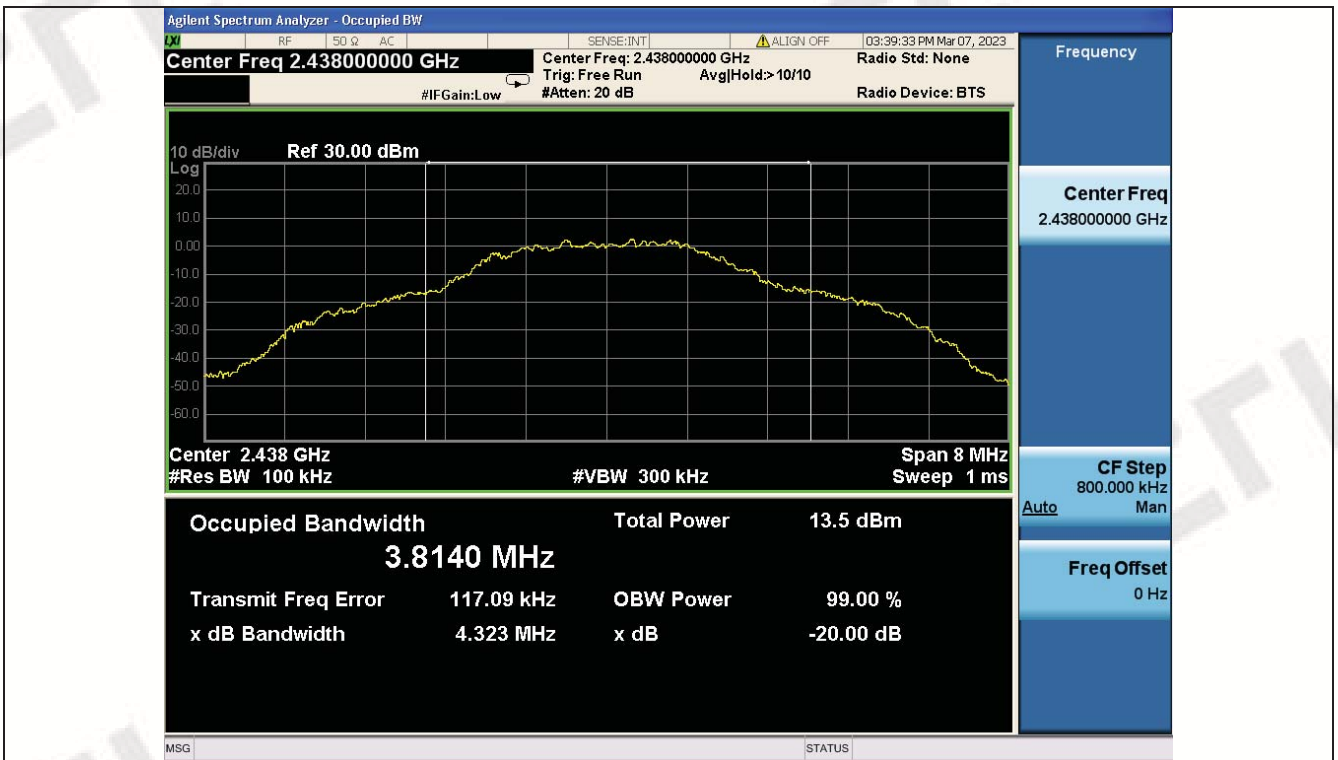

CH09

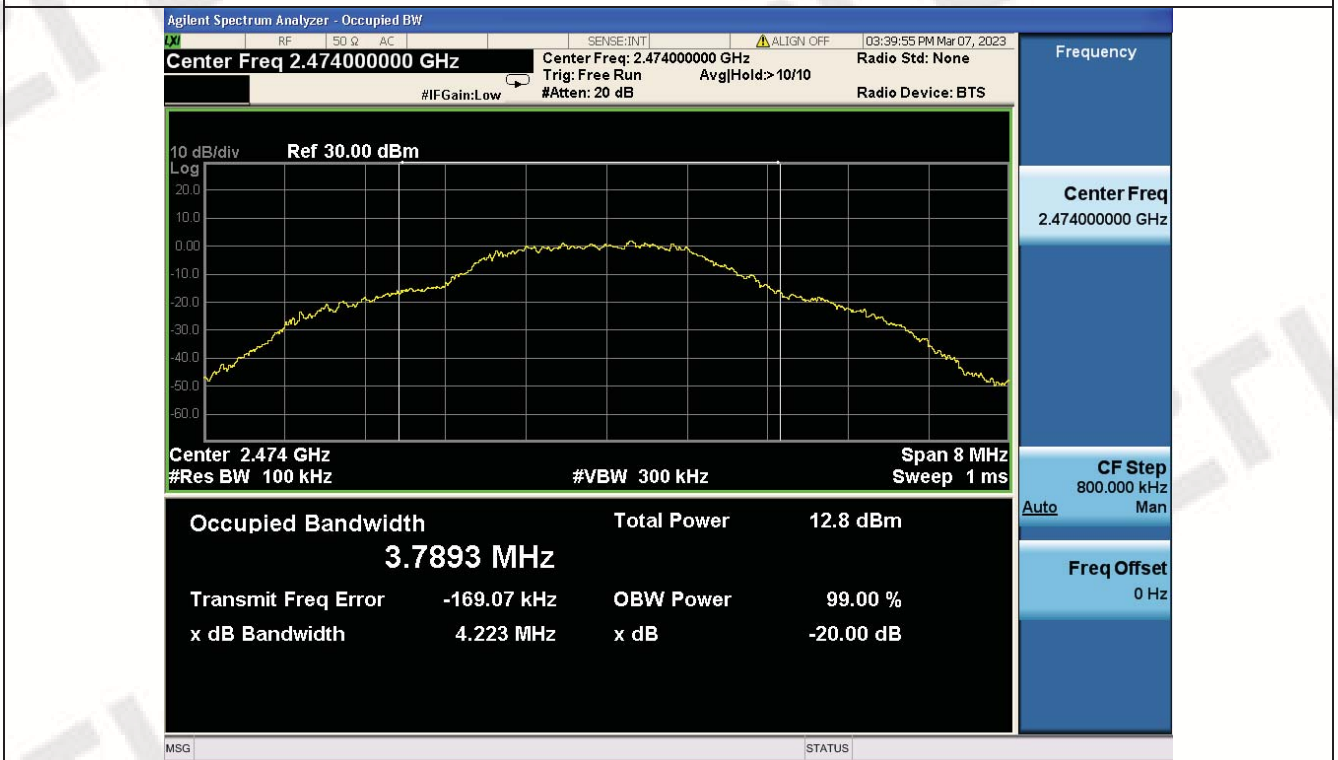

CH18

3.4. Antenna Requirement

Standard Applicable

For intentional device, according to FCC 47 CFR Section 15.203, an intentional radiator shall be designed to ensure that no antenna other than that furnished by the responsible party shall be used with the device.

Refer to statement below for compliance.

The manufacturer may design the unit so that the user can replace a broken antenna, but the use of a standard antenna jack or electrical connector is prohibited. Further, this requirement does not apply to intentional radiators that must be professionally installed.

Antenna Connected Construction

The antenna used in this product is a Internal Antenna, The directional gains of antenna used for transmitting is 2.00dBi.

4. Test Setup Photos of the EUT

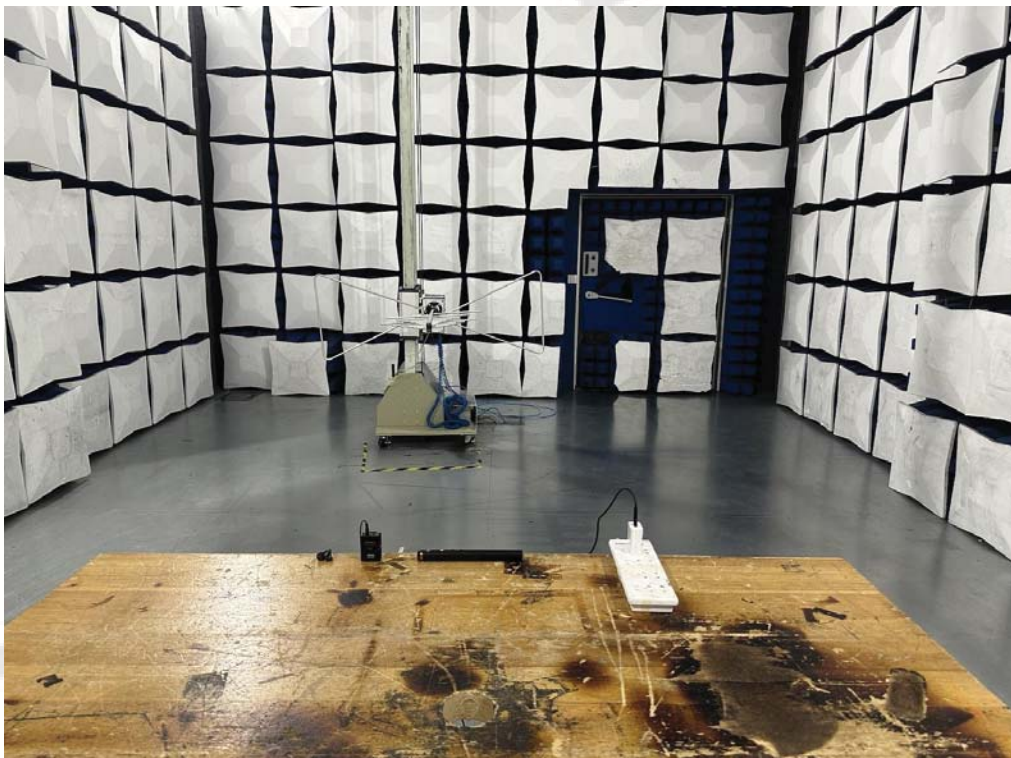



5. External and Internal Photos of the EUT

External Photos of EUT

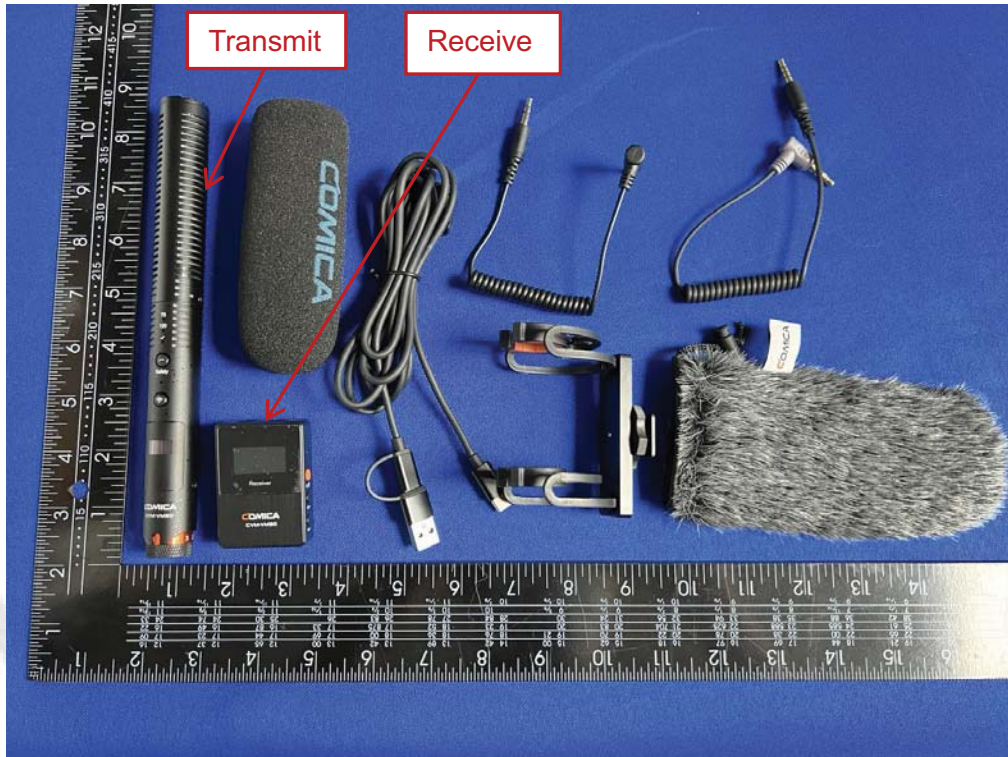

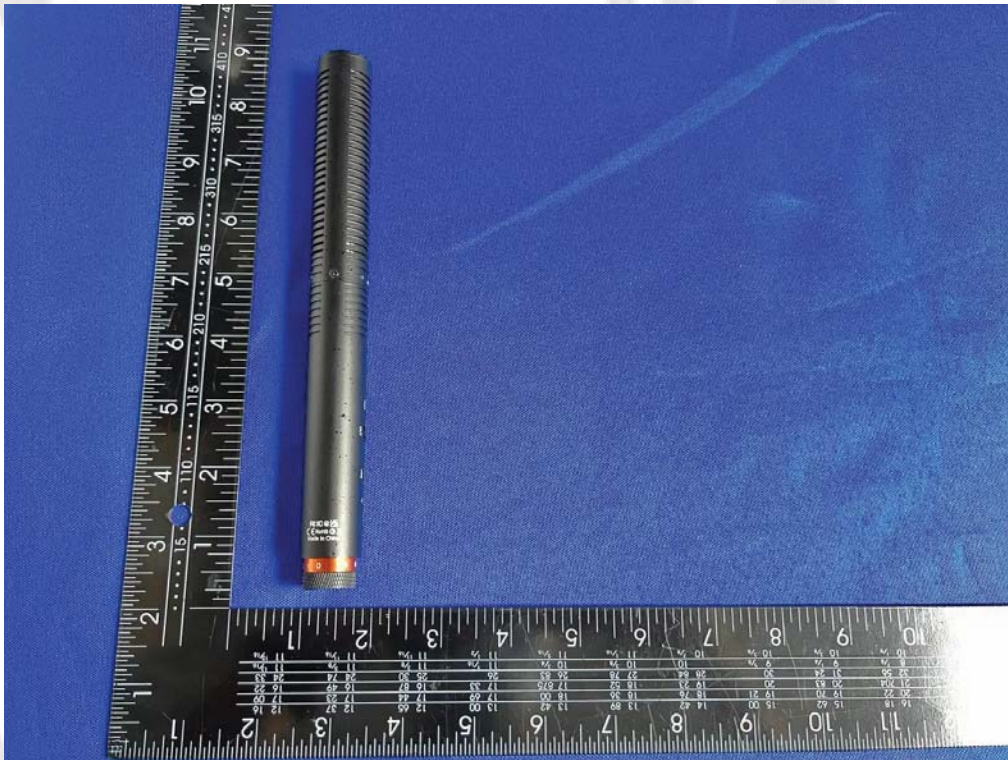



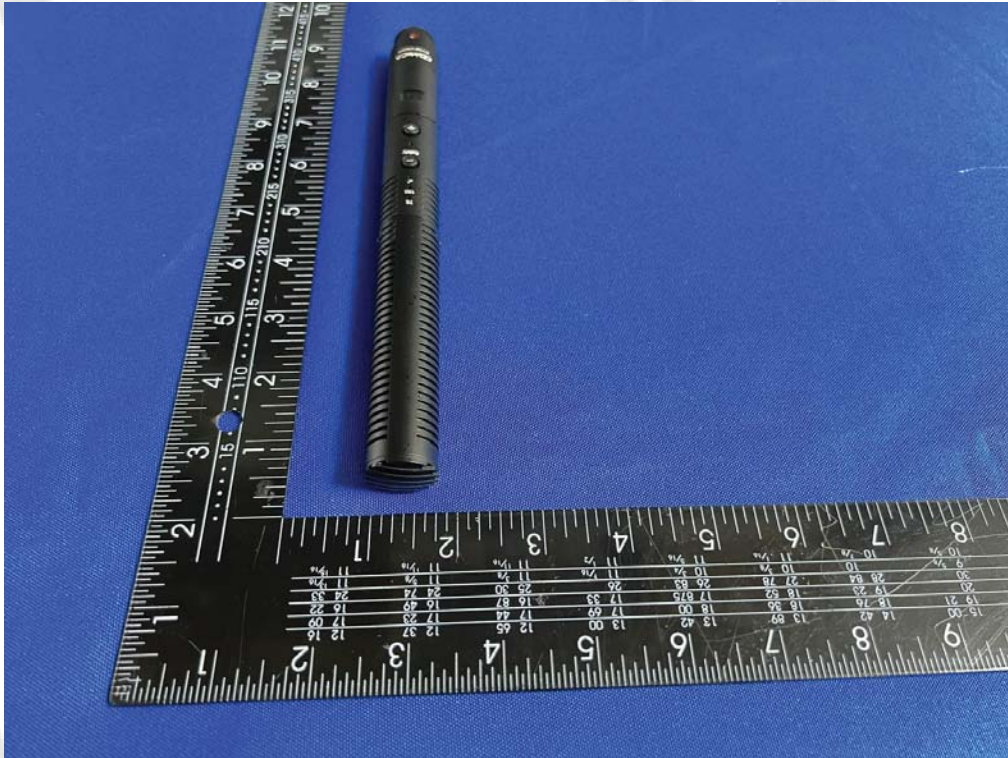

Internal Photos of EUT

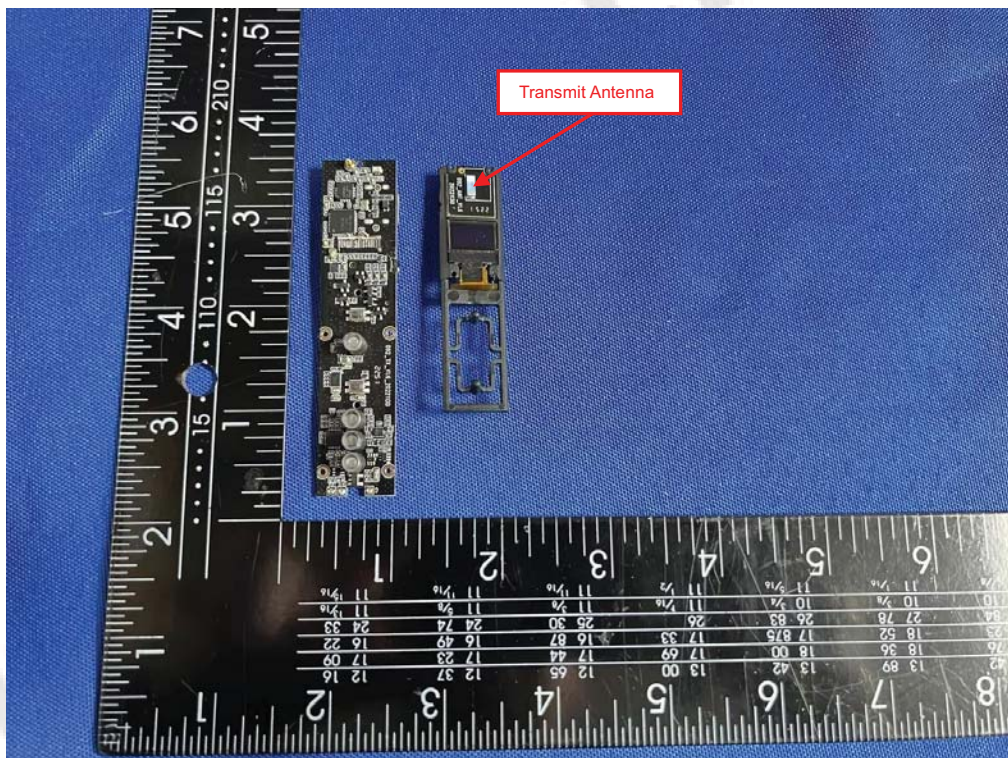

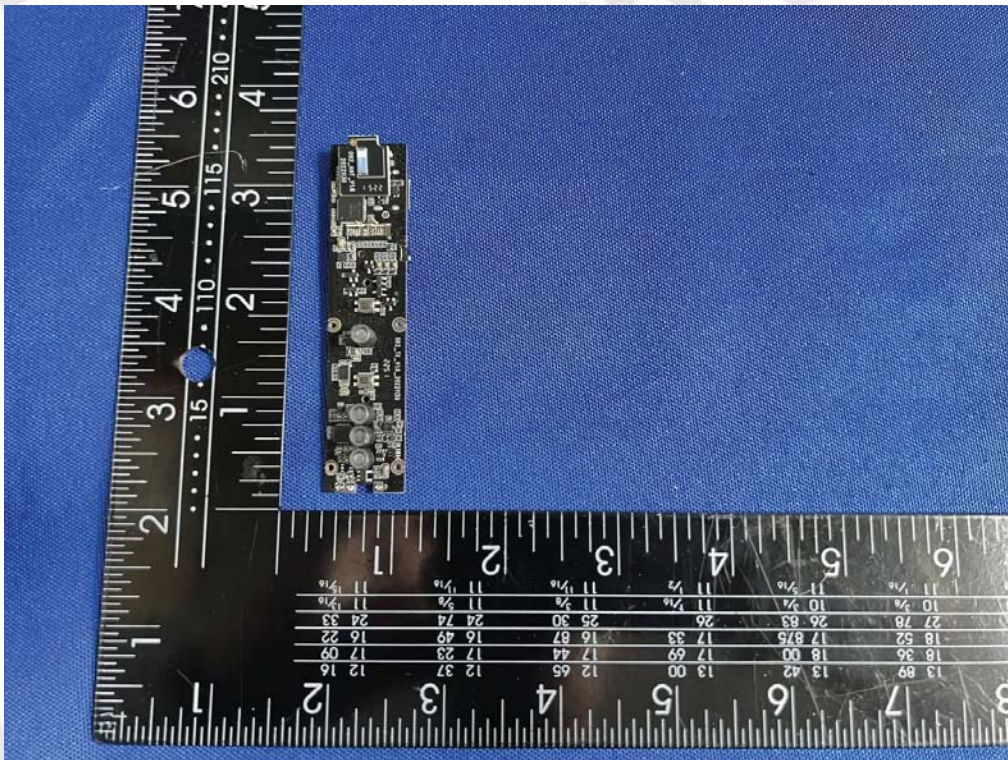
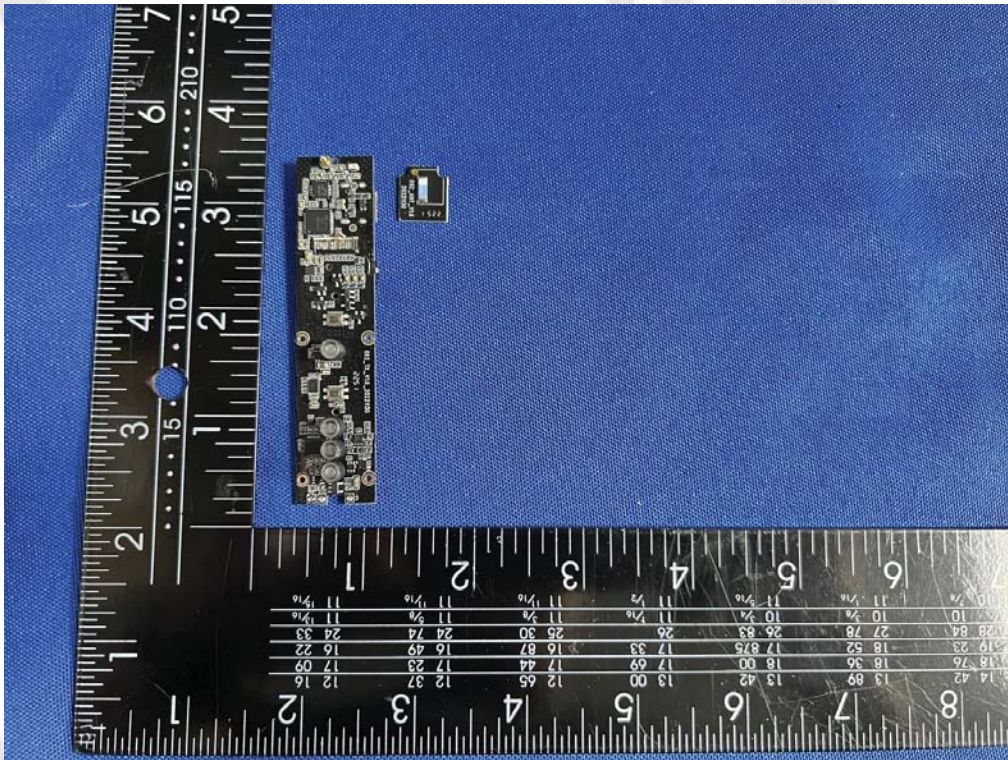

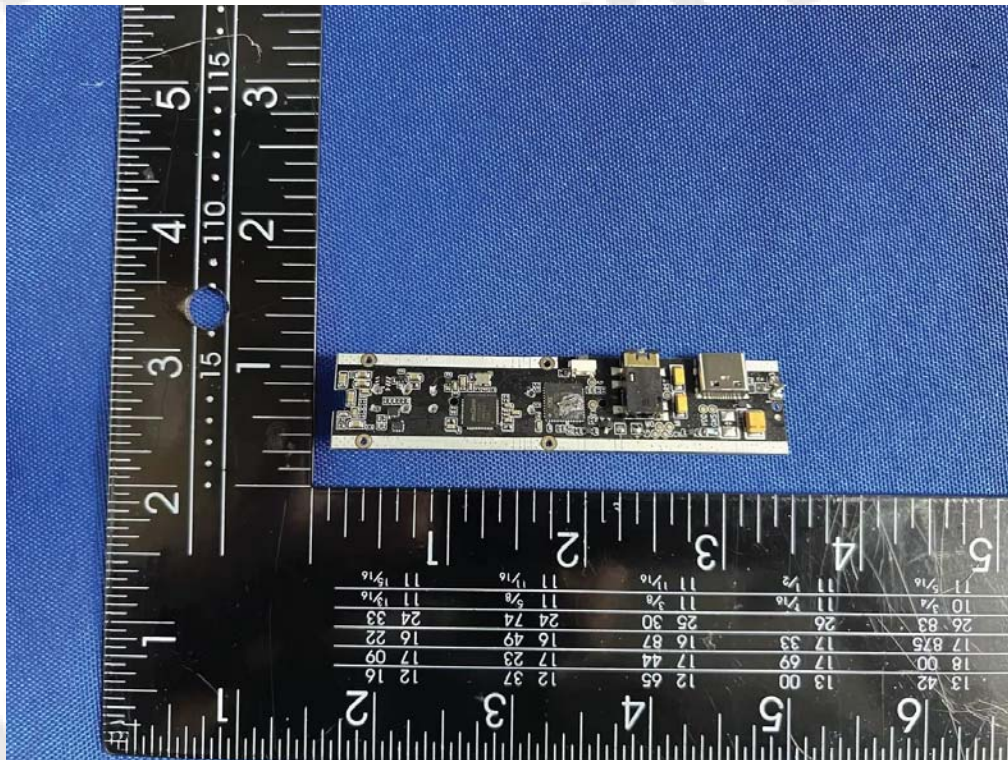
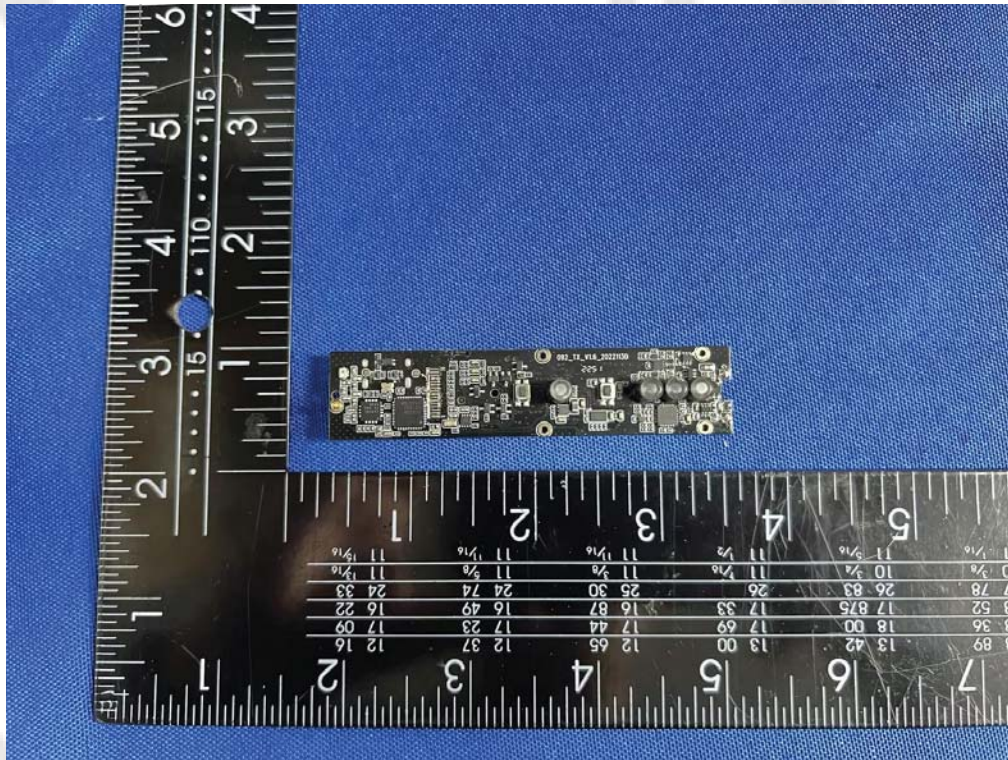

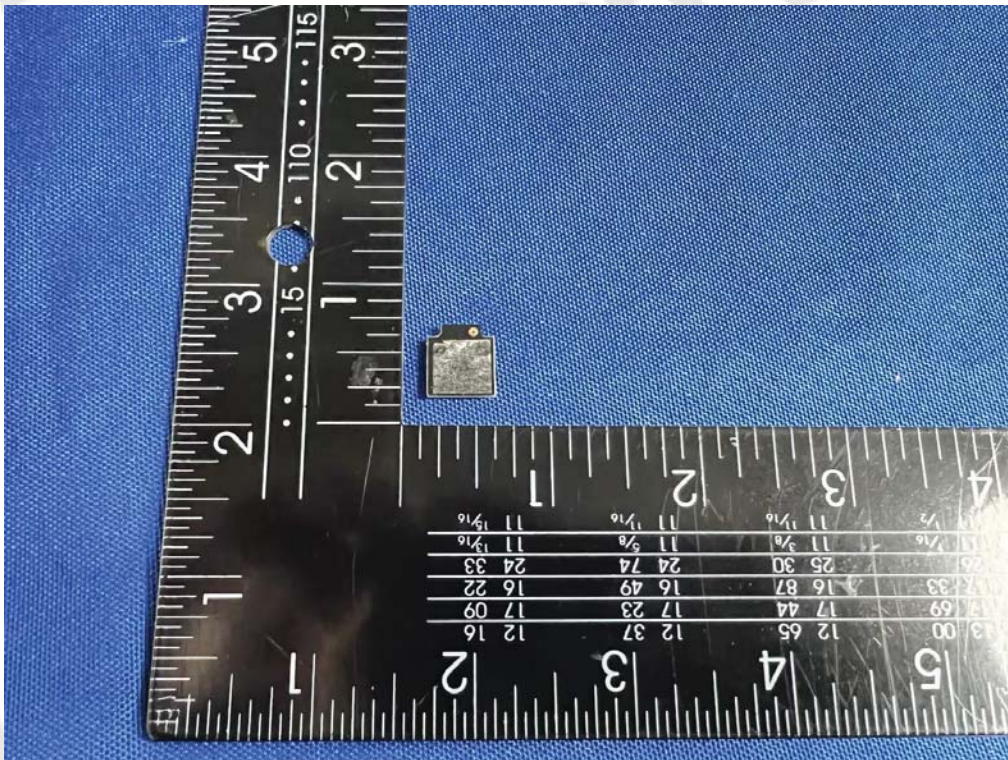
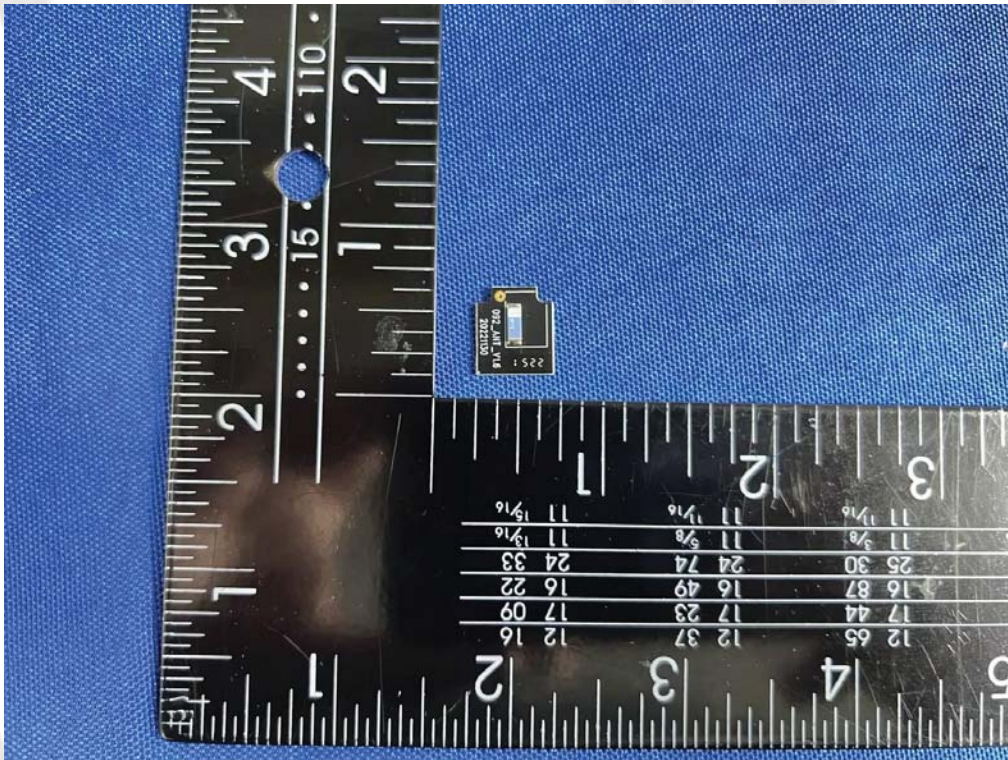



***** End of Report *****