

AIRROBO

Scan this QR code for  
step-by-step videos



# Robot Vacuum Cleaner **T20+** **T20Plus**

LDS Laser Navigation & Automatic Dirt Disposal

## User Manual

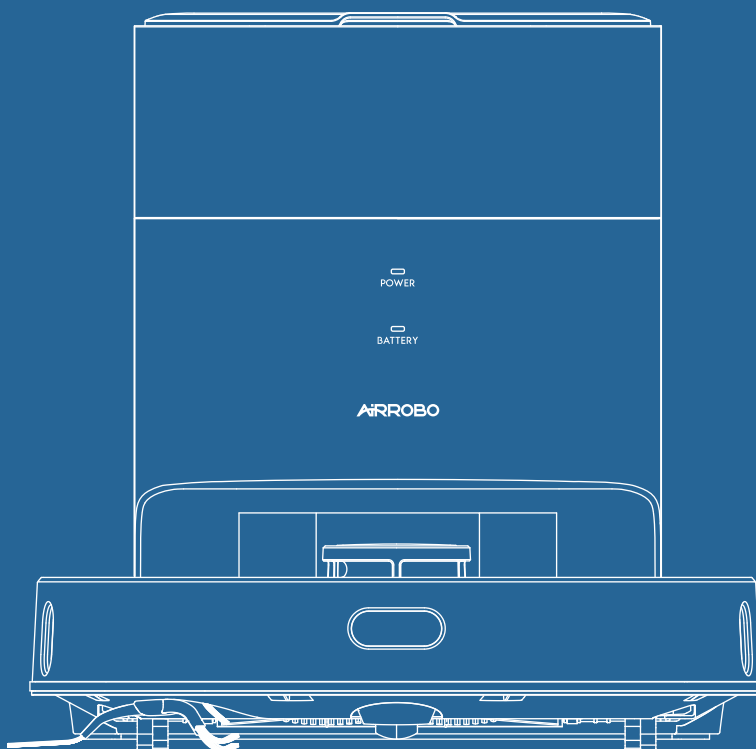

AIRROBO is a smart home appliance brand with a focus on AI-enabled technologies. Supported by a world-leading enterprise in humanoid robotics field, AIRROBO is aiming to bring the most cutting-edge technology to more and more households around the globe, making smart home a new norm of life. Please read this manual carefully before using the product and store it properly.

Customer Service: [support.airrobo@ubtrobot.com](mailto:support.airrobo@ubtrobot.com)

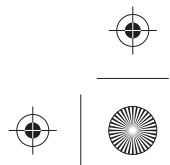
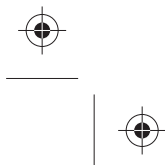
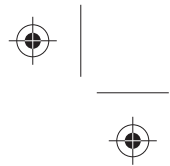
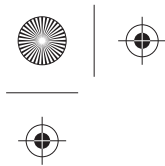

Thank you for purchasing **AIRROBO ROBOT VACUUM CLEANER**.

- It is strongly recommended to read the user manual comprehensively, including proper use, safety information and maintenance instructions for the AIRROBO robot before using it.
- The user manual offers instructions only. If any other situations that you encounter are not addressed in this user manual, please contact our customer service at [support.airrobo@ubtrobot.com](mailto:support.airrobo@ubtrobot.com) for product technical support.
- This user manual will be updated upon new software or hardware updates. Content and images will be updated without further notice.

EN

## Part 1 Safety Information

### 1.1 Precautions

- This product should only be used for floor cleaning at home. Do not use it outdoors (such as in an open yard), on non-floor surface (such as on a sofa), or in a commercial or industrial environment.
- Do not use it in a suspended environment without any protective barriers, such as duplex floors, open balconies, or on top of furniture.
- Do not use the robot in a wet or damp environment.
- Do not use or charge it in an environment where the temperature is higher than 40°C, lower than 0°C, or where there is any liquid or sticky material on the ground.
- Please pick up all cables on the floor before using them to avoid getting tangled.
- Please pick up all fragile objects, such as vases and plastic bags to prevent collisions or damaging valuable belongings.
- This appliance can be used by children aged from 8 years and above and persons with reduced physical, sensory or mental capabilities or lack of experience and knowledge if they have been given supervision or instruction concerning use of the appliance in a safe way and understand the hazards involved.
- Cleaning and user maintenance shall not be made by children without supervision.
- If the supply cord is damaged, it must be replaced by the manufacturer, its service agent or similarly qualified persons in order to avoid a hazard.
- Children should be supervised to ensure that they do not play with the appliance.
- Do not attempt to disassemble, repair, modify or replace any part of your product. All servicing should be performed by qualified personnel only. There are no userserviceable parts inside. Please contact us when you need repair services.
- Dispose of all packaging materials properly. Keep away from children and pets.
- Do not place the cleaning brush where children can reach it.
- Beware of the suction: hair and fingers might get sucked. Please keep a safe distance.
- Do not use the product to pick up any burning objects, such as unextinguished cigarette butts.
- Do not let the product pick up any sharp objects such as glass pieces and nails.
- Do not grab the protective cover of the radar or the bumper as a handle to carry.
- To clean or maintain the robot, dustbin and charging base, please turn them off first, unplug them from the socket, and disconnect the power supply. The robot and 2-in-1 dustbin cannot be soaked in water.
- Do not use wet cloth with any kind of detergent to wipe any parts of the robot.
- Do not mop on carpets. Before mopping the floor, please set up restricted area in the APP to avoid damping the carpets.
- Please use this product in compliance with the instructions in the manual.
- CAUTION: In order to avoid a hazard due to inadvertent resetting of the thermal cut-out, this appliance must not be supplied through an external switching device, such as a timer, or connected to a circuit that is regularly switched on and off by the utility.



Before charging, read the instructions.



For indoor use.

### 1.2 Battery and Charging

- It is forbidden to incinerate the product. Even if it is severely damaged the battery may explode.
- This appliance may only be charged with the charging base (Model: T20-01) supplied with the appliance. Do not use any third-party charging bases.
- Do not disassemble, repair, or modify the battery and charging base.
- Do not place the charging base near a heat source, such as a heater.
- Do not wipe or clean the charging base with wet cloth or your hands.
- Do not throw away old batteries. The disposal of old batteries should be handled by a professional recycling agency.
- Please make sure the robot is turned off and it's recommended to use the original packaging during transportation.
- If unused for an extended period, please turn the robot off after having fully charged it and store it in a cool and dry place.
- Charge the robot at least once every three months to avoid damage to the battery due to excessive discharge.
- Use the right tool to take out the battery when needed. The power supply must be disconnected when removing the battery. First, remove the bottom cover screw, then open the bottom cover. Unplug the battery connector, and finally, remove the battery from the battery compartment.
- Before discarding the robot, the battery must be removed. The battery is to be disposed of safely.
- Do not recharging non-rechargeable batteries.
- This appliance contains batteries that are only replaceable by skilled persons.

### 1.3 Laser Safety

- The laser distance measuring sensor of the product complies with the standard of Class 1 laser products of IEC60825 and does not produce dangerous laser radiation.
- The maximum laser output of the product is 10 mW.
- Exposure near the aperture of the radar may cause burns to your eyes.
- Standard: IEC 60825-1:2014.

## Part 2 Product Overview

### 2.1 Packing List

EN

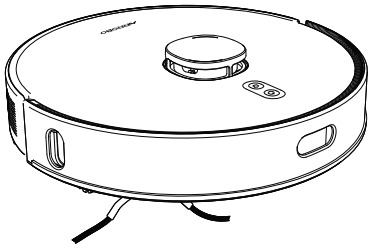

Robot vacuum cleaner  
(Hereinafter referred to as **robot**)

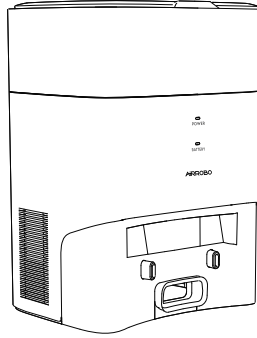

Automatic dirt disposal and charging base  
(Hereinafter referred to as **base** or **charging base**)

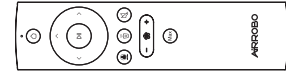

Remote control

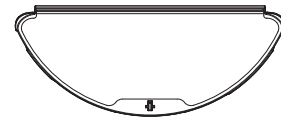

Mopping module

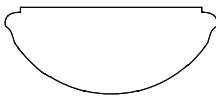

Mopping cloth

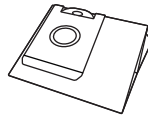

Disposable dust bag

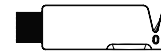

Cleaning brush

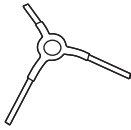

Side brush

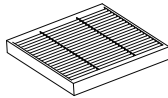

HEPA Filter  
(Hereinafter referred to as **filter**)

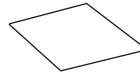

User manual

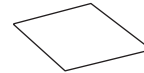

Warranty card

- Accessories installed on the robot

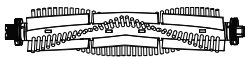

Main brush

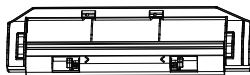

Main brush cover

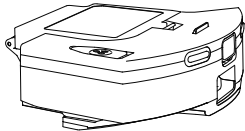

2-in-1 dustbin

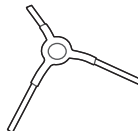

Side brush

- Accessories installed on the charging base

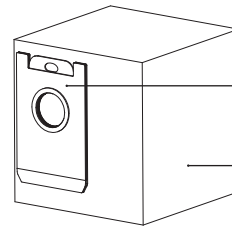

Dust bag handle

Disposable dust bag



\*1 piece of disposable dust bag is installed to the base  
The dust bag is a disposable product and cannot be reused. Please replace it regularly.

#### Reminder:

- The outline sketches of the product, accessories, user interface, etc. in the manual are for reference only.

## 2.2 Product Appearance

### • Buttons

<p> <b>Power Button</b> Press it to start <b>Auto Cleaning/Pause Cleaning</b>. Press it and hold for 3 seconds to turn robot on or off.</p>	<p> <b>Home Button</b> Press it and hold for 3 seconds to start <b>Local Cleaning</b>, in which mode the robot will clean a four-square-meter area centered on itself.</p>
--------------------------------------------------------------------------------------------------------------------------------------------------------------------------------------------------------------------------------------	-------------------------------------------------------------------------------------------------------------------------------------------------------------------------------------------------------------------------------------------------------------------------

EN

**Reminder:** When the robot is moving, you can press **any button** to pause it.

### • Robot Vacuum Cleaner

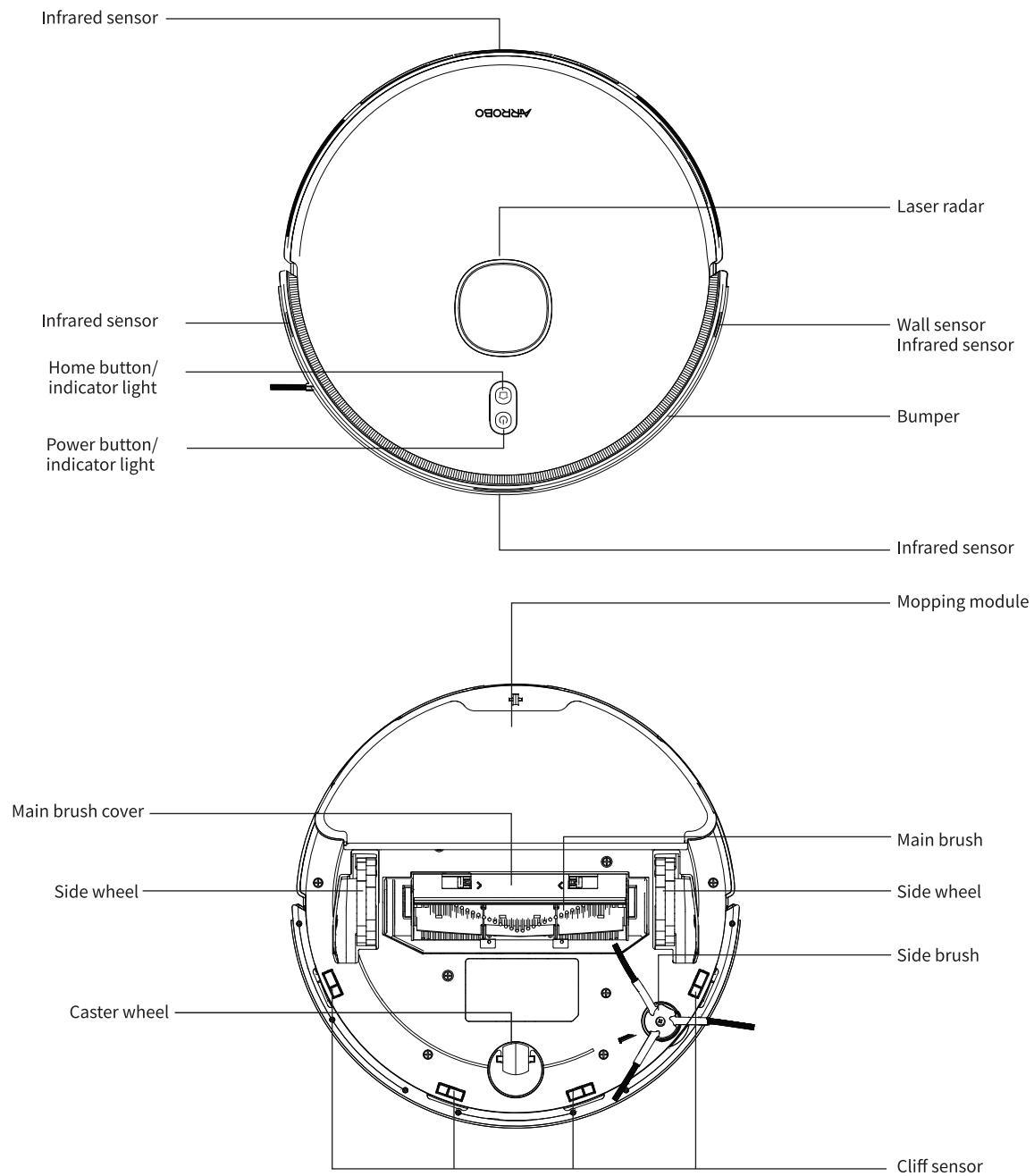

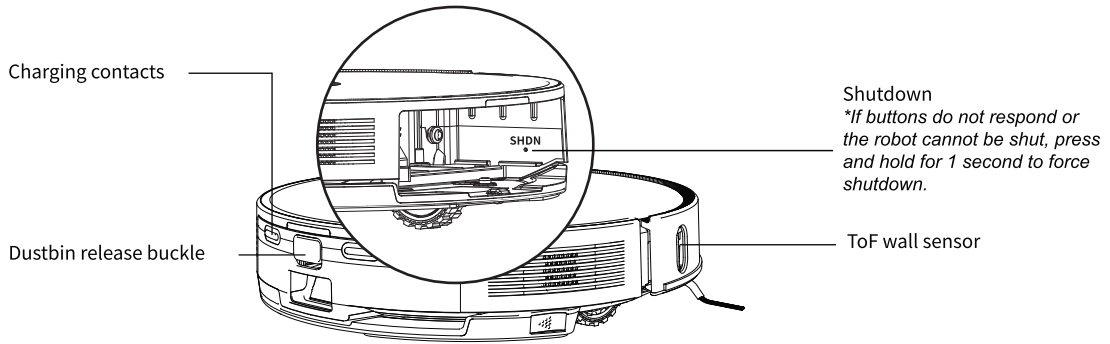

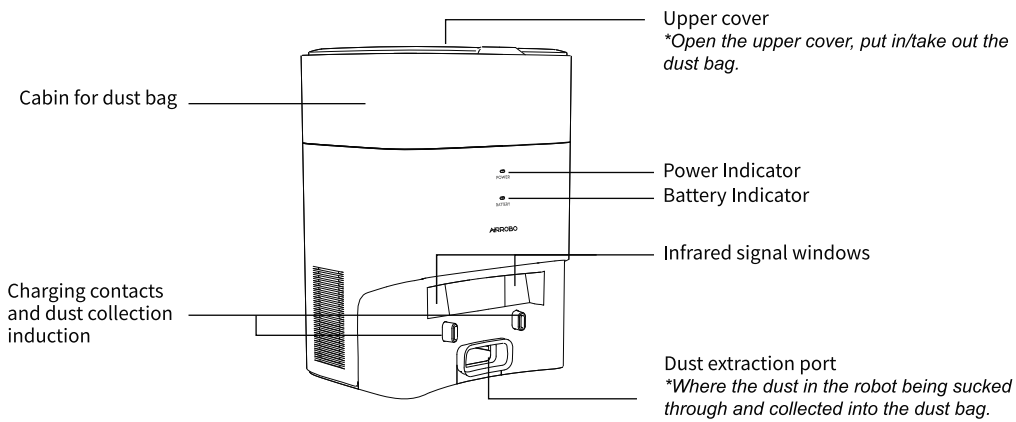

• Automatic dirt disposal and charging base





• Description of the base indicator lights

No.	Power Indicator 		Battery Indicator 	
1	OFF	Base not engaged	OFF	Robot is not on the base charging
2	White ON	Base engaged	White ON	Battery fully charged
3	White Breathing	/	White Breathing	Charging (Battery level $\geq 80\%$ )
4	Orange flashing	Abnormal (the specific fault types, please refer to the voice played by robot)	Orange flashing	/
5	Orange Breathing	/	Orange Breathing	Charging (Battery level $< 80\%$ )
6	OFF	Idle for more than 60 seconds	OFF	Idle for more than 60 seconds

**Reminder:**

The dust bag is a consumable item and needs to be purchased from the official distribution channels.

• Description of the robot indicator lights

No.	Robot Status	Power indicator  and Home indicator 
1	Charging	White Breathes (Battery level $\geq 30\%$ ) Orange Breathes (Battery level $< 30\%$ ) White ON (Battery fully charged)
2	Cleaning / Standby / Wi-Fi connected	White ON
3	Returning to base	White Breathes
4	Abnormal	Orange Flashes
5	Wi-Fi not connected	Orange Breathes
6	Network configurating/Updating	Blue Flashes

## • Remote Control

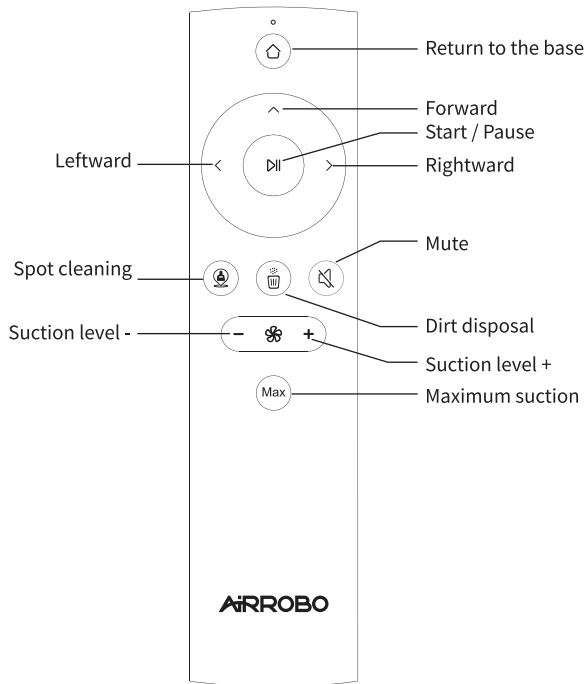

## Remote Control Buttons

- Press to pause cleaning; press it again to resume.
- Press to adjust the direction of the robot.
- During the cleaning, press to return to the charging base.
- Press to start the spot cleaning mode, in which the robot will clean a four-square-meter area centered on itself.
- When you press , the base sucks the dirt out of the robot and stores it in the disposable dust bag. (only available when the robot is charging at base)
- Press to adjust the level of suction power.
- Press to adjust to the maximum level of the suction power of the robot.

### Note:

- Before using, install two AAA batteries in the remote control, making sure that the positive and negative ends follow the markings indicated in the battery compartment.
- When the robot is not connected to a Wi-Fi network, you can still operate it with the remote control.
- When the robot is on the charging base, it will back off a short distance if any direction button on the remote control is pressed. After that, you can operate it normally.
- Remove the batteries from the remote control if you will not use it for a long time.
- Non-rechargeable batteries are not to be recharged.
- Different types of batteries or new and used batteries are not to be mixed.
- Batteries are to be inserted with the correct polarity.
- Exhausted batteries are to be removed from the appliance and safely disposed.
- The supply terminals are not to be short-circuited.

## Part 3 Installation and Operation

### 3.1 Installation

#### 1. Remove the bumper stopper

- Place the robot on a flat floor and remove the bumper stopper plugged at both ends of the front bumper.

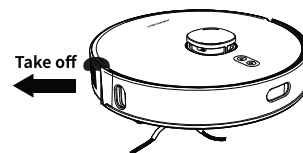

#### 2. Install the base

- Place the base against the wall on a flat floor, insert the power plug into a socket that meets the national standards requirements and then turn on the power.
- Ensure that there are no obstacles within 1.2 meters (4 feet) in front and 0.5 meters (1.6 feet) from either side.

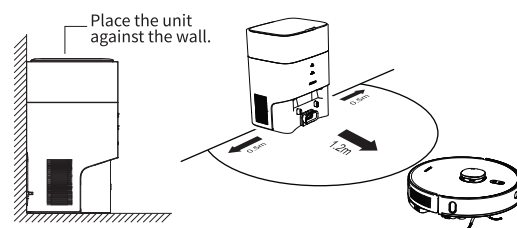

#### 3. Charge the robot

- Press and hold the for 3 seconds to turn on the robot, and then press the to make the robot automatically align to charge.
- Make sure that the charging contact points are dry before charging. Please get the robot fully charged before operating.
- Please pick up the **cables**, **lightweight** and **fragile objects** on the floor before cleaning to avoid damage caused by entangling, dragging, and colliding during cleaning.
- It is recommended to start cleaning from the base so as to remember the location of the base when building the map, and it is efficient to find the base when returning to the base.
- When the battery runs low during cleaning, the robot will automatically return to the base to charge and continue cleaning from its breakpoint once the battery is restored to 80% battery level.
- Or you can manually push the robot aligning to charge.

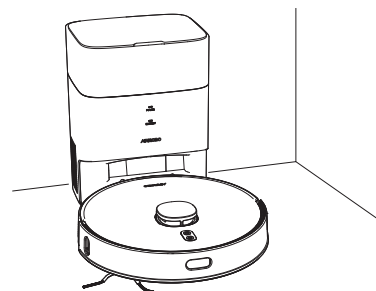

## 3.2 Operation

EN

### 1. Preparation

**Step1:** First ensure that the RF band of your Wi-Fi network is 2.4GHz. In particular, 5GHz is not supported.

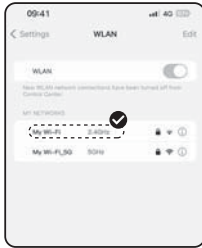

**Step2:** Ensure your phone have connected to your 2.4GHz Wi-Fi and the Bluetooth of your phone should be ON.

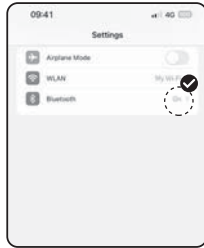

**Step3:** Scan the QR code or search AIRROBO in Apple Store or Google Play to download the APP. Register and log in the AIRROBO APP.



**Step4:** Press and hold the  for 3 seconds to start the robot. Or you can charge the robot on the base to start it automatically. Ensure your phone and the robot are right within the signal range—not more than 3 meters the better.

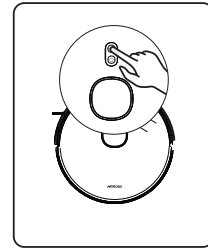

### 2. Network configuration/Pairing

**Step1:** Click [Add device] or [+] to add the robot, which will pop out in the Add Device Page or the front page automatically.

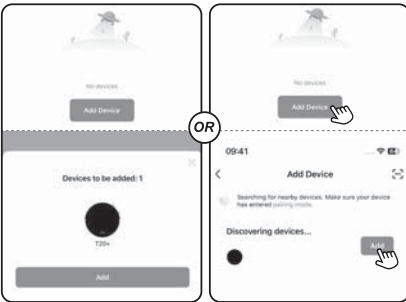

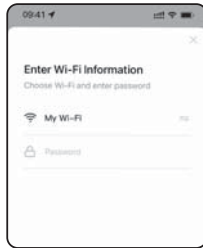

**Step2:** Enter your Wi-Fi password. Besides, if your phone has connected to your Wi-Fi already, the Wi-Fi name will automatically be input.

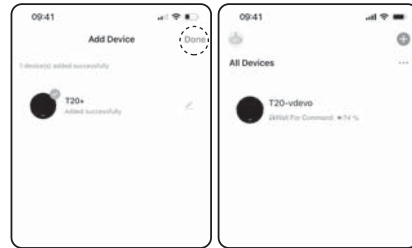

**Step3:** Added successfully! Click [Done] to enter the next step. Now you can operate the robot through the APP.





#### Tips:

1. Due to the update of the APP, these pages maybe slightly different. Please follow the current in-app guides while using.
2. If your robot is unable to be found or has timed out for several times, please do as follows before trying again. Ensure that the phone does not disable Nearby Devices and that the router is not in whitelist mode. Reset Wi-Fi to the robot: Press and hold  +  for 3 seconds when the robot is ON. Then clear the APP case: Me - Settings - Clear Cache.
3. The APP is currently not compatible with Android tablets and iPads.
4. To use the APP properly, please turn on the Basic Google Services if you are using an Android phone.

#### Reminder:

- Due to the regular upgrade and update of the APP, the actual operation might be slightly different from the above description. Please follow the instructions in the current APP.
- If you want to connect to Alexa, click "Alexa" and follow the prompts.

### 3. Power on/power off/pause

- The white light will breathe for several seconds while turning on. Then the white light will be on, which means the robot is on standby.
- Press the  to start auto cleaning.
- Press and hold the  for 3 seconds to spot cleaning.
- When is paused, press and hold the  for 3 seconds to turn it off. The white light will quickly flash for several seconds before turning off.
- The robot will enter sleep mode if it pauses for 5 minutes. Press any button or use the remote control to wake it up.

**Reminder:** The robot cannot be shut down, or put on standby during charging.

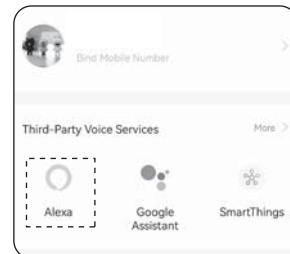



#### 4. Automatic charge/manual charge

- When the battery runs low or cleaning is completed, the robot will automatically return to the charging base.
- Press  when the robot is paused, it will return to the base to charge.

#### 5. Add water or clean the mop during cleaning

- If you want to add water to the tank or clean the mop during cleaning, you should press any button to pause the robot first. Afterwards, you can press the  again to resume cleaning. Not available on waterlogged ground.

#### 6. Fault state

- When the robot fails, a voice prompt will be issued and the light will flash orange. Please refer to **Troubleshooting** for solutions.

EN

## Part 4 Daily Maintenance

### 1. Replace disposable dust bag

When the dust passage is stuck or dust bag is full, the Power Indicator (  ) on the base will flash orange, and a voice prompt will be issued by the robot.

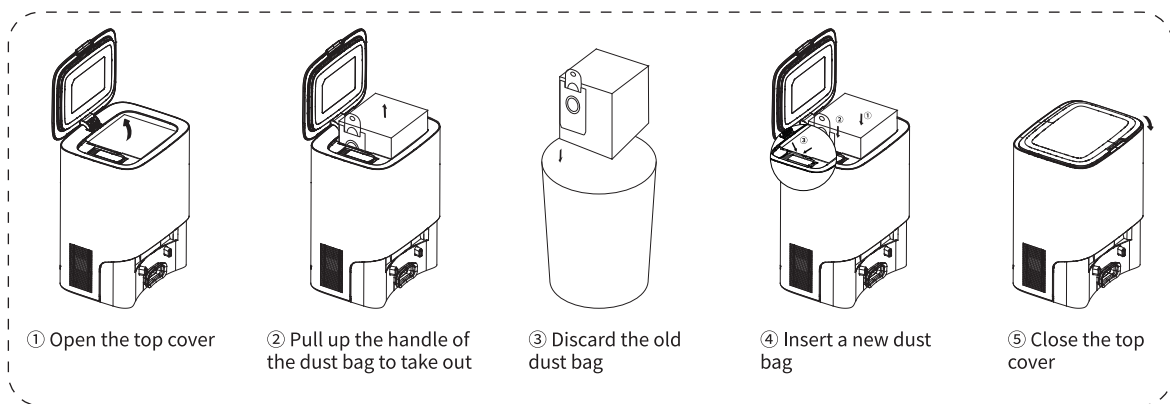

### 2. Clean the dust passage

If the Power Indicator (  ) on the base is still flashing after replacing the dust bag, it is recommended to disconnect power, turn the base upside down, and check whether the dust passage is blocked by any foreign objects. If the dust passage is blocked, refer to the figure below and use a screwdriver to remove the transparent cover of the dust passage and remove foreign objects.

**Note:** Violent dismantling is prohibited. After that, please reassemble it.

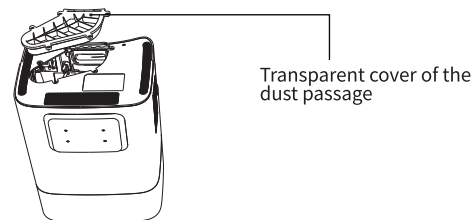

### 3. Clean infrared signal windows/Charging contacts and dust collection induction

Wipe gently with a clean soft, dry cloth. It is recommended to clean once a month.

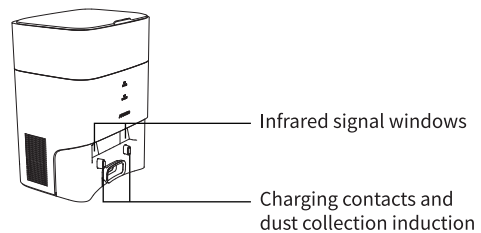

### 4. Clean the fan filter

The fan filter is under the dust bag. If there is dust accumulation, you can wipe with a soft and dry cloth.

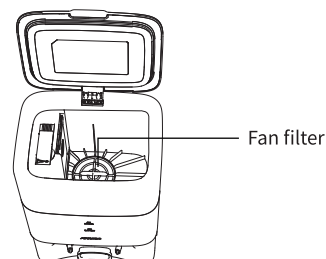

### 5. Clean the main brush

The main brush is a consumable item and should be cleaned at least once a week. It is recommended to replace it every 6-12 months to ensure optimal performance.

① Flip the robot over, press the buckle on the main brush cover and remove the cover first.

**Note:** When placing the robot upside down, please protect the top lidar from damage.

② Use the blade of the cleaning brush to cut entangled hair on the main brush.

③ Replace the main brush and its cover and press to fasten the buckle.

EN

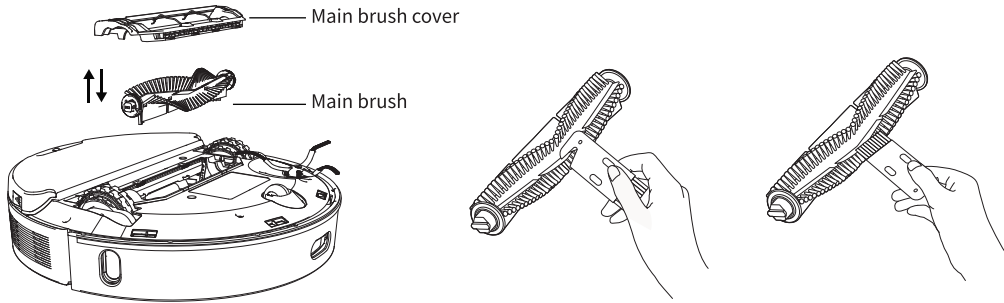

### 6. Clean the side brush

Use a screwdriver to remove the screws on the side brush, then remove the side brush. Re-install the side brush after cleaning or install a new one.

**Reminder:** The side brush is a consumable item. It is recommended to replace it every 3-6 months.



### 7. Clean the sensors

It is recommended to wipe each sensor with a clean soft and dry cloth once a week to ensure the optimal performance.

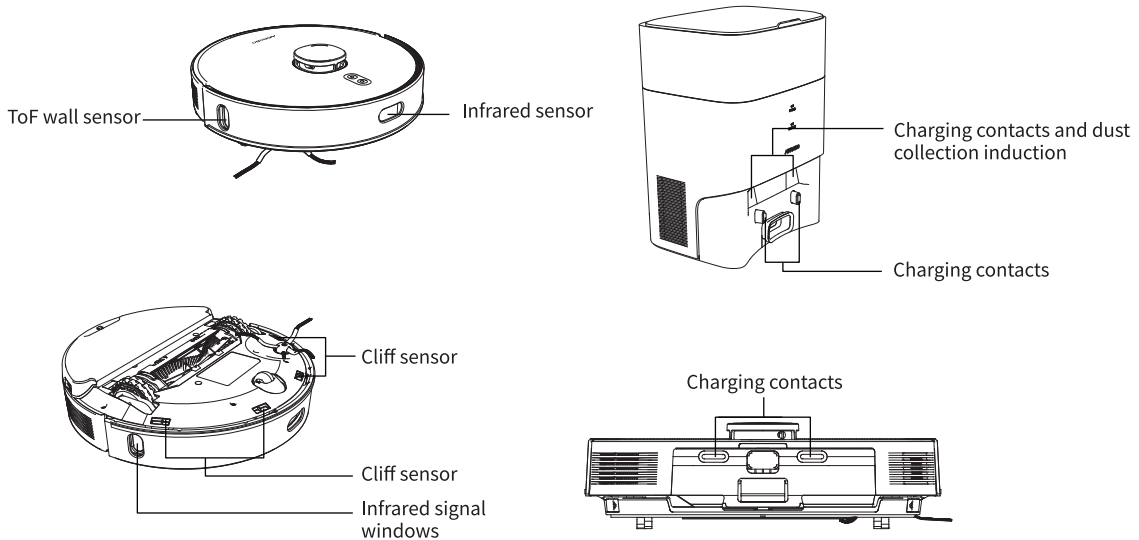

## 8. Battery care

- The robot has a built-in, high-performance, rechargeable lithium-ion battery pack. To maintain battery performance, please keep charging on the base.
- If left unused for a long period, please turn it off for storage and charge it at least once a month to avoid damage to the battery due to over-discharge.
- Never charge the robot at sub-zero temperatures. Due to the characteristics of lithium batteries, charging below zero will cause irreversible damage to the battery.

## 9. Clean the 2-in-1 dustbin

- ① Press and hold the release buckle while pulling it out.
- ② Press the buckle of the dustbin to open it.
- ③ Take out the filter.
- ④ Use the cleaning brush to clean the filter and remove debris.

\* The HEPA filter is a consumable item. It is recommended to replace it every 3-6 weeks. Please purchase replacements from the authorized sellers.

- ⑤ Clean the dustbin.
- ⑥ Open the water tank cover and fill it with the right amount of water. Never add any type of cleaner or disinfectant to the tank to avoid corroding the electronics in it.
- ⑦ Reverse the 2-in-1 dustbin and remove the mop for replacement.

### Reminder:

- The state of the mop affects the mopping effect; please keep the mop clean.
- Always remove the mop to clean and dry it before installing. It is recommended to clean the mop separately from the water tank, otherwise the dirty water will stain the filter.
- The mop is a consumable item; it is recommended to replace it once every 3-6 weeks.

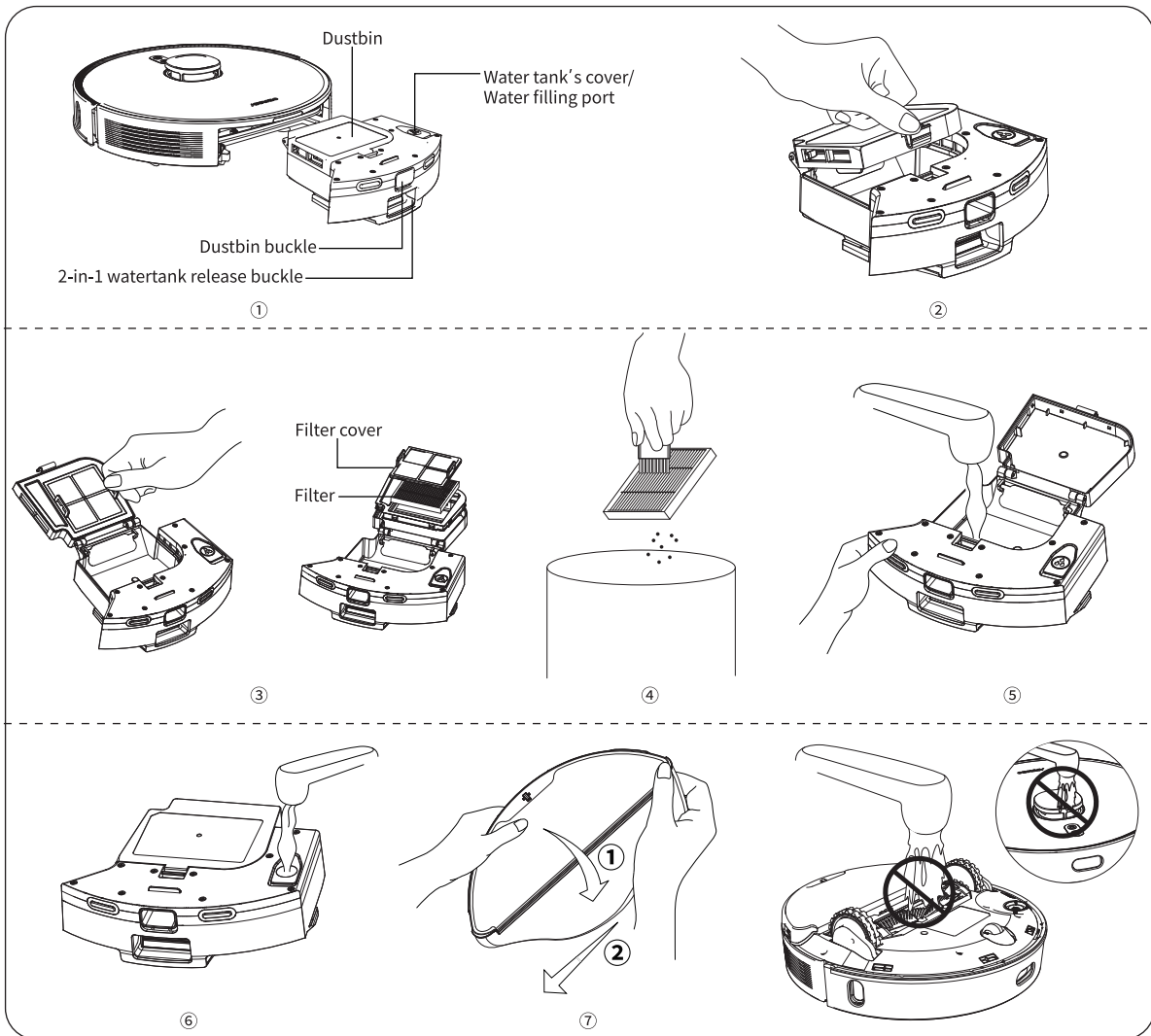

## Part 5 Troubleshooting



The power light flashes orange when the robot is not working properly. It will also play a voice prompt when a fault occurs. Please refer to the instruction sheet below. Besides, if the base encounters problems, please refer to the voice prompts of the robot at the time it has already launched the base. For more information, please check the FAQ in the app.

EN

## Part 6 Basic parameters

### Robot vacuum cleaner

Model	T20+, T20 Plus
Product Size	350×350*100mm
Input	19 V === 1.2 A
Rated power	36 W
Working voltage	14.4 V ===
Wireless connections	Wi-Fi IEEE 802.11b/g/n 2.4 GHz Bluetooth 2402-2480MHz

### Automatic dirt disposal and charging base

Model	T20-01
Product Size	258×210×355mm+
Input	EU/UK: 220 V-230 V ~ 50/60 Hz US/JP: 100 V-120 V ~ 50/60 Hz
Output	19 V === 1.2 A
Rated power	900 W

## Part 7 After-Sales Service

AIRROBO provides a warranty that is processed in the most hassle-free way possible. This policy should be regarded as a standard service policy that covers products sold only by online stores or authorized distributors. Kindly contact us at [support.airrobo@ubtrobot.com](mailto:support.airrobo@ubtrobot.com) with your order receipt or other proof of purchase for confirmation.

### Note:

- Consumables delivered with the product are not covered by the warranty.

### 30 days Money-Back Guarantee for Any Reason:

Products provide a full refund within 30 days from the date the item was delivered to the designated shipping address.

- The returned product must use the original packaging and include all product accessories.
  - For non-quality related warranty claims, the buyer is responsible for shipping costs.
  - Returns may be rejected if the product does not meet the above requirements.
- If the 30-day refund period is exceeded, you cannot request a refund. If it was not purchased online, please contact the authorized distributors.

### Warranty Claims for Quality-Related Issues:

All quality-related defects on items sold directly by online stores or AIRROBO's authorized resellers are covered by an extensive warranty, starting from the date of purchase.

AIRROBO's limited warranty is restricted to the country of purchase.

AIRROBO's warranty is in addition to rights provided under local consumer laws and may vary among countries.

Warranties on all replacements follow the same warranty timeframe as the original defective item.

Warranties are invalid after being fully refunded.

### Process:

- The buyer must provide sufficient proof of purchase.
- AIRROBO must document what happens when buyers troubleshoot the product.
- The defective item's serial number and visible proof depicting the defect are required.
- It may be necessary to return the product for quality inspection.

### The buyer shall bear the freight in the following situations:

- Returning products for any reason other than a proven defect.
- Warranty claims on items taken outside the original country of purchase.
- Returning items claimed to have defects but certified by the AIRROBO Quality Department to function normally.
- Costs associated with unauthorized returns (out-of-warranty returns).

### Not Covered Under Warranty:

- Products without sufficient proof of purchase
- Lost or stolen products
- Items that have expired their warranty period
- Non-quality-related issues (Out-of-warranty returns)
- Products repaired through by third parties
- Damage to the product caused by misuse (including but not limited to falls, extreme temperatures, water, and operating improperly)
- Purchases from unauthorized resellers

When returning items with prepaid shipping, AIRROBO takes responsibility for damage or loss incurred in transit. When returning items for non-quality issues, the buyer takes responsibility for damage or loss incurred in transit. AIRROBO does not provide refunds for shipping damage for non-quality-related warranty claims.

**Ensure the Wi-Fi light on the robot is slowly flashing, then select AP Mode.**

## Part 8 Declaration of Conformity

### 8.1 FCC Compliance Statement

FCC ID:2AZRE-T20

Changes or modifications not expressly approved by the party responsible for compliance could void the user's authority to operate the equipment.

This device complies with Part 15 of the FCC Rules. Operation is subject to the following two conditions:

- (1) this device may not cause harmful interference, and
- (2) this device must accept any interference received, including interference that may cause undesired operation.

This equipment has been tested and found to comply with the limits for a Class B digital device, pursuant to Part 15 of the FCC Rules. These limits are designed to provide reasonable protection against harmful interference in a residential installation. This equipment generates, uses, and can radiate radio frequency energy and, if not installed and used in accordance with the instructions, may cause harmful interference to radio communications.

However, there is no guarantee that interference will not occur in a particular installation. If this equipment does cause harmful interference to radio or television reception, which can be determined by turning the equipment off and on, the user is encouraged to try to correct the interference by one or more of the following measures:

- Reorient or relocate the receiving antenna.
- Increase the separation between the equipment and receiver.
- Connect the equipment into an outlet on a circuit different from that to which the receiver is connected.
- Consult the dealer or an experienced radio/TV technician for help.

### 8.2 FCC Radiation Exposure Statement

This equipment complies with FCC radiation exposure limits set forth for an uncontrolled environment.

This equipment should be installed and operated with a minimum distance of 20 cm between the radiator and your body. This transmitter must not be co-located or operating in conjunction with any other antenna or transmitter.

### 8.3 ISED TO CANADIAN USERS

IC:28477-T20

This device contains licence-exempt transmitter(s)/receiver(s) that comply with Innovation, Science and Economic Development Canada's licence-exempt RSS(s).

Operation is subject to the following two conditions:

- (1) This device may not cause interference.
- (2) This device must accept any interference, including interference that may cause undesired operation of the device.

This Class B digital apparatus complies with Canadian ICES - 003.

This device complies with RSS - 247 of ISED. Operation is subject to the condition that this device does not cause harmful interference.

L'émetteur/récepteur exempt de licence contenu dans le présent appareil est conforme aux CNR d'Innovation, Sciences et Développement économique Canada applicables aux appareils radio exempts de licence. L'exploitation est autorisée aux deux conditions suivantes :

- (1) L'appareil ne doit pas produire de brouillage;
- (2) L'appareil doit accepter tout brouillage radioélectrique subi, même si le brouillage est susceptible d'en compromettre le fonctionnement.

Cet appareil numérique de la Classe B conforme à la norme NMB - 003 du Canada.

Cet appareil est conforme à la norme RSS - 247 d'ISED. Le fonctionnement est soumis à la condition que cet appareil ne provoque pas d'interférences nuisibles.

### 8.4 IC Radiation Exposure Statement

This equipment complies with IC radiation exposure limits set forth for an uncontrolled environment. This equipment should be installed and operated with minimum distance of 20 cm between the radiator and your body. This transmitter must not be co-located or operating in conjunction with any other antenna or transmitter.

Cet équipement est conforme aux limites d'exposition aux rayonnements de la IC établies pour un environnement non contrôlé. Cet équipement doit être installé et fonctionner à au moins 20 cm de distance d'un radiateur ou de votre corps. Cet émetteur ne doit pas être co-localisé ou fonctionner en conjonction avec une autre antenne ou un autre émetteur.

EN

### 8.5 WEEE Disposal and Recycling Information



All products bearing this symbol are waste electrical and electronic equipment (WEEE as in directive 2012/19/EU) which should not be mixed with unsorted household waste. Instead, you should protect human health and the environment by handing over your waste equipment to a designated collection point for the recycling of waste electrical and electronic equipment, appointed by the government or local authorities. Correct disposal and recycling will help prevent potential negative consequences to the environment and human health. Please contact the installer or local authorities for more information about the location as well as terms and conditions of such collection points.

### 8.6 EU RF Exposure statement

This equipment should be installed and operated with a minimum distance of 20cm between the radiator & your body. This transmitter must not be co-located or operated in conjunction with any other antenna or transmitter.