

- 1、制造商 (Manufacturer CN) : Dongguan WeCXW Co., Ltd.
- 2、型号 (Model No) : SM-BT702-MAIN PCBA
- 3、天线类型 (Antenna type) : PCB Antenna
- 4、天线尺寸 (Antenna size) : 5.4\*12.3mm
- 5、天线图纸

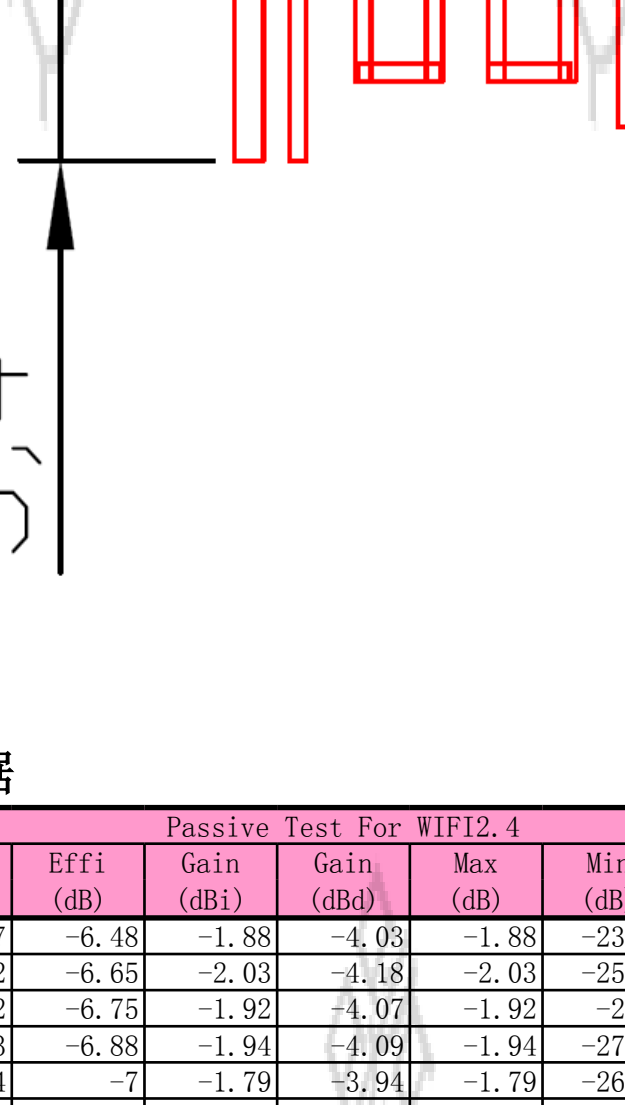

6、无源数据

Freq (MHz)	Effi (%)	Effi (dB)	Gain (dBi)	Passive Test For WIFI2.4				
				Gain (dBd)	Max (dB)	Min (dB)	Attenuat Hor	Attenuat Ver
2400	22.47	-6.48	-1.88	-4.03	-1.88	-23.97	53.28	52.56
2410	21.62	-6.65	-2.03	-4.18	-2.03	-25.42	53.34	52.58
2420	21.12	-6.75	-1.92	-4.07	-1.92	-26.2	53.45	52.63
2430	20.53	-6.88	-1.94	-4.09	-1.94	-27.52	53.33	52.73
2440	19.94	-7	-1.79	-3.94	-1.79	-26.07	53.37	52.78
2450	20.67	-6.85	-1.28	-3.43	-1.28	-26.52	53.46	53.02
2460	19.91	-7.01	-1.41	-3.56	-1.41	-27.63	53.47	52.9
2470	20.26	-6.93	-1.09	-3.24	-1.09	-27.51	53.54	52.93
2480	19.98	-6.99	-1.14	-3.29	-1.14	-27.91	53.54	52.79
2490	19.91	-7.01	-1.04	-3.19	-1.04	-25.31	53.54	52.88
2500	20.52	-6.88	-0.9	-3.05	-0.9	-21.6	53.52	52.85

2400.00MHz - 2500.00MHz Gain

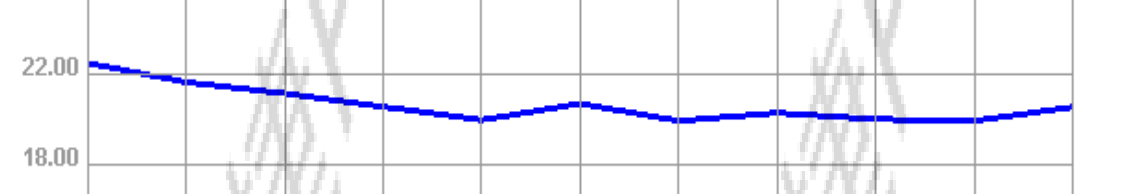

2400.00MHz - 2500.00MHz Efficiency

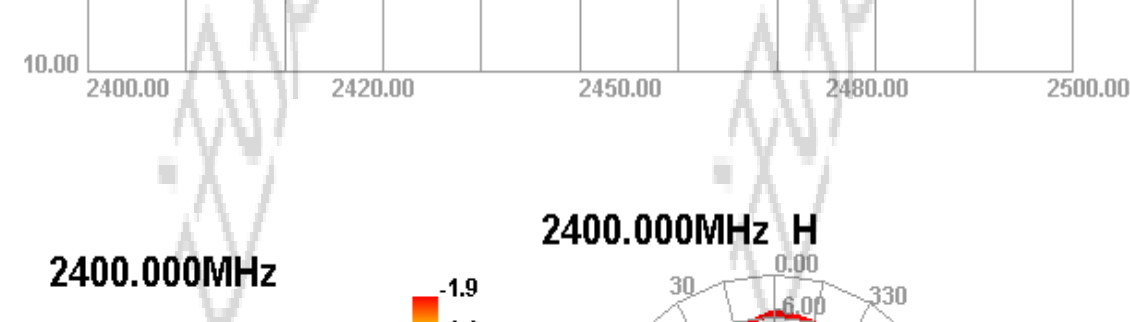

2400.000MHz

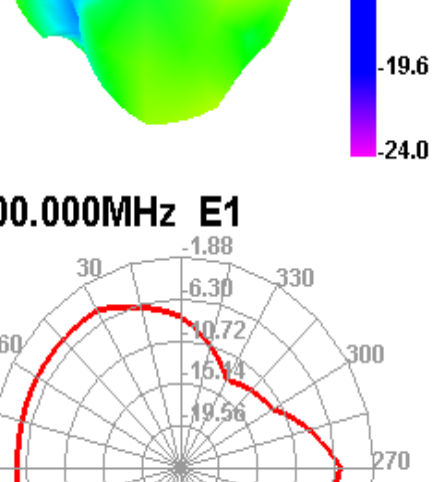

2400.000MHz H

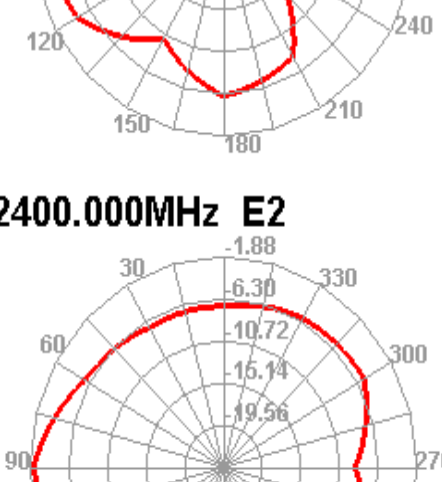

2400.000MHz E1

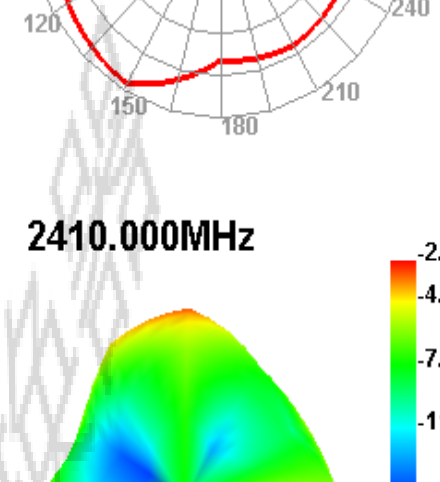

2400.000MHz E2

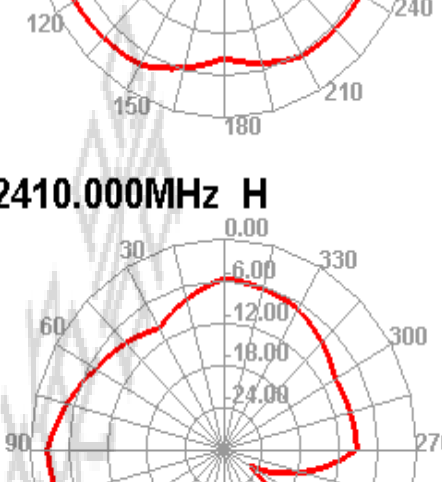

2410.000MHz

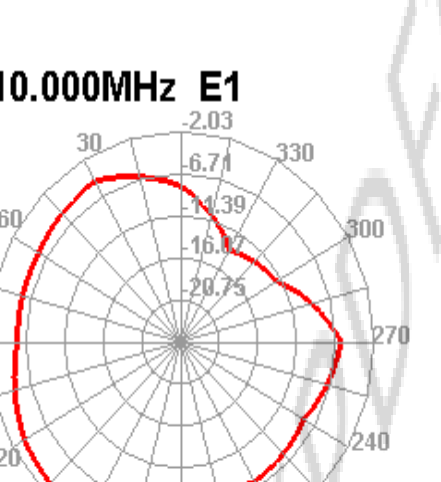

2410.000MHz H

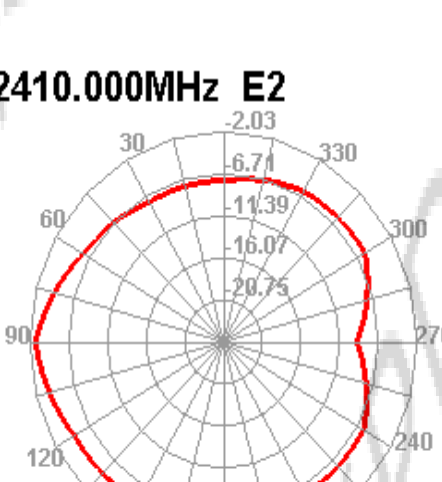

2410.000MHz E1

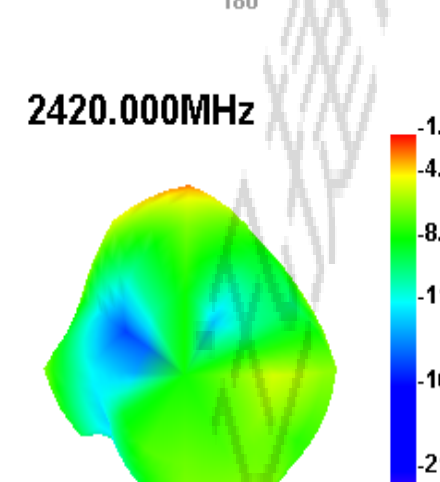

2410.000MHz E2

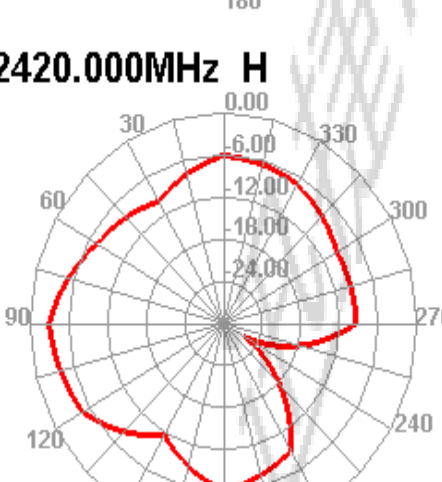

2420.000MHz

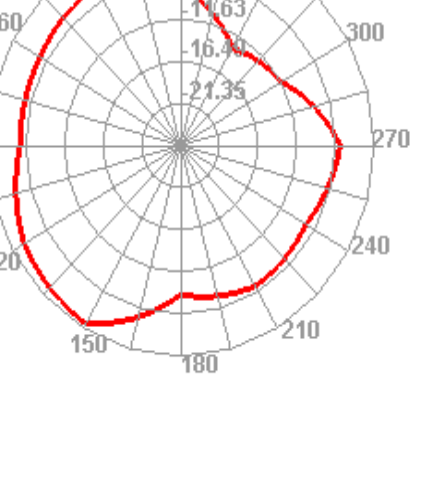

2420.000MHz H

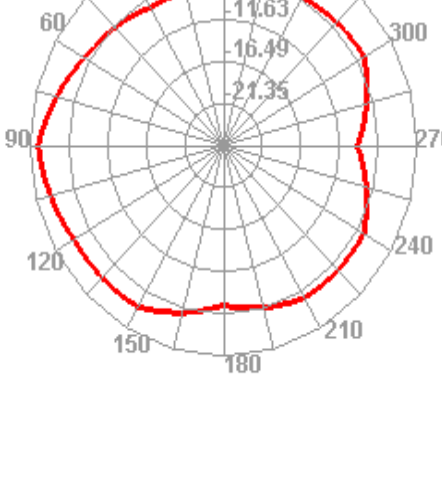

2420.000MHz E1

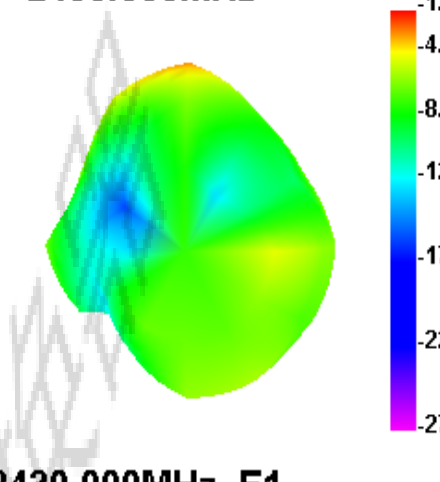

2420.000MHz E2

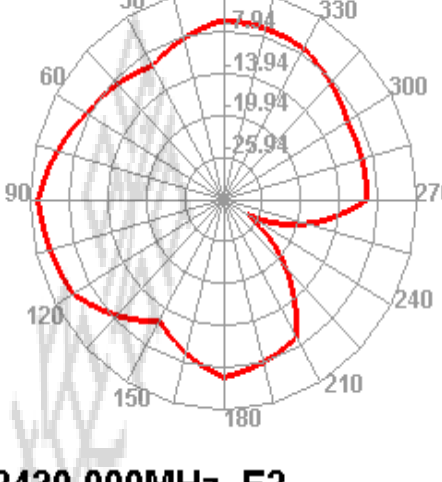

2430.000MHz

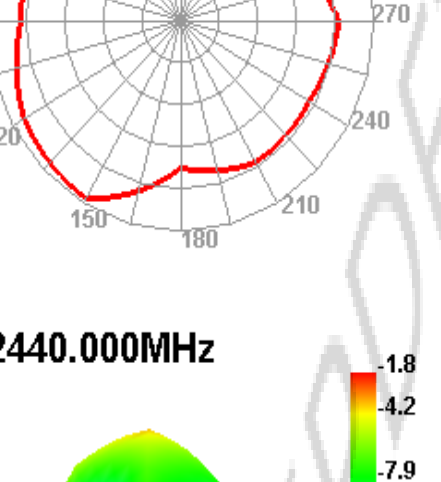

2430.000MHz H

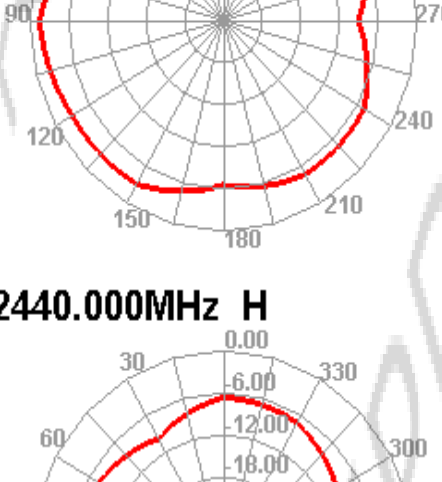

2430.000MHz E1

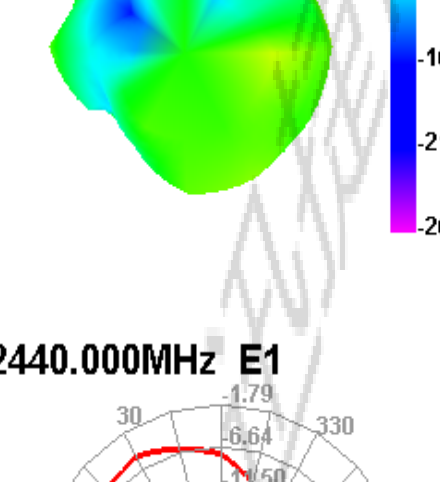

2430.000MHz E2

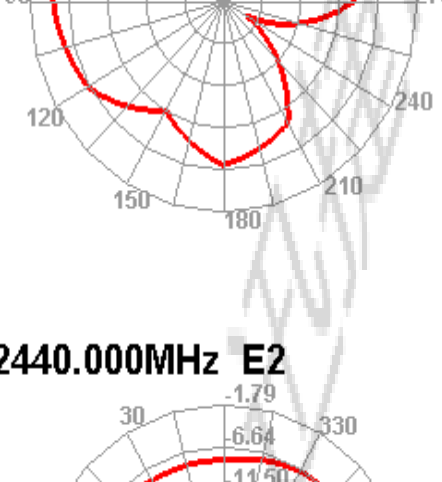

2440.000MHz

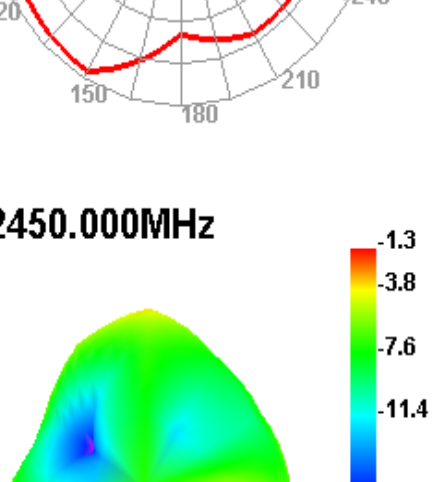

2440.000MHz H

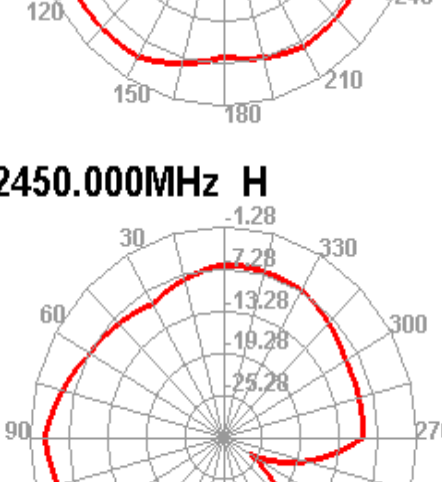

2440.000MHz E1

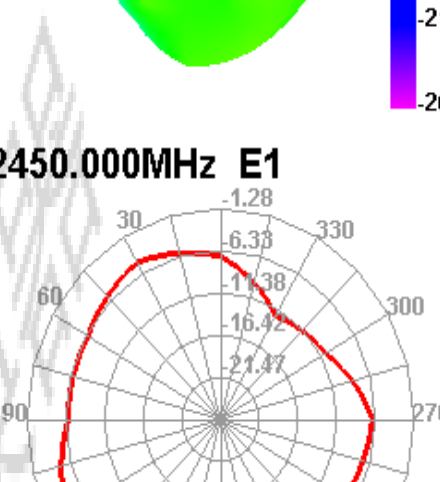

2440.000MHz E2

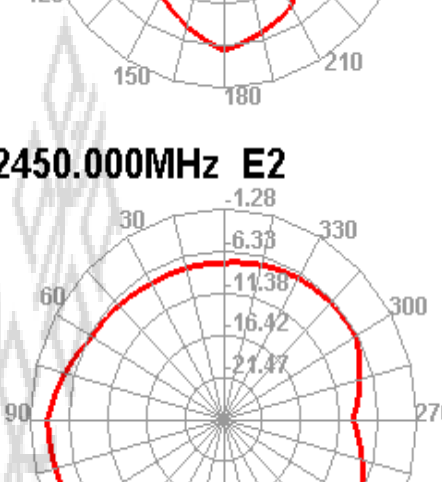

2450.000MHz

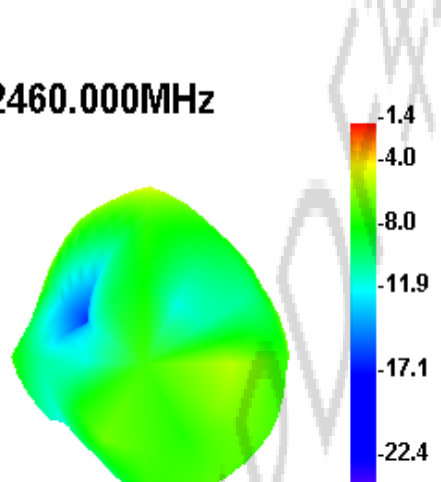

2450.000MHz H

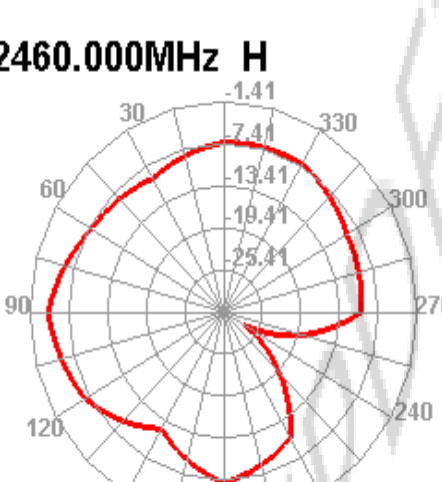

2450.000MHz E1

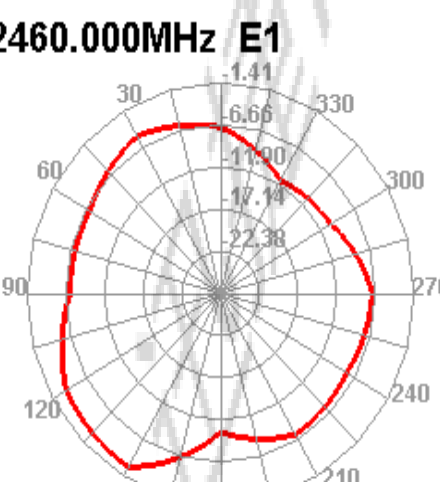

2450.000MHz E2

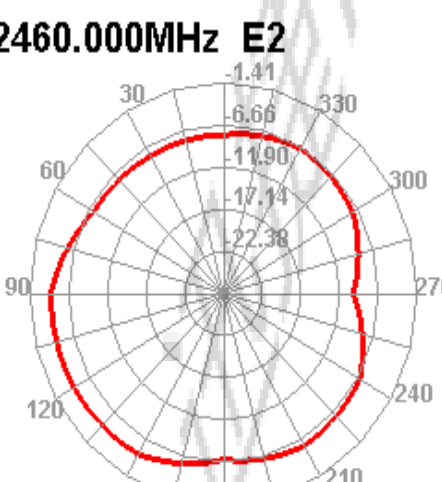

2460.000MHz

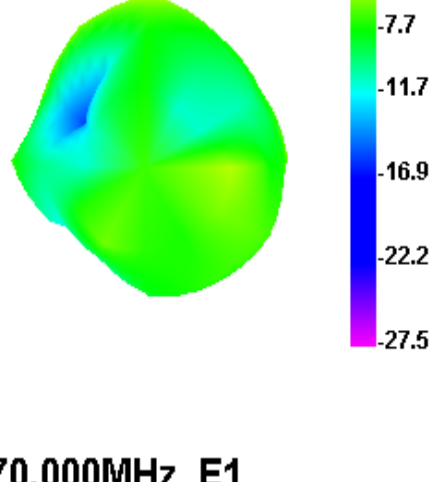

2460.000MHz H

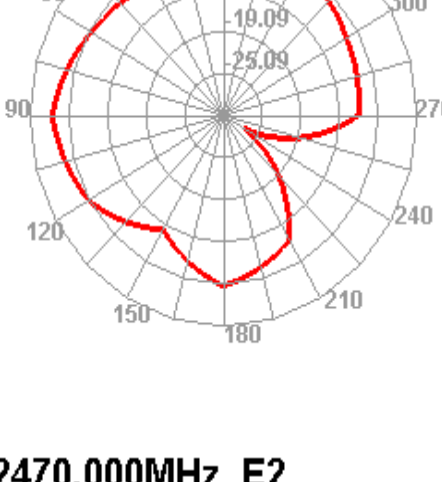

2460.000MHz E1

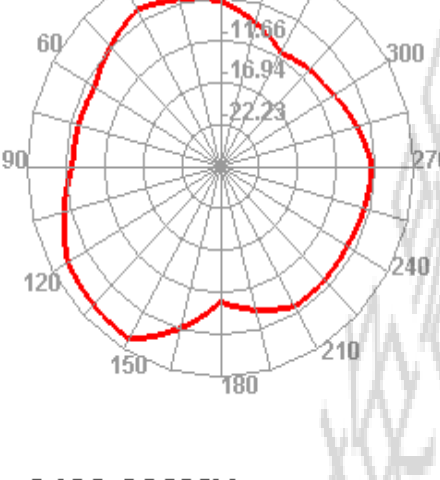

2460.000MHz E2

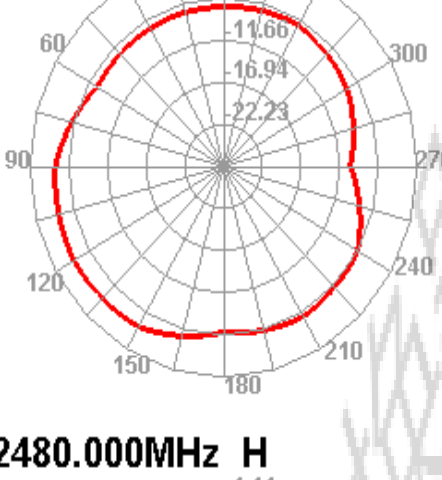

2470.000MHz

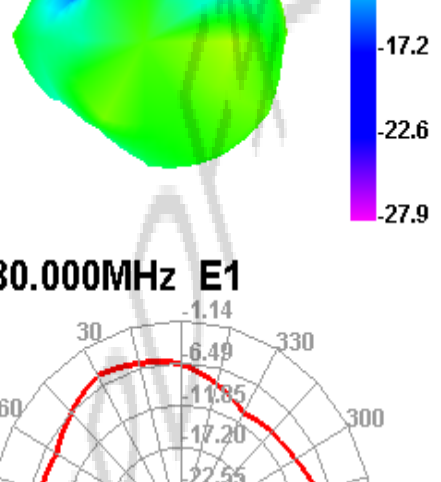

2470.000MHz H

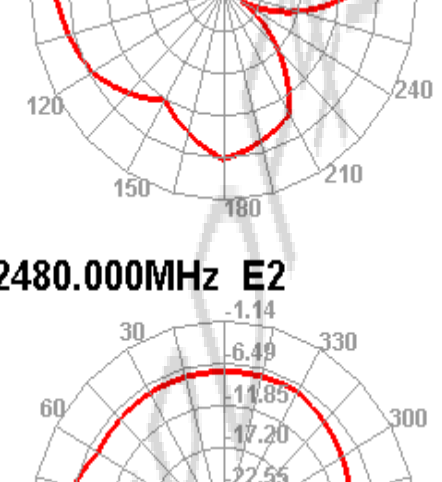

2470.000MHz E1

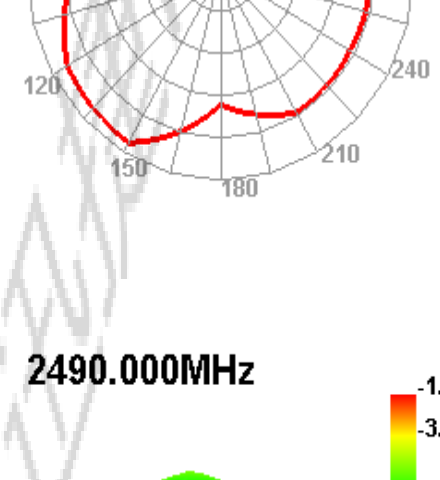

2470.000MHz E2

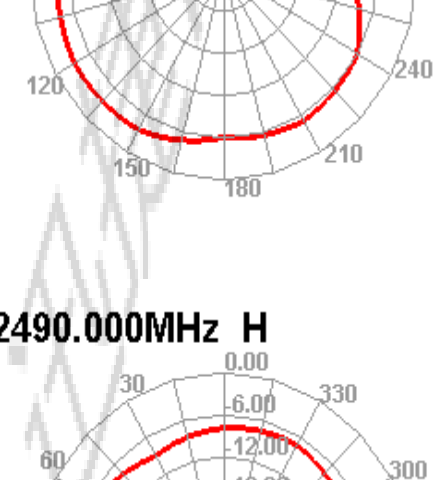

2480.000MHz

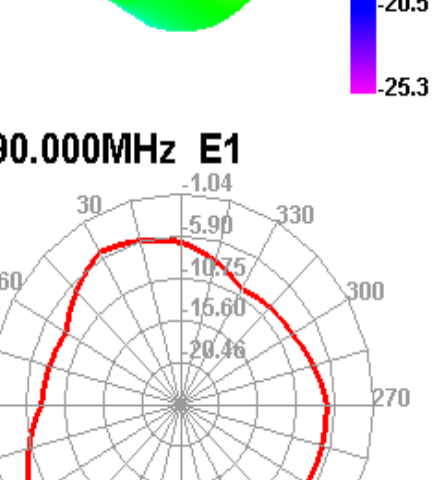

2480.000MHz H

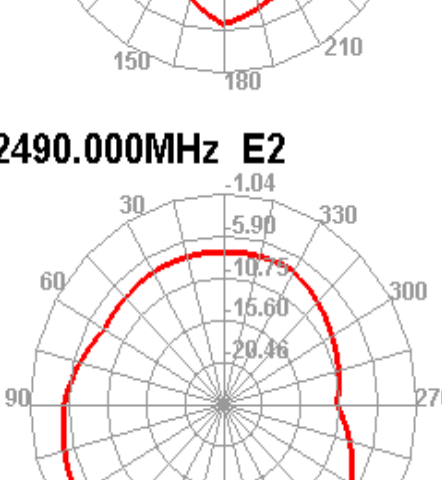

2480.000MHz E1

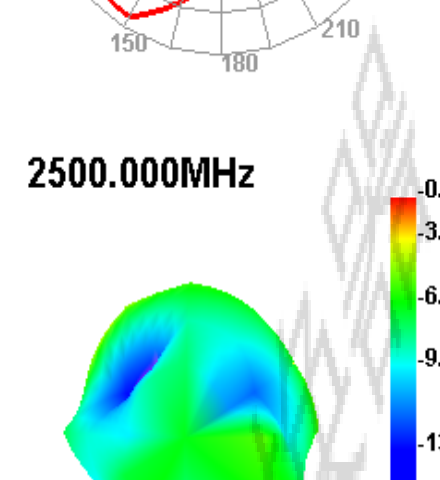

2480.000MHz E2

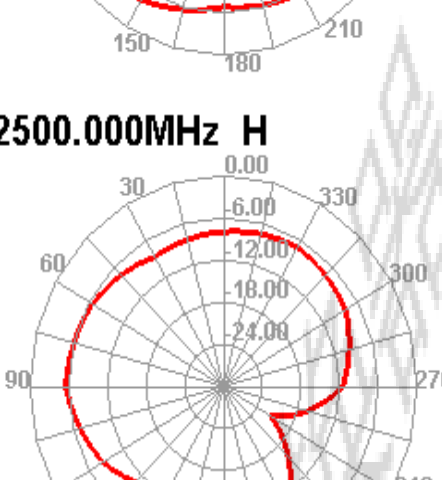

2490.000MHz

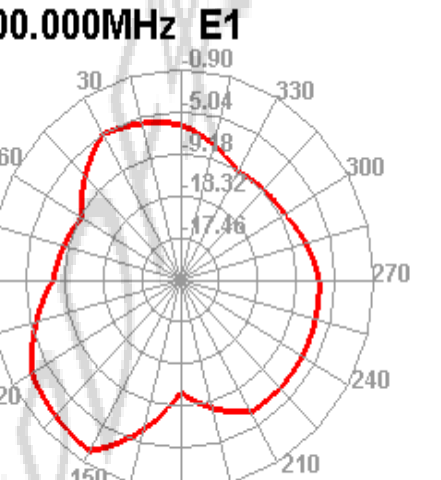

2490.000MHz H

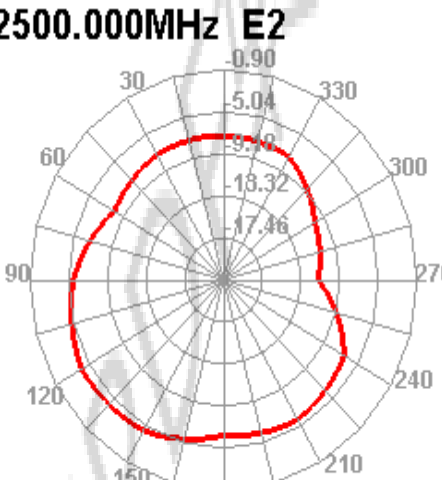

2490.000MHz E1



2490.000MHz E2



2500.000MHz



2500.000MHz H



2500.000MHz E1



2500.000MHz E2

