

8.2. Limit

9.3.1 FCC 15.205 Restricted frequency band

MHz	MHz	MHz	GHz
0.090 - 0.110	16.42 - 16.423	399.9 - 410	4.5 - 5.15
¹ 0.495 - 0.505	16.69475 - 16.69525	608 - 614	5.35 - 5.46
2.1735 - 2.1905	16.80425 - 16.80475	960 - 1240	7.25 - 7.75
4.125 - 4.128	25.5 - 25.67	1300 - 1427	8.025 - 8.5
4.17725 - 4.17775	37.5 - 38.25	1435 - 1626.5	9.0 - 9.2
4.20725 - 4.20775	73 - 74.6	1645.5 - 1646.5	9.3 - 9.5
6.215 - 6.218	74.8 - 75.2	1660 - 1710	10.6 - 12.7
6.26775 - 6.26825	108 - 121.94	1718.8 - 1722.2	13.25 - 13.4
6.31175 - 6.31225	123 - 138	2200 - 2300	14.47 - 14.5
8.291 - 8.294	149.9 - 150.05	2310 - 2390	15.35 - 16.2
8.362 - 8.366	156.52475 - 156.52525	2483.5 - 2500	17.7 - 21.4
8.37625 - 8.38675	156.7 - 156.9	2690 - 2900	22.01 - 23.12
8.41425 - 8.41475	162.0125 - 167.17	3260 - 3267	23.6 - 24.0
12.29 - 12.293	167.72 - 173.2	3332 - 3339	31.2 - 31.8
12.51975 - 12.52025	240 - 285	3345.8 - 3358	36.43 - 36.5
12.57675 - 12.57725	322 - 335.4	3600 - 4400	(²)

9.3.2. FCC 15.209 Limit.

FREQUENCY MHz	DISTANCE Meters	FIELD STRENGTHS LIMIT	
		μV/m	dB(μV)/m
0.009 ~ 0.490	300	2400/F(KHz)	67.6-20log(F)
0.490 ~ 1.705	30	24000/F(KHz)	87.6-20log(F)
1.705 ~ 30.0	30	30	29.54
30 ~ 88	3	100	40.0
88 ~ 216	3	150	43.5
216 ~ 960	3	200	46.0
960 ~ 1000	3	500	54.0
Above 1000	3	74.0 dB(μV)/m (Peak) 54.0 dB(μV)/m (Average)	

Note: (1) The emission limits shown in the above table are based on measurements employing a CISPR QP detector except for the frequency bands 9-90KHz, 110-490KHz and above 1000MHz. Radiated emissions limits in these three bands are based on measurements employing an average detector.

(2) At frequencies below 30MHz, measurement may be performed at a distance closer than that specified, and the limit at closer measurement distance can be extrapolated by below formula:

$$\text{Limit}_{3m}(\text{dBuV/m}) = \text{Limit}_{30m}(\text{dBuV/m}) + 40\text{Log}(30m/3m)$$

9.3.3. Limit for this EUT

All the emissions appearing within 15.205 restricted frequency bands shall not exceed the limits shown in 15.209, all the other emissions shall be at least 30dB below the fundamental emissions, or comply with 15.209 limits.

8.3. Test Procedure

- (1) EUT was placed on a non-metallic table, 80 cm above the ground plane inside a semi-anechoic chamber.
- (2) Setup EUT and assistant system according clause 2.4 and 7.2
- (3) Test antenna was located 3m(except 18GHz-40GHz was 1m) from the EUT on an adjustable mast, and the antenna used as below table.

Test frequency range	Test antenna used
9KHz-30MHz	Active Loop antenna
30MHz-1GHz	Bilog Broadband Antenna
1GHz-18GHz	Double Ridged Horn Antenna(1GHz-18GHz)
18GHz-40GHz	Horn Antenna(18GHz-40GHz)

According ANSI C63.10:2013 clause 6.4.4.2 and 6.5.3, for measurements below 30 MHz, the loop antenna was positioned with its plane vertical from the EUT and rotated about its vertical axis for maximum response at each azimuth position around the EUT. And the loop antenna also be positioned with its plane horizontal at the specified distance from the EUT. The center of the loop is 1 m above the ground. for measurement above 30MHz, the Trilog Broadband Antenna or Horn Antenna was located 3m from EUT, Measurements were made with the antenna positioned in both the horizontal and vertical planes of Polarization, and the measurement antenna was varied from 1 m to 4 m. in height above the reference ground plane to obtain the maximum signal strength.

- (4) Below pre-scan procedure was first performed in order to find prominent frequency spectrum radiated emissions from 9KHz to 25GHz:
 - (a) Scanning the peak frequency spectrum with the antenna specified in step (3), and the EUT was rotated 360 degree, the antenna height was varied from 1m to 4m(Except loop antenna, it's fixed 1m above ground.)
 - (b) Change work frequency or channel of device if practicable.

- (c) Change modulation type of device if practicable.
- (d) new battery is used during testing
- (e) Rotated EUT though three orthogonal axes to determine the attitude of EUT arrangement produces highest emissions.

Spectrum frequency from 9KHz to 25GHz (tenth harmonic of fundamental frequency) was investigated, and no any obvious emission were detected from 18GHz to 25GHz, so below final test was performed with frequency range from 9KHz to 18GHz.

- (5) For final emissions measurements at each frequency of interest, the EUT was rotated and the antenna height was varied between 1m and 4m in order to maximize the emission. Measurements in both horizontal and vertical polarities were made and the data was recorded. In order to find the maximum emission, the relative positions of equipments and all of the interface cables were changed according to ANSI C63.10 2013 on Radiated Emission test.
- (6) The emissions from 9KHz to 1GHz were measured based on CISPR QP detector except for the frequency bands 9-90KHz, 110-490KHz, for emissions from 9KHz-90KHz,110KHz-490KHz and above 1GHz were measured based on average detector, for emissions above 1GHz, peak emissions also be measured and need comply with Peak limit.
- (7) The emissions from 9KHz to 1GHz, QP or average values were measured with EMI receiver with below RBW

Frequency band	RBW
9KHz-150KHz	200Hz
150KHz-30MHz	9KHz
30MHz-1GHz	120KHz

- (8) For emissions above 1GHz, both Peak and Average level were measured with Spectrum Analyzer, and the RBW is set at 1MHz, VBW is set at 3MHz for Peak measure; RBW is set at 1MHz, VBW is set at 10Hz for Average measure(according ANSI C63.10:2013 clause 4.2.3.2.3 procedure for average measure). Peak detector is used for Peak and AV measurement both.

According to KDB 789033 v02r01 section G) 1) (d), for For measurements above 1000 MHz @ 3m distance, the limit of field strength is computed as follows:

$$E[\text{dBuV/m}] = \text{EIRP}[\text{dBm}] + 95.2;$$

For example, if EIRP = -27dBm

$$E[\text{dBuV/m}] = -27 + 95.2 = 68.2\text{dBuV/m}.$$

8.4. Test result(Below 30MHz)

EUT:	IO Wi-Fi 6 Dual Band 2x2:2 Home Mesh Router with Integrated Antenna (5 dBi)	Model Name. :	ion4xi_HMR
Temperature:	25°C	Relative Humidity:	51%
Distance:	3m	Test Power:	110VAC, 60Hz
Polarization:	--	Test Result:	Pass
Test Mode:	Keeping TX mode	Test By:	Ankur

Freq. (MHz)	Reading (dBuV/m)	Limit (dBuV/m)	Margin (dB)	State P/F
--	--	--	--	P
--	--	--	--	P

Note:

The amplitude of spurious emissions which are attenuated by more than 20dB below the permissible value has no need to be reported.

Distance extrapolation factor = 20 log (specific distance/test distance)(dB);

Limit line = specific limits(dBuv) + distance extrapolation factor.

Note: N/A

TEST RESULTS (Between 30M – 1000 MHz)

EUT:	IO Wi-Fi 6 Dual Band 2x2:2 Home Mesh Router with Integrated Antenna (5 dBi)	Model Name. :	ion4xi_HMR
Temperature:	25°C	Relative Humidity:	51%
Distance:	3m	Test Power:	110VAC, 60Hz
Polarization:	Vertical	Test Result:	Pass
Standard:	(RE)FCC PART 15	Test By:	Ankur
Test Mode:	Keeping TX mode		

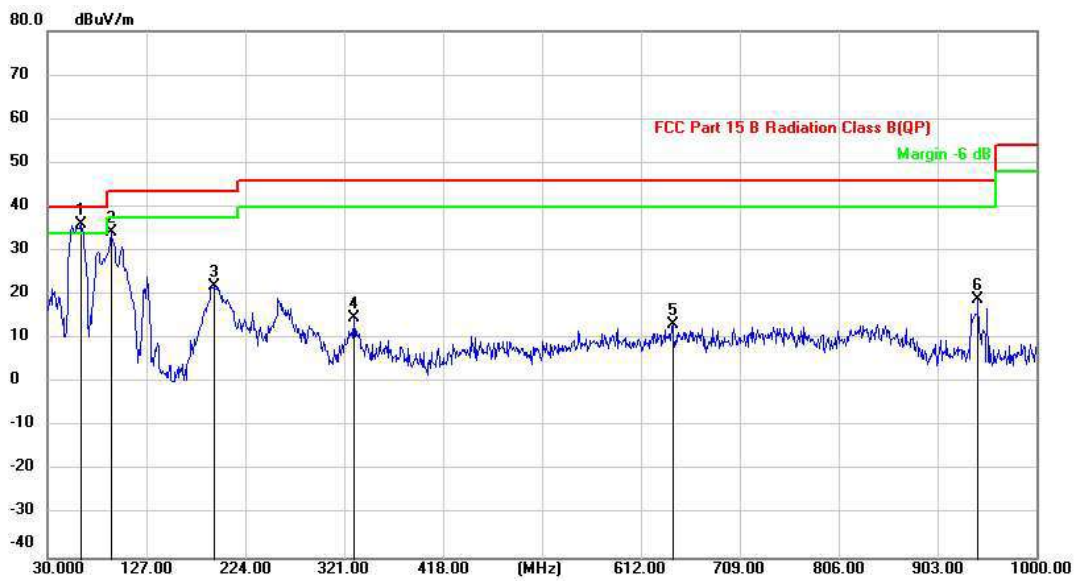

No.	Frequency (MHz)	Reading (dBuV)	Factor (dB/m)	Level (dBuV/m)	Limit (dBuV/m)	Margin (dB)	Detector
1 *	62.9799	54.18	-18.26	35.92	40.00	-4.08	QP
2	92.0798	53.01	-18.73	34.28	43.50	-9.22	QP
3	192.9600	40.56	-18.56	22.00	43.50	-21.50	QP
4	330.6999	29.39	-14.68	14.71	46.00	-31.29	QP
5	643.0398	25.16	-11.99	13.17	46.00	-32.83	QP
6	942.7699	34.28	-15.44	18.84	46.00	-27.16	QP

The test result is calculated as the following:

- (1) Result = Reading + Correct Factor
- (2) Correct Factor = Antenna Factor + Cable Loss – Amplifier Gain + Attenuator
- (3) Margin = Result - Limit

EUT:	IO Wi-Fi 6 Dual Band 2x2:2 Home Mesh Router with Integrated Antenna (5 dBi)	Model Name. :	ion4xi_HMR
Temperature:	25°C	Relative Humidity:	51%
Distance:	3m	Test Power:	110VAC, 60Hz
Polarization:	Horizontal	Test Result:	Pass
Standard:	(RE) FCC PART 15	Test By:	Ankur
Test Mode:	Keeping TX mode		

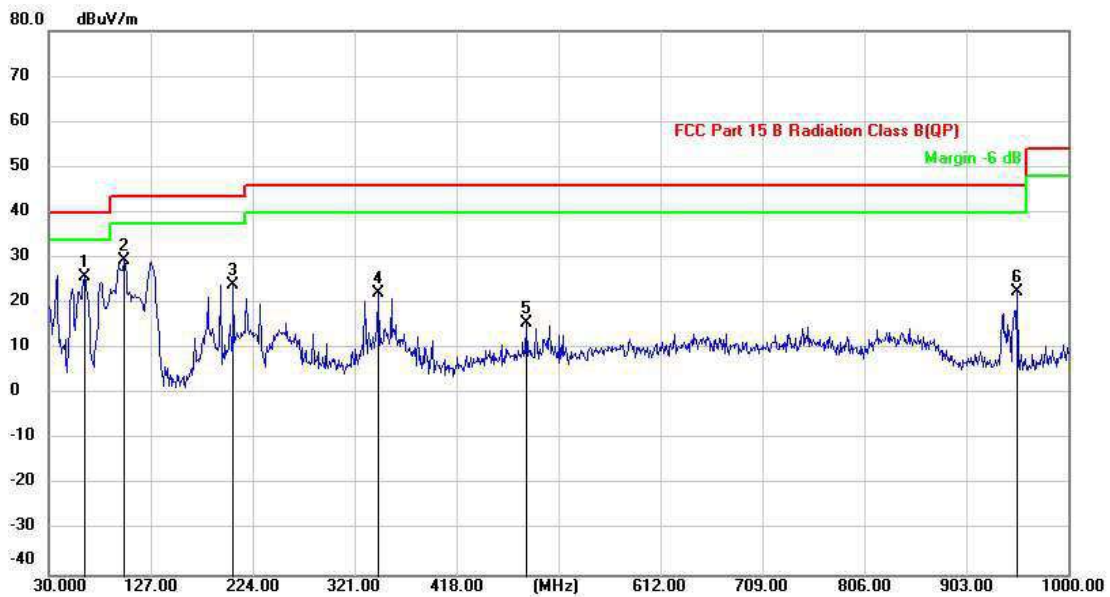

No.	Frequency (MHz)	Reading (dBuV)	Factor (dB/m)	Level (dBuV/m)	Limit (dBuV/m)	Margin (dB)	Detector
1	63.9500	44.24	-18.49	25.75	40.00	-14.25	QP
2 *	101.7800	46.81	-17.48	29.33	43.50	-14.17	QP
3	205.5697	42.82	-18.82	24.00	43.50	-19.50	QP
4	343.3100	37.12	-14.85	22.27	46.00	-23.73	QP
5	483.9599	29.81	-14.24	15.57	46.00	-30.43	QP
6	951.5000	38.22	-15.61	22.61	46.00	-23.39	QP

The test result is calculated as the following:

- (4) Result = Reading + Correct Factor
- (5) Correct Factor = Antenna Factor + Cable Loss – Amplifier Gain + Attenuator
- (6) Margin = Result - Limit

TEST RESULTS (Between 1000M – 18000 MHz)

EUT:	IO Wi-Fi 6 Dual Band 2x2:2 Home Mesh Router with Integrated Antenna (5 dBi)	Model Name. :	ion4xi_HMR
Temperature:	25°C	Relative Humidity:	51%
Distance:	3m	Test Power:	110VAC, 60Hz
Polarization:	Vertical	Test Result:	Pass
Standard:	(RE) FCC PART 15	Test By:	Ankur
Test Mode:	Keeping TX mode		

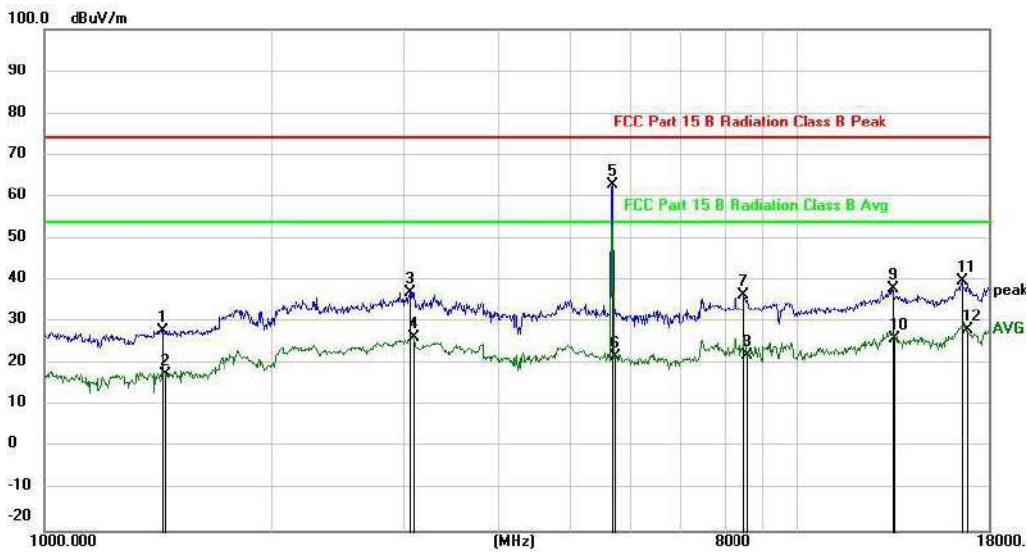

No.	Mk.	Freq. MHz	Reading Level dBuV	Correct Factor dB	Measurement dBuV/m	Limit dBuV/m	Over dB	Detector
1		1435.189	36.54	-8.61	27.93	74.00	-46.07	peak
2		1447.688	26.42	-8.65	17.77	54.00	-36.23	AVG
3		3060.486	46.05	-8.83	37.22	74.00	-36.78	peak
4		3087.140	35.06	-8.70	26.36	54.00	-27.64	AVG
5	*	5697.365	66.39	-3.56	62.83	74.00	-11.17	peak
6		5746.982	25.41	-3.42	21.99	54.00	-32.01	AVG
7		8514.456	30.72	5.75	36.47	74.00	-37.53	peak
8		8613.467	15.83	6.43	22.26	54.00	-31.74	AVG
9		13404.00	19.23	18.90	38.13	74.00	-35.87	peak
10		13520.74	6.51	19.48	25.99	54.00	-28.01	AVG
11		16600.64	22.55	17.27	39.82	74.00	-34.18	peak
12		16842.29	13.34	14.78	28.12	54.00	-25.88	AVG

Note: Marker 5 is intentionally radiated frequency from the EUT.

The test result is calculated as the following:

- (1) Result = Reading + Correct Factor
- (2) Correct Factor = Antenna Factor + Cable Loss – Amplifier Gain + Attenuator
- (3) Margin = Result – Limit

EUT:	IO Wi-Fi 6 Dual Band 2x2:2 Home Mesh Router with Integrated Antenna (5 dBi)	Model Name. :	ion4xi_HMR
Temperature:	25°C	Relative Humidity:	51%
Distance:	3m	Test Power:	110VAC, 60Hz
Polarization:	Horizontal	Test Result:	Pass
Standard:	(RE) FCC PART 15	Test By:	Ankur
Test Mode:	Keeping TX mode		

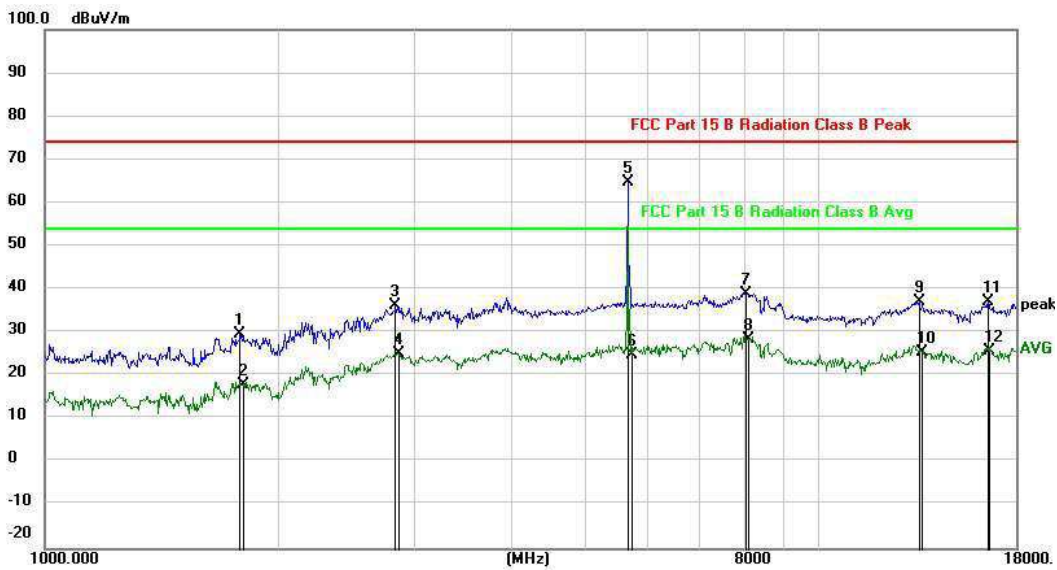

No.	Mk.	Freq. MHz	Reading Level dBuV	Correct Factor dB	Measurement dBuV/m	Limit dBuV/m	Over dB	Detector
1		1787.762	38.44	-8.93	29.51	74.00	-44.49	peak
2		1798.127	26.86	-8.92	17.94	54.00	-36.06	AVG
3		2838.921	45.53	-9.29	36.24	74.00	-37.76	peak
4		2863.645	34.50	-9.26	25.24	54.00	-28.76	AVG
5	*	5664.525	68.36	-3.65	64.71	74.00	-9.29	peak
6		5746.982	28.15	-3.42	24.73	54.00	-29.27	AVG
7		8036.214	33.79	5.28	39.07	74.00	-34.93	peak
8		8106.200	23.11	5.33	28.44	54.00	-25.56	AVG
9		13481.71	17.83	19.39	37.22	74.00	-36.78	peak
10		13599.12	6.16	19.42	25.58	54.00	-28.42	AVG
11		16552.72	19.36	17.77	37.13	74.00	-36.87	peak
12		16648.69	8.88	16.78	25.66	54.00	-28.34	AVG

Note: Marker 5 is intentionally radiated frequency from the EUT.

The test result is calculated as the following:

(4) Result = Reading + Correct Factor

(5) Correct Factor = Antenna Factor + Cable Loss – Amplifier Gain + Attenuator

(6) Margin = Result – Limit

The field strength is calculated by adding the Antenna Factor, Cable Factor & Preamplifier. The basic equation with a sample calculation is as follows:

Final Test Level = Receiver Reading + Antenna Factor + Cable Factor – Preamplifier Factor.

Average measurement was not performed if peak level lower than average limit.

No any other emissions level very low which are attenuated less than 20dB below the limit.

According to 15.31(o), The amplitude of spurious emissions from intentional radiators and emissions from unintentional radiators which are attenuated more than 20 dB below the permissible value need not be reported unless specifically required elsewhere in this Part.

Hence there no other emissions have been reported.

9. POWER LINE CONDUCTED EMISSION

9.1. Block diagram of test setup

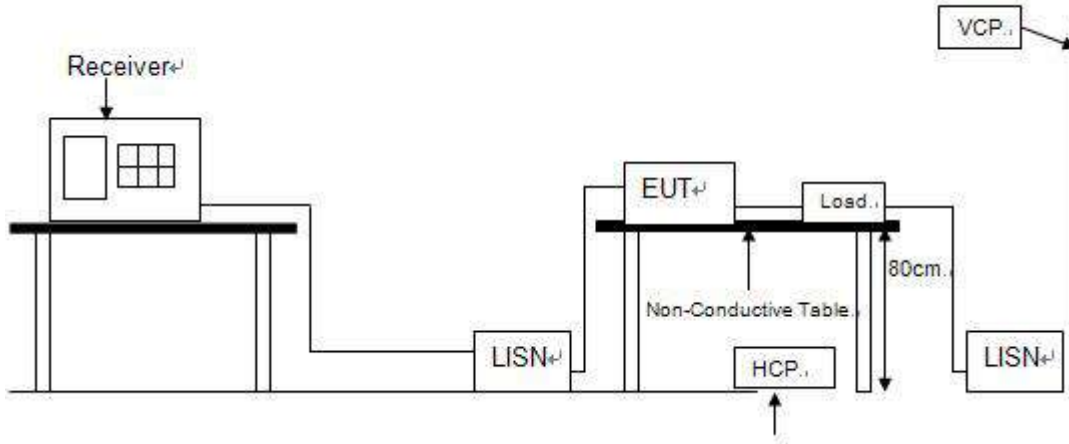

9.2. Power Line Conducted Emission Limits

Frequency	Quasi-Peak Level dB(μ V)	Average Level dB(μ V)
150kHz ~ 500kHz	66 ~ 56*	56 ~ 46*
500kHz ~ 5MHz	56	46
5MHz ~ 30MHz	60	50

Note 1: * Decreasing linearly with logarithm of frequency.

Note 2: The lower limit shall apply at the transition frequencies.

9.3. Test Procedure

The EUT and Support equipment, if needed, were put placed on a non-metallic table, 80cm above the ground plane.

Configuration EUT to simulate typical usage as described in clause 2.4 and test equipment as described in clause 10.2 of this report.

All I/O cables were positioned to simulate typical actual usage as per ANSI C63.4.

All support equipment power received from a second LISN.

Emissions were measured on each current carrying line of the EUT using an EMI Test Receiver connected to the LISN powering the EUT.

The Receiver scanned from 150 kHz to 30MHz for emissions in each of the test modes.

During the above scans, the emissions were maximized by cable manipulation.

The test mode(s) described in clause 2.4 were scanned during the preliminary test.

After the preliminary scan, we found the test mode producing the highest emission level.

The EUT configuration and worse cable configuration of the above highest emission levels were recorded for reference of the final test.

EUT and support equipment were set up on the test bench as per the configuration with highest emission level in the preliminary test.

A scan was taken on both power lines, Neutral and Line, recording at least the six highest emissions.

Emission frequency and amplitude were recorded into a computer in which correction factors were used to calculate the emission level and compare reading to the applicable limit.

The test data of the worst-case condition(s) was recorded.

The bandwidth of test receiver is set at 9 KHz.

9.4. Test Result

PASS. (See below detailed test result)

Note1: All emissions not reported below are too low against the prescribed limits.

Note2: “-----” means peak detection; “-----” means average detection

EUT:	IO Wi-Fi 6 Dual Band 2x2:2 Home Mesh Router with Integrated Antenna (5 dBi)	Model Name.:	ion4xi_HMR
Temperature:	25 °C	Relative Humidity:	51%
Probe:	Line	Test Power:	110VAC, 60Hz
Test Mode:	TX	Test Result:	Pass
Standard:	(CE)FCC PART 15 E_QP		

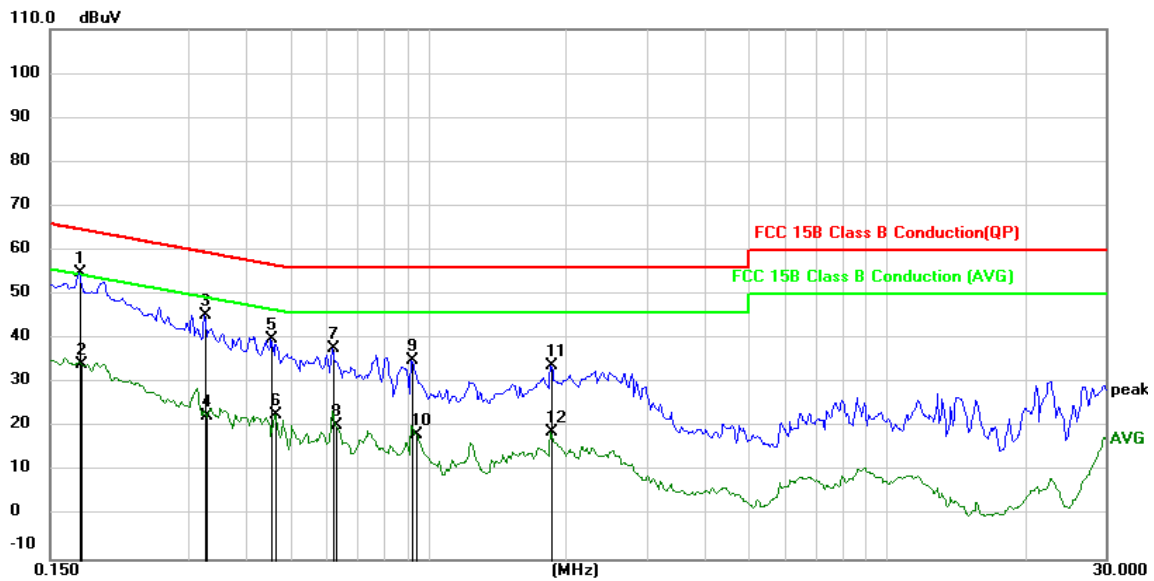

No.	Mk.	Freq. MHz	Reading Level dBuV	Correct Factor dB	Measurement dBuV	Limit dBuV	Over dB	Detector
1	*	0.1734	64.76	-9.94	54.82	64.79	-9.97	QP
2		0.1758	44.25	-9.93	34.32	54.68	-20.36	AVG
3		0.3255	55.27	-9.85	45.42	59.56	-14.14	QP
4		0.3301	32.52	-9.85	22.67	49.45	-26.78	AVG
5		0.4542	49.89	-9.87	40.02	56.80	-16.78	QP
6		0.4661	32.58	-9.87	22.71	46.58	-23.87	AVG
7		0.6180	47.84	-9.86	37.98	56.00	-18.02	QP
8		0.6297	30.20	-9.86	20.34	46.00	-25.66	AVG
9		0.9222	44.92	-9.81	35.11	56.00	-20.89	QP
10		0.9427	28.11	-9.81	18.30	46.00	-27.70	AVG
11		1.8504	43.78	-9.87	33.91	56.00	-22.09	QP
12		1.8504	28.70	-9.87	18.83	46.00	-27.17	AVG

The test result is calculated as the following:

- (1) Result = Reading + Correct Factor
- (2) Correct Factor = (LISN, ISN, PLC or Current Probe) Factor + Cable Loss +Attenuator
- (3) Margin = Result - Limit

EUT:	IO Wi-Fi 6 Dual Band 2x2:2 Home Mesh Router with Integrated Antenna (5 dBi)	Model Name.:	ion4xi_HMR
Temperature:	25 °C	Relative Humidity:	51%
Probe:	Neutral	Test Power:	110VAC, 60Hz
Test Mode:	TX	Test Result:	Pass
Standard:	(CE)FCC PART 15 E_QP		

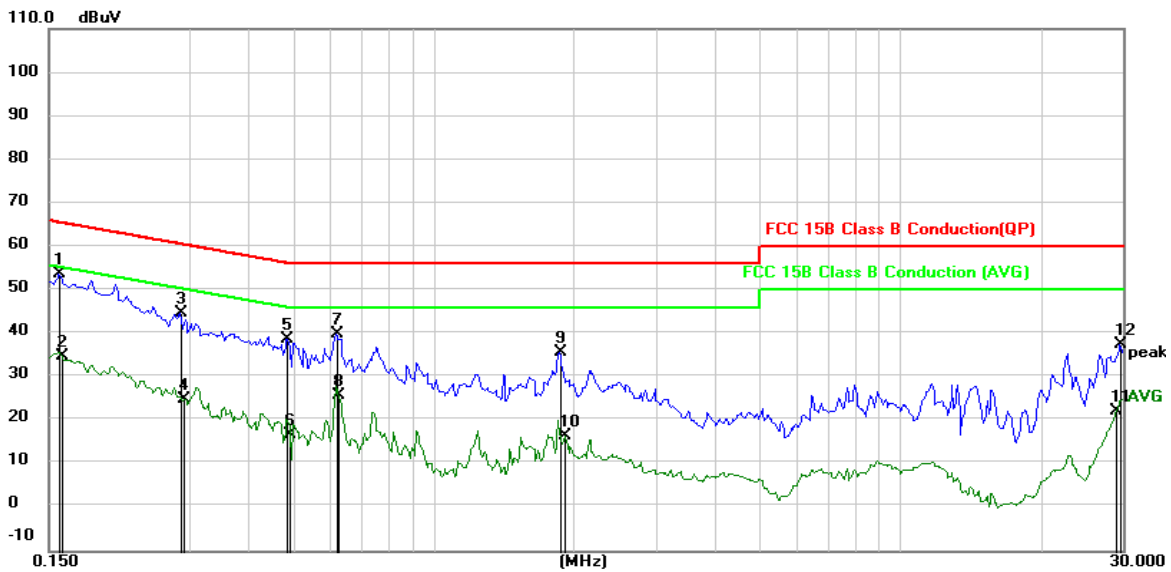

No.	Mk.	Freq. MHz	Reading Level dBuV	Correct Factor dB	Measurement dBuV	Limit dBuV	Over dB	Detector
1	*	0.1578	63.83	-10.01	53.82	65.57	-11.75	QP
2		0.1597	44.89	-10.01	34.88	55.47	-20.59	AVG
3		0.2865	54.46	-9.84	44.62	60.62	-16.00	QP
4		0.2923	34.67	-9.84	24.83	50.46	-25.63	AVG
5		0.4854	48.76	-9.88	38.88	56.25	-17.37	QP
6		0.4939	26.71	-9.88	16.83	46.10	-29.27	AVG
7		0.6180	49.95	-9.86	40.09	56.00	-15.91	QP
8		0.6270	35.63	-9.86	25.77	46.00	-20.23	AVG
9		1.8621	45.76	-9.87	35.89	56.00	-20.11	QP
10		1.9167	26.28	-9.87	16.41	46.00	-29.59	AVG
11		29.0611	15.98	6.31	22.29	60.00	-37.71	QP
12		29.6067	28.94	8.51	37.45	50.00	-12.55	AVG

The test result is calculated as the following:

- (1) Result = Reading + Correct Factor
- (2) Correct Factor = (LISN, ISN, PLC or Current Probe) Factor + Cable Loss +Attenuator
- (3) Margin = Result – Limit

10. CONDUCTED SPURIOUS EMISSIONS

Test Requirement: FCC Part 15 C section 15.407

(d) In any 100 kHz bandwidth outside the frequency band in which the spread spectrum or digitally modulated intentional radiator is operating. the radio frequency power that is produced by the intentional radiator shall be at least 20 dB below that in the 100 kHz bandwidth within the band that contains the highest level of the desired power. Based on either an RF conducted or a radiated measurement. Provided the transmitter demonstrates compliance with the peak conducted power limits.

Test Method: ANSI C63.10: Clause 6.7

Test Status: Pre-Scan has been conducted to determine the worst-case mode from all possible combinations between available modulations, data rates and antenna ports (if EUT with antenna diversity architecture). Following channel(s) was (were) selected for the final test as listed below.
Pre-test the EUT under 2 modes: power-supplied by using the AC adapter and power-supplied by using internal battery. After pre-testing, we found the worst case is the test mode of EUT power-supplied by using internal battery.

Test Configuration:

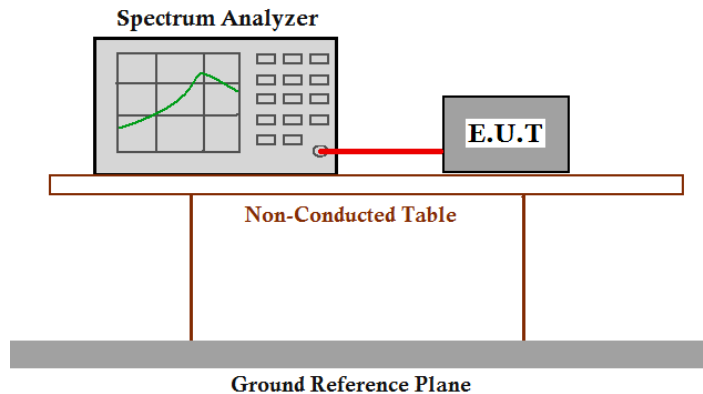

Test Procedure:

1. Remove the antenna from the EUT and then connect a low RF cable from the antenna port to the spectrum analyzer or power meter.
2. Set the spectrum analyzer: RBW=100 KHz, VBW = 300KHz. Sweep = auto; Detector Function = Peak. Trace = Max Hold, Scan up through 10th harmonic.
3. Measure the Conducted Spurious Emissions of the test frequency with special test status.
4. Repeat until all the test status is investigated.
5. Report the worse case.

Report No.: AAEMT/EMC/220826-02-09

Result plot as follows: CHAIN 0

a20 5.180 GHz

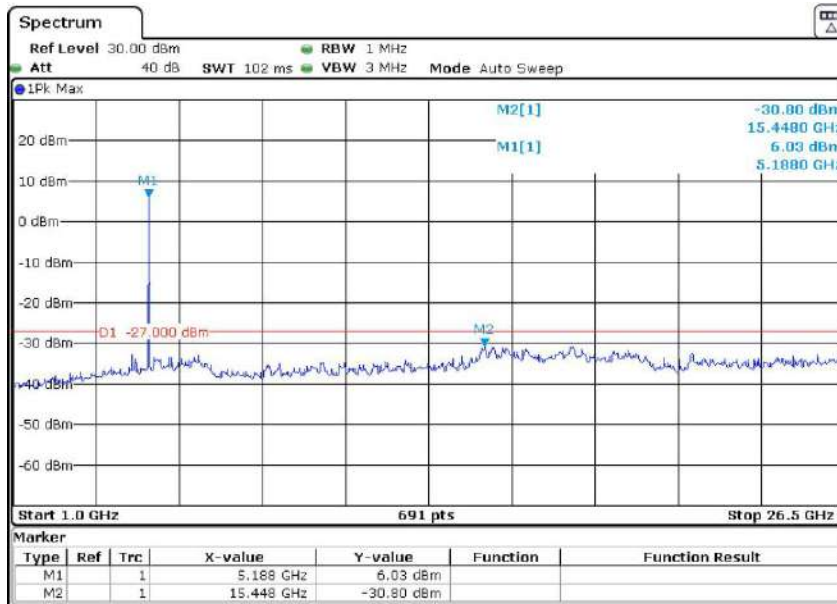
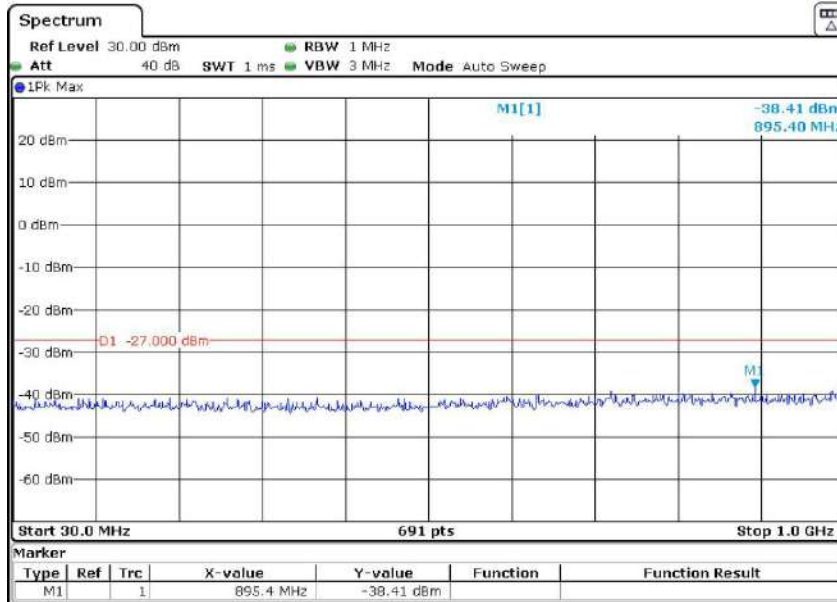

Report No.: AAEMT/EMC/220826-02-09

a20 5.240 GHz

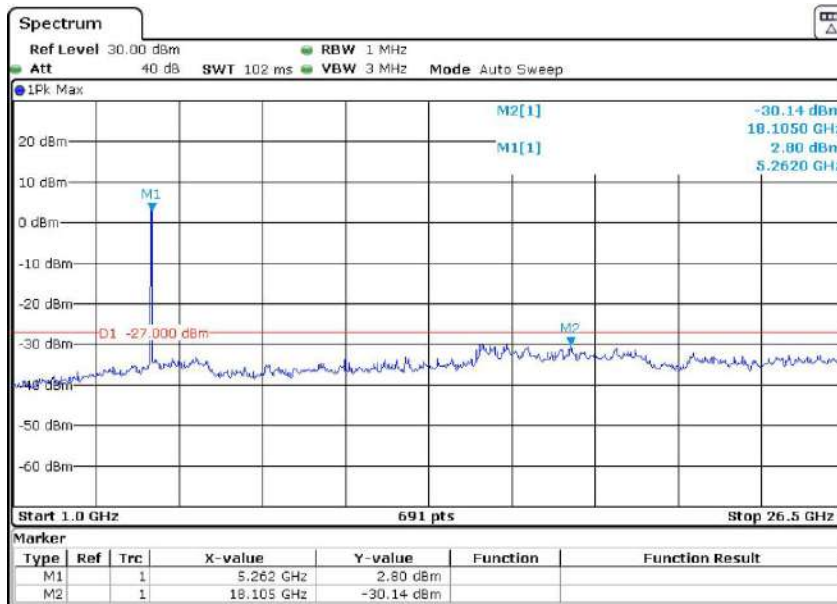
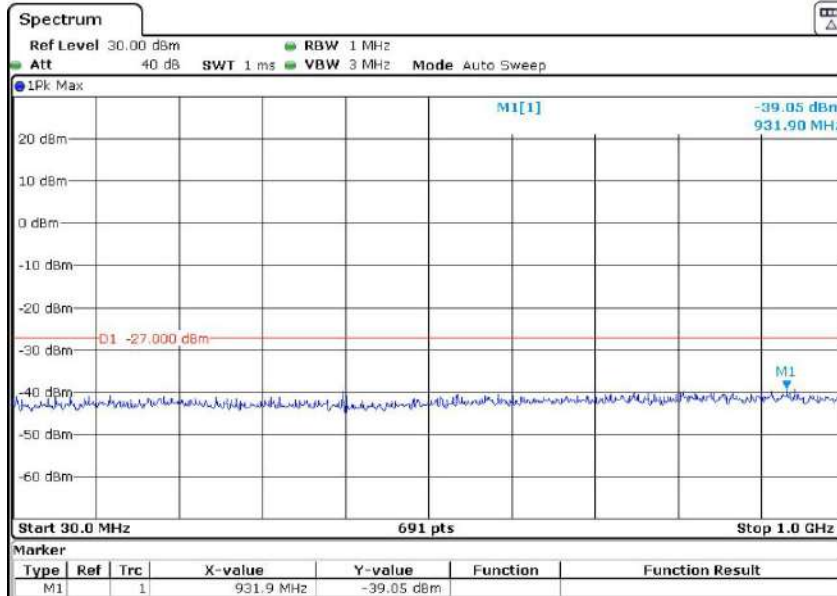

Report No.: AAEMT/EMC/220826-02-09

n20 5.180 GHz

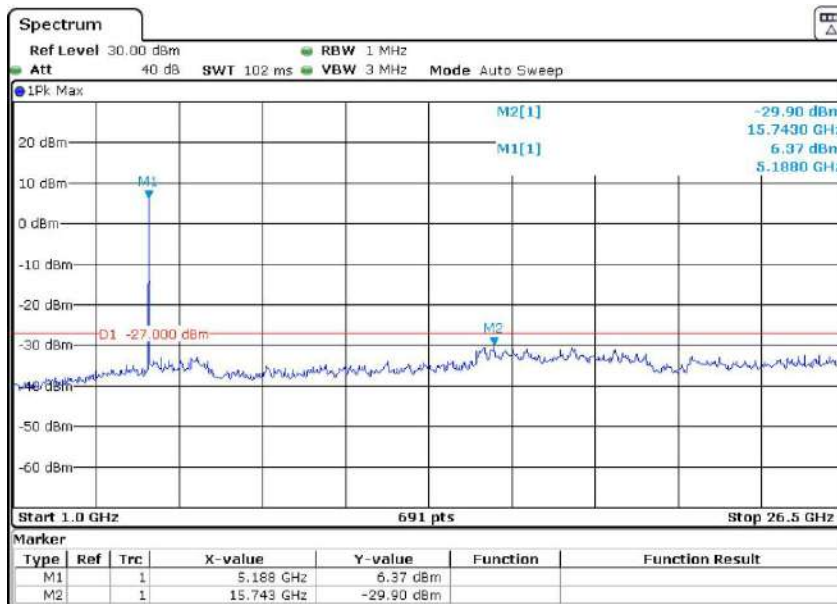
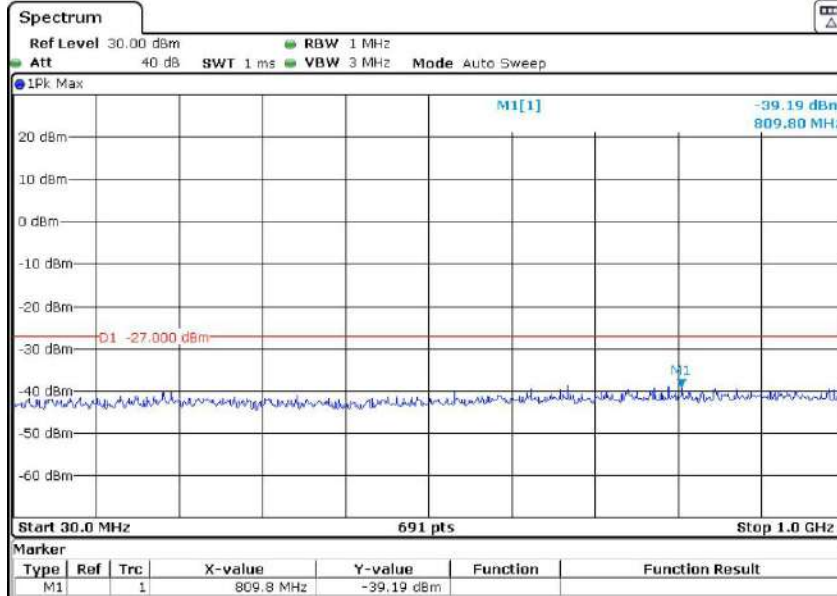

Report No.: AAEMT/EMC/220826-02-09

n20 5.240 GHz

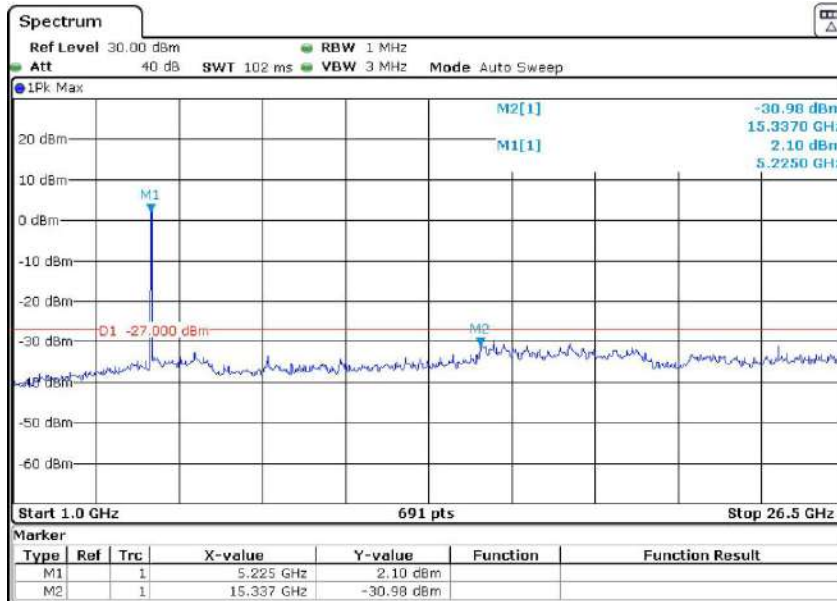
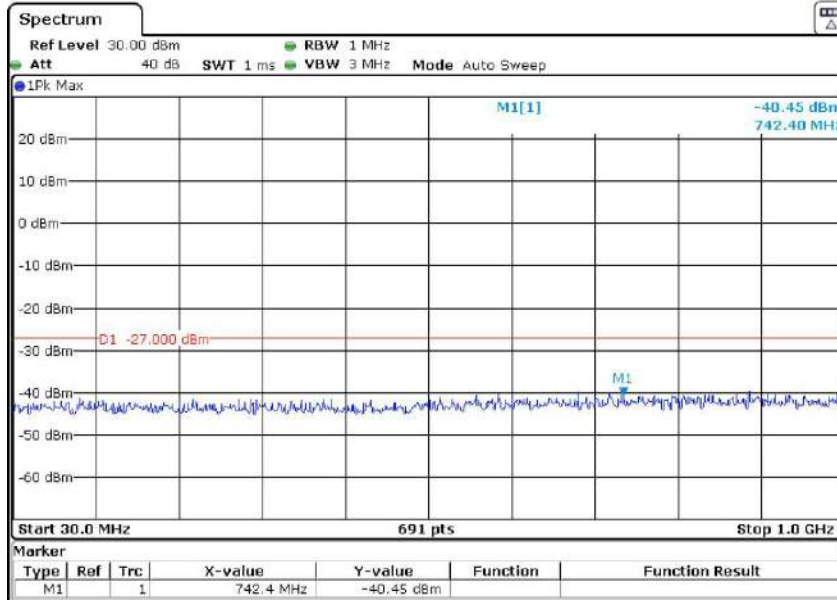

Report No.: AAEMT/EMC/220826-02-09

n40 5.190 GHz

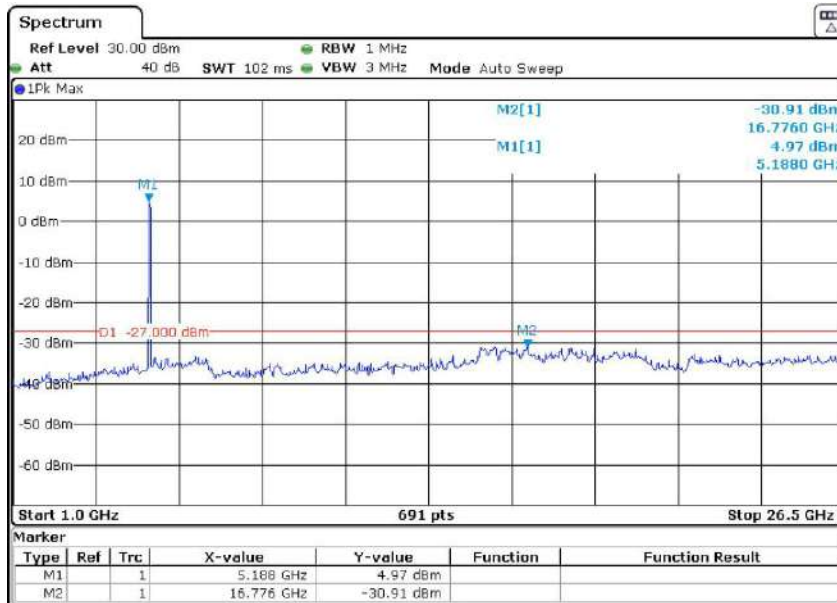
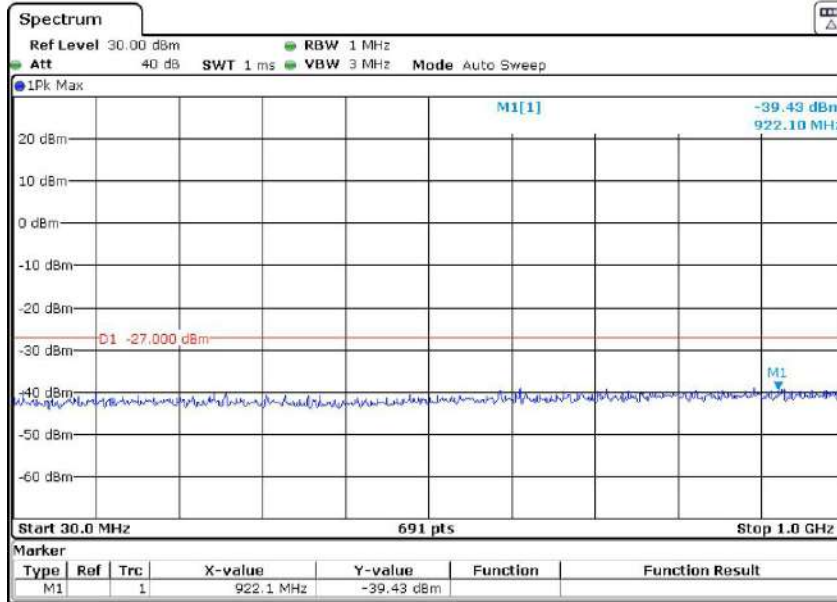

Report No.: AAEMT/EMC/220826-02-09

n40 5.230 GHz

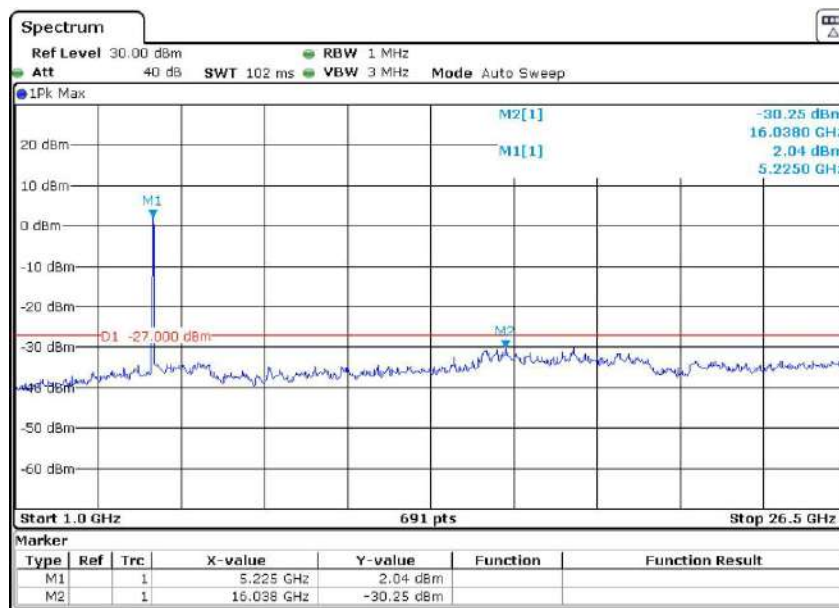
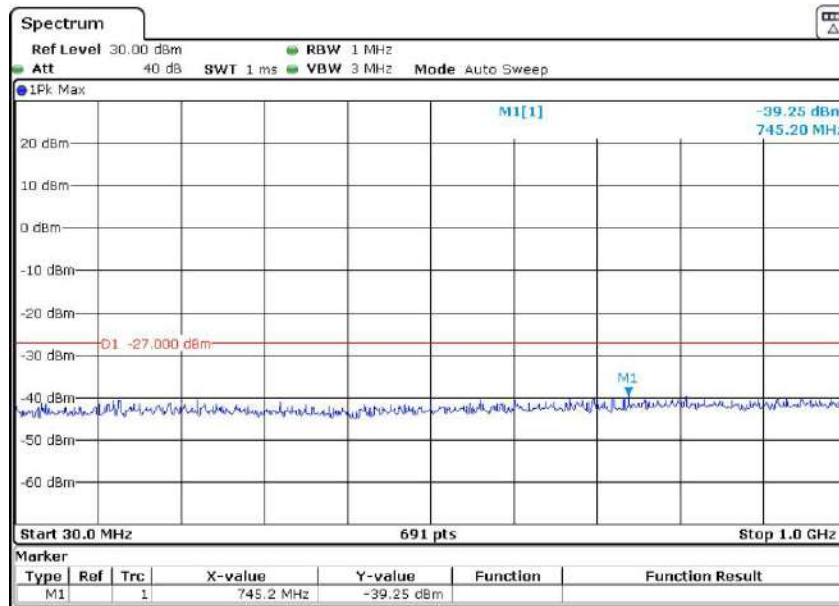

Report No.: AAEMT/EMC/220826-02-09

ac20 5.180 GHz

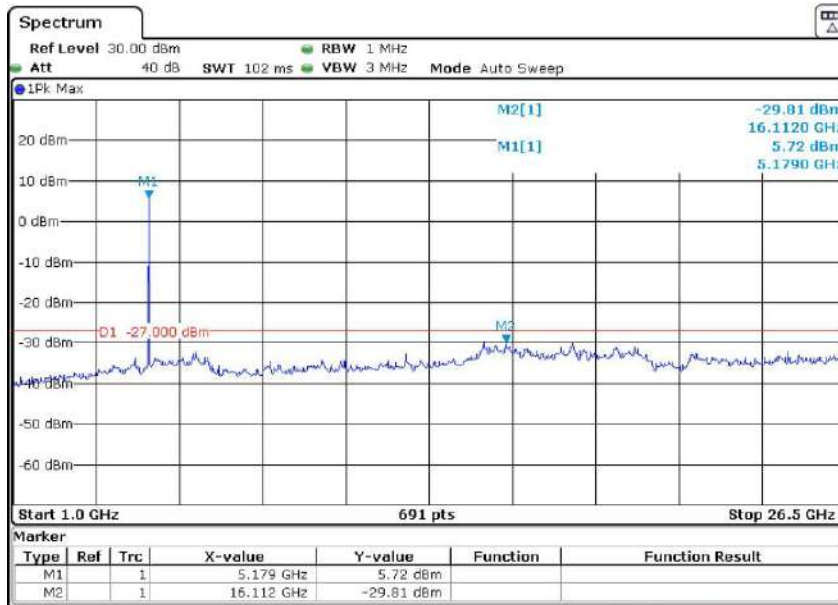
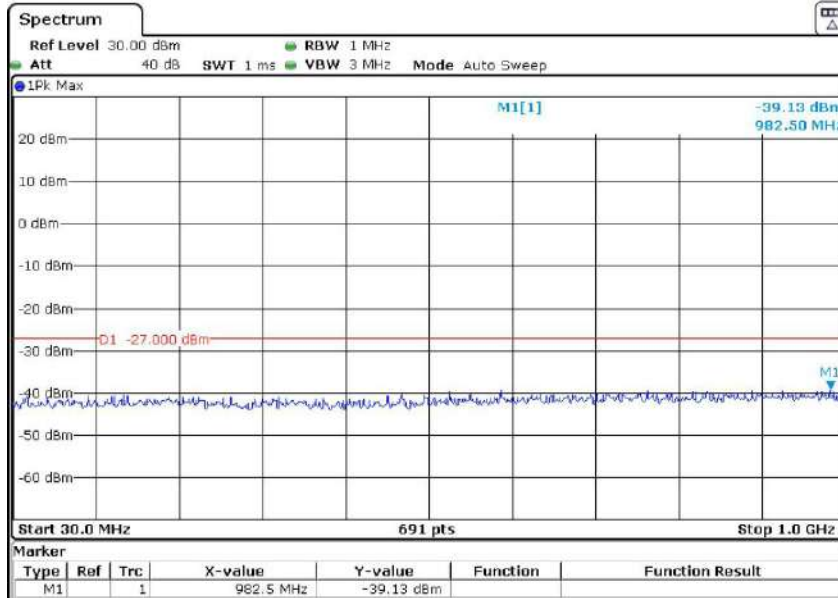

Report No.: AAEMT/EMC/220826-02-09

ac20 5.240GHz

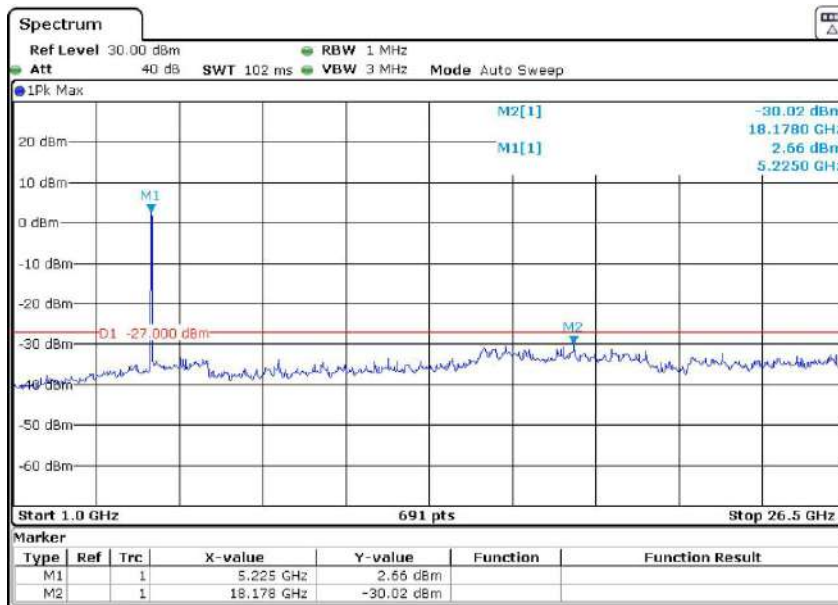
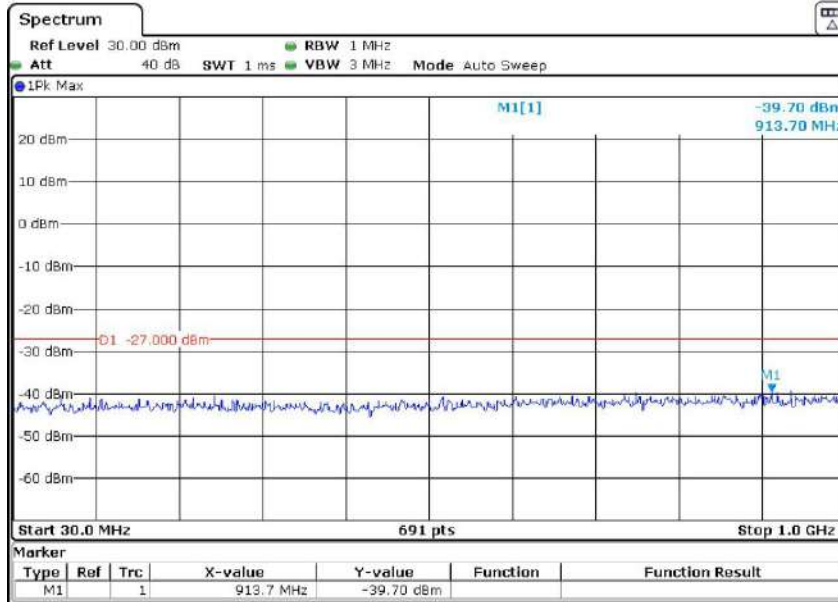

Report No.: AAEMT/EMC/220826-02-09

ac40 5.230GHz

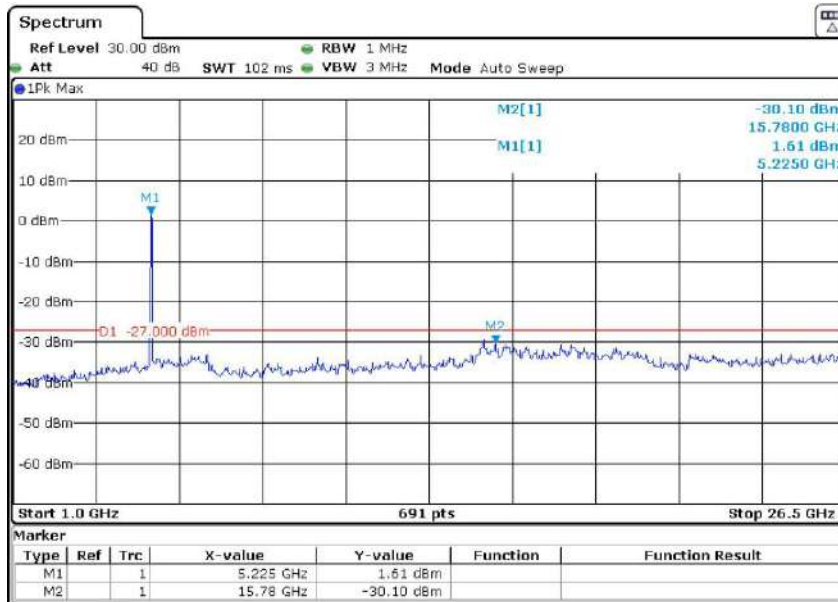
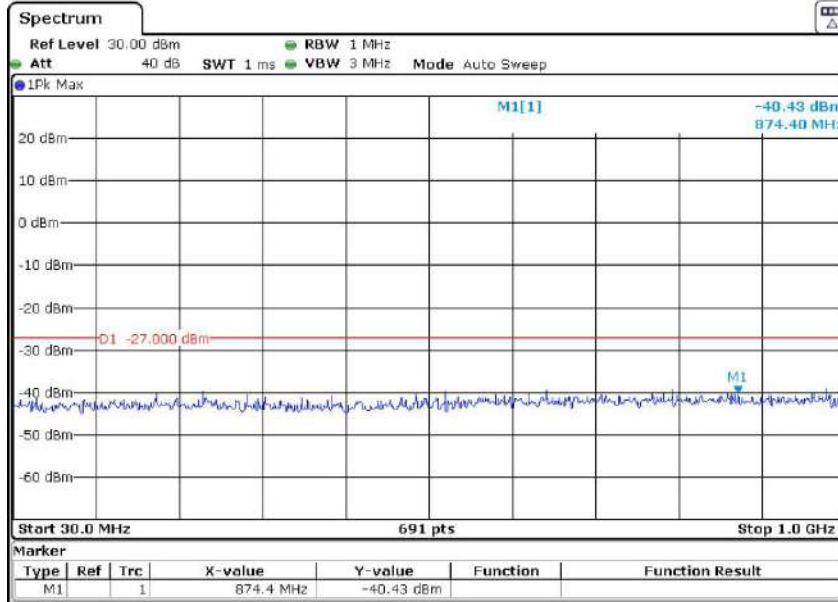

Report No.: AAEMT/EMC/220826-02-09

ac80 5.210 GHz

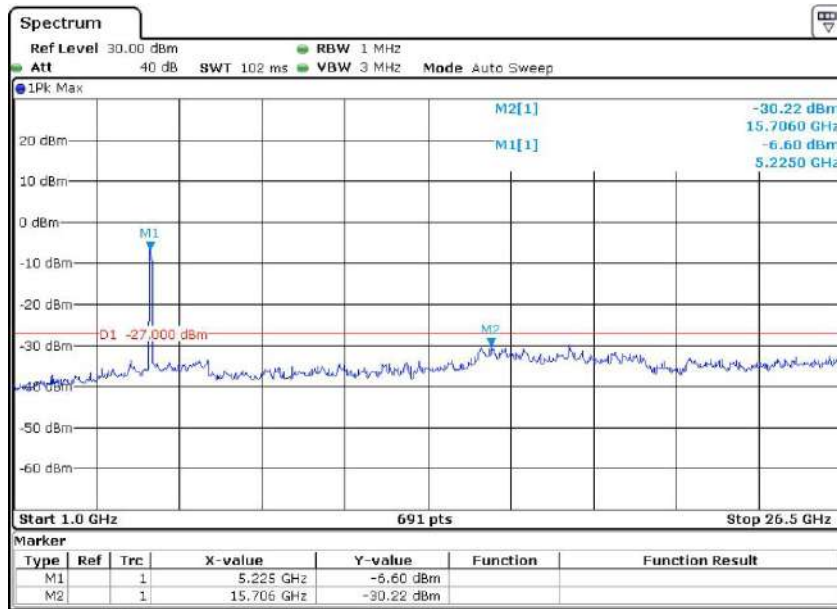
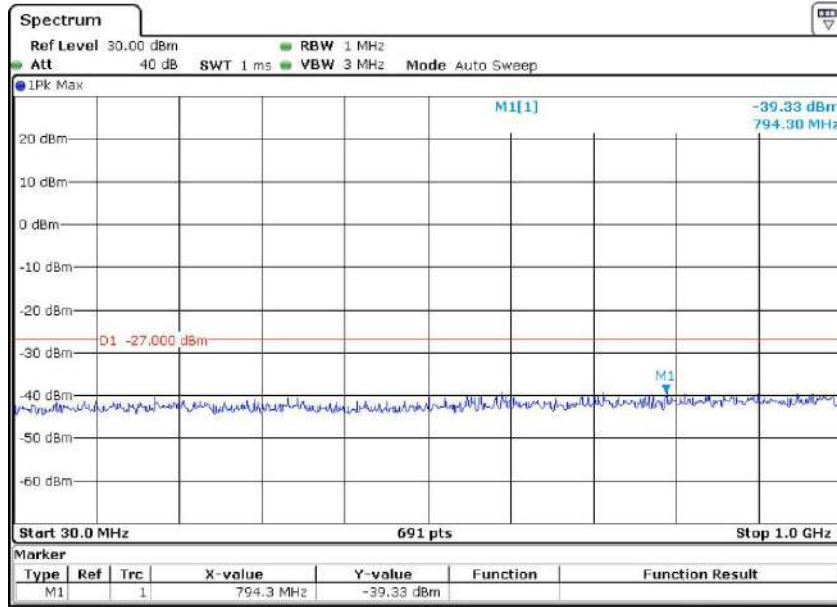

Report No.: AAEMT/EMC/220826-02-09

ax20 5.180 GHz

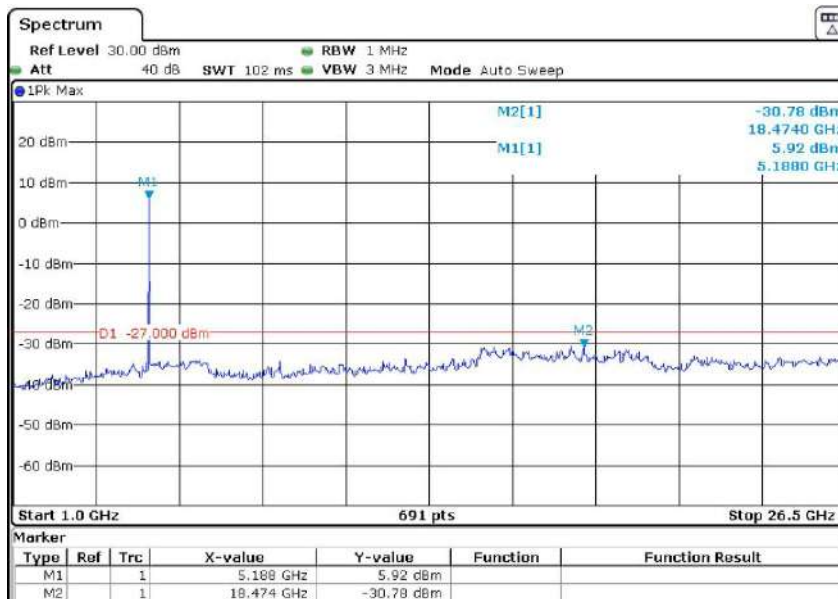
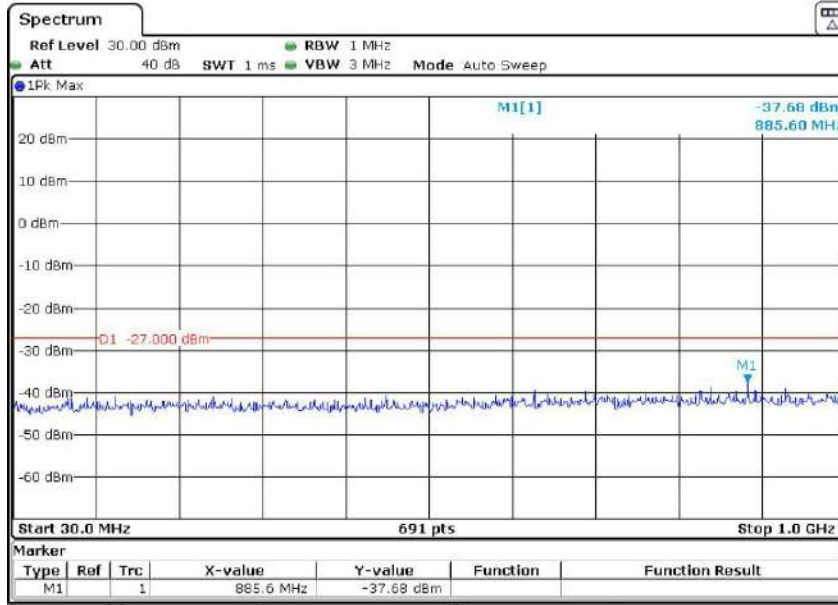

Report No.: AAEMT/EMC/220826-02-09

ax20 5.240 GHz

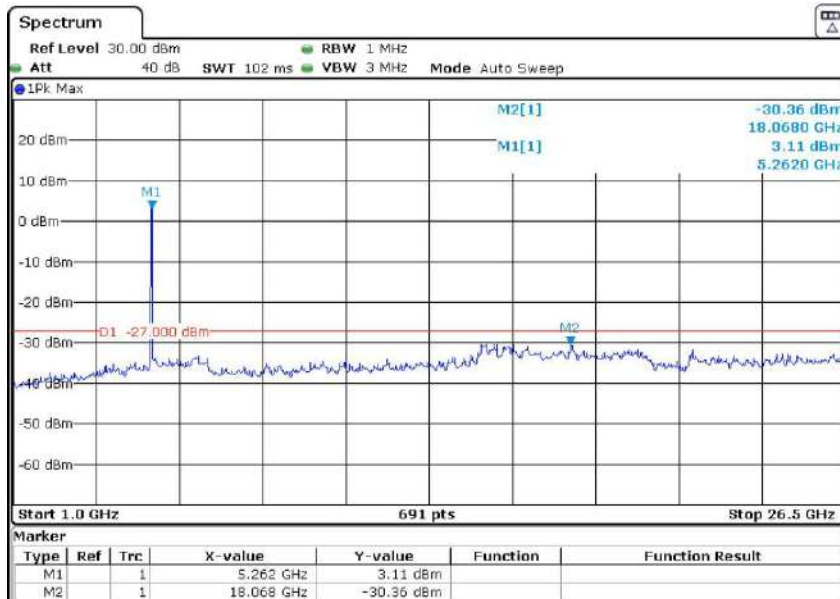
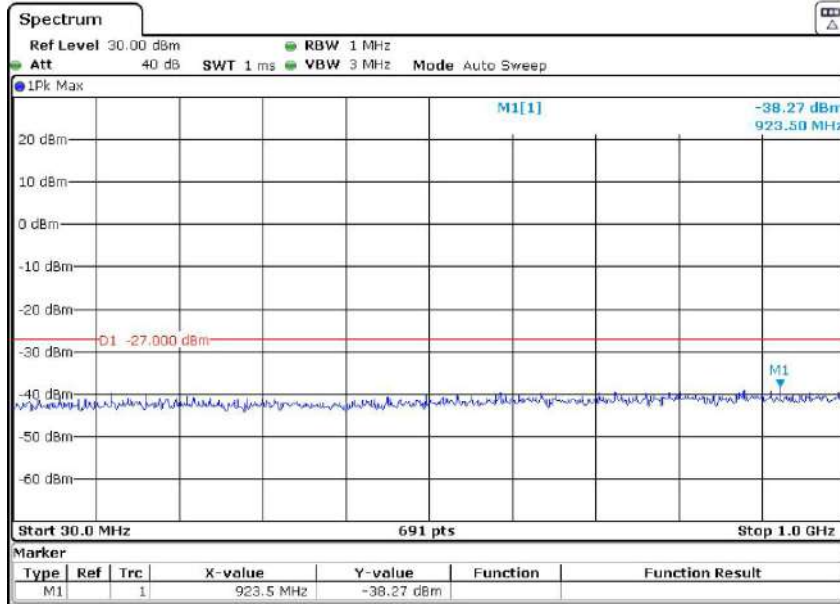

Report No.: AAEMT/EMC/220826-02-09

ax40 5.190 GHz

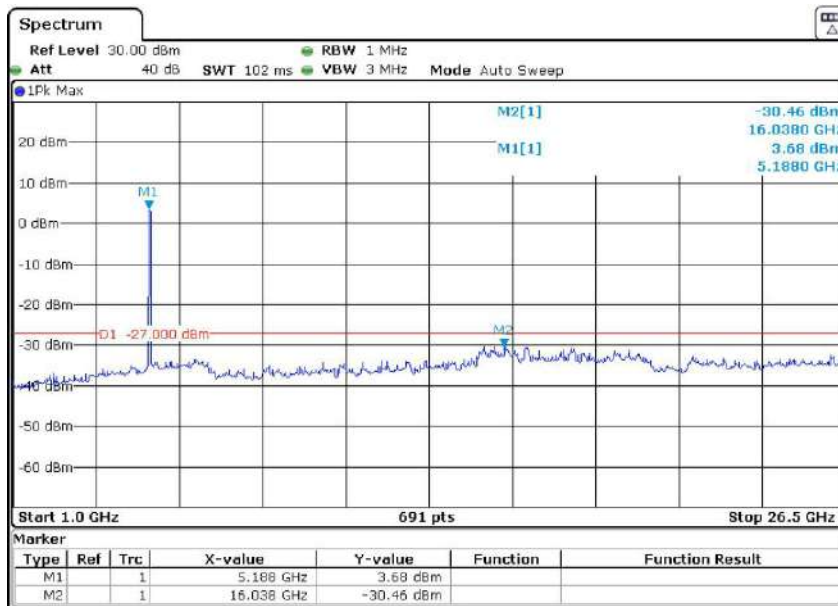
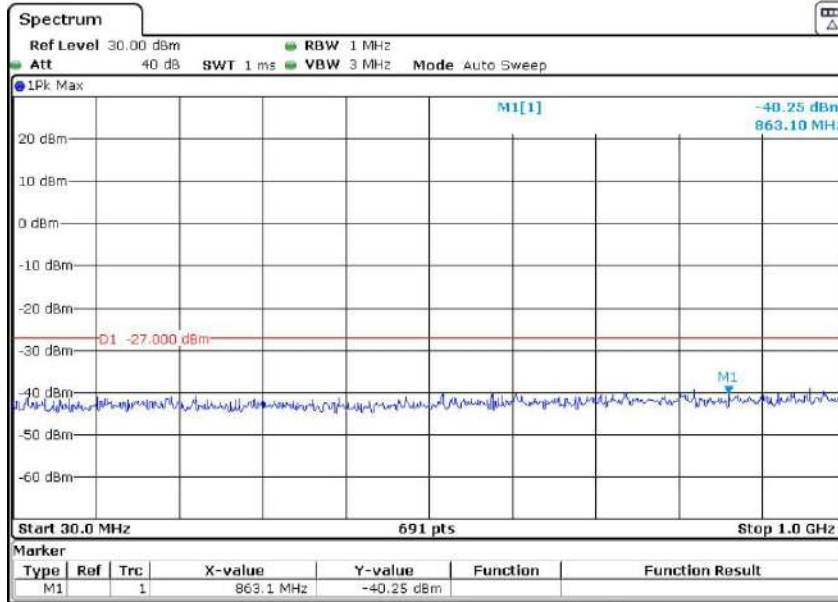

Report No.: AAEMT/EMC/220826-02-09

ax40 5.230 GHz

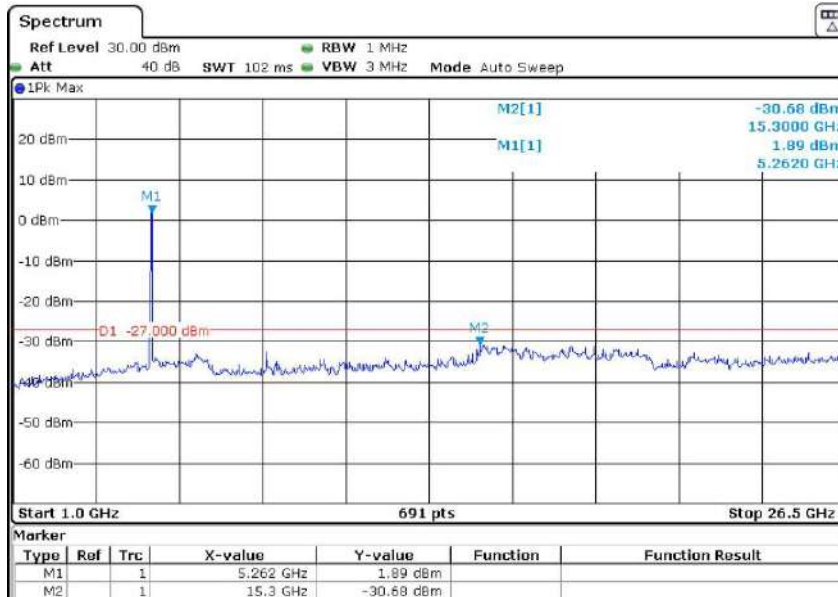
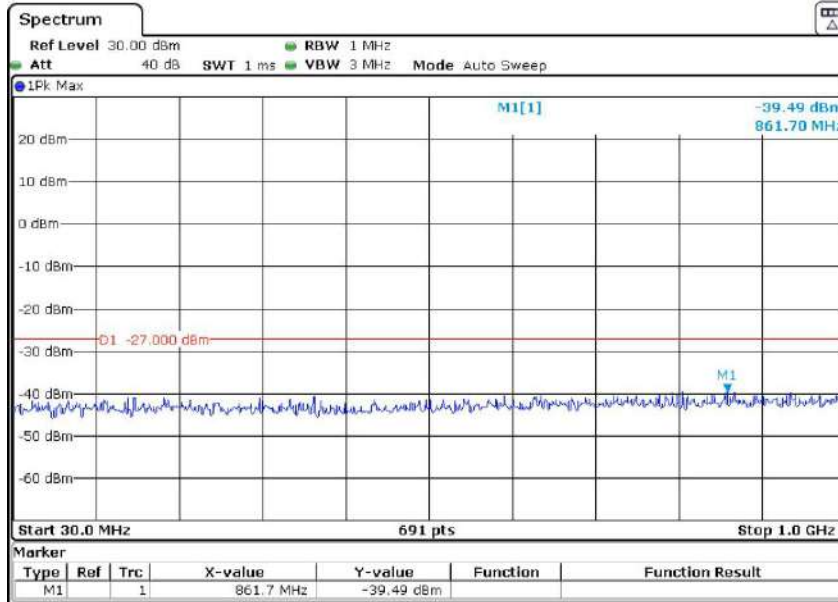

Report No.: AAEMT/EMC/220826-02-09

ax80 5.210 GHz

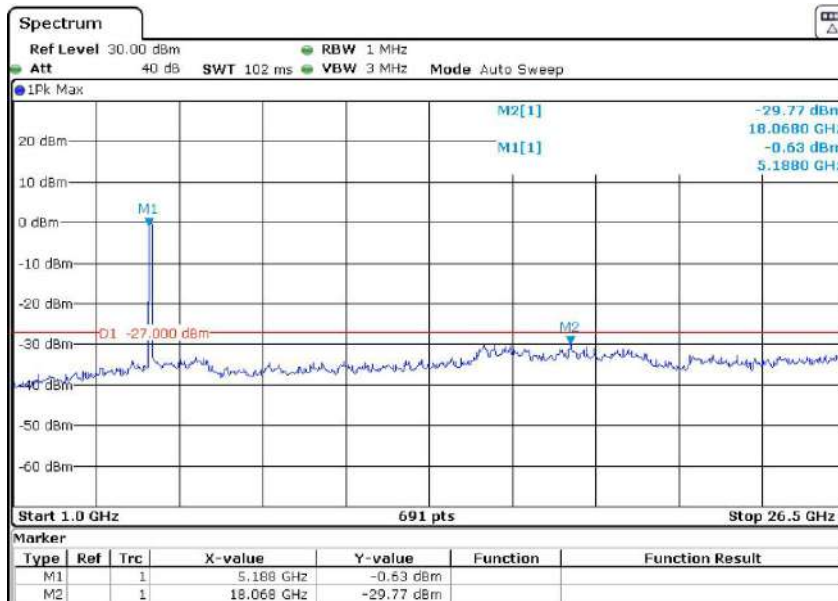
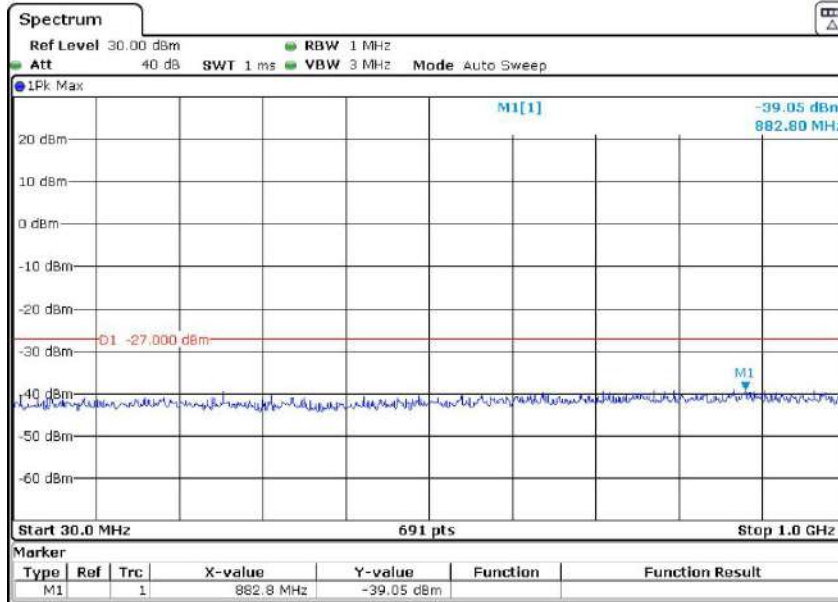

Result plot as follows: CHAIN 0

a20 5.745 GHz

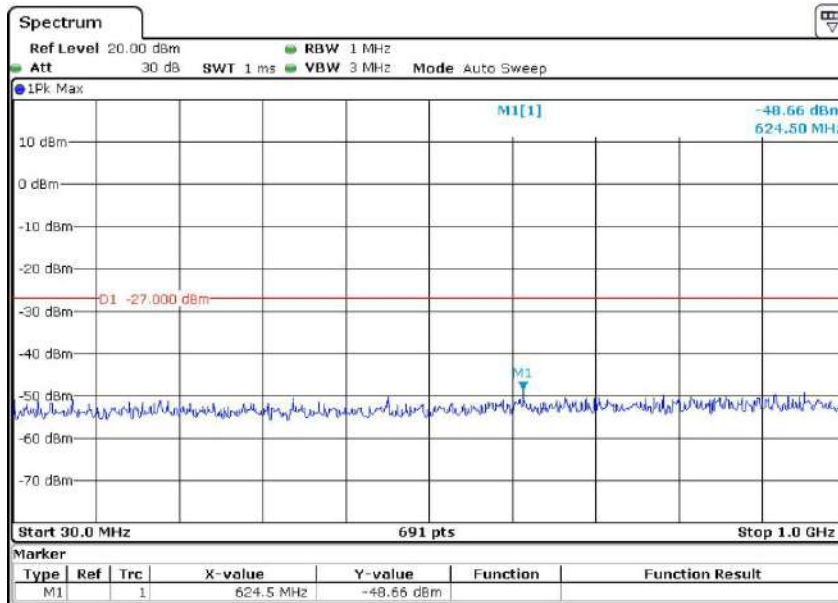
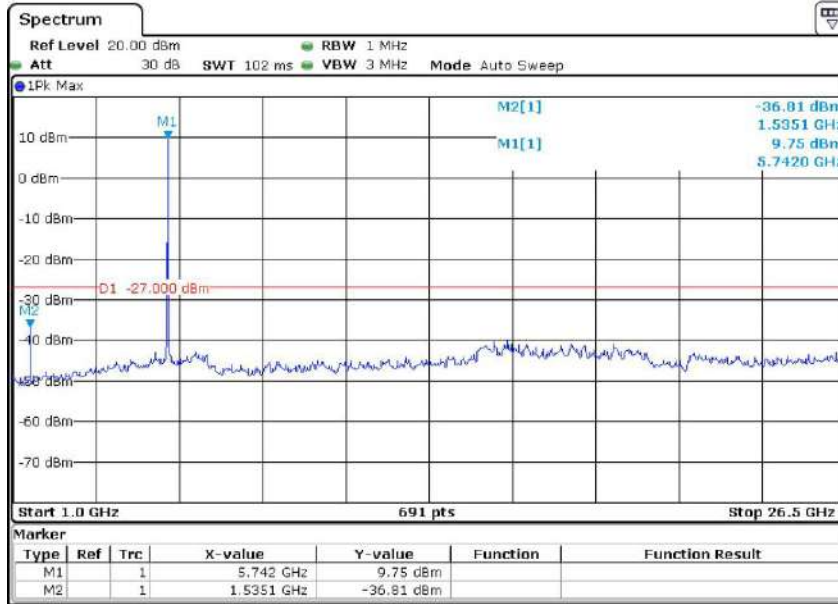

Report No.: AAEMT/EMC/220826-02-09

a20 5.825 GHz

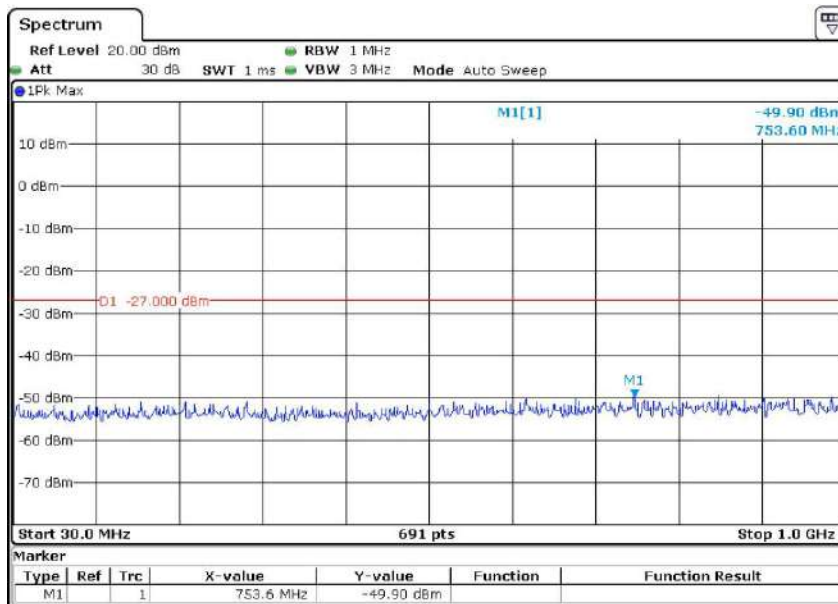
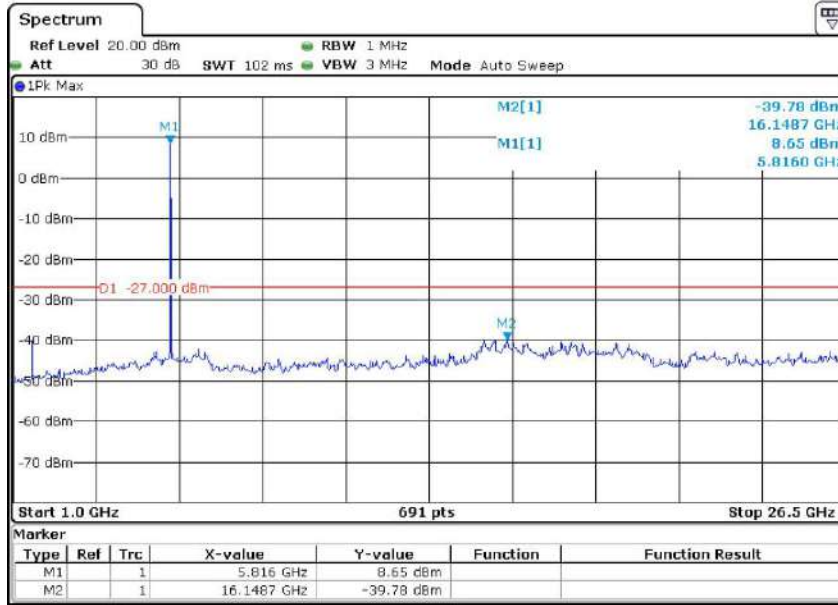

Report No.: AAEMT/EMC/220826-02-09

n20 5.745 GHz

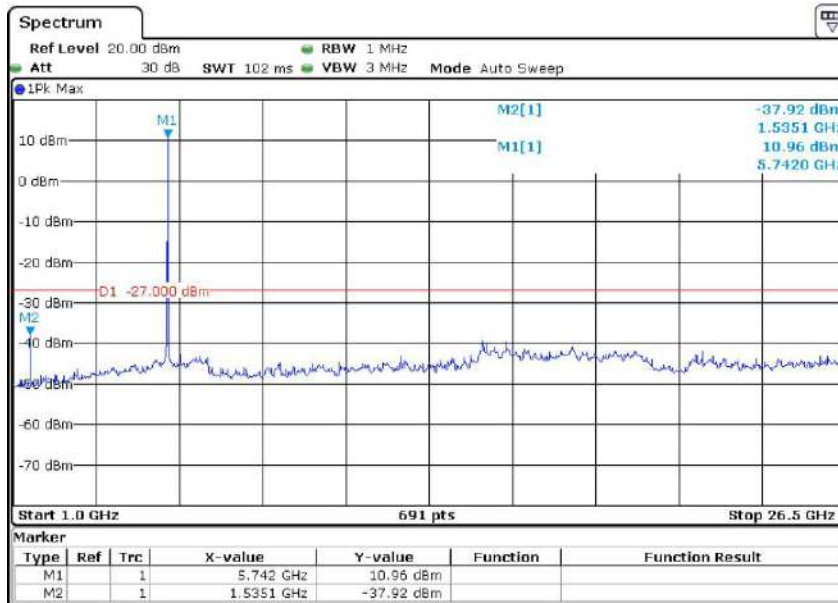
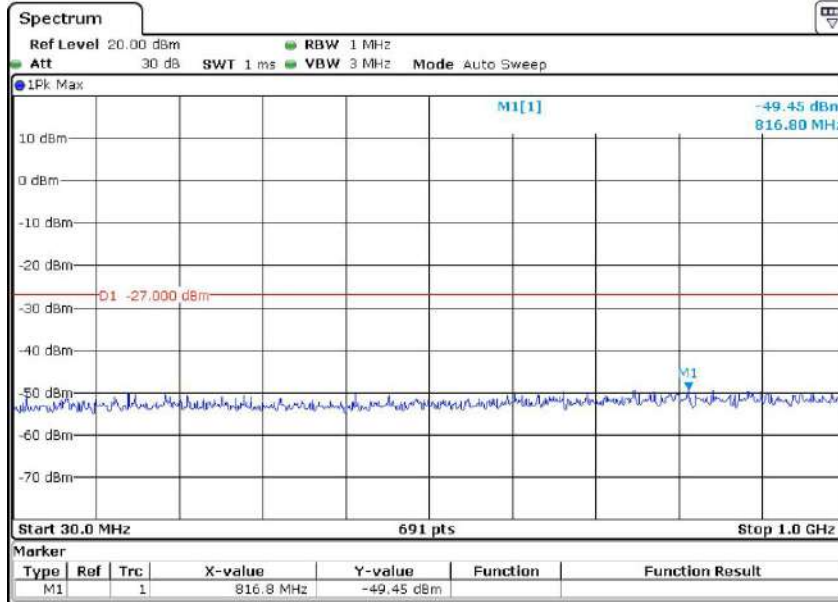

Report No.: AAEMT/EMC/220826-02-09

n20 5.825 GHz

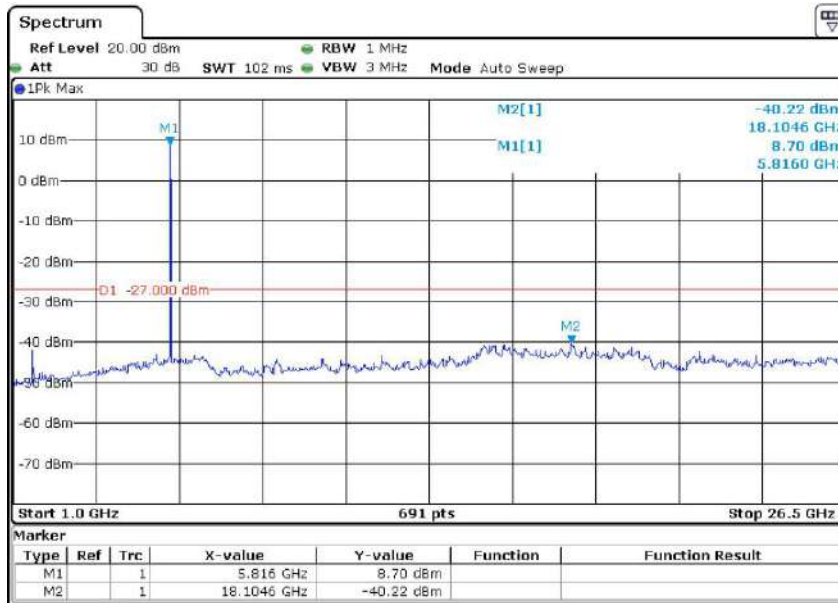
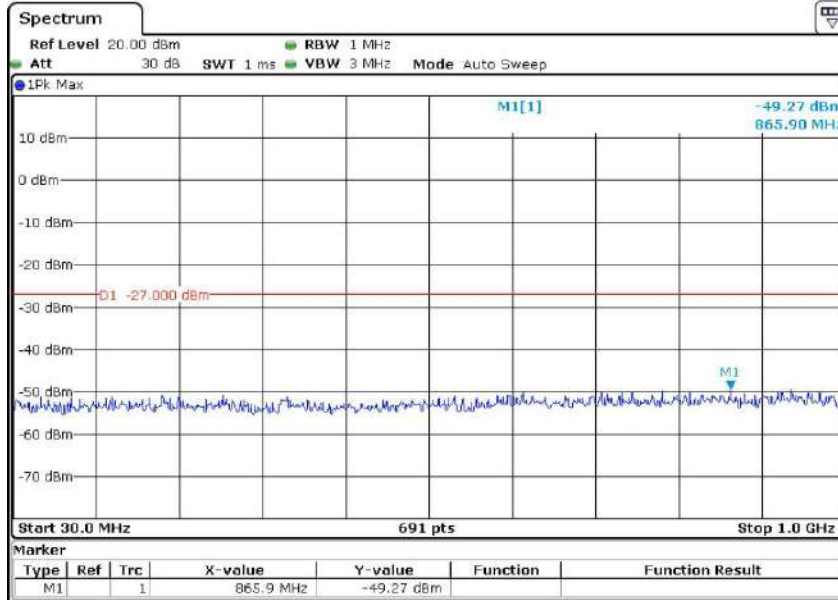

Report No.: AAEMT/EMC/220826-02-09

n40 5.755 GHz

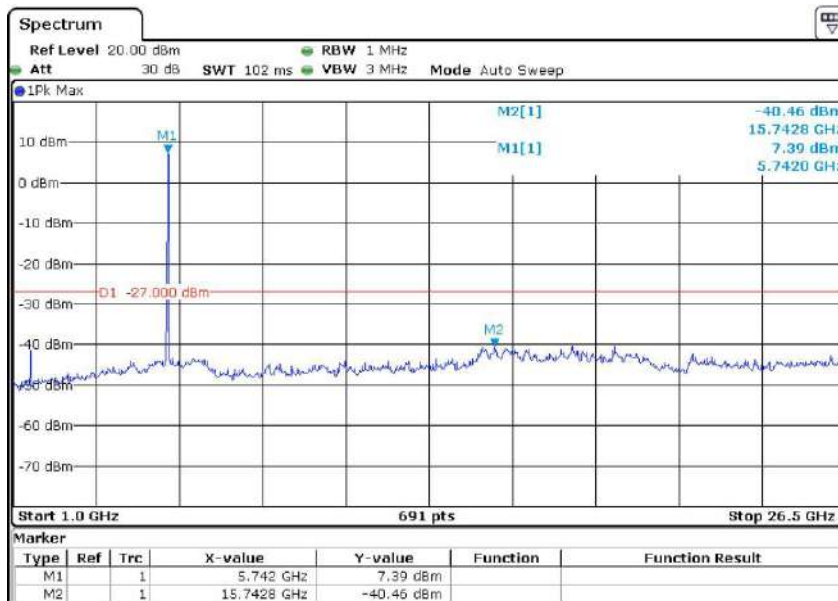
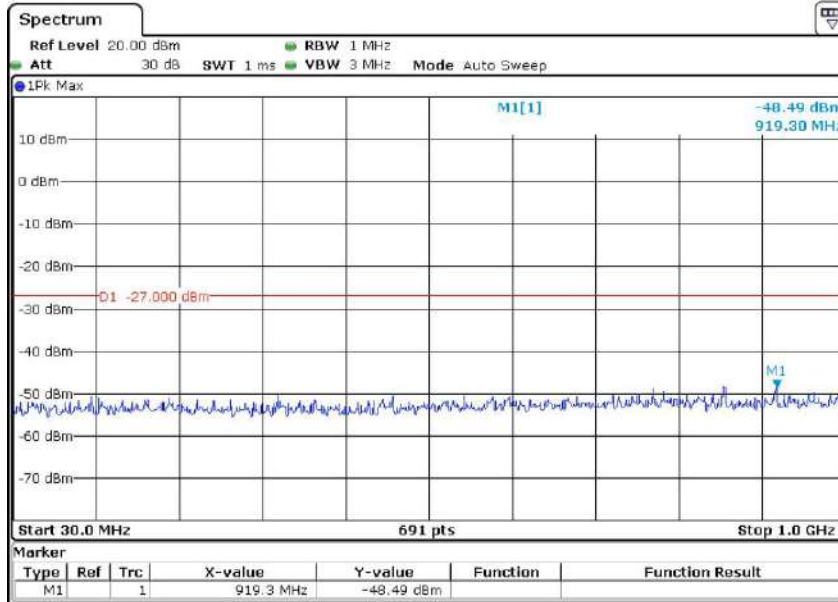

Report No.: AAEMT/EMC/220826-02-09

n40 5.795 GHz

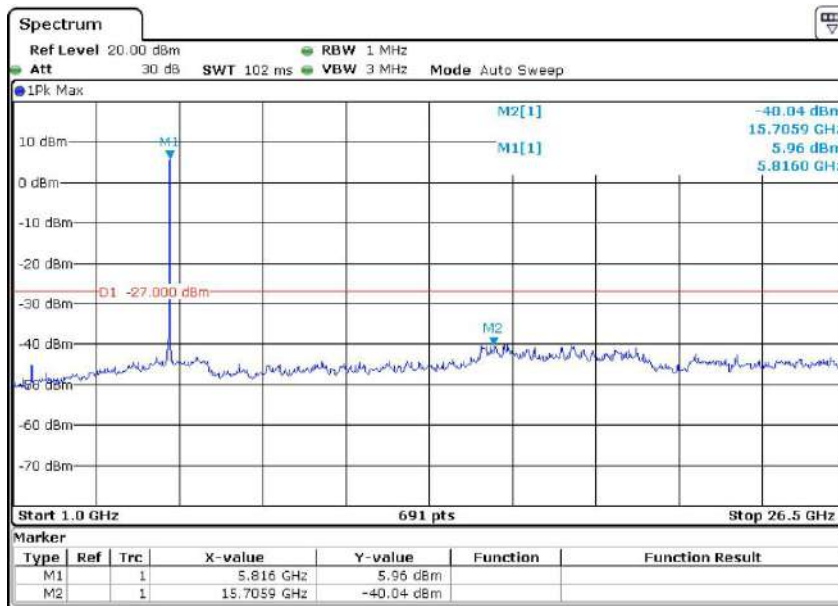
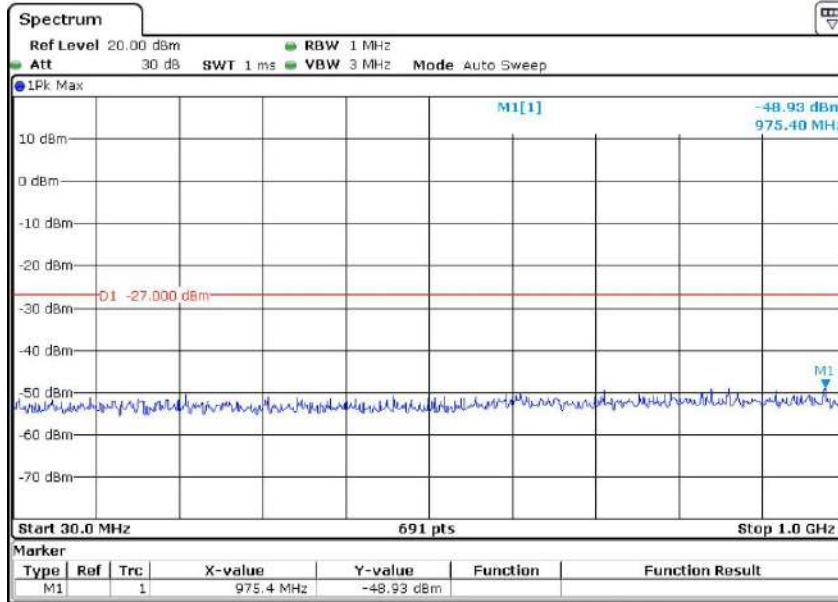

Report No.: AAEMT/EMC/220826-02-09

ac20 5.745 GHz

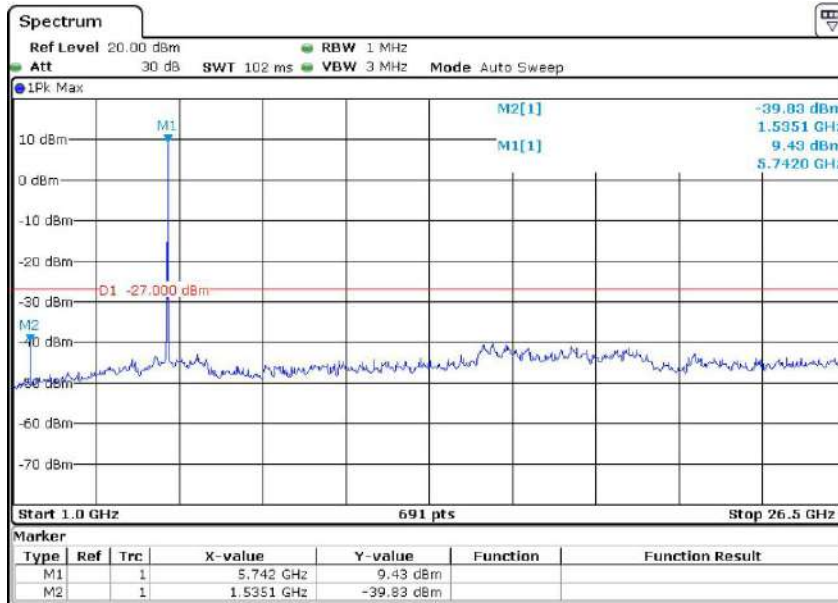
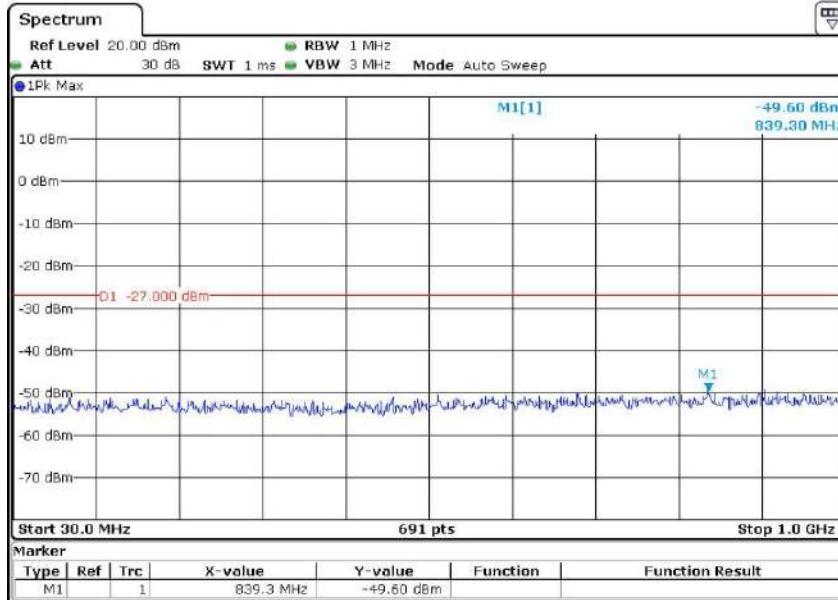

Report No.: AAEMT/EMC/220826-02-09

ac20 5.825 GHz

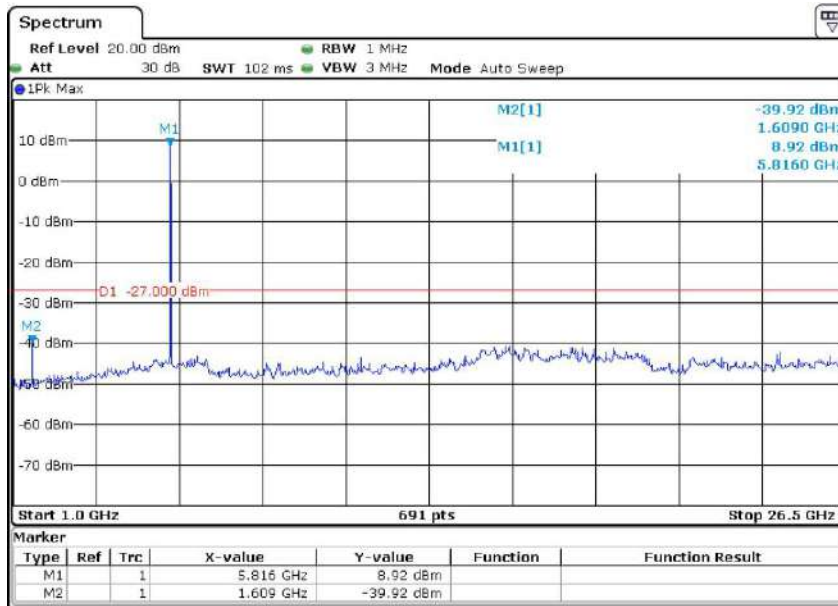
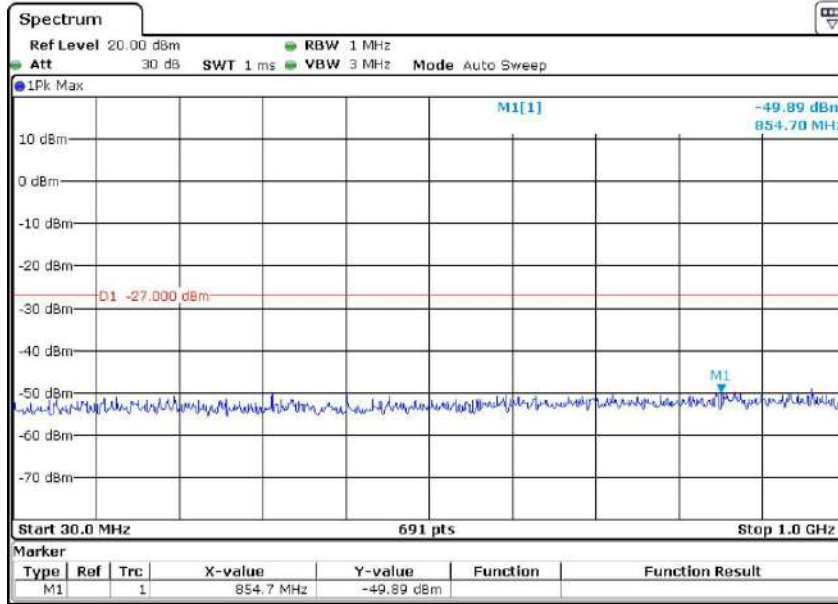

Report No.: AAEMT/EMC/220826-02-09

ac40 5.755 GHz

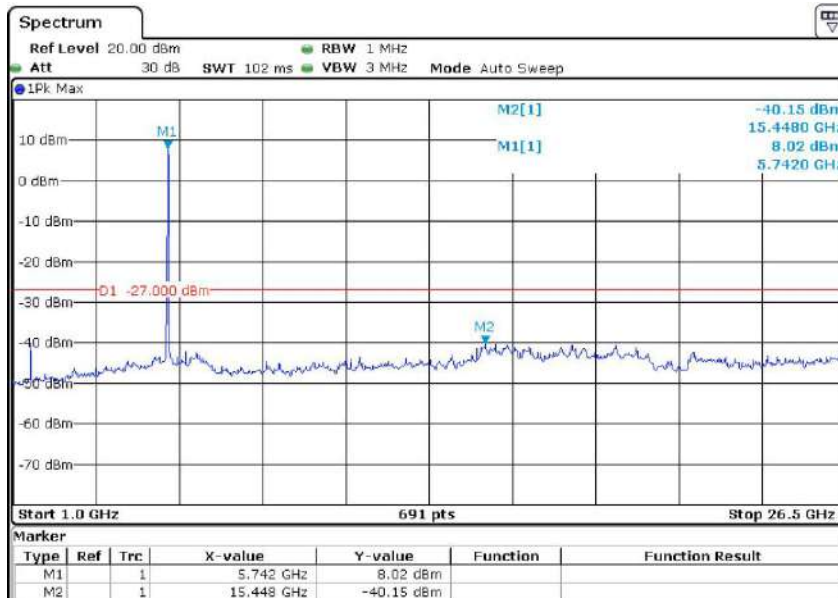
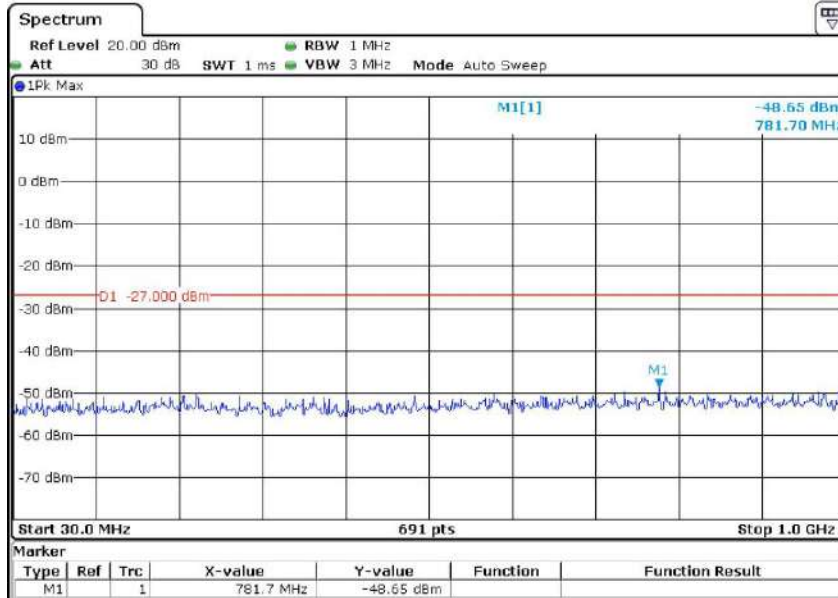

Report No.: AAEMT/EMC/220826-02-09

ac40 5.795 GHz

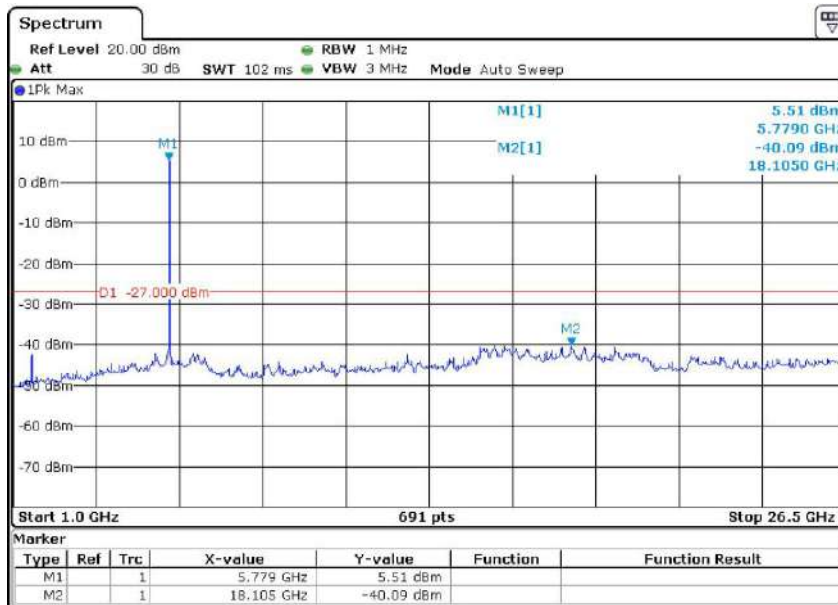
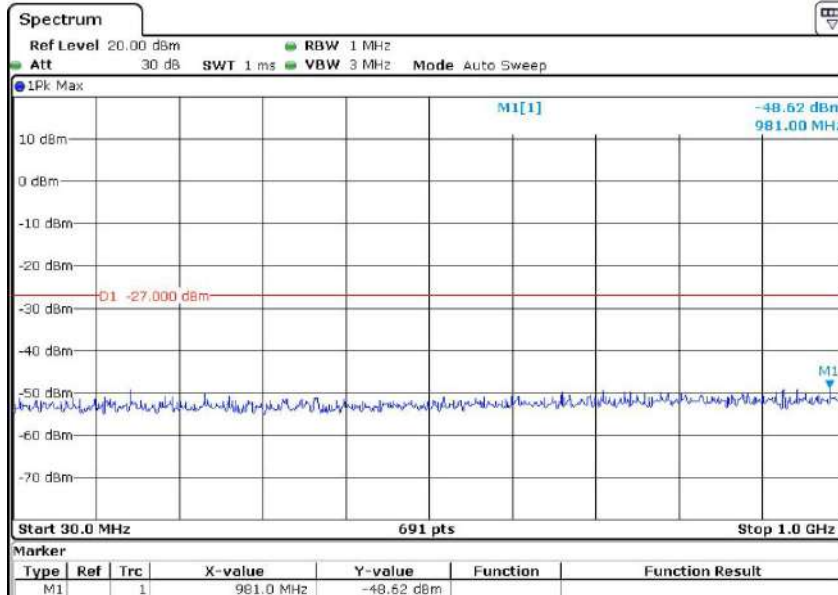

Report No.: AAEMT/EMC/220826-02-09

ac80 5.775 GHz

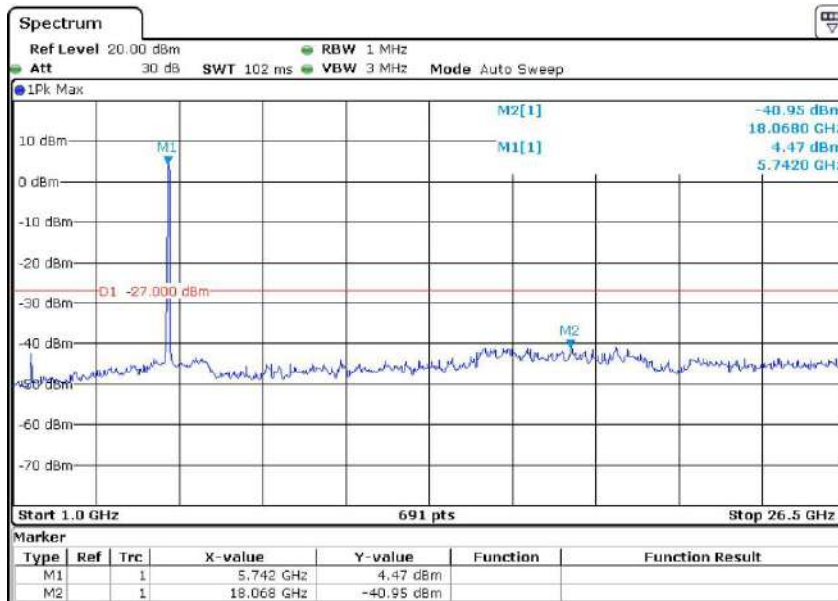
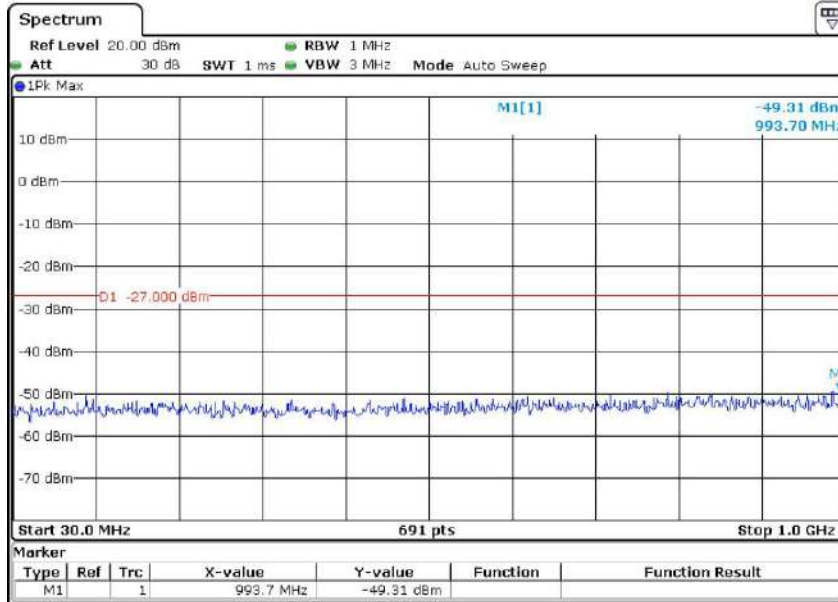

Report No.: AAEMT/EMC/220826-02-09

ax20 5.745 GHz

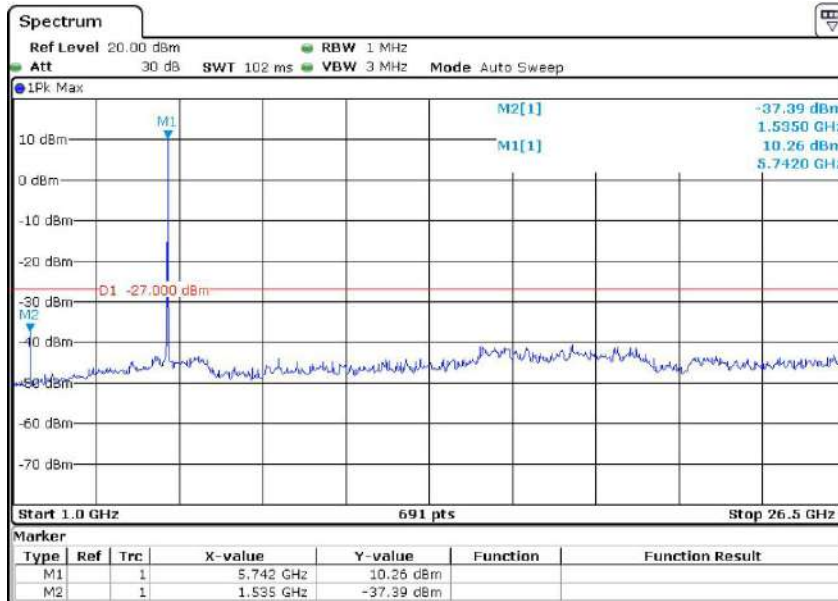
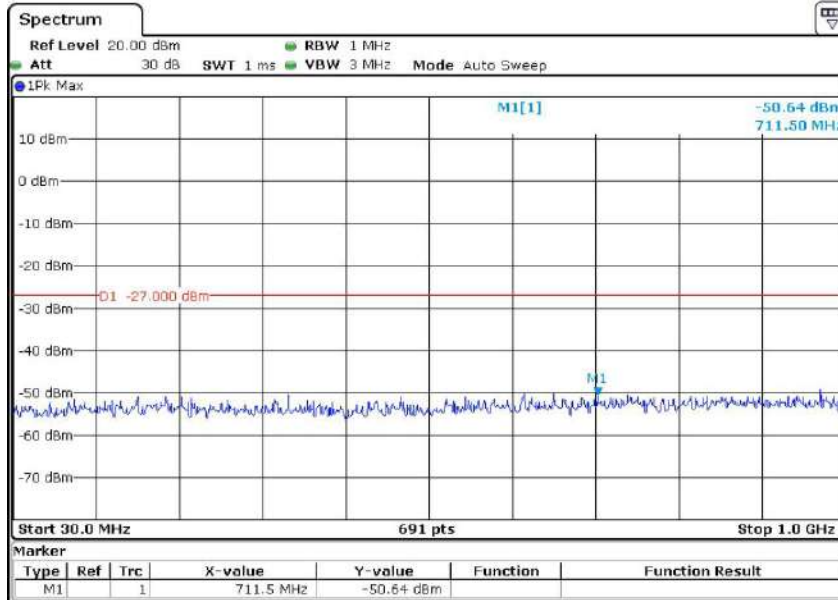

Report No.: AAEMT/EMC/220826-02-09

ax20 5.825 GHz

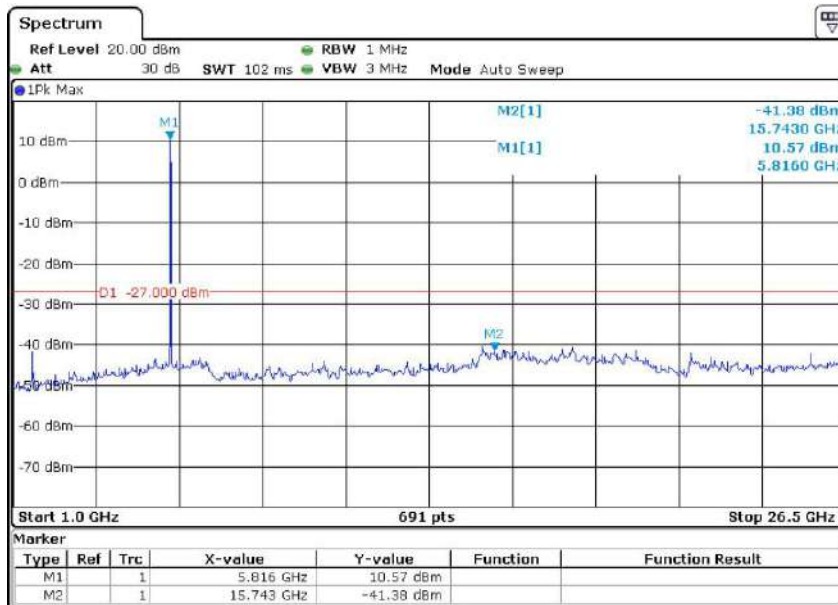
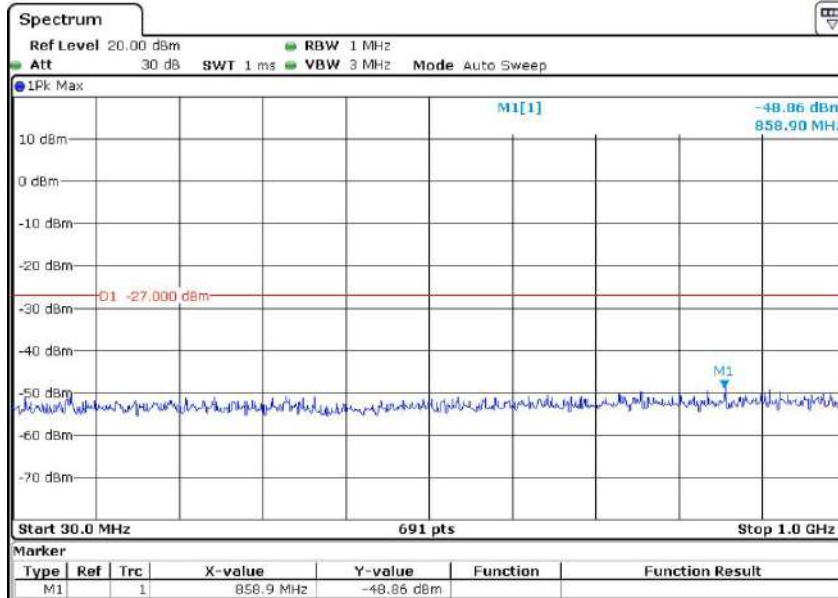

Report No.: AAEMT/EMC/220826-02-09

ax40 5.755 GHz

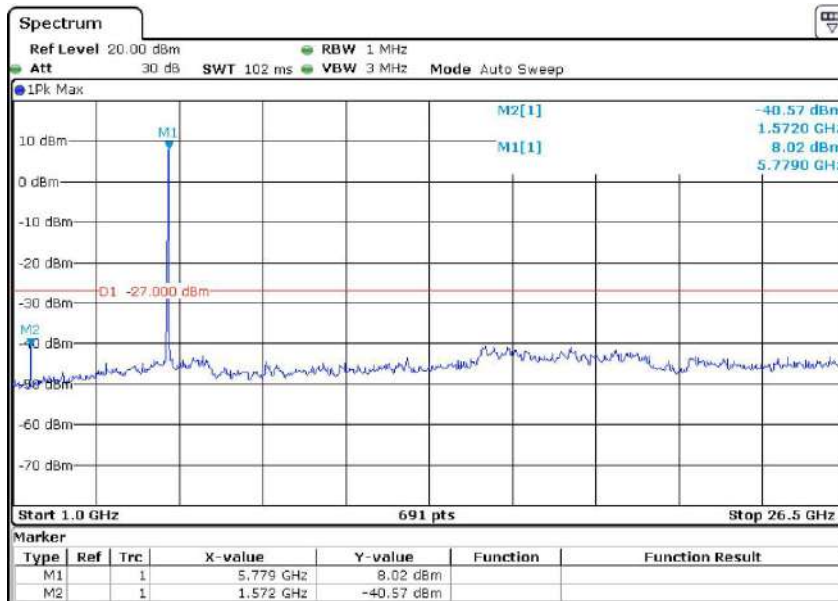
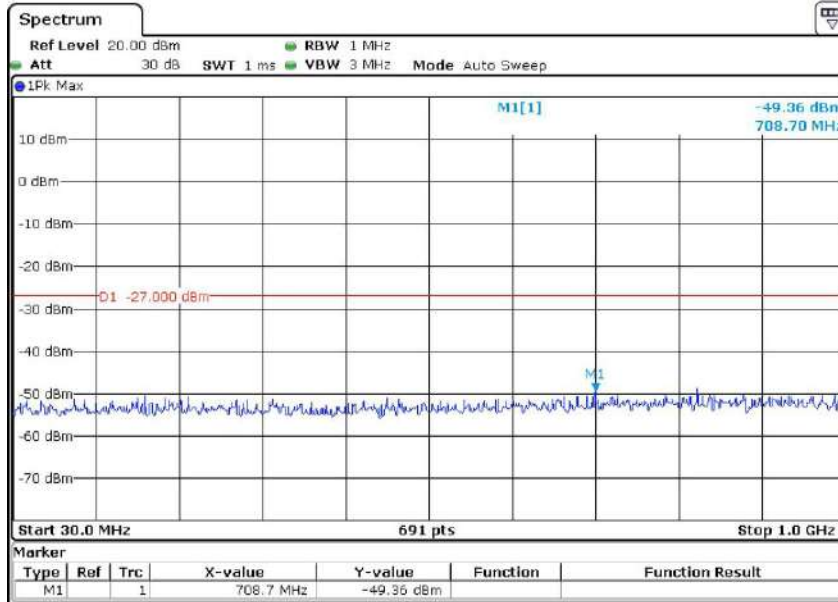

Report No.: AAEMT/EMC/220826-02-09

ax40 5.795 GHz

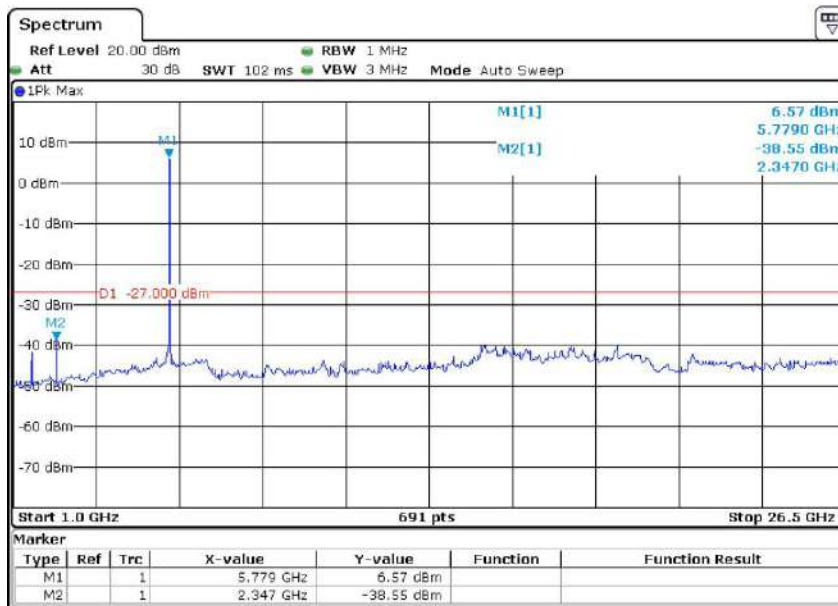
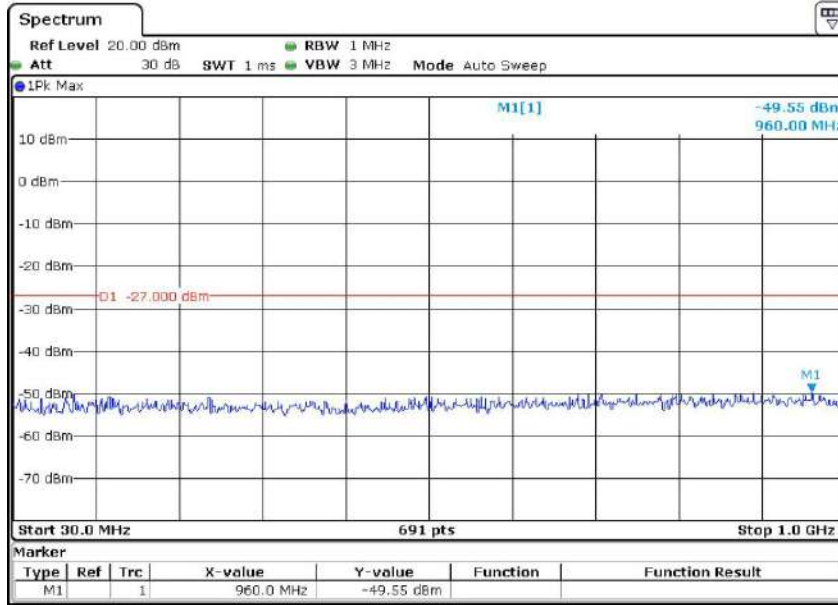

Report No.: AAEMT/EMC/220826-02-09

ax80 5.775 GHz

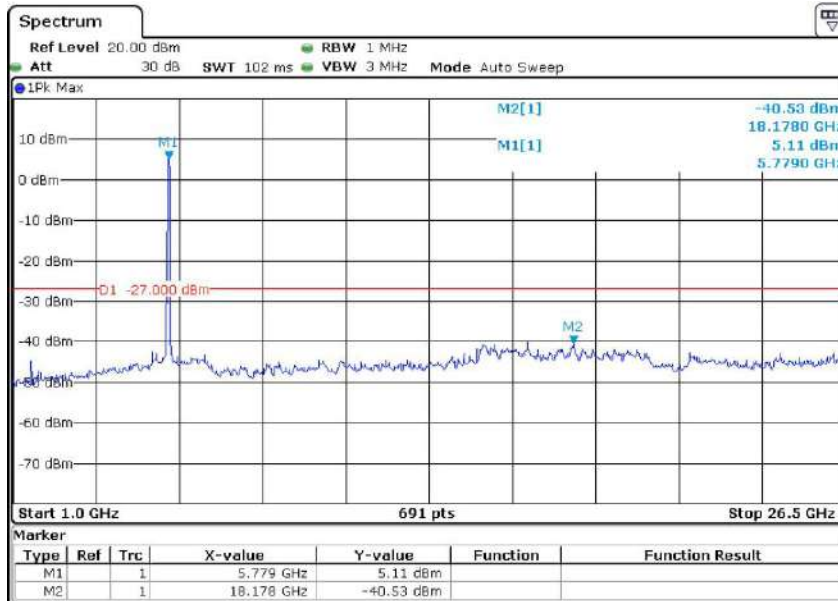
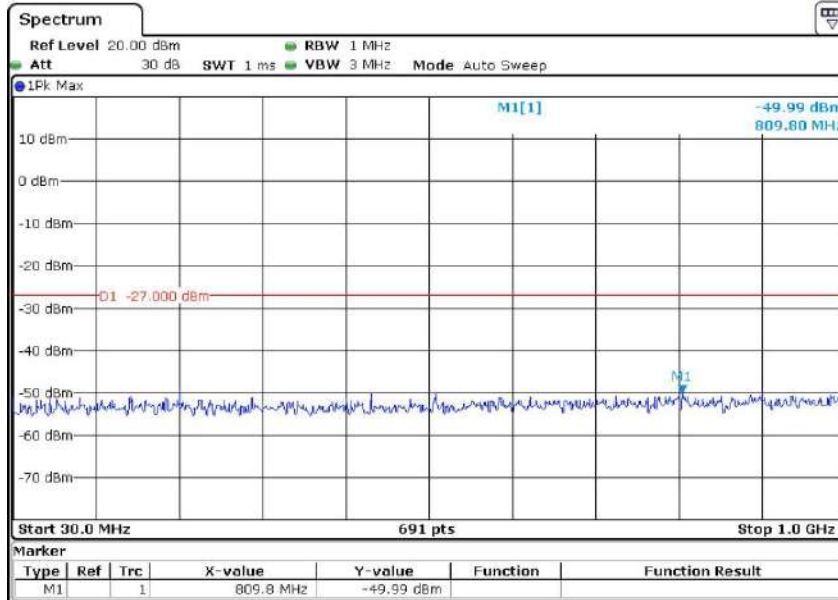

Report No.: AAEMT/EMC/220826-02-09

Result plot as follows: CHAIN 1

a20 5.180 GHz

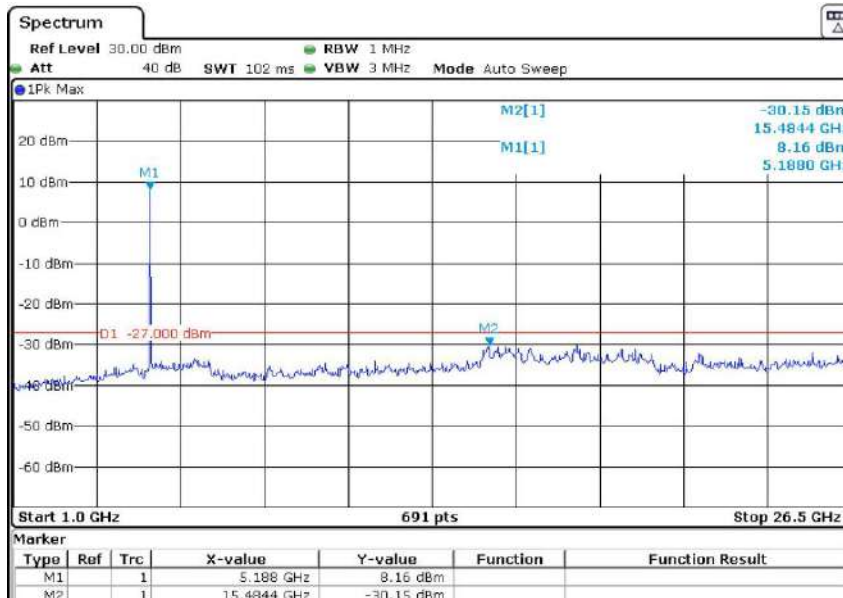
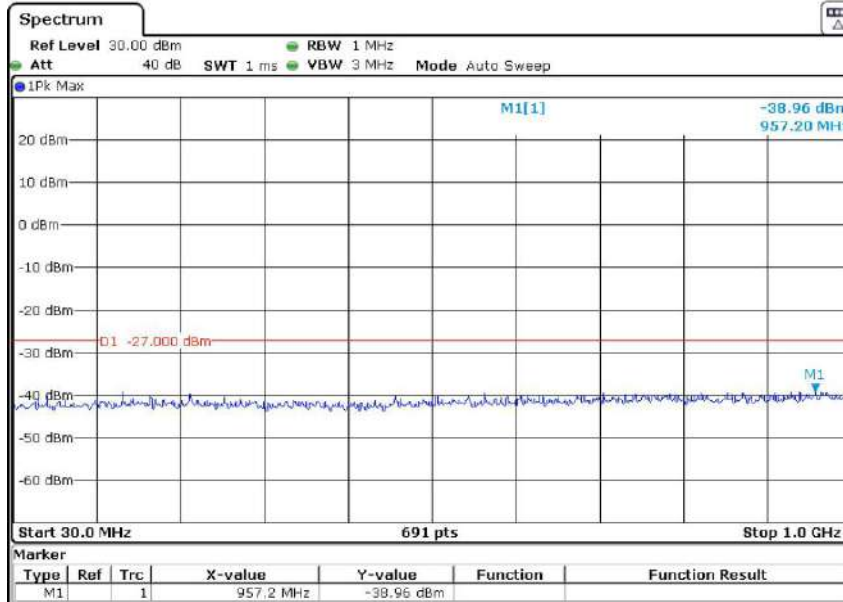

Report No.: AAEMT/EMC/220826-02-09

a20 5.240 GHz

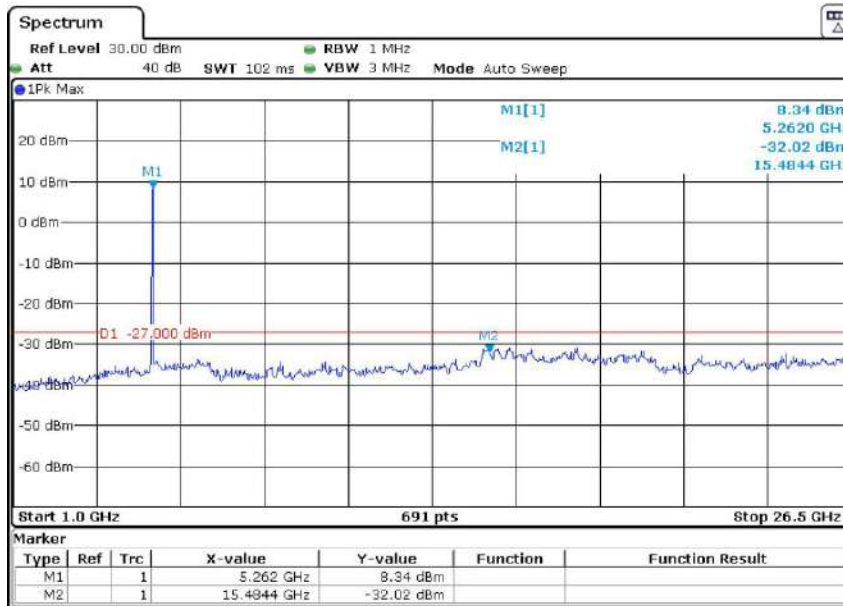
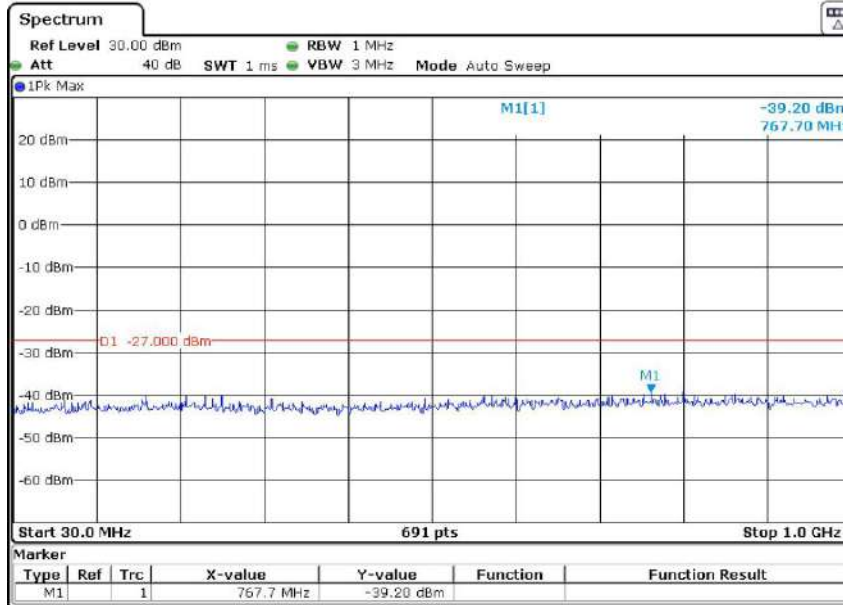

Report No.: AAEMT/EMC/220826-02-09

n20 5.180 GHz

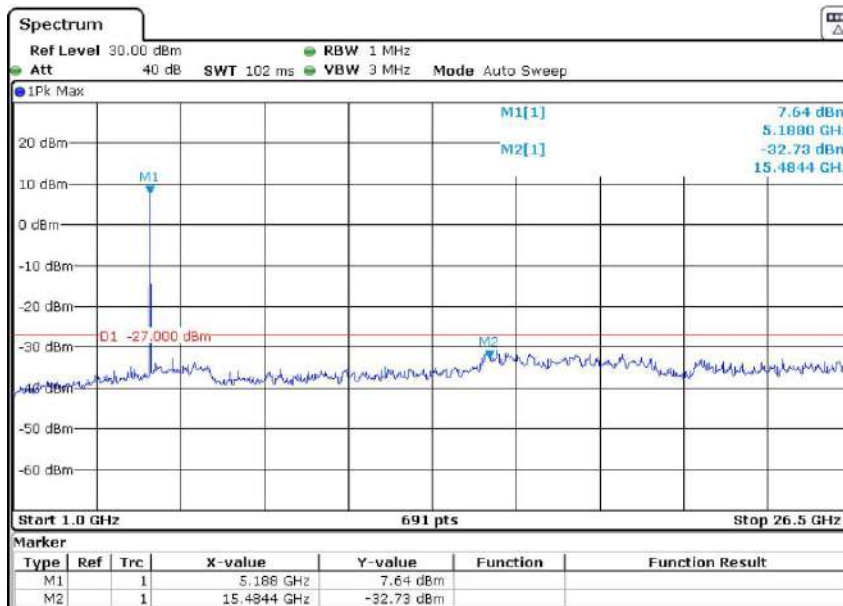
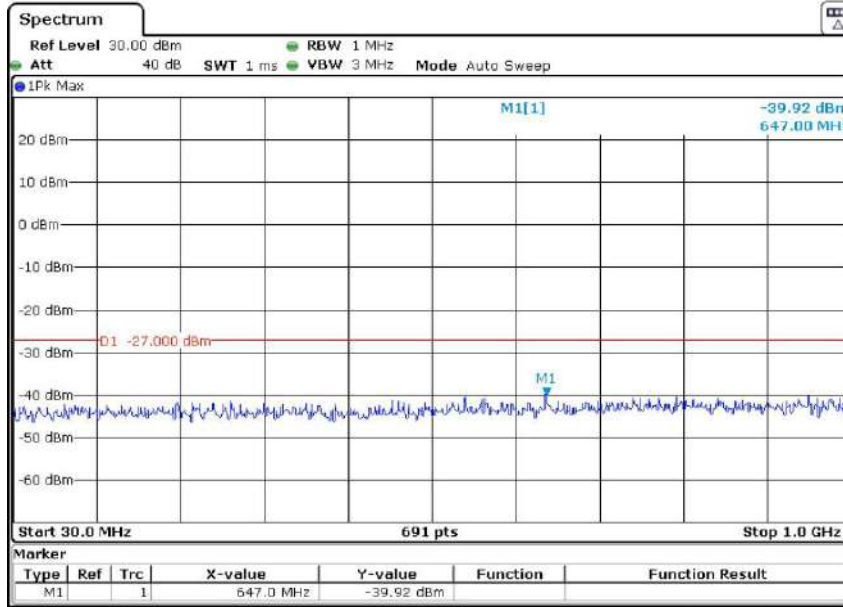

Report No.: AAEMT/EMC/220826-02-09

n20 5.240 GHz

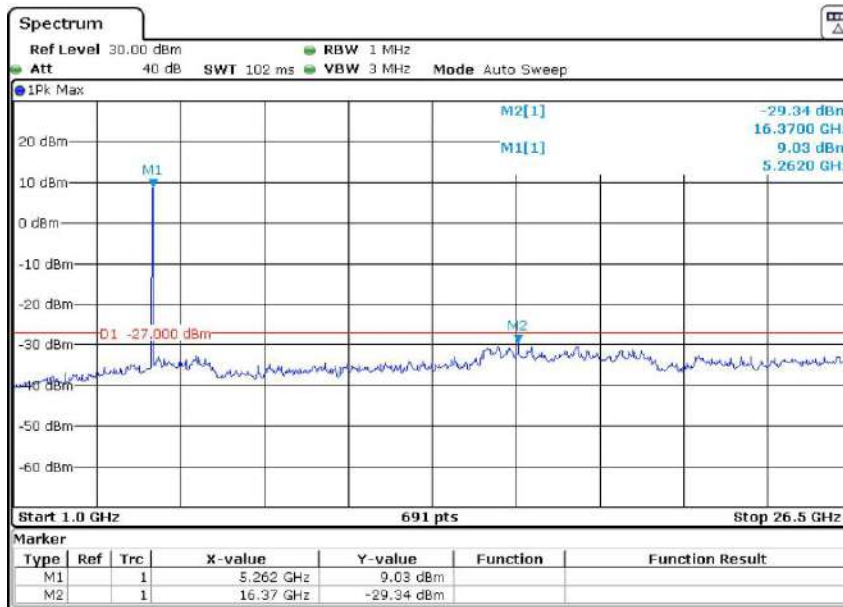
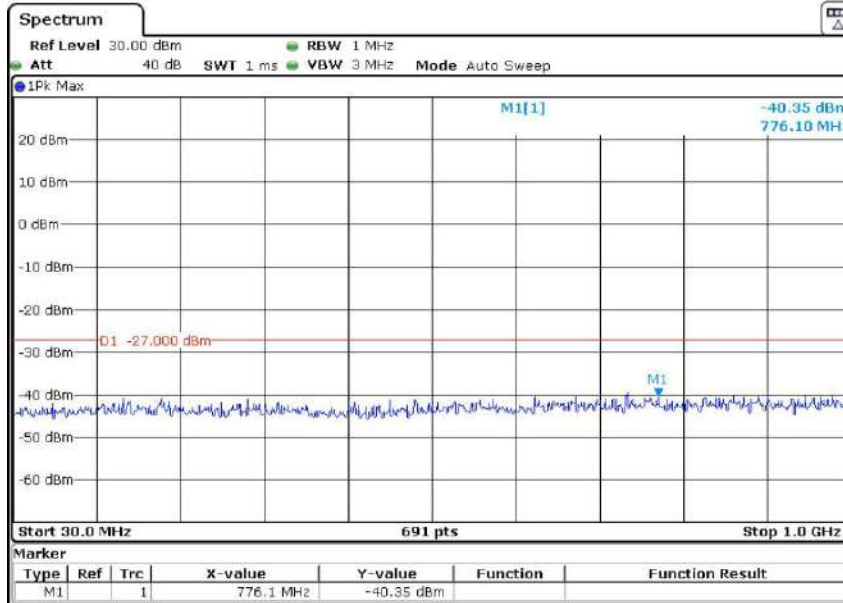

Report No.: AAEMT/EMC/220826-02-09

n40 5.190 GHz

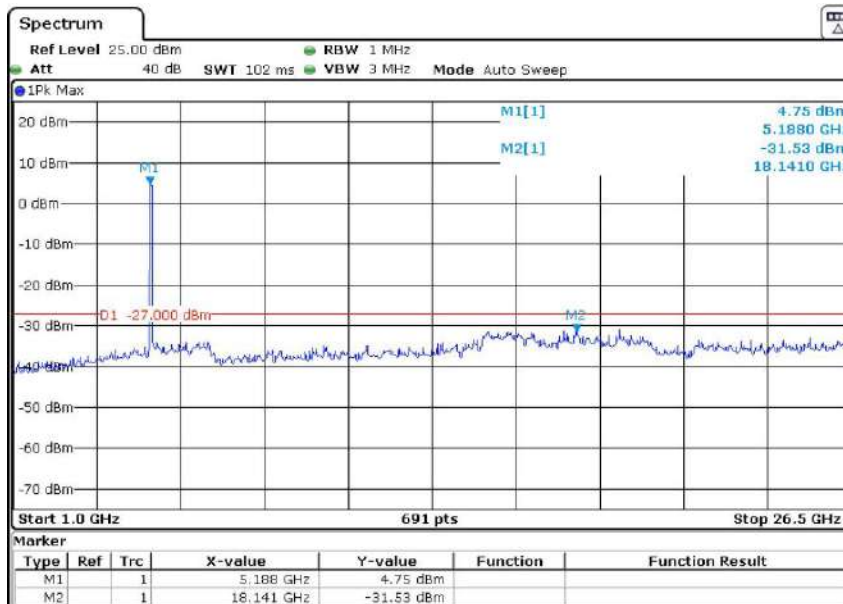
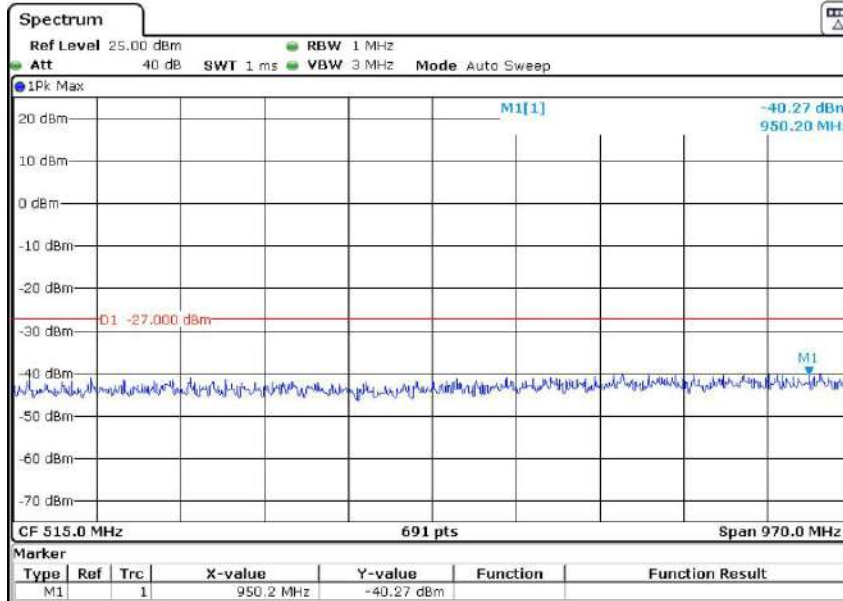

Report No.: AAEMT/EMC/220826-02-09

n40 5.230 GHz

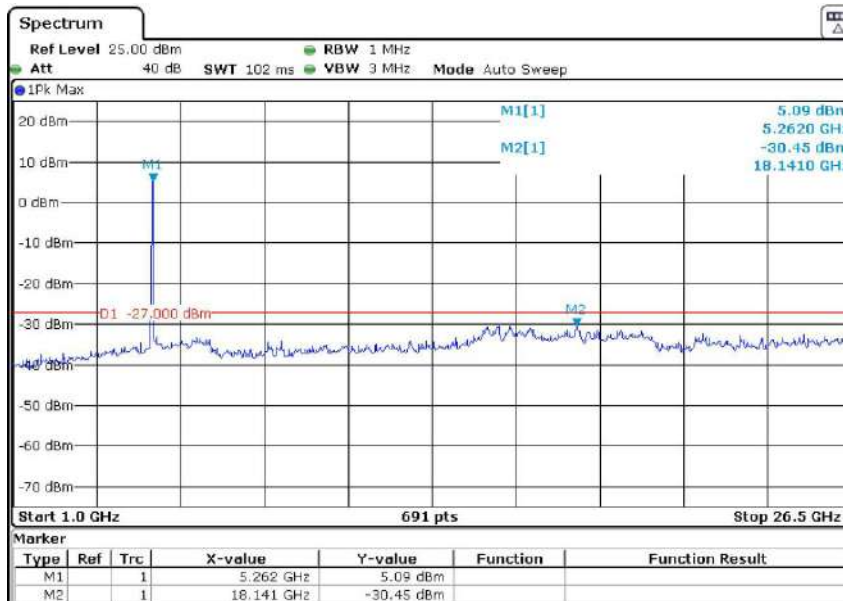
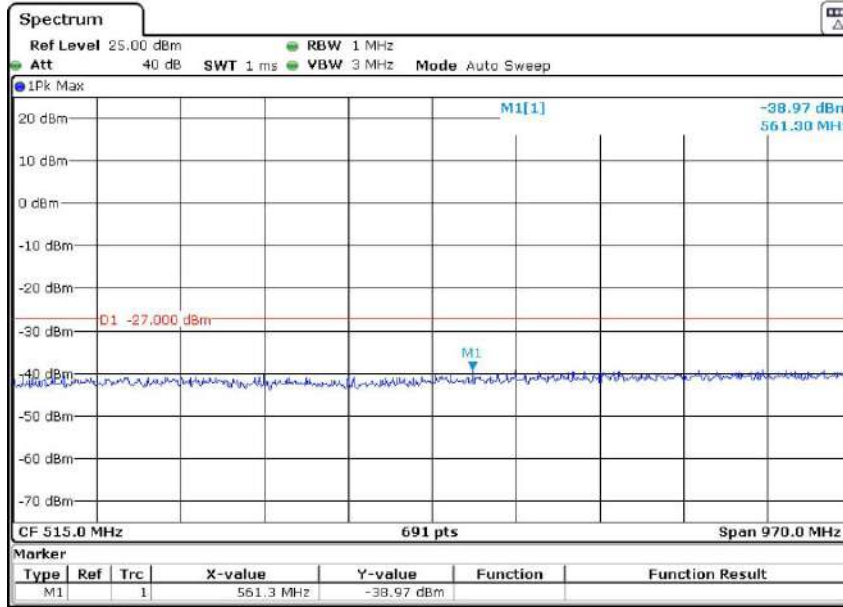

Report No.: AAEMT/EMC/220826-02-09

ac20 5.180 GHz

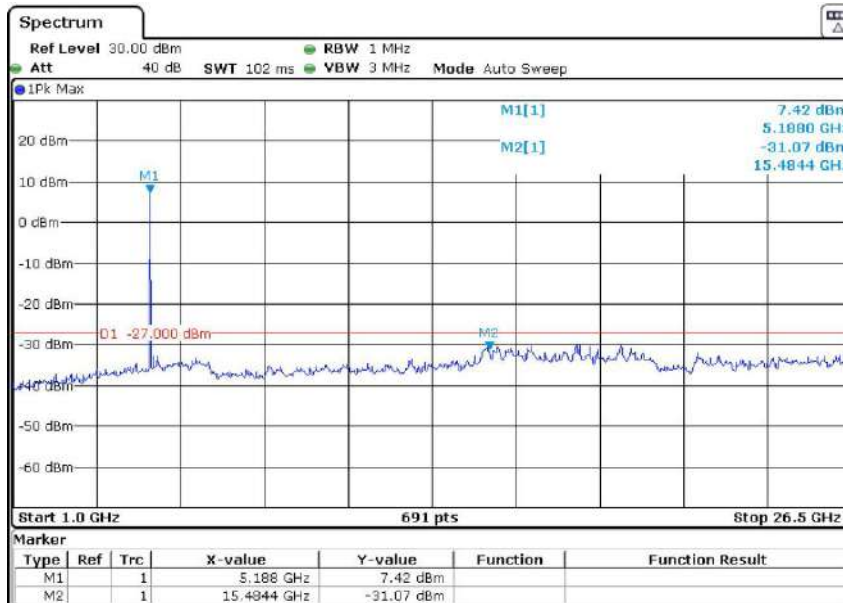
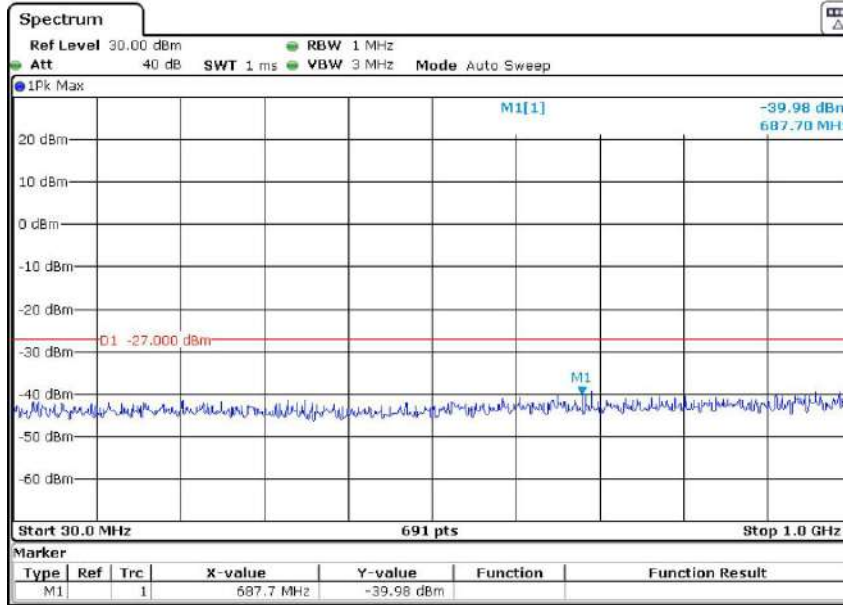

Report No.: AAEMT/EMC/220826-02-09

ac20 5.240GHz

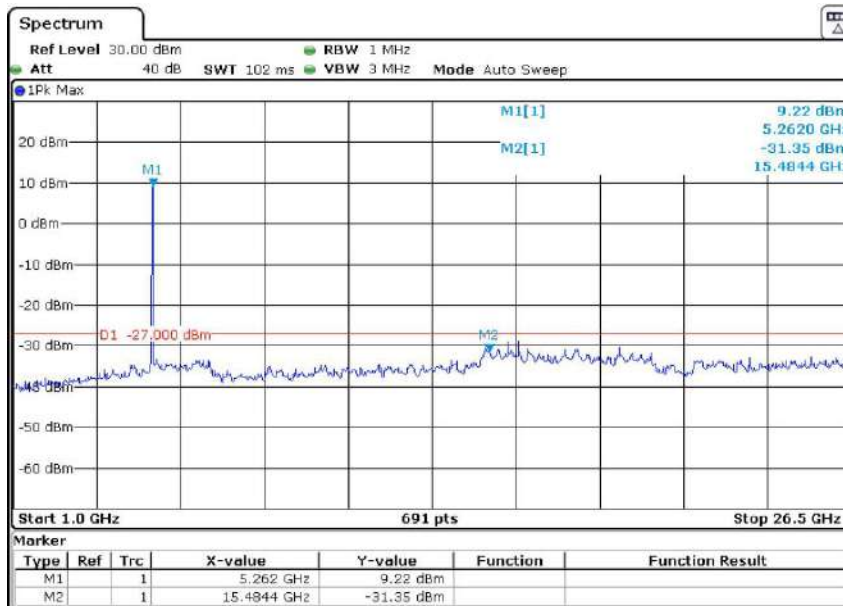
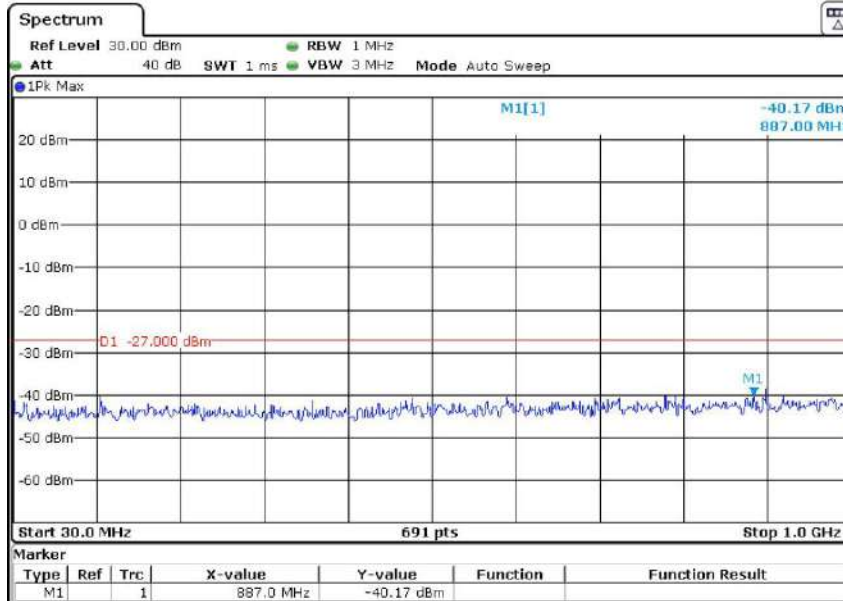

Report No.: AAEMT/EMC/220826-02-09

ac40 5.190GHz

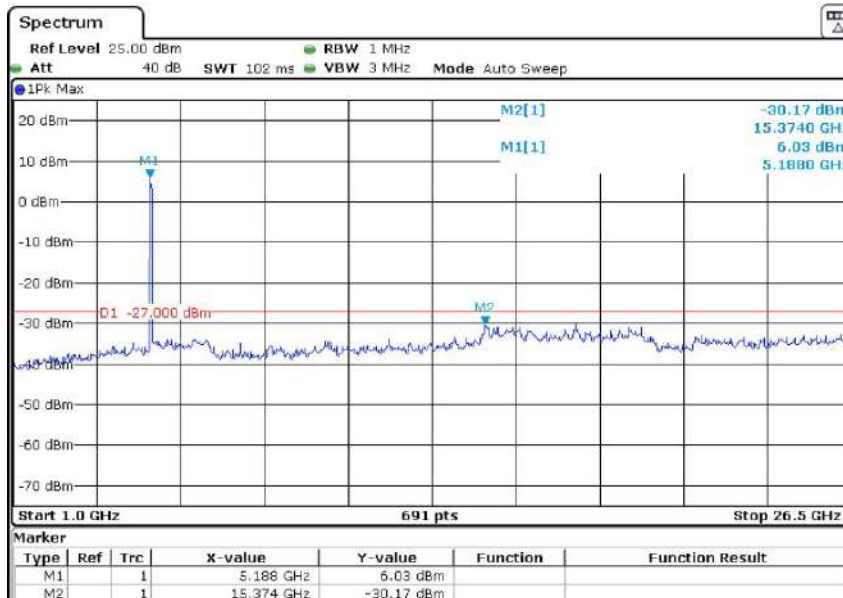
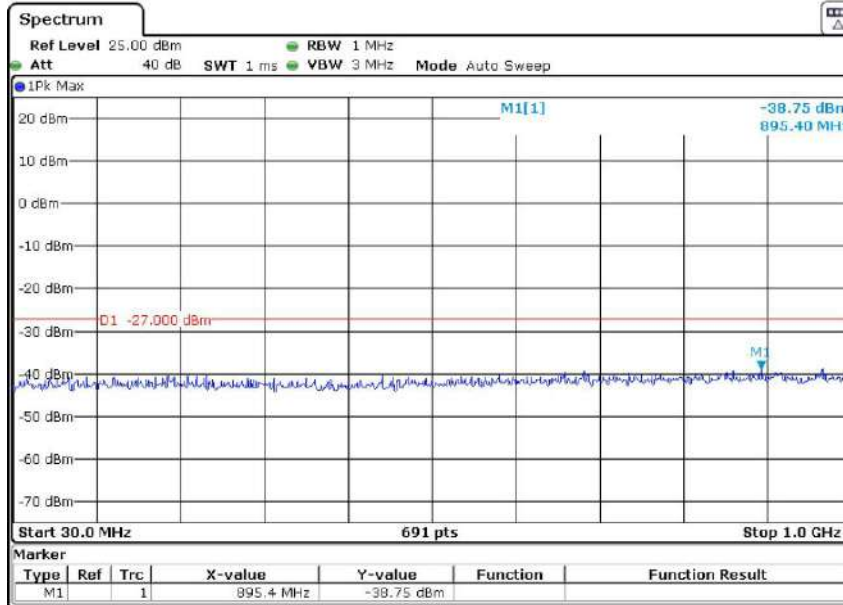

Report No.: AAEMT/EMC/220826-02-09

ac40 5.230GHz

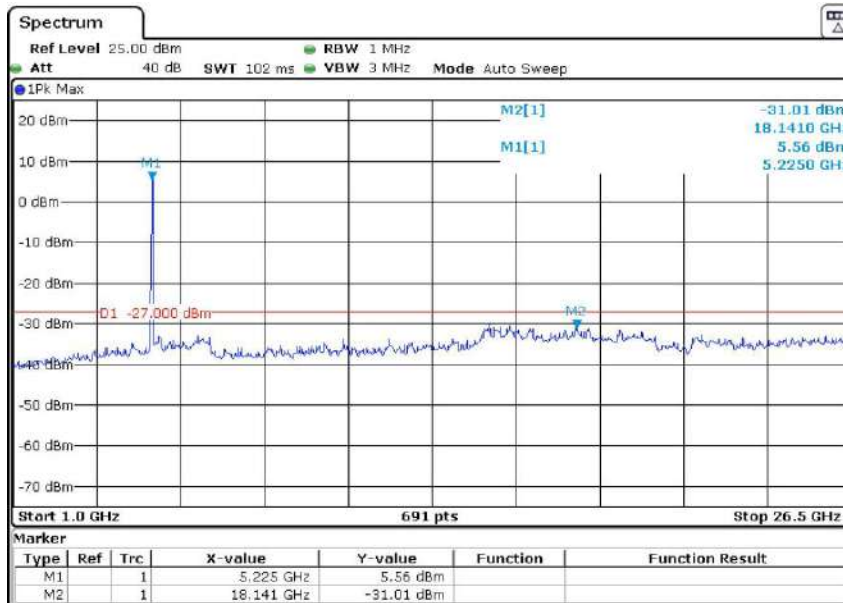
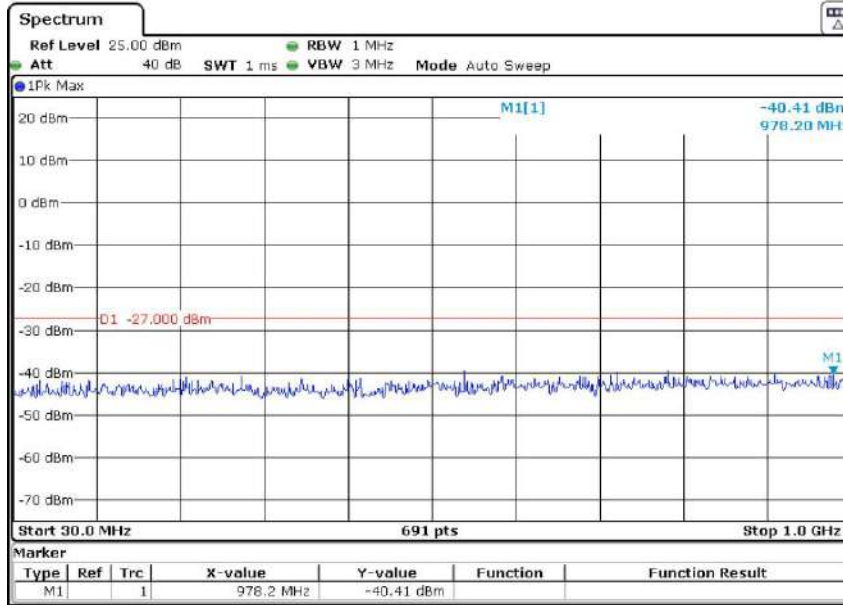

Report No.: AAEMT/EMC/220826-02-09

ac80 5.210GHz

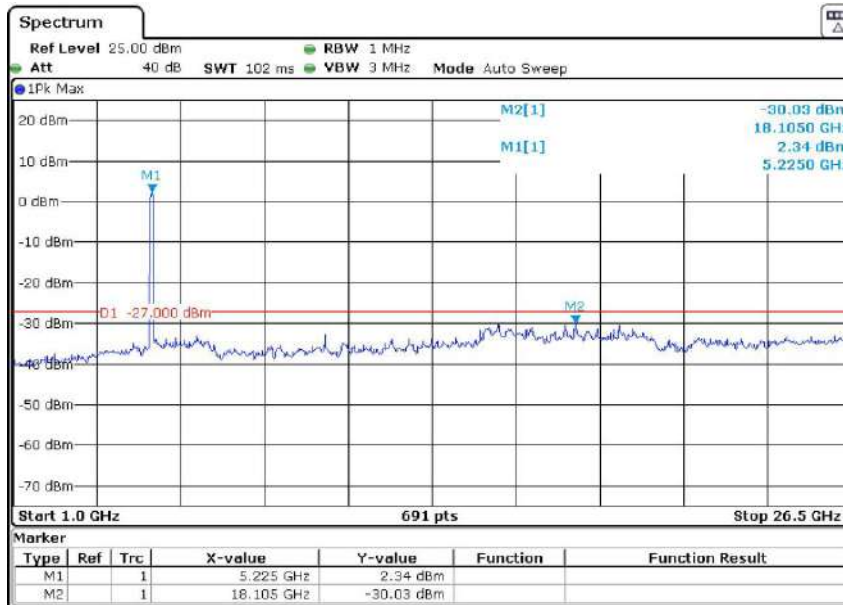
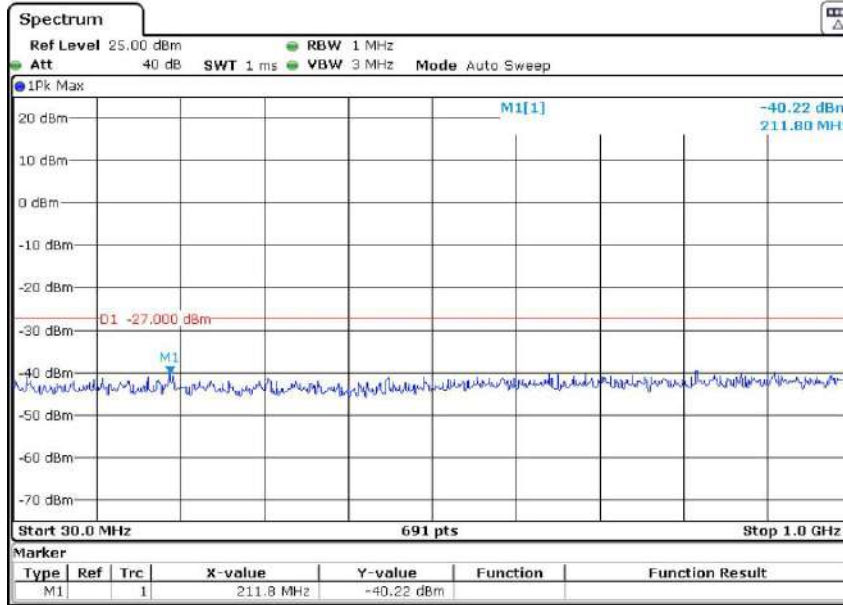

Report No.: AAEMT/EMC/220826-02-09

ax20 5.180 GHz

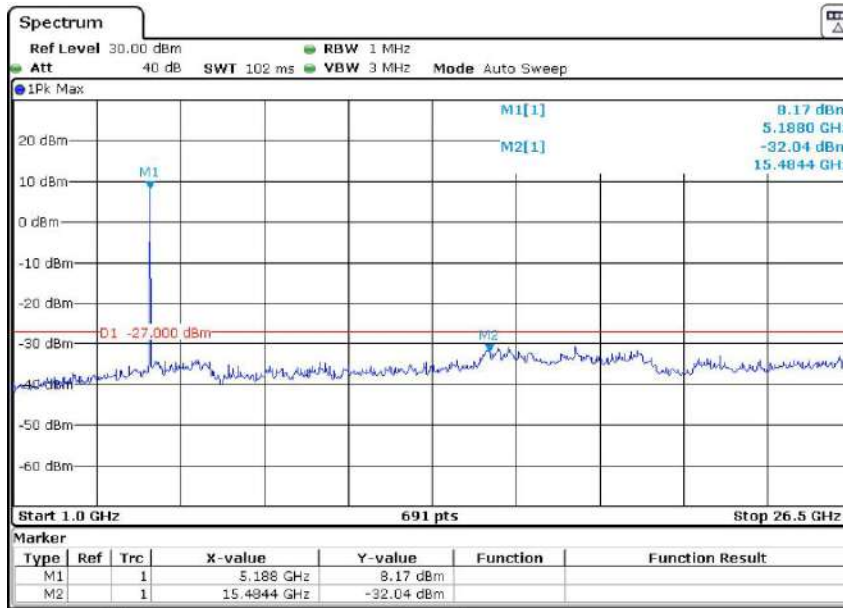
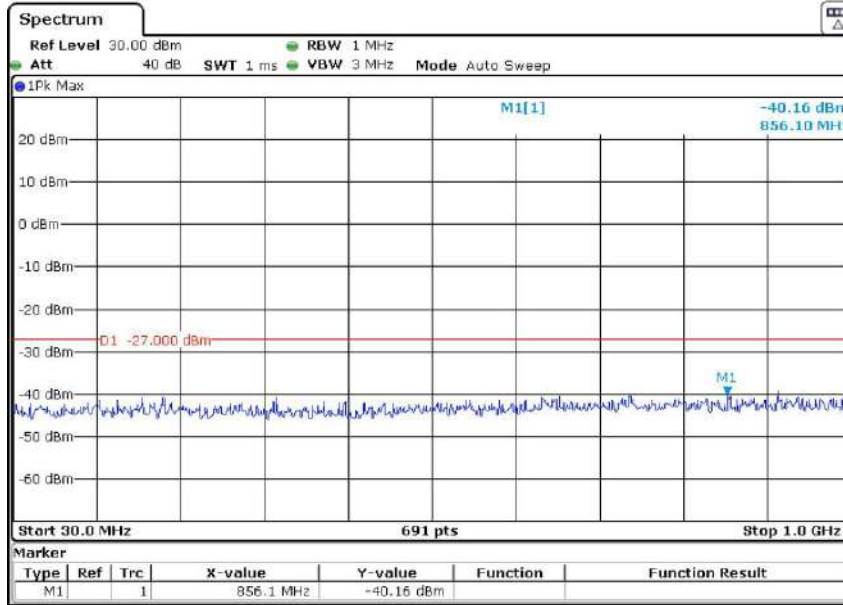

Report No.: AAEMT/EMC/220826-02-09

ax20 5.240 GHz

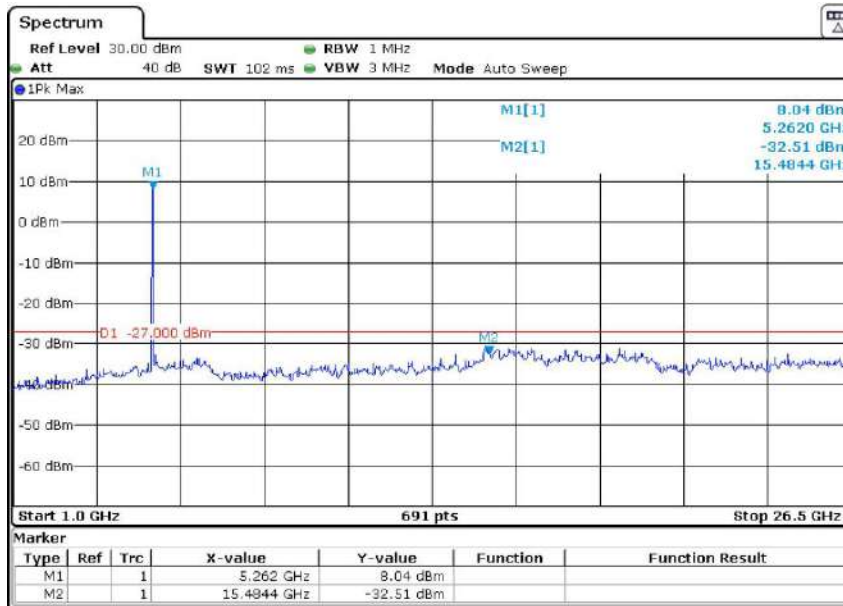
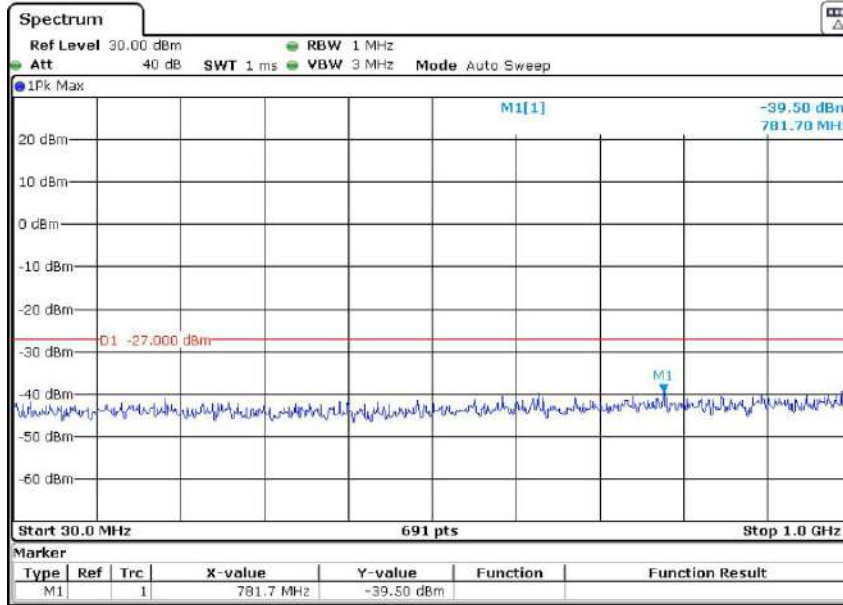

Report No.: AAEMT/EMC/220826-02-09

ax40 5.190 GHz

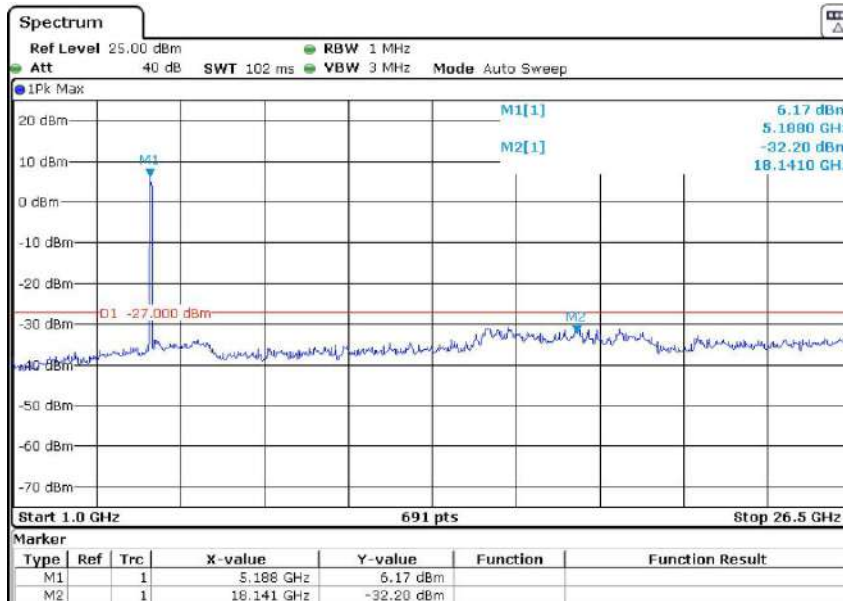
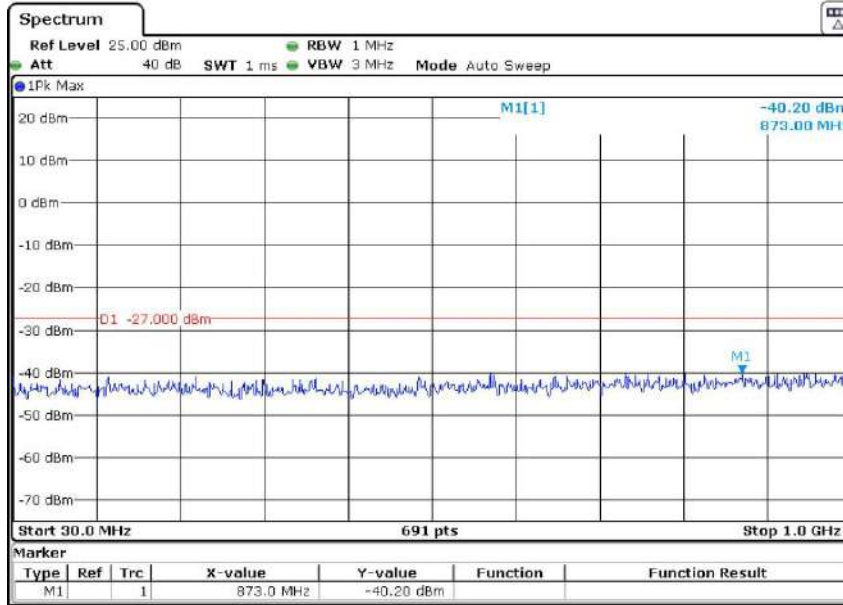

Report No.: AAEMT/EMC/220826-02-09

ax40 5.230 GHz

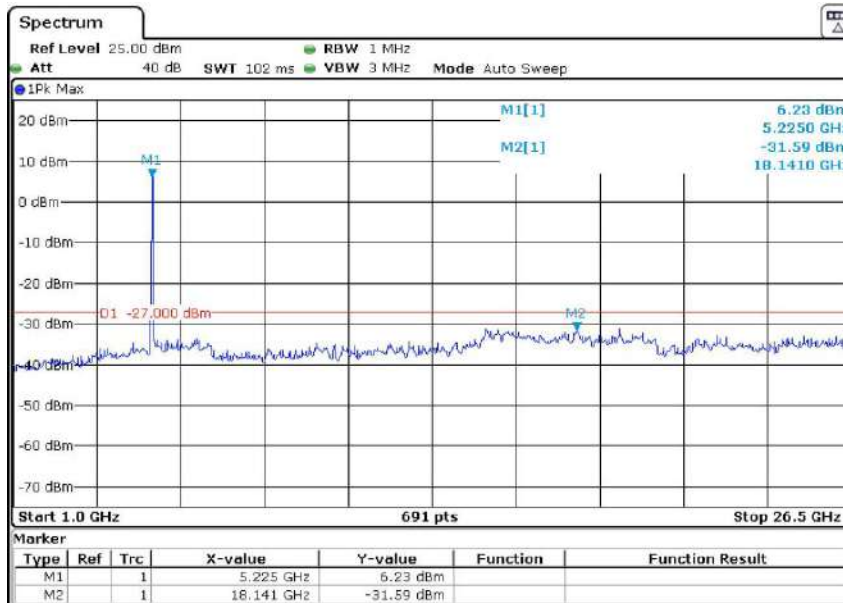
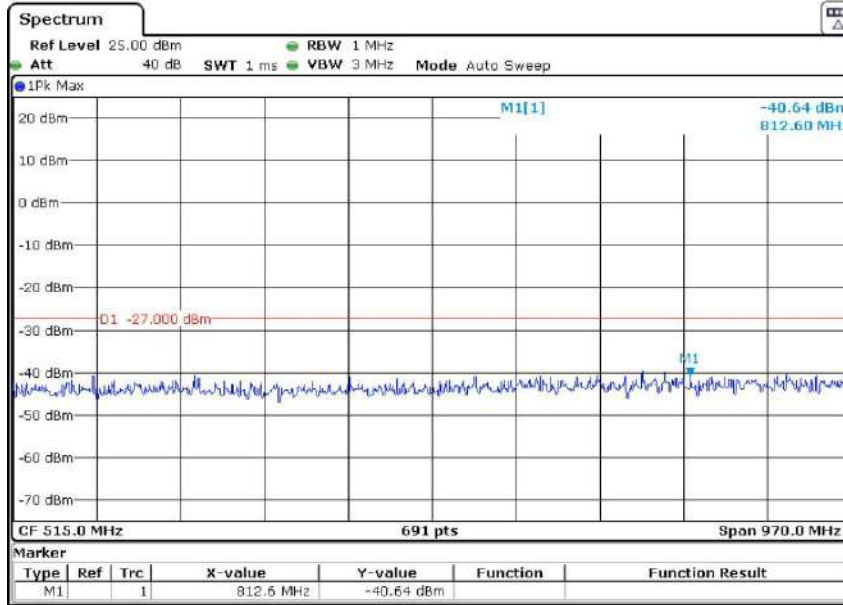

Report No.: AAEMT/EMC/220826-02-09

ax80 5.210 GHz

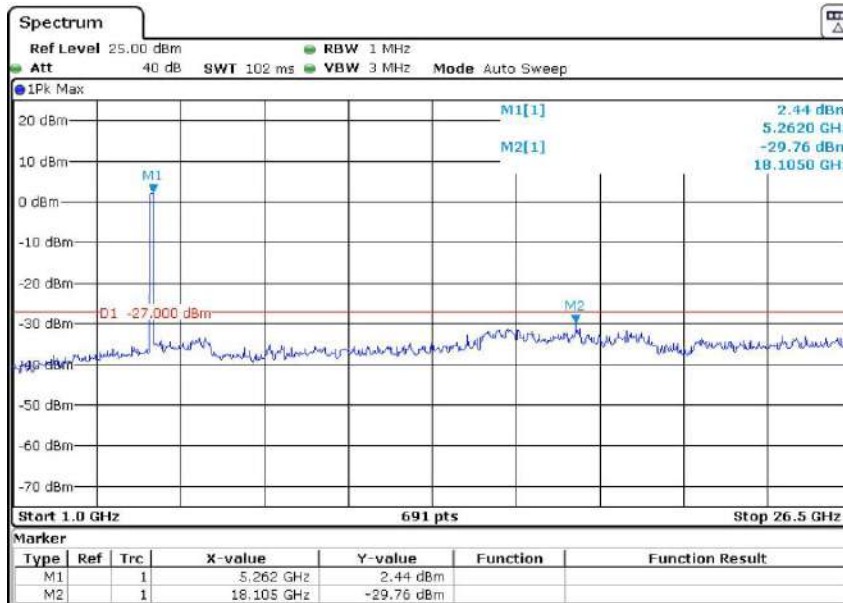
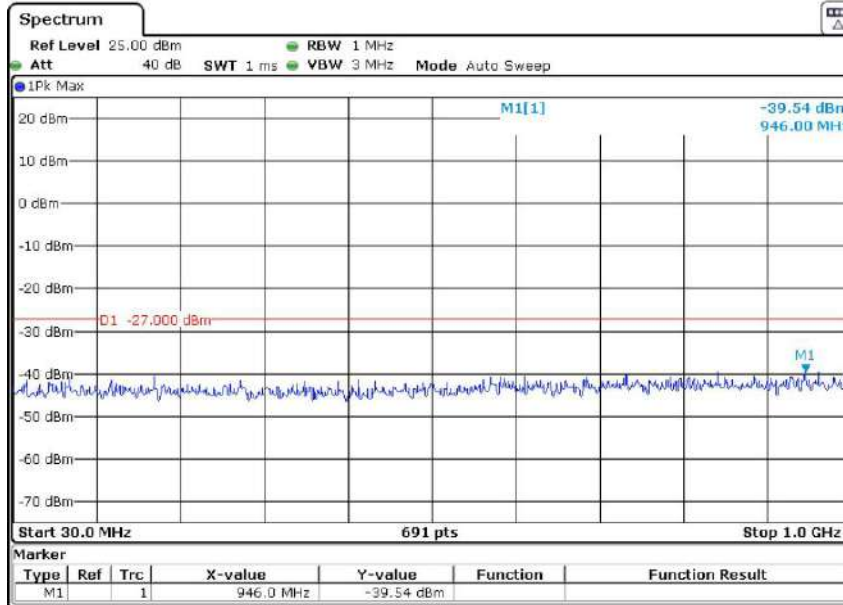

Report No.: AAEMT/EMC/220826-02-09

Result plot as follows: CHAIN 1

a20 5.745 GHz

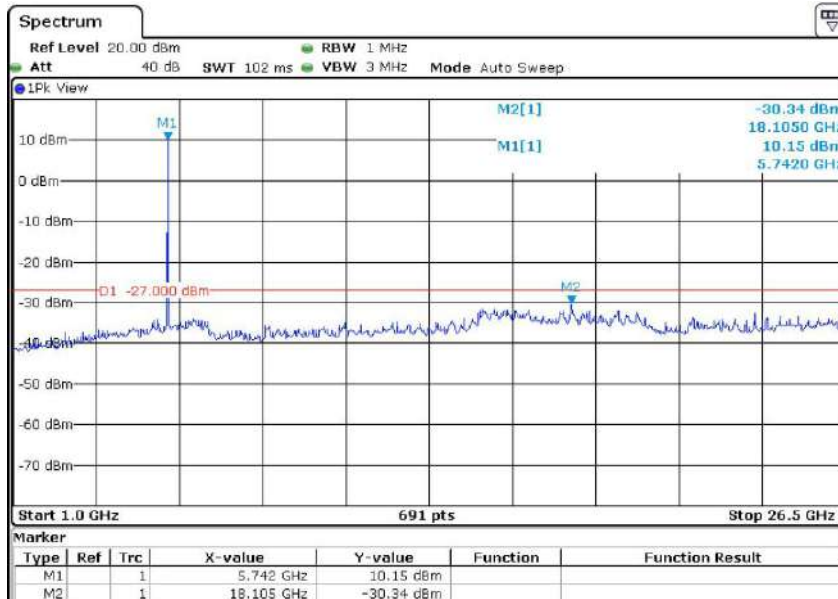
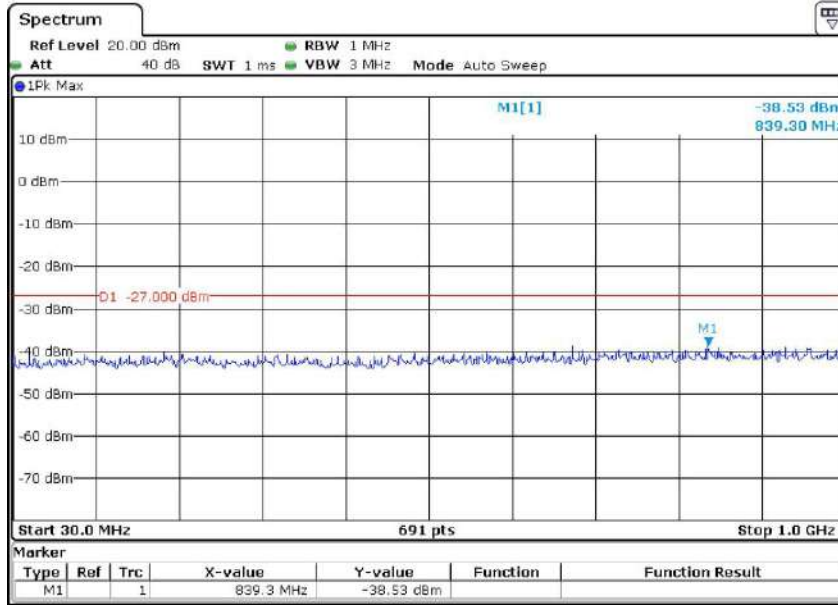

Report No.: AAEMT/EMC/220826-02-09

a20 5.825 GHz

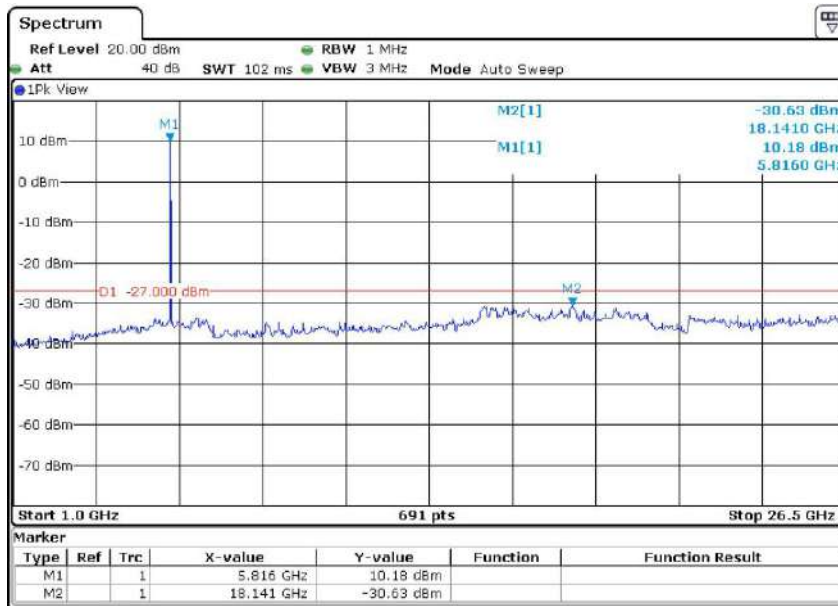
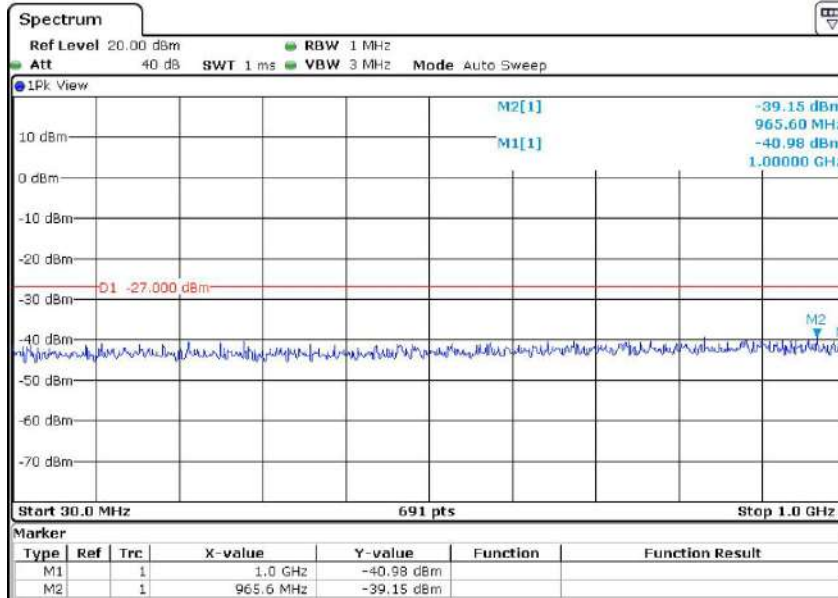

Report No.: AAEMT/EMC/220826-02-09

n20 5.745 GHz

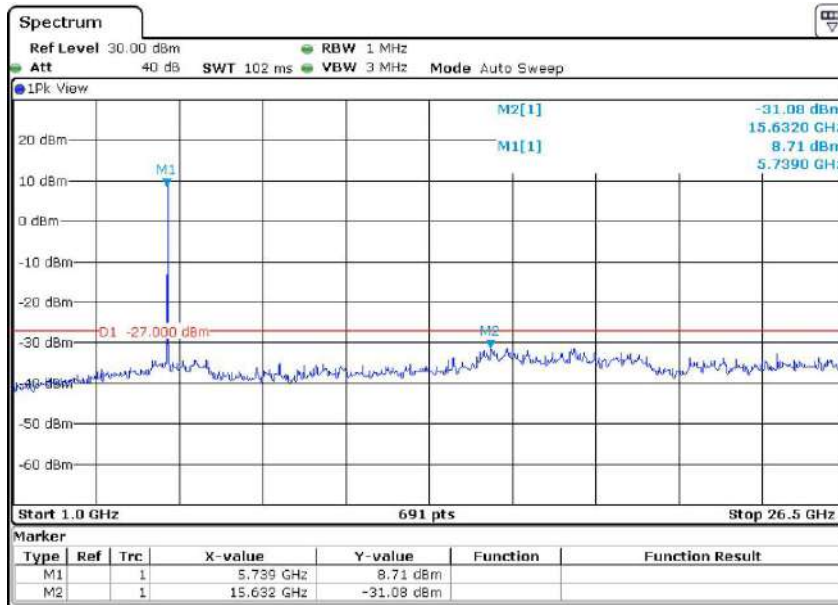
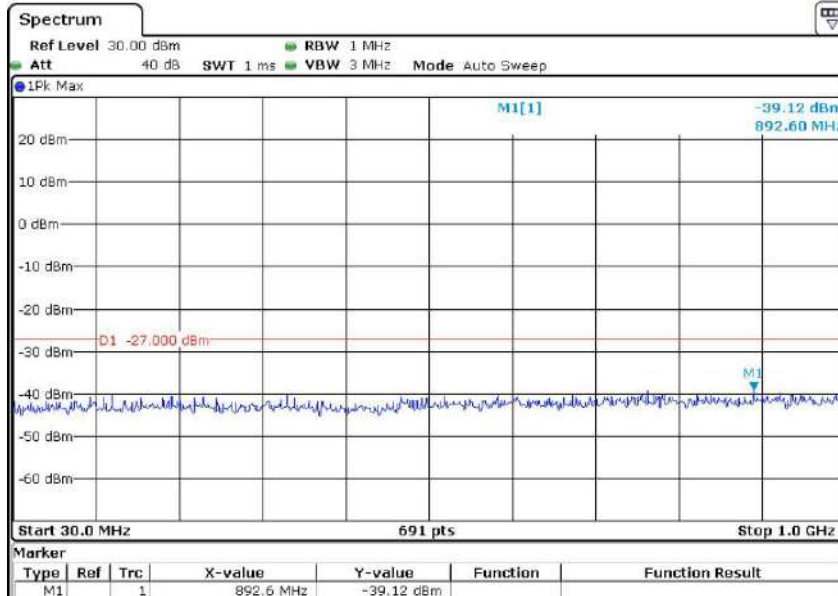

Report No.: AAEMT/EMC/220826-02-09

n20 5.825 GHz

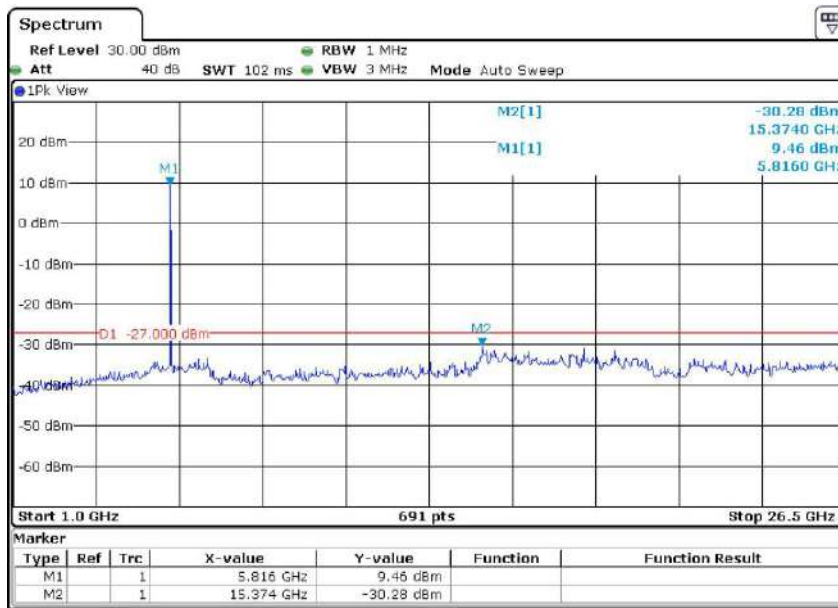
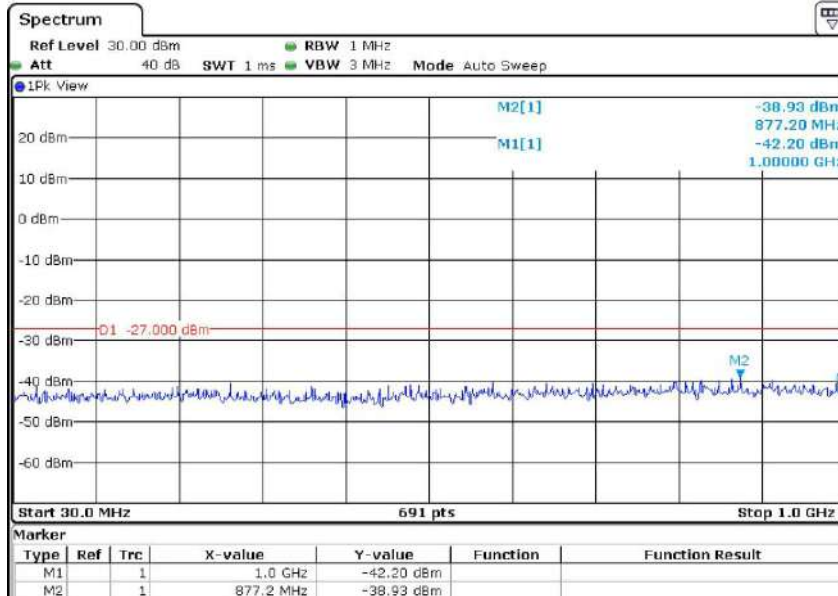

Report No.: AAEMT/EMC/220826-02-09

n40 5.755 GHz

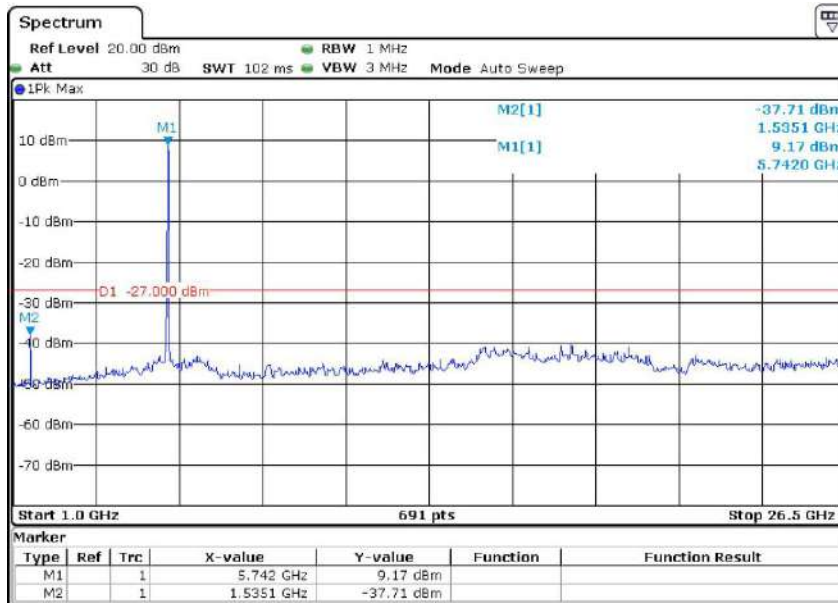
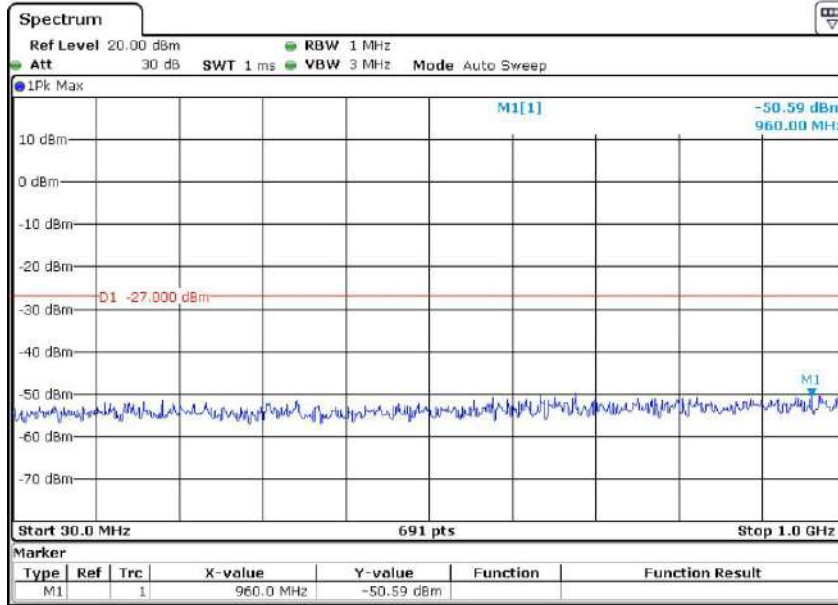

Report No.: AAEMT/EMC/220826-02-09

n40 5.795 GHz

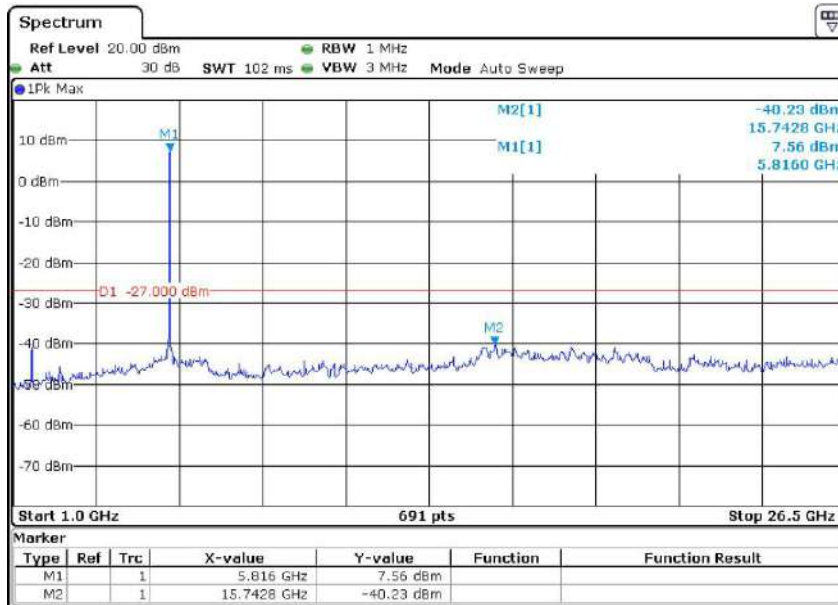
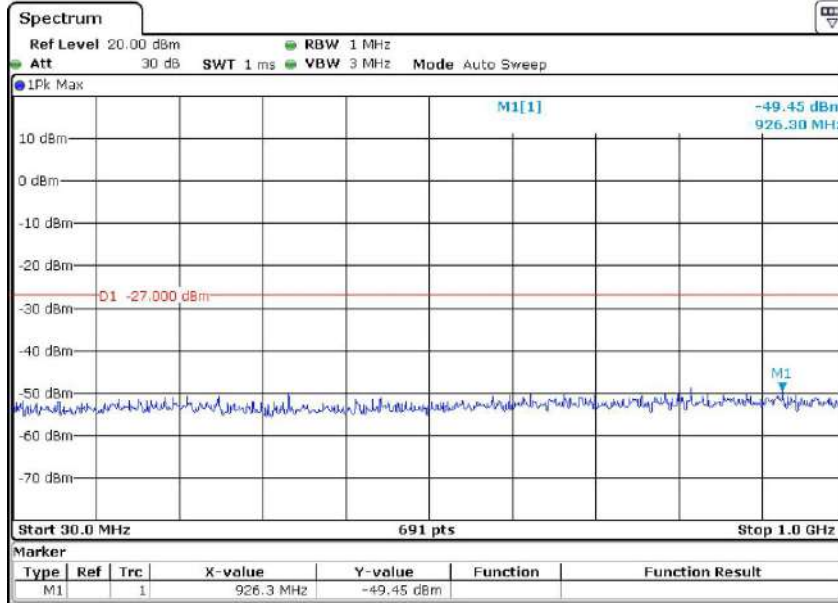

Report No.: AAEMT/EMC/220826-02-09

ac20 5.745 GHz

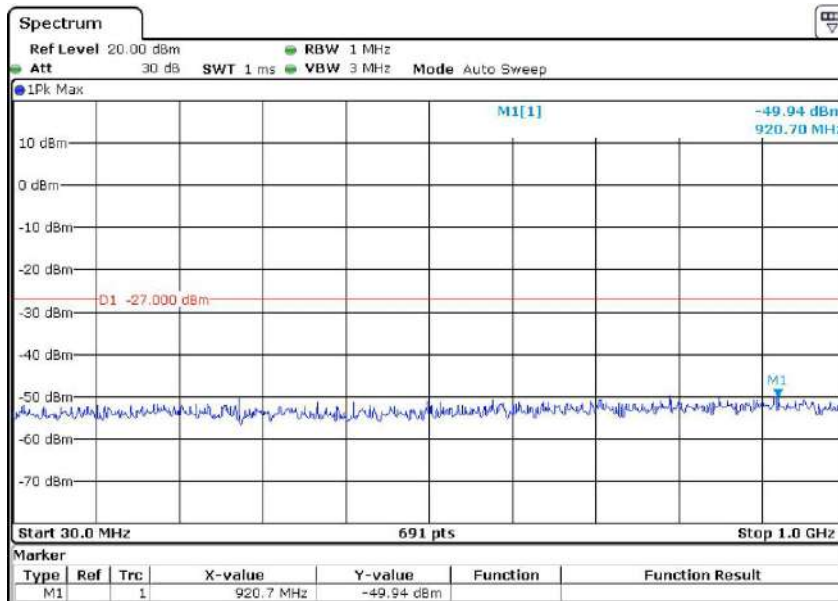
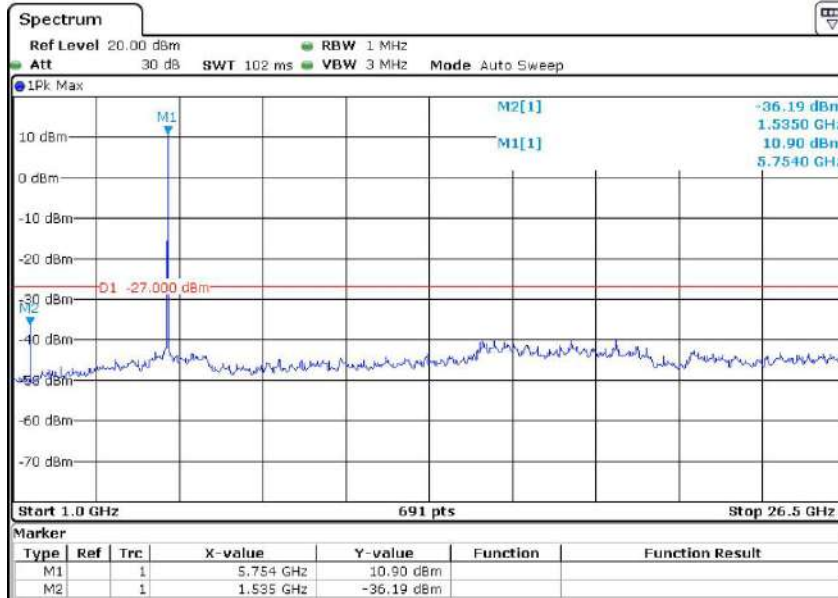

Report No.: AAEMT/EMC/220826-02-09

ac20 5.825 GHz

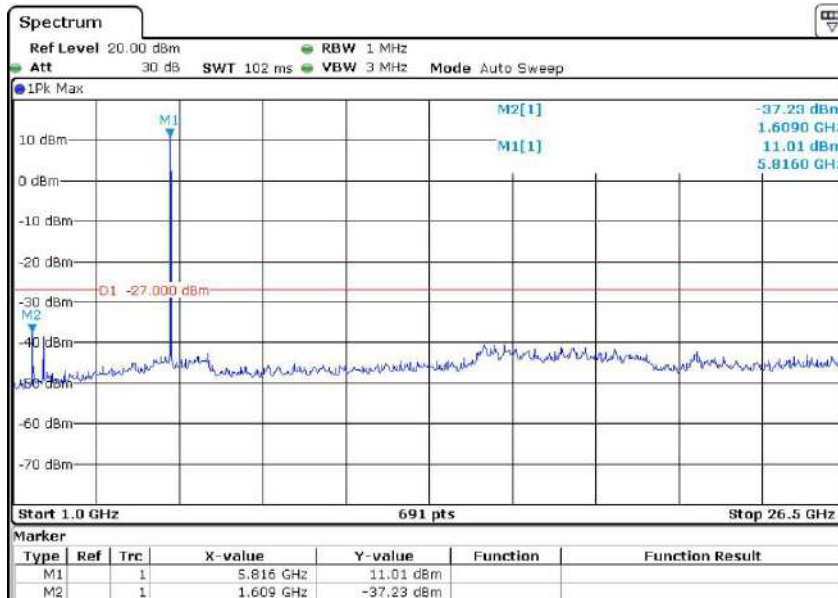
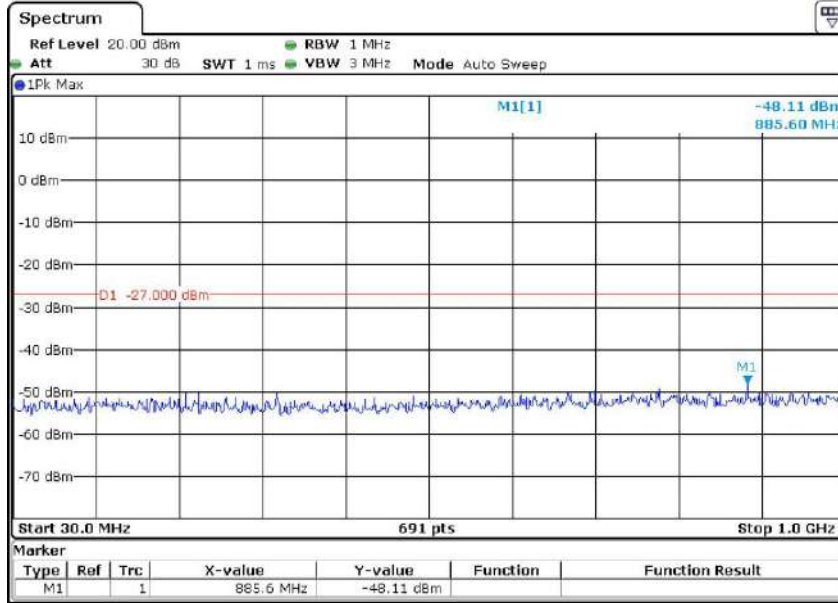

Report No.: AAEMT/EMC/220826-02-09

ac40 5.755 GHz

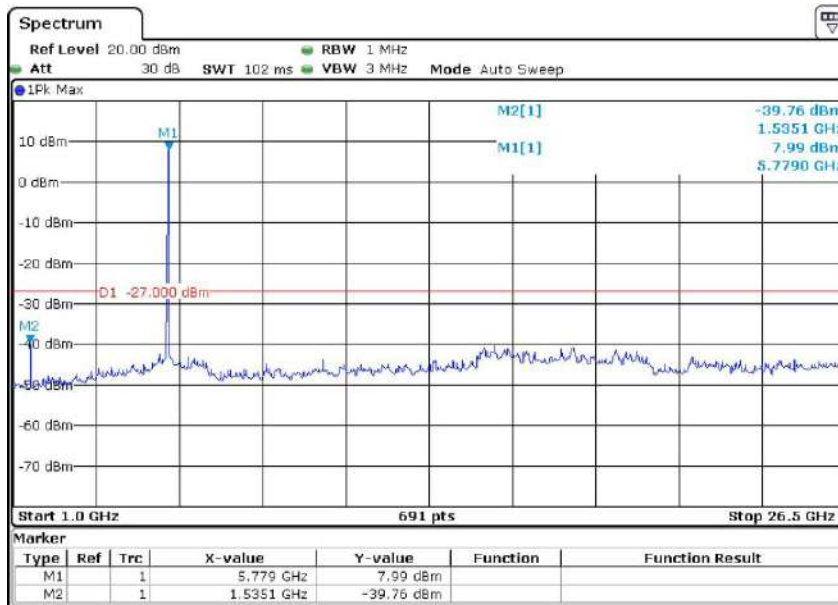
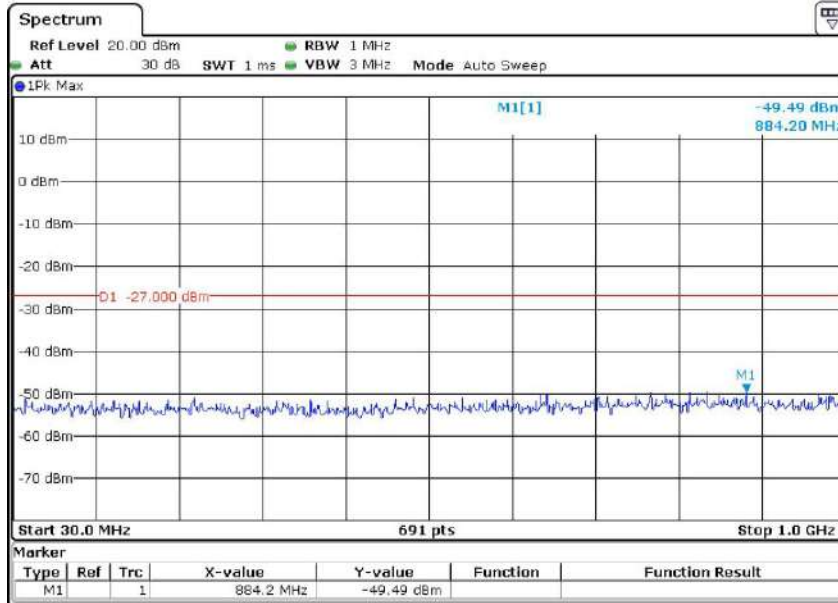

Report No.: AAEMT/EMC/220826-02-09

ac40 5.795 GHz

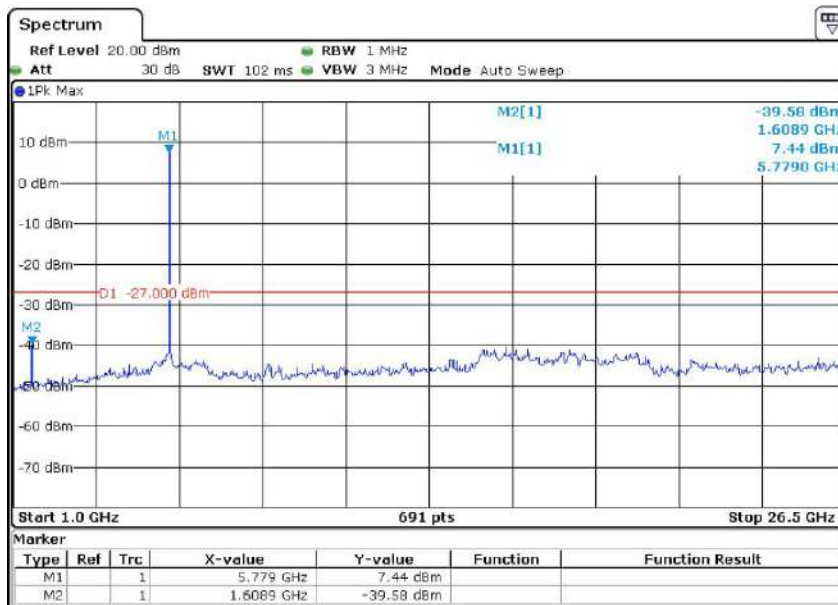
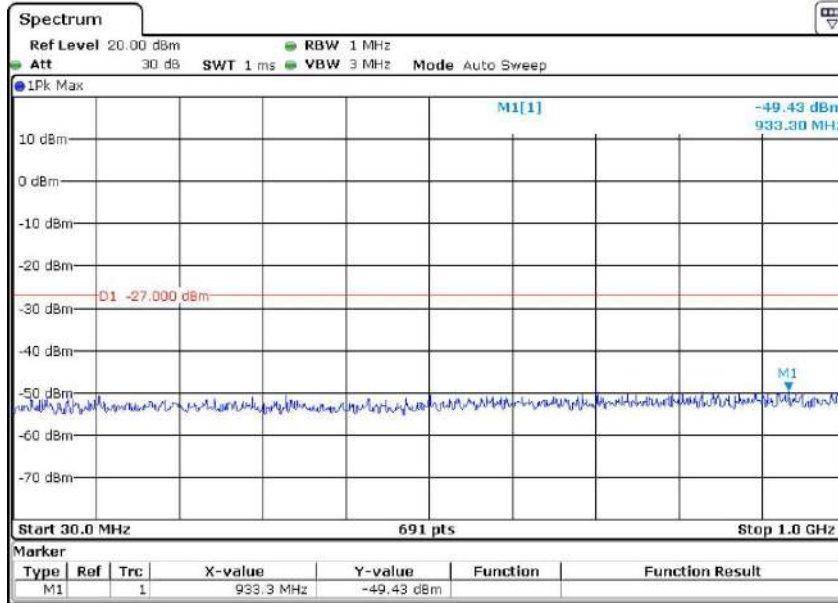

Report No.: AAEMT/EMC/220826-02-09

ac80 5.775 GHz

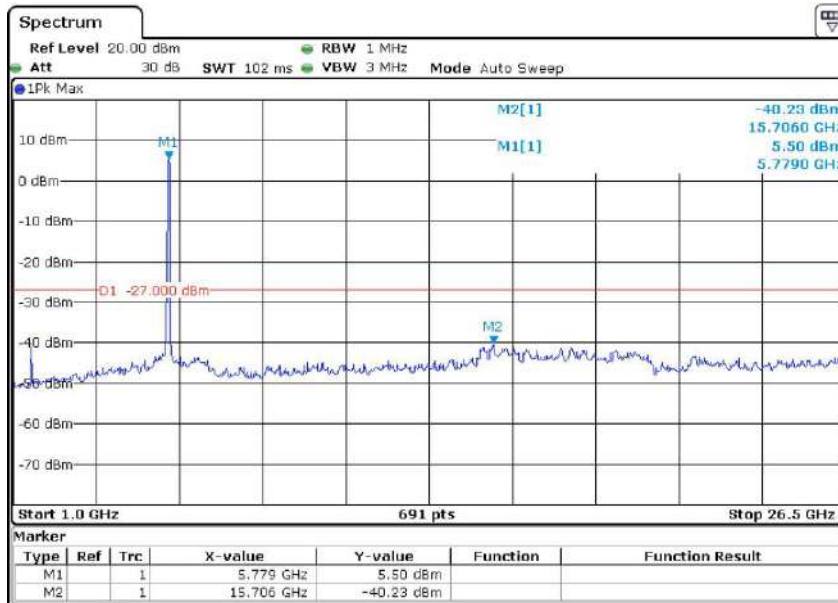
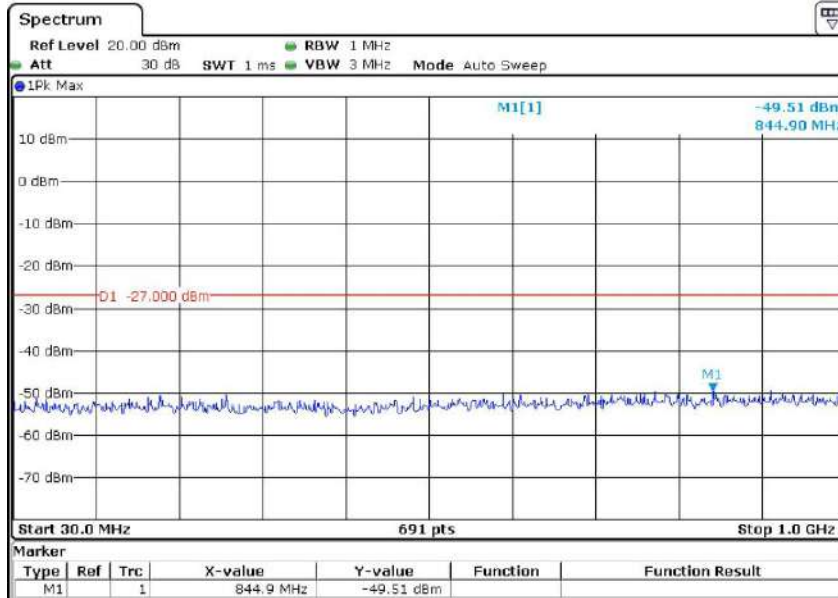

Report No.: AAEMT/EMC/220826-02-09

ax20 5.745 GHz

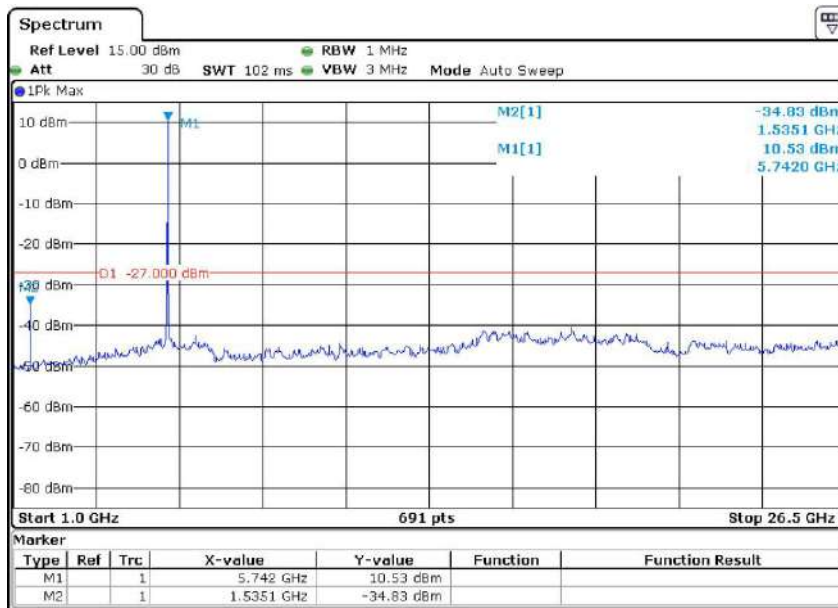
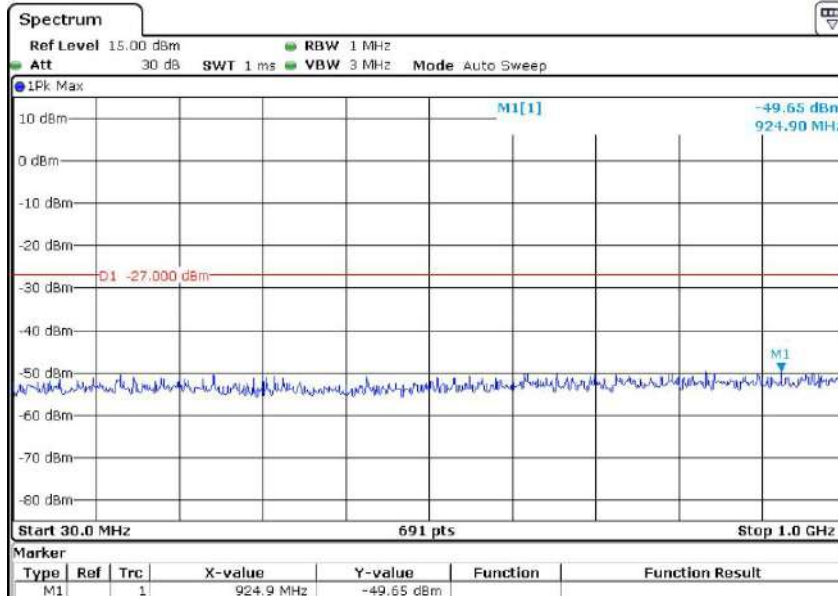

Report No.: AAEMT/EMC/220826-02-09

ax20 5.825 GHz

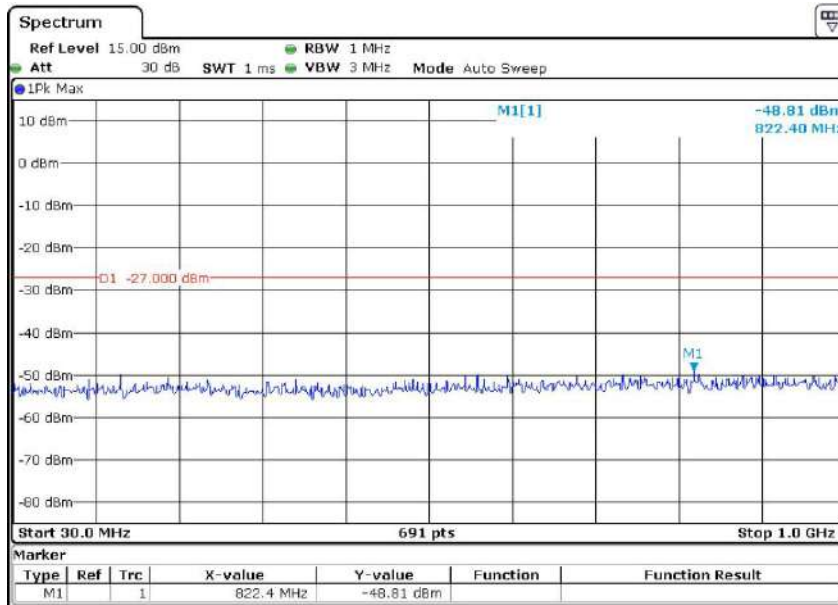
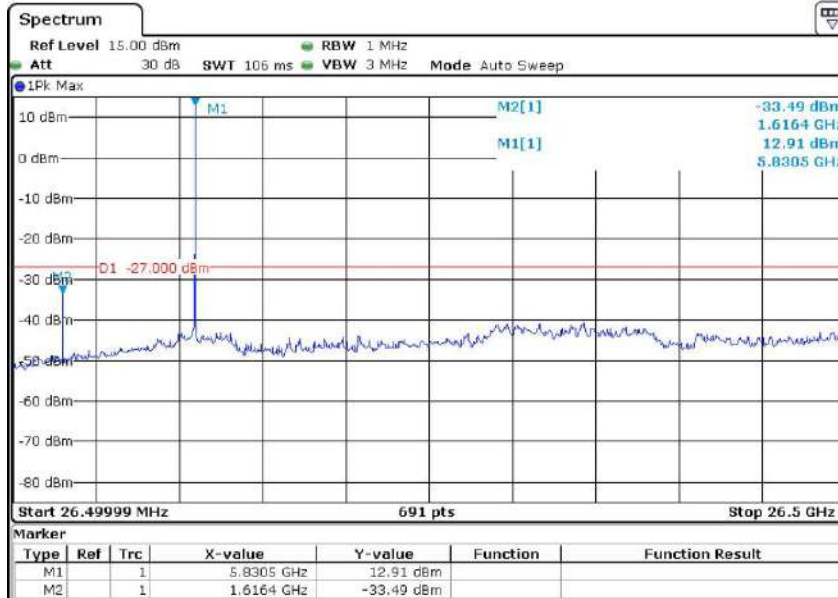

Report No.: AAEMT/EMC/220826-02-09

ax40 5.755 GHz

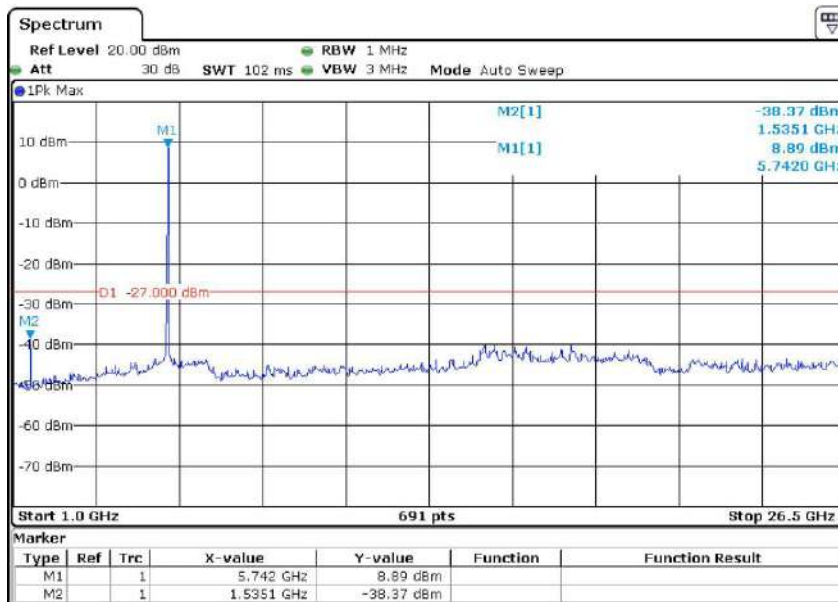
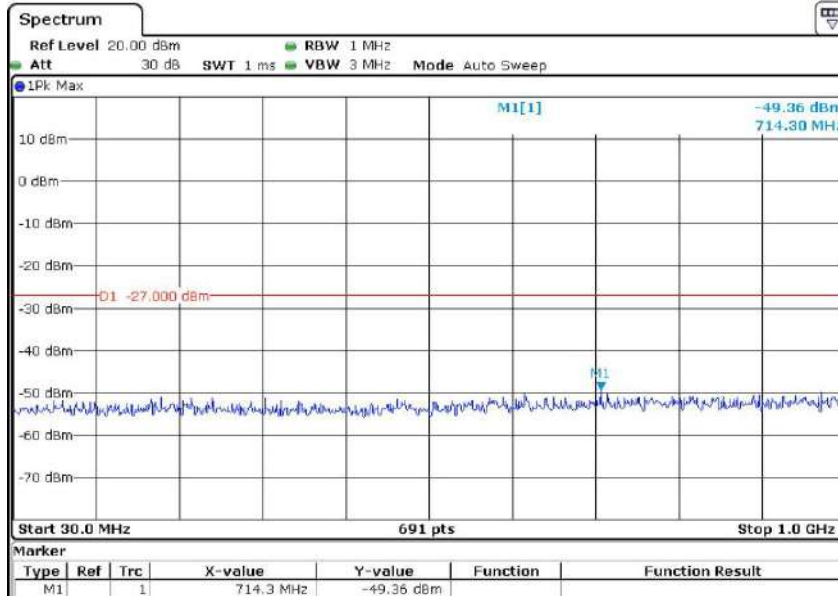

Report No.: AAEMT/EMC/220826-02-09

ax40 5.795 GHz

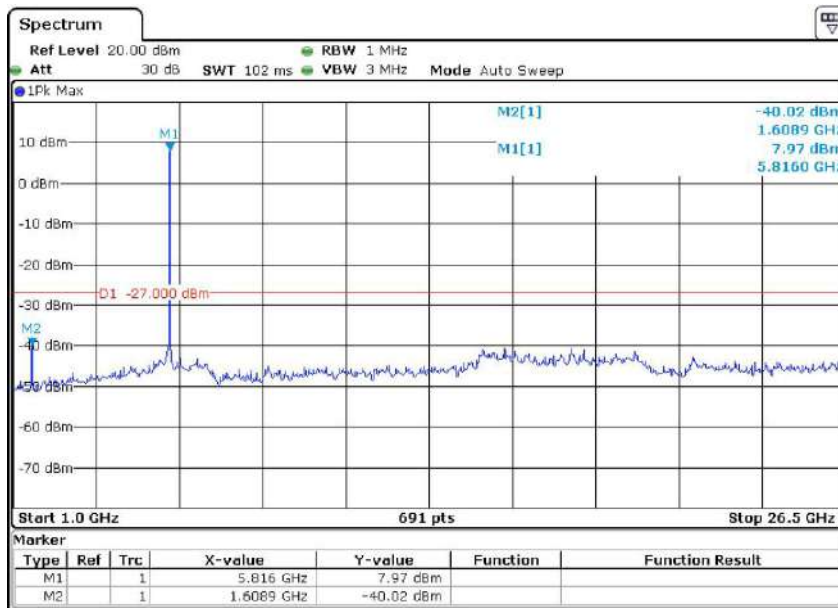
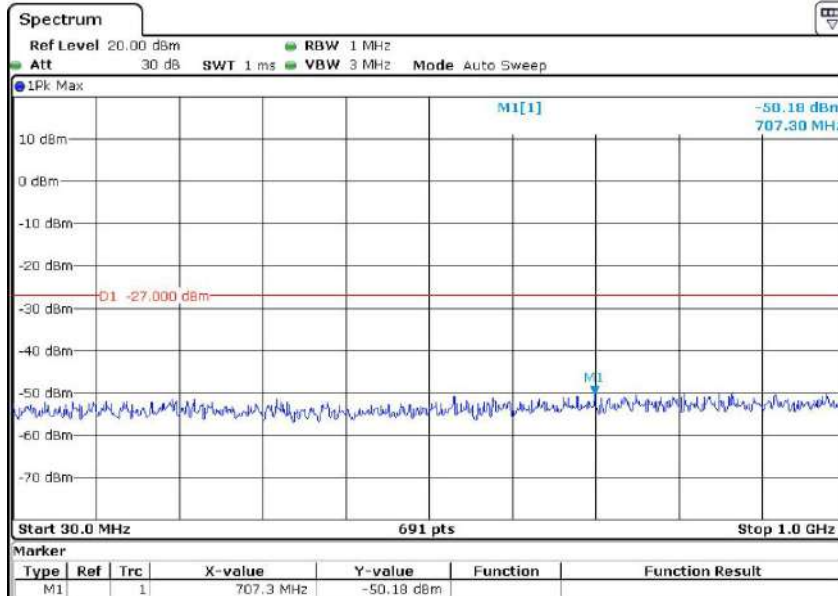

Report No.: AAEMT/EMC/220826-02-09

ax80 5.775 GHz

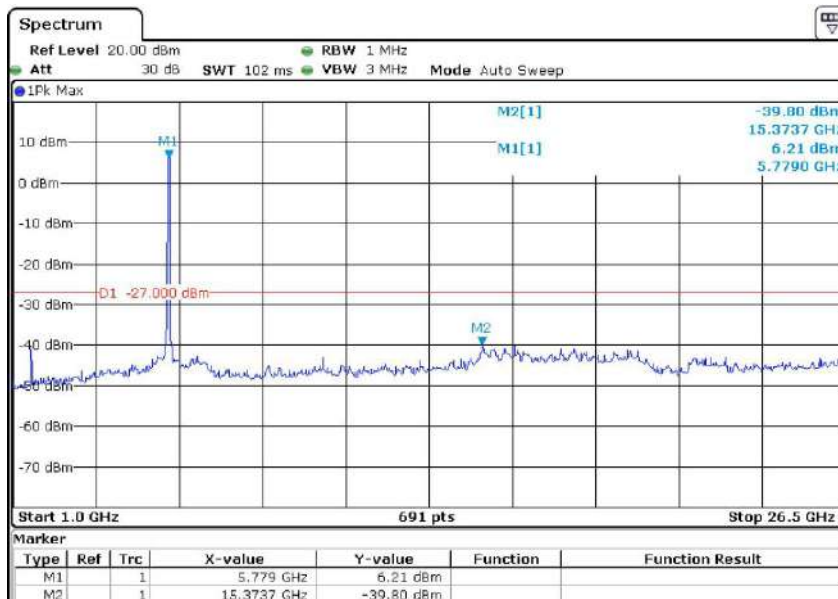
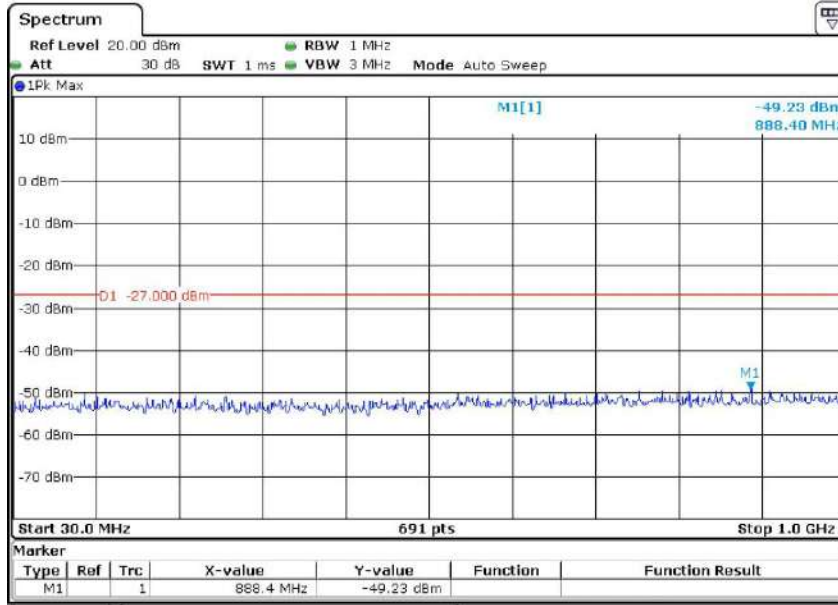

11. ANTENNA REQUIREMENTS

11.1. Limit

15.203 requirement: For intentional device, according to 15.203: an intentional radiator shall be designed to ensure that no antenna other than that furnished by the responsible party shall be used with the device.

11.2. EUT ANTENNA

The antennas used for this product an Integral Antenna that no antenna other than that furnished by the responsible party shall be used with the device, the maximum peak gain of the transmit antenna is 5dBi and the antenna connector is designed with permanent attachment and no consideration of replacement. Therefore the EUT is considered sufficient to comply with the provision.



****End of report****