



FCC TEST REPORT FOR

Fujian EastWest Lifewit Technology Co., LTD

Karaoke System

Test Model: K9

Additional Model No.: SD-309, K19

Prepared for : Fujian EastWest Lifewit Technology Co., LTD
Rm 1201-1205, Bld 18, 2nd Phase of Innovation Park, no.7,
Address : Wulongjiang Mid-Ave, Fuzhou High-tech Zone, Fuzhou, Fujian
Province
Prepared by : Shenzhen LCS Compliance Testing Laboratory Ltd.
Address : 101, 201 Bldg A & 301 Bldg C, Juji Industrial Park Yabianxueziwei,
Shajing Street, Baoan District, Shenzhen, 518000, China
Tel : (+86)755-82591330
Fax : (+86)755-82591332
Web : www.LCS-cert.com
Mail : webmaster@LCS-cert.com
Date of receipt of test sample : November 14, 2022
Number of tested samples : 2
Sample No. : A101022006-1, A101022006-2
Serial number : Prototype
Date of Test : November 14, 2022 ~ December 30, 2022
Date of Report : January 05, 2023



Shenzhen LCS Compliance Testing Laboratory Ltd.
Add: 101, 201 Bldg A & 301 Bldg C, Juji Industrial Park Yabianxueziwei, Shajing Street, Baoan District, Shenzhen,
518000, China
Tel: +(86) 0755-82591330 | E-mail: webmaster@lcs-cert.com | Web: www.lcs-cert.com
Scan code to check authenticity



FCC TEST REPORT
FCC CFR 47 PART 15 C (15.247)

Report Reference No. : LCSA101022006EA

Date of Issue : January 05, 2023

Testing Laboratory Name : Shenzhen LCS Compliance Testing Laboratory Ltd.

Address : 101, 201 Bldg A & 301 Bldg C, Juji Industrial Park Yabianxueziwei, Shajing Street, Baoan District, Shenzhen, 518000, China

Testing Location/ Procedure : Full application of Harmonised standards ■
Partial application of Harmonised standards □
Other standard testing method □

Applicant's Name : Fujian EastWest Lifewit Technology Co., LTD

Address : Rm 1201-1205, Bld 18, 2nd Phase of Innovation Park, no.7, Wulongjiang Mid-Ave, Fuzhou High-tech Zone, Fuzhou, Fujian Province

Test Specification

Standard : FCC CFR 47 PART 15 C (15.247)

Test Report Form No. : LCSEMC-1.0

TRF Originator : Shenzhen LCS Compliance Testing Laboratory Ltd.

Master TRF : Dated 2011-03

Shenzhen LCS Compliance Testing Laboratory Ltd. All rights reserved.

This publication may be reproduced in whole or in part for non-commercial purposes as long as the Shenzhen LCS Compliance Testing Laboratory Ltd. is acknowledged as copyright owner and source of the material. Shenzhen LCS Compliance Testing Laboratory Ltd. takes no responsibility for and will not assume liability for damages resulting from the reader's interpretation of the reproduced material due to its placement and context.

Test Item Description : Karaoke System

Trade Mark : TONOR

Test Model : K9

Ratings : Input: 5V~2A
DC 7.4V by Rechargeable Li-ion Battery, 4000mAh

Result : Positive

Compiled by:

Li Huan

Li Huan/ Administrator

Supervised by:

Cary Luo

Cary Luo/ Technique principal

Approved by:

Gavin Liang

Gavin Liang / Manager



Shenzhen LCS Compliance Testing Laboratory Ltd.
Add: 101, 201 Bldg A & 301 Bldg C, Juji Industrial Park Yabianxueziwei, Shajing Street, Baoan District, Shenzhen, 518000, China
Tel: +(86) 0755-82591330 | E-mail: webmaster@lcs-cert.com | Web: www.lcs-cert.com
Scan code to check authenticity



FCC -- TEST REPORT

Test Report No. : LCSA101022006EA	January 05, 2023 Date of issue
--	-----------------------------------

Test Model..... : K9 EUT..... : Karaoke System
Applicant..... : Fujian EastWest Lifewit Technology Co., LTD Address..... : Rm 1201-1205, Bld 18, 2nd Phase of Innovation Park, no.7, Wulongjiang Mid-Ave, Fuzhou High-tech Zone, Fuzhou, Fujian Province Telephone..... : / Fax..... : /
Manufacturer..... : Fujian EastWest Lifewit Technology Co., LTD Address..... : Rm 1201-1205, Bld 18, 2nd Phase of Innovation Park, no.7, Wulongjiang Mid-Ave, Fuzhou High-tech Zone, Fuzhou, Fujian Province Telephone..... : / Fax..... : /
Factory..... : Dongguan Suoda Electronic Technology Co., Ltd Address..... : Room 101, No.1 Xingfeng Road, Fenggang Town, Dongguan City, Guangdong Province Telephone..... : / Fax..... : /

Test Result	Positive
--------------------	-----------------

The test report merely corresponds to the test sample.
 It is not permitted to copy extracts of these test result without the written permission of the test laboratory.



Shenzhen LCS Compliance Testing Laboratory Ltd.
 Add: 101, 201 Bldg A & 301 Bldg C, Juji Industrial Park Yabianxueziwei, Shajing Street, Baoan District, Shenzhen, 518000, China
 Tel: +(86) 0755-82591330 | E-mail: webmaster@lcs-cert.com | Web: www.lcs-cert.com
 Scan code to check authenticity



Revision History

Report Version	Issue Date	Revision Content	Revised By
000	January 05, 2023	Initial Issue	---



TABLE OF CONTENTS

Description	Page
1. GENERAL INFORMATION	6
1.1 Description of Device (EUT)	6
1.2 Support equipment List	7
1.3 External I/O Cable	7
1.4 Description of Test Facility	7
1.5 Statement of the Measurement Uncertainty	7
1.6 Measurement Uncertainty	7
1.7 Description of Test Modes	8
2. TEST METHODOLOGY	9
2.1 EUT Configuration	9
2.2 EUT Exercise	9
2.3 General Test Procedures	9
2.4. Test Sample	9
3. SYSTEM TEST CONFIGURATION	10
3.1 Justification	10
3.2 EUT Exercise Software	10
3.3 Special Accessories	10
3.4 Block Diagram/Schematics	10
3.5 Equipment Modifications	10
3.6 Test Setup	10
4. SUMMARY OF TEST RESULTS	11
5. SUMMARY OF TEST EQUIPMENT	12
6. MEASUREMENT RESULTS	13
6.1. Frequency Separation and 20 dB Bandwidth	13
6.2. Peak Power	14
6.3. Time of Occupancy (Dwell Time)	15
6.4. Number of Hopping Frequency	16
6.5. Band Edges Measurements and Conducted Spurious Emissions Test	17
6.6. Restricted Band Emission Limit	18
6.7. AC Power Line Conducted Emissions	29
6.8. Emissions in Restricted Bands	32
6.9. Pseudorandom Frequency Hopping Sequence	34
6.10. Antenna Requirement	35
7. TEST SETUP PHOTOGRAPHS OF EUT	36
8. EXTERIOR PHOTOGRAPHS OF THE EUT	36
9. INTERIOR PHOTOGRAPHS OF THE EUT	36





1. GENERAL INFORMATION

1.1 Description of Device (EUT)

EUT	: Karaoke System
Test Model	: K9
Additional Model No.	: SD-309, K19
Model Declaration	: PCB board, structure and internal of these model(s) are the same, So no additional models were tested
Power Supply	: Input: 5V $\overline{=}$ 2A DC 7.4V by Rechargeable Li-ion Battery, 4000mAh
Hardware Version	: 309-4G
Software Version	: YSD(SD-309)_AC6901A_SDRD_62F4_202209271056(4G)
Bluetooth	:
Frequency Range	: 2402MHz~2480MHz
Channel Number	: 79 channels for Bluetooth V5.0 (DSS) 40 channels for Bluetooth V5.0 (DTS)
Channel Spacing	: 1MHz for Bluetooth V5.0 (DSS) 2MHz for Bluetooth V5.0 (DTS)
Modulation Type	: GFSK, $\pi/4$ -DQPSK, 8-DPSK for Bluetooth V5.0 (DSS) GFSK for Bluetooth V5.0 (DTS)
Bluetooth Version	: V5.0
Antenna Description	: PCB Antenna, -0.58dBi(Max.)





1.2 Support equipment List

Manufacturer	Description	Model	Serial Number	Certificate
OPPO	Adapter	OP52KAUH	---	FCC

Note: The adapter is supplied by lab and only use tested.

1.3 External I/O Cable

I/O Port Description	Quantity	Cable
Type-C USB Port	1	USB Cable: 0.8m, unshielded
USB Port	1	N/A
TF Card Port	1	N/A
AUX Port	1	N/A
GUITAR Port	1	N/A

1.4 Description of Test Facility

NVLAP Accreditation Code is 600167-0.
 FCC Designation Number is CN5024.
 CAB identifier is CN0071.
 CNAS Registration Number is L4595.
 Test Firm Registration Number: 254912.

The 3m-Semi anechoic test site fulfils CISPR 16-1-4 according to ANSI C63.10:2013 and CISPR 16-1-4:2010 SVSWR requirement for radiated emission above 1GHz.

1.5 Statement of the Measurement Uncertainty

The data and results referenced in this document are true and accurate. The reader is cautioned that there may be errors within the calibration limits of the equipment and facilities. The measurement uncertainty was calculated for all measurements listed in this test report acc. To CISPR 16 – 4 “Specification for radio disturbance and immunity measuring apparatus and methods – Part 4: Uncertainty in EMC Measurements” and is documented in the LCS quality system acc. To DIN EN ISO/IEC 17025. Furthermore, component and process variability of devices similar to that tested may result in additional deviation. The manufacturer has the sole responsibility of continued compliance of the device.

1.6 Measurement Uncertainty

Test Item	Frequency Range	Uncertainty	Note
Radiation Uncertainty	9KHz~30MHz	3.10dB	(1)
	30MHz~200MHz	2.96dB	(1)
	200MHz~1000MHz	3.10dB	(1)
	1GHz~26.5GHz	3.80dB	(1)
	26.5GHz~40GHz	3.90dB	(1)
Conduction Uncertainty	150kHz~30MHz	1.63dB	(1)
Power disturbance	30MHz~300MHz	1.60dB	(1)

(1). This uncertainty represents an expanded uncertainty expressed at approximately the 95% confidence level using a coverage factor of k=2.





1.7 Description of Test Modes

Bluetooth operates in the unlicensed ISM Band at 2.4GHz. With basic data rate feature, the data rates can be up to 1 Mb/s by modulating the RF carrier using GFSK techniques. The EUT works in the X-axis, Y-axis, Z-axis. The following operating modes were applied for the related test items. All test modes were tested, only the result of the worst case was recorded in the report.

Mode of Operations	Frequency Range (MHz)	Data Rate (Mbps)
BT	2402	1/2/3
	2441	1/2/3
	2480	1/2/3
For Conducted Emission		
Test Mode	TX Mode/Hopping Mode	
For Radiated Emission		
Test Mode	TX Mode/Hopping Mode	

Worst-case mode and channel used for 150 KHz-30 MHz power line conducted emissions was determined to be TX (3Mbps-Middle Channel).

Worst-case mode and channel used for 9 KHz-1000 MHz radiated emissions was determined to be TX (3Mbps-Middle Channel).

Pre-test AC conducted emission at charge from 3Mbps-Middle Channel mode, recorded worst case.

Pre-test AC conducted emission at both voltage AC 120V/60Hz and AC 240V/60Hz, recorded worst case.

AC conducted emission pre-test at power adapter modes, recorded worst case.





2. TEST METHODOLOGY

The tests documented in this report were performed in accordance with ANSI C63.10-2013, FCC CFR PART 15C 15.207, 15.209 and 15.247.

2.1 EUT Configuration

The EUT configuration for testing is installed on RF field strength measurement to meet the Commissions requirement and operating in a manner that intends to maximize its emission characteristics in a continuous normal application.

2.2 EUT Exercise

The EUT was operated in the normal operating mode for Hopping Numbers and Dwell Time test and a continuous transmits mode for other tests.

According to its specifications, the EUT must comply with the requirements of the Section 15.207, 15.209, 15.247 under the FCC Rules Part 15 Subpart C.

2.3 General Test Procedures

2.3.1 Conducted Emissions

The EUT is placed on the turntable, which is 0.8 m above ground plane. According to the requirements in Section 6.1.1 of ANSI C63.10-2013 Conducted emissions from the EUT measured in the frequency range between 0.15 MHz and 30MHz using Quasi-peak and average detector modes.

2.3.2 Radiated Emissions

The EUT is placed on a turn table, which is 0.8 m above ground plane below 1GHz and 1.5 m above ground plane above 1GHz. The turntable shall rotate 360 degrees to determine the position of maximum emission level. EUT is set 3m away from the receiving antenna, which varied from 1m to 4m to find out the highest emission. And also, each emission was to be maximized by changing the polarization of receiving antenna both horizontal and vertical. In order to find out the maximum emissions, exploratory radiated emission measurements were made according to the requirements in Section 6.4 of ANSI C63.10-2013

2.4. Test Sample

The application provides 2 samples to meet requirement;

Sample Number	Description
Sample 1(A101022006-1)	Engineer sample – continuous transmit
Sample 2(A101022006-2)	Normal sample – Intermittent transmit





3. SYSTEM TEST CONFIGURATION

3.1 Justification

The system was configured for testing in a continuous transmits condition.

3.2 EUT Exercise Software

The system was configured for testing in a continuous transmits condition and change test channels by software (FrequencyTool_v0.3.2) provided by application.

3.3 Special Accessories

Manufacturer	Description	Model	Serial Number	Certificate
--	--	--	--	--

3.4 Block Diagram/Schematics

Please refer to the related document.

3.5 Equipment Modifications

Shenzhen LCS Compliance Testing Laboratory Ltd. has not done any modification on the EUT.

3.6 Test Setup

Please refer to the test setup photo.





4. SUMMARY OF TEST RESULTS

Applied Standard: FCC Part 15 Subpart C				
FCC Rules	Description of Test	Test Sample	Result	Remark
§15.247(a)	20dB Bandwidth	Sample 1	Compliant	Appendix A.1
§15.247(b)(1)	Maximum Peak Conducted Output Power	Sample 1	Compliant	Appendix A.2
§15.247(a)(1)	Frequency Separation	Sample 1	Compliant	Appendix A.3
§15.247(a)(1)	Time Of Occupancy (Dwell Time)	Sample 1	Compliant	Appendix A.4
§15.247(a)(1)	Number Of Hopping Frequency	Sample 1	Compliant	Appendix A.5
§15.209(a)	Radiated Spurious Emissions	Sample 1 Sample 2	Compliant	Note 1
§15.247(d)	Band Edges Measurements and Conducted Spurious Emissions	Sample 1	Compliant	Appendix A.6 Appendix A.7
§15.205	Emissions at Restricted Band	Sample 1	Compliant	Appendix A.8
§15.207(a)	AC Mains Conducted Emissions	Sample 2	Compliant	Note 1
§15.203	Antenna Requirements	Sample 1	Compliant	Note 1
§15.247(i)§1.1310 §15.247(i)§2.1091	RF Exposure	N/A	Compliant	Note 2

Remark:

1. Note 1 – Test results inside test report;
2. Note 2 – Test results in other test report (RF Report);



Shenzhen LCS Compliance Testing Laboratory Ltd.
 Add: 101, 201 Bldg A & 301 Bldg C, Juji Industrial Park Yabianxueziwei, Shajing Street, Baoan District, Shenzhen, 518000, China
 Tel: +(86) 0755-82591330 | E-mail: webmaster@lcs-cert.com | Web: www.lcs-cert.com
 Scan code to check authenticity



5. SUMMARY OF TEST EQUIPMENT

Item	Equipment	Manufacturer	Model No.	Serial No.	Cal Date	Due Date
1	Power Meter	R&S	NRVS	100444	2022-06-16	2023-06-15
2	Power Sensor	R&S	NRV-Z81	100458	2022-06-16	2023-06-15
3	Power Sensor	R&S	NRV-Z32	10057	2022-06-16	2023-06-15
4	Test Software	Tonscend	JS1120-2	/	N/A	N/A
5	RF Control Unit	Tonscend	JS0806-2	N/A	2022-10-29	2023-10-28
6	MXA Signal Analyzer	Agilent	N9020A	MY50510140	2022-10-29	2023-10-28
7	DC Power Supply	Agilent	E3642A	N/A	2022-10-29	2023-10-28
8	EMI Test Software	AUDIX	E3	/	N/A	N/A
9	3m Semi Anechoic Chamber	SIDT FRANKONIA	SAC-3M	03CH03-HY	2022-06-16	2023-06-15
10	Positioning Controller	Max-Full	MF7802BS	MF780208586	N/A	N/A
11	Active Loop Antenna	SCHWARZBECK	FMZB 1519B	00005	2021-08-29	2024-08-28
12	By-log Antenna	SCHWARZBECK	VULB9163	9163-470	2021-09-12	2024-09-11
13	Horn Antenna	SCHWARZBECK	BBHA 9120D	9120D-1925	2021-09-05	2024-09-04
14	Broadband Horn Antenna	SCHWARZBECK	BBHA 9170	791	2021-08-29	2024-08-28
15	Broadband Preamplifier	SCHWARZBECK	BBV9719	9719-025	2022-06-16	2023-06-15
16	EMI Test Receiver	R&S	ESR 7	101181	2022-06-16	2023-06-15
17	RS SPECTRUM ANALYZER	R&S	FSP40	100503	2022-10-29	2023-10-28
18	Broadband Preamplifier	/	BP-01M18G	P190501	2022-06-16	2023-06-15
19	6dB Attenuator	/	100W/6dB	1172040	2022-06-16	2023-06-15
20	3dB Attenuator	/	2N-3dB	/	2022-10-29	2023-10-28
21	EMI Test Receiver	R&S	ESPI	101940	2022-08-18	2023-08-17
22	Artificial Mains	R&S	ENV216	101288	2022-06-16	2023-06-15
23	10dB Attenuator	SCHWARZBECK	MTS-IMP-136	261115-001-0032	2022-06-16	2023-06-15
24	EMI Test Software	Farad	EZ	/	N/A	N/A



Shenzhen LCS Compliance Testing Laboratory Ltd.
 Add: 101, 201 Bldg A & 301 Bldg C, Juji Industrial Park Yabianxueziwei, Shajing Street, Baoan District, Shenzhen,
 518000, China
 Tel: +(86) 0755-82591330 | E-mail: webmaster@lcs-cert.com | Web: www.lcs-cert.com
 Scan code to check authenticity



6. MEASUREMENT RESULTS

6.1. Frequency Separation and 20 dB Bandwidth

6.1.1 Limit

According to §15.247(a), Frequency hopping systems shall have hopping channel carrier frequencies separated by a minimum of 25 kHz or the 20 dB bandwidth of the hopping channel, whichever is greater. Alternatively, frequency hopping systems operating in the 2400-2483.5 MHz band may have hopping channel carrier frequencies that are separated by 25 kHz or two-thirds of the 20 dB bandwidth of the hopping channel, whichever is greater, provided the systems operate with an output power no greater than 125 mW.

6.1.2 Block Diagram of Test Setup

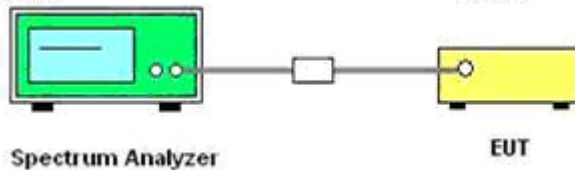

6.1.3 Test Procedure

Frequency separation test procedure :

- 1). Place the EUT on the table and set it in transmitting mode.
- 2). Remove the antenna from the EUT and then connect a low loss RF cable from the antenna port to the Spectrum Analyzer.
- 3). Set center frequency of Spectrum Analyzer = middle of hopping channel.
- 4). Set the Spectrum Analyzer as RBW = 30 kHz, VBW = 100 kHz, Span = wide enough to capture the peaks of two adjacent channels, Sweep = auto.
- 5). Max hold, mark 2 peaks of hopping channel and record the 2 peaks frequency.

20dB bandwidth test procedure :

- 1). Span = approximately 2 to 3 times the 20 dB bandwidth, centered on a hopping channel.
- 2). RBW $\geq 1\%$ of the 20 dB bandwidth, VBW \geq RBW.
- 3). Detector function = peak.
- 4). Trace = max hold.

6.1.4 Test Results

6.1.4.1 20dB Bandwidth

PASS

Please refer to Appendix A.1

Remark:

1. Test results including cable loss;
2. Measured 20dB Bandwidth at difference Packet Type for each mode and recorded worst case for each mode.
3. Worst case data at DH5 for GFSK, 2DH5 for $\pi/4$ -DQPSK, 3DH5 for 8-DPSK modulation type;

6.1.4.2 Frequency Separation

PASS

Please refer to Appendix A.3





6.2. Peak Power

6.2.1 Block Diagram of Test Setup

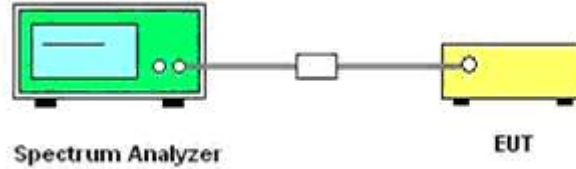

6.2.2 Limit

According to §15.247(b)(1), For frequency hopping systems operating in the 2400–2483.5 MHz band employing at least 75 non-overlapping hopping channels, and all frequency hopping systems in the 5725–5850 MHz band: 1 watt. For all other frequency hopping systems in the 2400–2483.5 MHz band: 0.125 watts.

6.2.3 Test Procedure

The transmitter output is connected to the spectrum.

6.2.4. Test Procedures

- 1) Span: Approximately five times the 20 dB bandwidth, centered on a hopping channel.
- 2) RBW > 20 dB bandwidth of the emission being measured.
- 3) VBW \geq RBW.
- 4) Sweep: Auto.
- 5) Detector function: Peak.
- 6) Trace: Max hold.

6.2.5 Test Results

PASS

Please refer to Appendix A.2

Remark:

1. *Test results including cable loss;*
2. *Measured output power at difference Packet Type for each mode and recorded worst case for each mode.*





6.3. Time of Occupancy (Dwell Time)

6.3.1 Limit

According to §15.247(a)(1), Frequency hopping systems operating in the 2400MHz- 2483.5 MHz bands. The average time of occupancy on any channels shall not greater than 0.4 s within a period 0.4 s multiplied by the number of hopping channels employed.

6.3.2 Block Diagram of Test Setup

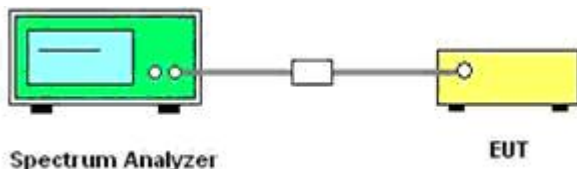

6.3.3 Test Procedure

- 1). Place the EUT on the table and set it in transmitting mode.
- 2). Remove the antenna from the EUT and then connect a low loss RF cable from the antenna port to the Spectrum Analyzer.
- 3). Set center frequency of Spectrum Analyzer = operating frequency.
- 4). Set the Spectrum Analyzer as RBW=1MHz, VBW=3MHz, Span = 0Hz, Sweep = auto.
- 5). Repeat above procedures until all frequency measured was complete.

6.3.4 Test Results

The Dwell Time=Burst Width*Total Hops. The detailed calculations are showed as follows:

The duration for dwell time calculation: $0.4[s]*\text{hopping number}=0.4[s]*79[\text{ch}] =31.6[s*\text{ch}]$;

The burst width [ms/hop/ch], which is directly measured, refers to the duration on one channel hop.

The hops per second for all channels: The selected EUT Conf uses a slot type of 5-Tx&1-Rx and a hopping rate of 1600 [ch*hop/s] for all channels. So the final hopping rate for all channels is $1600/6=266.67 [\text{ch*hop/s}]$

The hops per second on one channel: $266.67 [\text{ch*hops/s}]/79 [\text{ch}] =3.38 [\text{hop/s}]$;

The total hops for all channels within the dwell time calculation duration: $3.38 [\text{hop/s}]*31.6[s*\text{ch}]=106.67 [\text{hop*ch}]$;

The dwell time for all channels hopping: $106.67 [\text{hop*ch}]*\text{Burst Width} [\text{ms/hop/ch}]$.

PASS

Please refer to Appendix A.4

Remark:

1. Test results including cable loss;
2. Measured at difference Packet Type for each mode and recorded worst case for each mode.
3. Dwell Time Calculate formula:

DH5: Dwell time=Pulse Time (ms) $\times (1600 \div 6 \div 79) \times 31.6$ Second



Shenzhen LCS Compliance Testing Laboratory Ltd.

Add: 101, 201 Bldg A & 301 Bldg C, Juji Industrial Park Yabianxueziwei, Shajing Street, Baoan District, Shenzhen, 518000, China

Tel: +(86) 0755-82591330 | E-mail: webmaster@lcs-cert.com | Web: www.lcs-cert.com

Scan code to check authenticity



6.4. Number of Hopping Frequency

6.4.1 Limit

According to §15.247(a)(1), Frequency hopping systems operating in the band 2400-2483.5 MHz shall use at least 15 hopping channels.

6.4.2 Block Diagram of Test Setup

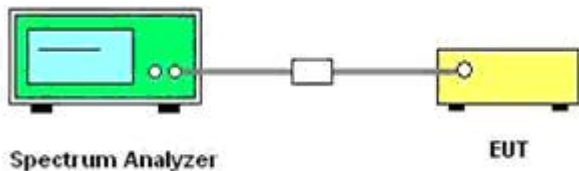

6.4.3 Test Procedure

- 1). Place the EUT on the table and set it in transmitting mode.
- 2). Remove the antenna from the EUT and then connect a low loss RF cable from the antenna port to the Spectrum Analyzer.
- 3). Set Spectrum Analyzer Start=2400MHz, Stop = 2483.5MHz, Sweep = auto.
- 4). Set the Spectrum Analyzer as RBW=100KHz, VBW=300KHz.
- 5). Max hold, view and count how many channel in the band.

6.4.4 Test Results

PASS

Please refer to Appendix A.5

Remark:

1. Test results including cable loss;
2. Measured number of hopping channels at difference Packet Type for each mode and recorded worst case for each mode.
3. Worst case data at DH5 for GFSK, 2DH5 for $\pi/4$ -DQPSK, 3DH5 for 8-DPSK modulation type;





6.5. Band Edges Measurements and Conducted Spurious Emissions Test

6.5.1 Limit

In any 100 kHz bandwidth outside the frequency band in which the spread spectrum or digitally modulated intentional radiator is operating, the radio frequency power that is produced by the intentional radiator shall be at least 20 dB below that in the 100 kHz bandwidth within the band that contains the highest level of the desired power, based on either an RF conducted or a radiated measurement. Attenuation below the general limits specified in Section 15.209(a) is not required.

6.5.2 Block Diagram of Test Setup

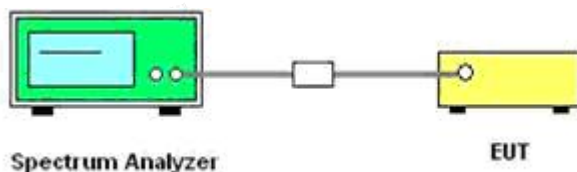

6.5.3 Test Procedure

Conducted RF measurements of the transmitter output were made to confirm that the EUT antenna port conducted emissions meet the specified limit and to identify any spurious signals that require further investigation or measurements on the radiated emissions site.

The transmitter output is connected to the spectrum analyzer. The resolution bandwidth is set to 100 KHz. The video bandwidth is set to 300 KHz.

Measurements are made over the 30 MHz to 25GHz range with the transmitter set to the lowest, middle, and highest channels

6.5.4 Test Results of Conducted Spurious Emissions

No non-compliance noted. Only record the worst test result in this report. The test data refer to the following page.

PASS

Please refer to Appendix A.6 for Band Edges Measurements.

Please refer to Appendix A.7 for Conducted Spurious Emission.

Remark:

1. Test results including cable loss;
2. Measured at difference Packet Type for each mode and recorded worst case for each mode.
3. Worst case data at DH5 for GFSK, 2DH5 for $\pi/4$ -DQPSK, 3DH5 for 8-DPSK modulation type;





6.6. Restricted Band Emission Limit

6.6.1. Standard Applicable

15.205 (a) Except as shown in paragraph (d) of this section, only spurious emissions are permitted in any of the frequency bands listed below:

MHz	MHz	MHz	GHz
0.090-0.110	16.42-16.423	399.9-410	4.5-5.15
1\ 0.495-0.505	16.69475-16.69525	608-614	5.35-5.46
2.1735-2.1905	16.80425-16.80475	960-1240	7.25-7.75
4.125-4.128	25.5-25.67	1300-1427	8.025-8.5
4.17725-4.17775	37.5-38.25	1435-1626.5	9.0-9.2
4.20725-4.20775	73-74.6	1645.5-1646.5	9.3-9.5
6.215-6.218	74.8-75.2	1660-1710	10.6-12.7
6.26775-6.26825	108-121.94	1718.8-1722.2	13.25-13.4
6.31175-6.31225	123-138	2200-2300	14.47-14.5
8.291-8.294	149.9-150.05	2310-2390	15.35-16.2
8.362-8.366	156.52475-156.52525	2483.5-2500	17.7-21.4
8.37625-8.38675	156.7-156.9	2690-2900	22.01-23.12
8.41425-8.41475	162.0125-167.17	3260-3267	23.6-24.0
12.29-12.293	167.72-173.2	3332-3339	31.2-31.8
12.51975-12.52025	240-285	3345.8-3358	36.43-36.5
12.57675-12.57725	322-335.4	3600-4400	(12\)
13.36-13.41			

1\ Until February 1, 1999, this restricted band shall be 0.490-0.510 MHz.

12\ Above 38.6

According to §15.247 (d): 20dBc in any 100 kHz bandwidth outside the operating frequency band. In case the emission fall within the restricted band specified on 15.205(a), then the 15.209(a) limit in the table below has to be followed.

Frequencies (MHz)	Field Strength (microvolts/meter)	Measurement Distance (meters)
0.009~0.490	2400/F(KHz)	300
0.490~1.705	24000/F(KHz)	30
1.705~30.0	30	30
30~88	100	3
88~216	150	3
216~960	200	3
Above 960	500	3

6.6.2. Measuring Instruments and Setting

Please refer to of equipment list in this report. The following table is the setting of spectrum analyzer and receiver.





Spectrum Parameter	Setting
Attenuation	Auto
Start Frequency	1000 MHz
Stop Frequency	10 th carrier harmonic
RB / VB (Emission in restricted band)	1MHz / 1MHz for Peak, 1 MHz / 1/T kHz for Average
RB / VB (Emission in non-restricted band)	1MHz / 1MHz for Peak, 1 MHz / 1/T kHz for Average

Receiver Parameter	Setting
Attenuation	Auto
Start ~ Stop Frequency	9kHz~150kHz / RB/VB 200Hz/1KHz for QP/AVG
Start ~ Stop Frequency	150kHz~30MHz / RB/VB 9kHz/30KHz for QP/AVG
Start ~ Stop Frequency	30MHz~1000MHz / RB/VB 120kHz/1MHz for QP

6.6.3. Test Procedures

1) Sequence of testing 9 kHz to 30 MHz

Setup:

- The equipment was set up to simulate a typical usage like described in the user manual or described by manufacturer.
- If the EUT is a tabletop system, a rotatable table with 0.8 m height is used.
- If the EUT is a floor standing device, it is placed on the ground.
- Auxiliary equipment and cables were positioned to simulate normal operation conditions.
- The AC power port of the EUT (if available) is connected to a power outlet below the turntable.
- The measurement distance is 3 meter.
- The EUT was set into operation.

Premeasurement:

- The turntable rotates from 0° to 315° using 45° steps.
- The antenna height is 1.0 meter.
- At each turntable position the analyzer sweeps with peak detection to find the maximum of all emissions

Final measurement:

- Identified emissions during the premeasurement the software maximizes by rotating the turntable position (0° to 360°) and by rotating the elevation axes (0° to 360°).
- The final measurement will be done in the position (turntable and elevation) causing the highest emissions with QPK detector.
- The final levels, frequency, measuring time, bandwidth, turntable position, correction factor, margin to the limit and limit will be recorded. Also a plot with the graph of the premeasurement and the limit will be stored.





2) Sequence of testing 30 MHz to 1 GHz

Setup:

- The equipment was set up to simulate a typical usage like described in the user manual or described by manufacturer.
- If the EUT is a tabletop system, a table with 0.8 m height is used, which is placed on the ground plane.
- If the EUT is a floor standing device, it is placed on the ground plane with insulation between both.
- Auxiliary equipment and cables were positioned to simulate normal operation conditions
- The AC power port of the EUT (if available) is connected to a power outlet below the turntable.
- The measurement distance is 3 meter.
- The EUT was set into operation.

Premeasurement:

- The turntable rotates from 0° to 315° using 45° steps.
- The antenna is polarized vertical and horizontal.
- The antenna height changes from 1 to 4 meter.
- At each turntable position, antenna polarization and height the analyzer sweeps three times in peak to find the maximum of all emissions.

Final measurement:

- The final measurement will be performed with minimum the six highest peaks.
- According to the maximum antenna and turntable positions of premeasurement the software maximize the peaks by changing turntable position ($\pm 45^\circ$) and antenna movement between 1 and 4 meter.
- The final measurement will be done with QP detector with an EMI receiver.
- The final levels, frequency, measuring time, bandwidth, antenna height, antenna polarization, turntable angle, correction factor, margin to the limit and limit will be recorded. Also a plot with the graph of the premeasurement with marked maximum final measurements and the limit will be stored.



Shenzhen LCS Compliance Testing Laboratory Ltd.

Add: 101, 201 Bldg A & 301 Bldg C, Juji Industrial Park Yabianxueziwei, Shajing Street, Baoan District, Shenzhen, 518000, China

Tel: +(86) 0755-82591330 | E-mail: webmaster@lcs-cert.com | Web: www.lcs-cert.com

Scan code to check authenticity



3) Sequence of testing 1 GHz to 18 GHz

Setup:

- The equipment was set up to simulate a typical usage like described in the user manual or described by manufacturer.
- If the EUT is a tabletop system, a rotatable table with 1.5 m height is used.
- If the EUT is a floor standing device, it is placed on the ground plane with insulation between both.
- Auxiliary equipment and cables were positioned to simulate normal operation conditions
- The AC power port of the EUT (if available) is connected to a power outlet below the turntable.
- The measurement distance is 3 meter.
- The EUT was set into operation.

Premeasurement:

- The turntable rotates from 0° to 315° using 45° steps.
- The antenna is polarized vertical and horizontal.
- The antenna height scan range is 1 meter to 4 meter.
- At each turntable position and antenna polarization the analyzer sweeps with peak detection to find the maximum of all emissions.

Final measurement:

- The final measurement will be performed with minimum the six highest peaks.
- According to the maximum antenna and turntable positions of premeasurement the software maximize the peaks by changing turntable position ($\pm 45^\circ$) and antenna movement between 1 and 4 meter. This procedure is repeated for both antenna polarizations.
- The final measurement will be done in the position (turntable, EUT-table and antenna polarization) causing the highest emissions with Peak and Average detector.
- The final levels, frequency, measuring time, bandwidth, turntable position, EUT-table position, antenna polarization, correction factor, margin to the limit and limit will be recorded. Also a plot with the graph of the premeasurement with marked maximum final measurements and the limit will be stored.





4) Sequence of testing above 18 GHz

Setup:

- The equipment was set up to simulate a typical usage like described in the user manual or described by manufacturer.
- If the EUT is a tabletop system, a rotatable table with 1.5 m height is used.
- If the EUT is a floor standing device, it is placed on the ground plane with insulation between both.
- Auxiliary equipment and cables were positioned to simulate normal operation conditions
- The AC power port of the EUT (if available) is connected to a power outlet below the turntable.
- The measurement distance is 1 meter.
- The EUT was set into operation.

Premeasurement:

- The antenna is moved spherical over the EUT in different polarizations of the antenna.

Final measurement:

- The final measurement will be performed at the position and antenna orientation for all detected emissions that were found during the premeasurements with Peak and Average detector.
- The final levels, frequency, measuring time, bandwidth, correction factor, margin to the limit and limit will be recorded. Also a plot with the graph of the premeasurement and the limit will be stored.





6.6.4. Test Setup Layout

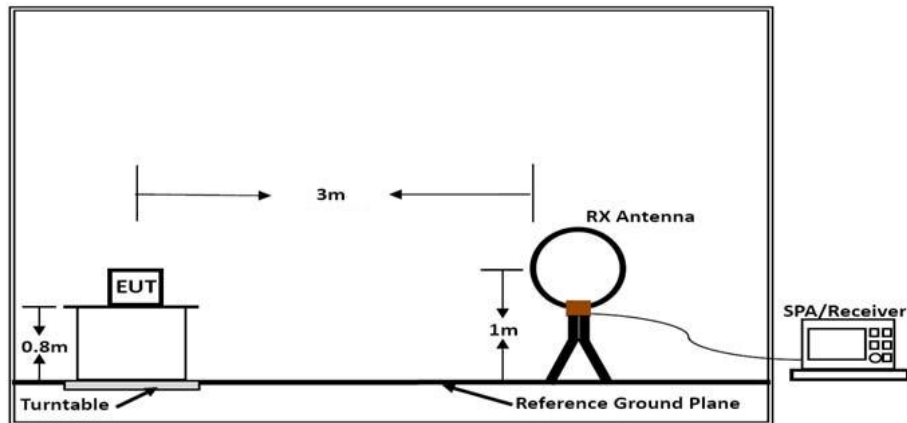

Below 30MHz

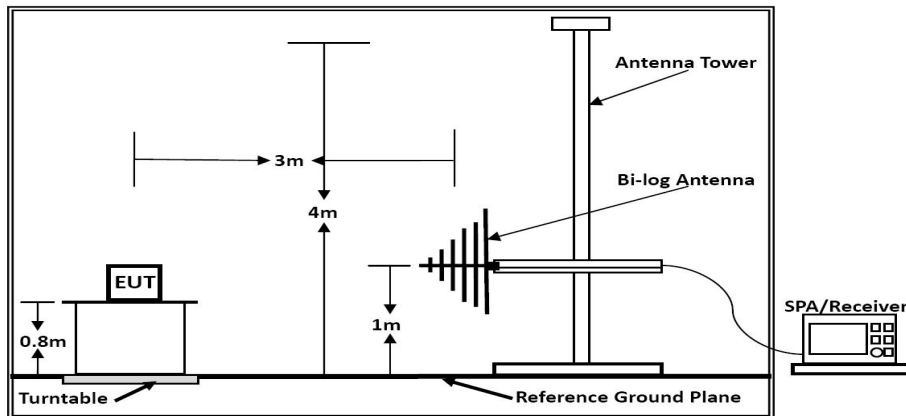

Below 1GHz

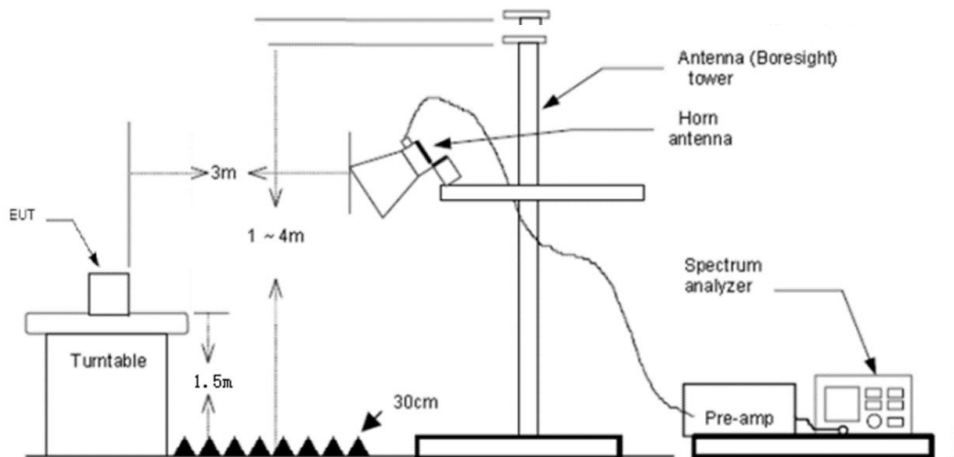

Above 10 GHz shall be extrapolated to the specified distance using an extrapolation factor of 20 dB/decade from 3m to 1.5m.





6.6.5. EUT Operation during Test

The EUT was programmed to be in continuously transmitting mode.

6.6.6. Results of Radiated Emissions (9 KHz~30MHz)

Temperature	23.8℃	Humidity	52.1%
Test Engineer	Ling Zhu	Configurations	BT

Freq. (MHz)	Level (dBUV)	Over Limit (dB)	Over Limit (dBUV)	Remark
-	-	-	-	See Note

Note:

The amplitude of spurious emissions which are attenuated by more than 20 dB below the permissible value has no need to be reported.

Distance extrapolation factor = 40 log (specific distance / test distance) (dB);

Limit line = specific limits (dBUV) + distance extrapolation factor.

6.6.7. Results of Radiated Emissions (30 MHz~1000 MHz)

Temperature	23.8℃	Humidity	52.1%
Test Engineer	Ling Zhu	Configurations	BT

PASS.

The test data please refer to following page.





Horizontal

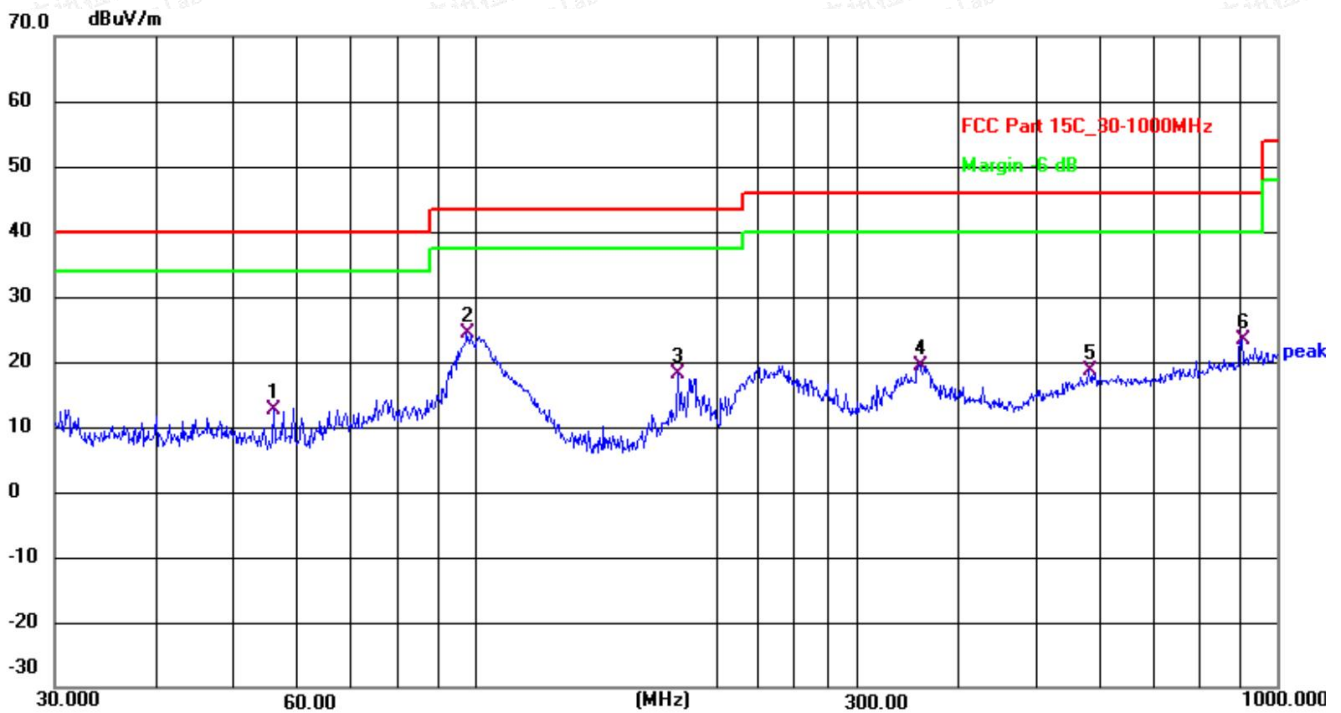

No.	Frequency (MHz)	Reading (dBUV)	Factor (dB/m)	Level (dBUV/m)	Limit (dBUV/m)	Margin (dB)	Detector
1	56.1974	30.92	-18.17	12.75	40.00	-27.25	QP
2	97.7983	42.71	-18.33	24.38	43.50	-19.12	QP
3	179.3863	36.77	-18.74	18.03	43.50	-25.47	QP
4	359.1860	34.26	-14.83	19.43	46.00	-26.57	QP
5	582.7425	29.36	-10.73	18.63	46.00	-27.37	QP
6	903.3094	31.51	-8.25	23.26	46.00	-22.74	QP



Shenzhen LCS Compliance Testing Laboratory Ltd.
 Add: 101, 201 Bldg A & 301 Bldg C, Juji Industrial Park Yabianxueziwei, Shajing Street, Baoan District, Shenzhen, 518000, China
 Tel: +(86) 0755-82591330 | E-mail: webmaster@lcs-cert.com | Web: www.lcs-cert.com
 Scan code to check authenticity

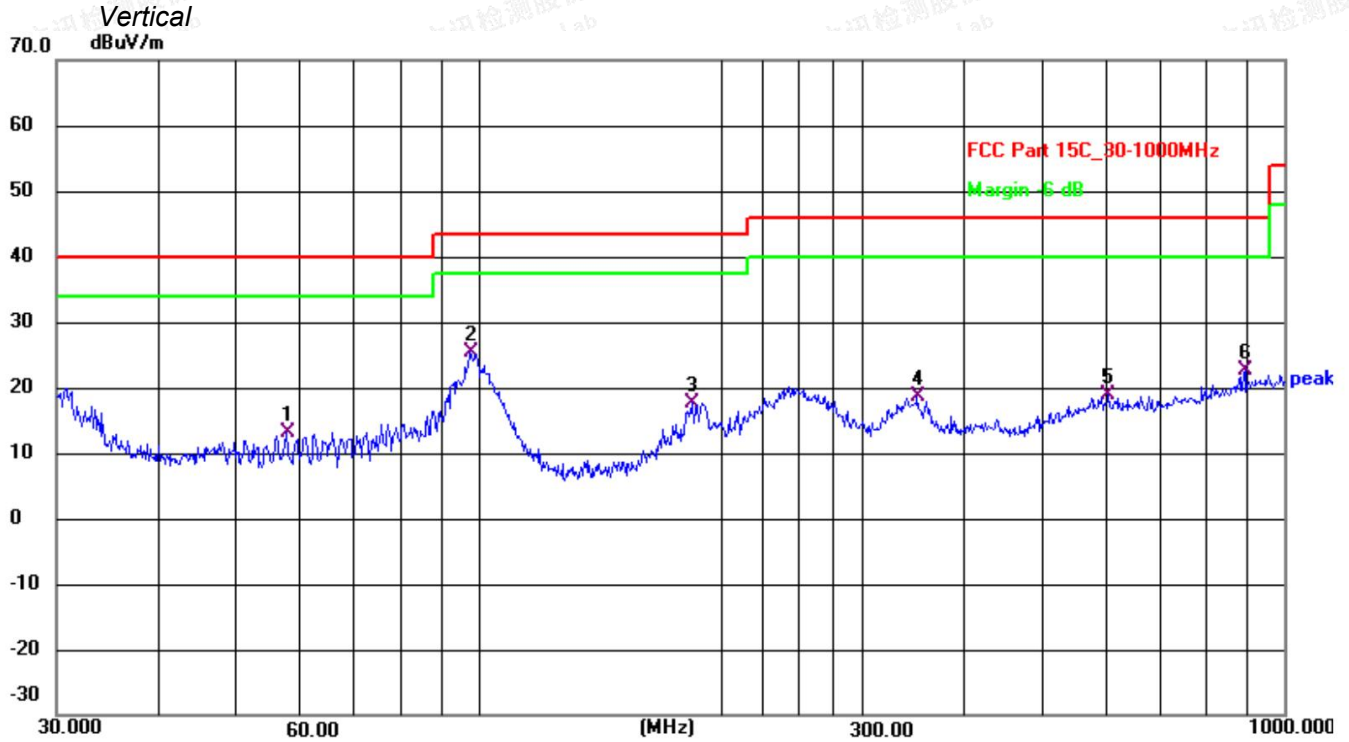

No.	Frequency (MHz)	Reading (dBuV)	Factor (dB/m)	Level (dBuV/m)	Limit (dBuV/m)	Margin (dB)	Detector
1	57.7962	31.47	-18.45	13.02	40.00	-26.98	QP
2	97.7983	43.65	-18.33	25.32	43.50	-18.18	QP
3	184.4898	36.22	-18.54	17.68	43.50	-25.82	QP
4	350.4768	33.43	-14.87	18.56	46.00	-27.44	QP
5	605.6592	29.49	-10.59	18.90	46.00	-27.10	QP
6	893.8567	30.97	-8.40	22.57	46.00	-23.43	QP

Note:

- 1). Pre-scan all modes and recorded the worst case results in this report (3Mbps-Middle Channel).
- 2). Emission level (dBuV/m) = 20 log Emission level (uV/m).
- 3). Level = Reading + Factor, Margin = Level – Limit, Factor = Antenna Factor + Cable Loss - Preamp Factor



Shenzhen LCS Compliance Testing Laboratory Ltd.
 Add: 101, 201 Bldg A & 301 Bldg C, Juji Industrial Park Yabianxueziwei, Shajing Street, Baoan District, Shenzhen, 518000, China
 Tel: +(86) 0755-82591330 | E-mail: webmaster@lcs-cert.com | Web: www.lcs-cert.com
 Scan code to check authenticity



6.6.8. Results of Radiated Emissions (1 GHz~26 GHz)

Note: All the modes have been tested and recorded worst mode in the report.

The worst test result for GFSK, Channel 0 / 2402 MHz

Freq. MHz	Reading dBuV	Ant. Fac dB/m	Pre. Fac. dB	Cab. Loss dB	Measured dBuV/m	Limit dBuV/m	Margin dB	Remark	Pol.
4804.00	60.95	33.06	35.04	3.94	62.91	74.00	-11.09	Peak	Horizontal
4804.00	44.55	33.06	35.04	3.94	46.51	54.00	-7.49	Average	Horizontal
4804.00	54.60	33.06	35.04	3.94	56.56	74.00	-17.44	Peak	Vertical
4804.00	40.10	33.06	35.04	3.94	42.06	54.00	-11.94	Average	Vertical

The worst test result for GFSK, Channel 39 / 2441 MHz

Freq. MHz	Reading dBuV	Ant. Fac dB/m	Pre. Fac. dB	Cab. Loss dB	Measure d dBuV/m	Limit dBuV/m	Margin dB	Remark	Pol.
4882.00	57.91	33.16	35.15	3.96	59.88	74.00	-14.12	Peak	Horizontal
4882.00	45.14	33.16	35.15	3.96	47.11	54.00	-6.89	Average	Horizontal
4882.00	54.23	33.16	35.15	3.96	56.20	74.00	-17.80	Peak	Vertical
4882.00	41.01	33.16	35.15	3.96	42.98	54.00	-11.02	Average	Vertical

The worst test result for GFSK, Channel 78 / 2480 MHz

Freq. MHz	Reading dBuV	Ant. Fac dB/m	Pre. Fac. dB	Cab. Loss dB	Measured dBuV/m	Limit dBuV/m	Margin dB	Remark	Pol.
4960.00	58.57	33.26	35.14	3.98	60.67	74.00	-13.33	Peak	Horizontal
4960.00	45.98	33.26	35.14	3.98	48.08	54.00	-5.92	Average	Horizontal
4960.00	59.22	33.26	35.14	3.98	61.32	74.00	-12.68	Peak	Vertical
4960.00	43.50	33.26	35.14	3.98	45.60	54.00	-8.40	Average	Vertical

The worst test result for $\pi/4$ -DQPSK, Channel 0 / 2402 MHz

Freq. MHz	Reading dBuV	Ant. Fac dB/m	Pre. Fac. dB	Cab. Loss dB	Measure d dBuV/m	Limit dBuV/m	Margin dB	Remark	Pol.
4804.00	59.59	33.06	35.04	3.94	61.55	74.00	-12.45	Peak	Horizontal
4804.00	42.28	33.06	35.04	3.94	44.24	54.00	-9.76	Average	Horizontal
4804.00	57.74	33.06	35.04	3.94	59.70	74.00	-14.30	Peak	Vertical
4804.00	41.43	33.06	35.04	3.94	43.39	54.00	-10.61	Average	Vertical

The worst test result for $\pi/4$ -DQPSK, Channel 39 / 2441 MHz

Freq. MHz	Reading dBuV	Ant. Fac dB/m	Pre. Fac. dB	Cab. Loss dB	Measur ed dBuV/m	Limit dBuV/m	Margin dB	Remark	Pol.
4882.00	58.64	33.16	35.15	3.96	60.61	74.00	-13.39	Peak	Horizontal
4882.00	40.91	33.16	35.15	3.96	42.88	54.00	-11.12	Average	Horizontal
4882.00	54.05	33.16	35.15	3.96	56.02	74.00	-17.98	Peak	Vertical
4882.00	41.25	33.16	35.15	3.96	43.22	54.00	-10.78	Average	Vertical

The worst test result for $\pi/4$ -DQPSK, Channel 78 / 2480 MHz

Freq. MHz	Readin g dBuV	Ant. Fac dB/m	Pre. Fac. dB	Cab. Loss dB	Measure d dBuV/m	Limit dBuV/m	Margin dB	Remark	Pol.
4960.00	57.94	33.26	35.14	3.98	60.04	74.00	-13.96	Peak	Horizontal
4960.00	42.90	33.26	35.14	3.98	45.00	54.00	-9.00	Average	Horizontal
4960.00	54.52	33.26	35.14	3.98	56.62	74.00	-17.38	Peak	Vertical
4960.00	44.23	33.26	35.14	3.98	46.33	54.00	-7.67	Average	Vertical



*The worst test result for 8-DPSK, Channel 0 / 2402 MHz*

Freq. MHz	Reading dBuv	Ant. Fac dB/m	Pre. Fac. dB	Cab. Loss dB	Measured dBuv/m	Limit dBuv/m	Margin dB	Remark	Pol.
4804.00	53.01	33.06	35.04	3.94	54.97	74.00	-19.03	Peak	Horizontal
4804.00	44.62	33.06	35.04	3.94	46.58	54.00	-7.42	Average	Horizontal
4804.00	53.36	33.06	35.04	3.94	55.32	74.00	-18.68	Peak	Vertical
4804.00	42.48	33.06	35.04	3.94	44.44	54.00	-9.56	Average	Vertical

The worst test result for 8-DPSK, Channel 39 / 2441 MHz

Freq. MHz	Reading dBuv	Ant. Fac dB/m	Pre. Fac. dB	Cab. Loss dB	Measured dBuv/m	Limit dBuv/m	Margin dB	Remark	Pol.
4882.00	58.16	33.16	35.15	3.96	60.13	74.00	-13.87	Peak	Horizontal
4882.00	44.13	33.16	35.15	3.96	46.10	54.00	-7.90	Average	Horizontal
4882.00	53.74	33.16	35.15	3.96	55.71	74.00	-18.29	Peak	Vertical
4882.00	43.76	33.16	35.15	3.96	45.73	54.00	-8.27	Average	Vertical

The worst test result for 8-DPSK, Channel 78 / 2480 MHz

Freq. MHz	Reading dBuv	Ant. Fac dB/m	Pre. Fac. dB	Cab. Loss dB	Measured dBuv/m	Limit dBuv/m	Margin dB	Remark	Pol.
4960.00	58.75	33.26	35.14	3.98	60.85	74.00	-13.15	Peak	Horizontal
4960.00	43.51	33.26	35.14	3.98	45.61	54.00	-8.39	Average	Horizontal
4960.00	60.53	33.26	35.14	3.98	62.63	74.00	-11.37	Peak	Vertical
4960.00	43.20	33.26	35.14	3.98	45.30	54.00	-8.70	Average	Vertical

Notes:

- 1). Measuring frequencies from 9 KHz~10th harmonic or 26.5GHz (which is less), at least have 20dB margin found between lowest internal used/generated frequency to 30MHz.
- 2). Radiated emissions measured in frequency range from 9 KHz~10th harmonic or 26.5GHz (which is less) were made with an instrument using Peak detector mode.
- 3). Data of measurement within this frequency range shown “ --- ” in the table above means the reading of emissions are attenuated more than 20dB below the permissible limits or the field strength is too small to be measured.
- 4). Measured Level = Reading Level + Factor, Margin = Measured Level – Limit,
Factor = Antenna Factor + Cable Loss - Preamp Factor



6.7. AC Power Line Conducted Emissions

6.7.1 Standard Applicable

According to §15.207 (a): For an intentional radiator which is designed to be connected to the public utility (AC) power line, the radio frequency voltage that is conducted back onto the AC power line on any frequency or frequencies within the band 150 kHz to 30 MHz shall not exceed 250 microvolts (The limit decreases linearly with the logarithm of the frequency in the range 0.15 MHz to 0.50 MHz). The limits at specific frequency range is listed as follows:

Frequency Range (MHz)	Limits (dB μ V)	
	Quasi-peak	Average
0.15 to 0.50	66 to 56	56 to 46
0.50 to 5	56	46
5 to 30	60	50

* Decreasing linearly with the logarithm of the frequency

6.7.2 Block Diagram of Test Setup

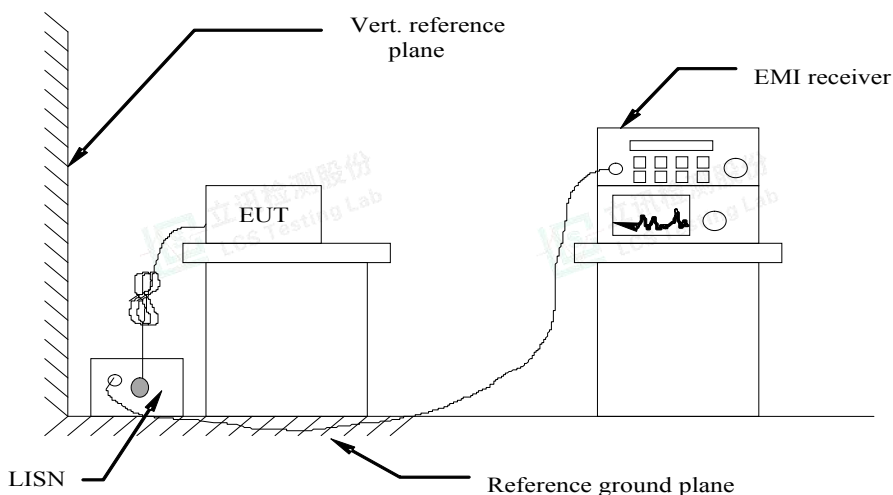

6.7.3 Test Results

Temperature	23.3°C	Humidity	53.1%
Test Engineer	Ling Zhu	Configurations	BT

PASS.

The test data please refer to following page.





Line

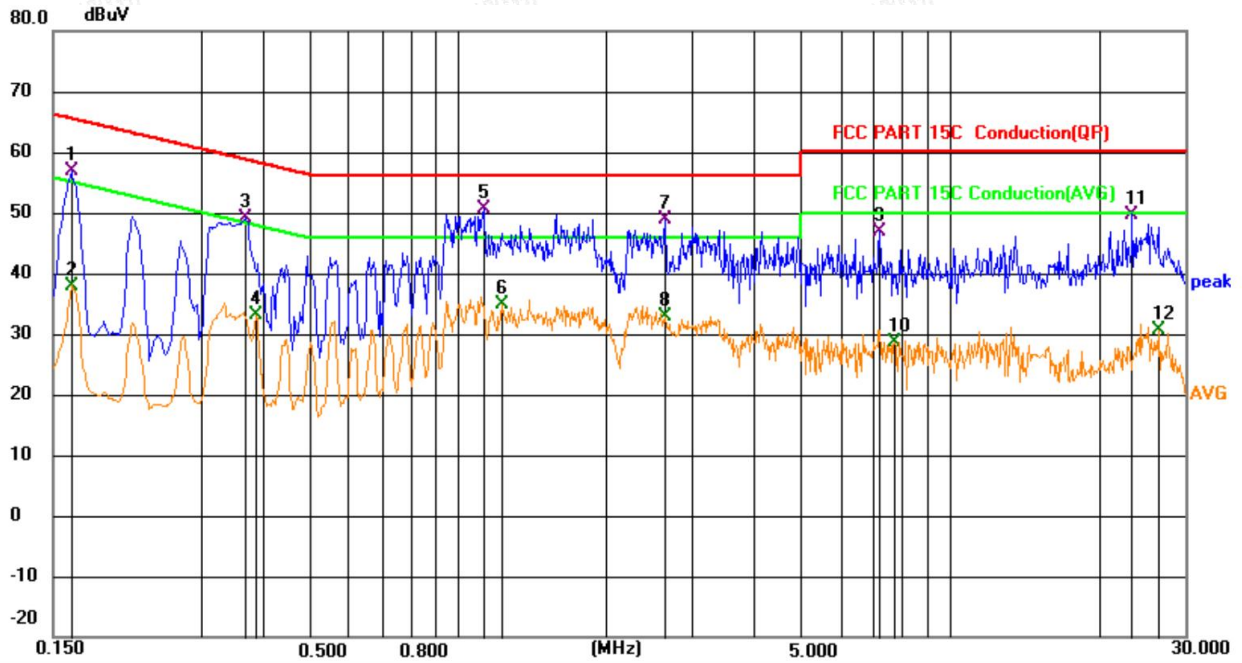

No.	Mk.	Freq. MHz	Reading Level dBuV	Correct Factor dB	Measure- ment dBuV	Limit dBuV	Margin dB	Detector	Comment
1		0.1636	37.16	19.63	56.79	65.28	-8.49	QP	
2		0.1641	18.30	19.63	37.93	55.25	-17.32	AVG	
3		0.3706	29.38	19.63	49.01	58.49	-9.48	QP	
4		0.3886	13.42	19.63	33.05	48.09	-15.04	AVG	
5	*	1.1310	31.08	19.65	50.73	56.00	-5.27	QP	
6		1.2256	15.32	19.66	34.98	46.00	-11.02	AVG	
7		2.6296	29.27	19.68	48.95	56.00	-7.05	QP	
8		2.6385	13.19	19.68	32.87	46.00	-13.13	AVG	
9		7.1791	27.25	19.74	46.99	60.00	-13.01	QP	
10		7.6921	8.95	19.76	28.71	50.00	-21.29	AVG	
11		23.4781	29.69	20.06	49.75	60.00	-10.25	QP	
12		26.6011	10.49	20.03	30.52	50.00	-19.48	AVG	



Shenzhen LCS Compliance Testing Laboratory Ltd.
 Add: 101, 201 Bldg A & 301 Bldg C, Juji Industrial Park Yabianxueziwei, Shajing Street, Baoan District, Shenzhen, 518000, China
 Tel: +(86) 0755-82591330 | E-mail: webmaster@lcs-cert.com | Web: www.lcs-cert.com
 Scan code to check authenticity



Neutral

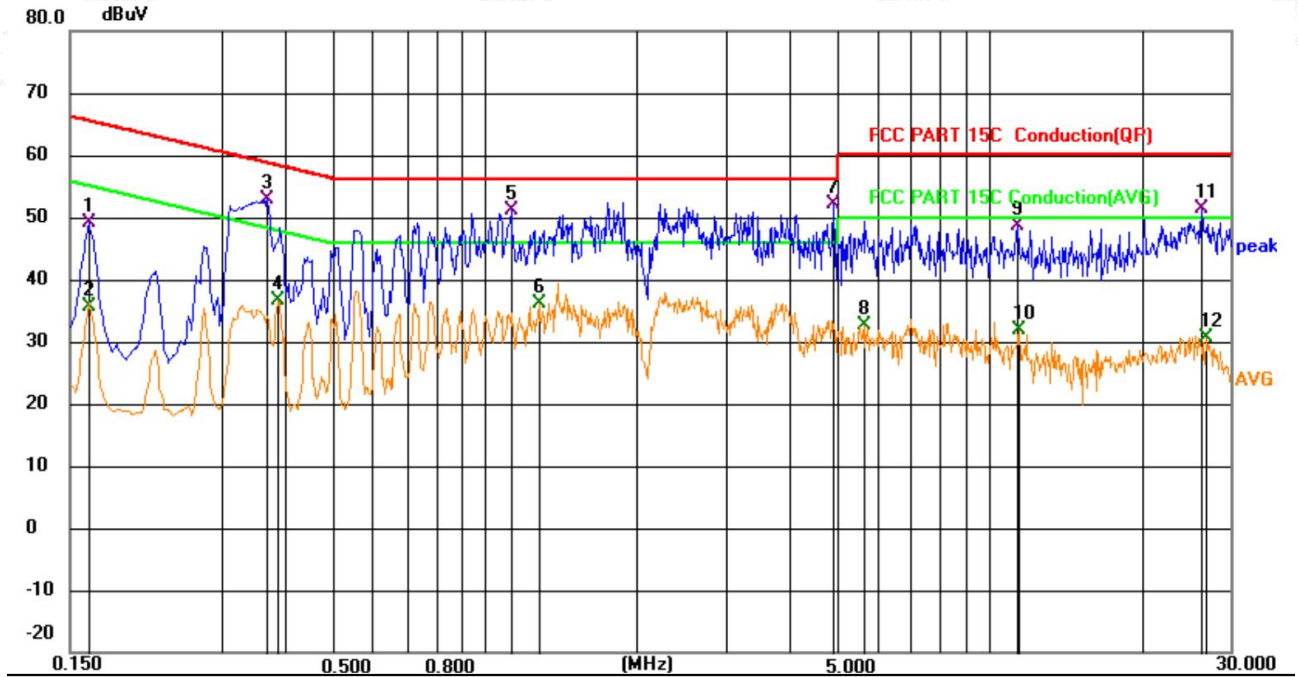

No.	Mk.	Freq. MHz	Reading Level dBuV	Correct Factor dB	Measure- ment dBuV	Limit dBuV	Margin dB	Detector	Comment
1		0.1636	29.56	19.63	49.19	65.28	-16.09	QP	
2		0.1641	16.11	19.63	35.74	55.25	-19.51	AVG	
3		0.3706	33.37	19.63	53.00	58.49	-5.49	QP	
4		0.3886	16.91	19.63	36.54	48.09	-11.55	AVG	
5		1.1266	31.57	19.65	51.22	56.00	-4.78	QP	
6		1.2796	16.51	19.66	36.17	46.00	-9.83	AVG	
7	*	4.9066	32.23	19.80	52.03	56.00	-3.97	QP	
8		5.6626	12.93	19.80	32.73	50.00	-17.27	AVG	
9		11.3911	28.78	19.85	48.63	60.00	-11.37	QP	
10		11.4496	11.95	19.85	31.80	50.00	-18.20	AVG	
11		26.2996	31.25	20.03	51.28	60.00	-8.72	QP	
12		26.9701	10.65	20.05	30.70	50.00	-19.30	AVG	

***Note: Pre-scan all modes and recorded the worst case results in this report (3Mbps-Middle Channel).
 Measurement = Reading + Correct Factor, Margin = Measurement - Limit,
 Correct Factor=Lisn Factor+Cable Factor.



Shenzhen LCS Compliance Testing Laboratory Ltd.
 Add: 101, 201 Bldg A & 301 Bldg C, Juji Industrial Park Yabianxueziwei, Shajing Street, Baoan District, Shenzhen, 518000, China
 Tel: +(86) 0755-82591330 | E-mail: webmaster@lcs-cert.com | Web: www.lcs-cert.com
 Scan code to check authenticity

6.8. Emissions in Restricted Bands

6.8.1 Standard Applicable

In any 100 kHz bandwidth outside the frequency band in which the spread spectrum or digitally modulated intentional radiator is operating, the radio frequency power that is produced by the intentional radiator shall be at least 20 dB below that in the 100 kHz bandwidth within the band that contains the highest level of the desired power, based on either an RF conducted or a radiated measurement, provided the transmitter demonstrates compliance with the peak conducted power limits. If the transmitter complies with the conducted power limits based on the use of RMS averaging over a time interval, as permitted under paragraph (b)(3) of this section, the attenuation required under this paragraph shall be 30 dB instead of 20 dB. Attenuation below the general limits specified in §15.209(a) is not required. In addition, radiated emissions which fall in the restricted bands, as defined in §15.205(a), must also comply with the radiated emission limits specified in §15.209(a) (see §15.205(c)).

6.8.2. Test Setup Layout

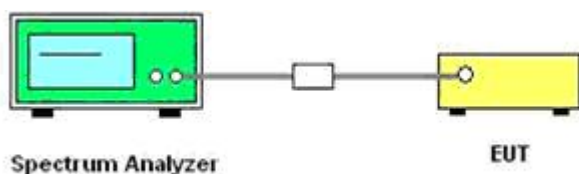

6.8.3. Measuring Instruments and Setting

Please refer to equipment list in this report. The following table is the setting of Spectrum Analyzer.

6.8.4. Test Procedures

According to KDB 412172 section 1.1 Field Strength Approach (linear terms):

$$\text{eirp} = p_t \times g_t = (E \times d)^2/30$$

Where:

p_t = transmitter output power in watts,

g_t = numeric gain of the transmitting antenna (unitless),

E = electric field strength in V/m,

d = measurement distance in meters (m).

$$\text{erp} = \text{eirp}/1.64 = (E \times d)^2/(30 \times 1.64)$$

Where all terms are as previously defined.

1. Check the calibration of the measuring instrument using either an internal calibrator or a known signal from an external generator.
2. Remove the antenna from the EUT and then connect to a low loss RF cable from the antenna port to a EMI test receiver, then turn on the EUT and make it operate in transmitting mode. Then set it to Middle Channel and High Channel within its operating range, and make sure the instrument is operated in its linear range.
3. Set both RBW and VBW of spectrum analyzer to 100 kHz with a convenient frequency span including 100kHz bandwidth from band edge, for Radiated emissions restricted band RBW=1MHz, VBW=3MHz for peak detector and RBW=1MHz, VBW=1/B for AV detector.
4. Measure the highest amplitude appearing on spectral display and set it as a reference level. Plot the graph with marking the highest point and edge frequency.
5. Repeat above procedures until all measured frequencies were complete.



Shenzhen LCS Compliance Testing Laboratory Ltd.

Add: 101, 201 Bldg A & 301 Bldg C, Juji Industrial Park Yabianxueziwei, Shajing Street, Baoan District, Shenzhen, 518000, China

Tel: +(86) 0755-82591330 | E-mail: webmaster@lcs-cert.com | Web: www.lcs-cert.com

Scan code to check authenticity



6. Measure the conducted output power (in dBm) using the detector specified by the appropriate regulatory agency for guidance regarding measurement procedures for determining quasi-peak, peak, and average conducted output power, respectively).
7. Add the maximum transmit antenna gain (in dBi) to the measured output power level to determine the EIRP level (see 12.2.5 for guidance on determining the applicable antenna gain)
8. Add the appropriate maximum ground reflection factor to the EIRP level (6 dB for frequencies ≤ 30 MHz, 4.7 dB for frequencies between 30 MHz and 1000 MHz, inclusive and 0 dB for frequencies > 1000 MHz).
9. For devices with multiple antenna-ports, measure the power of each individual chain and sum the EIRP of all chains in linear terms (e.g., Watts, mW).
10. Compare the resultant electric field strength level to the applicable regulatory limit.
11. Perform radiated spurious emission test duress until all measured frequencies were complete.

6.8.5. Test Results

PASS

Please refer to Appendix A.8

Remark:

1. Measured at difference Packet Type for each mode and recorded worst case for each mode.
2. Worst case data at DH5 for GFSK, 2DH5 for $\pi/4$ -DQPSK, 3DH5 for 8-DPSK modulation type;
3. Measured at Hopping and Non-Hopping mode, recorded worst at Non-Hopping mode.
4. The other emission levels were very low against the limit.
5. The average measurement was not performed when the peak measured data under the limit of average detection.
6. Detector AV is setting spectrum/receiver. RBW=1MHz/VBW=1/B/Sweep time=Auto/Detector=Peak;
7. Since the out-of-band characteristics of the EUT transmit antenna will often be unknown, the use of a conservative antenna gain value is necessary. Thus, when determining the EIRP based on the measured conducted power, the upper bound on antenna gain for a device with a single RF output shall be selected as the maximum in-band gain of the antenna across all operating bands, or 2 dBi, whichever is greater. However, for devices that operate in multiple frequency bands while using the same transmit antenna, the highest gain of the antenna within the operating band nearest in frequency to the restricted band emission being measured may be used in lieu of the overall highest gain when the emission is at a frequency that is within 20 percent of the nearest band edge frequency, but in no case shall a value less than 2 dBi be used.





6.9. Pseudorandom Frequency Hopping Sequence

6.9.1 Standard Applicable

For 47 CFR Part 15C sections 15.247 (a) (1) requirement:

Frequency hopping systems shall have hopping channel carrier frequencies separated by a minimum of 25 kHz or the 20 dB bandwidth of the hop-ping channel, whichever is greater. Alternatively, frequency hopping systems operating in the 2400–2483.5 MHz band may have hopping channel carrier frequencies that are separated by 25 kHz or two-thirds of the 20 dB bandwidth of the hopping channel, whichever is greater, provided the systems operate with an output power no greater than 125 mW. The system shall hop to channel frequencies that are selected at the system hopping rate from a pseudo randomly ordered list of hopping frequencies. Each frequency must be used equally on the average by each transmitter. The system receivers shall have input bandwidths that match the hop-ping channel bandwidths of their corresponding transmitters and shall shift frequencies in synchronization with the transmitted signals.

6.9.2 EUT Pseudorandom Frequency Hopping Sequence Requirement

The pseudorandom frequency hopping sequence may be generated in a nine-stage shift register whose 5th first stage. The sequence begins with the first one of 9 consecutive ones, for example: the shift register is initialized with nine ones.

- Number of shift register stages:9
- Length of pseudo-random sequence:29-1=511 bits
- Longest sequence of zeros:8(non-inverted signal)

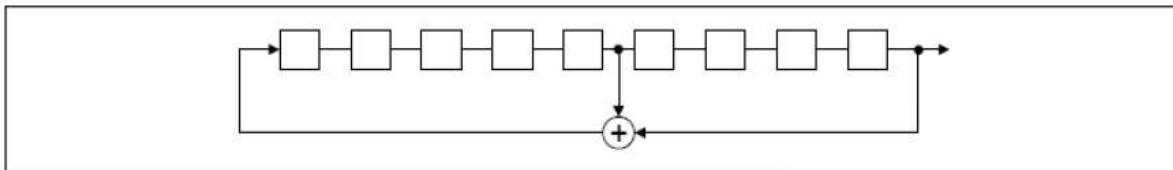

Linear Feedback Shift Register for Generation of the PRBS sequence

An example of pseudorandom frequency hopping sequence as follows:

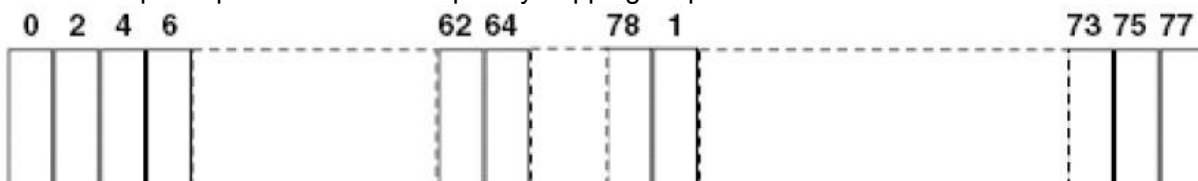

Each frequency used equally one the average by each transmitter. The system receiver have input bandwidths that match the hopping channel bandwidths of their corresponding transmitter and shift frequencies in synchronization with the transmitted signals.





6.10. Antenna Requirement

6.10.1 Standard Applicable

According to antenna requirement of §15.203.

An intentional radiator shall be designed to ensure that no antenna other than that furnished by the responsible party shall be used with the device. The use of a permanently attached antenna or of an antenna that uses a unique coupling to the intentional radiator shall be considered sufficient to comply with the provisions of this Section. The manufacturer may design the unit so that a broken antenna can be re-placed by the user, but the use of a standard antenna jack or electrical connector is prohibited. This requirement does not apply to carrier current devices or to devices operated under the provisions of Sections 15.211, 15.213, 15.217, 15.219, or 15.221. Further, this requirement does not apply to intentional radiators that must be professionally installed, such as perimeter protection systems and some field disturbance sensors, or to other intentional radiators which, in accordance with Section 15.31(d), must be measured at the installation site. However, the installer shall be responsible for ensuring that the proper antenna is employed so that the limits in this Part are not exceeded.

And according to §15.247(4)(1), system operating in the 2400-2483.5MHz bands that are used exclusively for fixed, point-to-point operations may employ transmitting antennas with directional gain greater than 6dBi provided the maximum peak output power of the intentional radiator is reduced by 1 dB for every 3 dB that the directional gain of the antenna exceeds 6dBi.

6.10.2 Antenna Connected Construction

6.10.2.1. Standard Applicable

According to § 15.203 & RSS-Gen, an intentional radiator shall be designed to ensure that no antenna other than that furnished by the responsible party shall be used with the device.

6.10.2.2. Antenna Connector Construction

The gains of antenna used for transmitting is -0.58dBi(Max.), and the antenna is PCB Antenna and no consideration of replacement. Please see EUT photo for details.

6.10.2.3. Results: Compliance.





7. TEST SETUP PHOTOGRAPHS OF EUT

Please refer to separated files for Test Setup Photos of the EUT.

8. EXTERIOR PHOTOGRAPHS OF THE EUT

Please refer to separated files for External Photos of the EUT.

9. INTERIOR PHOTOGRAPHS OF THE EUT

Please refer to separated files for Internal Photos of the EUT.

-----THE END OF TEST REPORT-----

