

11AC20MIMO_Ant1_5500

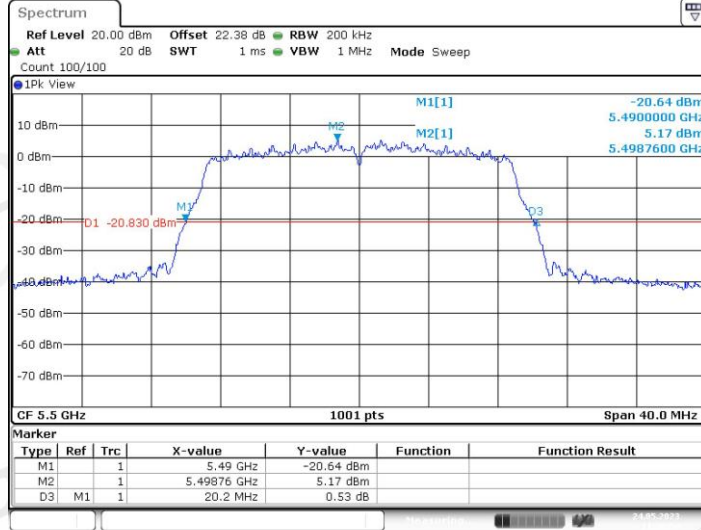

Date: 24.MAY.2023 11:20:55

11AC20MIMO_Ant2_5500

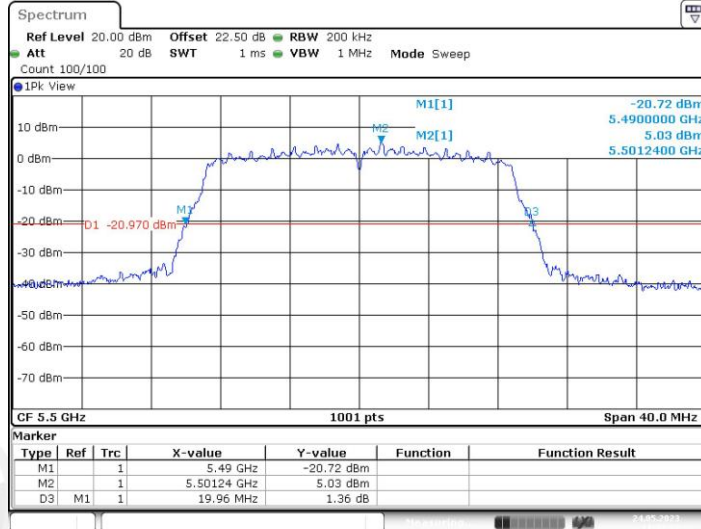

Date: 24.MAY.2023 11:22:37

11AC20MIMO_Ant1_5580

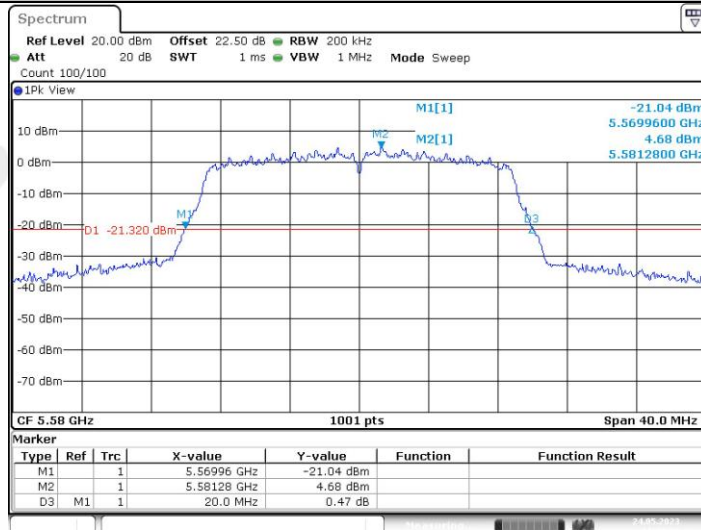

Date: 24.MAY.2023 11:24:34

11AC20MIMO_Ant2_5580

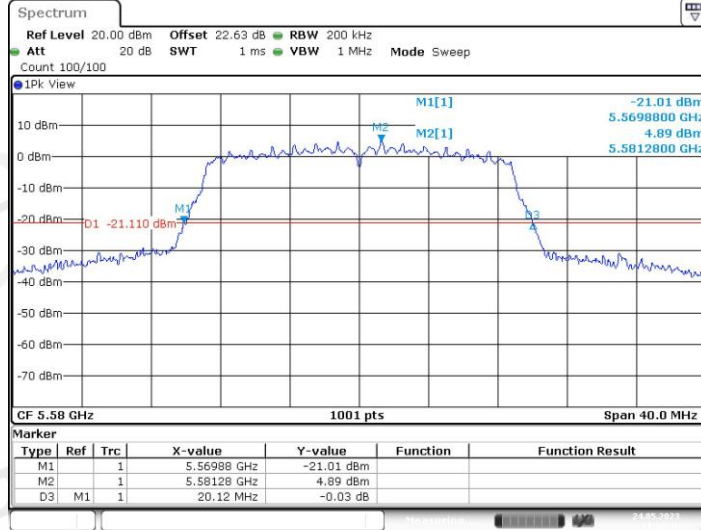

Date: 24.MAY.2023 11:26:16

11AC20MIMO_Ant1_5720

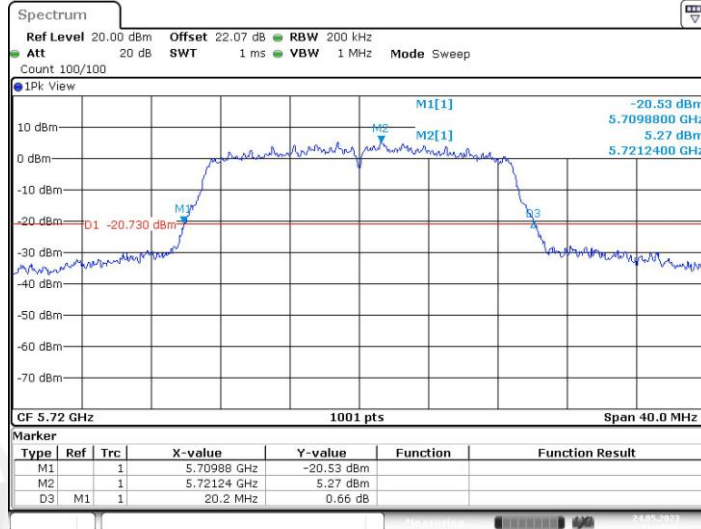

Date: 24.MAY.2023 11:28:08

11AC20MIMO_Ant2_5720

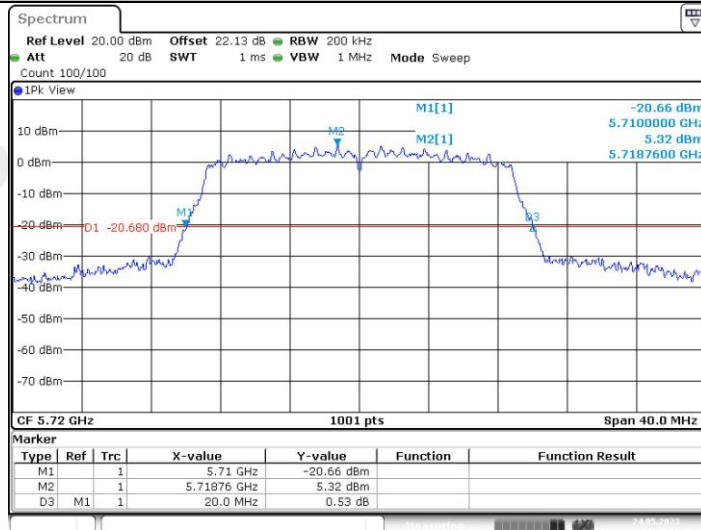

Date: 24.MAY.2023 11:30:19

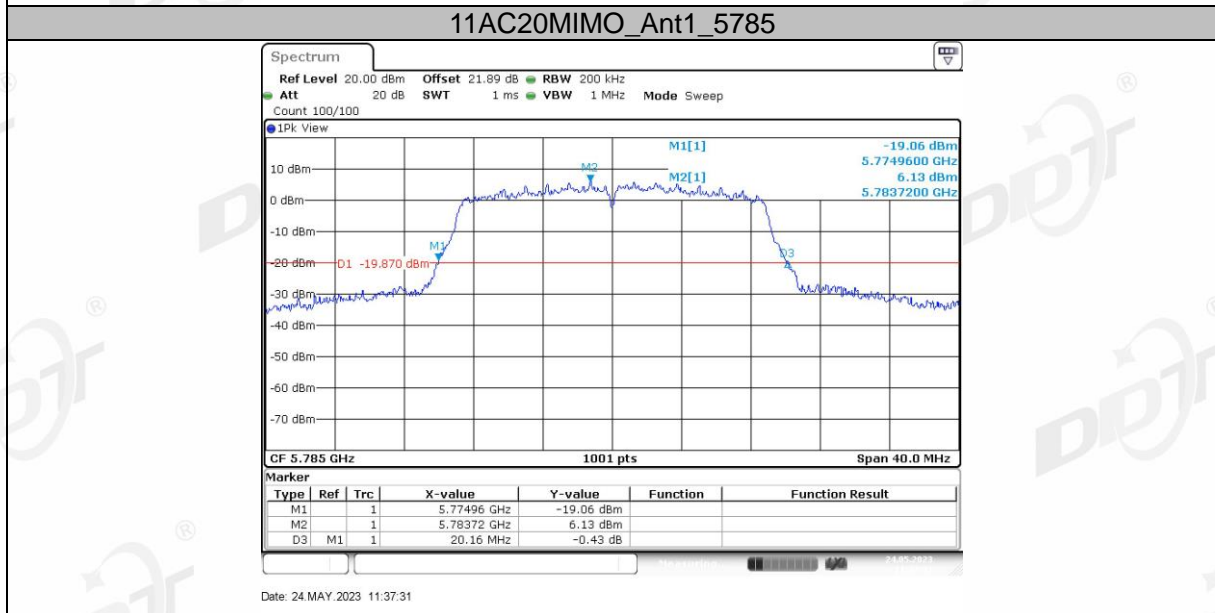
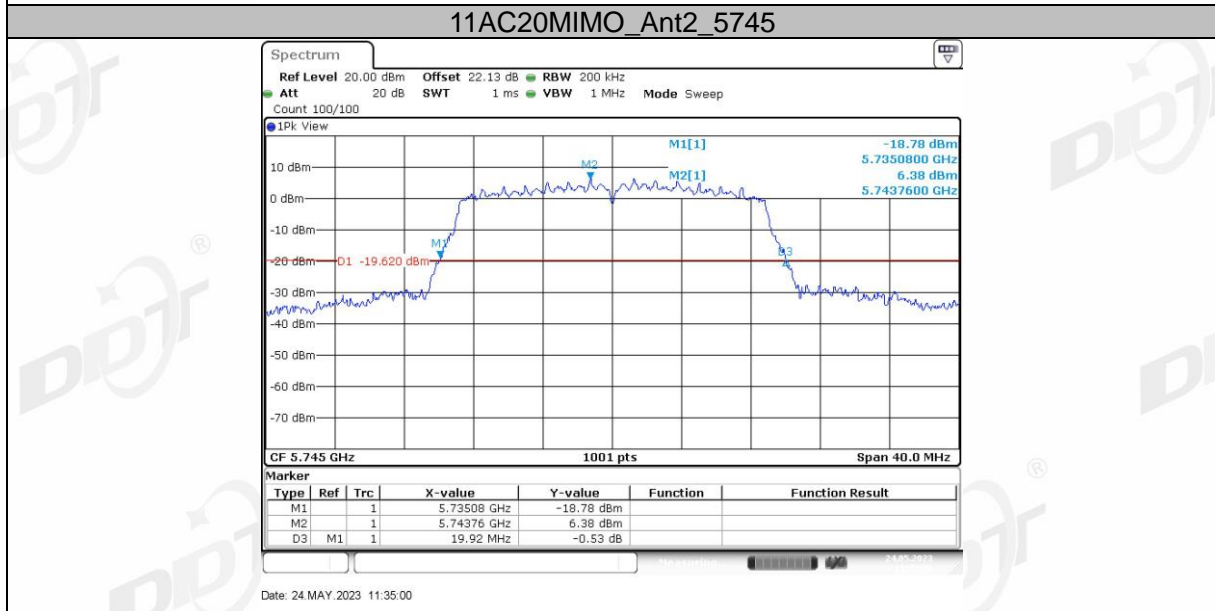
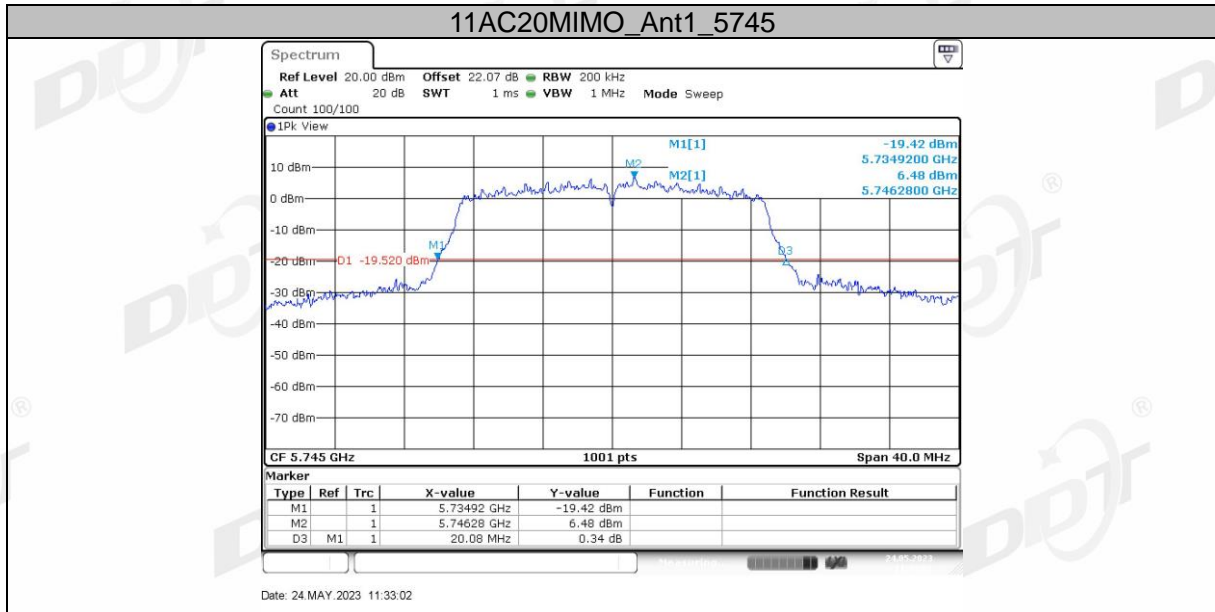

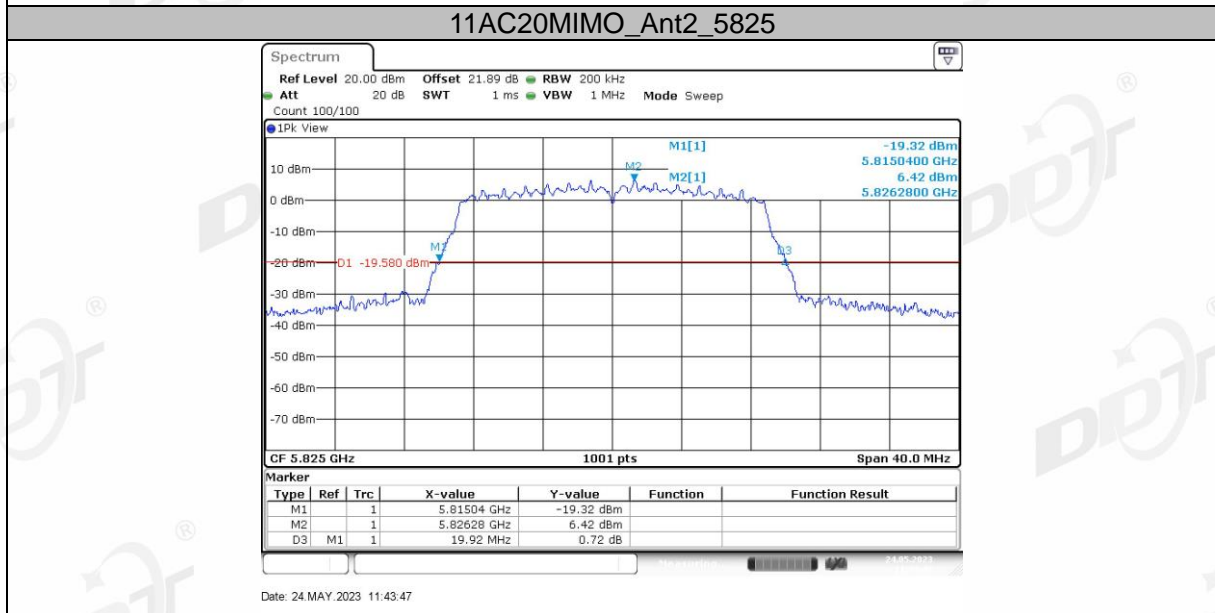
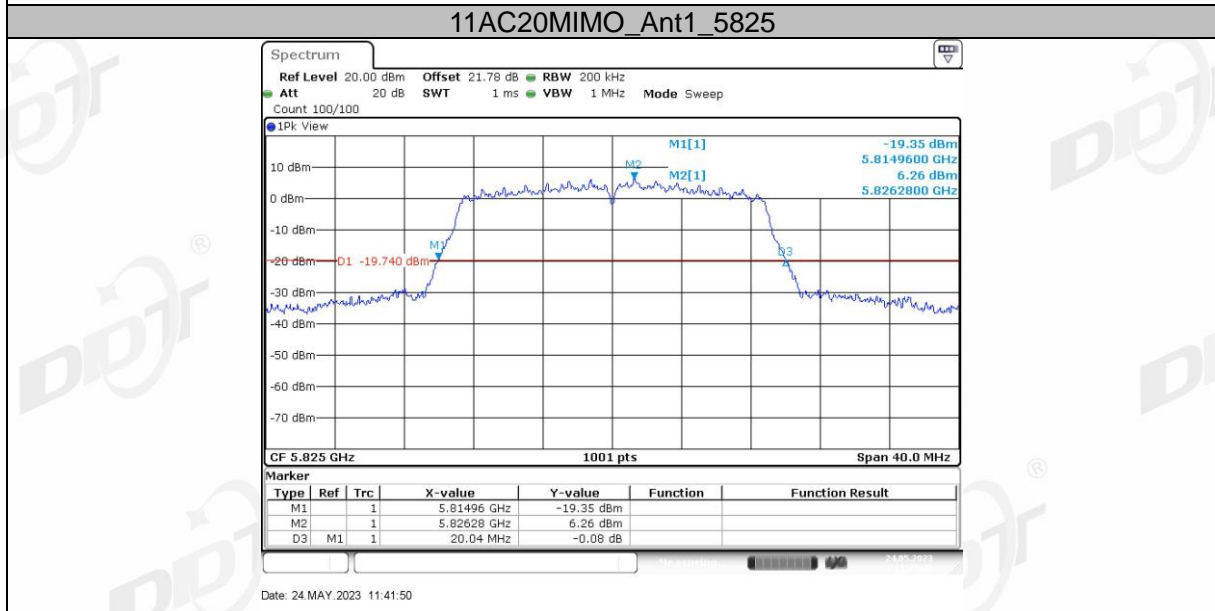
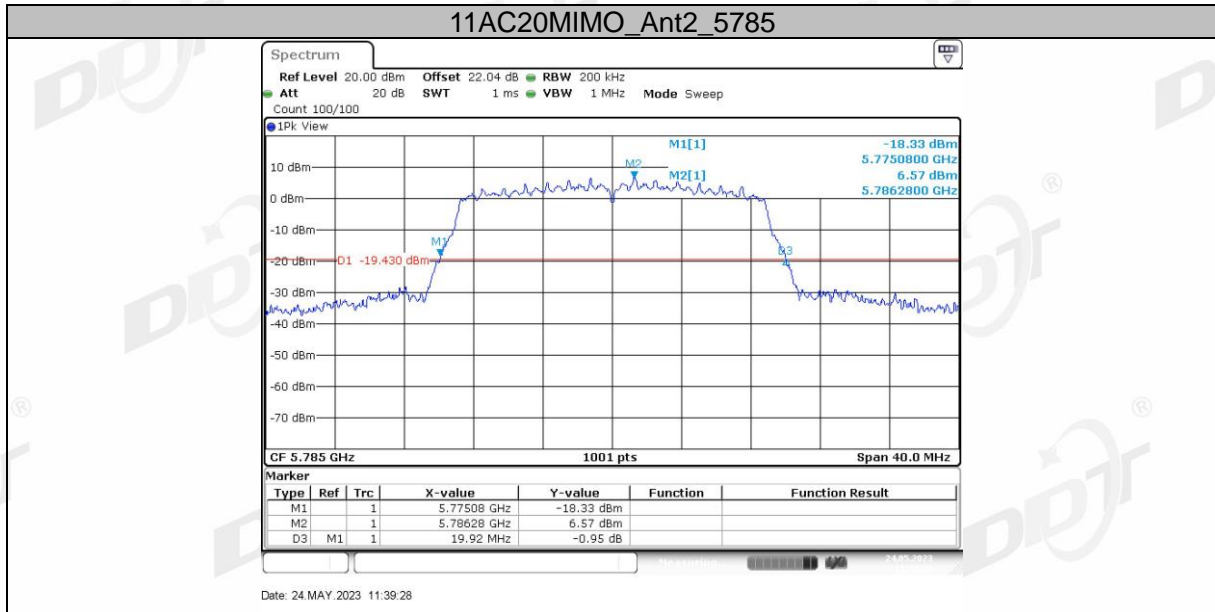

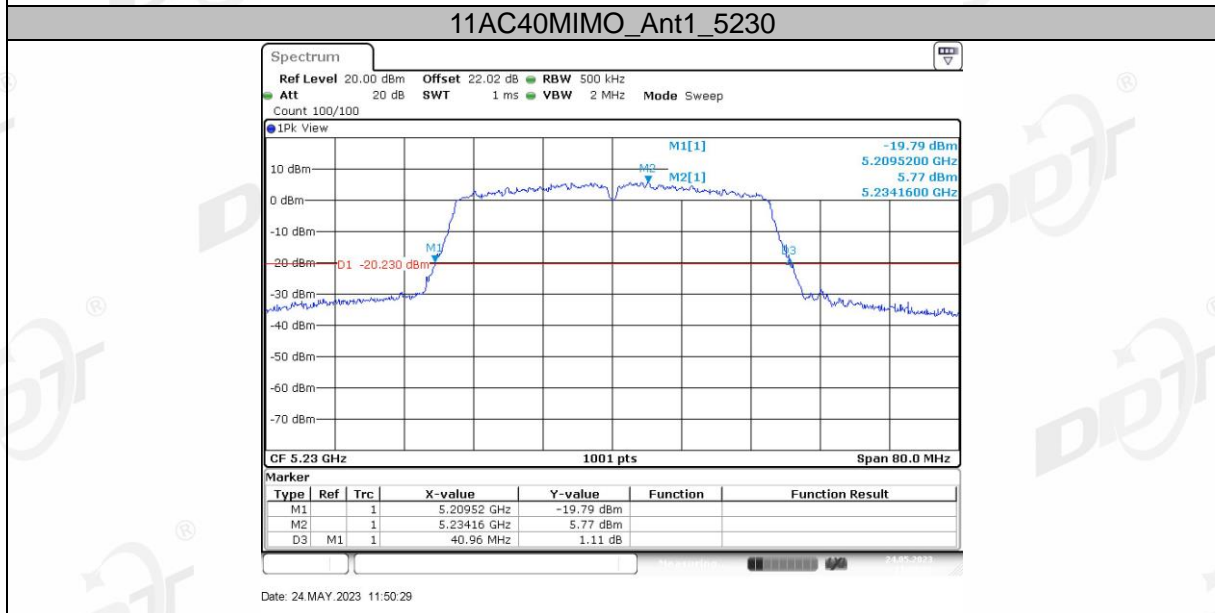
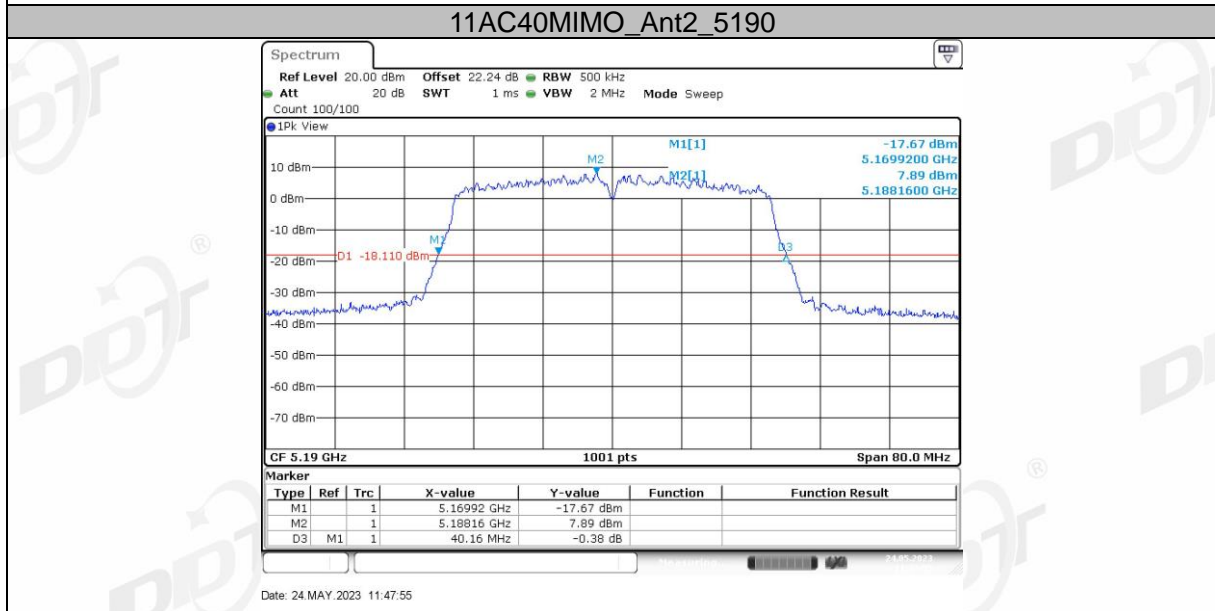
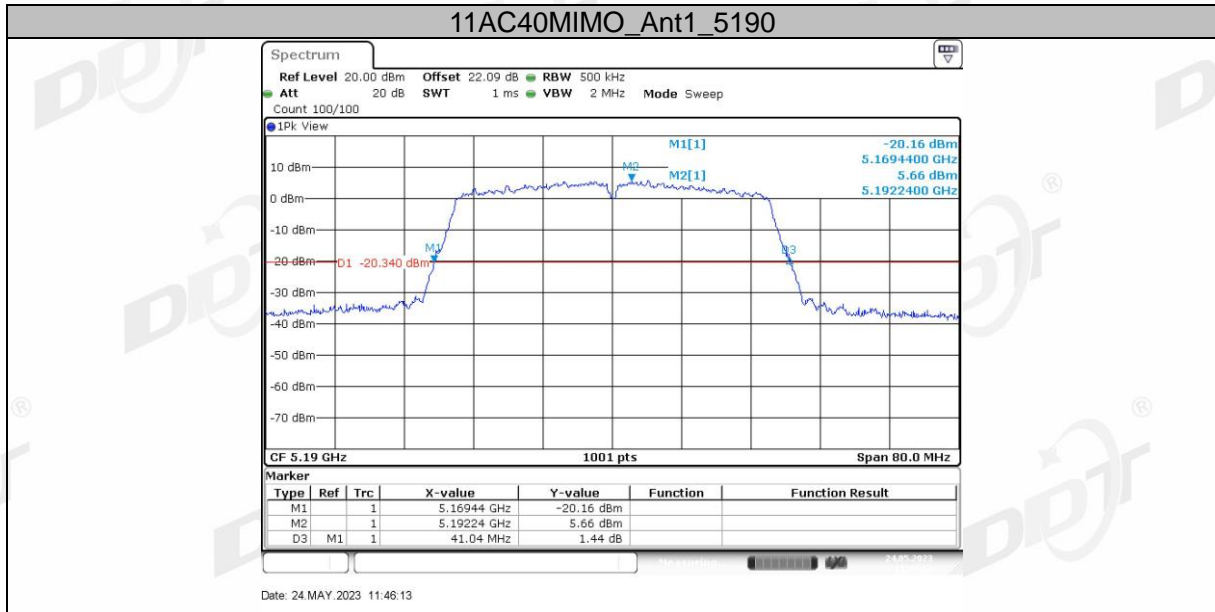

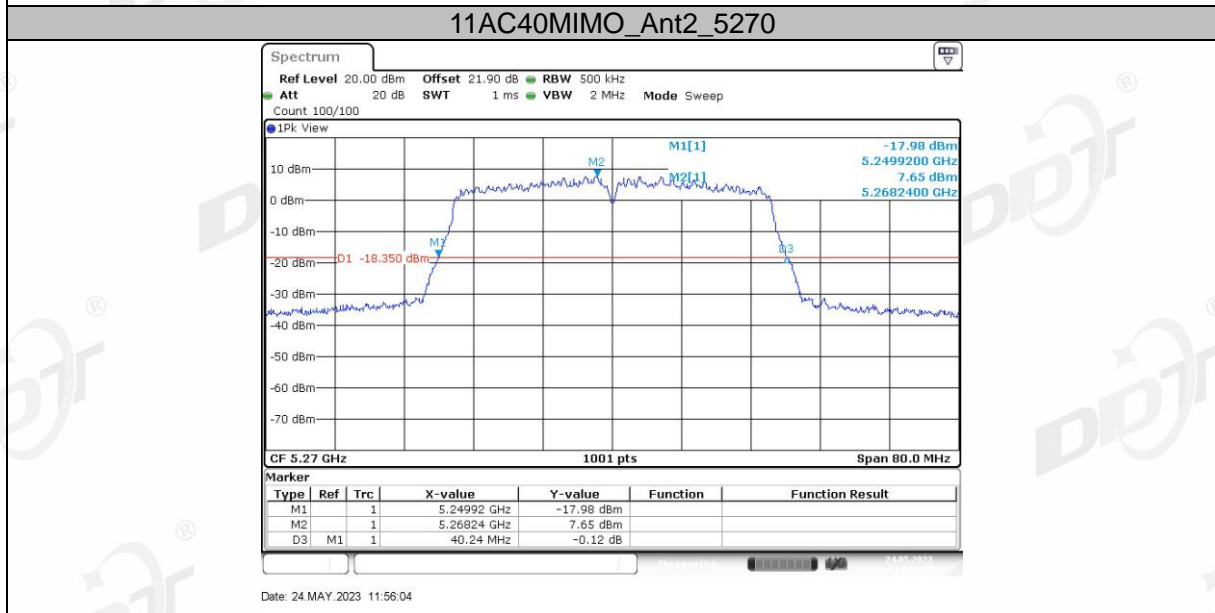
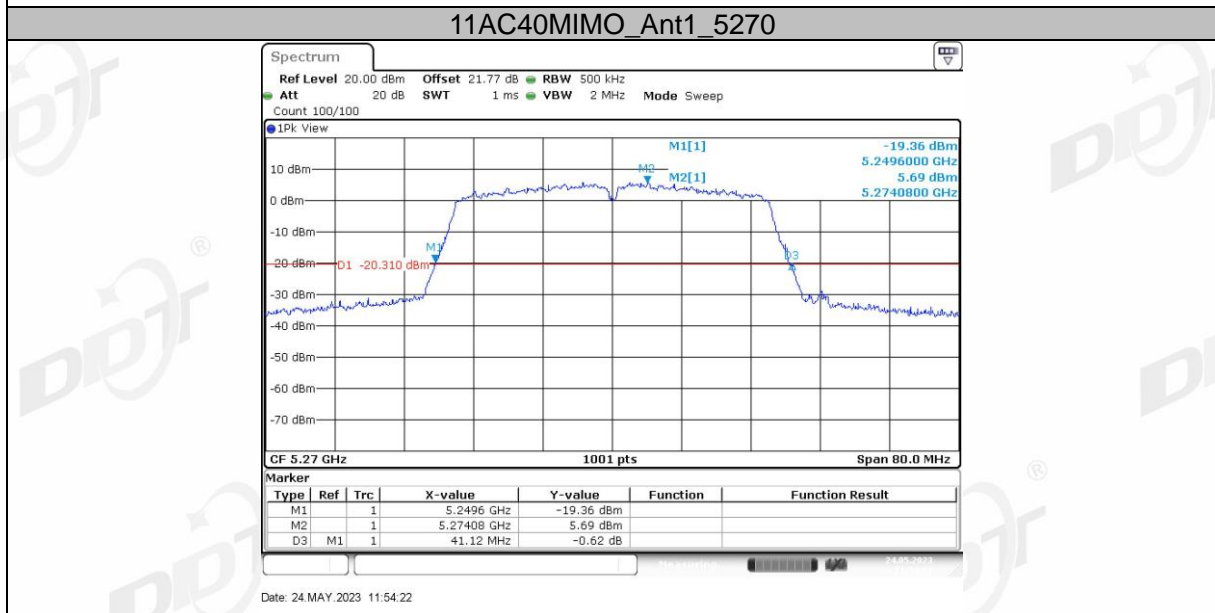
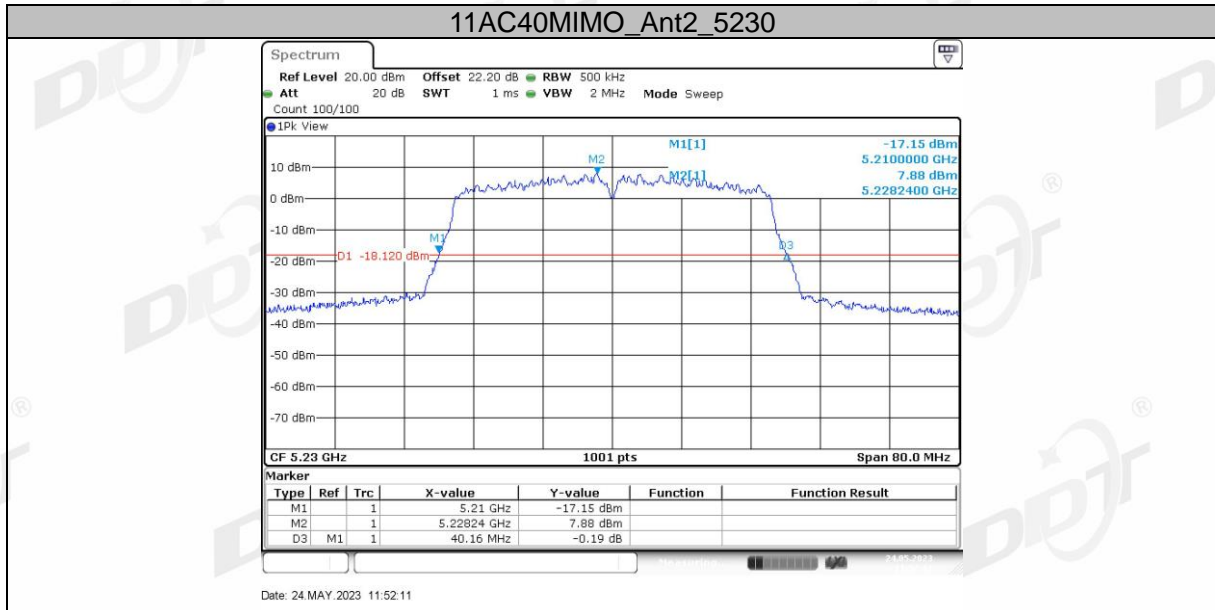

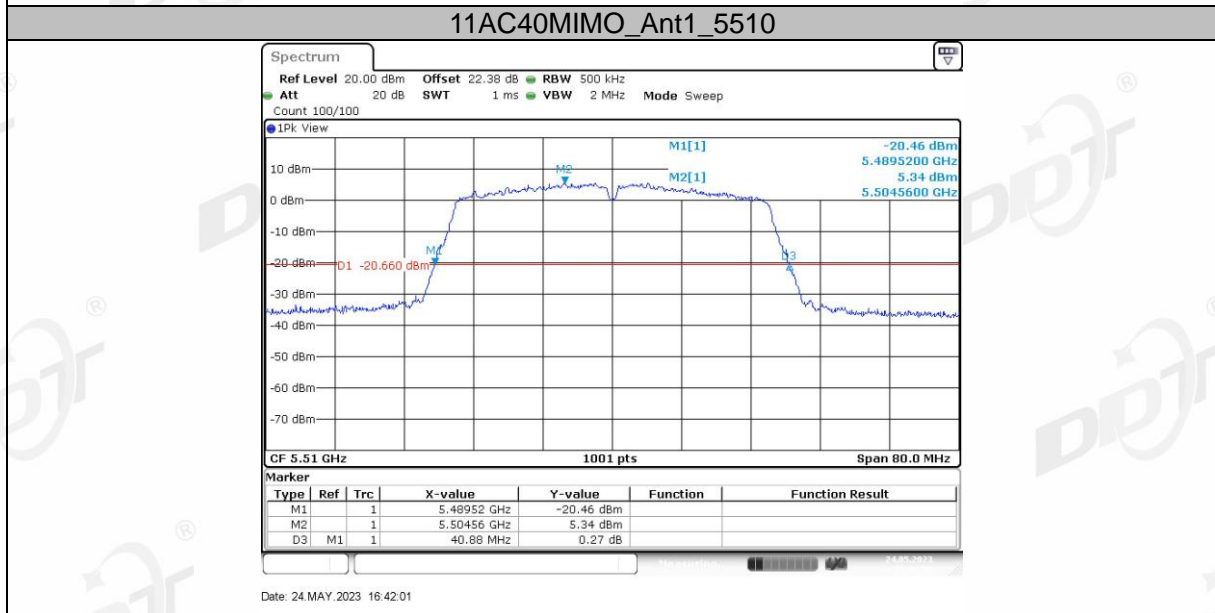
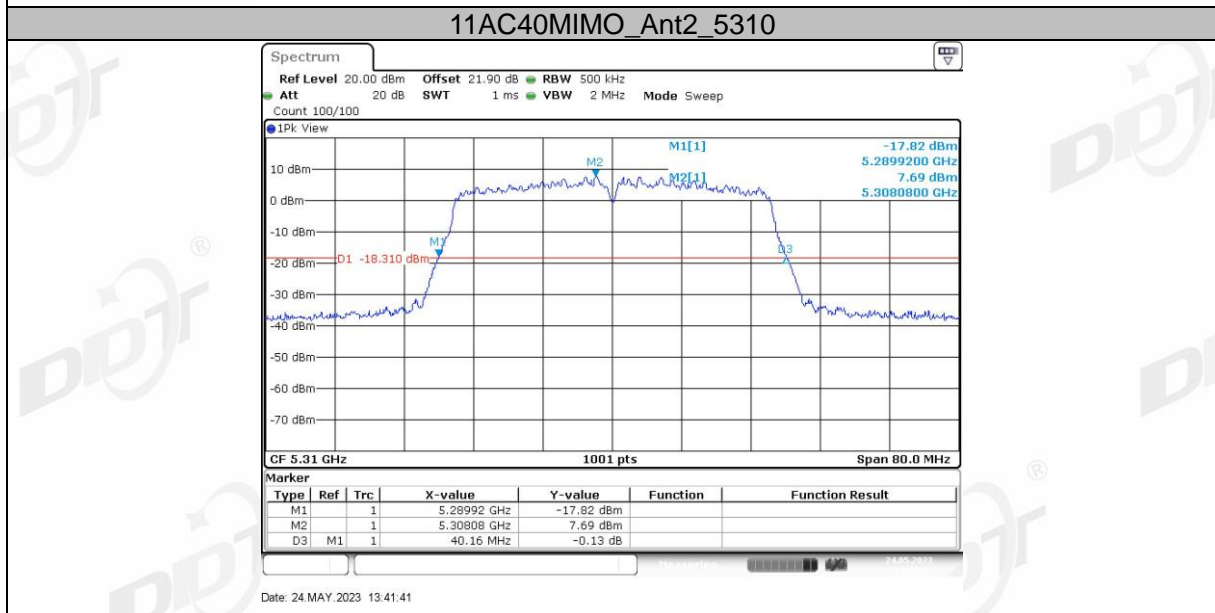
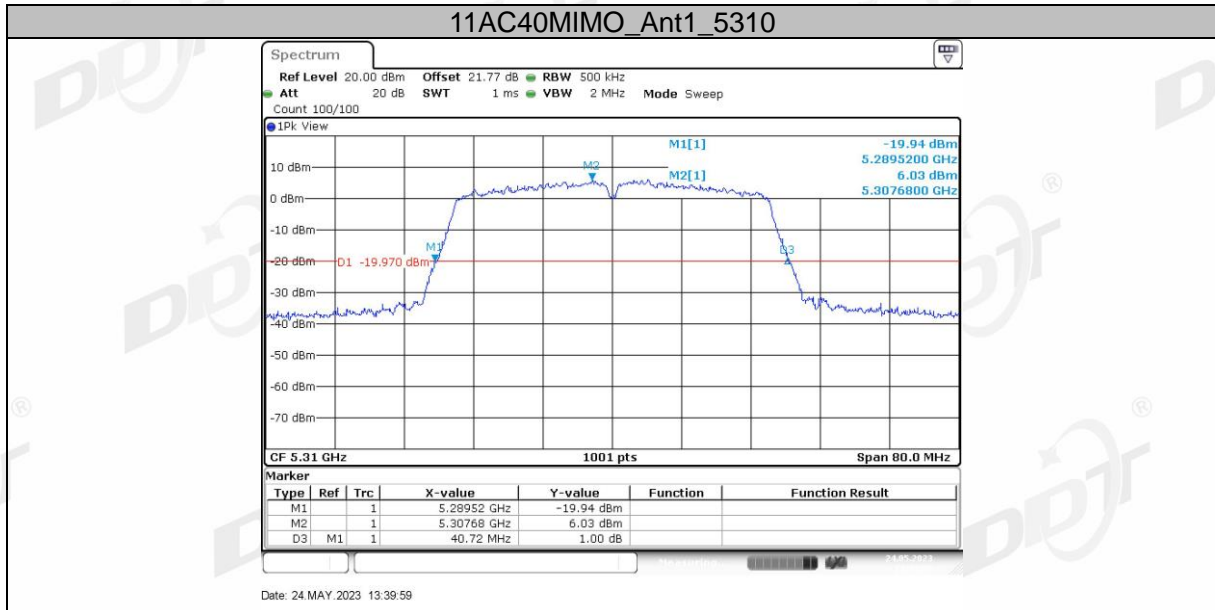

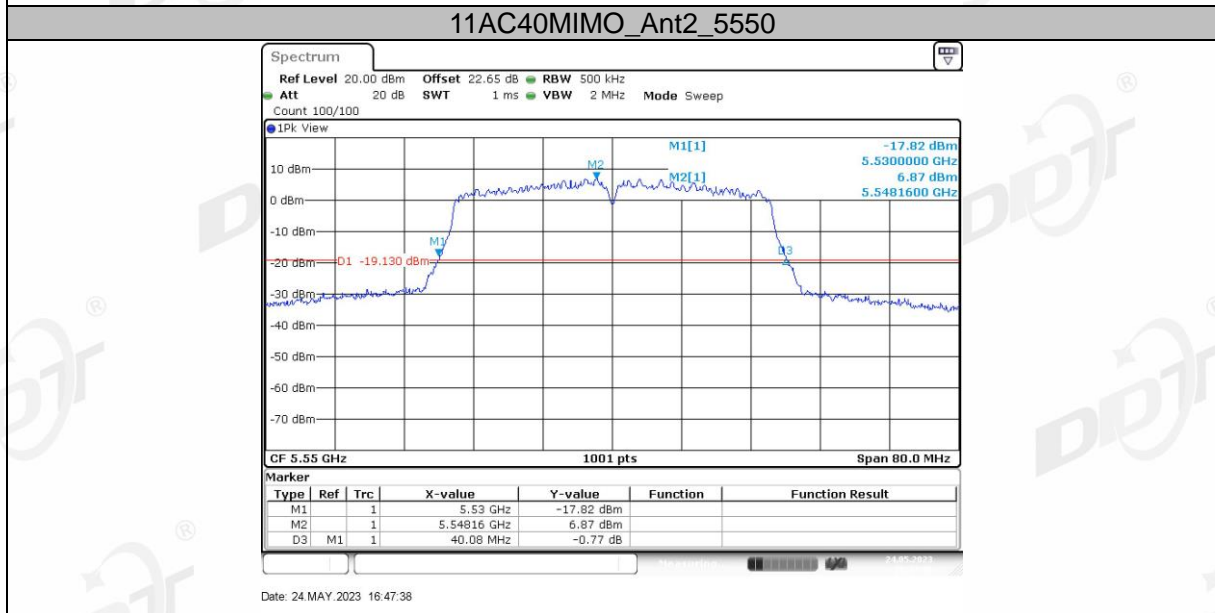
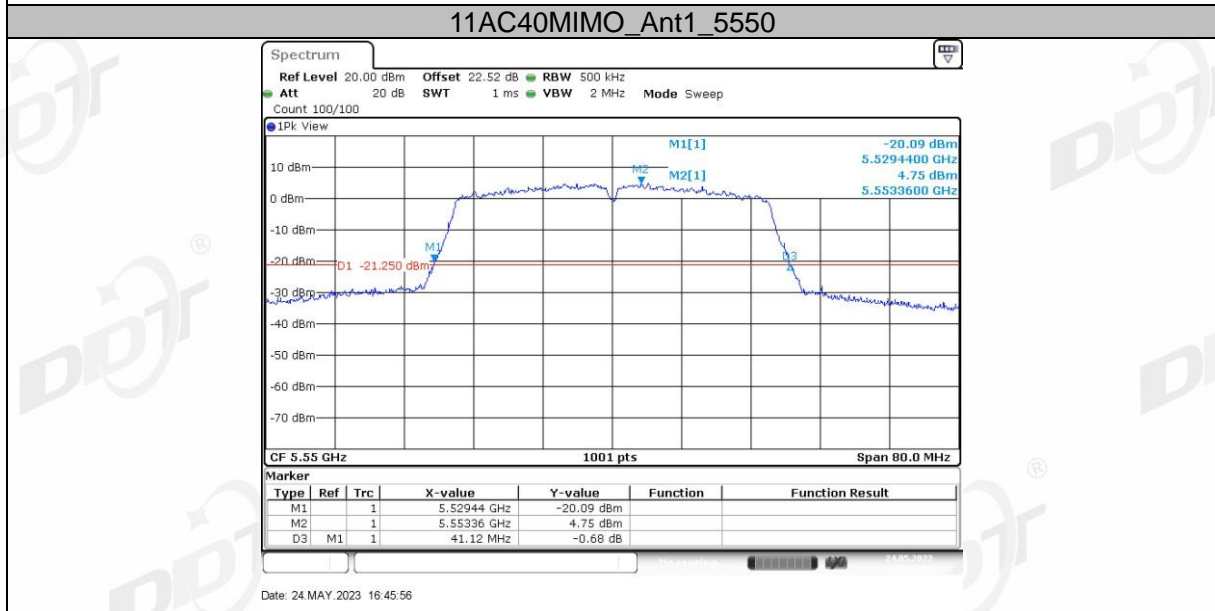
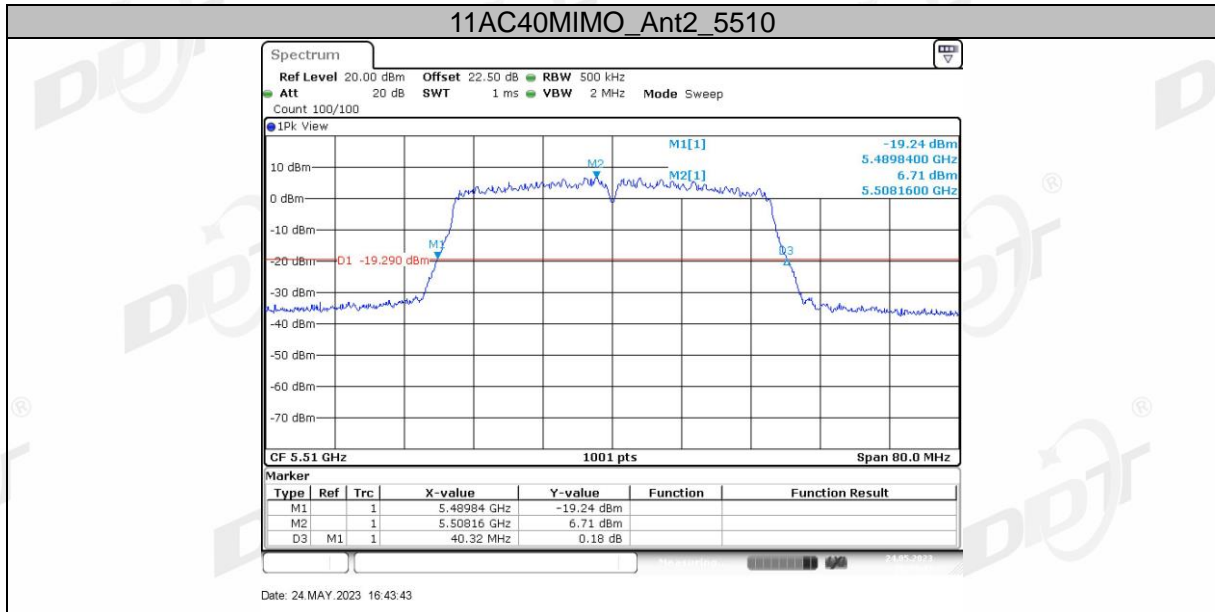

11AC40MIMO_Ant1_5710

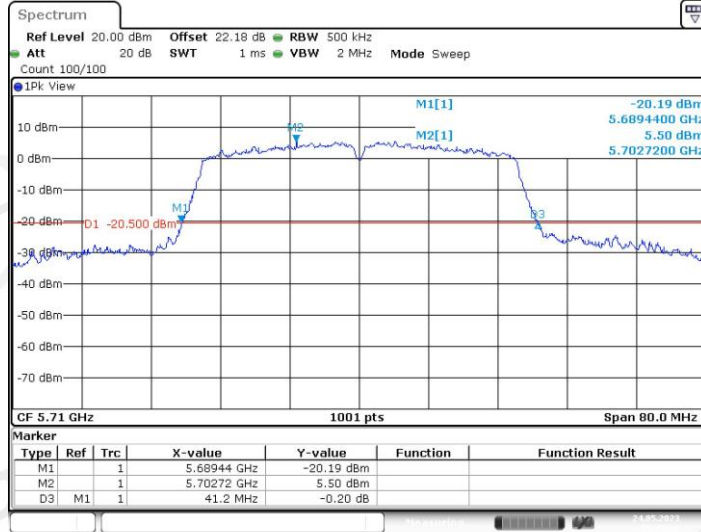

Date: 24.MAY.2023 16:49:50

11AC40MIMO_Ant2_5710

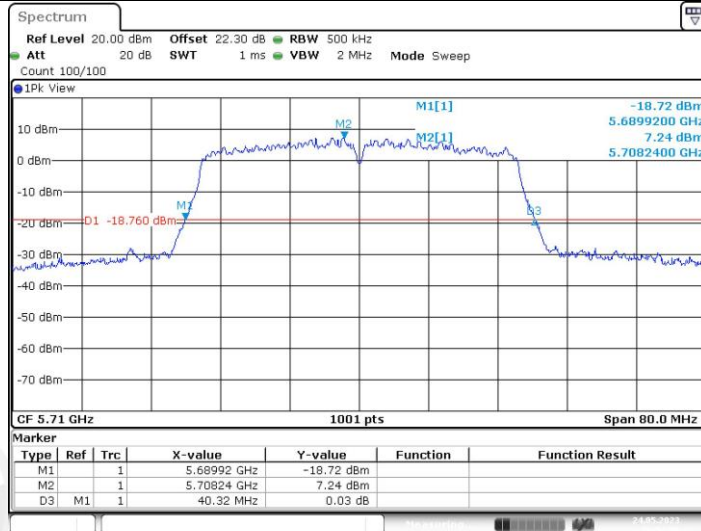

Date: 24.MAY.2023 16:52:01

11AC40MIMO_Ant1_5755

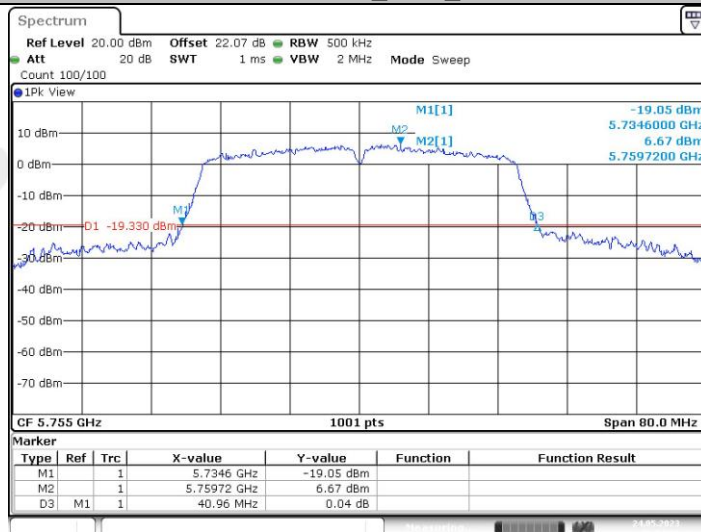

Date: 24.MAY.2023 16:54:28

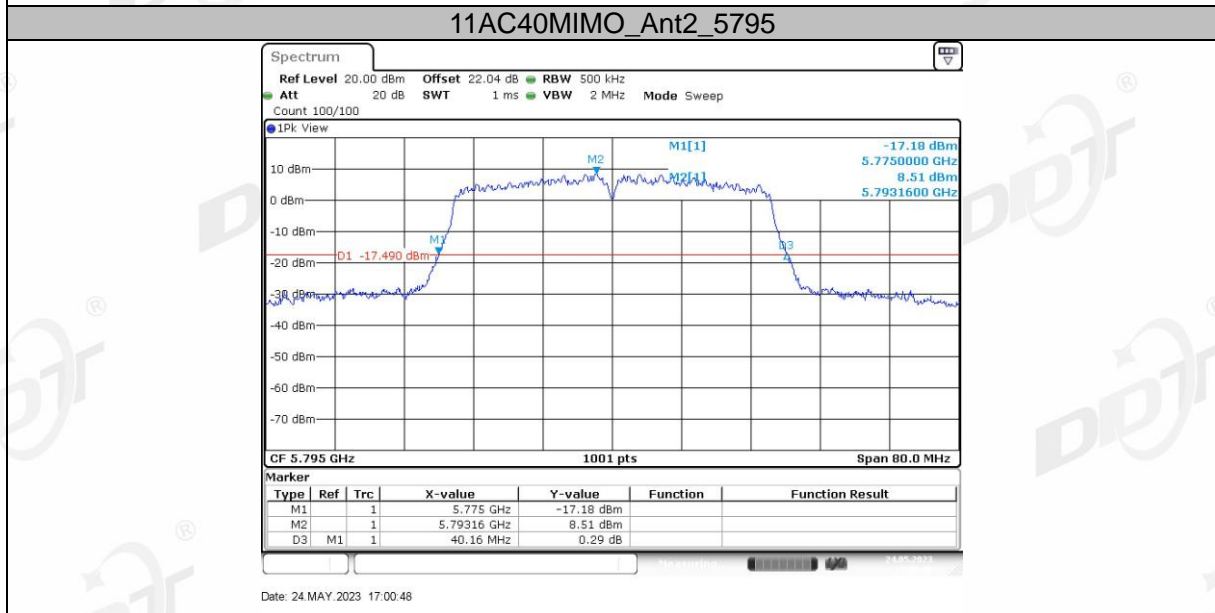
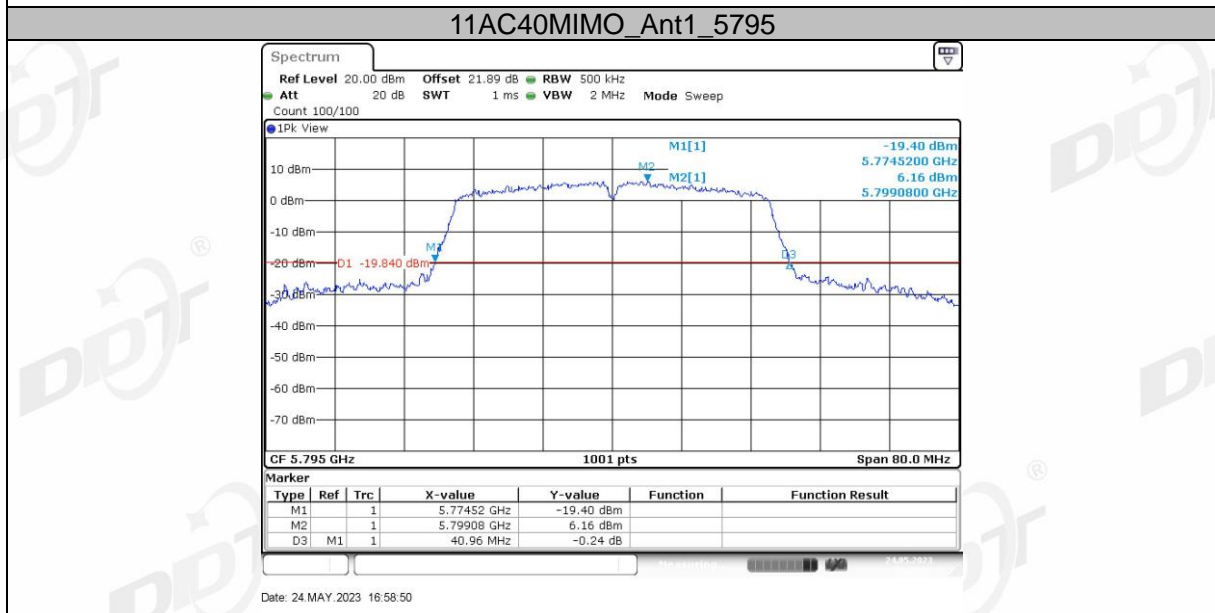
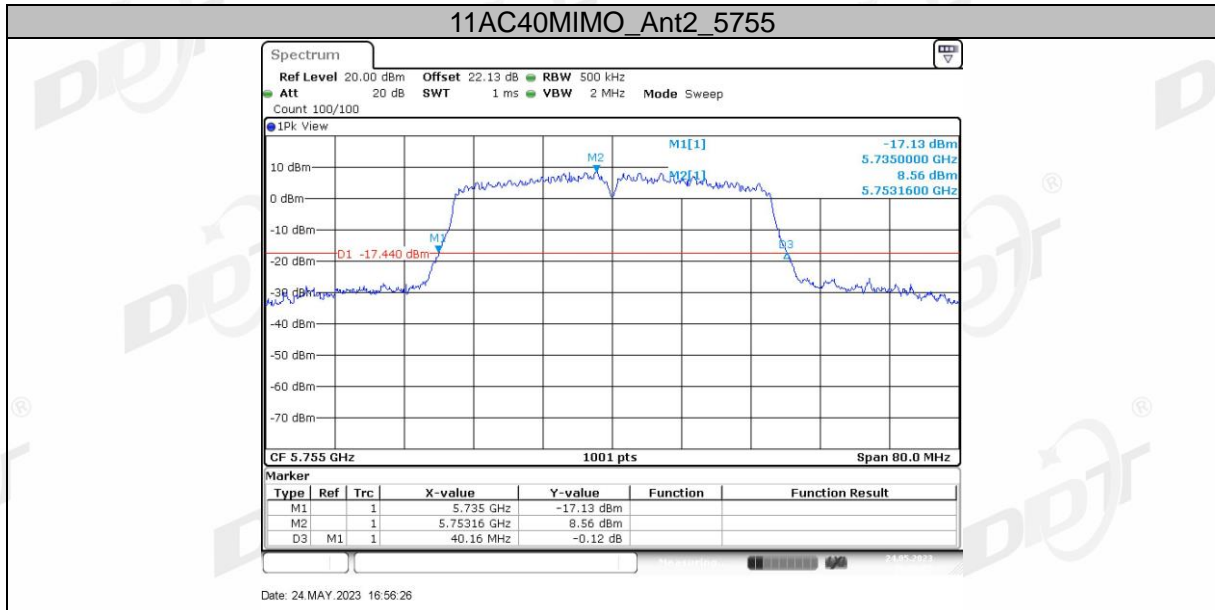

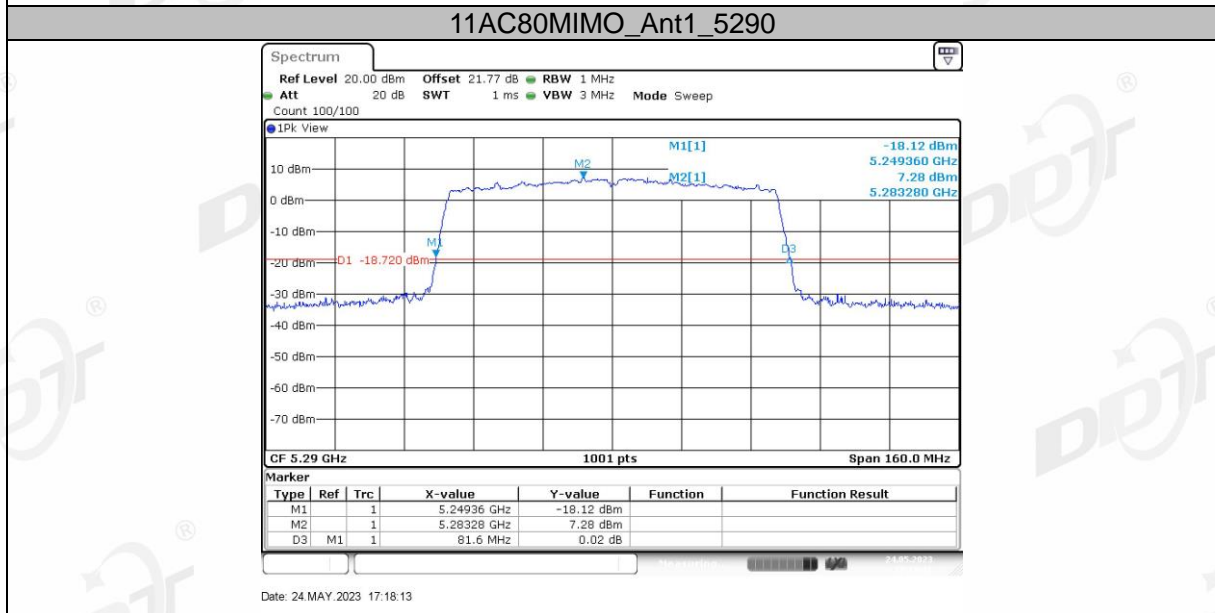
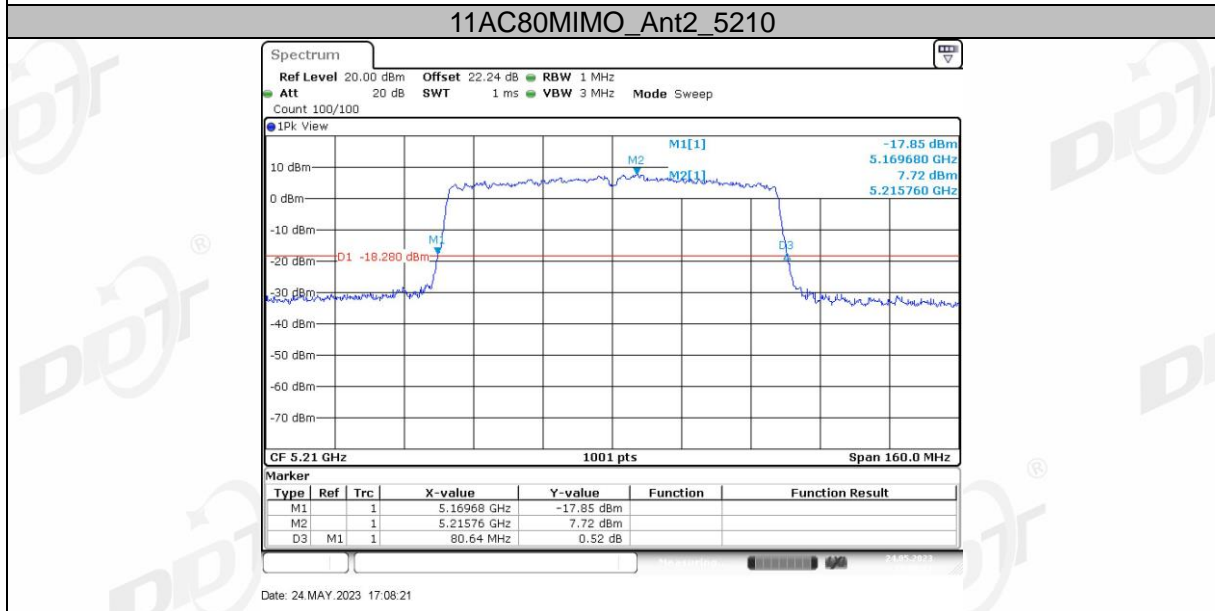
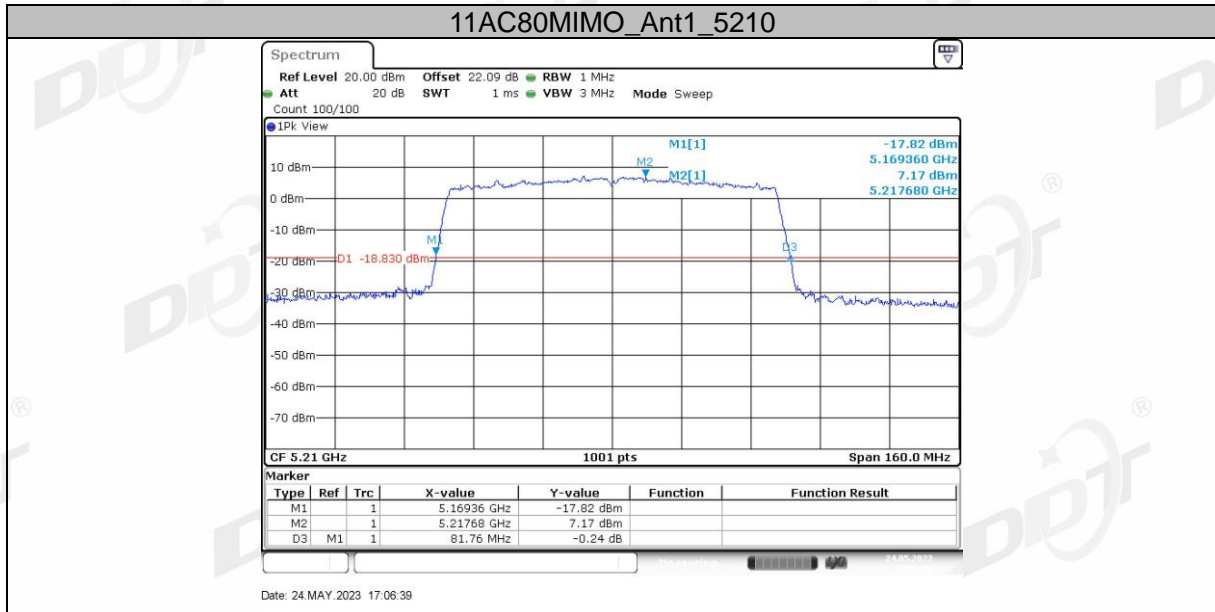

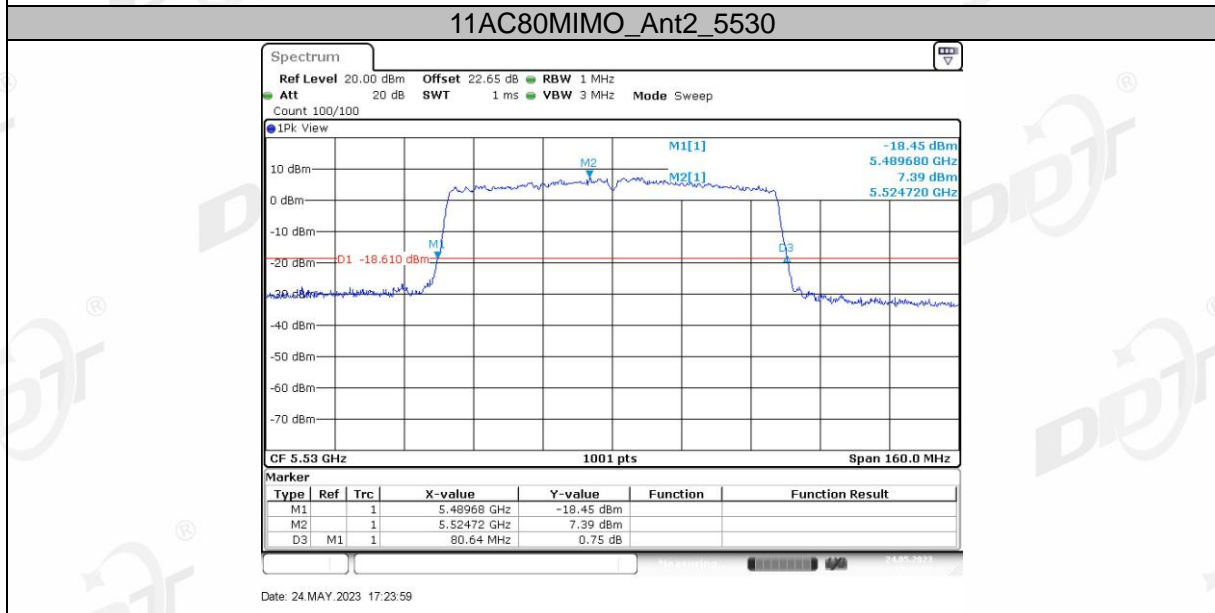
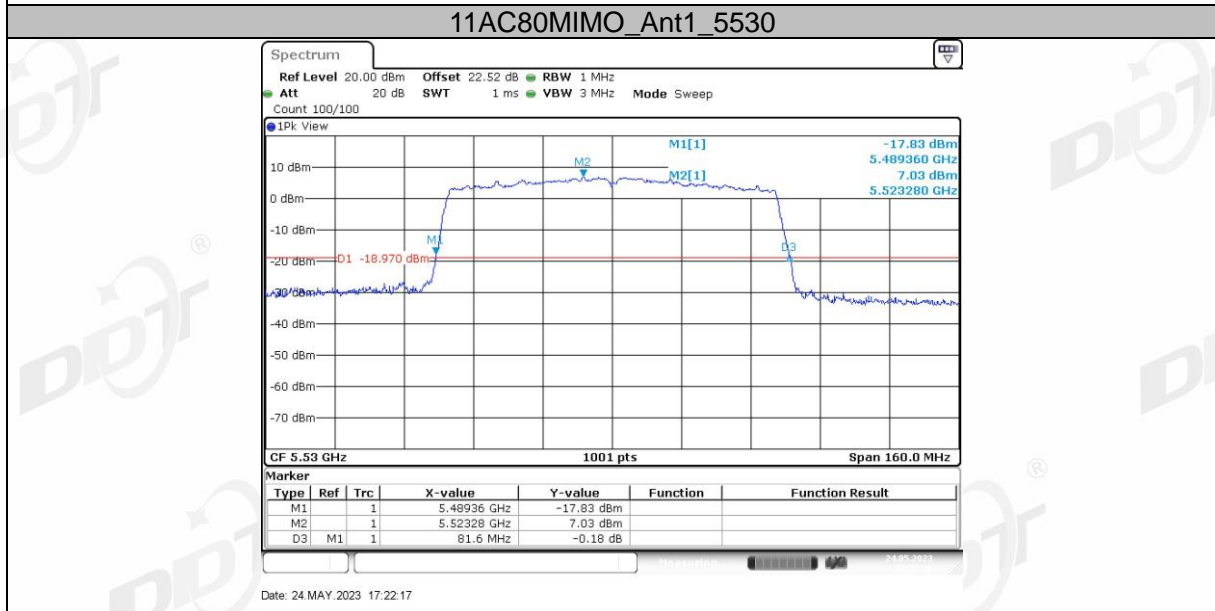
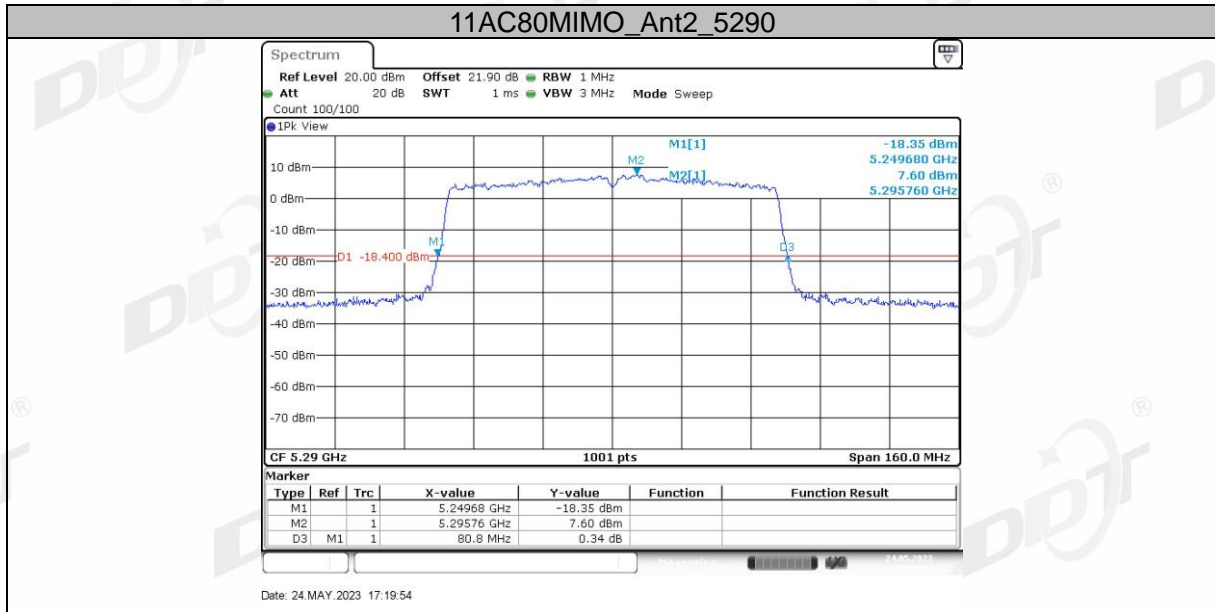

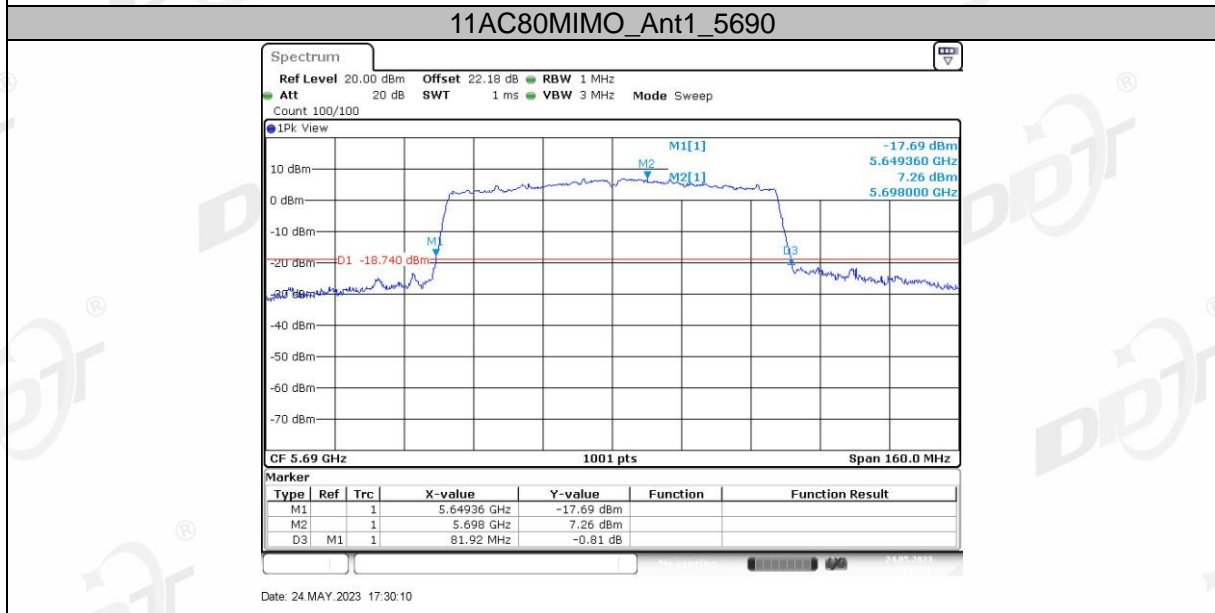
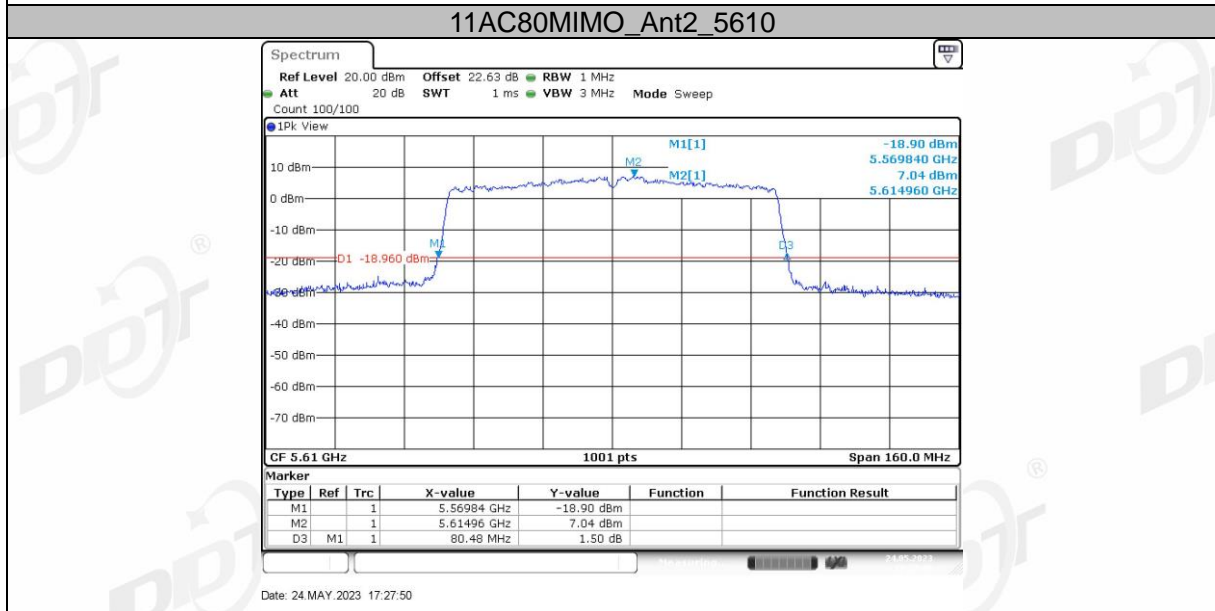
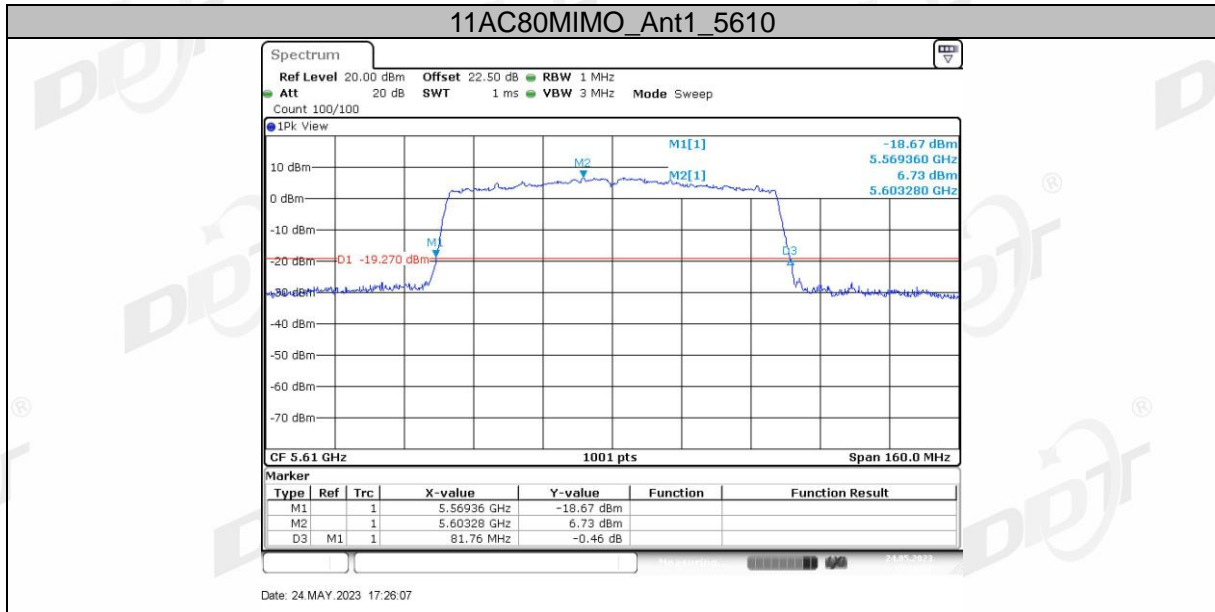

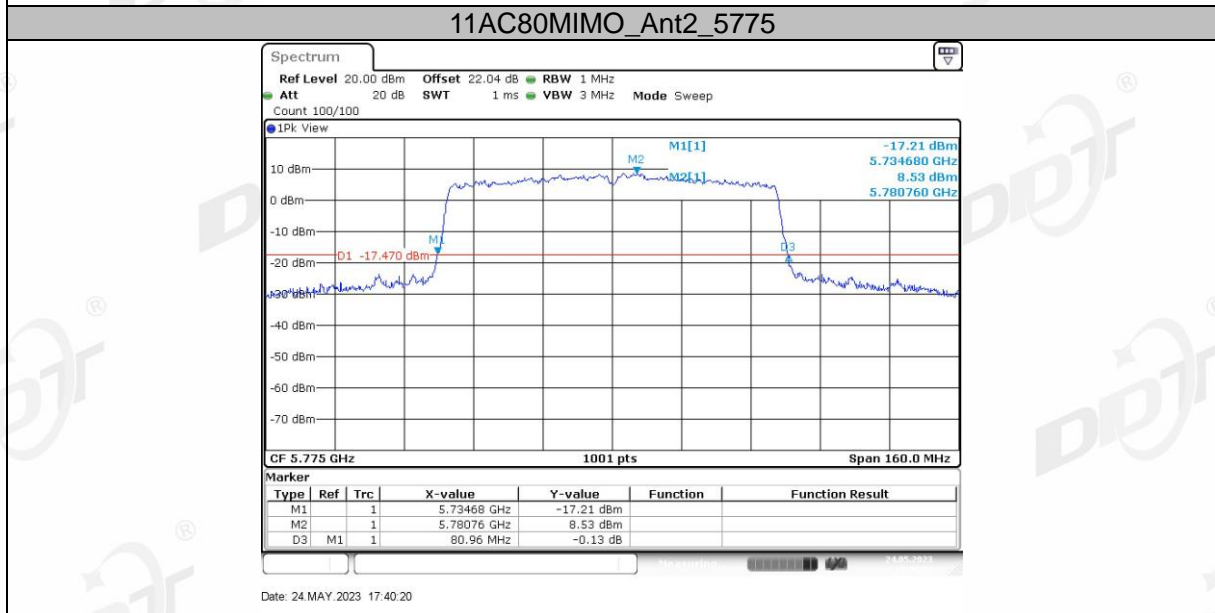
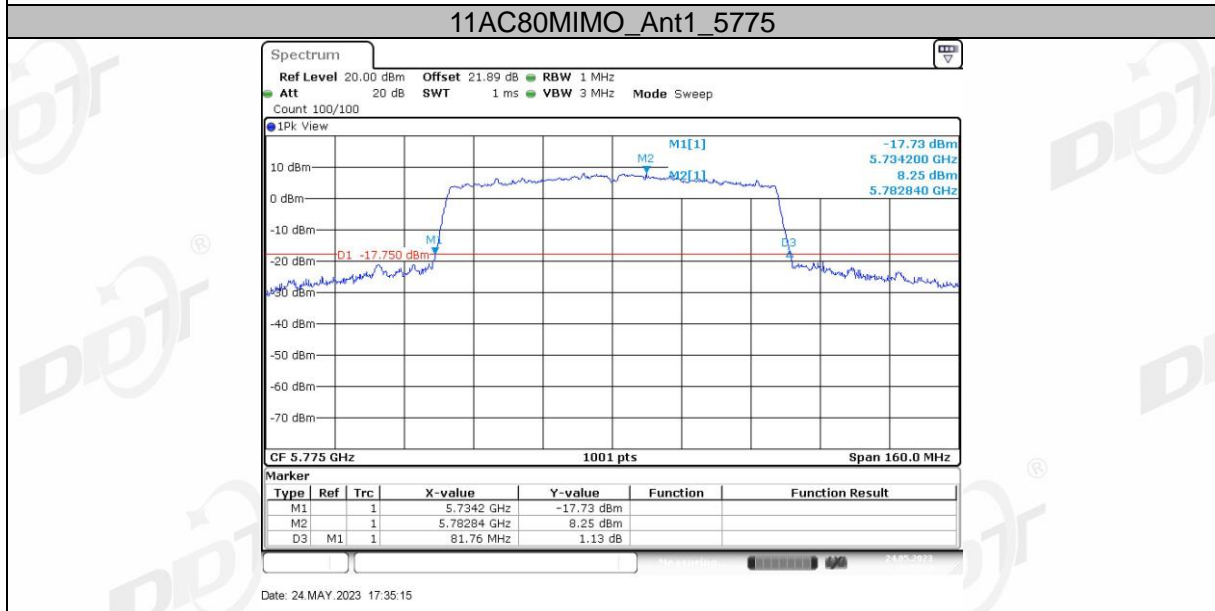
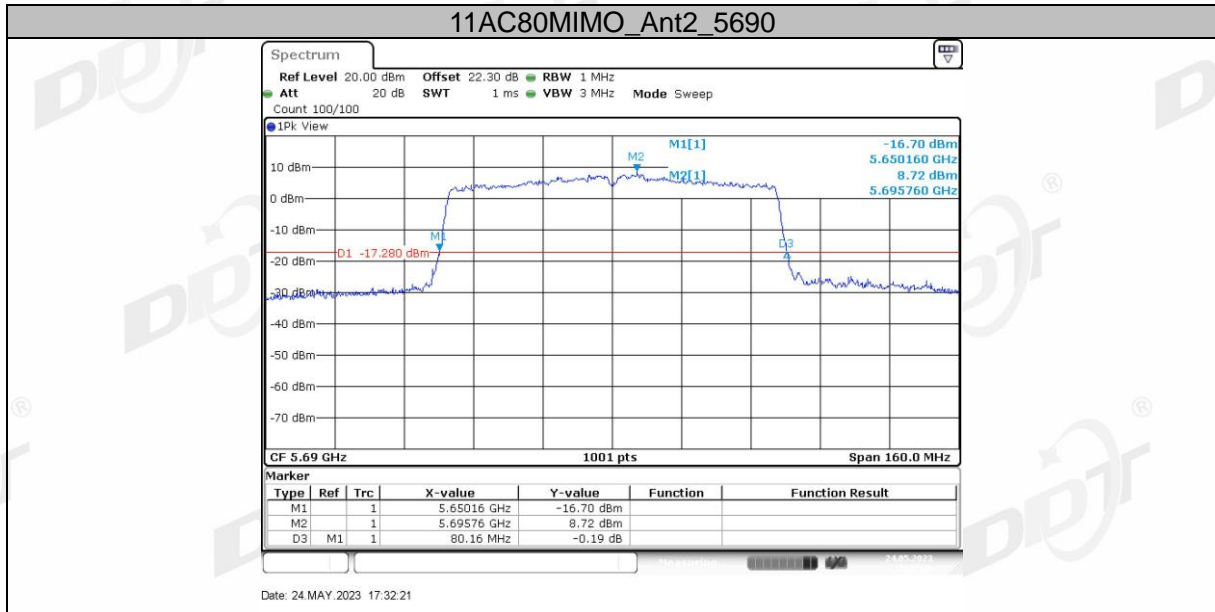

5. 6dB Bandwidth

5.1. Block diagram of test setup

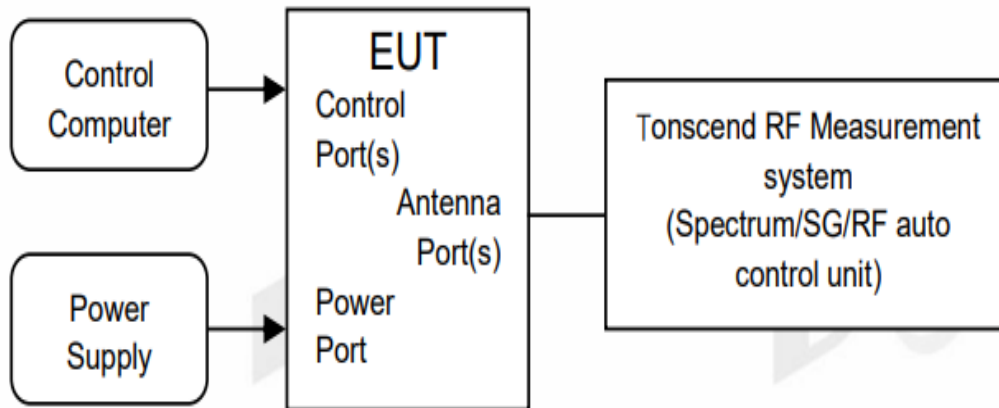

5.2. Limits

FCC Part15, Subpart E/ RSS-247		
Test Item	Limit	Frequency Range (MHz)
6 dB Bandwidth	Minimum 500 kHz	5725 - 5850

5.3. Test procedure

Connect EUT's antenna output to spectrum analyzer by RF cable.

Center Frequency	The center frequency of the channel under test
Detector	Peak
RBW	For 6 dB Bandwidth: RBW=100 kHz For 26 dB Bandwidth: approximately 1% of the emission bandwidth.
VBW	For 6 dB Bandwidth: VBW=300 kHz For 26 dB Bandwidth: >3 RBW
Trace	Max hold
Sweep	Auto couple

Allow the trace to stabilize, measure the maximum width of the emission that is constrained by the frequencies associated with the two outermost amplitude points (upper and lower frequencies) that are attenuated by 6 dB relative to the maximum level measured in the fundamental emission.

5.4. Test result

Test Mode	Antenna	Frequency [MHz]	6db EBW [MHz]	FL [MHz]	FH [MHz]	Limit [MHz]	Verdict
11A	Ant1	5745	15.16	5737.40	5752.56	0.5	PASS
	Ant2	5745	15.16	5737.40	5752.56	0.5	PASS
	Ant1	5785	15.12	5777.44	5792.56	0.5	PASS
	Ant2	5785	15.04	5777.48	5792.52	0.5	PASS
	Ant1	5825	15.12	5817.44	5832.56	0.5	PASS
	Ant2	5825	15.12	5817.44	5832.56	0.5	PASS
11N20MIMO	Ant1	5745	15.16	5737.40	5752.56	0.5	PASS
	Ant2	5745	15.16	5737.40	5752.56	0.5	PASS
	Ant1	5785	15.12	5777.44	5792.56	0.5	PASS
	Ant2	5785	15.12	5777.44	5792.56	0.5	PASS
	Ant1	5825	15.12	5817.44	5832.56	0.5	PASS
	Ant2	5825	15.72	5816.84	5832.56	0.5	PASS
11N40MIMO	Ant1	5755	35.12	5737.40	5772.52	0.5	PASS
	Ant2	5755	35.04	5737.48	5772.52	0.5	PASS
	Ant1	5795	35.12	5777.48	5812.60	0.5	PASS
	Ant2	5795	35.12	5777.48	5812.60	0.5	PASS
11AC20MIMO	Ant1	5745	15.16	5737.40	5752.56	0.5	PASS
	Ant2	5745	15.72	5736.84	5752.56	0.5	PASS
	Ant1	5785	15.12	5777.44	5792.56	0.5	PASS
	Ant2	5785	15.68	5776.88	5792.56	0.5	PASS
	Ant1	5825	15.12	5817.44	5832.56	0.5	PASS
	Ant2	5825	15.72	5816.84	5832.56	0.5	PASS
11AC40MIMO	Ant1	5755	35.04	5737.48	5772.52	0.5	PASS
	Ant2	5755	35.04	5737.48	5772.52	0.5	PASS
	Ant1	5795	35.12	5777.48	5812.60	0.5	PASS
	Ant2	5795	35.12	5777.48	5812.60	0.5	PASS
11AC80MIMO	Ant1	5775	75.20	5737.40	5812.60	0.5	PASS
	Ant2	5775	75.20	5737.40	5812.60	0.5	PASS