



Xming Episode One Smart Projector

小明智能投影機

User Manual

XMM2102

Xming Episode One Smart Projector User Manual	1
Xming Episode One Smart Projector 使用说明书	19

What's in the box

When opening the packaging, check the contents of the box against the list below. If there is anything missing, please contact the seller in due time.



Smart Projector

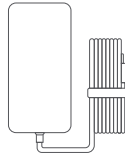

Adapter



Power Cord



Remote Control



User Manual



Warranty Card

 Note:

- The actual contents may vary depending on the country (or region) of sale, please refer to the actual product.
- Retain the original packaging for future storage or transportation.

Getting Started

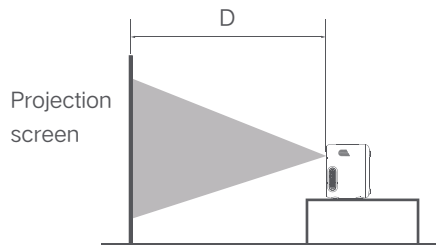
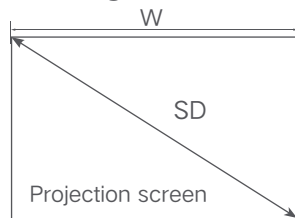

Determine the distance between the projector and the wall or screen according to the desired screen size.

Screen Dimensions (SD)	Relative Distance (D)	Picture width (W)
40"	106	88
60"	159	132
80"	212	177
100"	265	221
120"	318	265

Screen Dimensions (SD): The diagonal size of the projection screen (in inches).

Relative Distance (D): The distance between the projector and the wall or screen (in cm).

Picture width (W): The width of the screen projected by the projector onto the wall (in cm).

 Note:

The dimensions in the table above are for reference only, they are approximate and may slightly differ from the actual values.

Power up

Connect your power cable to the projector, then plug it in to the wall outlet.
Power your projector remote by inserting the appropriate batteries.
(batteries not included)

Connect other devices by referencing port label and descriptions on the next page.

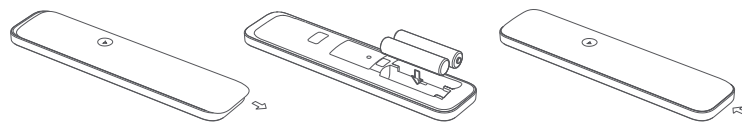

Step 1. Push the back cover in the direction of the arrow, and after hearing a sound, the back cover will separate from the remote control.

Step 2. Remove the back cover, then take out the battery.













Step 3. Install the battery, then put the back cover onto the remote control and push it firmly in the direction of the arrow until it clicks into place. Once you hear a sound, it indicates that it has been installed properly.

Note:

- Pay attention to the positive and negative poles when installing batteries in the remote control.
- When battery leaks, immediately wipe away any fluid with a dry cloth and replace the batteries with new ones.
- Dispose of used batteries according to local waste disposal rules and regulations of the country or area you live in.

Grab your remote RC605D



-  POWER: Turn Projector on and off
-  PROFILE SELECTOR :
Switch between different Google Accounts
-  SETTINGS: Access the settings
-  GOOGLE ASSISTANT:
Ask Google Assistant to find movies, stream apps, play music, and control the TV - all with your voice.
-  NAVIGATION PAD:
Move up, down, left, or right, then press the middle button to confirm
-  BACK: Return to previous screen
-  HOME: Return to home screen
-  Referring to the instructions below
 1. If Live Tab is supported in country then launch Live Tab*.
 2. If device supports tuner then launch deep link to OEM app.
-  Volume Button:
 -  + Increase the volume
 -  - Decrease the volume
-  Netflix: Access the Netflix App
-  YouTube: Access the YouTube App

* US Only.

* Some apps, content, and/or features may not be available in all countries. Subject to availability.

Product Overview

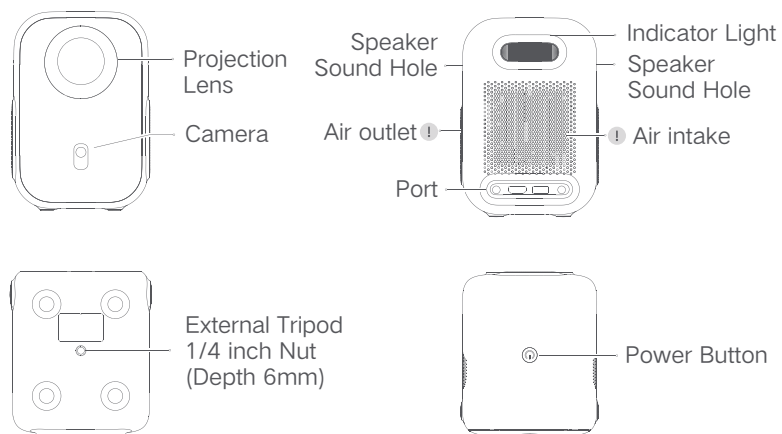

CAUTION:

- Do not place objects within 20cm near the heat dissipation vents.
- Do not place any objects near the vents, as this may cause heat to build up inside the projector.
- Do not look directly into the lens so as to avoid eye damage as this projector emits strong light during use.

Connection Ports

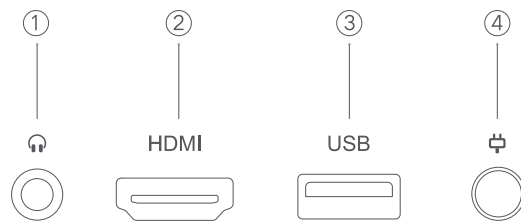

- ① Line Out:
Connect an analog cable to an external analog audio system.
- ② HDMI:
Highest quality audio/video connection. Connect cable box, Blu-ray player, gaming console, or other devices to your projector using HDMI cables.
- ③ USB:
Connect a USB device to access photos, music and movies.
- ④ DC:
Connect your projector to the power source with the included power cable.

Power Indicator

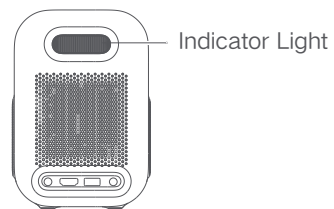

Press the power button on the body and the power button on the remote control to turn it on and off.

The power indicator (a soft white light) to the corresponding projector's status is as follows:

- During the startup process, the indicator light is always on and then blinks breathingly, and then goes out after entering the main interface of the system.
- After entering the system, the indicator light is always off.
- After entering the shutdown screen, the indicator light is always on.
- When the system is in standby, the indicator light is off.
- The breathing light is always on during the shutdown process, and the breathing light is off after the shutdown.

Keystones & Focus

1. Move the projector, the screen will be omni-directional automatic correction and auto-focus.
2. Open the settings menu, find Projector in Settings, here you can choose Keystone Correction or Focus to realize the function.

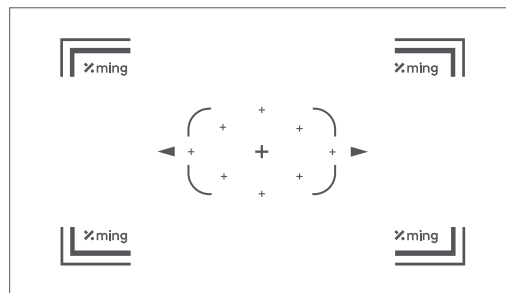

Hoisting instructions

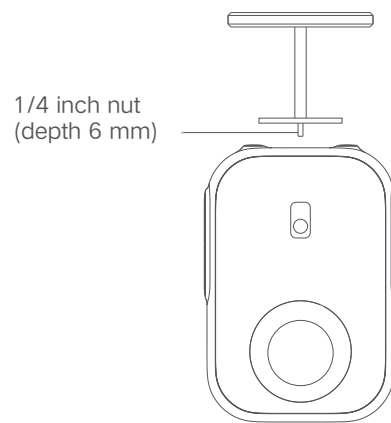

 Note:

- For hoisting, please use screws of specified specifications and select a suitable bracket.

Specifications

Basic Information	Name	Xming Episode One Smart Projector
	Model	XMM2102
	Item Dimensions	122*141*175mm
	Input	1.25 kg
Electrical Specifications	Total Power	≤65W
	Standby Power	< 0.5W
	Input	DC19V \pm 3.42A
Optical Parameters	Resolution	1920*1080
	Ratio	1.2 : 1
	Ratio	40~120"
	Focus	Auto Focus
System	Keystone Correction	Omni-directional auto-keystone correction
	Storage	2G DDR/16G eMMC
	System	Android TV™ OS
	Bluetooth	BT 5.0
Audio	Wireless	Wi-Fi IEEE 802.11 a/b/g/n/ac 2.4GHz/5GHz
	Audio Effects	Dolby Audio
	Speaker	2 × 3W Full-range

Others	Noise	≤30dB ambient temperature ≤30 ° C, 1m distance
		≤34dB ambient temperature > 30 ° C, 1m distance
	Storage Temperature/ Humidity	-20 °C to 55 °C / ≤ 90%
	Operating Temperature/ Humidity	0 °C to 40 °C / 20% – 80%

Troubleshooting

Fault	Solution
No projected image	Turn off the projector and disconnect from the power, then plug in the power cord and turn on the projector.
Operating system crashes	Turn off the projector and disconnect from the power, then plug in the power cord and turn on the projector.
Screen display error	Turn off the projector and disconnect from the power, then plug in the power cord and turn on the projector.

Fault	Solution
Remote control is missing or not paired and the projector cannot be turned on remotely.	Turn off the projector and disconnect from the power. Wait for five minutes, then plug in the power cord and turn on the projector. After the projector has been restarted, pair the remote control again.
If the projector overheats, it will automatically turn off.	Please remove any obstacles from the air inlets and outlets so as to ensure a smooth airflow through the projector. Follow the instructions above to restart the projector.
Other Internal System Errors	Please contact a qualified technician to service the device, or return the projector to the after-sales department.

Regulatory Compliance



Hereby, [Formovie (Chongqing) Innovative Technology Co., Ltd.] declares that the radio equipment type [LCD Smart Projector / XMM2102] is in compliance with Directive 2014 / 53 / EU and Radio Equipment Regulations 2017. The full text of the declaration of conformity is available at the following internet address:
<http://www.formovie.com/global/service/support/declaration.html>

This device is restricted to indoor use when operating in the 5150 to 5350 MHz frequency range.

BT maximum transmitter power: 100mW at 2.4GHz - 2.4835GHz
Wi-Fi 2.4G maximum transmitter power: 100mW at 2.4GHz - 2.4835GHz
Wi-Fi 5G maximum transmitter power: 200mW at 5.15GHz - 5.25GHz, 100mW at 5.25GHz - 5.35GHz & 5.47GHz - 5.725GHz



All products bearing this symbol are waste electrical and electronic equipment (WEEE as in directive 2012/19/EU) which should not be mixed with unsorted household waste. Instead, you should protect human health and the environment by handing over your waste equipment to a designated collection point for the recycling of waste electrical and electronic equipment, appointed by the government or local authorities. Correct disposal and recycling will help prevent potential negative consequences to the environment and human health. Please contact the installer or local authorities for more information about the location as well as terms and conditions of such collection points.



Correct disposal of the batteries in this product (Applicable in countries with separate collection systems) This marking on battery, manual or packaging indicates that the batteries in this product should not be disposed of with other household waste at the end of their working life. Where marked, the chemical symbols Hg, Cd or Pb indicate that the battery contains mercury, cadmium or lead above the reference levels in EC Directive 2006/66. If batteries are not properly disposed of, these substances can cause harm to human health or the environment. To protect natural resources and to promote material reuse, please separate batteries from other types of waste and recycle them through your local, free battery return system.



This device complies with part 15 of the FCC Rules. Operation is subject to the following two conditions: (1) This device may not cause harmful interference, and (2) this device must accept any interference received, including interference that may cause undesired operation.

Note: This equipment has been tested and found to comply with the limits for a Class B digital device, pursuant to part 15 of the FCC rules. These limits are designed to provide reasonable protection against harmful interference in a residential installation. This equipment generates, uses and can radiate radio frequency energy and, if not installed and used in accordance with the instructions, may cause harmful interference to radio communications. However, there is no guarantee that interference will not occur in a particular installation. If this equipment does cause harmful interference to radio or television reception, which can be determined by turning the equipment off and on, the user is encouraged to try to correct the interference by one or more of the following measures:

- Reorient or relocate the receiving antenna.
- Increase the separation between the equipment and receiver.
- Connect the equipment into an outlet on a circuit different from that to which the receiver is connected.
- Consult the dealer or an experienced radio/TV technician for help.

Important: You are cautioned that changes or modifications not expressly approved by the party responsible for compliance could void the user's authority to operate the equipment.

RF Exposure Information: The radiated output power of this device meets the limits of FCC/IC radio frequency exposure limits. This device should be operated with a minimum separation distance of 20cm (8 inches) between the equipment and a person's body.

RF warning for Portable device: The device has been evaluated to meet general RF exposure requirement. The device can be used in portable exposure condition without restriction.

Canada regulatory compliance

This device complies with Innovation, Science and Economic Development Canada license-exempt RSS standard(s). Operation is subject to the following two conditions: (1) this device may not cause interference, and (2) this device must accept any interference, including interference that may cause undesired operation of the device.

Operation in the band 5150–5250 MHz is only for indoor use to reduce the potential for harmful interference to co-channel mobile satellite systems.

Exposure to radio frequency energy

The radiated output power of this device meets the limits of FCC/IC radio frequency exposure limits. This device should be operated with a minimum separation distance of 20 cm (8 inches) between the equipment and a person's body.

RF warning for Portable device: The device has been evaluated to meet general RF exposure requirement. The device can be used in portable exposure condition without restriction.

CAN ICES-003 (B)/NMB-003(B)

Le présent appareil est conforme aux CNR d'Innovation, Sciences et Développement économique Canada applicables aux appareils radio exempts de licence. L'exploitation est autorisée aux deux conditions suivantes : (1) l'appareil ne doit pas produire de brouillage, et (2) l'utilisateur de l'appareil doit accepter tout brouillage radioélectrique subi, même si le brouillage est susceptible d'en compromettre le fonctionnement.

La bande 5150–5250 MHz est réservée uniquement pour une utilisation à l'intérieur afin de réduire les risques de brouillage préjudiciable aux systèmes de satellites mobiles utilisant les mêmes canaux.

L'exposition à l'énergie radiofréquence

La puissance de sortie rayonné de cet appareil est conforme aux limites de la FCC/IC limites d'exposition aux fréquences radio. Cet appareil doit être utilisé avec une distance minimale de séparation de 20 cm entre l'appareil et le corps d'une personne.

Avertissement RF pour un appareil portable:L'appareil a été évalué et répond aux exigences générales d'exposition aux RF. L'appareil peut être utilisé dans des conditions d'exposition portables sans restriction.

CAN ICES-003 (B)/NMB-003(B)

**CAUTION:**

- Risk of explosion if the battery is replaced by an incorrect type.
- Disposal of a battery into fire or a hot oven, or mechanically crushing or cutting of a battery, that can result in an explosion.
- Leaving a battery in an extremely high temperature surrounding environment that can result in an explosion or the leakage of flammable liquid or gas.
- A battery subjected to extremely low air pressure that may result in an explosion or the leakage of flammable liquid or gas.

Product Certifications



Manufactured under license from Dolby Laboratories. Dolby, Dolby Audio, and the double-D symbol are trademarks of Dolby Laboratories Licensing Corporation.



The terms HDMI, HDMI High-Definition Multimedia Interface, and the HDMI Logo are trademarks or registered trademarks of HDMI Licensing Administrator, Inc.



Google TV is the name of this device's software experience and a trademark of Google LLC. Google, YouTube and Android TV are trademarks of Google LLC.

Google Assistant is not available in all languages and countries. Availability of services varies by country and language.

The product marking and safety information are located at the bottom of the product.

盒子裡包含

打開包裝時，請對照下面列表檢查包裝內的物品，如有遺漏，請與賣家聯繫。



智能投影儀

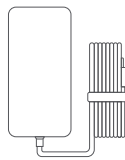

適配器



電源線



遙控器



用戶手冊

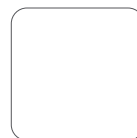

保修卡

 注意：

- 實際內容可能因銷售國家（或地區）而異，請以實際產品為準。
- 保留原包裝以備將來儲存或運輸。

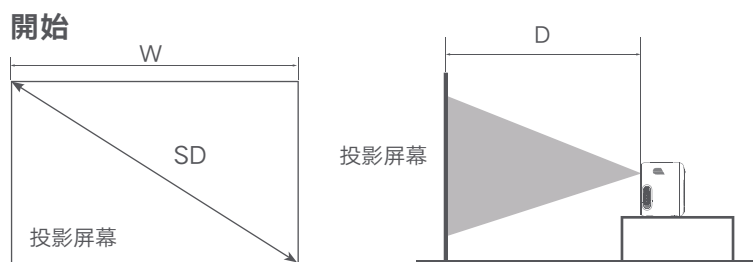

根據所需的屏幕尺寸確定投影儀與牆壁或屏幕之間的距離

尺寸 (SD)	相對距離 (D)	畫面寬度 (W)
40"	106	88
60"	159	132
80"	212	177
100"	265	221
120"	318	265

屏幕尺寸 (SD)：投影屏幕的對角線尺寸 (單位為英寸)

相對距離 (D)：投影儀與牆壁或屏幕之間的距離 (單位為厘米)

畫面寬度 (W)：投影儀投影到牆面的畫面寬度尺寸 (單位為厘米)

 注意：

上表的尺寸僅供參考，它們是近似值，可能與實際值略有不同

启动

將電源線連接到投影儀上，然後將其插入牆上的插座。
插入合適的電池為投影儀遙控器供電（不含電池）。
請參照端口標籤和下一頁的描述連接其他設備。

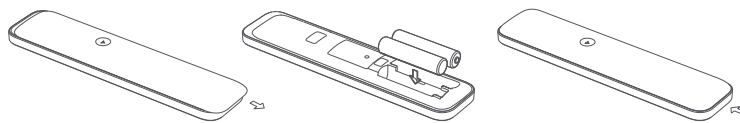

步驟一：朝箭頭方向推動後蓋，然後聽到扣位脫離聲音後，後蓋就會跟遙控器分開

步驟二：拿開後蓋，並取出電池。











步驟三：裝入電池，然後把後蓋放到遙控器上，朝箭頭方向推到底。一旦你聽到扣位扣合聲音後，說明後蓋安裝到位了。

⚠ 注意：

- 安裝遙控器電池時注意正極和負極。
- 當電池漏液時，請立即用乾布擦乾，然後更換新電池。
- 根據您所在國家或地區的當地廢物處理規則和規定處理廢舊電池。

遙控器 RC605D



-  電源:打開和關閉投影儀
-  配置文件選擇器:在不同的谷歌賬戶之間切換
-  設置:進入設置界面
-  Google 助理:
你可以通過語音詢問Google助理來搜索電影、流媒體應用、播放音樂和控制電視。
-  導航面板:
向上、向下、向左或者向右移動,然後按中鍵確認
-  返回:返回到上一個界面
-  主界面:返回主界面
-  使用說明如下:
 - 1.如果該國支持“LiveTab”,則啓動“Live Tab*”。
 - 2.如果設備支持調諧器,則啓動OEM應用程序的深度鏈接。
-  音量按鈕:
 - 增加音量
 - 減小音量
-  Netflix:訪問Netflix應用程序
-  YouTube:訪問YouTube應用程序

*僅適用於美國。

*某些應用程序、內容和/或功能可能在所有國家/地區不可用。視當地情況而定。

產品概述

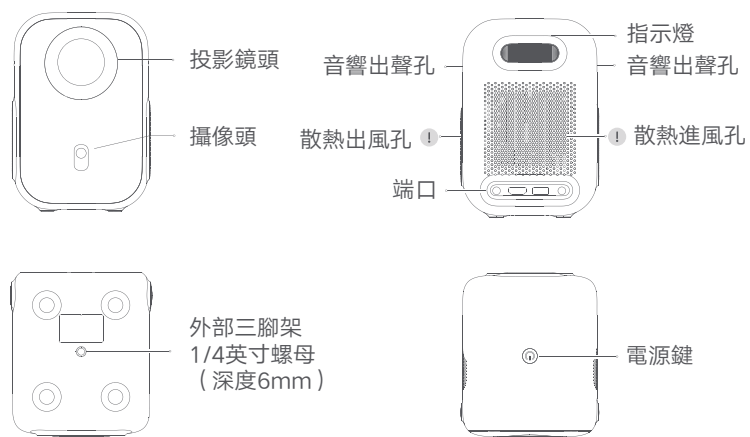

⚠ 警告:

- 散熱口附近20cm範圍內禁止放置物體。
- 不要在通風口附近放置任何物體，因為這可能會導致投影儀內部積聚熱量。
- 投影儀在使用過程中會發出強光，請勿直視鏡頭，以免傷害眼睛。

連接端口

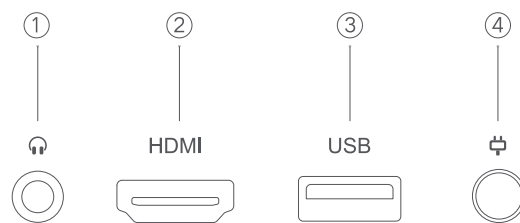

- ① 耳機：
模擬線纜連接到外部的模擬音頻系統。
- ② HDMI：
最高質量的音頻/視頻連接，使用HDMI線將有線電視盒、藍光播放器、遊戲機或者其他設備連接到投影儀
- ③ USB：
連接USB設備訪問照片、音樂和電影。
- ④ 電源：
用隨附的電源線將投影儀連接到電源上。

電源指示燈

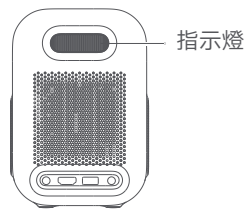

按下機身上的電源按鈕和遙控器上的電源按鈕來打開和關閉它。

對應投影儀狀態的電源指示燈(白色燈)如下：

- 開機過程中指示燈一直亮，然後呼吸式閃爍，進入系統主界面後熄滅。
- 進入系統後，指示燈一直不亮。進入關機畫面後，指示燈一直亮。
- 系統處於待機狀態時，指示燈不亮。
- 關機過程中呼吸燈一直亮，關機後呼吸燈不亮。

畫面校正與對焦

1. 移動投影儀，螢幕會進行全方位的自動校正和自動對焦。
2. 打開設置菜單，找到投影儀選項，在這裡你可以選擇梯形校正或對焦來實現功能。

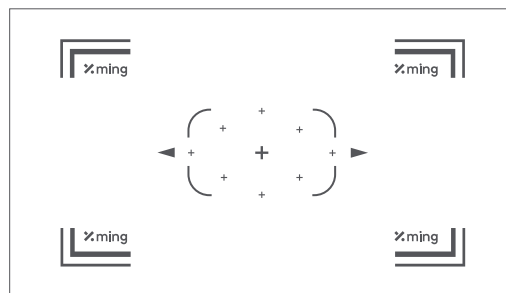

吊裝指引

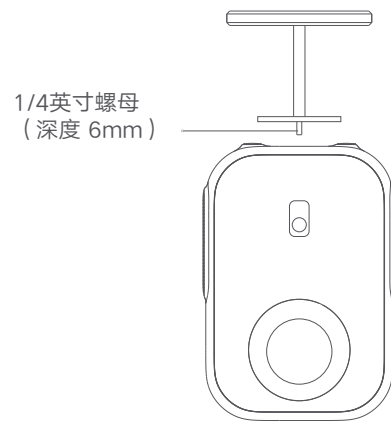

 注意：

- 吊裝時，請使用規定規格的螺釘，並選擇合適的支架。

支持解析度

支持解析度					
	1080p	1080i	720p	576p	576i
HDMI1.4	支持	支持	支持	支持	支持
HDMI2.0	支持	支持	支持	支持	支持
HDMI2.1	支持	支持	支持	支持	支持
輸入幀數24Hz,30Hz,50Hz,60Hz皆通過測試					

產品規格

基本資訊	產品名稱	小明智能投影機
	產品型號	XMM2102
	產品尺寸	141*122*175 mm
	產品淨重	1.25 kg
電氣規格	功率	整機 ≤65 W; 待機功率 <0.5 W
	電源輸入	DC19V --- 3.42A
投影參數	標準解析度	1920*1080
	投射比	1.2 : 1
	畫面尺寸	40~120"
	鏡頭對焦	自動對焦
	梯形校正	全向自動梯形校正
系統	內建儲存	2G DDR/16G eMMC
	作業系統	Android TV™ OS
	藍牙	藍牙 5.0
	無線連接	Wi-Fi IEEE 802.11 a/b/g/n/ac 2.4GHz/5GHz
聲音	音效	Dolby Audio
	喇叭	2 × 3 W 全頻
其他	噪音	≤ 30dB 觀影模式 @ 環溫 25°C
		≤ 33dB 觀影模式 @ 環溫 30°C
	儲存溫度/ 濕度	-20 °C to 55 °C / ≤ 90%
工作溫度/ 濕度	0 °C to 40 °C / 20% - 80%	

故障排除

問題	解決方案
沒有投影圖像	關閉投影機並斷開電源，然後插入電源線並打開投影機
操作系統崩潰	關閉投影機並斷開電源，然後插入電源線並打開投影機
屏幕顯示錯誤	關閉投影機並斷開電源，然後插入電源線並打開投影機
遙控器丟失或未配對， 投影儀無法遠程打開	關閉投影機並斷開電源。 等待五分鐘，然後插上電源線，打開投影儀。 投影儀重新啟動後，重新配對遙控器。
如果投影儀過熱， 它會自動關閉	請清除出風口上的障礙物，確保投影機氣流暢通。 按照上面的說明重新啟動投影儀
其他系統內部錯誤	請聯繫有資質的技術人員對設備進行維修， 或將投影機退回售後部門

產品有毒有害的名稱及含量

設備名稱：小明智能投影機，型號：XMM2102						
單元	限用物質及其化學符號					
	鉛 (Pb)	汞 (Hg)	鎘 (Cd)	六價鉻 (Cr)	多溴聯苯 (PBB)	多溴二苯醚 (PBDE)
電源線元件 / 電源適配器	-	○	○	○	○	○
內部線材	○	○	○	○	○	○
塑膠外殼	○	○	○	○	○	○
光機組件	-	○	○	○	○	○
風扇組件	-	○	○	○	○	○
揚聲器	-	○	○	○	○	○
天線元件	○	○	○	○	○	○
PCB 板組件	-	○	○	○	○	○
遙控器	-	○	○	○	○	○
其他金屬件	-	○	○	○	○	○

備考 1. “超出 0.1wt%”及“超出 0.01wt%”系指限用物質之百分比含量超出百分比含量基準值。
備考 2. “○”系指該項限用物質之百分比含量未超出百分比含量基準值。
備考 3. “-”系指該項限用物質為排除項目。

法規遵循



廢電池請回收
警告：請勿戳刺或焚燒。此電池不含汞。

廢電池請回收

低功率射頻器材警語：

取得審驗證明之低功率射頻器材，非經核准，公司、商號或使用者均不得擅自變更頻率、加大功率或變更原設計之特性及功能。低功率射頻器材之使用不得影響飛航安全及干擾合法通信；經發現有干擾現象時，應立即停用，並改善至無干擾時方得繼續使用。前述合法通信，指依電信管理法規定作業之無線電通信。低功率射頻器材須忍受合法通信或工業、科學及醫療用電波輻射性電機設備之干擾。

在正常使用條件下，本裝置的天線與使用者身體之間應保持至少 20cm 的間隔。

應避免影響附近雷達系統之操作 高增益指向性天線只得應用於固定式點對點系統。

注意：

- 若替換的電池類型不正確，則存在爆炸的風險。
- 將電池扔入火中或熱烤爐中或採用機械方式擠壓或切割電池，可能會導致爆炸。
- 將電池放在極度高溫環境下可能導致爆炸或者易燃液體或氣體的泄漏。
- 電池承受極度低壓可能導致爆炸或者易燃液體或氣體的泄漏。

產品認證



依照 Dolby Laboratories 授權製造。
Dolby、Dolby Audio 和雙 D 標誌是
Dolby Laboratories Licensing
Corporation 的註冊商標。



HDMI、HDMI High-Definition Multimedia
Interface 和 HDMI 標誌是 HDMI Licensing
Administrator, Inc. 的商標或註冊商標。



Google TV 是這部裝置軟體服務的名稱,也是 Google LLC 的商標。
「Google」、「YouTube」和「Android TV」是 Google LLC 的商標。

Google 助理目前僅支援部分國家/地區和語言。
提供的服務會因國家/地區和語言而有所不同。

產品標記和狀態資訊位於產品的底部

Manufacturer:

Formovie (Chongqing) Innovative Technology Co., Ltd.

Address:

4-401, # 2 Longgang Road, Guojiatuo Area, Jiangbei District,
Chongqing, China

製造商:

峰米（重慶）創新科技有限公司

地址:

中國重慶市江北區郭家沱街道隆港路2號4層401室

www.formovie.com

印刷说明

- 成品尺寸: 120mm*120mm , R=10mm, 尺寸公差±0.2mm。
- 材质: 105g哑粉。
- 印刷颜色: PANTONE Grey 700
- 装订方式: 骑马钉
- 材料符合RoHS, REACH及POPS环保要求。
- 封底白边公差: -0.5mm~+0.5mm。

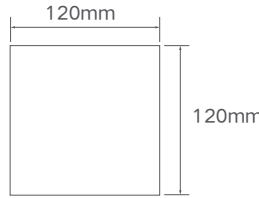

版本变更

版本	说明	日期
A	新版发行	2024.01.02
B		
C		
D		
E		