

# TEST REPORT

**Product Name** : Smart Projector  
**Model Number** : M135FGE-Pro, M135\*\*\*\*\*, "\*" can be replaced by 0-9, A-Z, - or blank, indicates for different market purposes  
**FCC ID** : 2AZNP-M135FGE-PRO

**Prepared for Address** : Formovie (Chongqing) Innovative Technology Co., Ltd.  
4-401, #2 Longgang Road, Guojiatuo Area, Jiangbei District, Chongqing, China

**Prepared by Address** : EMTEK (SHENZHEN) CO., LTD.  
Building 69, Majialong Industry Zone, Nanshan District, Shenzhen, Guangdong, China

Tel: (0755) 26954280  
Fax: (0755) 26954282

**Report Number** : ENS2107280006W00403R  
**Date(s) of Tests** : Jul 28, 2021 to Aug 27, 2021  
**Date of issue** : Aug 27, 2021

### TEST RESULT CERTIFICATION

Applicant : Formovie (Chongqing) Innovative Technology Co., Ltd.  
 Address : 4-401, #2 Longgang Road, Guojiatuo Area, Jiangbei District, Chongqing, China  
 Manufacturer : Formovie (Chongqing) Innovative Technology Co., Ltd.  
 Address : 4-401, #2 Longgang Road, Guojiatuo Area, Jiangbei District, Chongqing, China  
 EUT : Smart Projector  
 Model Name : M135FGE-Pro, M135\*\*\*\*\*, "\*" can be replaced by 0-9, A-Z, - or blank, indicates for different market purposes  
 Trademark : WEMAX, FORMOVIE

Measurement Procedure Used:

APPLICABLE STANDARDS	
STANDARD	TEST RESULT
FCC 47 CFR Part 2 , Subpart J FCC 47 CFR Part 15 , Subpart C	PASS

The above equipment was tested by EMTEK (SHENZHEN) CO., LTD. The test data, data evaluation, test procedures, and equipment configurations shown in this report were made in accordance with the procedures given in ANSI C63.10 (2013) and the energy emitted by the sample EUT tested as described in this report is in compliance with the requirements of FCC Rules Part 2 and Part 15.247

The test results of this report relate only to the tested sample identified in this report.

Date of Test : Jul 28, 2021 to Aug 27, 2021

Prepared by :   
Xiaolan Yu /Editor

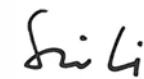
Reviewer :   
Sevin Li /Supervisor

Approve & Authorized Signer :   
Lisa Wang/Manager



## Modified History

Version	Report No.	Revision Date	Summary
V1.0	ENS2107280006W00403 R	/	Original Report



## TABLE OF CONTENTS

<b>1</b>	<b>EUT TECHNICAL DESCRIPTION .....</b>	<b>5</b>
<b>2</b>	<b>SUMMARY OF TEST RESULT .....</b>	<b>6</b>
<b>3</b>	<b>TEST METHODOLOGY .....</b>	<b>7</b>
3.1	GENERAL DESCRIPTION OF APPLIED STANDARDS .....	7
3.2	MEASUREMENT EQUIPMENT USED .....	7
3.3	DESCRIPTION OF TEST MODES .....	9
<b>4</b>	<b>FACILITIES AND ACCREDITATIONS .....</b>	<b>10</b>
4.1	FACILITIES .....	10
4.2	EQUIPMENT .....	10
4.3	LABORATORY ACCREDITATIONS AND LISTINGS .....	10
<b>5</b>	<b>TEST SYSTEM UNCERTAINTY .....</b>	<b>11</b>
<b>6</b>	<b>SETUP OF EQUIPMENT UNDER TEST .....</b>	<b>12</b>
6.1	RADIO FREQUENCY TEST SETUP 1 .....	12
6.2	RADIO FREQUENCY TEST SETUP 2 .....	12
6.3	CONDUCTED EMISSION TEST SETUP .....	15
6.4	BLOCK DIAGRAM CONFIGURATION OF TEST SYSTEM .....	16
6.5	SUPPORT EQUIPMENT .....	16
<b>7</b>	<b>TEST REQUIREMENTS .....</b>	<b>17</b>
7.1	MINIMUM (6DB) OCCUPIED BANDWIDTH .....	17
7.2	MAXIMUM PEAK CONDUCTED OUTPUT POWER .....	24
7.3	MAXIMUM POWER SPECTRAL DENSITY .....	39
7.4	UNWANTED SPURIOUS EMISSIONS .....	54
7.5	RADIATED EMISSION .....	59
7.6	CONDUCTED EMISSION TEST .....	70
7.7	ANTENNA APPLICATION .....	73

## 1 EUT TECHNICAL DESCRIPTION

Characteristics	Description
Product	Smart Projector
Model Number	M135FGE-Pro, M135*****, "" can be replaced by 0-9, A-Z, - or blank, indicates for different market purposes (Note: These models are identical in circuitry and electrical, mechanical and physical construction; the only difference is the model. for trading purpose. We prepare M135FGE-Pro for test.)
Sample Number	2#
IEEE 802.11 WLAN Mode Supported	<input checked="" type="checkbox"/> 802.11b <input checked="" type="checkbox"/> 802.11g <input checked="" type="checkbox"/> 802.11n(20MHz channel bandwidth) <input checked="" type="checkbox"/> 802.11n(40MHz channel bandwidth)
Modulation	DSSS with DBPSK/DQPSK/CCK for 802.11b; OFDM with BPSK/QPSK/16QAM/64QAM for 802.11g/n;
Operating Frequency Range	<input checked="" type="checkbox"/> 2412-2462MHz for 802.11b/g/n(HT20); <input checked="" type="checkbox"/> 2422-2452MHz for 802.11n(HT40);
Number of Channels	<input checked="" type="checkbox"/> 11 channels for 802.11b/g/n(HT20); <input checked="" type="checkbox"/> 7 Channels for 802.11n(HT40);
Transmit Power Max	20.11 dBm
Antenna Type	Monopole Antenna
Antenna Gain	Antenna 1: 4.28 dBi Antenna 2: 3.89 dB
Power Supply	Input: AC 100-240V~2.5A 50/60HZ
Date of Received	Jul 28, 2021
Temperature Range	0°C ~ +40°C

## 2 SUMMARY OF TEST RESULT

FCC Part Clause	Test Parameter	Verdict	Remark
15.247(a)(2)	DTS (6dB) Bandwidth	PASS	
15.247(b)(3)	Maximum Peak Conducted Output Power	PASS	
15.247(e)	Maximum Power Spectral Density Level	PASS	
15.247(d)	Unwanted Emission Into Non-Restricted Frequency Bands	PASS	
15.247(d) 15.209	Unwanted Emission Into Restricted Frequency Bands (conducted)	PASS	
15.247(d) 15.209	Radiated Spurious Emission	PASS	
15.207	Conducted Emission Test	PASS	
15.247(b)	Antenna Application	PASS	
	NOTE1: N/A (Not Applicable) NOTE2: According to FCC OET KDB 558074, the report use radiated measurements in the restricted frequency bands. In addition, the radiated test is also performed to ensure the emissions emanating from the device cabinet also comply with the applicable limits.		

### RELATED SUBMITTAL(S) / GRANT(S):

This submittal(s) (test report) is intended for FCC ID: 2AZNP-M135FGE-PRO filing to comply with Section 15.247 of the FCC Part 15, Subpart C Rules.

### 3 TEST METHODOLOGY

#### 3.1 GENERAL DESCRIPTION OF APPLIED STANDARDS

According to its specifications, the EUT must comply with the requirements of the following standards:

FCC 47 CFR Part 2, Subpart J

FCC 47 CFR Part 15, Subpart C

FCC KDB 558074 D01 15.247 Meas Guidance v05r02

FCC KDB 662911 D01 Multiple Transmitter Output v02r01

#### 3.2 MEASUREMENT EQUIPMENT USED

##### Conducted Emission Test Equipment

Equipment	Manufacturer	Model No.	Serial No.	Last Cal.	Cal. Interval
Test Receiver	Rohde & Schwarz	ESCI	101384	May 15, 2021	1 Year
L.I.S.N.	Rohde & Schwarz	ENV216	5	May 15, 2021	1 Year
L.I.S.N.	Kyoritsu	KNW-407	8-1492-9	May 16, 2021	1 Year

##### For Spurious Emissions Test

Equipment	Manufacturer	Model No.	Serial No.	Last Cal.	Cal. Interval
EMI Test Receiver	Rohde & Schwarz	ESU 26	100154	May 15, 2021	1 Year
Pre-Amplifie	Lunar EM	LNA30M3G-25	J10100000070	May 15, 2021	1 Year
Bilog Antenna	Schwarzbeck	VULB9163	661	Sep 22, 2019	2 Year
Horn antenna	Schwarzbeck	BBHA9120D	9120D-1177	July 4, 2020	2 Year
Pre-Amplifie	SKET	LNPA_0118G-45	SK2019051801	May 15, 2021	1 Year
Loop Antenna	Schwarzbeck	FMZB1519	1519-012	June 12, 2021	2 Year
Spectrum Analyzer	Rohde & Schwarz	FSV40	100967	May 15, 2021	1 Year
Horn antenna	Schwarzbeck	BBHA9120D	9120D-1198	May 15, 2021	2 Year
Cable	H+B	NmSm-05-C15052	N/A	May 15, 2021	1 Year
Cable	H+B	NmSm-2-C15201	N/A	May 15, 2021	1 Year
Cable	H+B	NmNm-7-C15702	N/A	May 15, 2021	1 Year
Cable	H+B	SAC-40G-1	414	May 15, 2021	1 Year
Cable	H+B	SUCOFLEX104	MY14871/4	May 15, 2021	
Cable	H+B	BLU18A-NmSm-6500	D8501	May 15, 2021	1 Year
Band reject Filter(50dB)	WI/DE	WRCGV-2400(2400-2485MHz)	2	May 15, 2021	1 Year

**For other test items:**

Equipment	Manufacturer	Model No.	Serial No.	Last Cal.	Cal. Interval
Vector Signal Generater	Agilent	N5182B	My53050553	May 15, 2021	1 Year
Analog Signal Generator	Agilent	N5171B	My53050878	May 15, 2021	1 Year
Signal Analyzer	Agilent	N9010A	My53470879	May 15, 2021	1 Year
Power Analyzer	Agilent	PS-X10-200	N/A	May 15, 2021	1 Year
Wideband Radio Communication Tester	R&S	CMW500	1201.0002K50-140822zk	May 15, 2021	1 Year
Test Accessories	Agilent	PS-X10-100	N/A	May 15, 2021	1 Year
Temperature&Humidity test chamber	ESPEC	EL-02KA	12107166	May 15, 2021	1 Year
Blocking Box	Agilent	AD211	N/A	May 15, 2021	1 Year

**Remark:** Each piece of equipment is scheduled for calibration once a year.

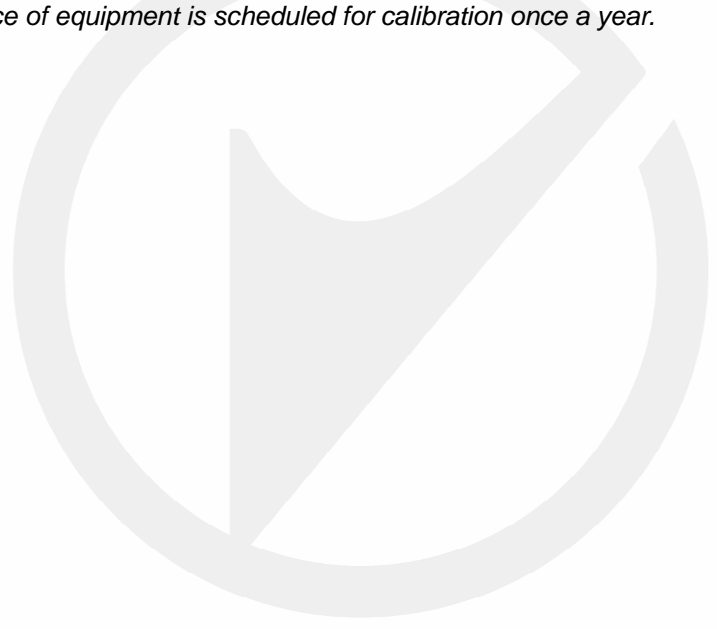



### 3.3 DESCRIPTION OF TEST MODES

The EUT has been tested under its typical operating condition.

The EUT configuration for testing is installed on RF field strength measurement to meet the Commissions requirement and operating in a manner which intends to maximize its emission characteristics in a continuous normal application.

The Transmitter was operated in the normal operating mode. The TX frequency was fixed which was for the purpose of the measurements.

Test of channel included the lowest and middle and highest frequency to perform the test, then record on this report.

Those data rates (802.11b: 1 Mbps; 802.11g: 6 Mbps; 802.11n (HT20): MCS0; 802.11n (HT40): MCS0) were used for all test.

Pre-defined engineering program for regulatory testing used to control the EUT for staying in continuous transmitting and receiving mode is programmed.

Frequency and Channel list for 802.11 b/g/n(HT20):

Channel	Frequency (MHz)	Channel	Frequency (MHz)	Channel	Frequency (MHz)
1	2412	5	2432	9	2452
2	2417	6	2437	10	2457
3	2422	7	2442	11	2462
4	2427	8	2447		

Frequency and Channel list for 802.11n(HT40):

Channel	Frequency (MHz)	Channel	Frequency (MHz)	Channel	Frequency (MHz)
3	2422	6	2437	9	2452
4	2427	7	2442		
5	2432	8	2447		

Test Frequency and Channel for 802.11 b/g/n(HT20):

Lowest Frequency		Middle Frequency		Highest Frequency	
Channel	Frequency (MHz)	Channel	Frequency (MHz)	Channel	Frequency (MHz)
1	2412	6	2437	11	2462

Test Frequency and channel for 802.11n(HT40):

Lowest Frequency		Middle Frequency		Highest Frequency	
Channel	Frequency (MHz)	Channel	Frequency (MHz)	Channel	Frequency (MHz)
3	2422	6	2437	9	2452

The 2.4G WIFI has two antennas and support Multiple Outputs for 802.11n mode for this report; Antenna 1 Gain is 4.28dBi; Antenna 2 Gain is 3.89dBi; For this function is belong to Correlated Categorization equipment

According to KDB 662911, for Unequal antenna gains,

$$\text{Directional gain} = 10 \log [(10^{4.28/20} + 10^{3.89/20})^2 / 2] \text{ dBi} = 7.10 \text{ dBi}$$

## 4 FACILITIES AND ACCREDITATIONS

### 4.1 FACILITIES

All measurement facilities used to collect the measurement data are located at:

EMTEK (Shenzhen) Co., Ltd.

Building 69, Majialong Industry Zone District, Nanshan District, Shenzhen, China

The sites are constructed in conformance with the requirements of ANSI C63.7, ANSI C63.4 and CISPR Publication 22.

### 4.2 EQUIPMENT

Radiated emissions are measured with one or more of the following types of linearly polarized antennas: tuned dipole, biconical, log periodic, bi-log, and/or ridged waveguide, horn. Spectrum analyzers with preselectors and quasi-peak detectors are used to perform radiated measurements.

Conducted emissions are measured with Line Impedance Stabilization Networks and EMI Test Receivers.

Calibrated wideband preamplifiers, coaxial cables, and coaxial attenuators are also used for making measurements.

All receiving equipment conforms to CISPR Publication 16-1, "Radio Interference Measuring Apparatus and Measurement Methods."

### 4.3 LABORATORY ACCREDITATIONS AND LISTINGS

#### Site Description

EMC Lab. : **Accredited by CNAS**  
 The Certificate Registration Number is L2291.  
 The Laboratory has been assessed and proved to be in compliance with CNAS-CL01 (identical to ISO/IEC 17025:2017)

**Accredited by FCC**  
 Designation Number: CN1204  
 Test Firm Registration Number: 882943

**Accredited by A2LA**  
 The Certificate Number is 4321.01.

Accredited by Industry Canada  
 The Conformity Assessment Body Identifier is CN0008

Name of Firm : EMTEK (SHENZHEN) CO., LTD.

Site Location : Building 69, Majialong Industry Zone,  
 Nanshan District, Shenzhen, Guangdong, China

## 5 TEST SYSTEM UNCERTAINTY

The following measurement uncertainty levels have been estimated for tests performed on the apparatus:

Parameter	Uncertainty
Radio Frequency	$\pm 1 \times 10^{-5}$
Maximum Peak Output Power Test	$\pm 1.0\text{dB}$
Conducted Emissions Test	$\pm 2.0\text{dB}$
Radiated Emission Test	$\pm 2.0\text{dB}$
Power Density	$\pm 2.0\text{dB}$
Occupied Bandwidth Test	$\pm 1.0\text{dB}$
Band Edge Test	$\pm 3\text{dB}$
All emission, radiated	$\pm 3\text{dB}$
Antenna Port Emission	$\pm 3\text{dB}$
Temperature	$\pm 0.5^\circ\text{C}$
Humidity	$\pm 3\%$

Measurement Uncertainty for a level of Confidence of 95%

## 6 SETUP OF EQUIPMENT UNDER TEST

### 6.1 RADIO FREQUENCY TEST SETUP 1

The WLAN component's antenna port(s) of the EUT are connected to the measurement instrument per an appropriate attenuator. The EUT is controlled by PC/software to emit the specified signals for the purpose of measurements.

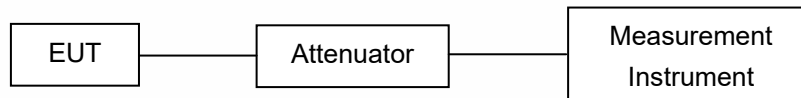

### 6.2 RADIO FREQUENCY TEST SETUP 2

The test site semi-anechoic chamber has met the requirement of NSA tolerance 4 dB according to the standards: ANSI C63.10. The test distance is 3m. The setup is according to the requirements in Section 13.1.4.1 of ANSI C63.10-2013 and CAN/CSA-CEI/IEC CISPR 22.

The maximal emission value is acquired by adjusting the antenna height, polarisation and turntable azimuth. Normally, the height range of antenna is 1 m to 4 m, the azimuth range of turntable is 0° to 360°, and the receive antenna has two polarizations Vertical (V) and Horizontal (H).

#### Below 30MHz:

The EUT is placed on a turntable 0.8 meters above the ground in the chamber, 3 meter away from the antenna (loop antenna). The Antenna should be positioned with its plane vertical at the specified distance from the EUT and rotated about its vertical axis for maximum response at each azimuth about the EUT. The center of the loop shall be 1 m above the ground. For certain applications, the loop antenna plane may also need to be positioned horizontally at the specified distance from the EUT.

#### Above 30MHz:

The EUT is placed on a turntable 0.8 meters above the ground in the chamber, 3 meter away from the antenna. The maximal emission value is acquired by adjusting the antenna height, polarisation and turntable azimuth. Normally, the height range of antenna is 1 m to 4 m, the azimuth range of turntable is 0° to 360°, and the receive antenna has two polarizations Vertical (V) and Horizontal (H).

#### Above 1GHz:

The EUT is placed on a turntable 1.5 meters above the ground in the chamber, 3 meter away from the antenna. The maximal emission value is acquired by adjusting the antenna height, polarisation and turntable azimuth. Normally, the height range of antenna is 1 m to 4 m, the azimuth range of turntable is 0° to 360°, and the receive antenna has two polarizations Vertical (V) and Horizontal (H).

Measurements shall be taken, using the following steps, at a test site that has been validated using the procedures of ANSI C63.4 or the latest CISPR 16-1-4 for measurements above 1 GHz, so as to simulate a near free-space environment (see RSS-Gen for applicable versions of ANSI and CISPR standards).

(1) Line the ground plane with absorbers between the transmitter and the receive antenna to minimize reflections. The absorbers used should have a minimum-rated attenuation of 20 dB through the measurement frequency range of interest. The absorbers shall be positioned to replicate the layout used when compliance with the applicable acceptability criterion was achieved, as set forth in the aforementioned standards on site validation.

(2) Set the height of the receive antenna to 1.5 m. The receive antenna must be one that was designed and fabricated to operate over the entire frequency range of interest, for example, an appropriate standard gain horn.

(3) The distance between the receive antenna and the radiating source shall be sufficient in order to ensure far-field conditions.

(4) Mount the transmitter at a height of 1.5 m.

(5) Configure the device under test (DUT) to produce the maximum power spectral density as measured while assessing compliance with Section 6.2.2 (i.e. channel frequency, modulation type and data rate). If the DUT is equipped with a detachable antenna and the antenna is intended for remote installation (i.e.

tower-mounted), the DUT may be substituted with a suitable signal generator. The level and frequency settings on the generator shall be set so as to reproduce the maximum power spectral density, measured within a 1 MHz bandwidth, obtained while assessing compliance to Section 6.2.2.

(6) Position the transmitter or the radiating antenna so that elevation pattern measurements can be taken.

(7) Find the 0° reference point in the horizontal plane.

(8) Care should be taken when positioning the receive antenna to avoid cross-polarization. Antennas of known mounting polarization should be assessed with the receive antenna oriented in the same polarity. If the polarization of the transmit antenna is unknown or the transmit antenna can be mounted in either polarization, e.i.r.p. measurements should be performed to find which mounting polarity provides the highest e.i.r.p. value. Testing shall be carried out with the receive antenna and the DUT mounted in each polarity.

(9) The emission shall be centred on the display of the spectrum analyzer with the following settings:

i. If the power spectral density of the DUT was assessed with a peak detector and the antenna cannot be detached from the DUT, the spectrum analyzer shall be set to a peak detector with a resolution bandwidth and video bandwidth of 1 MHz.

ii. If the power spectral density of the DUT was assessed using a sample detector with power averaging and the antenna cannot be detached from the DUT, the spectrum analyzer shall be set to a sample detector, configured to produce 100 power averages and set with a resolution bandwidth, as well as a video bandwidth of 1 MHz.

iii. If the antenna can be detached from the DUT, a continuous wave (CW) signal equal to that of the power spectral density measurement may be used, the spectrum analyzer shall be set to peak detector with a resolution bandwidth and video bandwidth of 1 MHz.

(10) Rotate the turntable 360° recording the field strength at each step. Throughout the main beam of the antenna, the step size shall be kept to a maximum of 1°.

Once outside the main beam of the antenna, the maximum step size shall be as follows, when compared to the requirements of Section 6.2.2:

i. Between 0° and 8°, maximum step size of 2°;

ii. Between 8° and 40°, maximum step size of 4°;

iii. Between 40° and 45°, maximum step size of 1°;

iv. Between 45° and 90°, maximum step size of 5°.

Once the mask reaches 90°, the mask will be inverted and the step size will follow in the same manner as above.

For the purpose of this procedure, the main beam of the antenna is defined as the 3 dB beamwidth.

(11) Convert the measured field strength values in terms of e.i.r.p. density (dBW/1 MHz) using the following equation:

$$\text{e.i.r.p. density (dBW/MHz)} = 10 \log((E \cdot r)^2 / 30)$$

E = field strength in V/m

r = measurement distance in metres

(12) Plot the results against the emission mask with reference to the horizontal plane.

(13) Using the plot, the 0° can be rotated to determine the worst-case installation tilt angle.

(14) Testing shall be performed using the highest gain antenna for every antenna type, if applicable.

(15) Antenna type(s), antenna model number(s), and worst-case tilt angle(s) necessary to remain compliant with the elevation mask requirement set forth in Section 6.2.2(3) of RSS-247 shall be clearly indicated in the user manual.

The following figure is an example of a polar elevation mask measured using the Method 1 reference to dB $\mu$ V/m at 3 m.

(a) Radiated Emission Test Set-Up, Frequency Below 30MHz

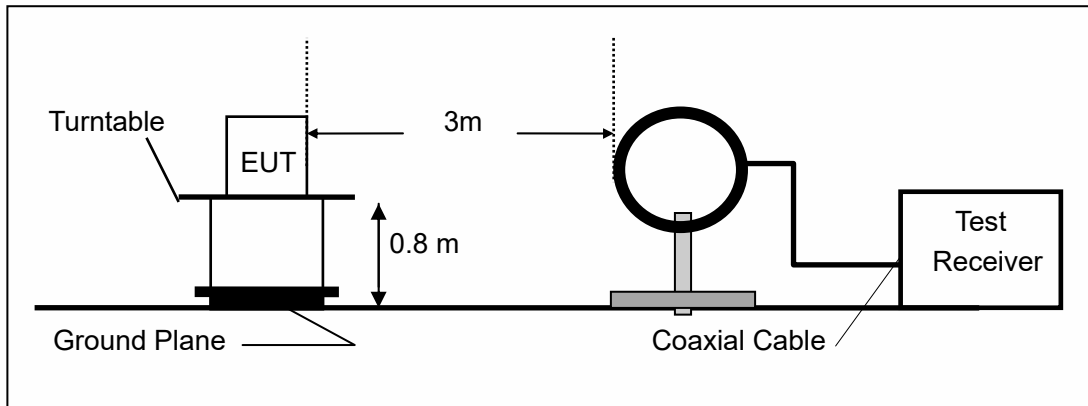

(b) Radiated Emission Test Set-Up, Frequency Below 1000MHz

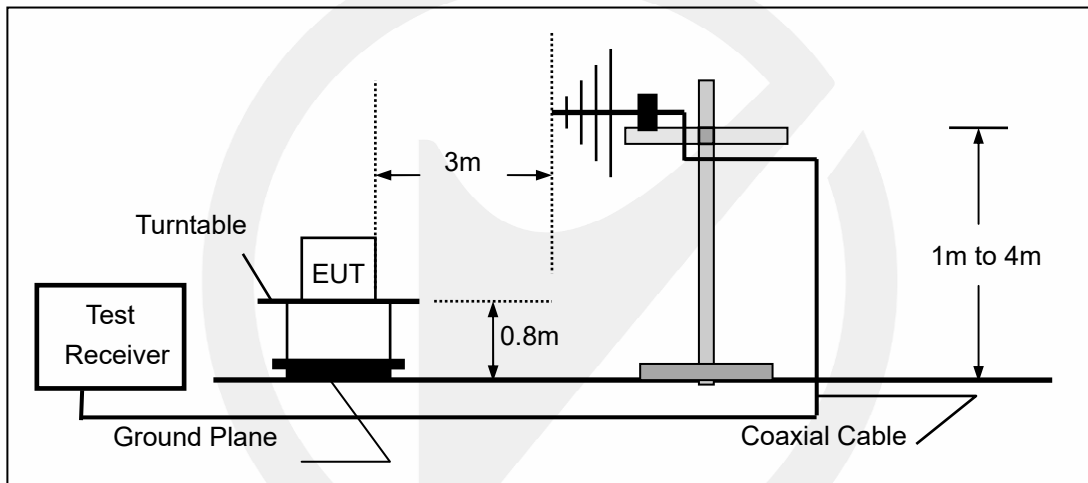

(c) Radiated Emission Test Set-Up, Frequency above 1000MHz

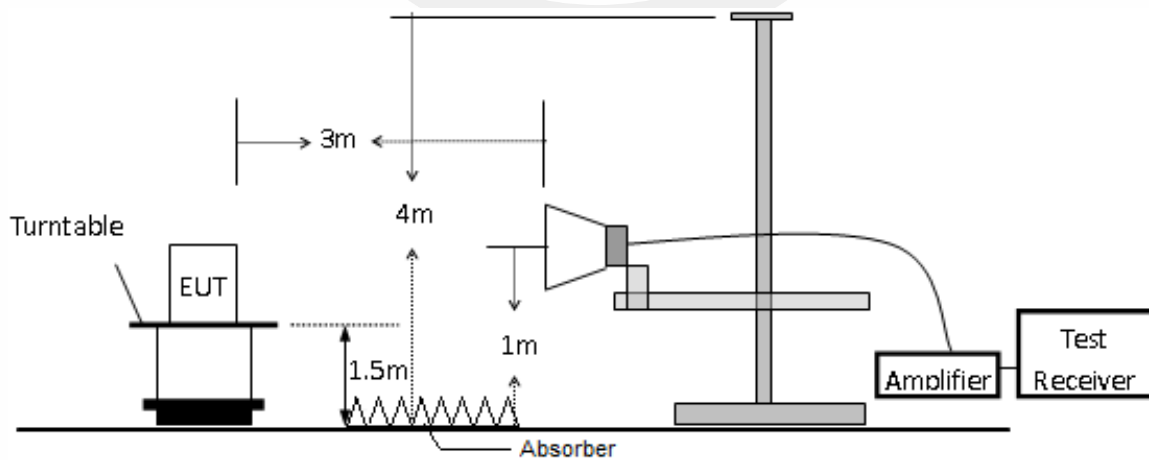

### 6.3 CONDUCTED EMISSION TEST SETUP

The mains cable of the EUT (maybe per AC/DC Adapter) must be connected to LISN. The LISN shall be placed 0.8 m from the boundary of EUT and bonded to a ground reference plane for LISN mounted on top of the ground reference plane. This distance is between the closest points of the LISN and the EUT. All other units of the EUT and associated equipment shall be at least 0.8m from the LISN.

Ground connections, where required for safety purposes, shall be connected to the reference ground point of the LISN and, where not otherwise provided or specified by the manufacturer, shall be of same length as the mains cable and run parallel to the mains connection at a separation distance of not more than 0.8 m.

According to the requirements in Section 13.1.4.1 of ANSI C63.10-2013 Conducted emissions from the EUT measured in the frequency range between 0.15 MHz and 30 MHz using CISPR Quasi-Peak and average detector mode.

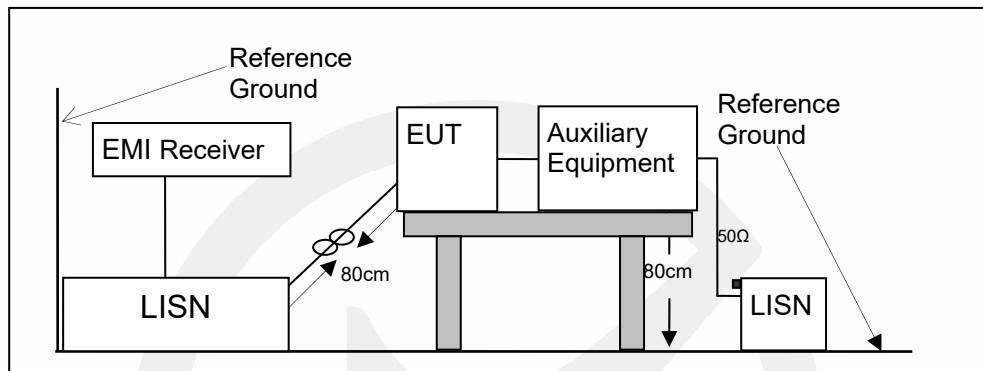

**6.4 BLOCK DIAGRAM CONFIGURATION OF TEST SYSTEM**

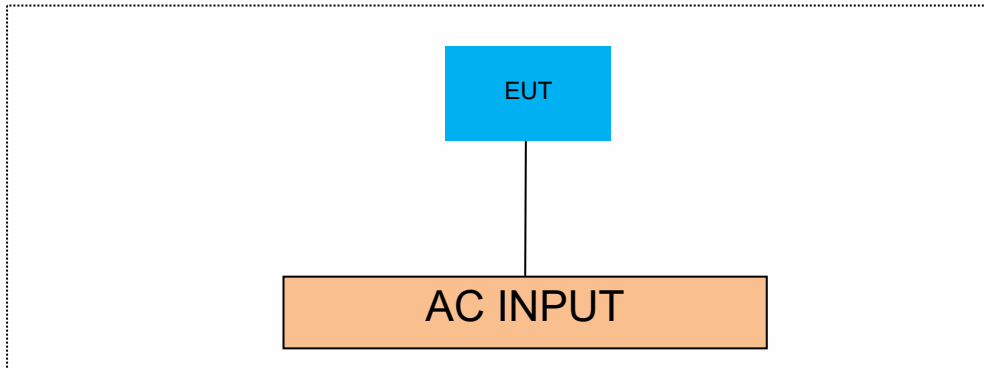

**6.5 SUPPORT EQUIPMENT**

EUT Cable List and Details			
Cable Description	Length (m)	Shielded/Unshielded	With / Without Ferrite
/	/	/	/

Auxiliary Cable List and Details			
Cable Description	Length (m)	Shielded/Unshielded	With / Without Ferrite
/	/	/	/

Auxiliary Equipment List and Details			
Description	Manufacturer	Model	Serial Number
/	/	/	/

**Notes:**

1. All the equipment/cables were placed in the worst-case configuration to maximize the emission during the test.
2. Grounding was established in accordance with the manufacturer's requirements and conditions for the intended use.



## 7 TEST REQUIREMENTS

### 7.1 MINIMUM (6DB) OCCUPIED BANDWIDTH

#### 7.1.1 Applicable Standard

According to FCC Part15.247 (a)(2) and KDB 558074 D01 15.247 Meas Guidance v05r02

#### 7.1.2 Conformance Limit

The minimum -6 dB bandwidth shall be at least 500 kHz.

#### 7.1.3 Test Configuration

Test according to clause 6.1 radio frequency test setup

#### 7.1.4 Test Procedure

The EUT was operating in WIFI mode and controlled its channel. Printed out the test result from the spectrum by hard copy function.

The RF output of EUT was connected to the spectrum analyzer by RF cable and attenuator. The path loss was compensated to the results for each measurement.

Set to the maximum power setting and enable the EUT transmit continuously

Set RBW = 100 kHz.

Set the video bandwidth (VBW) =300 kHz.

Set Span=2 times OBW

Set Detector = Peak.

Set Trace mode = max hold.

Set Sweep = auto couple.

Allow the trace to stabilize.

Measure the maximum width of the emission that is constrained by the frequencies associated with the two outermost amplitude points (upper and lower frequencies) that are attenuated by 6 dB relative to the maximum level measured in the fundamental emission.

Measure and record the results in the test report.

#### 7.1.5 Test Results

Temperature : 26°C                      ATM Pressure:: 1011 mbar  
 Humidity : 55 %                      Test By: Lily

Operation Mode	Channel Number	Channel Frequency (MHz)	Measurement Bandwidth (MHz)	Limit (kHz)	Verdict
802.11b	1	2412	10.14	>500	PASS
	6	2437	10.13	>500	PASS
	11	2462	10.14	>500	PASS
802.11g	1	2412	15.54	>500	PASS
	6	2437	15.74	>500	PASS
	11	2462	15.56	>500	PASS
802.11n (HT20)	1	2412	16.06	>500	PASS
	6	2437	16.44	>500	PASS
	11	2462	16.55	>500	PASS
802.11n (HT40)	3	2422	35.26	>500	PASS
	6	2437	35.29	>500	PASS
	9	2452	35.39	>500	PASS

Test Model DTS (6dB) Bandwidth  
802.11b  
Channel 1: 2412MHz

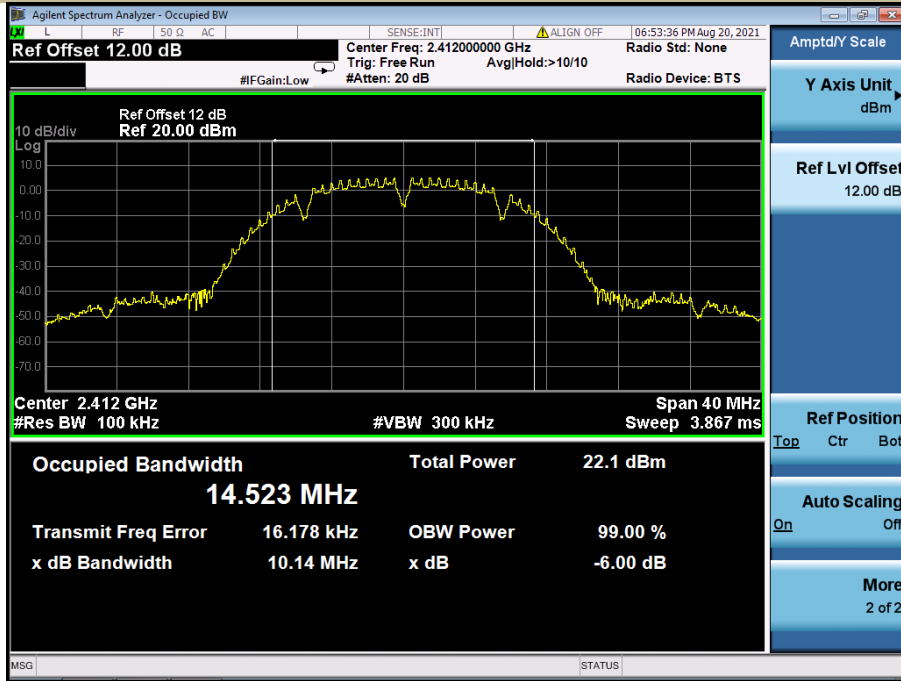

Test Model DTS (6dB) Bandwidth  
802.11b  
Channel 6: 2437MHz

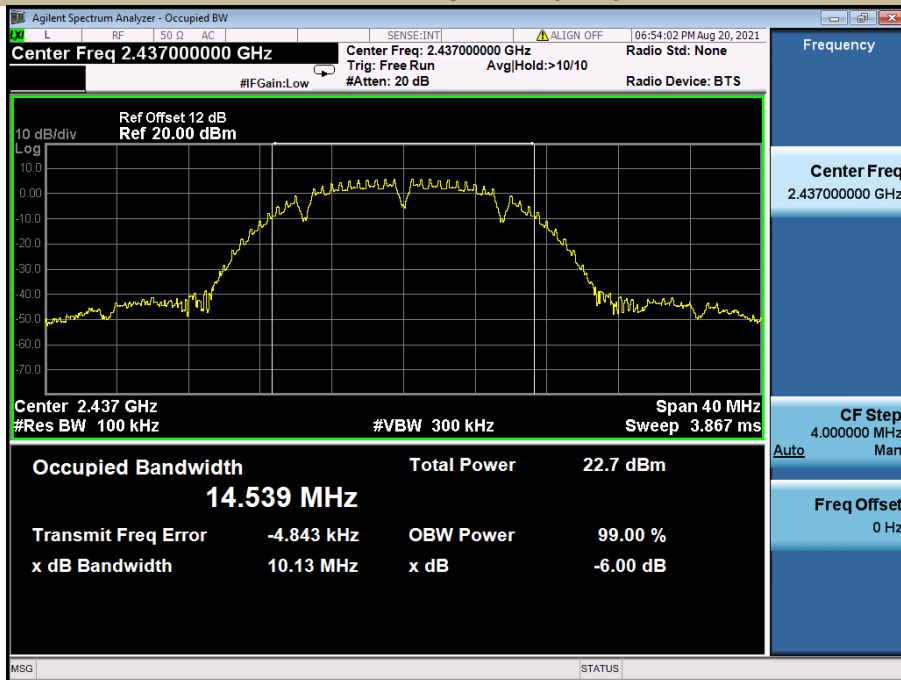

Test Model DTS (6dB) Bandwidth  
802.11b  
Channel 11: 2462MHz



Test Model DTS (6dB) Bandwidth  
802.11g  
Channel 1: 2412MHz

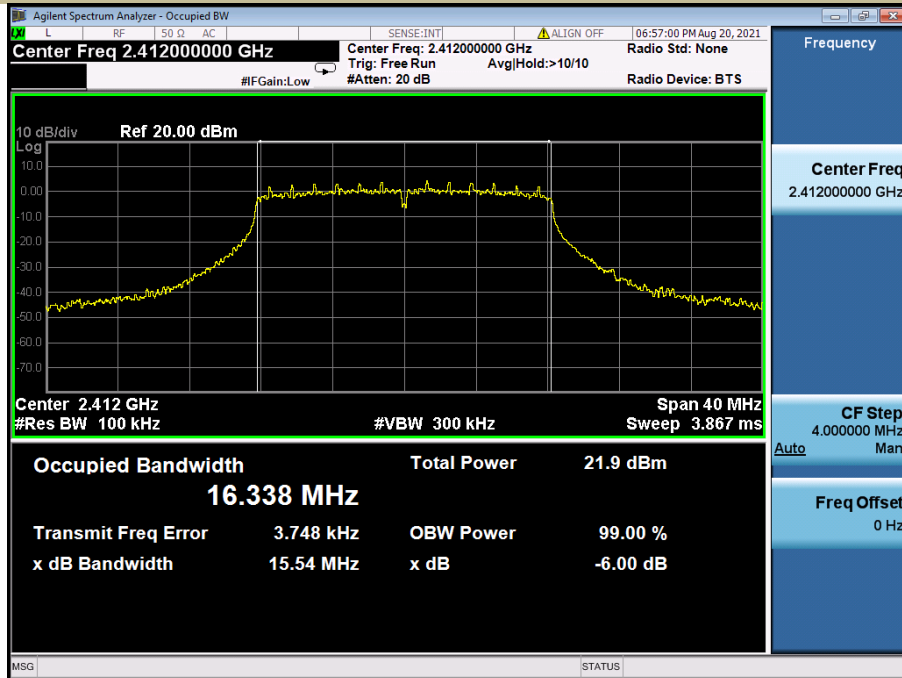

Test Model DTS (6dB) Bandwidth  
802.11g  
Channel 6: 2437MHz

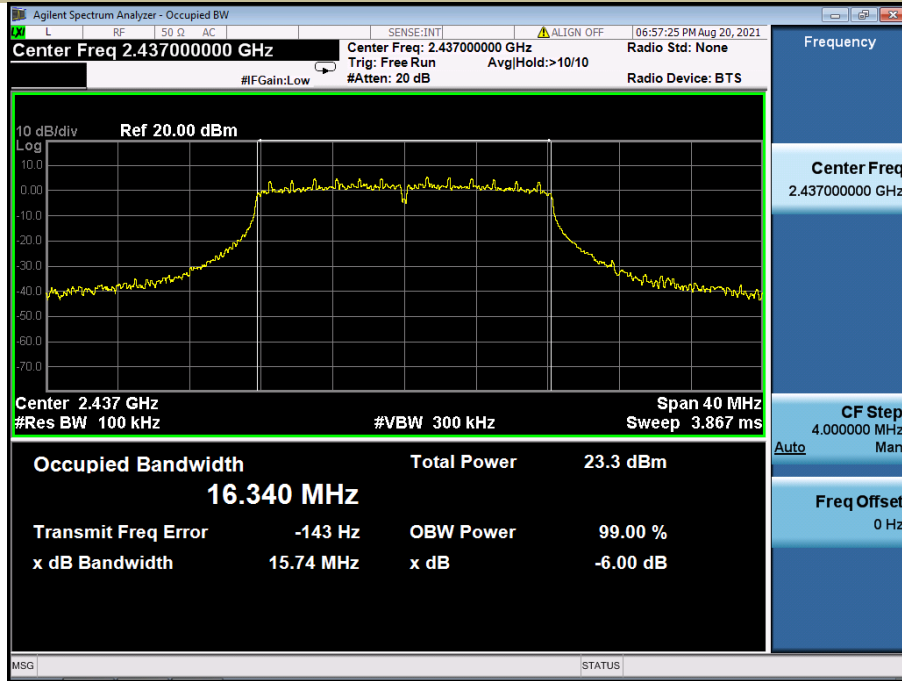

Test Model DTS (6dB) Bandwidth  
802.11g  
Channel 11: 2462MHz

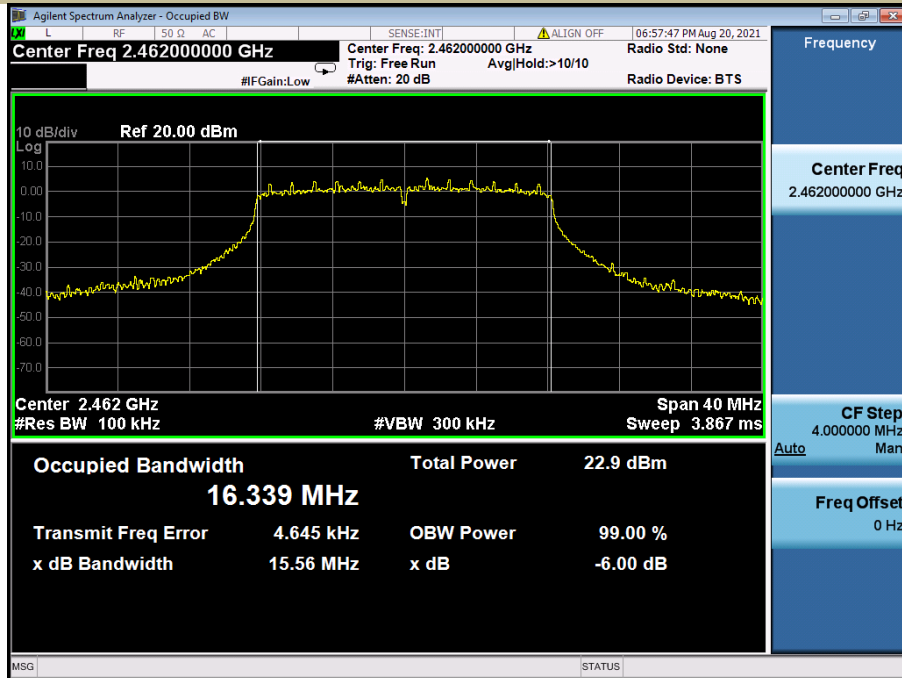

Test Model DTS (6dB) Bandwidth  
802.11n (HT20)  
Channel 1: 2412MHz

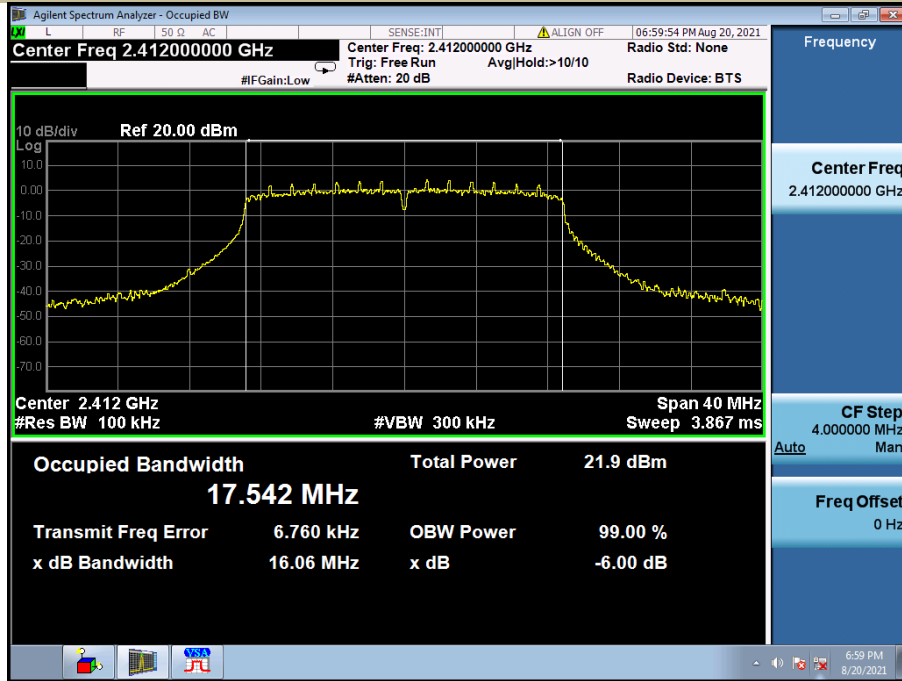

Test Model DTS (6dB) Bandwidth  
802.11n (HT20)  
Channel 6: 2437MHz

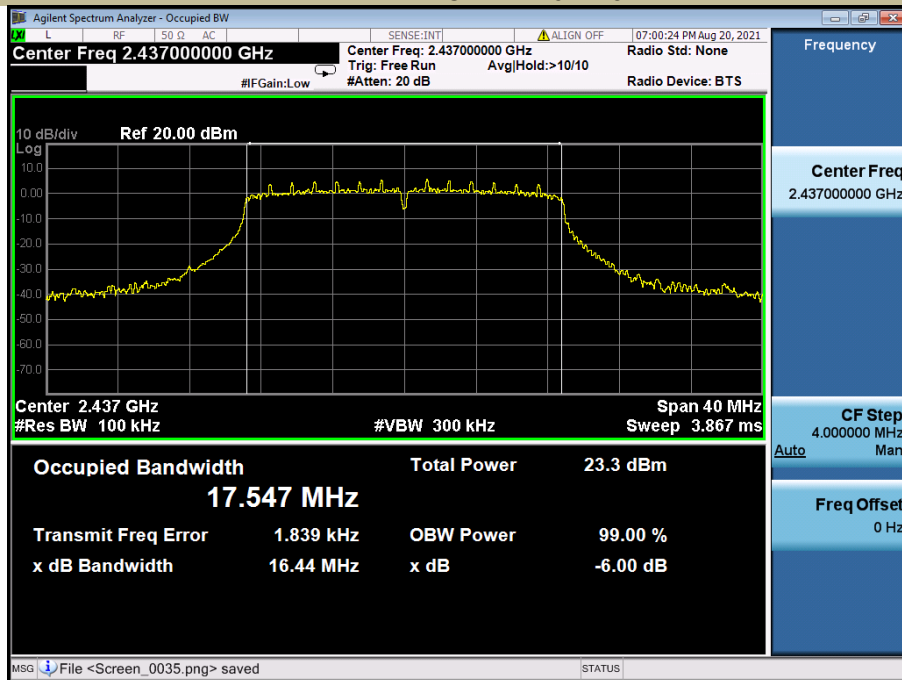

Test Model DTS (6dB) Bandwidth  
802.11n (HT20)  
Channel 11: 2462MHz

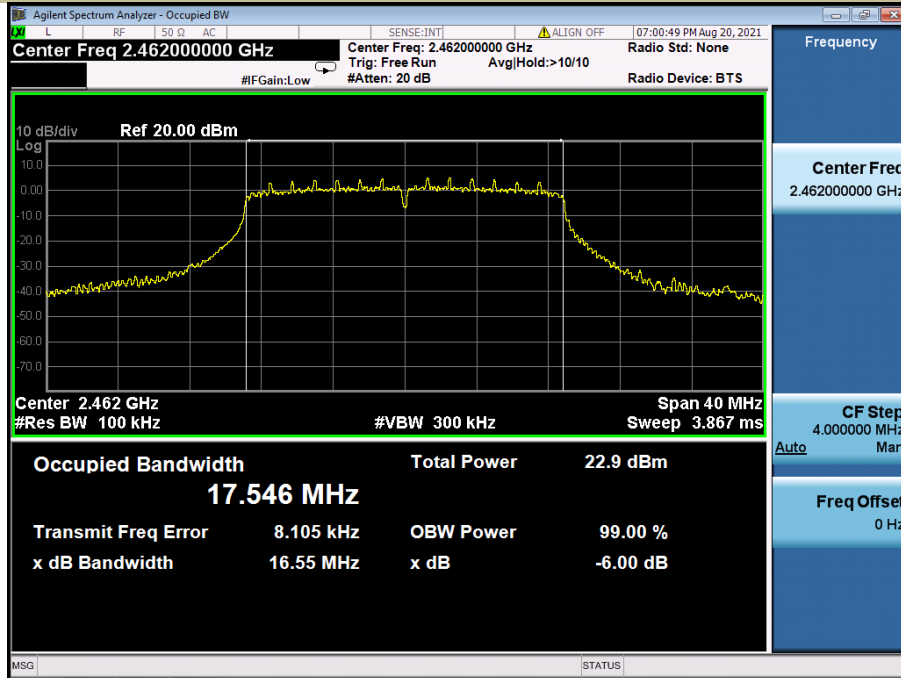

Test Model DTS (6dB) Bandwidth  
802.11n (HT40)  
Channel 3: 2422MHz

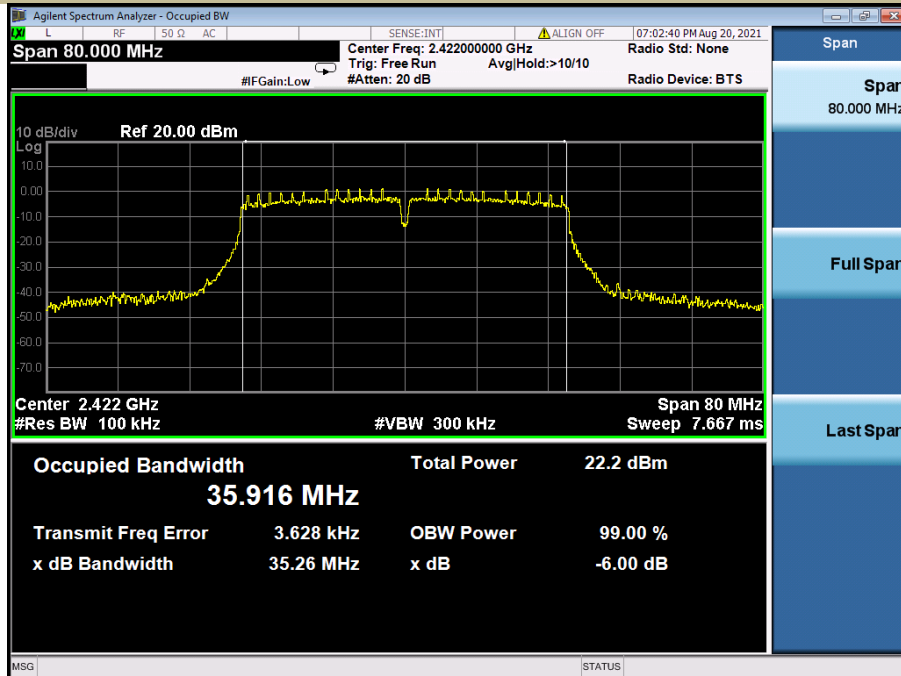

Test Model DTS (6dB) Bandwidth  
802.11n (HT40)  
Channel 6: 2437MHz

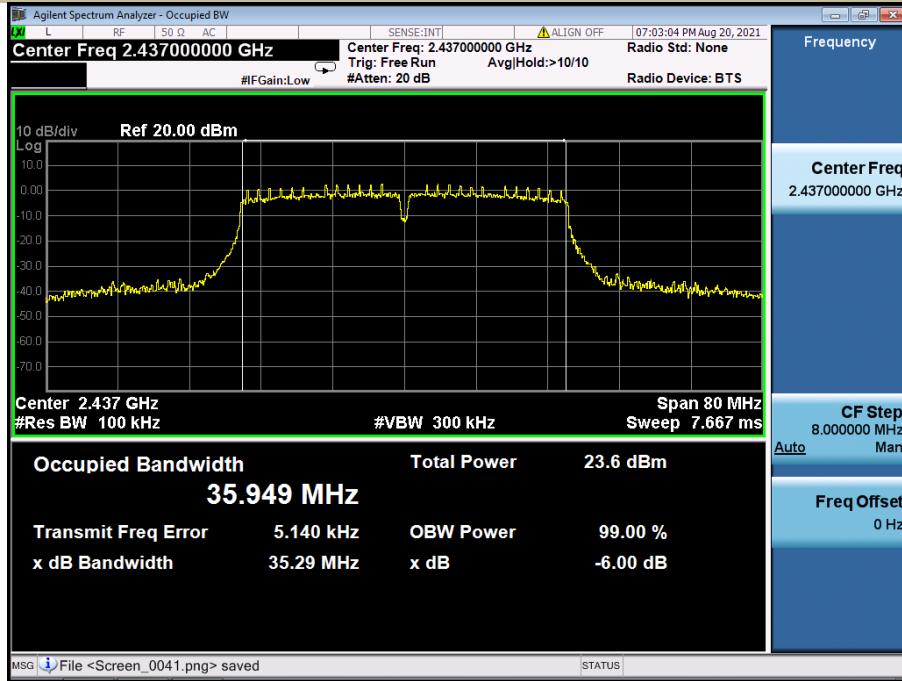

Test Model DTS (6dB) Bandwidth  
802.11n (HT40)  
Channel 9: 2452MHz

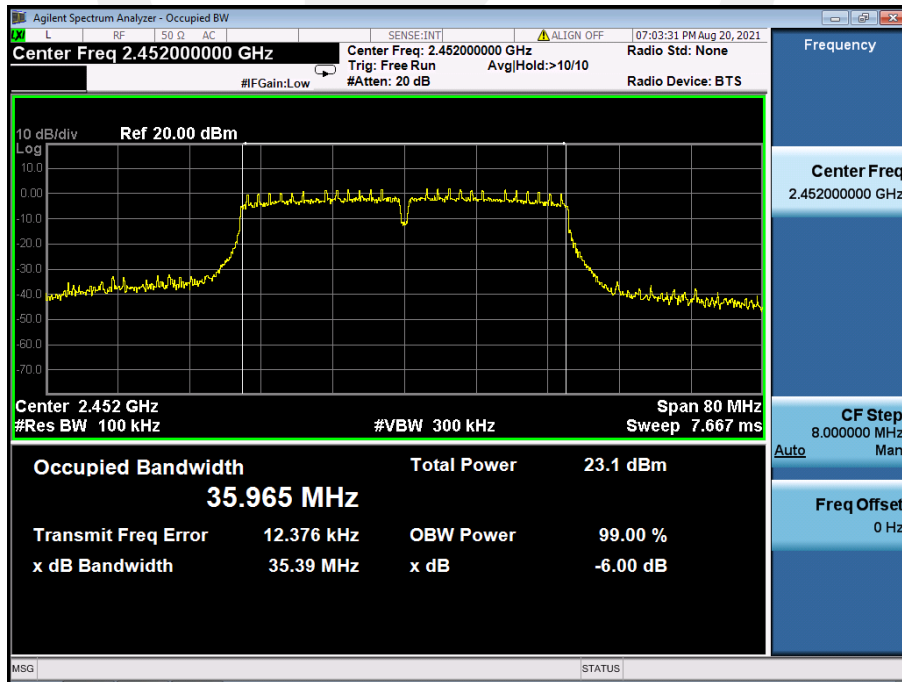

## 7.2 MAXIMUM PEAK CONDUCTED OUTPUT POWER

### 7.2.1 Applicable Standard

According to FCC Part 15.247 (b)(3) and KDB 558074 D01 15.247 Meas Guidance v05r02

### 7.2.2 Conformance Limit

The maximum conducted output power of the intentional radiator for systems using digital modulation in the 2400 - 2483.5 MHz bands shall not exceed: 1 Watt (30dBm).

### 7.2.3 Test Configuration

Test according to clause 6.1 radio frequency test setup

### 7.2.4 Test Procedure

- a) Set span to at least 1.5 times the OBW.
- b) Set RBW = 1-5% of the OBW, not to exceed 1 MHz.
- c) Set VBW  $\geq 3 \times$  RBW.
- d) Number of points in sweep  $\geq 2 \times$  span / RBW. (This gives bin-to-bin spacing  $\leq$  RBW/2, so that narrowband signals are not lost between frequency bins.)
- e) Sweep time = auto.
- f) Detector = RMS (i.e., power averaging), if available. Otherwise, use sample detector mode.
- g) If transmit duty cycle < 98 %, use a sweep trigger with the level set to enable triggering only on full power pulses. The transmitter shall operate at maximum power control level for the entire duration of every sweep. If the EUT transmits continuously (i.e., with no off intervals) or at duty cycle  $\geq 98$  %, and if each transmission is entirely at the maximum power control level, then the trigger shall be set to “free run” .
- h) Trace average at least 100 traces in power averaging (i.e., RMS) mode.
- i) Compute power by integrating the spectrum across the OBW of the signal using the instrument's band power measurement function, with band limits set equal to the OBW band edges. If the instrument does not have a band power function, sum the spectrum levels (in power units) at intervals equal to the RBW extending across the entire OBW of the spectrum.

■ According to FCC Part 15.247(b)(4):

Conducted output power limit specified in paragraph (b) of this section is based on the use of antennas with directional gains that do not exceed 6 dBi. If transmitting antennas of directional gain greater than 6 dBi are used, the conducted output power from the intentional radiator shall be reduced below the stated values in paragraphs (b)(3) of this section, as appropriate, by the amount in dB that the directional gain of the antenna exceeds 6 dBi.

Note: If antenna Gain exceeds 6 dBi, then Output power Limit=30-(Gain- 6)

### 7.2.5 Test Results



For 1T1R

**ANT 1**

Temperature : 26°C  
Humidity : 55 %

ATM Pressure: 1011 mbar  
Test By: Lily

Operation Mode	Channel Number	Channel Frequency (MHz)	Measurement Level (dBm)	Limit (dBm)	Verdict
802.11b	1	2412	14.54	30	PASS
	6	2437	15.16	30	PASS
	11	2462	14.99	30	PASS
802.11g	1	2412	14.77	30	PASS
	6	2437	16.15	30	PASS
	11	2462	15.76	30	PASS
802.11n (HT20)	1	2412	14.70	30	PASS
	6	2437	16.06	30	PASS
	11	2462	15.67	30	PASS
802.11n (HT40)	3	2422	14.62	30	PASS
	6	2437	16.04	30	PASS
	9	2452	15.51	30	PASS

**ANT 2**

Temperature : 26°C  
Humidity : 55 %

ATM Pressure: 1011 mbar  
Test By: Lily

Operation Mode	Channel Number	Channel Frequency (MHz)	Measurement Level (dBm)	Limit (dBm)	Verdict
802.11b	1	2412	16.32	30	PASS
	6	2437	17.21	30	PASS
	11	2462	17.28	30	PASS
802.11g	1	2412	17.16	30	PASS
	6	2437	17.98	30	PASS
	11	2462	17.58	30	PASS
802.11n (HT20)	1	2412	17.11	30	PASS
	6	2437	17.88	30	PASS
	11	2462	17.5	30	PASS
802.11n (HT40)	3	2422	17.07	30	PASS
	6	2437	17.95	30	PASS
	9	2452	17.59	30	PASS

Antenna 1:

Test Model Maximum Conducted Output Power  
802.11b  
Channel 1: 2412MHz

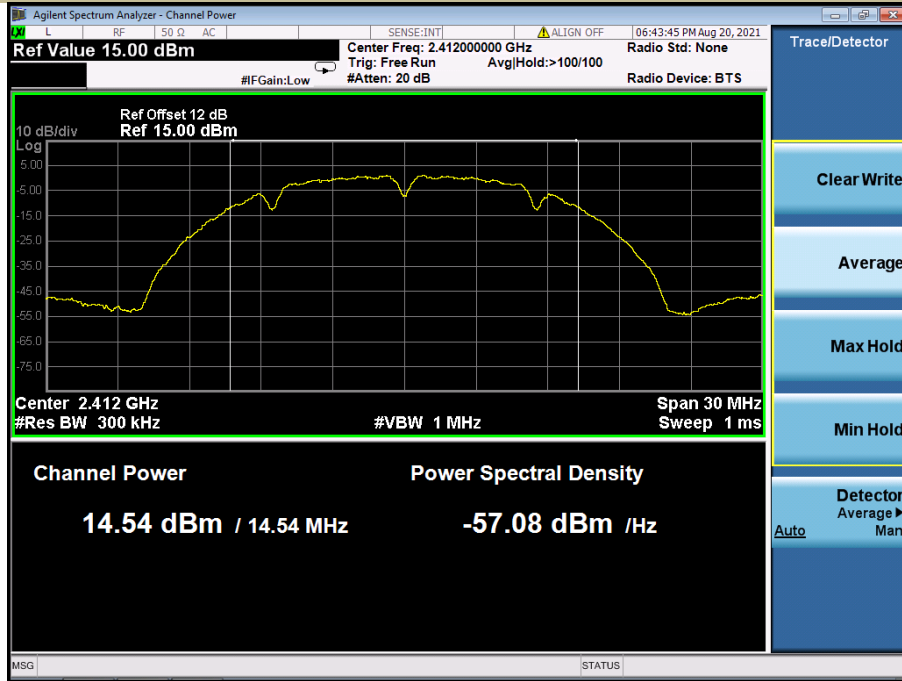

Test Model Maximum Conducted Output Power  
802.11b  
Channel 6: 2437MHz

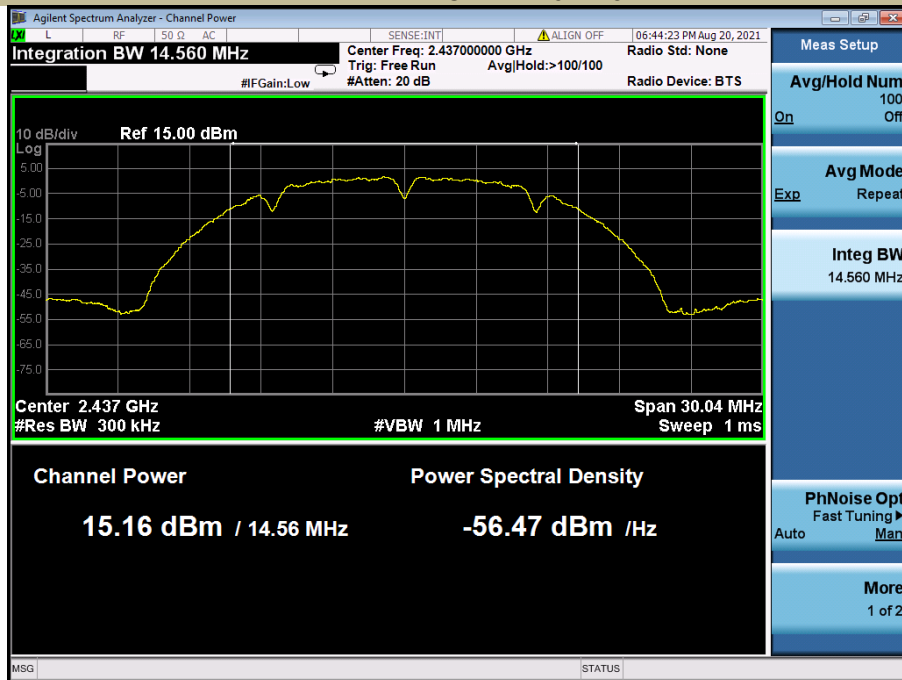

Test Model Maximum Conducted Output Power  
802.11b  
Channel 11: 2462MHz

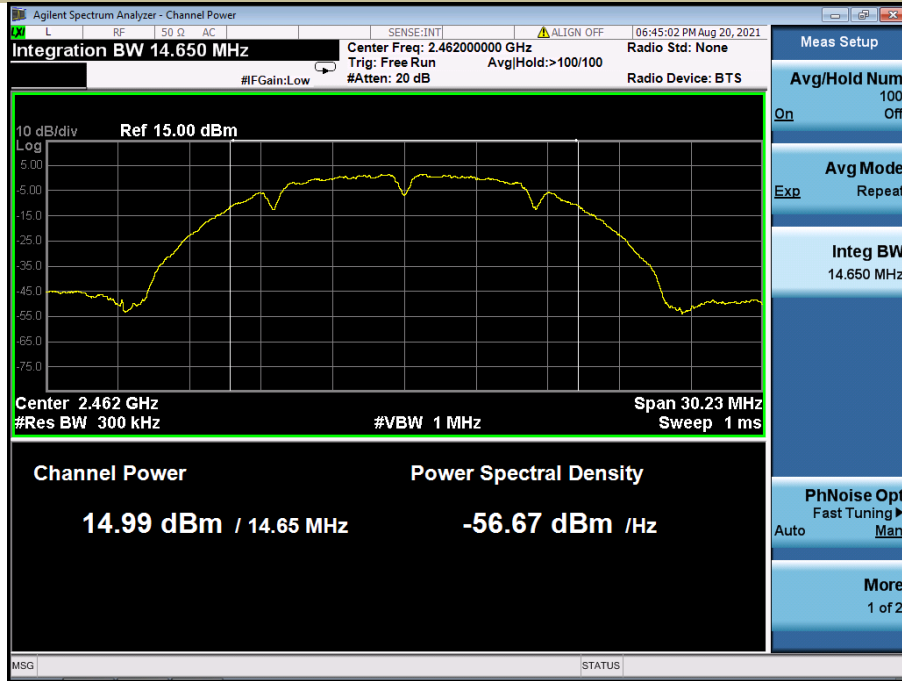

Test Model Maximum Conducted Output Power  
802.11g  
Channel 1: 2412MHz

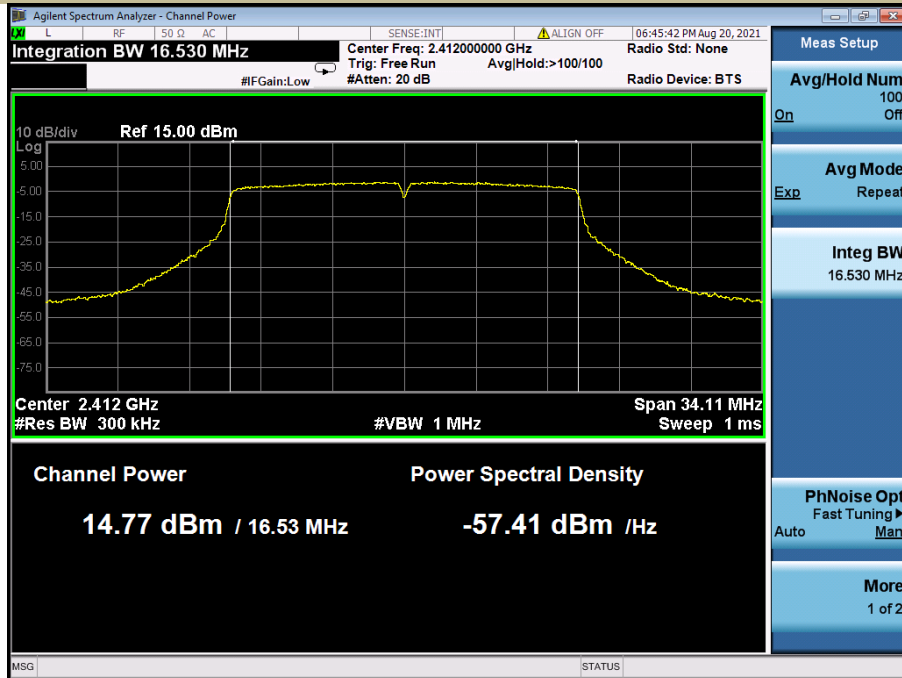

Test Model Maximum Conducted Output Power  
802.11g  
Channel 6: 2437MHz

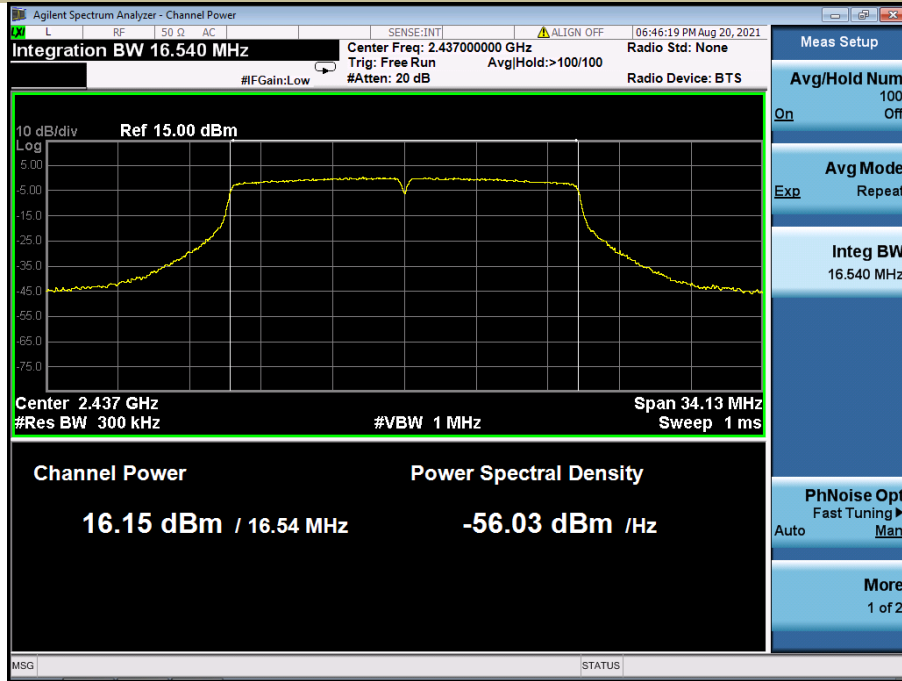

Test Model Maximum Conducted Output Power  
802.11g  
Channel 11: 2462MHz

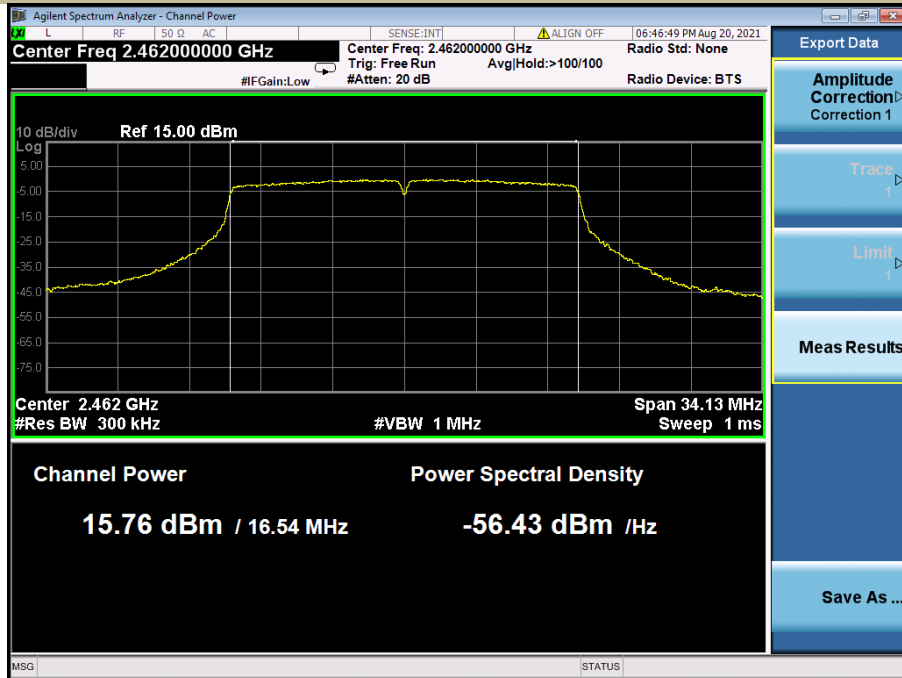

Test Model Maximum Conducted Output Power  
802.11n (HT20)  
Channel 1: 2412MHz

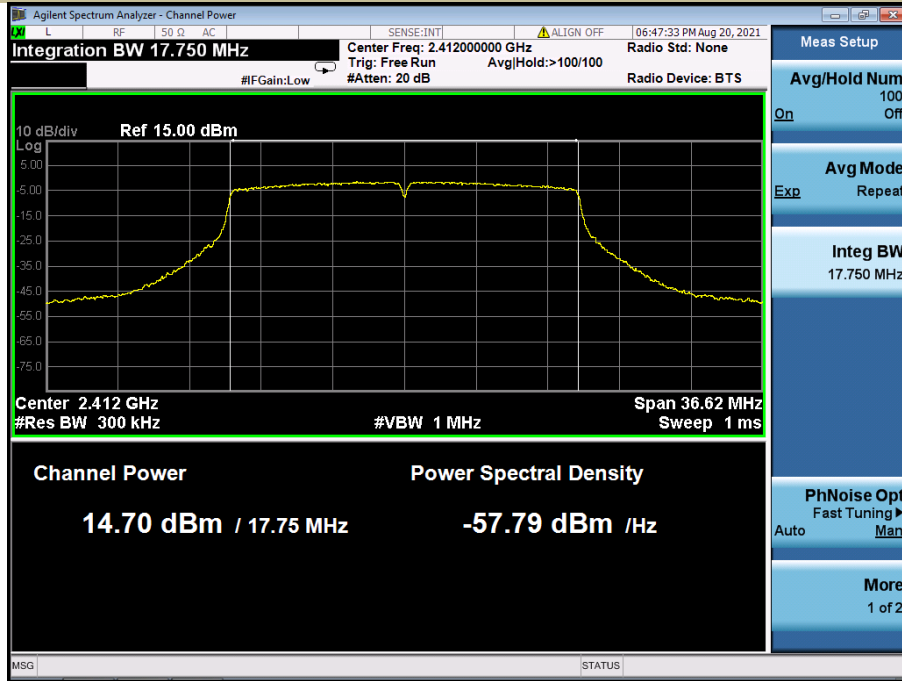

Test Model Maximum Conducted Output Power  
802.11n (HT20)  
Channel 6: 2437MHz

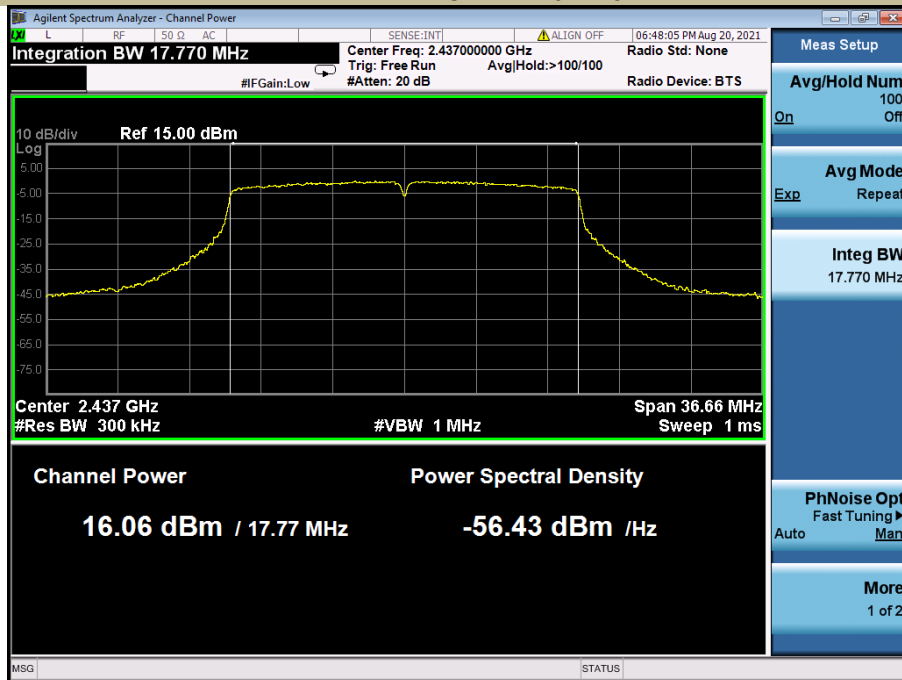

Test Model Maximum Conducted Output Power  
802.11n (HT20)  
Channel 11: 2462MHz

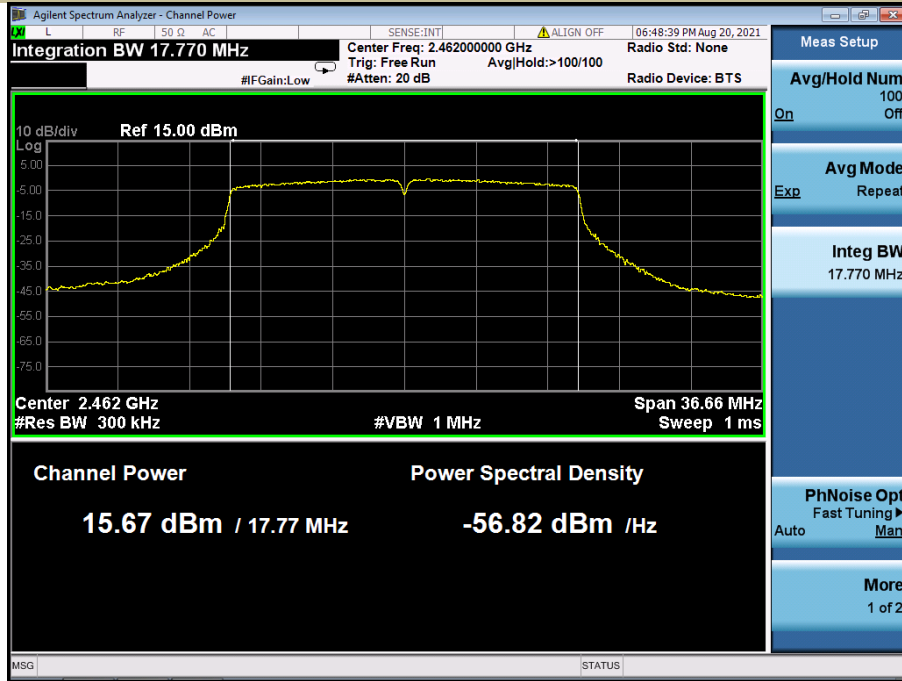

Test Model Maximum Conducted Output Power  
802.11n (HT40)  
Channel 3: 2422MHz

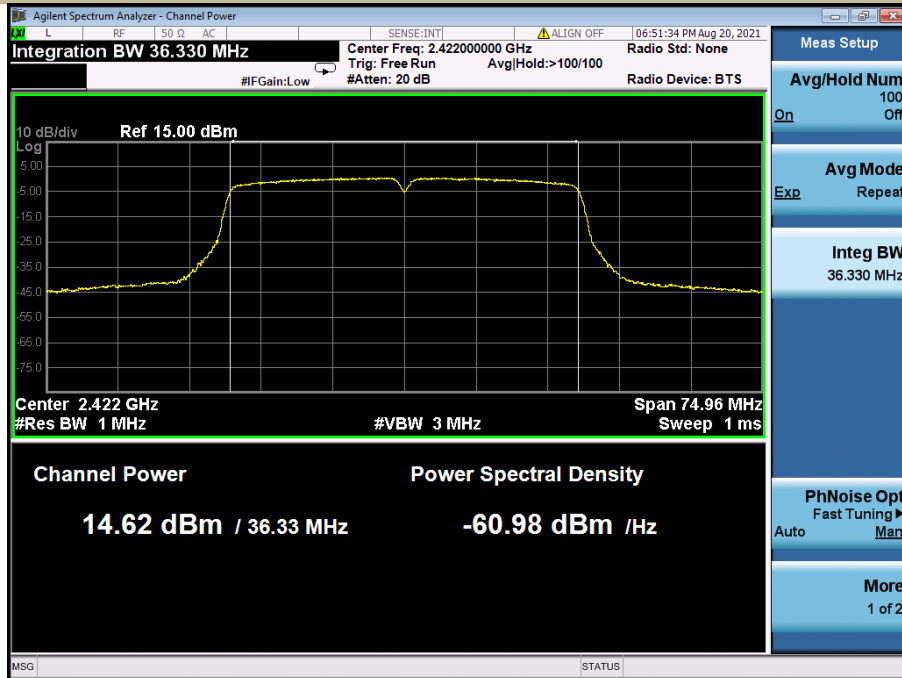

Test Model Maximum Conducted Output Power  
802.11n (HT40)  
Channel 6: 2437MHz

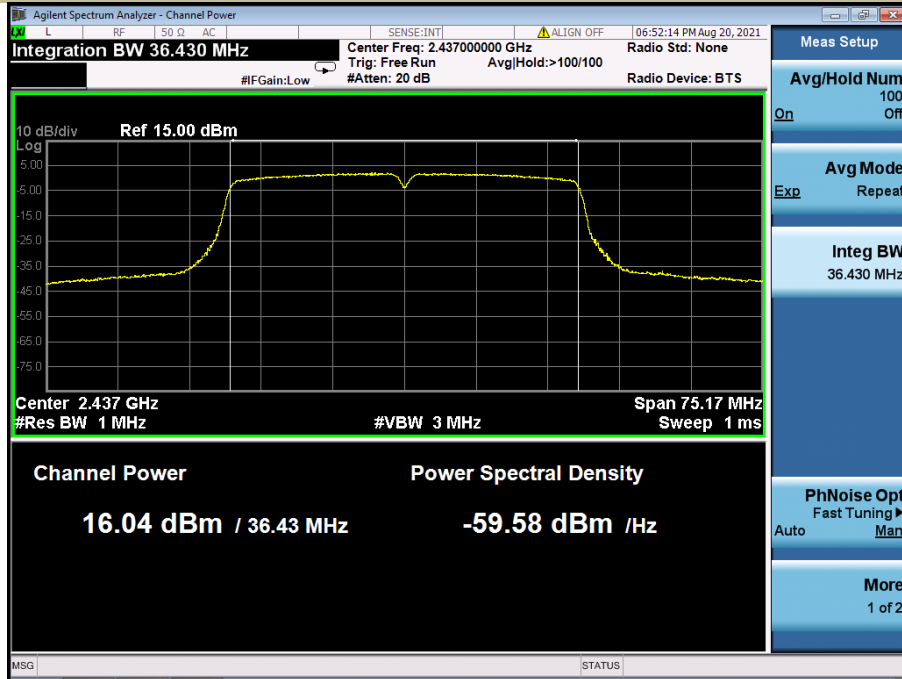

Test Model Maximum Conducted Output Power  
802.11n (HT40)  
Channel 9: 2452MHz

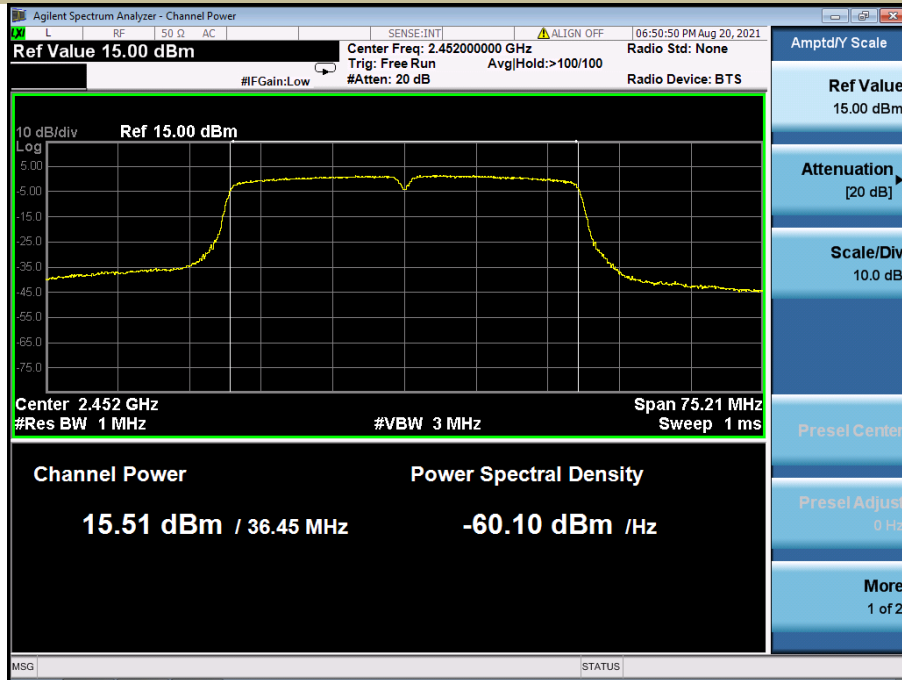

Antenna 2:

Test Model Maximum Conducted Output Power  
802.11b  
Channel 1: 2412MHz

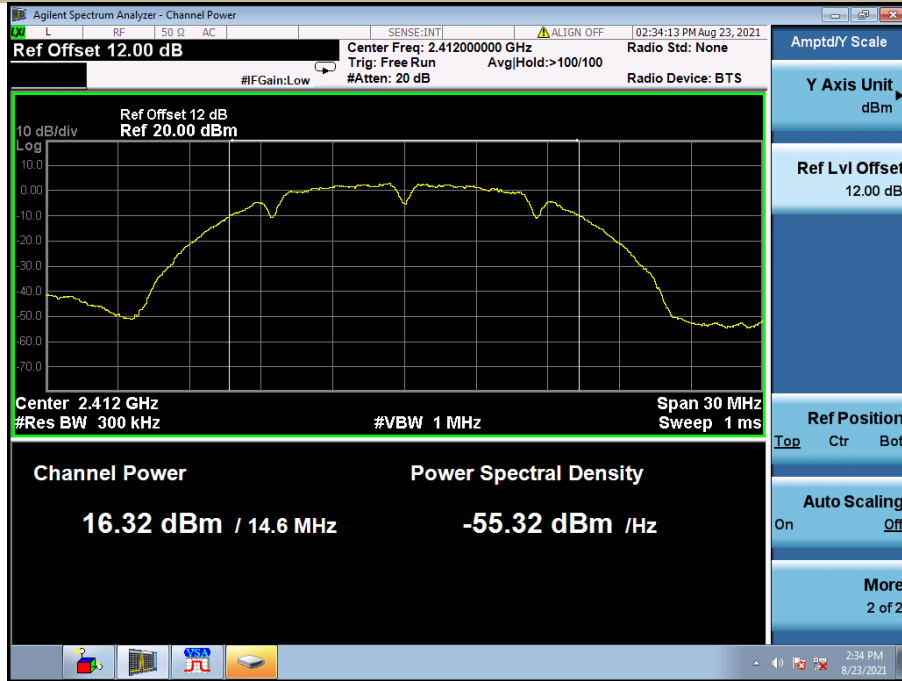

Test Model Maximum Conducted Output Power  
802.11b  
Channel 6: 2437MHz

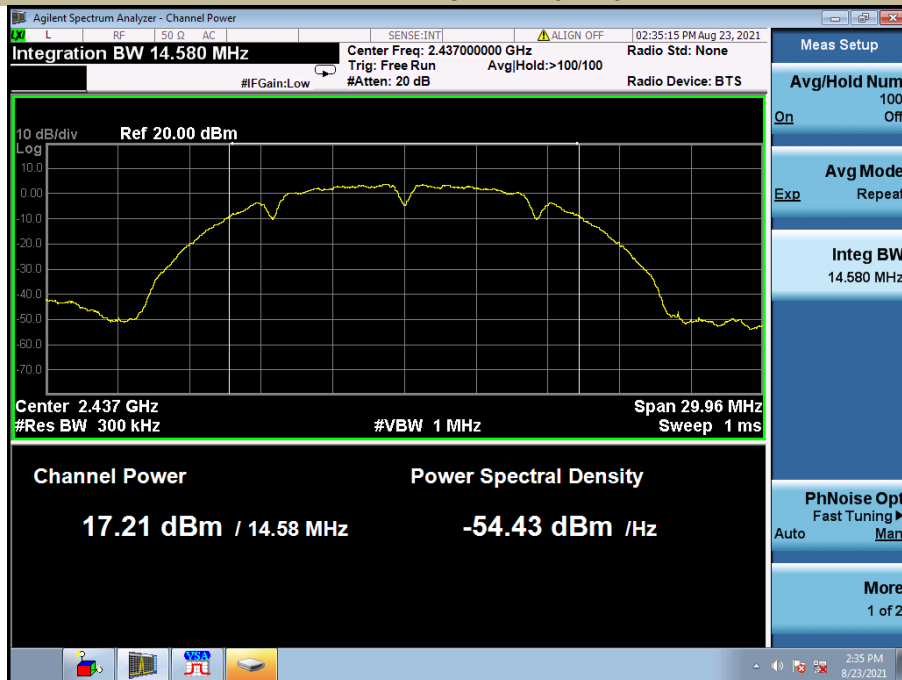



Test Model Maximum Conducted Output Power  
802.11b  
Channel 11: 2462MHz

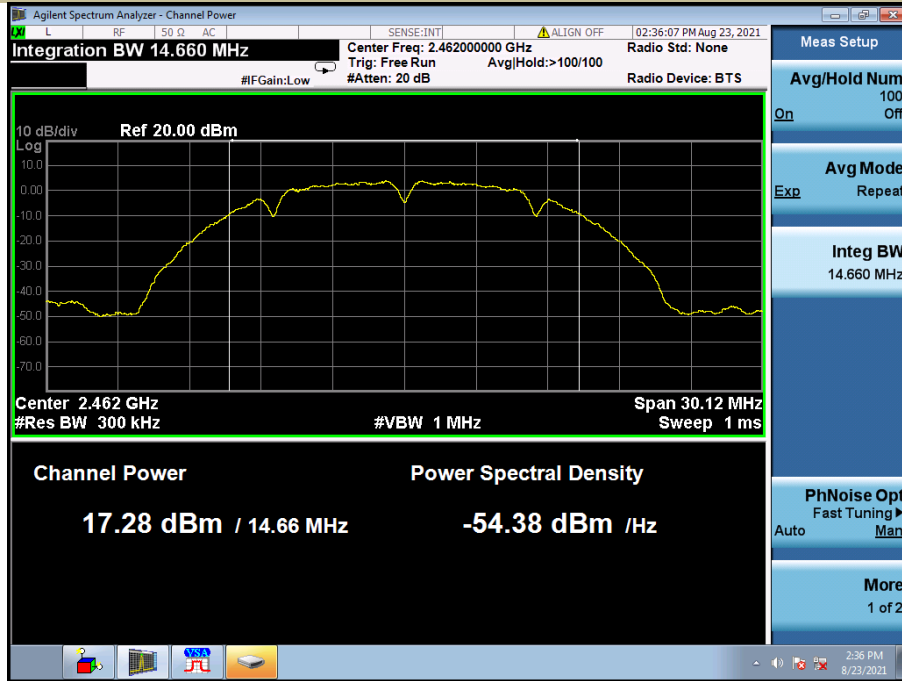

Test Model Maximum Conducted Output Power  
802.11g  
Channel 1: 2412MHz

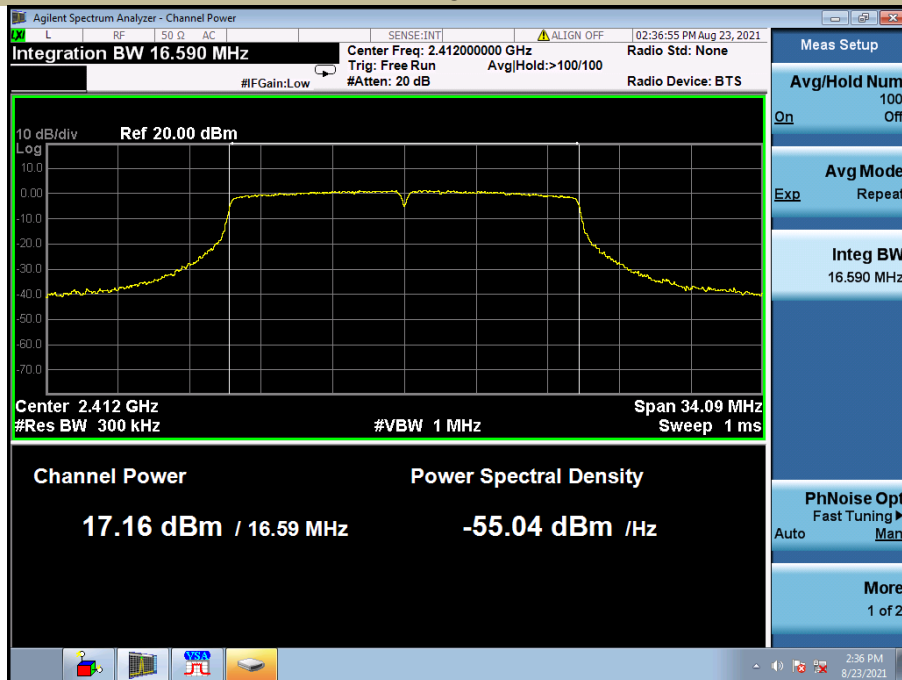

Test Model Maximum Conducted Output Power  
802.11g  
Channel 6: 2437MHz

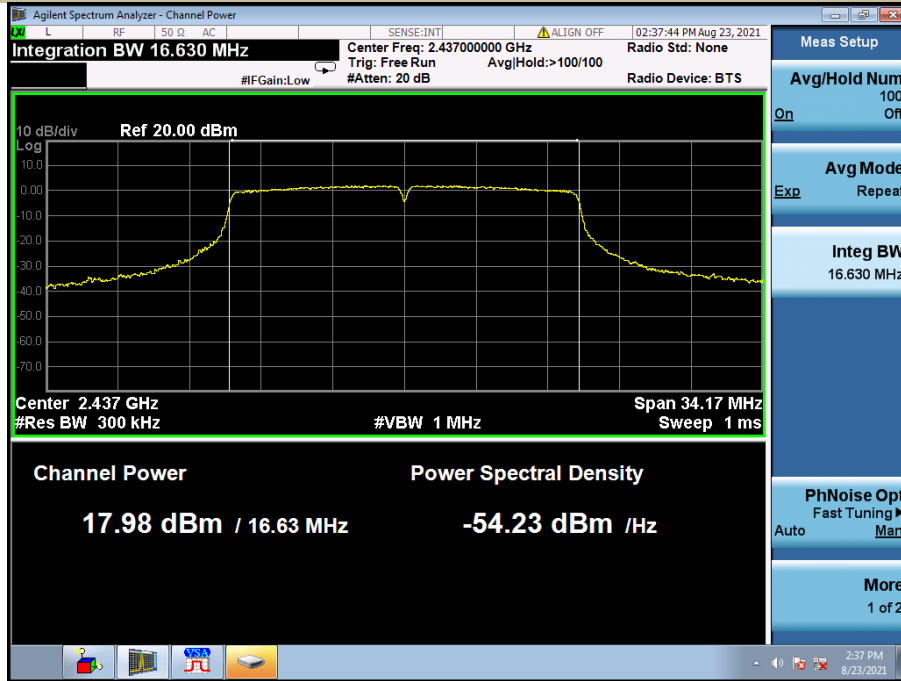

Test Model Maximum Conducted Output Power  
802.11g  
Channel 11: 2462MHz

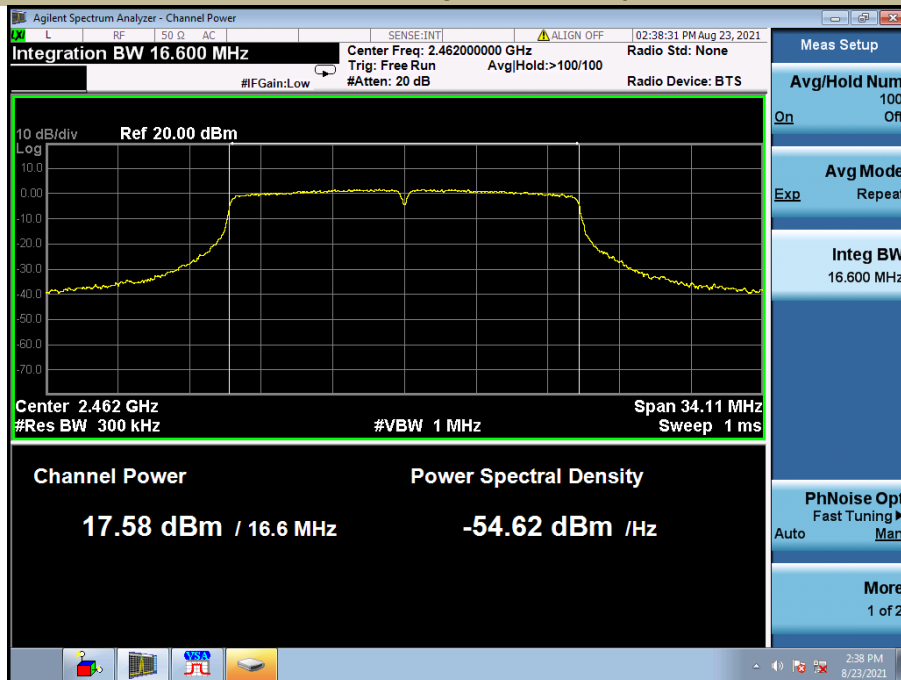

Test Model Maximum Conducted Output Power  
802.11n (HT20)  
Channel 1: 2412MHz

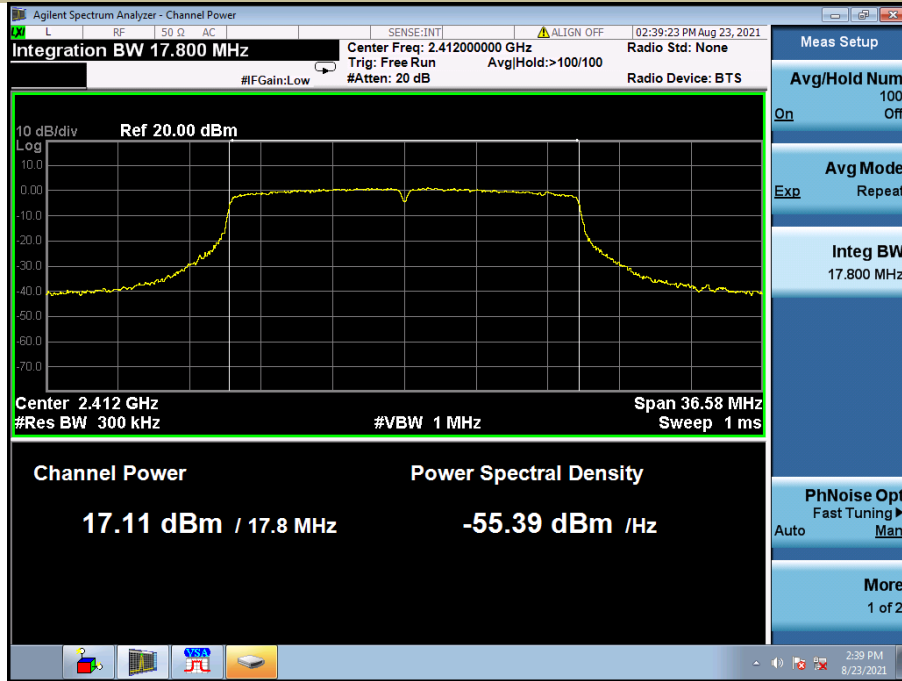

Test Model Maximum Conducted Output Power  
802.11n (HT20)  
Channel 6: 2437MHz

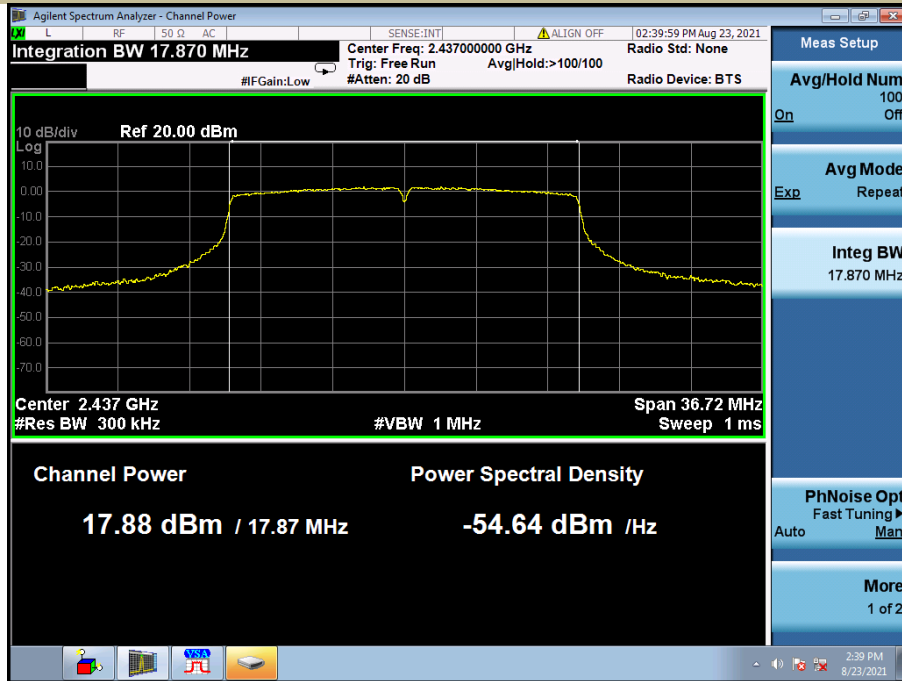

Test Model Maximum Conducted Output Power  
802.11n (HT20)  
Channel 11: 2462MHz

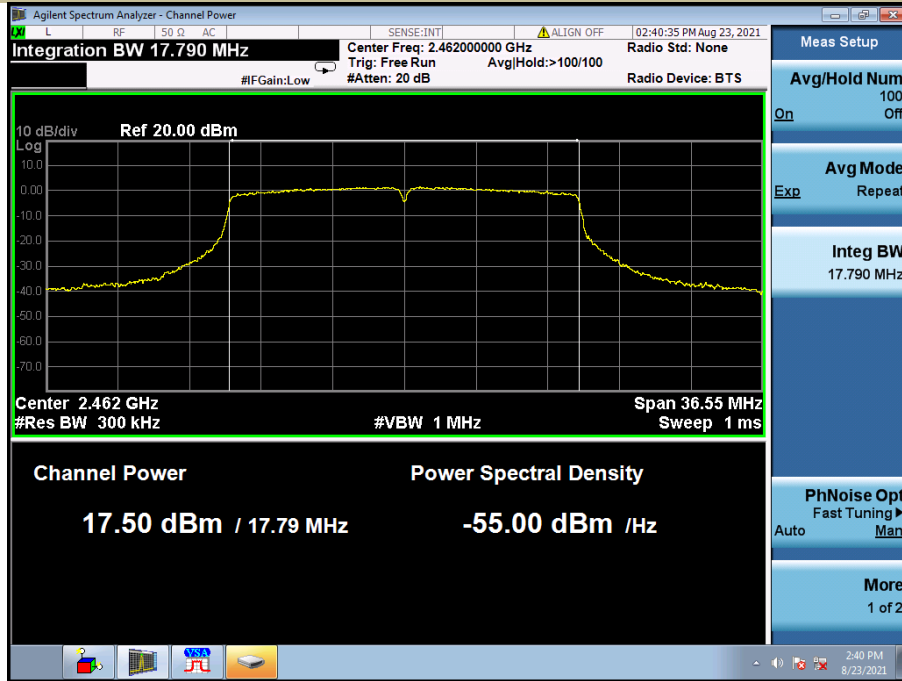

Test Model Maximum Conducted Output Power  
802.11n (HT40)  
Channel 3: 2422MHz

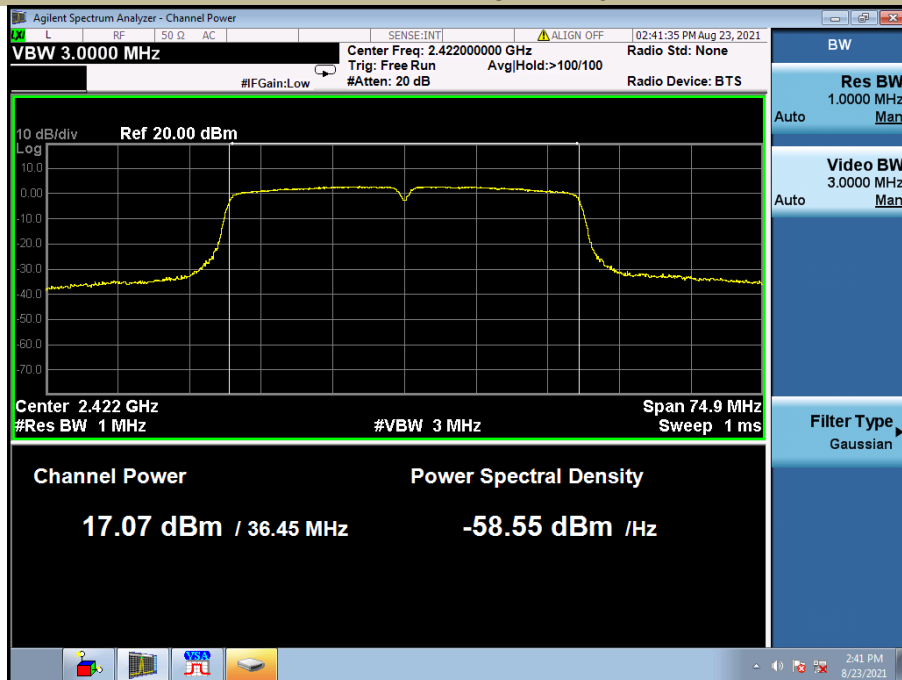

Test Model Maximum Conducted Output Power  
802.11n (HT40)  
Channel 6: 2437MHz

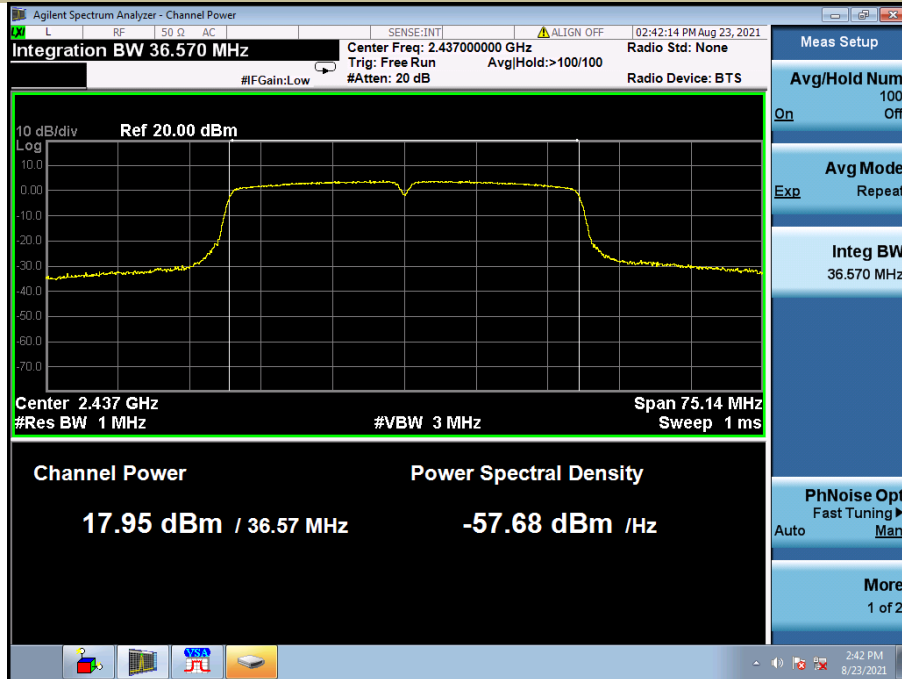

Test Model Maximum Conducted Output Power  
802.11n (HT40)  
Channel 9: 2452MHz

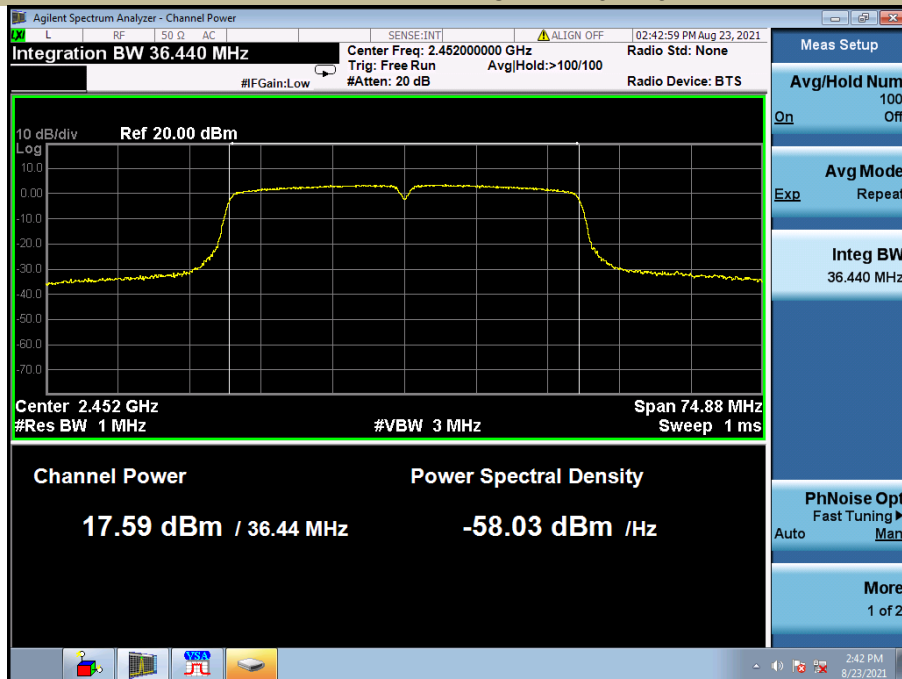

For 2T2R

Temperature : 26°C  
 Humidity : 55 %

ATM Pressure:: 1011 mbar  
 Test By: Lily

Operation Mode	Channel Number	Channel Frequency (MHz)	Measurement Level (dBm)	Limit (dBm)	Verdict
802.11n (HT20)	1	2412	19.08	28.9	PASS
	6	2437	20.07	28.9	PASS
	11	2462	19.69	28.9	PASS
802.11n (HT40)	3	2422	19.03	28.9	PASS
	6	2437	20.11	28.9	PASS
	9	2452	19.68	28.9	PASS

### 7.3 MAXIMUM POWER SPECTRAL DENSITY

#### 7.3.1 Applicable Standard

According to FCC Part15.247(e) and KDB 558074 D01 15.247 Meas Guidance v05r02

#### 7.3.2 Conformance Limit

The transmitter power spectral density conducted from the transmitter to the antenna shall not be greater than 8 dBm in any 3 kHz band during any time interval of continuous transmission. This power spectral density shall be determined in accordance with the provisions of section 5.4(d), (i.e. the power spectral density shall be determined using the same method as is used to determine the conducted output power).

#### 7.3.3 Test Configuration

Test according to clause 6.1 radio frequency test setup

#### 7.3.4 Test Procedure

This procedure shall be used if maximum peak conducted output power was used to demonstrate compliance

The transmitter output (antenna port) was connected to the spectrum analyzer

Set analyzer center frequency to DTS channel center frequency.

Set the span to 1.5 times the DTS bandwidth.

Set the RBW to: 3 kHz

Set the VBW to: 10 kHz.

Set Detector = peak.

Set Sweep time = auto couple.

Set Trace mode = max hold.

Allow trace to fully stabilize.

Use the peak marker function to determine the maximum amplitude level within the RBW.

#### 7.3.5 Test Results

For 1T1R

##### ANT 1

Temperature : 26°C ATM Pressure:: 1011 mbar

Humidity : 55 % Test By: Lily

Operation Mode	Channel Number	Channel Frequency (MHz)	Measurement Level (dBm/3kHz)	Limit (dBm/3kHz)	Verdict
802.11b	1	2412	-8.991	8	PASS
	6	2437	-8.443	8	PASS
	11	2462	-9.01	8	PASS
802.11g	1	2412	-10.842	8	PASS
	6	2437	-9.625	8	PASS
	11	2462	-9.458	8	PASS
802.11n (HT20)	1	2412	-10.489	8	PASS
	6	2437	-8.483	8	PASS
	11	2462	-9.516	8	PASS
802.11n (HT40)	3	2422	-12.366	8	PASS
	6	2437	-11.322	8	PASS
	9	2452	-11.639	8	PASS

Test Model Power Spectral Density  
802.11b  
Channel 1: 2412MHz



Test Model Power Spectral Density  
802.11b  
Channel 6: 2437MHz

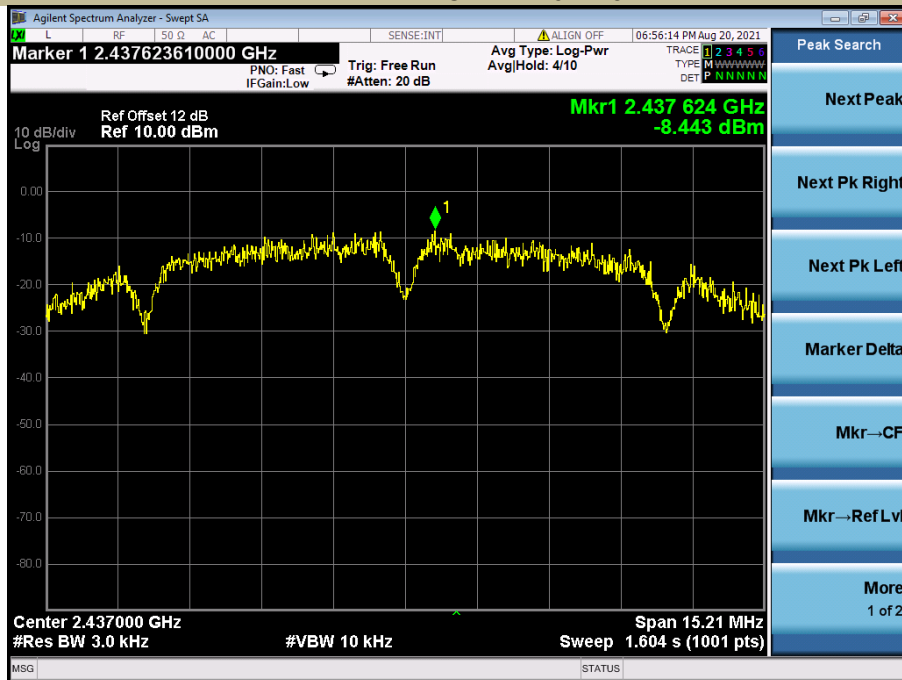



Test Model Power Spectral Density  
802.11b  
Channel 11: 2462MHz



Test Model Power Spectral Density  
802.11g  
Channel 1: 2412MHz

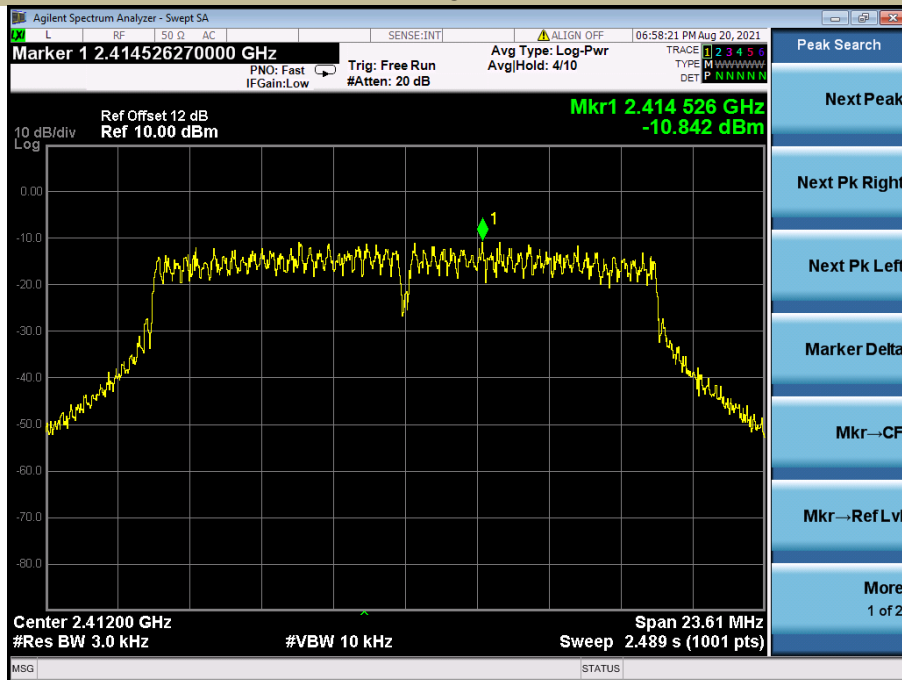

Test Model Power Spectral Density  
802.11g  
Channel 6: 2437MHz

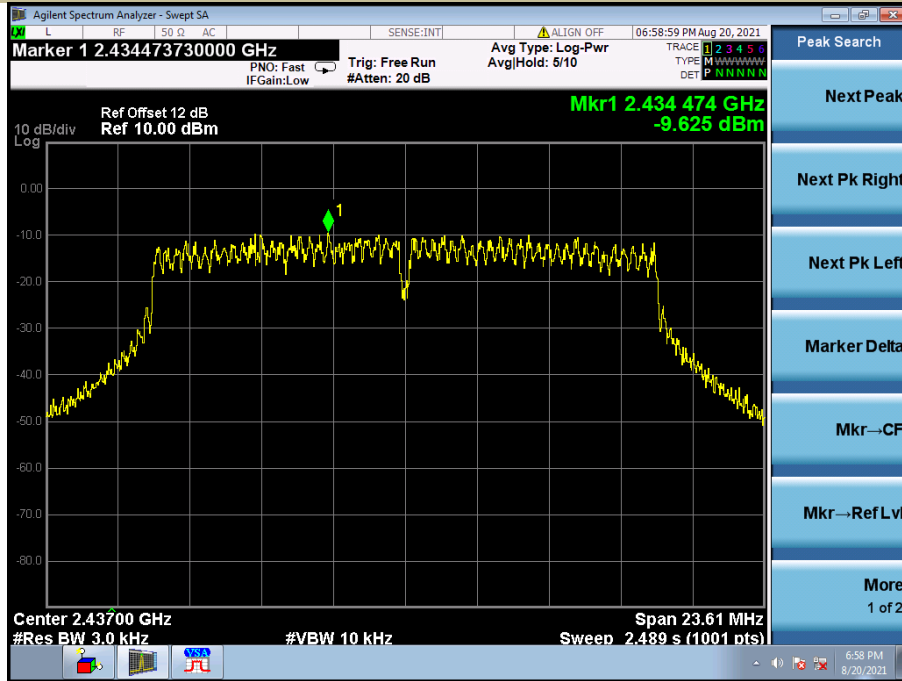

Test Model Power Spectral Density  
802.11g  
Channel 11: 2462MHz

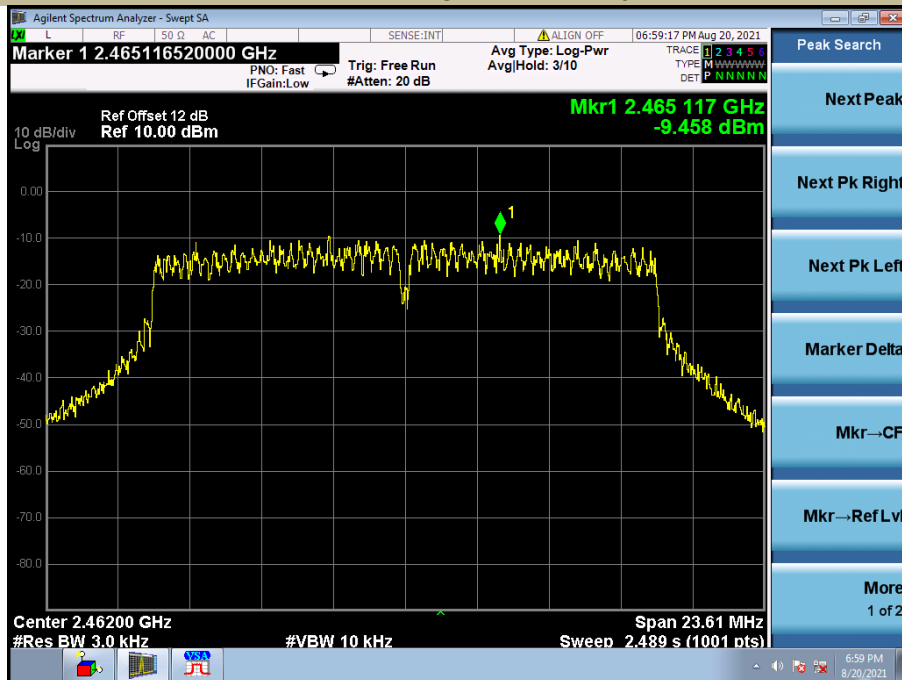

Test Model Power Spectral Density  
802.11n (HT20)  
Channel 1: 2412MHz

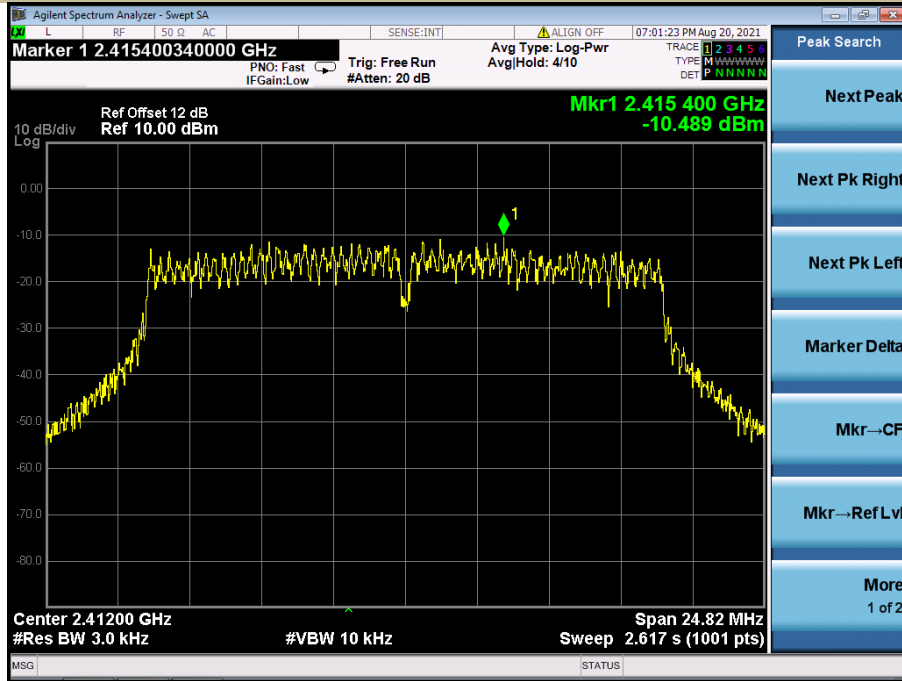

Test Model Power Spectral Density  
802.11n (HT20)  
Channel 6: 2437MHz

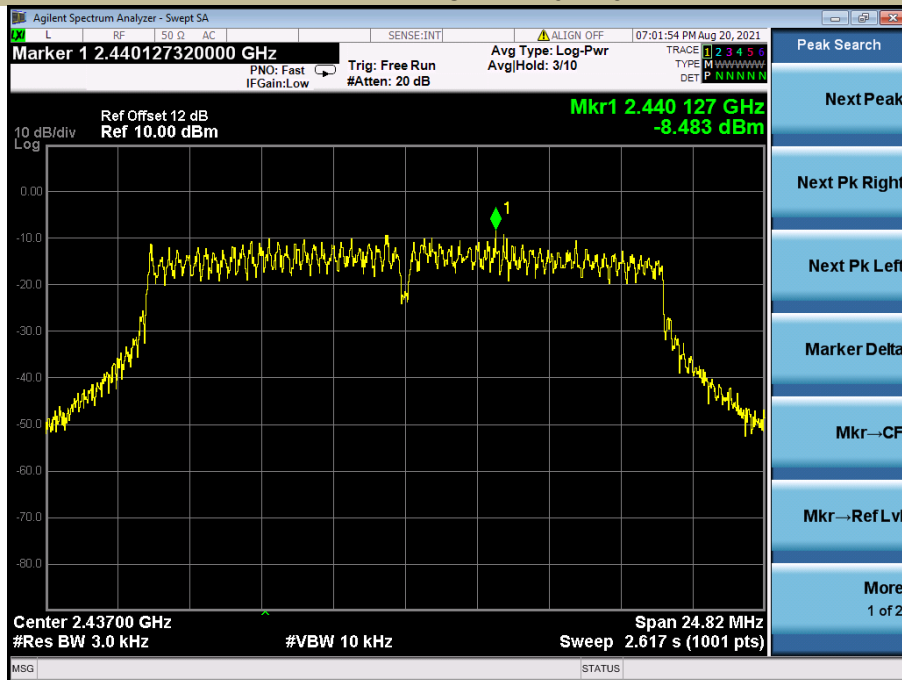

Test Model Power Spectral Density  
802.11n (HT20)  
Channel 11: 2462MHz

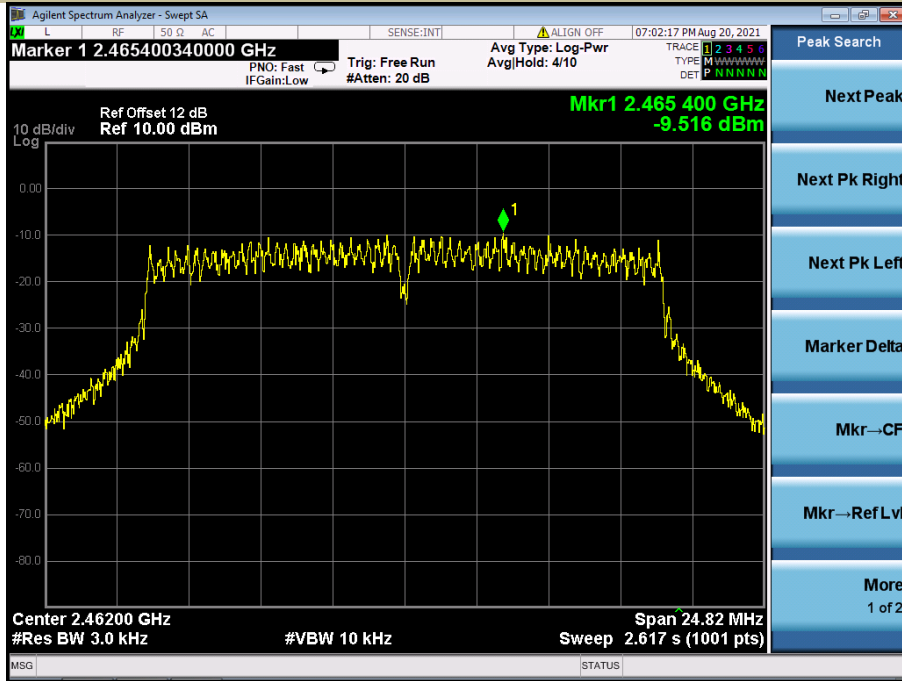

Test Model Power Spectral Density  
802.11n (HT40)  
Channel 3: 2422MHz

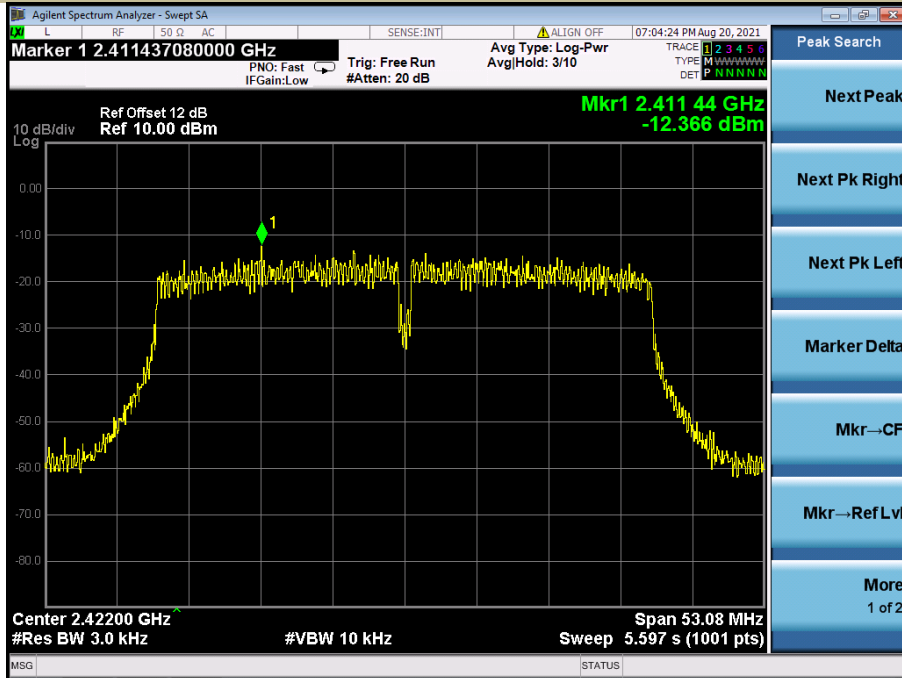

Test Model Power Spectral Density  
802.11n (HT40)  
Channel 6: 2437MHz

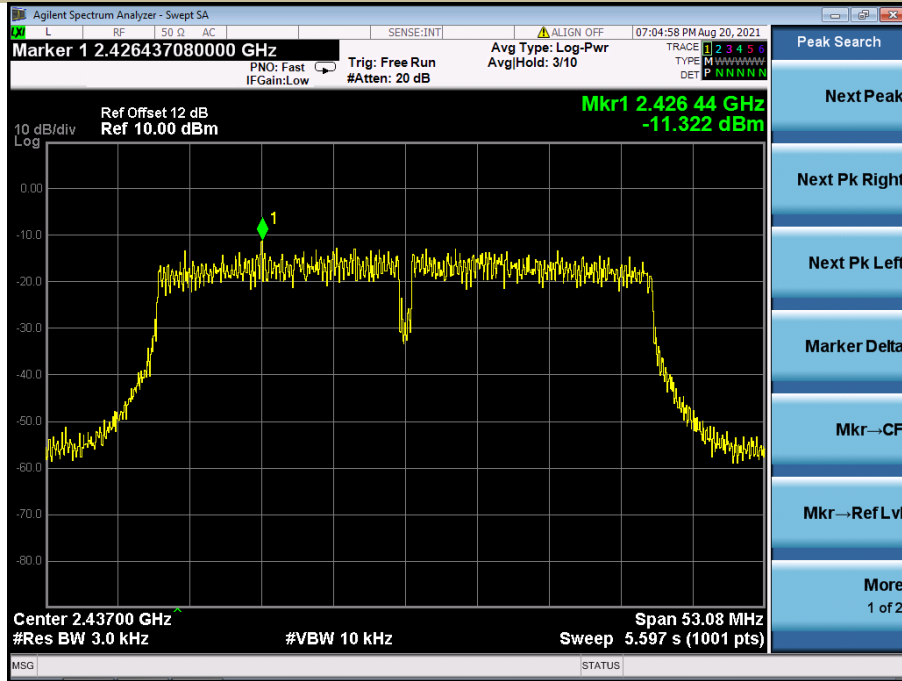

Test Model Power Spectral Density  
802.11n (HT40)  
Channel 9: 2452MHz

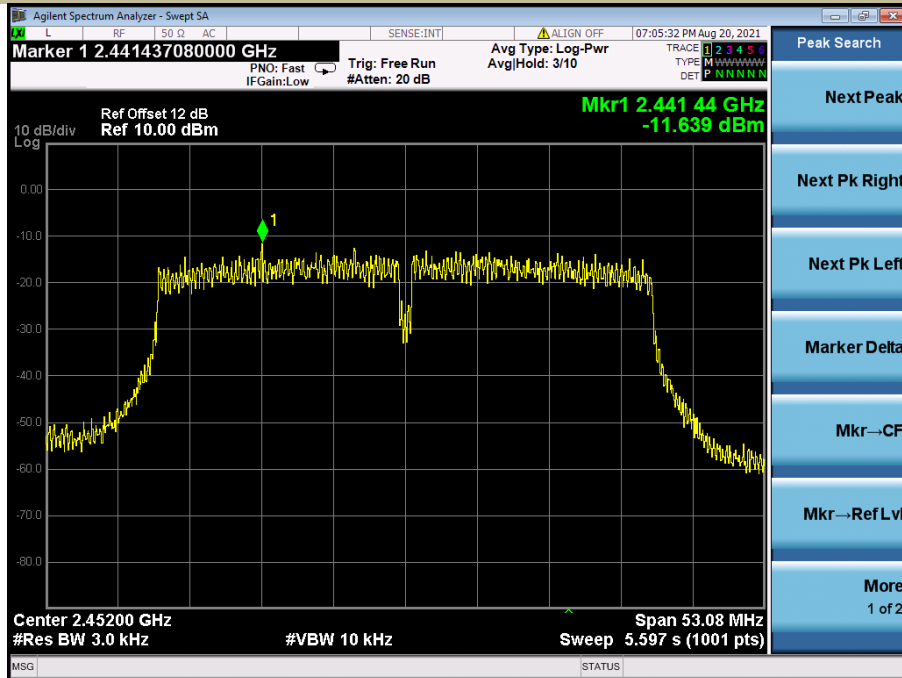

**ANT 2**

Temperature : 26°C      ATM Pressure:: 1011 mbar  
 Humidity : 55 %      Test By: Lily

Operation Mode	Channel Number	Channel Frequency (MHz)	Measurement Level (dBm/3kHz)	Limit (dBm/3kHz)	Verdict
802.11b	1	2412	-7.323	8	PASS
	6	2437	-5.537	8	PASS
	11	2462	-6.516	8	PASS
802.11g	1	2412	-8.120	8	PASS
	6	2437	-7.193	8	PASS
	11	2462	-7.895	8	PASS
802.11n (HT20)	1	2412	-7.792	8	PASS
	6	2437	-6.624	8	PASS
	11	2462	-7.982	8	PASS
802.11n (HT40)	3	2422	-11.441	8	PASS
	6	2437	-10.424	8	PASS
	9	2452	-10.402	8	PASS

Test Model Power Spectral Density  
802.11b  
Channel 1: 2412MHz



Test Model Power Spectral Density  
802.11b  
Channel 6: 2437MHz

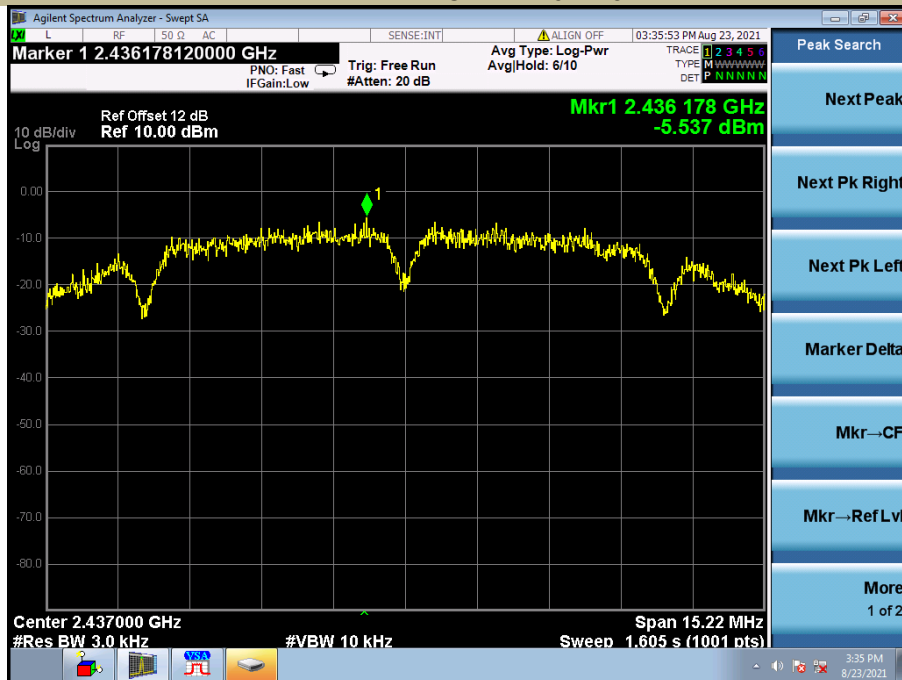

Test Model Power Spectral Density  
802.11b  
Channel 11: 2462MHz



Test Model Power Spectral Density  
802.11g  
Channel 1: 2412MHz

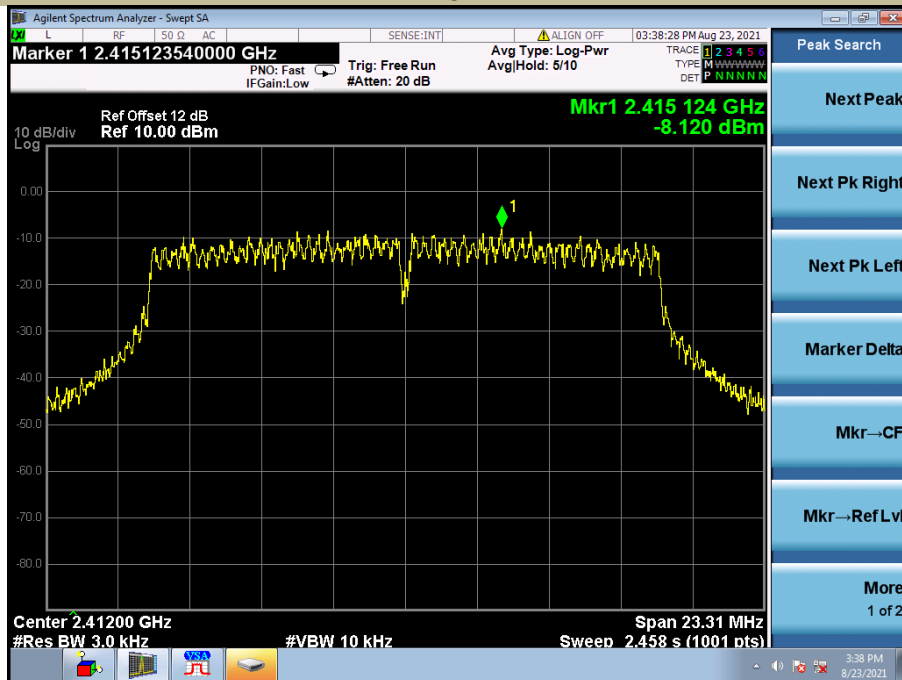



Test Model Power Spectral Density  
802.11g  
Channel 6: 2437MHz

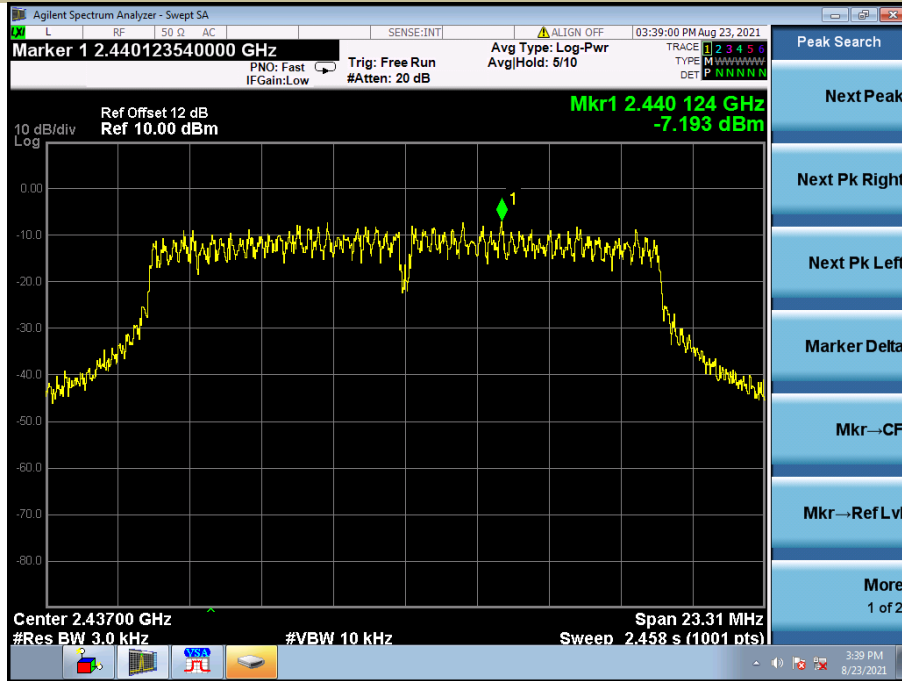

Test Model Power Spectral Density  
802.11g  
Channel 11: 2462MHz

