

# TEST REPORT

**Product Name** : Laser Projector  
**Model Number** : L166FGN, L166\*\*\*\*\* (\*=0-9, a-z, A-Z, - or blank, indicates for different market purposes)  
**FCC ID** : 2AZNP-L166FGN

**Prepared for** : Formovie (Chongqing) Innovative Technology Co., Ltd.  
**Address** : 4-401, #2 Longgang Road, Guojiatuo Area, Jiangbei District, Chongqing, China

**Prepared by** : EMTEK (SHENZHEN) CO., LTD.  
**Address** : Building 69, Majialong Industry Zone, Nanshan District, Shenzhen, Guangdong, China

Tel: (0755) 26954280  
Fax: (0755) 26954282

**Report Number** : ENS2403280299W00304R  
**Date(s) of Tests** : March 29, 2024 to April 27, 2024  
**Date of issue** : April 29, 2024

# 1 TEST RESULT CERTIFICATION

Applicant : Formovie (Chongqing) Innovative Technology Co., Ltd.  
 Address : 4-401, #2 Longgang Road, Guojiatuo Area, Jiangbei District, Chongqing, China  
 Manufacturer : Formovie (Chongqing) Innovative Technology Co., Ltd.  
 Address : 4-401, #2 Longgang Road, Guojiatuo Area, Jiangbei District, Chongqing, China  
 EUT : Laser Projector  
 Model Name : L166FGN, L166\*\*\*\*\* (\*=0-9, a-z, A-Z, - or blank, indicates for different market purposes)  
 Trademark : Formovie

Measurement Procedure Used:

APPLICABLE STANDARDS	
STANDARD	TEST RESULT
FCC 47 CFR Part 2, Subpart J FCC 47 CFR Part 15, Subpart E	PASS
IC RSS-GEN, Issue 5(04-2018)+A1(03-2019)+A2(02-2021) IC RSS-247 Issue 2(02-2017)	PASS

The above equipment was tested by EMTEK (SHENZHEN) CO., LTD. The test data, data evaluation, test procedures, and equipment configurations shown in this report were made in accordance with the procedures given in ANSI C63.10 (2013) and the energy emitted by the sample EUT tested as described in this report is in compliance with the requirements of FCC Rules Part 2, Part 15.407, IC RSS-247 Issue 2 and IC RSS-GEN, Issue 5.

The test results of this report relate only to the tested sample identified in this report.

Date of Test : March 29, 2024 to April 27, 2024

Prepared by :   
 Una Yu /Editor

Reviewer :   
 Joe Xia /Supervisor

Approve & Authorized Signer :   
 Lisa Wang/Manager



## Modified History

Version	Report No.	Revision Date	Summary
Ver.1.0	ENS2403280299W00304R	/	Original Report



## TABLE OF CONTENTS

<b>1</b>	<b>TEST RESULT CERTIFICATION .....</b>	<b>2</b>
<b>2</b>	<b>EUT TECHNICAL DESCRIPTION .....</b>	<b>5</b>
<b>3</b>	<b>SUMMARY OF TEST RESULT .....</b>	<b>7</b>
<b>4</b>	<b>TEST METHODOLOGY .....</b>	<b>8</b>
4.1	GENERAL DESCRIPTION OF APPLIED STANDARDS .....	8
4.2	MEASUREMENT EQUIPMENT USED .....	8
4.3	DESCRIPTION OF TEST MODES .....	8
<b>5</b>	<b>FACILITIES AND ACCREDITATIONS .....</b>	<b>13</b>
5.1	FACILITIES .....	13
5.2	EQUIPMENT .....	13
5.3	LABORATORY ACCREDITATIONS AND LISTINGS .....	13
<b>6</b>	<b>TEST SYSTEM UNCERTAINTY .....</b>	<b>14</b>
<b>7</b>	<b>SETUP OF EQUIPMENT UNDER TEST .....</b>	<b>15</b>
7.1	RADIO FREQUENCY TEST SETUP .....	15
7.2	RADIO FREQUENCY TEST SETUP .....	15
7.3	CONDUCTED EMISSION TEST SETUP .....	17
7.4	BLOCK DIAGRAM CONFIGURATION OF TEST SYSTEM .....	18
7.5	SUPPORT EQUIPMENT .....	18
<b>8</b>	<b>TEST REQUIREMENTS .....</b>	<b>19</b>
8.1	BANDWIDTH MEASUREMENT .....	19
8.2	MAXIMUM CONDUCTED OUTPUT POWER .....	219
8.3	MAXIMUM PEAK POWER DENSITY .....	401
8.4	UNDESIRABLE RADIATED SPURIOUS EMISSION .....	492
8.5	POWER LINE CONDUCTED EMISSIONS .....	521
8.6	ANTENNA APPLICATION .....	524

## 2 EUT TECHNICAL DESCRIPTION

Characteristics	Description
<b>Product:</b>	Laser Projector
<b>Model Number:</b>	L166FGN, L166***** (*=0-9, a-z, A-Z, - or blank, indicates for different market purposes) (Note: All models are identical in circuitry and electrical, mechanical and physical construction; the difference are model number for trading purpose. Mode L166FGN was Chosen final test.)
<b>Sample Number:</b>	2#
<b>Wifi Type:</b>	Wifi 5G with 5150MHz-5250MHz Band Wifi 5G with 5250MHz-5350MHz Band Wifi 5G with 5470MHz-5725MHz Band Wifi 5G with 5725MHz-5850MHz Band
<b>WLAN Supported:</b>	802.11a/n/ac/ax
<b>Data Rate :</b>	802.11a: 54/48/36/24/18/12/9/6Mbps 802.11n: MCS0-MCS15 802.11ac: MCS0-MCS9 802.11ax: MCS0-MCS11
<b>Modulation:</b>	OFDM with BPSK/QPSK/16QAM/64QAM for 802.11a/n OFDM with BPSK/QPSK/16QAM/64QAM/256QAM for 802.11ac OFDM with BPSK/QPSK/16QAM/64QAM/256QAM/1024QAM for 802.11ax
<b>Frequency Range:</b>	UNII-1: 5150MHz-5250MHz Band 5180-5240MHz for 802.11a/n(HT20)/ac(VHT20)/ax(HE20) 5190-5230MHz for 802.11n(HT40)/ac(VHT40)/ax(HE40) 5210MHz for 802.11ac(VHT80)/ax(HE80)
	UNII-2A: 5250MHz-5350MHz Band 5260-5320MHz for 802.11a/n(HT20)/ac(VHT20)/ax(HE20) 5270-5310MHz for 802.11n(HT40)/ac(VHT40)/ax(HE40) 5290MHz for 802.11ac(VHT80)/ax(HE80)
	UNII-2C: 5470MHz-5725MHz Band 5500-5700MHz for 802.11a/n(HT20)/ac(VHT20)/ax(HE20) 5510-5670MHz for 802.11n(HT40)/ac(VHT40)/ax(HE40) 5530MHz for 802.11ac(VHT80)/ax(HE80)
	UNII-3 with 5725MHz-5850MHz Band 5745-5825MHz for 802.11a/n(HT20)/ac(VHT20)/ax(HE20) 5755-5795MHz for 802.11n(HT40)/ac(VHT40)/ax(HE40) 5775MHz for 802.11ac(VHT80)/ax(HE80);
<b>TPC Function:</b>	Not Applicable
<b>Antenna Port:</b>	<input checked="" type="checkbox"/> Antenna port 1 <input checked="" type="checkbox"/> Antenna port 2
<b>Antenna Type:</b>	FPC Antenna

<b>Antenna Gain:</b>	ANT 1: 5.15 dBi ANT 2: 5.37 dBi
<b>Transmit Power:</b>	UNII-1 Band: 16.02 dBm UNII-2A Band: 15.90 dBm UNII-2C Band: 16.83 dBm UNII-3 Band: 15.88 dBm
<b>Test Voltage:</b>	AC 120V/60Hz
<b>Date of Received:</b>	March 28, 2024
<b>Temperature Range:</b>	0°C ~ +40°C
<b>FVIN:</b>	V7
<b>Note:</b> 1.For more details, please refer to the User's manual of the EUT.	



### 3 SUMMARY OF TEST RESULT

FCC Part Clause	IC Part Clause	Test Parameter	Verdict	Remark
15.407 (a) 15.407 (e) 2.1049	RSS-247, 6.2 RSS-Gen 6.7	99% , 6dB and 26dB Bandwidth	PASS	
15.407 (a)	RSS-247, 6.2	Maximum Conducted Output Power	PASS	
15.407 (a)	RSS-247, 6.2	PeakPower Spectral Density	PASS	
15.407 (b) 15.209 15.205	RSS-247, 6.2 RSS-Gen 8.9 RSS-Gen 8.10 RSS-Gen 6.13	RadiatedSpurious Emission	PASS	
15.207	RSS-Gen 8.8	Power Line Conducted Emission	PASS	
15.407(a) 15.203	RSS-Gen 6.8	Antenna Application	PASS	
NOTE1:N/A (Not Applicable) NOTE2:According to FCC OET KDB 789033, the report use radiated measurements in the restricted frequency bands. In addition, the radiated test is also performed to ensure the emissions emanating from the device cabinet also comply with the applicable limits.				

RELATED SUBMITTAL(S) / GRANT(S):

This submittal(s) (test report) is intended for **FCC ID:2AZNP-L166FGN** filing to comply with Section 15.407 of the FCC Part 15, Subpart C Rules.

## 4 TEST METHODOLOGY

### 4.1 GENERAL DESCRIPTION OF APPLIED STANDARDS

According to its specifications, the EUT must comply with the requirements of the following standards:

FCC 47 CFR Part 2, Subpart J

FCC 47 CFR Part 15, Subpart E

IC RSS-GEN, Issue 5(04-2018)+A1(03-2019)+A2(02-2021)

IC RSS-247 Issue 2(02-2017)

FCC KDB 662911 D01 Multiple Transmitter Output v02r01

FCC KDB 789033 D2 General UNII Test Procedures New Rules v02r01

### 4.2 MEASUREMENT EQUIPMENT USED

#### Conducted Emission Test Equipment

Equipment	Manufacturer	Model No.	Serial No.	Last Cal.	Cal. Interval
EMI Test Receiver	Rohde & Schwarz	ESCI	101384	2023/5/13	1Year
AMN	Rohde & Schwarz	ENV216	101161	2023/5/13	1Year

#### For Spurious Emissions Test

Equipment	Manufacturer	Model No.	Serial No.	Last Cal.	Cal. Interval
EMI Test Receiver	Rohde & Schwarz	ESU 26	100154	2023/5/13	1Year
Pre-Amplifie	Lunar EM	LNA30M3G-25	J10100000070	2023/5/13	1Year
Bilog Antenna	Schwarzbeck	VULB9163	660	2023/5/16	2 Year
Horn antenna	Schwarzbeck	BBHA9120D	9120D-1177	2023/5/12	2 Year
Pre-Amplifie	SKET	LNPA_0118G-45	SK2019051801	2023/5/10	1Year
Loop Antenna	Schwarzbeck	FMZB1519	1519-012	2023/5/12	2 Year
Spectrum Analyzer	Rohde & Schwarz	FSV40	100967	2023/5/10	1Year
Horn antenna	Schwarzbeck	BBHA9170	9170-399	2023/5/12	2 Year
Band reject Filter(50dB)	WI/DE	WRCGV-2400(2400-2485MHz)	2	2023/5/13	1 Year

#### For other test items:

Equipment	Manufacturer	Model No.	Serial No.	Last Cal.	Cal. Interval
Wideband Radio Communication Tester	R&S	CMW500	171168	2023/9/14	1Year
Frequency Extender	R&S	CMW-Z800A	100430	2023/11/2	1Year
Spectrum Analyzer	R&S	FSV3044	101289	2023/9/14	1Year
Analog Signal Generator	R&S	SMB100A	183237	2023/9/16	1Year
Vector Signal Generator	R&S	SMM100A	101808	2023/9/16	1Year
RF Control Unit(Power Meter)	Tonscend	JS0806-2	22C8060567	2023/9/14	1Year
Temperature&Humidity Chamber	ESPEC	EL-02KA	12107166	2023/5/10	1 Year



### 4.3 DESCRIPTION OF TEST MODES

The EUT has been tested under its typical operating condition.

The EUT configuration for testing is installed on RF field strength measurement to meet the Commissions requirement and operating in a manner which intends to maximize its emission characteristics in a continuous normal application.

The Transmitter was operated in the normal operating mode. The TX frequency was fixed which was for the purpose of the measurements.

Test of channel included the lowest and middle and highest frequency to perform the test, then record on this report.

Those data rates (802.11a: 54 Mbps; 802.11n(HT20): MCS0; 802.11ac(VHT20): MCS0; 802.11ax(HE20): MCS0; 802.11n(HT40): MCS0; 802.11ac(VHT40): MCS0; 802.11ax(HE40): MCS0; 802.11ac(VHT80): MCS0; 802.11ax(HE80): MCS; 802.11ac(VHT160): MCS0; 802.11ax(HE160): MCS) were used for all test.

Pre-defined engineering program for regulatory testing used to control the EUT for staying in continuous transmitting and receiving mode is programmed.

Wifi 5G with U-NII - 1

Frequency and Channel list for 802.11a, 802.11n (HT20), 802.11ac (VHT20), 802.11ax (HE20):

Channel	Frequency (MHz)	Channel	Frequency (MHz)	Channel	Frequency (MHz)
36	5180	44	5220		
40	5200	48	5240		

Frequency and Channel list for 802.11n (HT40), 802.11ac (VHT40), 802.11ax (HE40):

Channel	Frequency (MHz)	Channel	Frequency (MHz)	Channel	Frequency (MHz)
38	5190	46	5230		

Frequency and Channel list for 802.11ac (VHT80), 802.11ax (HE80):

Channel	Frequency (MHz)	Channel	Frequency (MHz)	Channel	Frequency (MHz)
42	5210				

**Test** Frequency and Channel for 802.11a, 802.11n (HT20), 802.11ac (VHT20), 802.11ax (HE20):

Lowest Frequency		Middle Frequency		Highest Frequency	
Channel	Frequency (MHz)	Channel	Frequency (MHz)	Channel	Frequency (MHz)
36	5180	40	5200	48	5240

**Test** Frequency and channel for 802.11n (HT40), 802.11ac (VHT40), 802.11ax (HE40):

Lowest Frequency		Middle Frequency		Highest Frequency	
Channel	Frequency (MHz)	Channel	Frequency (MHz)	Channel	Frequency (MHz)
38	5190	N/A	N/A	46	5230

**Test** Frequency and channel for 802.11ac (VHT80), 802.11ax (HE80):

Lowest Frequency		Middle Frequency		Highest Frequency	
Channel	Frequency (MHz)	Channel	Frequency (MHz)	Channel	Frequency (MHz)
42	5210	N/A	N/A	N/A	N/A

Wifi 5G with U-NII -2A

Frequency and Channel list 802.11a, 802.11n (HT20), 802.11ac (VHT20), 802.11ax (HE20):

Channel	Frequency (MHz)	Channel	Frequency (MHz)	Channel	Frequency (MHz)
52	5260	60	5300		
56	5280	64	5320		

Frequency and Channel list for 802.11n (HT40), 802.11ac (VHT40), 802.11ax (HE40):

Channel	Frequency (MHz)	Channel	Frequency (MHz)	Channel	Frequency (MHz)
54	5270				
62	5310				

Frequency and Channel list for 802.11ac (VHT80), 802.11ax (HE80):

Channel	Frequency (MHz)	Channel	Frequency (MHz)	Channel	Frequency (MHz)
58	5290				

Test Frequency and Channel for 802.11a, 802.11n (HT20), 802.11ac (VHT20), 802.11ax (HE20):

Lowest Frequency		Middle Frequency		Highest Frequency	
Channel	Frequency (MHz)	Channel	Frequency (MHz)	Channel	Frequency (MHz)
52	5260	56	5280	64	5320

Test Frequency and channel for 802.11n (HT40), 802.11ac (VHT40), 802.11ax (HE40):

Lowest Frequency		Middle Frequency		Highest Frequency	
Channel	Frequency (MHz)	Channel	Frequency (MHz)	Channel	Frequency (MHz)
54	5270	N/A	N/A	62	5310

Test Frequency and channel for 802.11ac (VHT80), 802.11ax (HE80):

Lowest Frequency		Middle Frequency		Highest Frequency	
Channel	Frequency (MHz)	Channel	Frequency (MHz)	Channel	Frequency (MHz)
58	5290				

Wifi 5G with U-NII -2C

Frequency and Channel list for 802.11a, 802.11n (HT20), 802.11ac (VHT20), 802.11ax (HE20):

Channel	Frequency (MHz)	Channel	Frequency (MHz)	Channel	Frequency (MHz)
100	5500	116	5580	132	5660
104	5520	120	5600	136	5680
108	5540	124	5620	140	5700
112	5560	128	5640		

Frequency and Channel list for 802.11n (HT40), 802.11ac (VHT40), 802.11ax (HE40):

Channel	Frequency (MHz)	Channel	Frequency (MHz)	Channel	Frequency (MHz)
102	5510	118	5590	134	5670
110	5550	126	5630		

Frequency and Channel list for 802.11ac (VHT80), 802.11ax (HE80):

Channel	Frequency (MHz)	Channel	Frequency (MHz)	Channel	Frequency (MHz)
106	5530	122	5610		

**Test** Frequency and Channel for 802.11a, 802.11n (HT20), 802.11ac (VHT20), 802.11ax (HE20):

Lowest Frequency		Middle Frequency		Highest Frequency	
Channel	Frequency (MHz)	Channel	Frequency (MHz)	Channel	Frequency (MHz)
100	5500	120	5600	140	5700

**Test** Frequency and channel for 802.11n (HT40), 802.11ac (VHT40), 802.11ax (HE40):

Lowest Frequency		Middle Frequency		Highest Frequency	
Channel	Frequency (MHz)	Channel	Frequency (MHz)	Channel	Frequency (MHz)
102	5510			134	5670

**Test** Frequency and channel for 802.11ac (VHT80), 802.11ax (HE80):

Lowest Frequency		Middle Frequency		Highest Frequency	
Channel	Frequency (MHz)	Channel	Frequency (MHz)	Channel	Frequency (MHz)
106	5530				

Wifi 5G with U-NII -3

Frequency and Channel list for 802.11a, 802.11n (HT20), 802.11ac (VHT20), 802.11ax (HE20):

Channel	Frequency (MHz)	Channel	Frequency (MHz)	Channel	Frequency (MHz)
149	5745	157	5785	165	5825
153	5765	161	5805		

Frequency and Channel list for 802.11n (HT40), 802.11ac (VHT40), 802.11ax (HE40):

Channel	Frequency (MHz)	Channel	Frequency (MHz)	Channel	Frequency (MHz)
151	5755	159	5795		

Frequency and Channel list for 802.11ac (VHT80), 802.11ax (HE80):

Channel	Frequency (MHz)	Channel	Frequency (MHz)	Channel	Frequency (MHz)
155	5775				

Test Frequency and Channel for 802.11a, 802.11n (HT20), 802.11ac (VHT20), 802.11ax (HE20):

Lowest Frequency		Middle Frequency		Highest Frequency	
Channel	Frequency (MHz)	Channel	Frequency (MHz)	Channel	Frequency (MHz)
149	5745	157	5785	165	5825

Test Frequency and channel for 802.11n (HT40), 802.11ac (VHT40), 802.11ax (HE40):

Lowest Frequency		Middle Frequency		Highest Frequency	
Channel	Frequency (MHz)	Channel	Frequency (MHz)	Channel	Frequency (MHz)
151	5755	N/A	N/A	159	5795

Test Frequency and channel for 802.11ac (VHT80), 802.11ax (HE80):

Lowest Frequency		Middle Frequency		Highest Frequency	
Channel	Frequency (MHz)	Channel	Frequency (MHz)	Channel	Frequency (MHz)
155	5775				

Multi-antenna correlation:

<input checked="" type="checkbox"/>	Transmit Signals are Correlated
	Directional gain = $10 \log[(10^{G1/20} + 10^{G2/20} + \dots + 10^{GN/20})^2 / N_{ANT}]$ dBi
<input type="checkbox"/>	All Transmit Signals are Completely Uncorrelated
	Directional gain = $10 \log[(10^{G1/10} + 10^{G2/10} + \dots + 10^{GN/10}) / N_{ANT}]$ dBi

Directional gain =  $10 \log [(10^{5.15/20} + 10^{5.37/20})^2 / 2]$  dBi=8.37 dBi

## 5 FACILITIES AND ACCREDITATIONS

### 5.1 FACILITIES

All measurement facilities used to collect the measurement data are located at:

EMTEK (Shenzhen) Co., Ltd.

Building 69, Majialong Industry Zone District, Nanshan District, Shenzhen, China

The sites are constructed in conformance with the requirements of ANSI C63.7, ANSI C63.4 and CISPR Publication 22.

### 5.2 EQUIPMENT

Radiated emissions are measured with one or more of the following types of linearly polarized antennas: tuned dipole, biconical, log periodic, bi-log, and/or ridged waveguide, horn. Spectrum analyzers with preselectors and quasi-peak detectors are used to perform radiated measurements.

Conducted emissions are measured with Line Impedance Stabilization Networks and EMI Test Receivers.

Calibrated wideband preamplifiers, coaxial cables, and coaxial attenuators are also used for making measurements.

All receiving equipment conforms to CISPR Publication 16-1, "Radio Interference Measuring Apparatus and Measurement Methods."

### 5.3 LABORATORY ACCREDITATIONS AND LISTINGS

#### Site Description

EMC Lab. : **Accredited by CNAS**  
 The Certificate Registration Number is L2291.  
 The Laboratory has been assessed and proved to be in compliance with CNAS-CL01 (identical to ISO/IEC 17025:2017)

**Accredited by FCC**  
 Designation Number: CN1204  
 Test Firm Registration Number: 882943

**Accredited by A2LA**  
 The Certificate Number is 4321.01.

Accredited by Industry Canada  
 The Conformity Assessment Body Identifier is CN0008

Name of Firm : EMTEK (SHENZHEN) CO., LTD.

Site Location : Building 69, Majialong Industry Zone,  
 Nanshan District, Shenzhen, Guangdong, China

## 6 TEST SYSTEM UNCERTAINTY

The following measurement uncertainty levels have been estimated for tests performed on the apparatus:

Test Parameter	Measurement Uncertainty
Frequency error	$\pm 20\text{Hz}$
Occupied Bandwidth	$\pm 0.5\text{KHz}$
Transmitter output power	$\pm 0.6\text{dB}$
Conducted spurious emissions	$\pm 3.2\text{dB}$
Radiated spurious emissions	$\pm 4.5\text{dB}$
Temperature	$\pm 1.2^\circ\text{C}$
Humidity	$\pm 3\%$
DC voltages	$\pm 0.25\text{V}$
Time	$\pm 1\%$

Measurement Uncertainty for a level of Confidence of 95%

## 7 SETUP OF EQUIPMENT UNDER TEST

### 7.1 RADIO FREQUENCY TEST SETUP

The WLAN component's antenna ports(s) of the EUT are connected to the measurement instrument per an appropriate attenuator. The EUT is controlled by PC/software to emit the specified signals for the purpose of measurements.

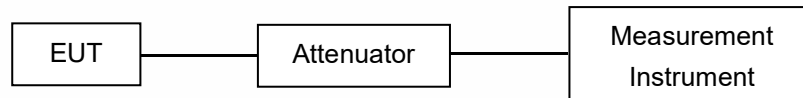

### 7.2 RADIO FREQUENCY TEST SETUP

The test site semi-anechoic chamber has met the requirement of NSA tolerance 4 dB according to the standards: ANSI C63.10. The test distance is 3m. The setup is according to the requirements in Section 13.1.4.1 of ANSI C63.10-2013 and CAN/CSA-CEI/IEC CISPR 22.

Below 30MHz:

The EUT is placed on a turntable 0.8 meters above the ground in the chamber, 3 meter away from the antenna (loop antenna). The Antenna should be positioned with its plane vertical at the specified distance from the EUT and rotated about its vertical axis for maximum response at each azimuth about the EUT. The center of the loop shall be 1 m above the ground. For certain applications, the loop antenna plane may also need to be positioned horizontally at the specified distance from the EUT.

Above 30MHz:

The EUT is placed on a turntable 0.8 meters above the ground in the chamber, 3 meter away from the antenna. The maximal emission value is acquired by adjusting the antenna height, polarisation and turntable azimuth. Normally, the height range of antenna is 1 m to 4 m, the azimuth range of turntable is 0° to 360°, and the receive antenna has two polarizations Vertical (V) and Horizontal (H).

Above 1GHz:

(Note: the FCC's permission to use 1.5m as an alternative per TCBC Conf call of Dec. 2, 2014.)

The EUT is placed on a turntable 1.5 meters above the ground in the chamber, 3 meter away from the antenna. The maximal emission value is acquired by adjusting the antenna height, polarisation and turntable azimuth. Normally, the height range of antenna is 1 m to 4 m, the azimuth range of turntable is 0° to 360°, and the receive antenna has two polarizations Vertical (V) and Horizontal (H).

(a) Radiated Emission Test Set-Up, Frequency Below 30MHz

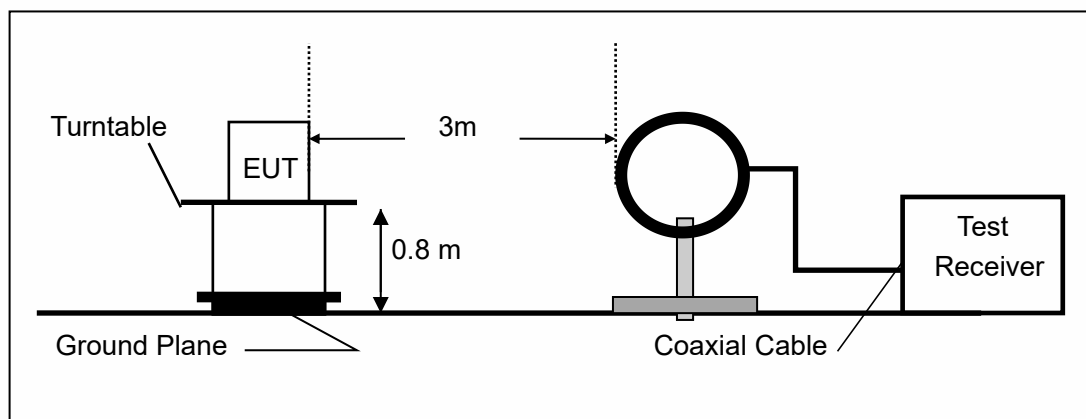

(b) Radiated Emission Test Set-Up, Frequency Below 1000MHz

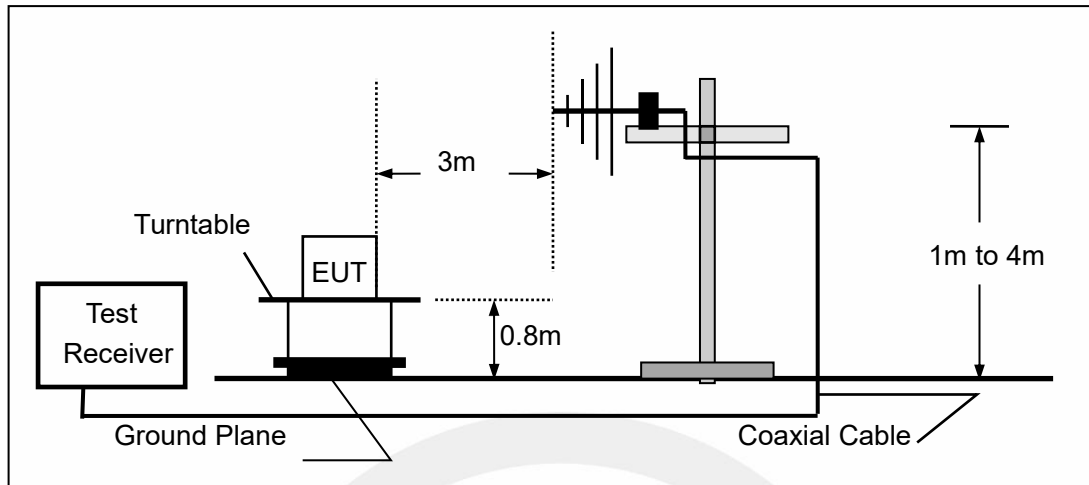

(c) Radiated Emission Test Set-Up, Frequency above 1000MHz

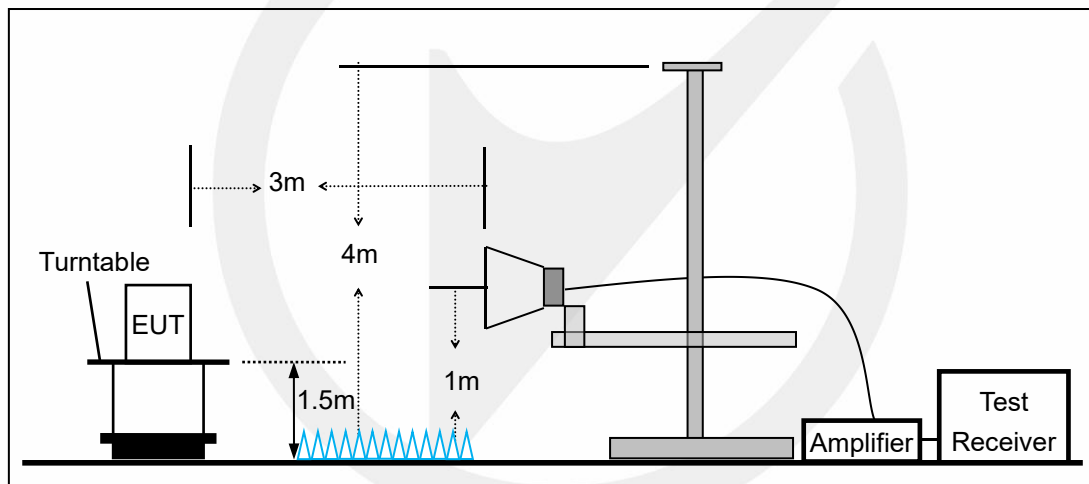



### 7.3 CONDUCTED EMISSION TEST SETUP

The mains cable of the EUT (maybe per AC/DC Adapter) must be connected to LISN. The LISN shall be placed 0.8 m from the boundary of EUT and bonded to a ground reference plane for LISN mounted on top of the ground reference plane. This distance is between the closest points of the LISN and the EUT. All other units of the EUT and associated equipment shall be at least 0.8m from the LISN.

Ground connections, where required for safety purposes, shall be connected to the reference ground point of the LISN and, where not otherwise provided or specified by the manufacturer, shall be of same length as the mains cable and run parallel to the mains connection at a separation distance of not more than 0.1 m.

According to the requirements in Section 13.1.4.1 of ANSI C63.10-2013 Conducted emissions from the EUT measured in the frequency range between 0.15 MHz and 30 MHz using CISPR Quasi-Peak and average detector mode.

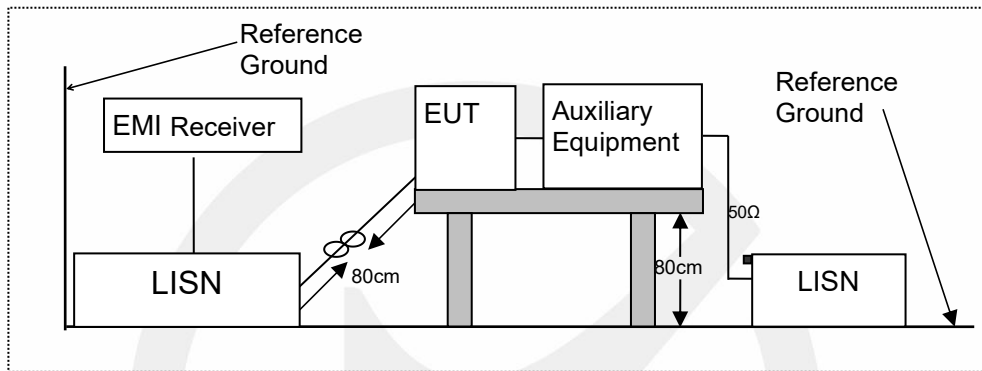

### 7.4 BLOCK DIAGRAM CONFIGURATION OF TEST SYSTEM

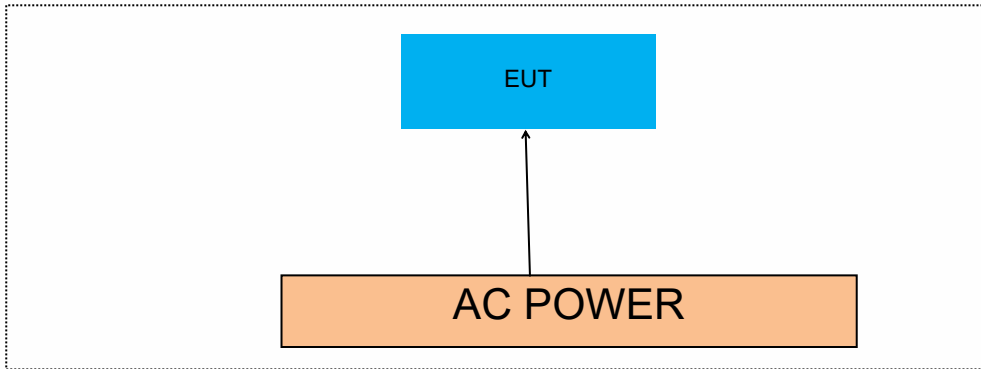

### 7.5 SUPPORT EQUIPMENT

EUT Cable List and Details			
Cable Description	Length (m)	Shielded/Unshielded	With / Without Ferrite
/	/	/	/

Auxiliary Cable List and Details			
Cable Description	Length (m)	Shielded/Unshielded	With / Without Ferrite
/	/	/	/

Auxiliary Equipment List and Details			
Description	Manufacturer	Model	Serial Number
/	/	/	/

**Notes:**

1. All the equipment/cables were placed in the worst-case configuration to maximize the emission during the test.
2. Grounding was established in accordance with the manufacturer's requirements and conditions for the intended use.

## 8 TEST REQUIREMENTS

### 8.1 BANDWIDTH MEASUREMENT

#### 8.1.1 Applicable Standard

According to FCC Part 15.407(a)(1) for UNII Band I  
According to FCC Part 15.407(a)(2) for UNII Band II-A and UNII Band II-C  
According to FCC Part 15.407(a)(3) for UNII Band III  
According to FCC Part 15.407(e) for UNII Band III  
According to 789033 D02 Section II(C)  
According to 789033 D02 Section II(D)  
According to RSS-Gen6.6, RSS 247, 6.2

#### 8.1.2 Conformance Limit

The 26dB bandwidth is used to determine the conducted power limits.  
Within the 5.725-5.85 GHz band, the minimum 6 dB bandwidth of U-NII devices shall be at least 500 kHz.

#### 8.1.3 Test Configuration

Test according to clause 7.1 radio frequency test setup

#### 8.1.4 Test Procedure

According to 789033 D02 v02r01 section C&D, the following is the measurement procedure.

##### 1. Emission Bandwidth (EBW)

- a) Set RBW = approximately 1% of the emission bandwidth.
- b) Set the VBW > RBW.
- c) Detector = Peak.
- d) Trace mode = max hold.
- e) Measure the maximum width of the emission that is 26 dB down from the maximum of the emission. Compare this with the RBW setting of the analyzer. Readjust RBW and repeat measurement as needed until the RBW/EBW ratio is approximately 1%.

##### 2. Minimum Emission Bandwidth for the band 5.725-5.85 GHz

Section 15.407(e) specifies the minimum 6 dB emission bandwidth of at least 500 KHz for the band 5.715-5.85 GHz. The following procedure shall be used for measuring this bandwidth:

- a) Set RBW = 100 kHz.
- b) Set the video bandwidth (VBW)  $\geq 3 \times$  RBW.
- c) Detector = Peak.
- d) Trace mode = max hold.
- e) Sweep = auto couple.
- f) Allow the trace to stabilize.
- g) Measure the maximum width of the emission that is constrained by the frequencies associated with the two outermost amplitude points (upper and lower frequencies) that are attenuated by 6 dB relative to the maximum level measured in the fundamental emission.

Note: The automatic bandwidth measurement capability of a spectrum analyzer or EMI receiver may be employed if it implements the functionality described above.

##### D. 99 Percent Occupied Bandwidth

The 99-percent occupied bandwidth is the frequency bandwidth such that, below its lower and above its upper frequency limits, the mean powers are each equal to 0.5 % of the total mean power of the given emission. Measurement of the 99-percent occupied bandwidth is required only as a condition for using the optional band-edge measurement techniques described in section II.G.3.d). Measurements of 99-percent occupied bandwidth may also optionally be used in lieu of the EBW to 789033 D02 v01r02 General UNII Test Procedures New Rules v01 define the minimum frequency range over which the spectrum is integrated when measuring maximum conducted output power as described in section II.E.

However, the EBW must be measured to determine bandwidth dependent limits on maximum conducted output power in accordance with 15.407(a).

The following procedure shall be used for measuring (99 %) power bandwidth:

1. Set center frequency to the nominal EUT channel center frequency.
2. Set span = 1.5 times to 5.0 times the OBW.
3. Set RBW = 1 % to 5 % of the OBW
4. Set VBW  $\geq 3 \cdot$  RBW
5. Video averaging is not permitted. Where practical, a sample detection and single sweep mode shall be used. Otherwise, peak detection and max hold mode (until the trace stabilizes) shall be used.
6. Use the 99 % power bandwidth function of the instrument (if available).
7. If the instrument does not have a 99 % power bandwidth function, the trace data points are recovered and directly summed in power units. The recovered amplitude data points, beginning at the lowest frequency, are placed in a running sum until 0.5 % of the total is reached; that frequency is recorded as the lower frequency. The process is repeated until 99.5 % of the total is reached; that frequency is recorded as the upper frequency. The 99% occupied bandwidth is the difference between these two frequencies.



8.1.5 Test Results

Temperature:	25°C
Relative Humidity:	45%
ATM Pressure:	1011 mbar

Note: N/A

TestMode	Antenna	Frequency[MHz]	26db EBW [MHz]	FL[MHz]	FH[MHz]	Limit[MHz]	Verdict
11A	Ant1	5180	24.16	5167.60	5191.76	---	---
	Ant2	5180	25.20	5166.64	5191.84	---	---
	Ant1	5200	25.36	5186.64	5212.00	---	---
	Ant2	5200	24.20	5187.56	5211.76	---	---
	Ant1	5240	19.68	5230.12	5249.80	---	---
	Ant2	5240	19.68	5230.12	5249.80	---	---
	Ant1	5260	24.40	5247.72	5272.12	---	---
	Ant2	5260	24.64	5247.52	5272.16	---	---
	Ant1	5280	24.44	5267.80	5292.24	---	---
	Ant2	5280	24.20	5267.88	5292.08	---	---
	Ant1	5320	25.40	5306.60	5332.00	---	---
	Ant2	5320	24.24	5307.60	5331.84	---	---
	Ant1	5500	25.08	5486.68	5511.76	---	---
	Ant2	5500	25.44	5486.56	5512.00	---	---
	Ant1	5580	24.68	5567.72	5592.40	---	---
	Ant2	5580	24.20	5568.00	5592.20	---	---
	Ant1	5700	25.20	5686.60	5711.80	---	---
	Ant2	5700	24.24	5687.60	5711.84	---	---
	Ant1	5745	24.60	5732.64	5757.24	---	---
	Ant2	5745	24.24	5732.96	5757.20	---	---
Ant1	5785	24.40	5772.64	5797.04	---	---	
Ant2	5785	24.28	5773.04	5797.32	---	---	
Ant1	5825	24.16	5812.96	5837.12	---	---	
Ant2	5825	24.60	5812.48	5837.08	---	---	
11N20MIMO	Ant1	5180	25.12	5167.72	5192.84	---	---
	Ant2	5180	24.56	5167.84	5192.40	---	---
	Ant1	5200	25.68	5187.20	5212.88	---	---
	Ant2	5200	24.68	5187.84	5212.52	---	---
	Ant1	5240	20.20	5229.92	5250.12	---	---
	Ant2	5240	19.96	5230.00	5249.96	---	---
	Ant1	5260	25.48	5246.96	5272.44	---	---
	Ant2	5260	23.60	5248.56	5272.16	---	---
	Ant1	5280	25.64	5267.12	5292.76	---	---
	Ant2	5280	23.28	5268.56	5291.84	---	---
	Ant1	5320	26.68	5306.72	5333.40	---	---
	Ant2	5320	30.40	5307.68	5338.08	---	---
	Ant1	5500	25.04	5487.80	5512.84	---	---
	Ant2	5500	25.00	5487.64	5512.64	---	---
	Ant1	5580	28.20	5566.96	5595.16	---	---
	Ant2	5580	23.44	5568.20	5591.64	---	---
	Ant1	5700	25.32	5687.56	5712.88	---	---
	Ant2	5700	24.84	5687.68	5712.52	---	---
	Ant1	5745	25.80	5732.20	5758.00	---	---
	Ant2	5745	24.20	5733.12	5757.32	---	---

	Ant1	5785	25.28	5772.08	5797.36	---	---	
	Ant2	5785	24.04	5773.20	5797.24	---	---	
	Ant1	5825	25.52	5812.16	5837.68	---	---	
	Ant2	5825	23.12	5813.44	5836.56	---	---	
11N40MIMO	Ant1	5190	40.88	5169.68	5210.56	---	---	
	Ant2	5190	39.92	5170.16	5210.08	---	---	
	Ant1	5230	40.80	5209.52	5250.32	---	---	
	Ant2	5230	40.00	5210.00	5250.00	---	---	
	Ant1	5270	40.80	5249.60	5290.40	---	---	
	Ant2	5270	40.08	5249.84	5289.92	---	---	
	Ant1	5310	41.04	5289.44	5330.48	---	---	
	Ant2	5310	39.92	5290.00	5329.92	---	---	
	Ant1	5510	40.72	5489.68	5530.40	---	---	
	Ant2	5510	40.24	5489.84	5530.08	---	---	
	Ant1	5550	40.64	5529.76	5570.40	---	---	
	Ant2	5550	40.08	5529.92	5570.00	---	---	
	Ant1	5670	40.40	5649.76	5690.16	---	---	
	Ant2	5670	40.00	5650.00	5690.00	---	---	
	Ant1	5755	40.48	5734.68	5775.16	---	---	
	Ant2	5755	40.08	5734.92	5775.00	---	---	
	Ant1	5795	41.36	5774.44	5815.80	---	---	
	Ant2	5795	40.08	5775.00	5815.08	---	---	
	11AC20MIMO	Ant1	5180	25.36	5167.64	5193.00	---	---
		Ant2	5180	23.88	5168.64	5192.52	---	---
Ant1		5200	25.40	5187.56	5212.96	---	---	
Ant2		5200	23.64	5188.88	5212.52	---	---	
Ant1		5240	40.00	5220.00	5260.00	---	---	
Ant2		5240	20.04	5229.96	5250.00	---	---	
Ant1		5260	25.48	5247.16	5272.64	---	---	
Ant2		5260	23.40	5248.12	5271.52	---	---	
Ant1		5280	25.56	5267.44	5293.00	---	---	
Ant2		5280	23.20	5268.56	5291.76	---	---	
Ant1		5320	25.84	5307.24	5333.08	---	---	
Ant2		5320	23.96	5308.60	5332.56	---	---	
Ant1		5500	25.08	5487.76	5512.84	---	---	
Ant2		5500	24.76	5487.76	5512.52	---	---	
Ant1		5580	25.40	5567.00	5592.40	---	---	
Ant2		5580	23.36	5568.48	5591.84	---	---	
Ant1		5700	25.68	5687.20	5712.88	---	---	
Ant2		5700	24.36	5688.16	5712.52	---	---	
Ant1		5745	25.12	5732.52	5757.64	---	---	
Ant2		5745	24.08	5733.16	5757.24	---	---	
Ant1		5785	24.96	5772.56	5797.52	---	---	
Ant2		5785	23.48	5773.40	5796.88	---	---	
Ant1		5825	25.64	5812.04	5837.68	---	---	
Ant2		5825	23.68	5813.60	5837.28	---	---	
11AC40MIMO		Ant1	5190	40.64	5169.68	5210.32	---	---
		Ant2	5190	40.00	5170.16	5210.16	---	---
		Ant1	5230	41.04	5209.60	5250.64	---	---
		Ant2	5230	39.76	5210.16	5249.92	---	---
		Ant1	5270	41.04	5249.52	5290.56	---	---
		Ant2	5270	40.32	5249.76	5290.08	---	---
		Ant1	5310	40.64	5289.68	5330.32	---	---
		Ant2	5310	39.92	5290.08	5330.00	---	---
	Ant1	5510	40.88	5489.60	5530.48	---	---	

	Ant2	5510	40.00	5490.00	5530.00	---	---
	Ant1	5550	40.48	5529.76	5570.24	---	---
	Ant2	5550	39.92	5529.92	5569.84	---	---
	Ant1	5670	40.64	5649.68	5690.32	---	---
	Ant2	5670	39.92	5650.00	5689.92	---	---
	Ant1	5755	40.80	5734.52	5775.32	---	---
	Ant2	5755	40.00	5735.00	5775.00	---	---
	Ant1	5795	40.64	5774.68	5815.32	---	---
	Ant2	5795	39.84	5775.08	5814.92	---	---
11AC80MIMO	Ant1	5210	80.96	5169.52	5250.48	---	---
	Ant2	5210	79.84	5170.16	5250.00	---	---
	Ant1	5290	80.96	5249.52	5330.48	---	---
	Ant2	5290	80.00	5250.00	5330.00	---	---
	Ant1	5530	80.80	5489.52	5570.32	---	---
	Ant2	5530	80.00	5490.00	5570.00	---	---
	Ant1	5610	80.64	5569.68	5650.32	---	---
	Ant2	5610	79.68	5570.16	5649.84	---	---
	Ant1	5775	81.28	5734.36	5815.64	---	---
Ant2	5775	80.00	5735.00	5815.00	---	---	
11AX20MIMO	Ant1	5180	27.96	5165.80	5193.76	---	---
	Ant2	5180	23.88	5168.00	5191.88	---	---
	Ant1	5200	25.28	5187.52	5212.80	---	---
	Ant2	5200	26.84	5187.12	5213.96	---	---
	Ant1	5240	19.96	5230.00	5249.96	---	---
	Ant2	5240	20.04	5229.96	5250.00	---	---
	Ant1	5260	29.00	5243.52	5272.52	---	---
	Ant2	5260	25.04	5247.64	5272.68	---	---
	Ant1	5280	24.20	5267.84	5292.04	---	---
	Ant2	5280	23.84	5268.60	5292.44	---	---
	Ant1	5320	28.76	5308.52	5337.28	---	---
	Ant2	5320	25.96	5306.92	5332.88	---	---
	Ant1	5500	25.08	5487.04	5512.12	---	---
	Ant2	5500	27.40	5486.00	5513.40	---	---
	Ant1	5580	29.40	5566.80	5596.20	---	---
	Ant2	5580	23.60	5568.16	5591.76	---	---
	Ant1	5700	24.72	5687.56	5712.28	---	---
	Ant2	5700	23.96	5687.48	5711.44	---	---
	Ant1	5745	25.32	5731.40	5756.72	---	---
	Ant2	5745	25.28	5732.96	5758.24	---	---
	Ant1	5785	26.76	5772.28	5799.04	---	---
	Ant2	5785	23.88	5773.64	5797.52	---	---
	Ant1	5825	25.52	5811.20	5836.72	---	---
	Ant2	5825	25.80	5812.76	5838.56	---	---
11AX40MIMO	Ant1	5190	41.28	5169.28	5210.56	---	---
	Ant2	5190	41.28	5169.68	5210.96	---	---
	Ant1	5230	41.04	5209.44	5250.48	---	---
	Ant2	5230	40.72	5209.76	5250.48	---	---
	Ant1	5270	41.20	5249.28	5290.48	---	---
	Ant2	5270	40.88	5249.60	5290.48	---	---
	Ant1	5310	41.36	5289.44	5330.80	---	---
	Ant2	5310	41.04	5289.52	5330.56	---	---
	Ant1	5510	41.12	5489.28	5530.40	---	---
	Ant2	5510	41.60	5489.20	5530.80	---	---
	Ant1	5550	42.08	5528.56	5570.64	---	---
	Ant2	5550	40.64	5529.84	5570.48	---	---



	Ant1	5670	41.12	5649.60	5690.72	---	---
	Ant2	5670	40.72	5649.76	5690.48	---	---
	Ant1	5755	40.72	5734.68	5775.40	---	---
	Ant2	5755	40.48	5734.84	5775.32	---	---
	Ant1	5795	40.88	5774.28	5815.16	---	---
	Ant2	5795	41.20	5774.60	5815.80	---	---
11AX80MIMO	Ant1	5210	89.12	5168.88	5258.00	---	---
	Ant2	5210	83.52	5168.56	5252.08	---	---
	Ant1	5290	90.72	5248.08	5338.80	---	---
	Ant2	5290	86.40	5247.28	5333.68	---	---
	Ant1	5530	88.48	5488.40	5576.88	---	---
	Ant2	5530	84.32	5487.92	5572.24	---	---
	Ant1	5610	91.84	5569.20	5661.04	---	---
	Ant2	5610	84.64	5567.44	5652.08	---	---
	Ant1	5775	90.40	5732.92	5823.32	---	---
	Ant2	5775	84.32	5733.08	5817.40	---	---





11A\_Ant1\_5180

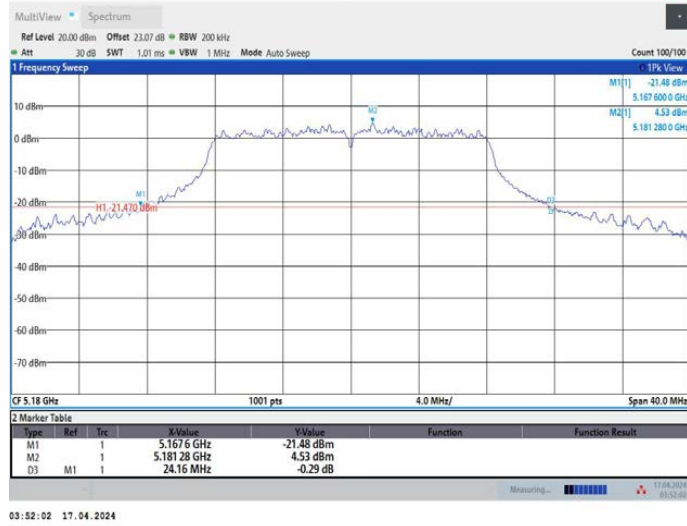

03:52:02 17.04.2024

11A\_Ant2\_5180

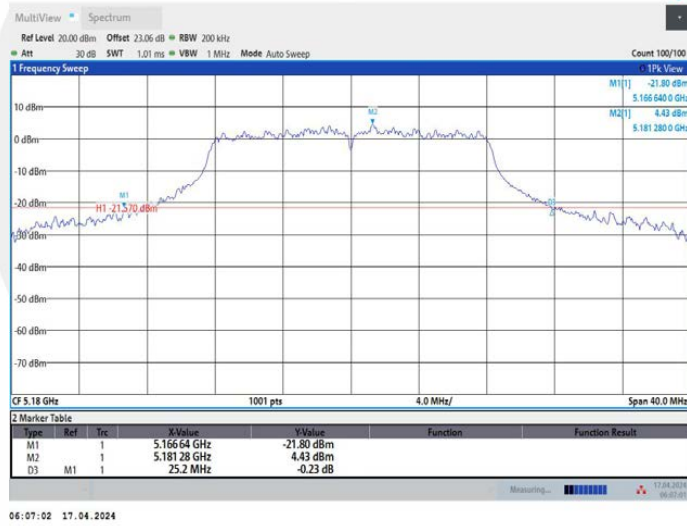

06:07:02 17.04.2024

11A\_Ant1\_5200

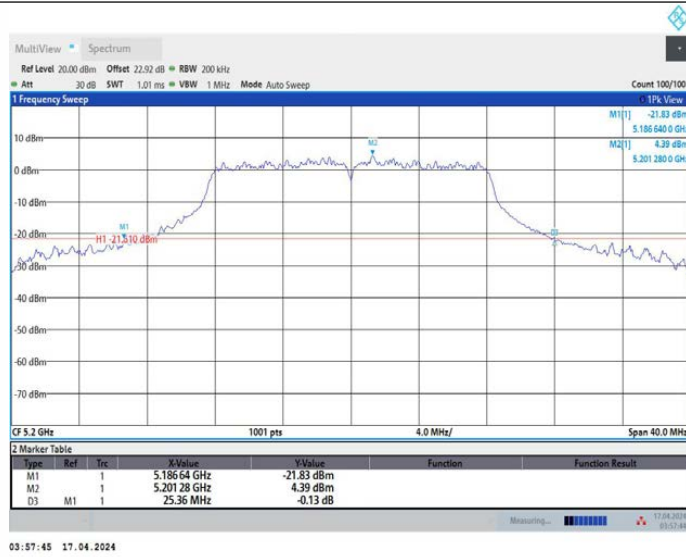

11A\_Ant2\_5200

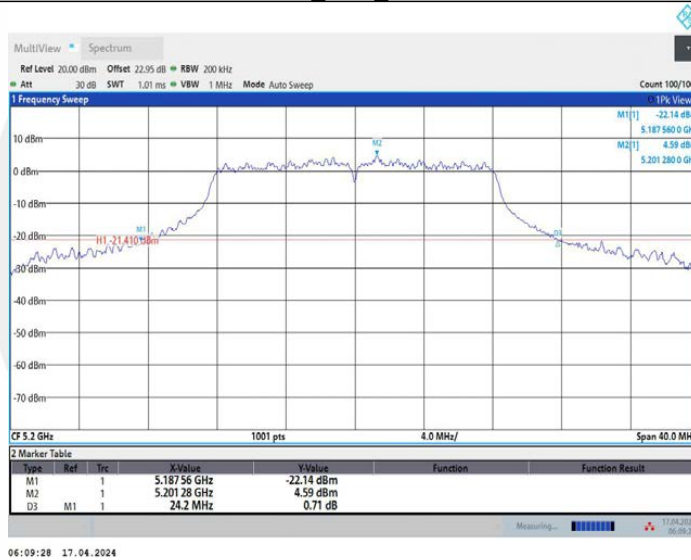

11A\_Ant1\_5240



## 11A\_Ant2\_5240

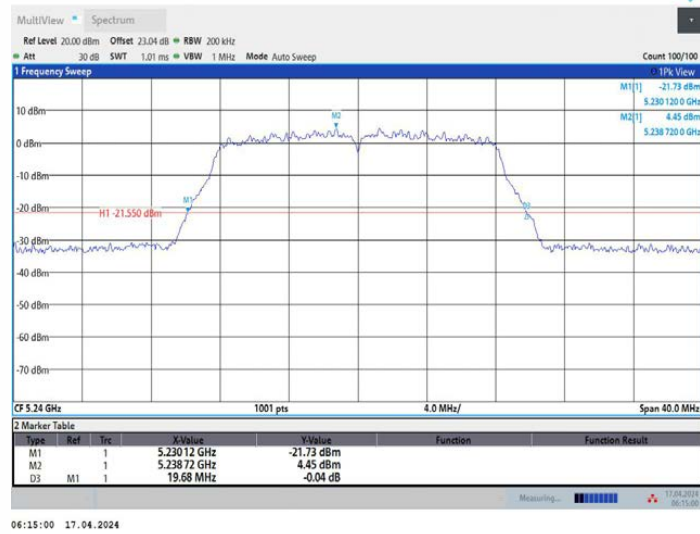

06:15:00 17.04.2024

## 11A\_Ant1\_5260

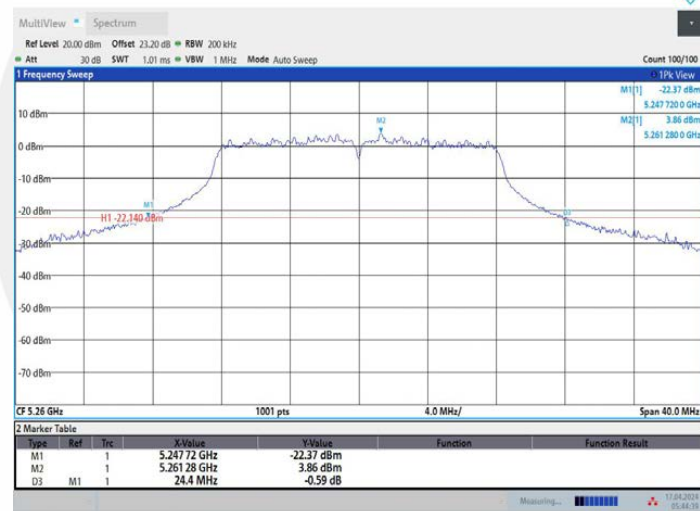

05:44:40 17.04.2024

## 11A\_Ant2\_5260

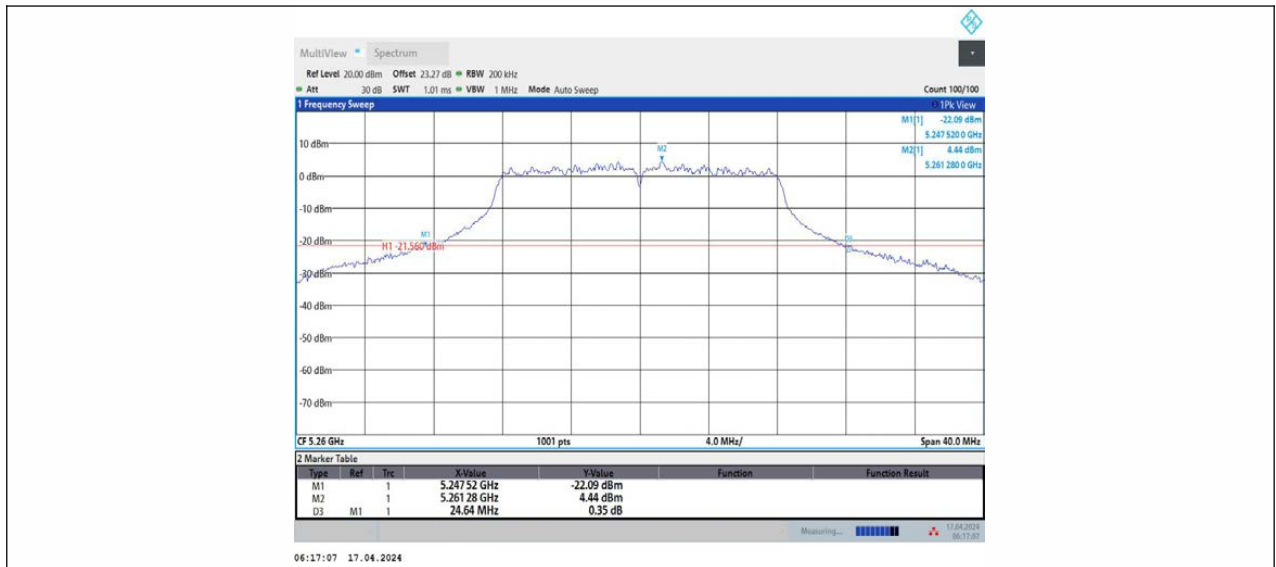

06:17:07 17.04.2024

11A\_Ant1\_5280

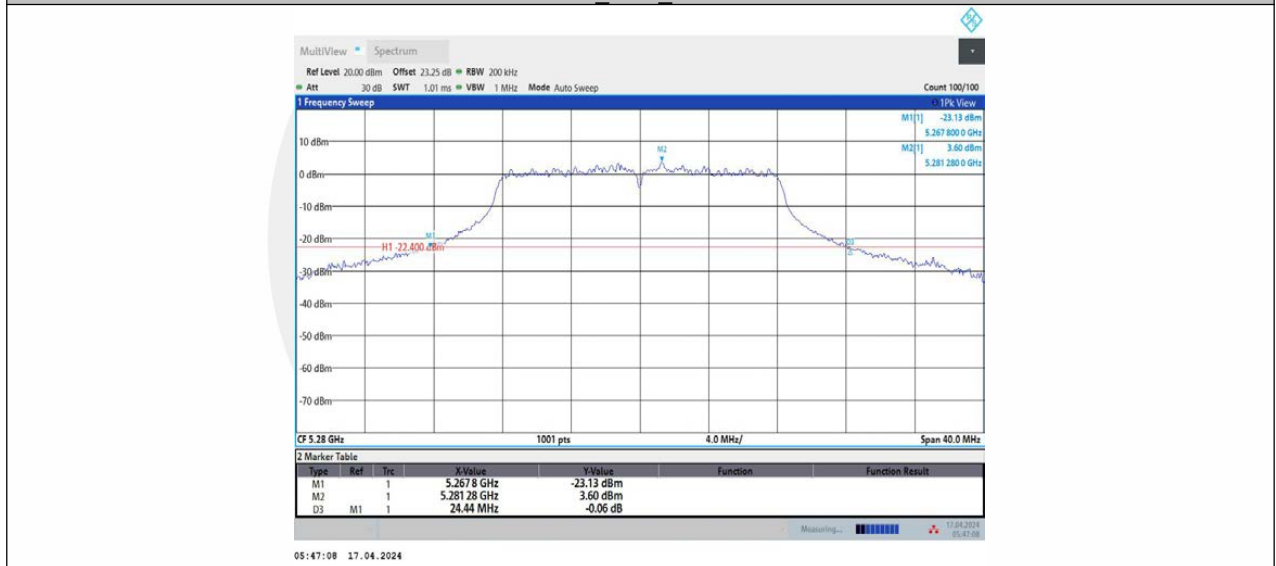

05:47:08 17.04.2024

11A\_Ant2\_5280

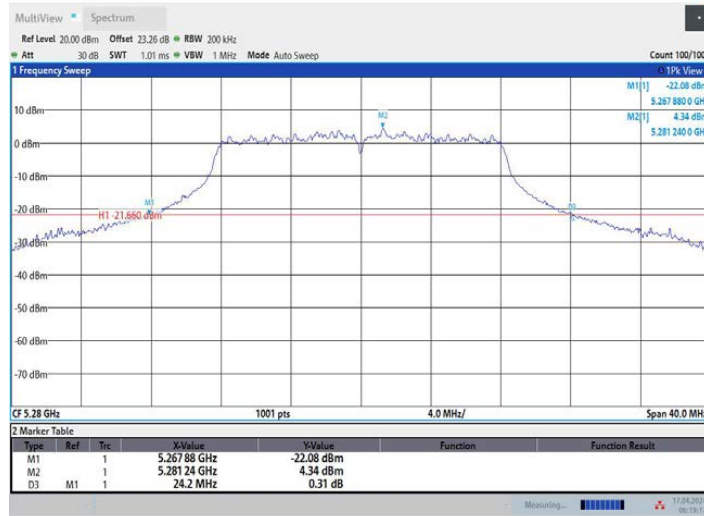

06:19:18 17.04.2024

11A\_Ant1\_5320

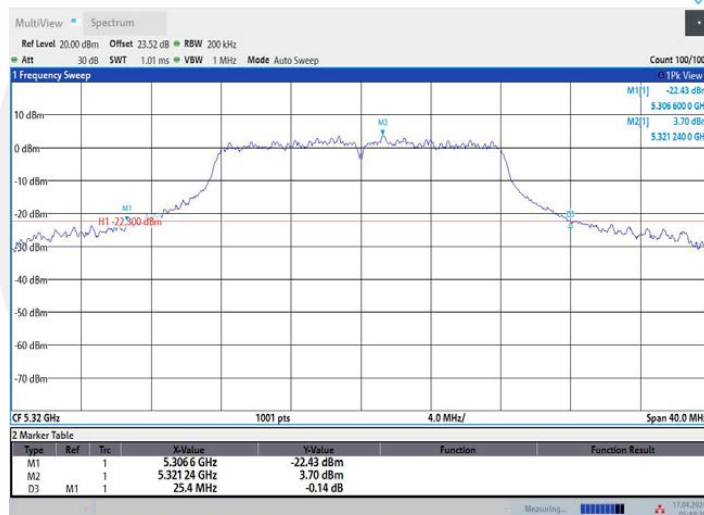

05:49:38 17.04.2024

11A\_Ant2\_5320

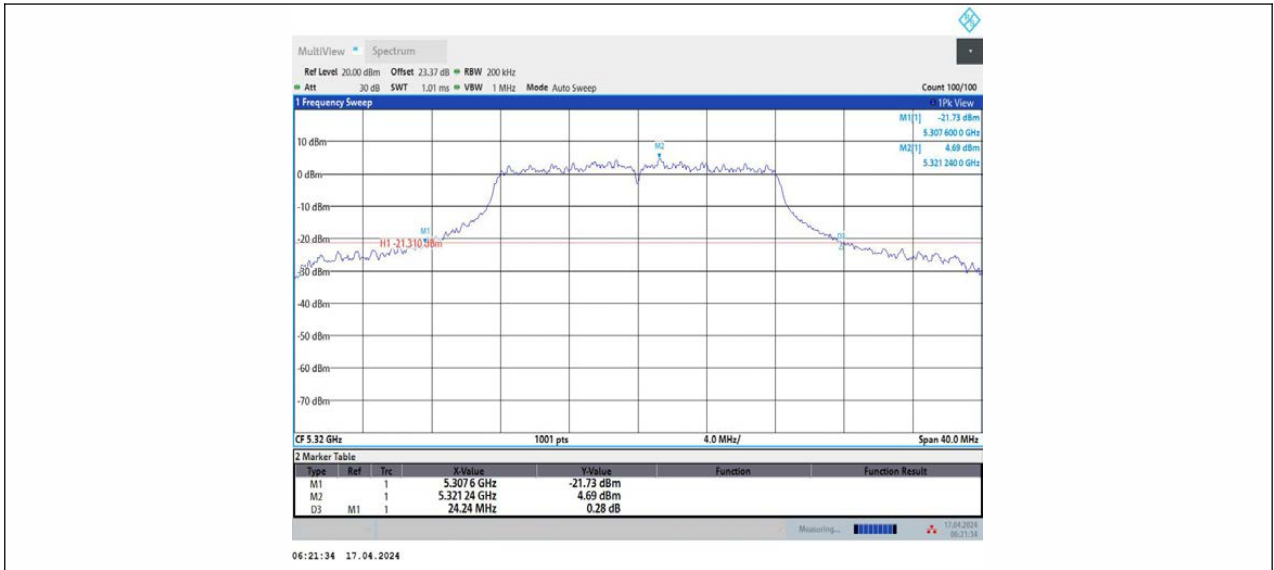

11A\_Ant1\_5500

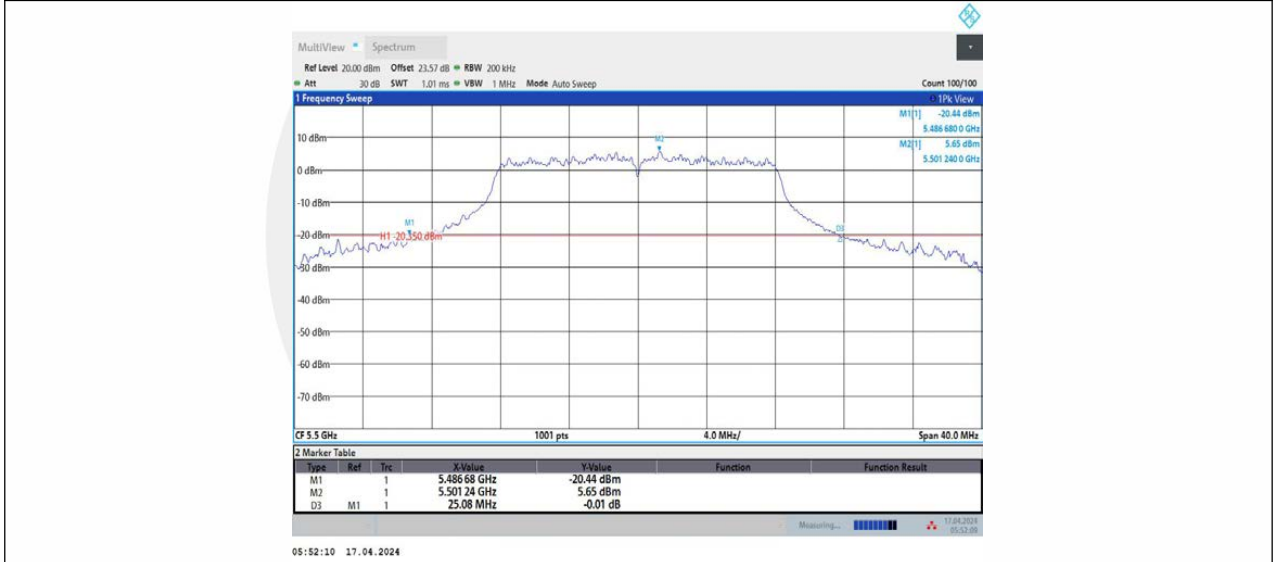

11A\_Ant2\_5500

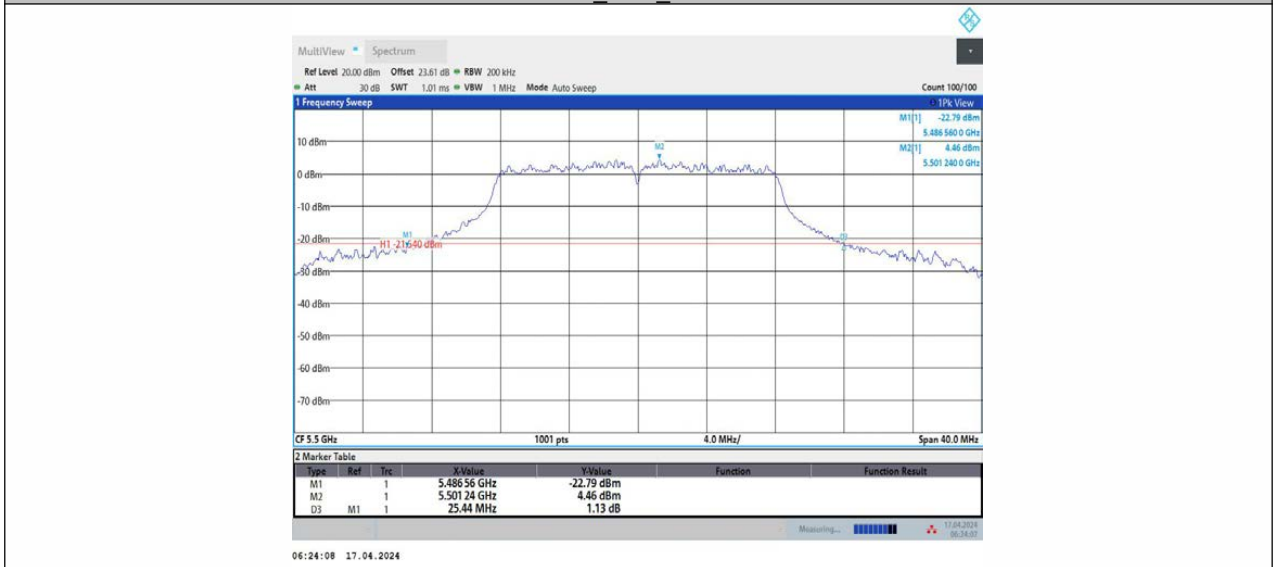

11A\_Ant1\_5580

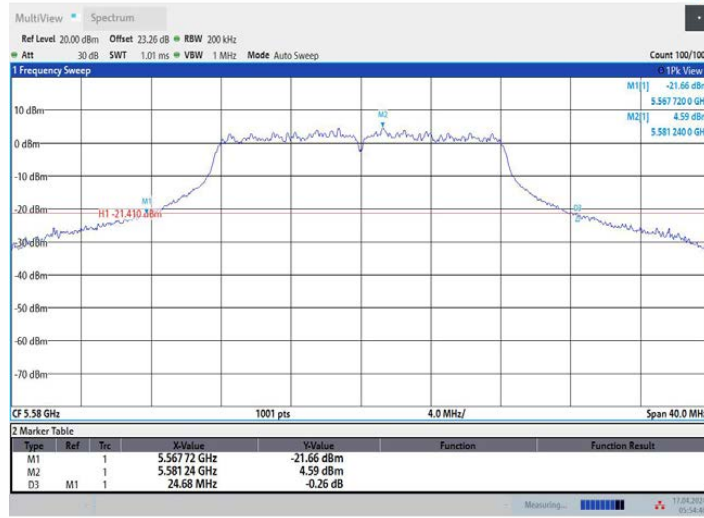

05:54:47 17.04.2024

11A\_Ant2\_5580

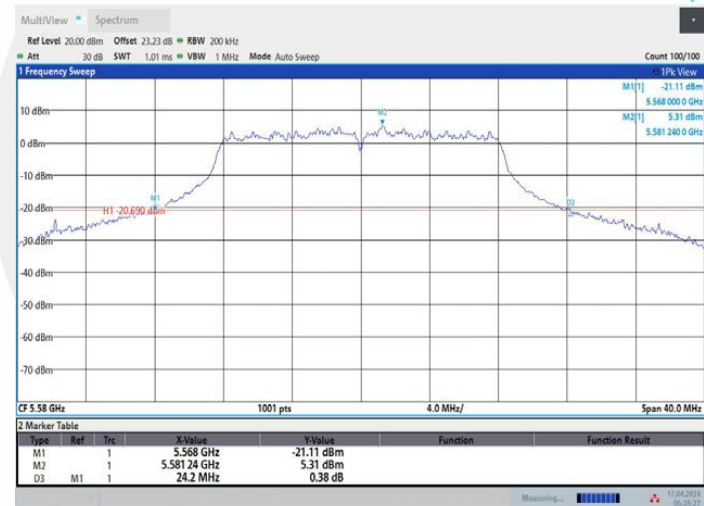

06:26:28 17.04.2024

11A\_Ant1\_5700



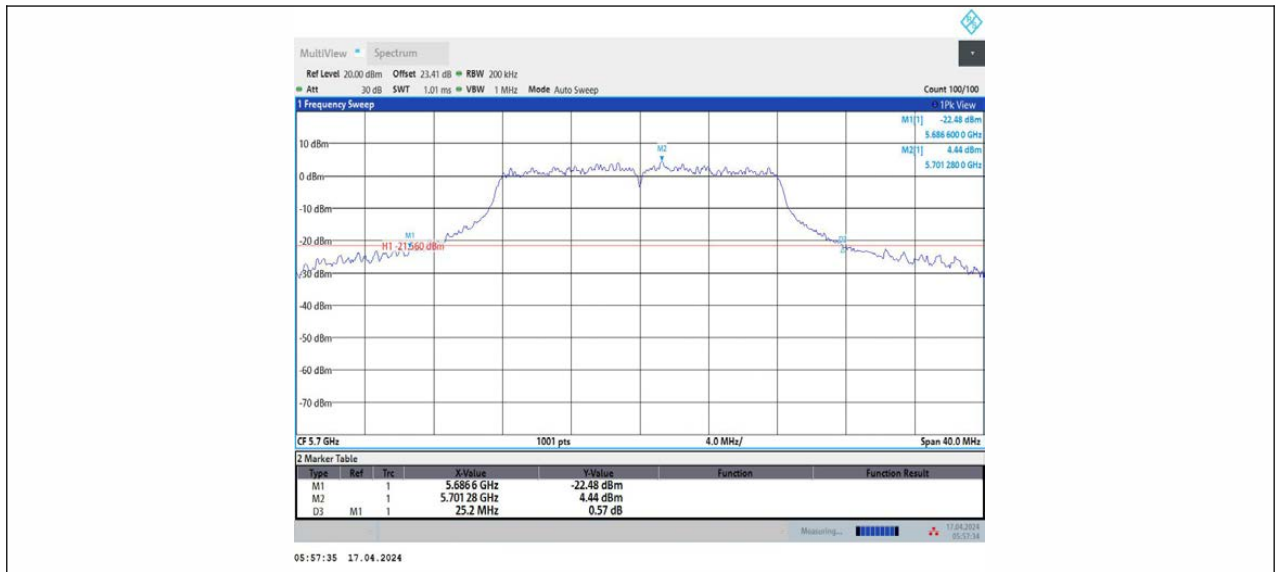

11A\_Ant2\_5700

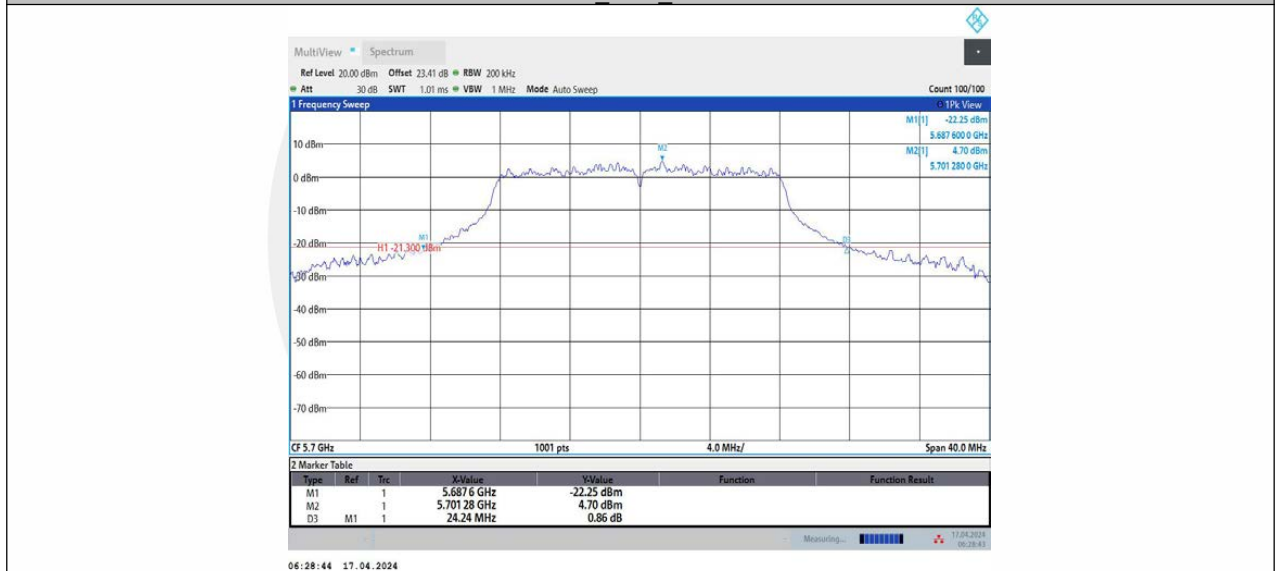

11A\_Ant1\_5745



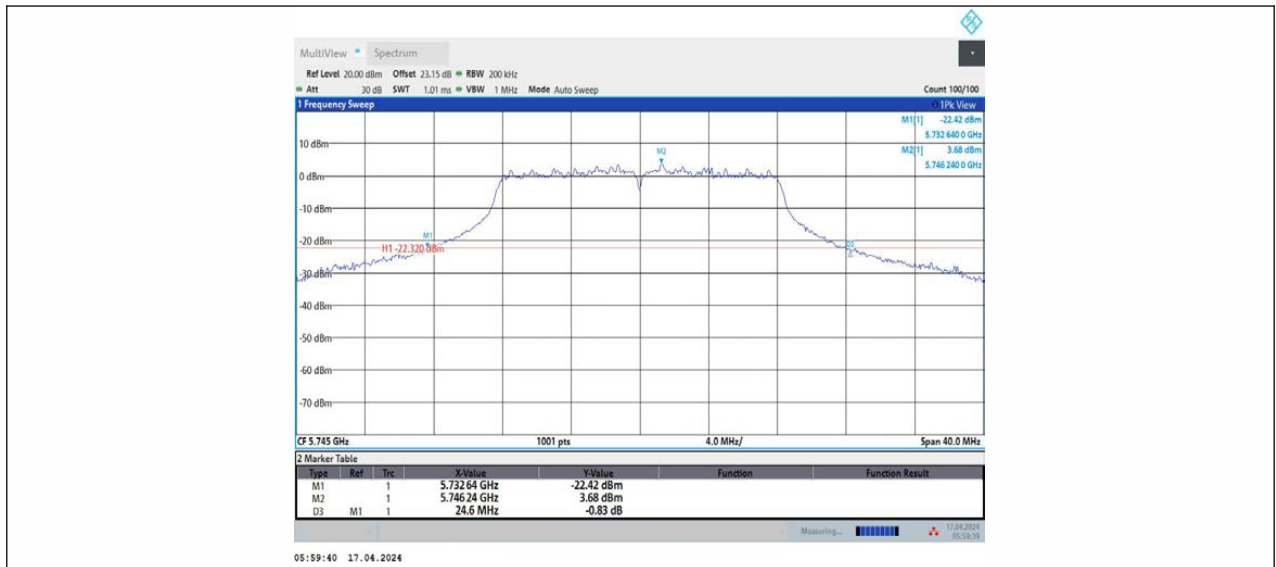

11A\_Ant2\_5745

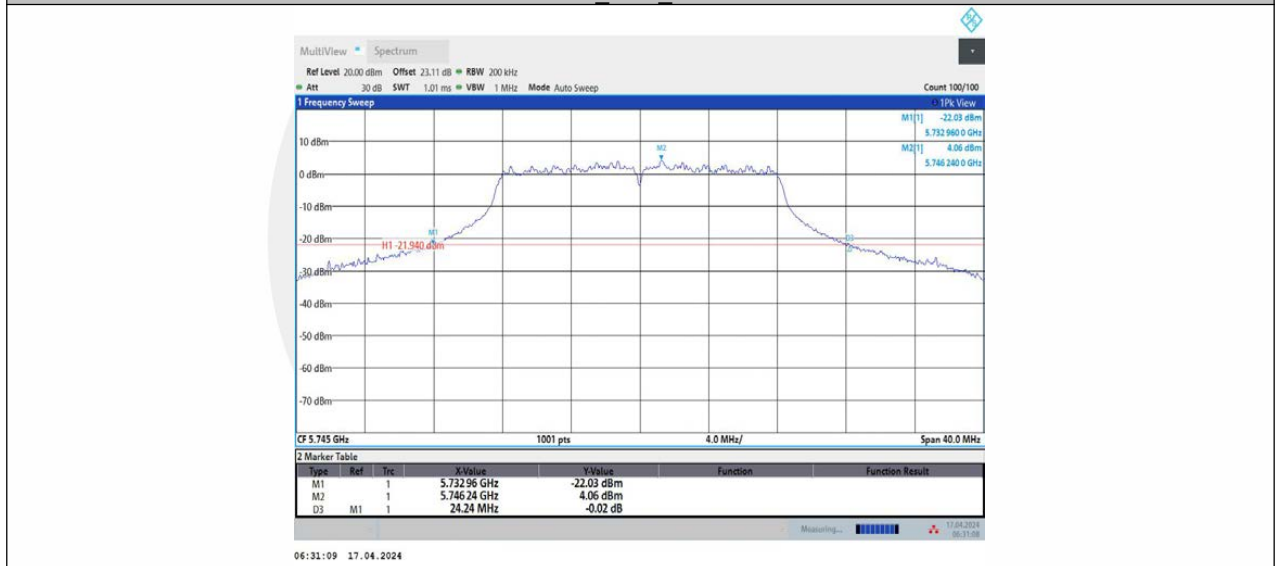

11A\_Ant1\_5785

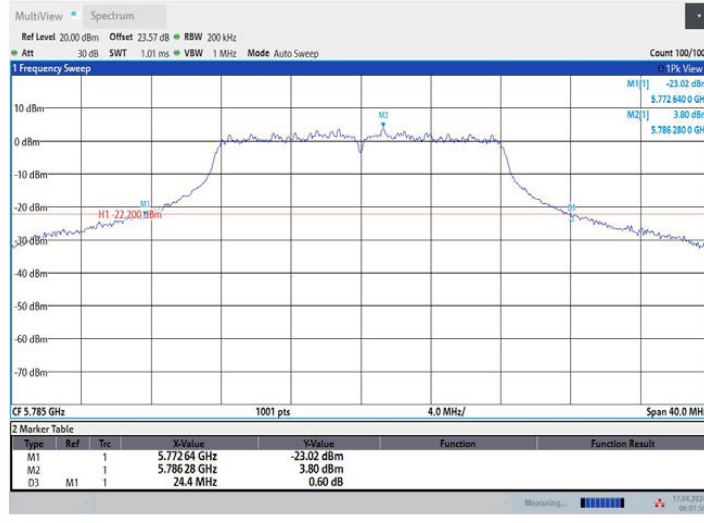

06:01:57 17.04.2024

11A\_Ant2\_5785

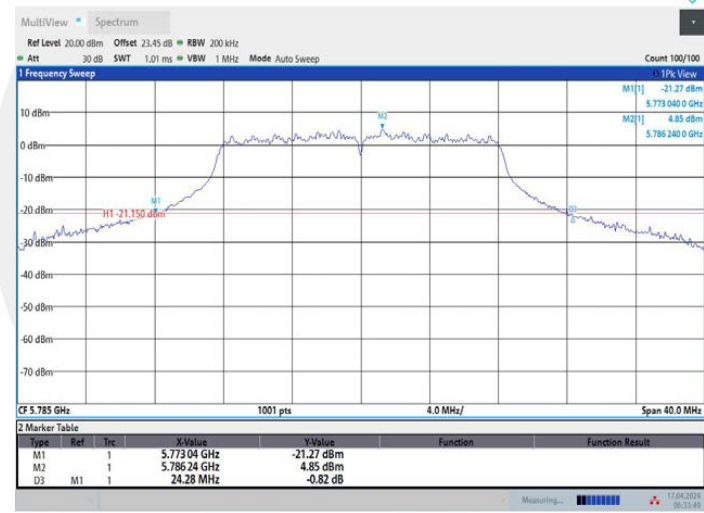

06:33:49 17.04.2024

11A\_Ant1\_5825

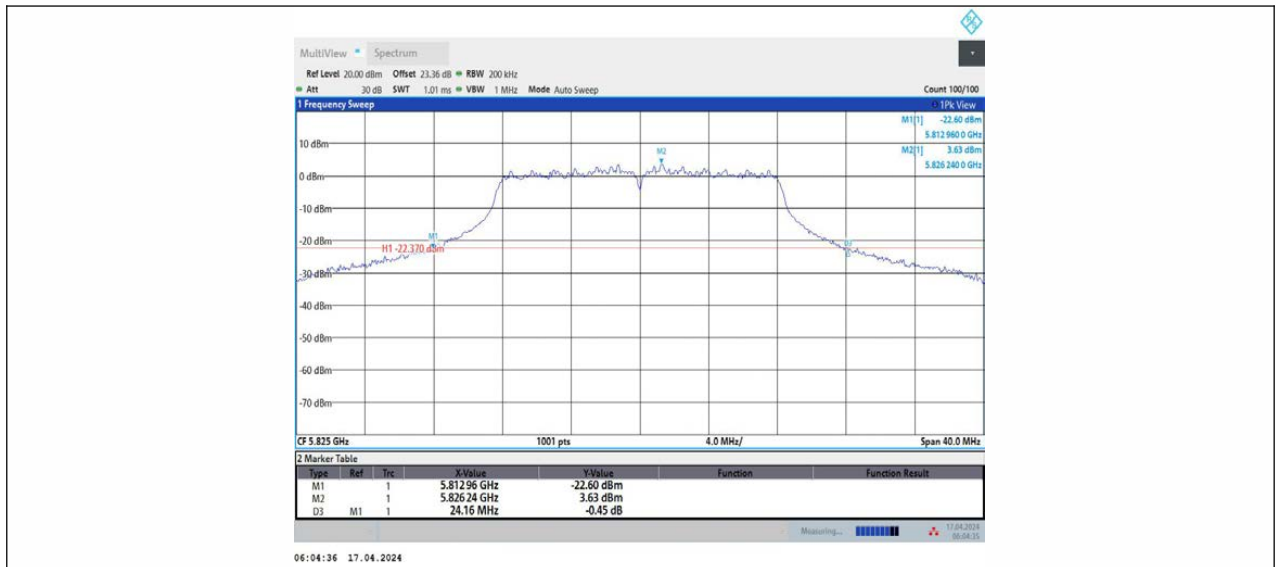

11A\_Ant2\_5825

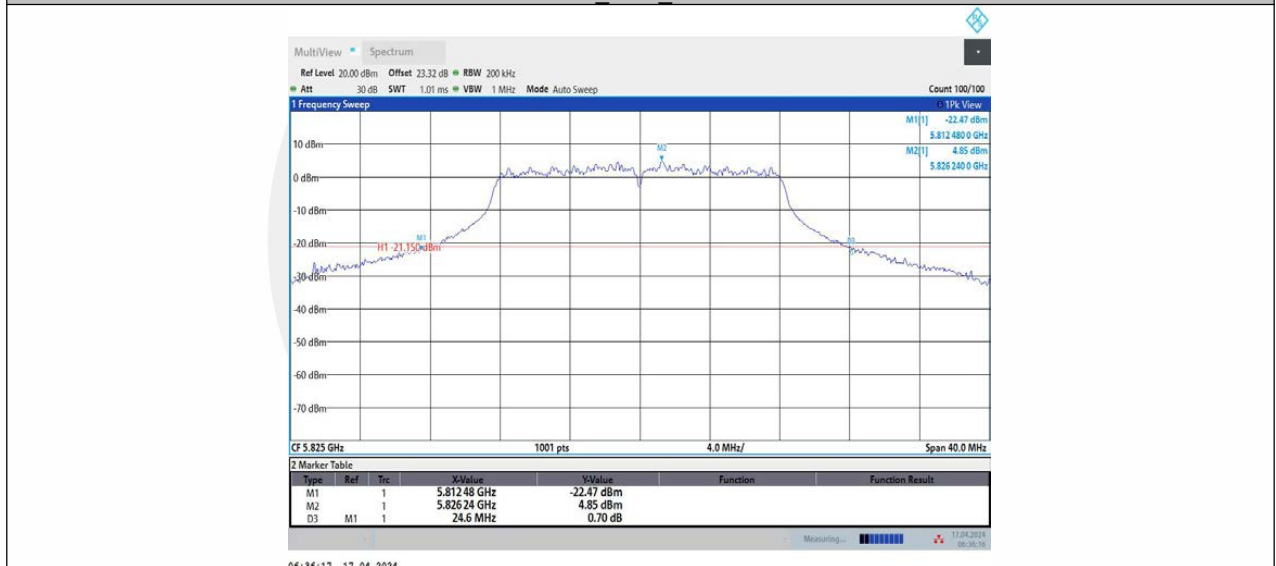

11N20MIMO\_Ant1\_5180

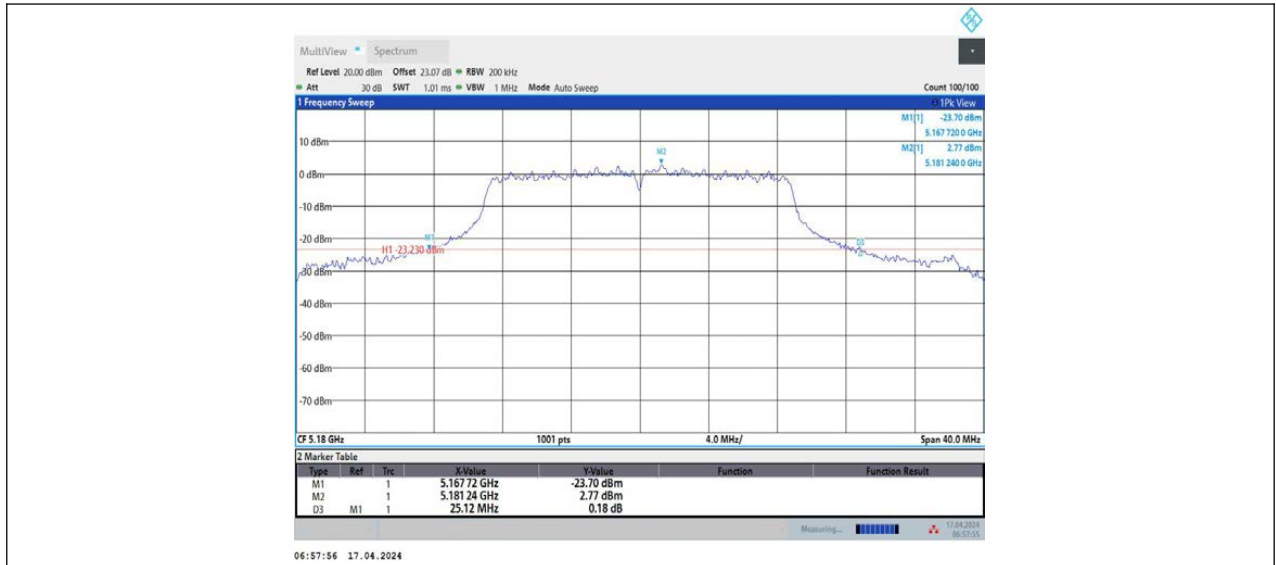

11N20MIMO\_Ant2\_5180

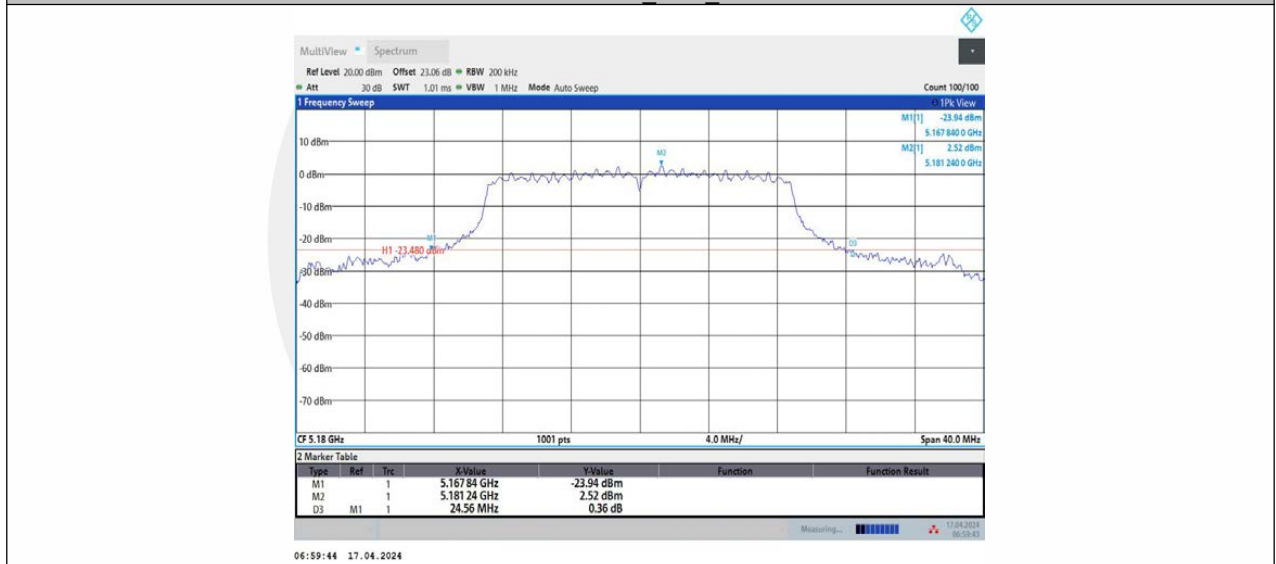

11N20MIMO\_Ant1\_5200

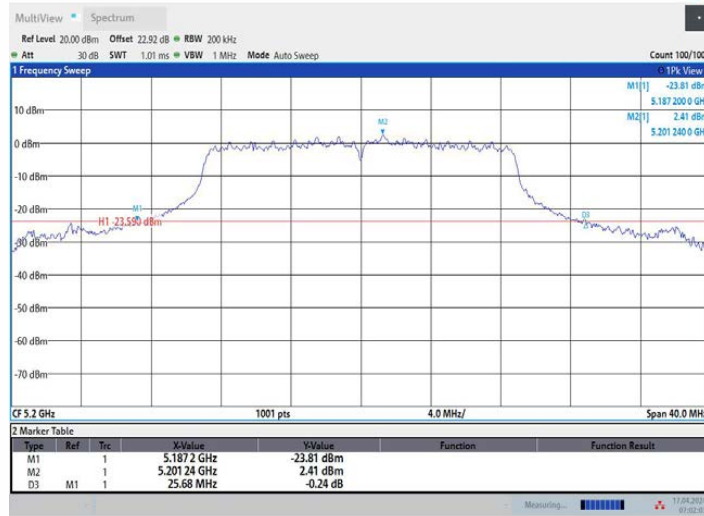

11N20MIMO\_Ant2\_5200



11N20MIMO\_Ant1\_5240

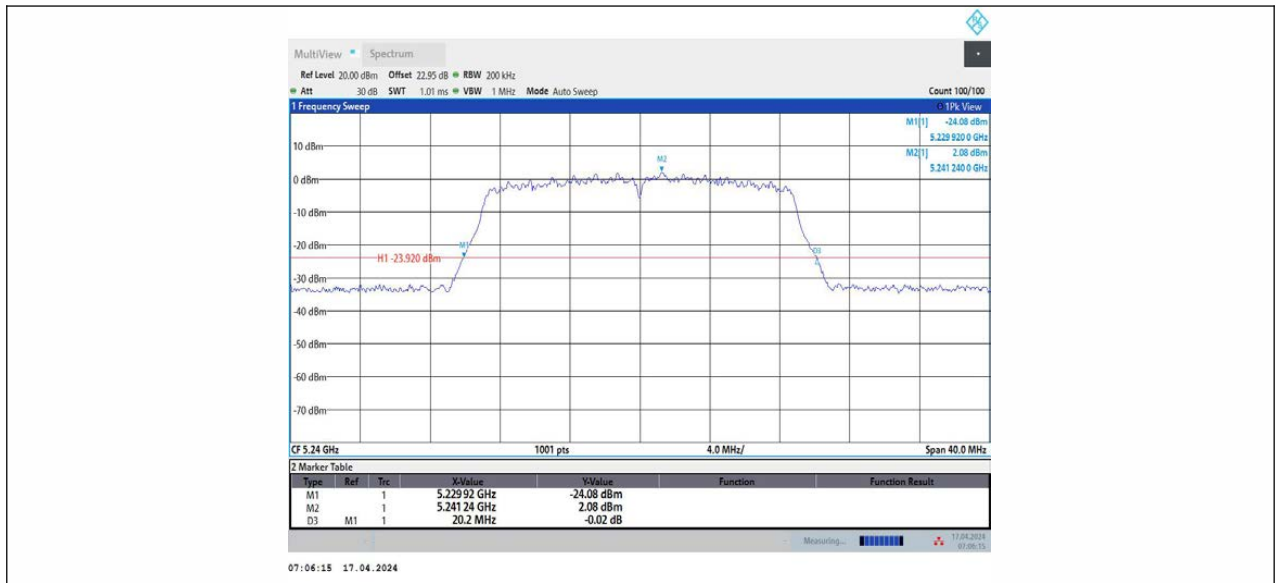

11N20MIMO\_Ant2\_5240



11N20MIMO\_Ant1\_5260

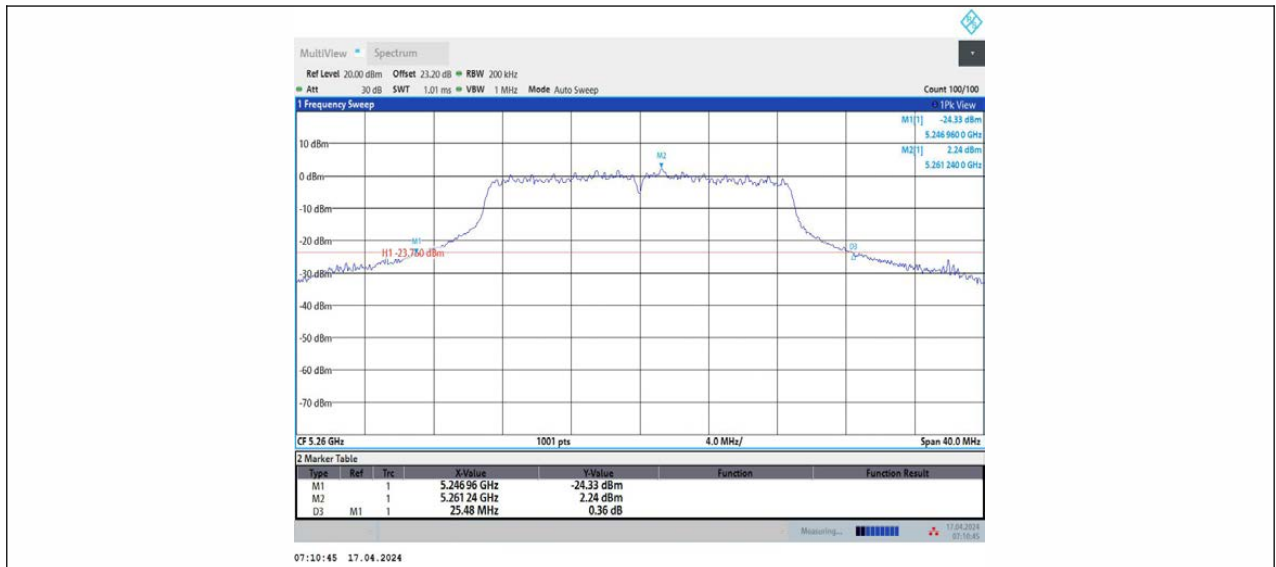

11N20MIMO\_Ant2\_5260

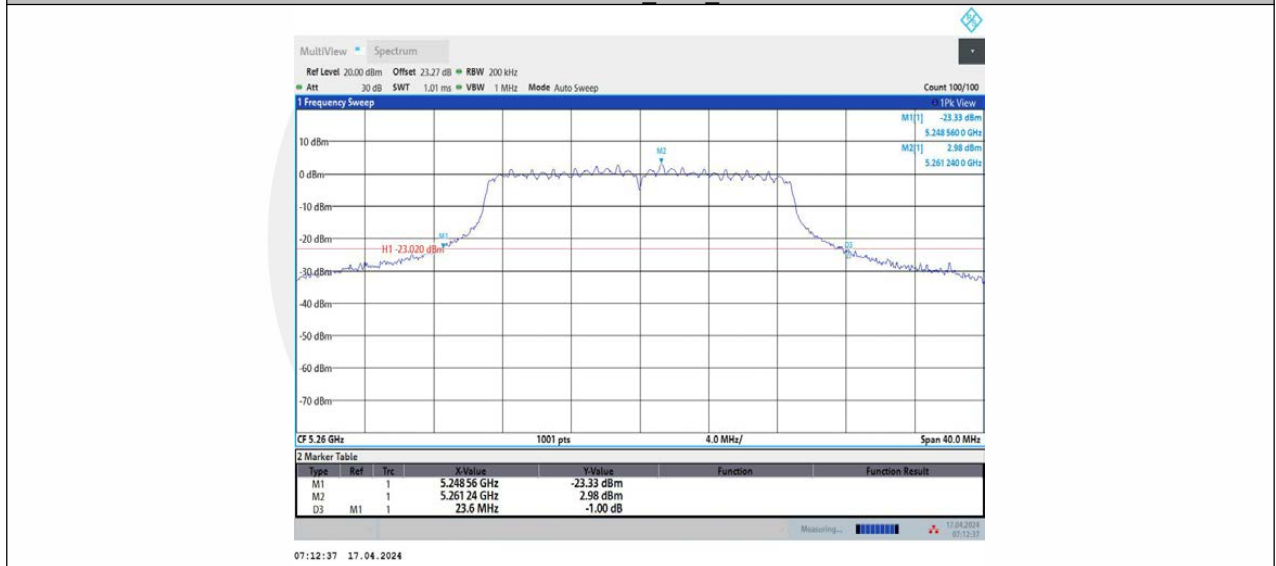

11N20MIMO\_Ant1\_5280



11N20MIMO\_Ant2\_5280

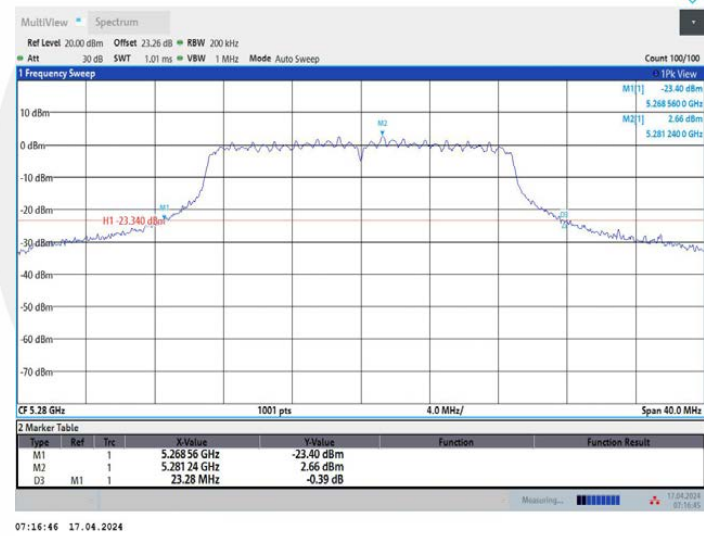

11N20MIMO\_Ant1\_5320



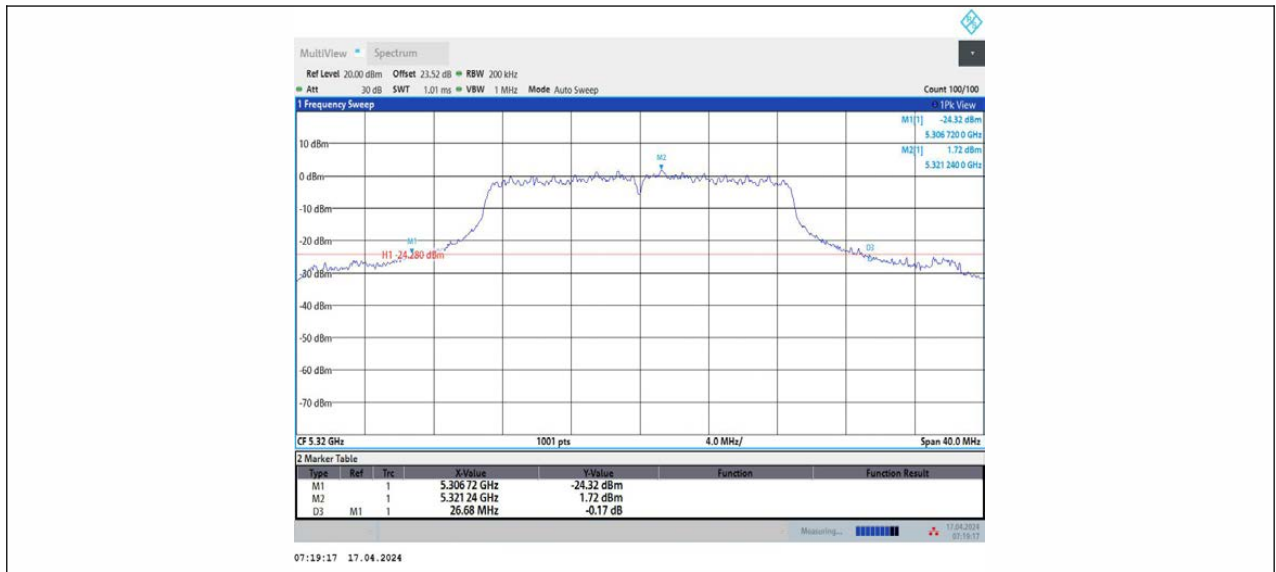

11N20MIMO\_Ant2\_5320

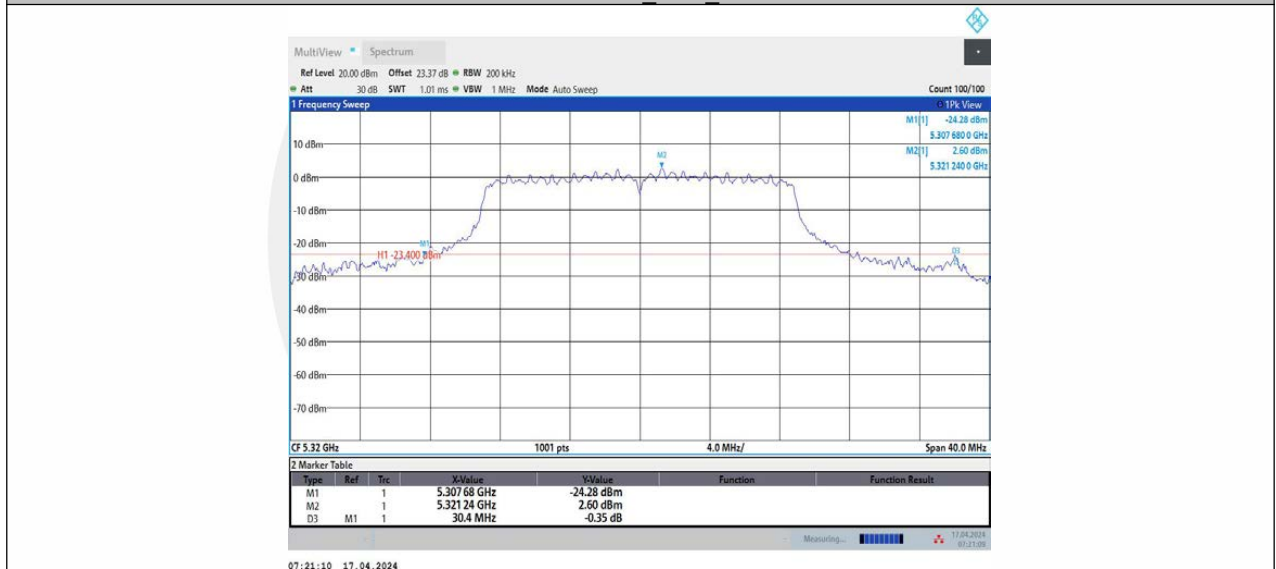

11N20MIMO\_Ant1\_5500

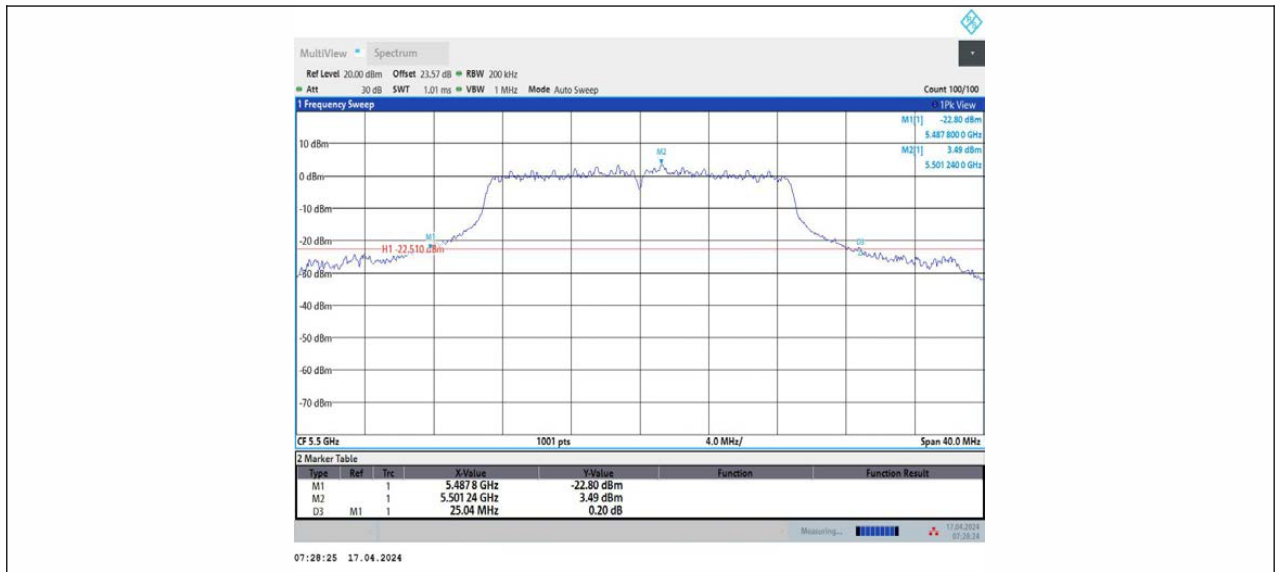

11N20MIMO\_Ant2\_5500

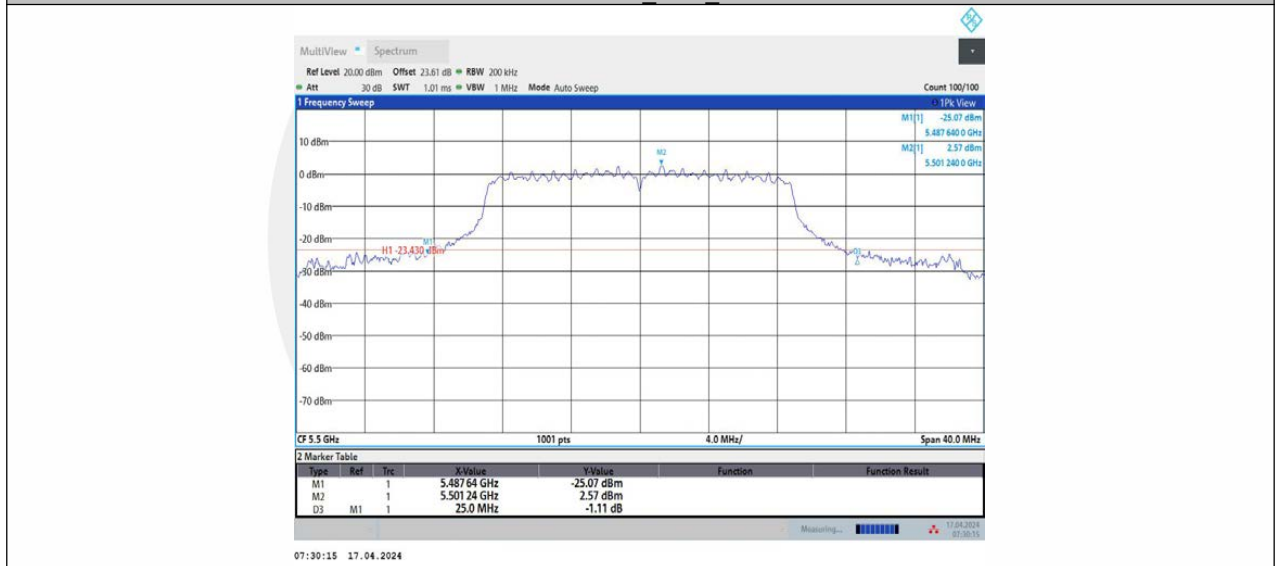

11N20MIMO\_Ant1\_5580

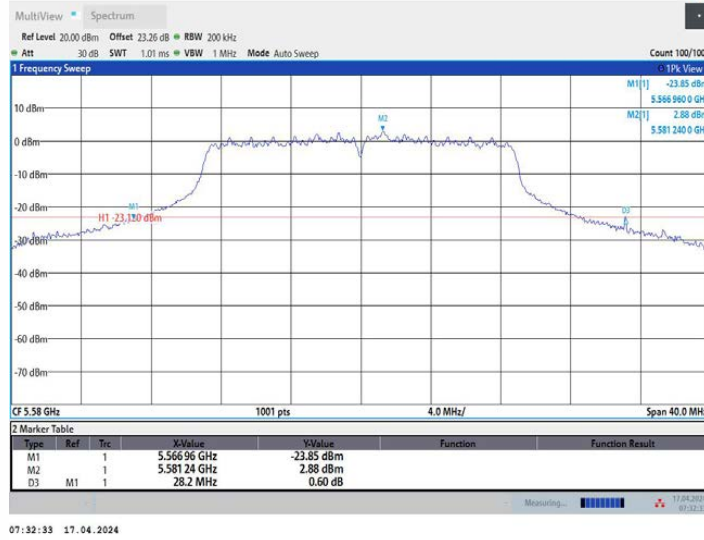

11N20MIMO\_Ant2\_5580

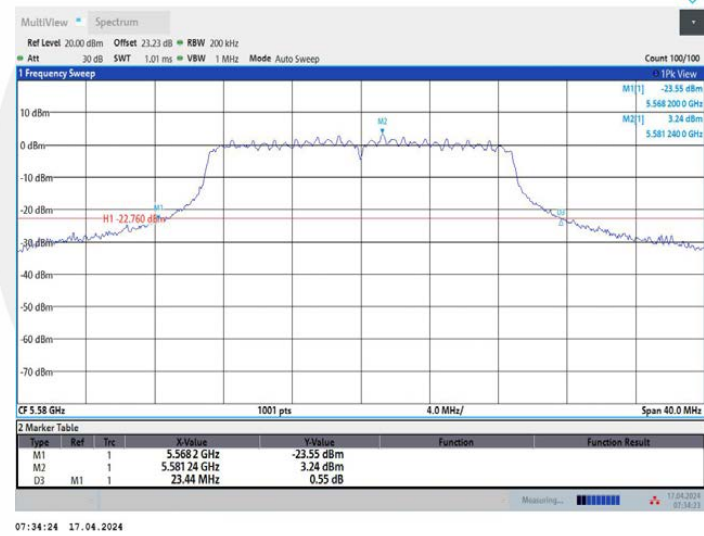

11N20MIMO\_Ant1\_5700

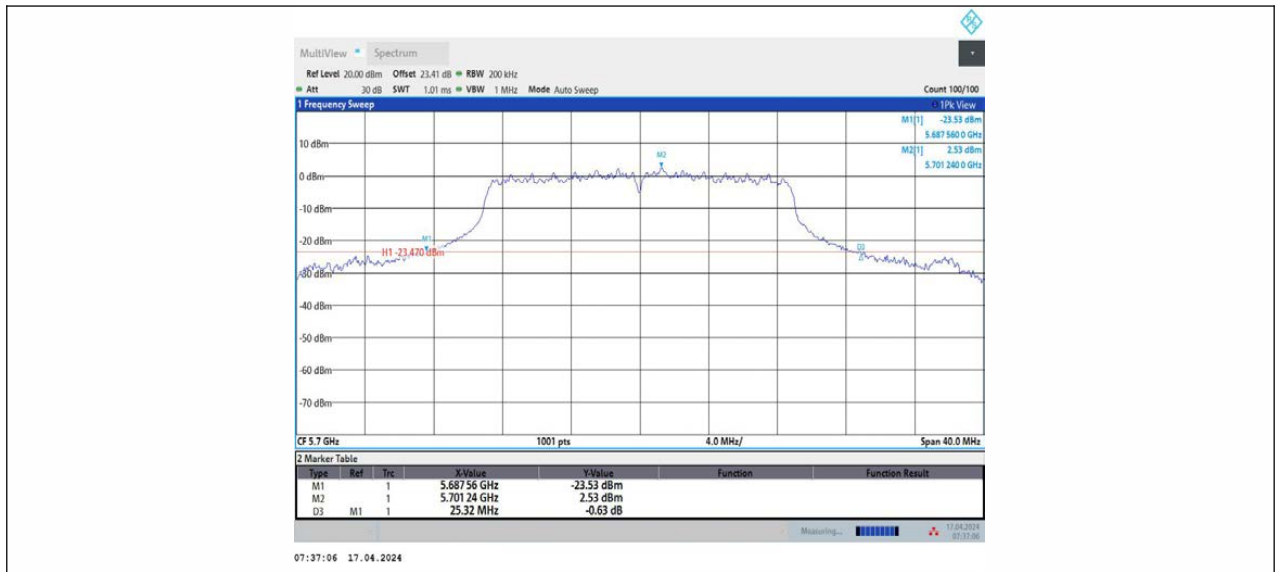

11N20MIMO\_Ant2\_5700

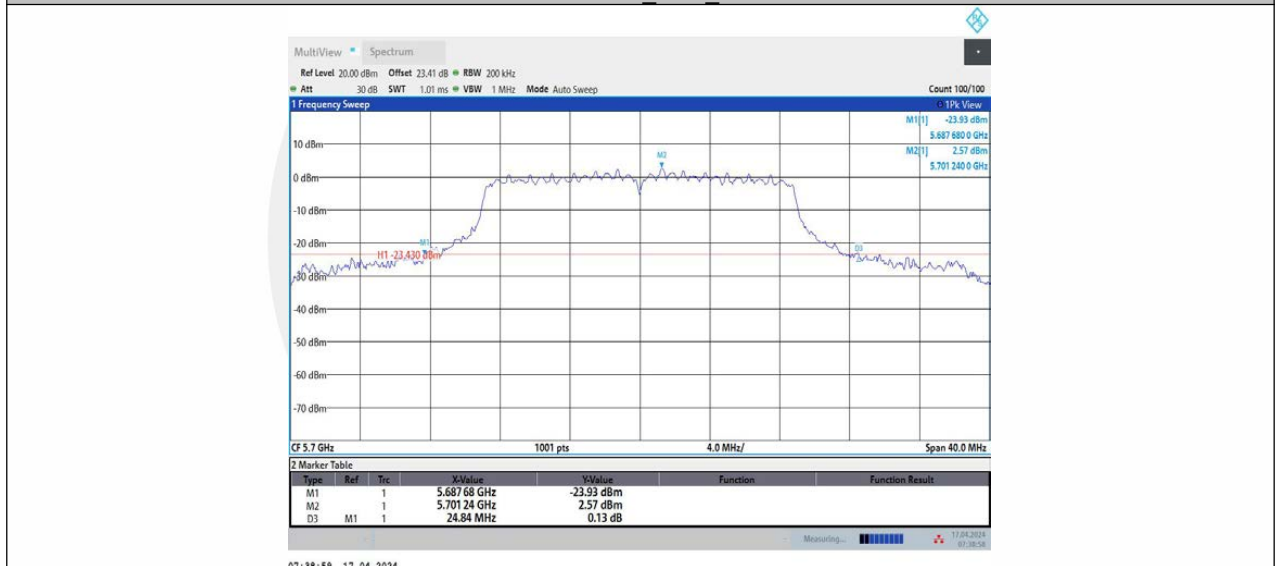

11N20MIMO\_Ant1\_5745

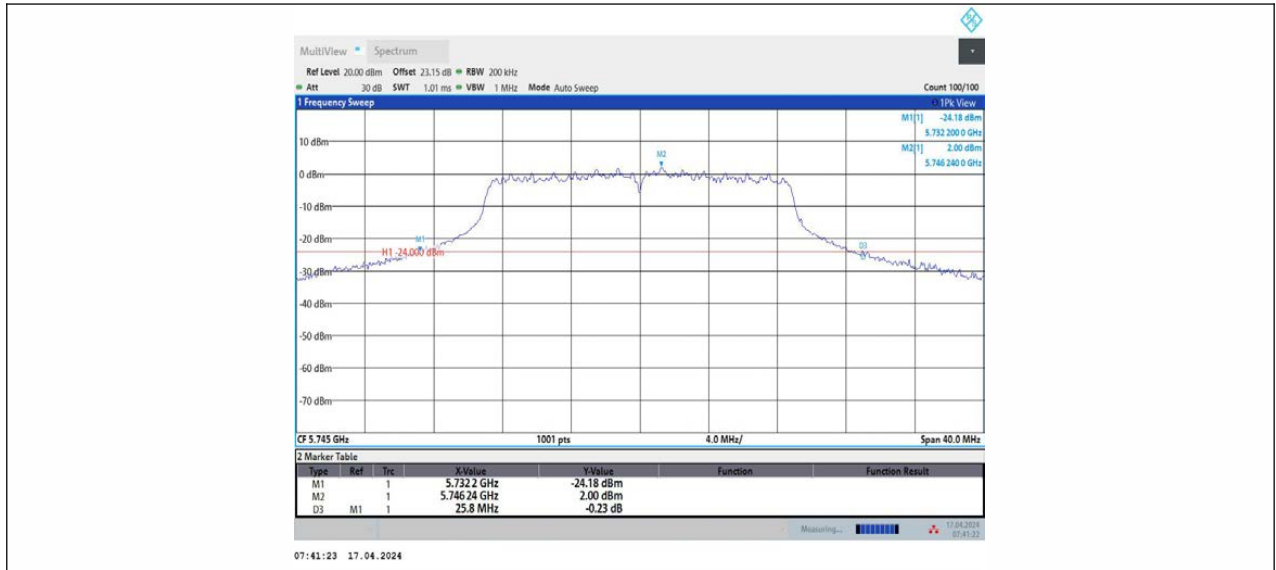

11N20MIMO\_Ant2\_5745

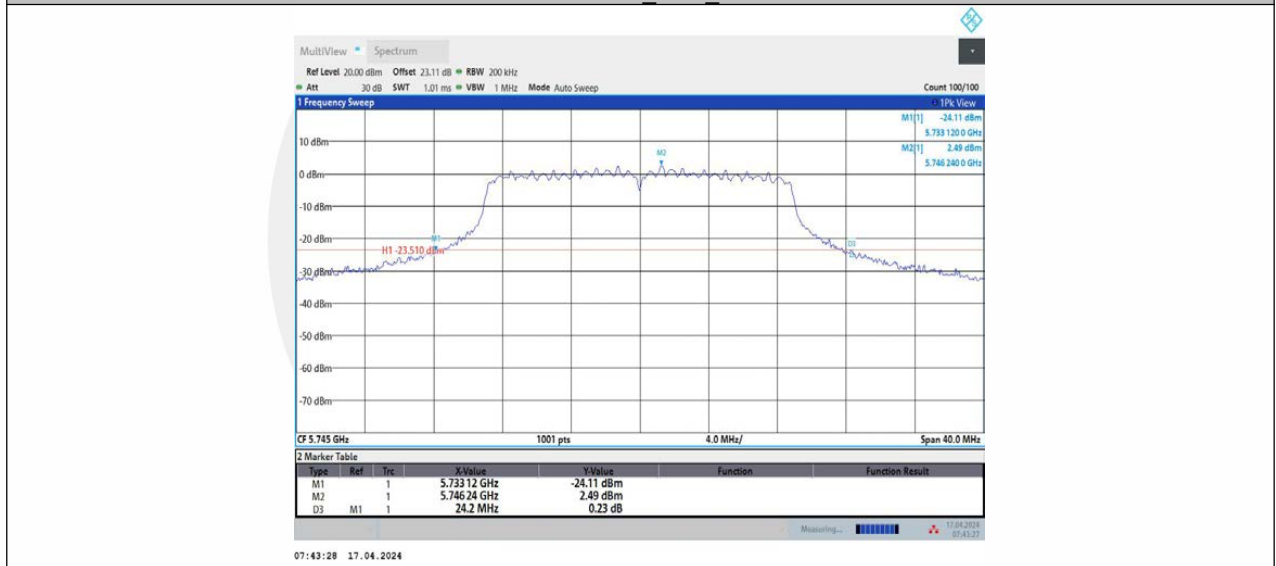

11N20MIMO\_Ant1\_5785

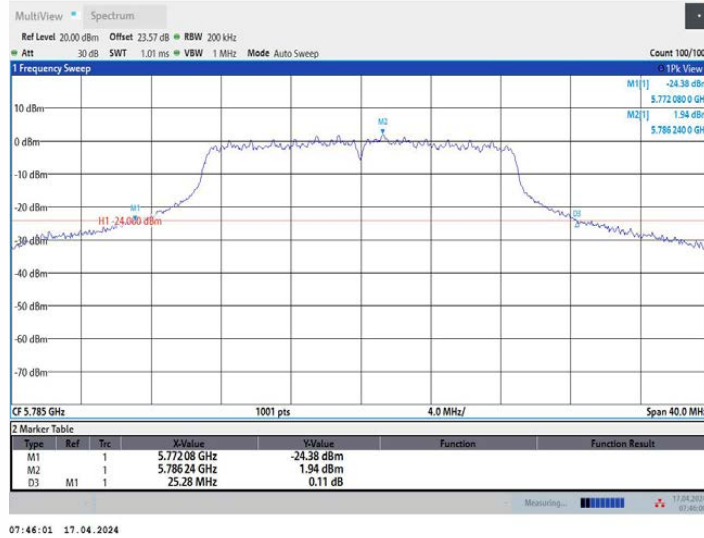

11N20MIMO\_Ant2\_5785

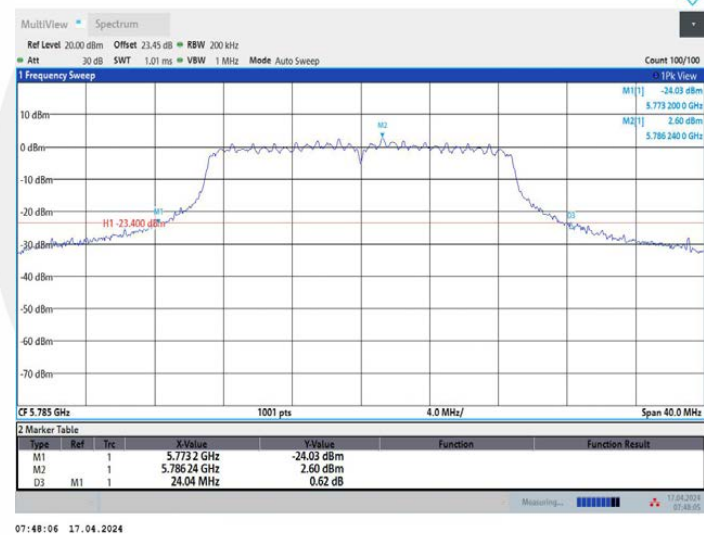

11N20MIMO\_Ant1\_5825

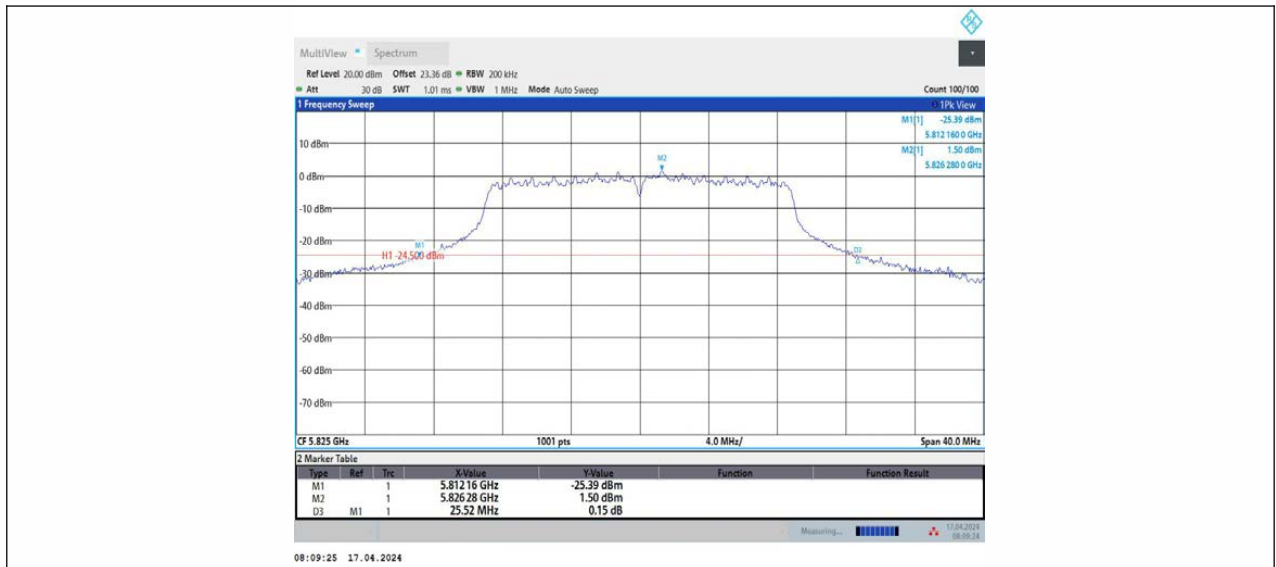

11N20MIMO\_Ant2\_5825

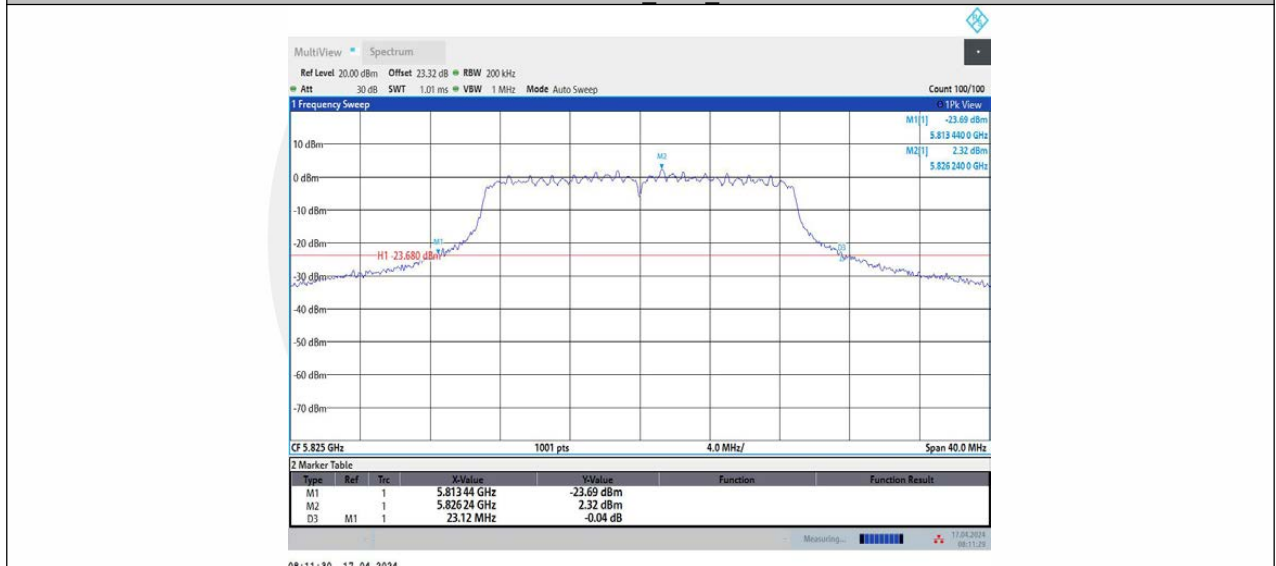

11N40MIMO\_Ant1\_5190

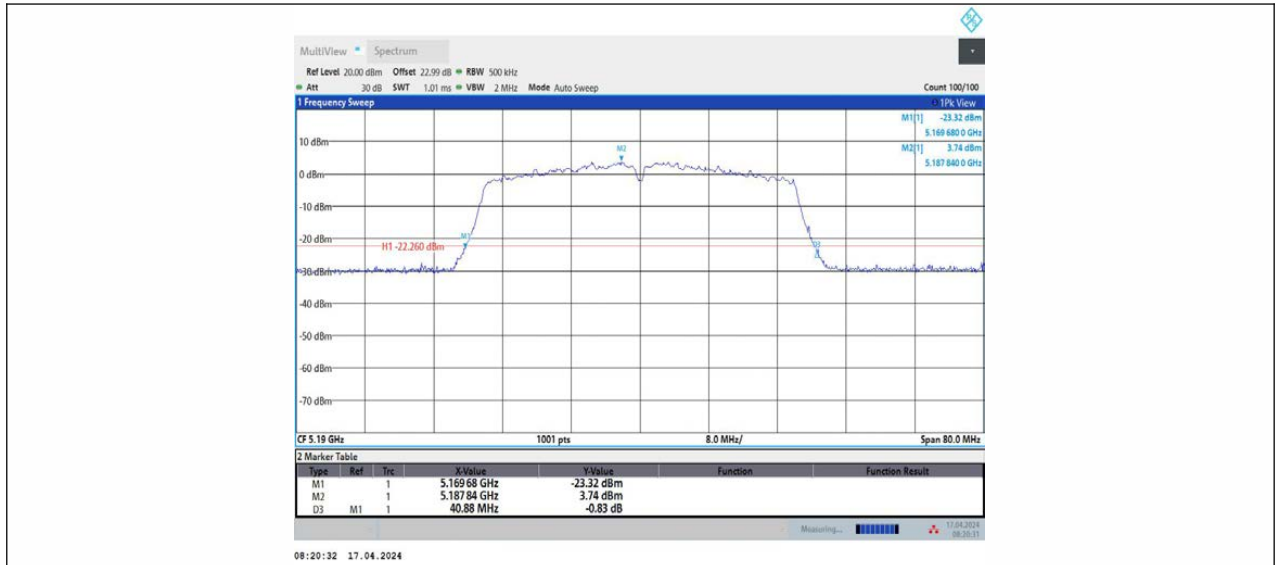

11N40MIMO\_Ant2\_5190

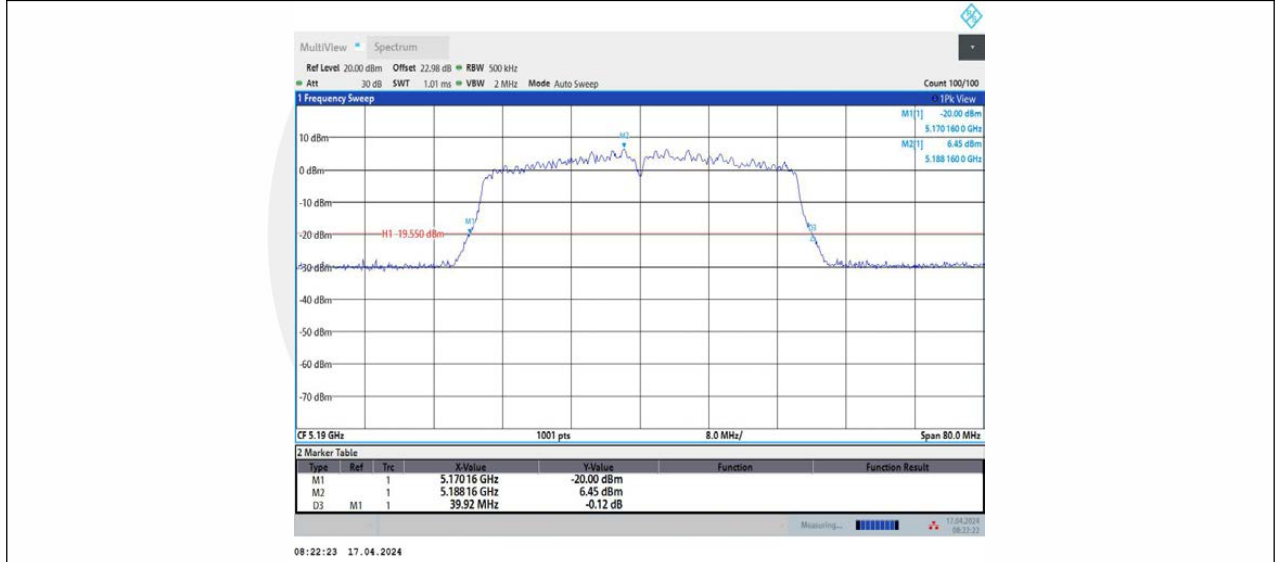

11N40MIMO\_Ant1\_5230



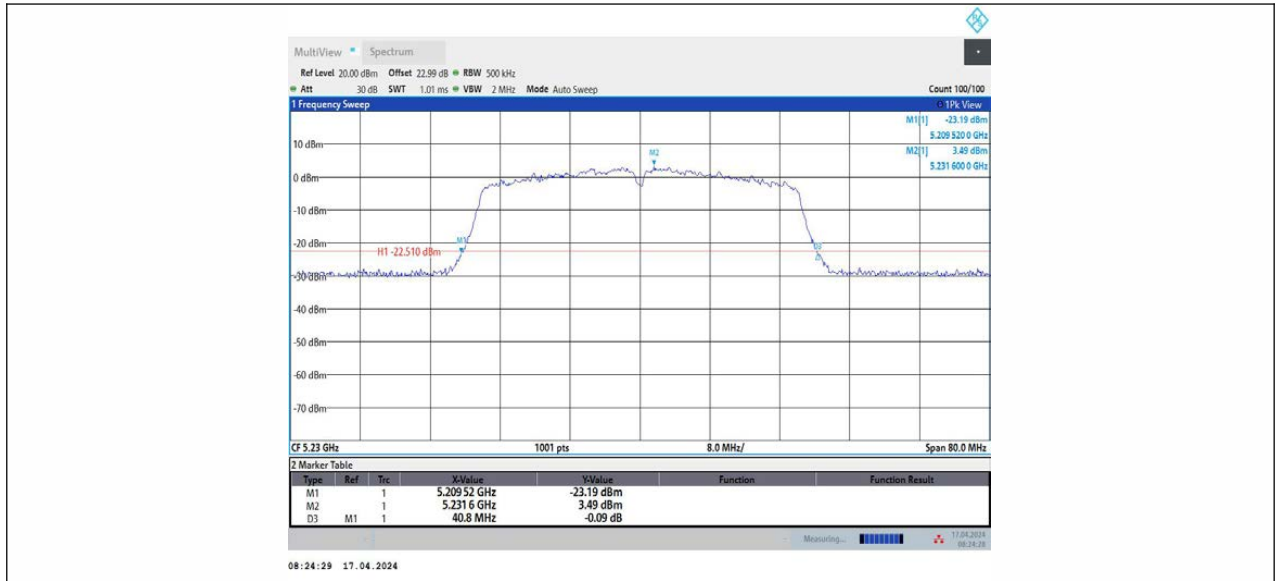

11N40MIMO\_Ant2\_5230

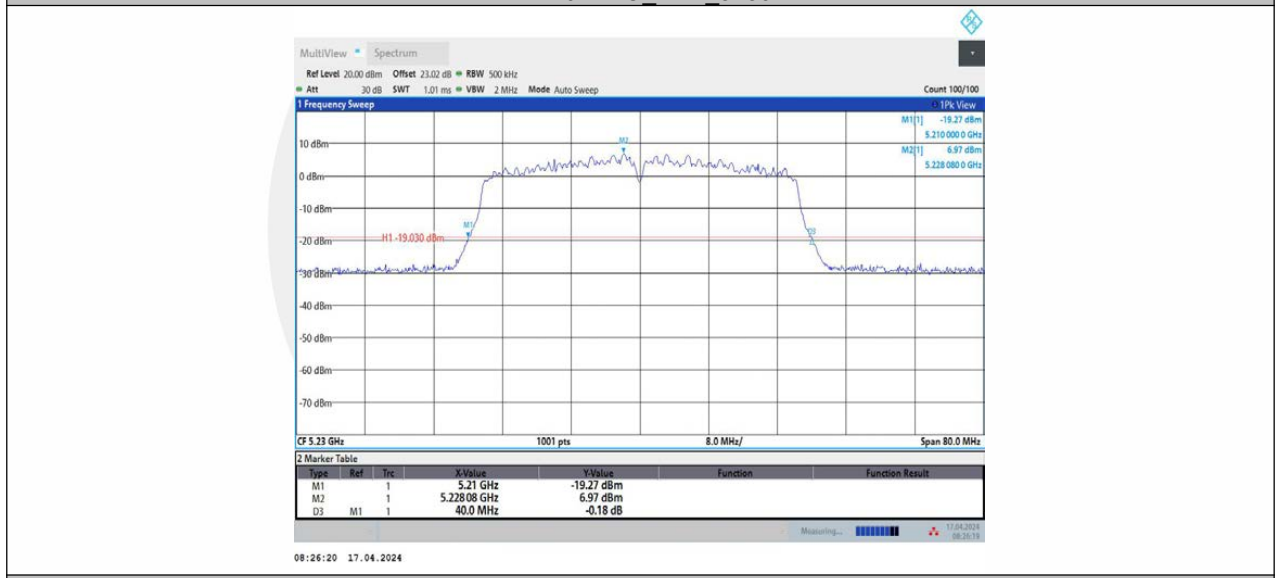

11N40MIMO\_Ant1\_5270

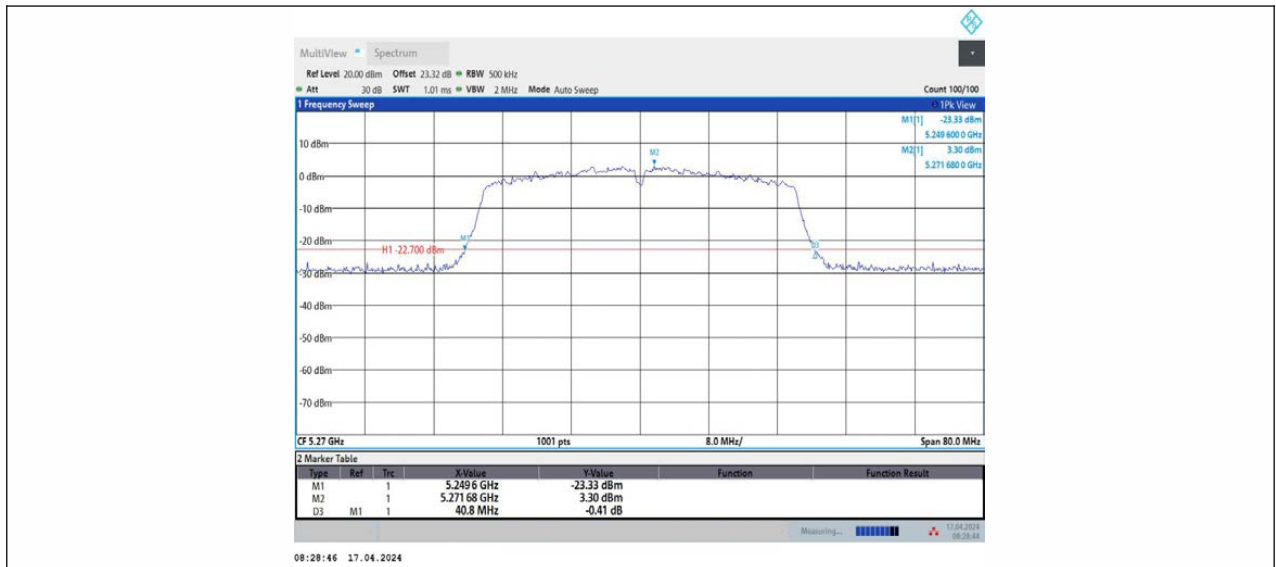

11N40MIMO\_Ant2\_5270

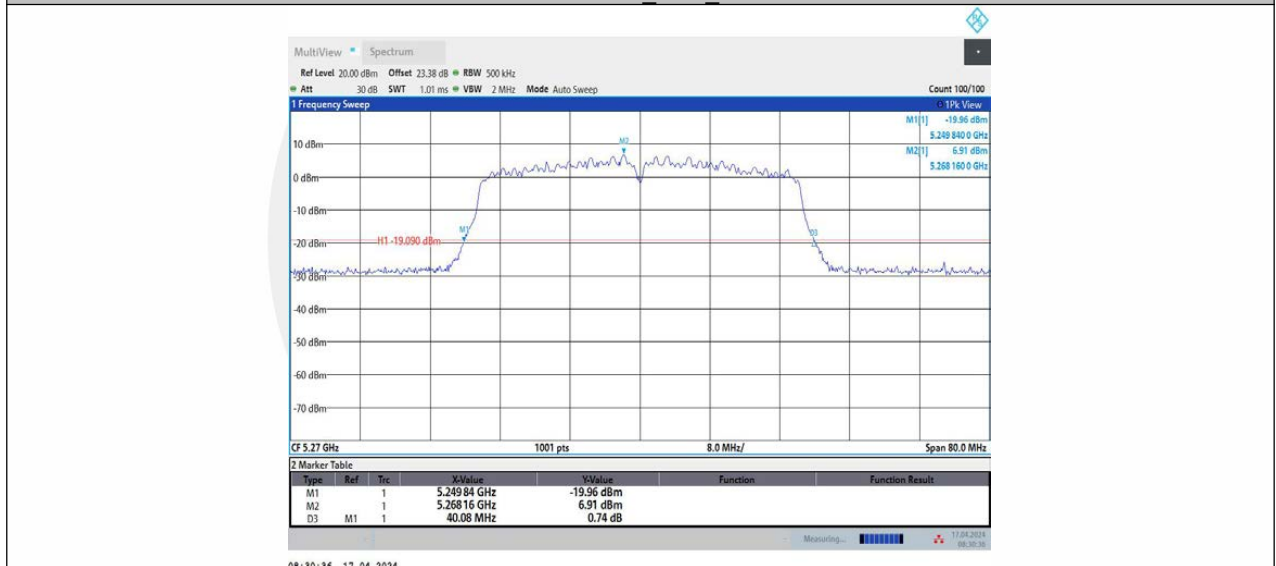

11N40MIMO\_Ant1\_5310

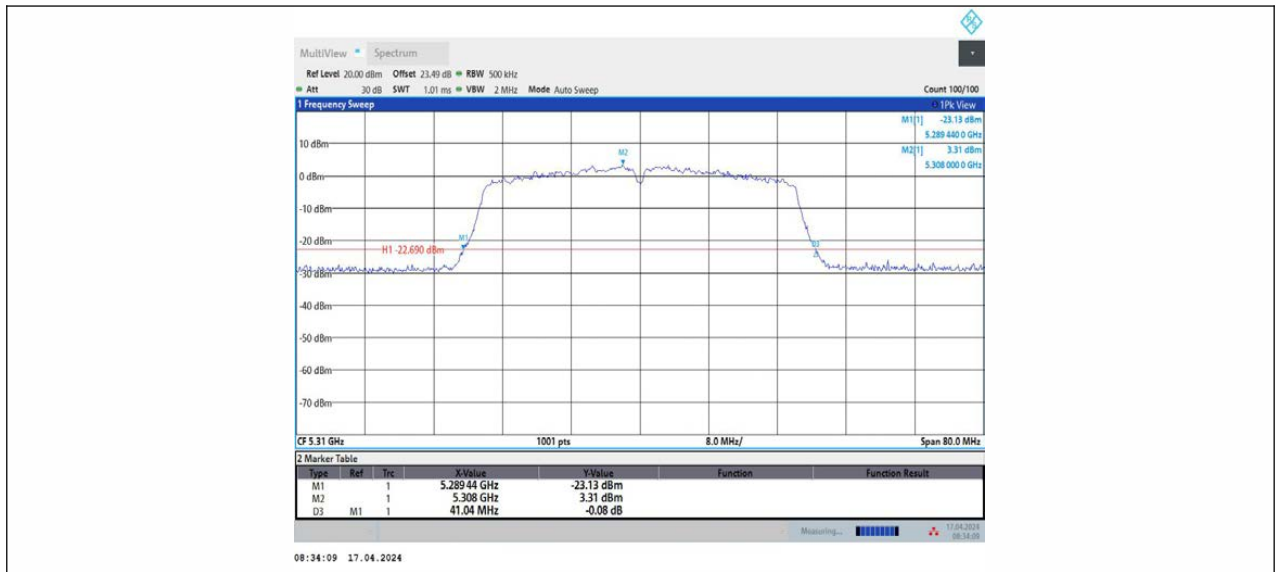

11N40MIMO\_Ant2\_5310

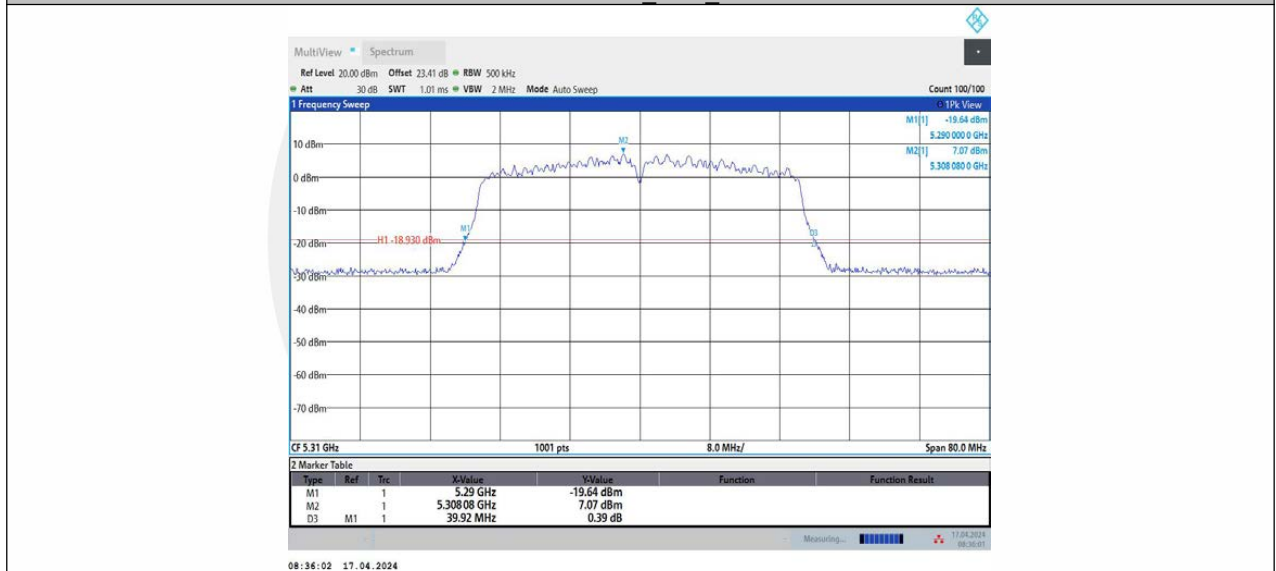

11N40MIMO\_Ant1\_5510

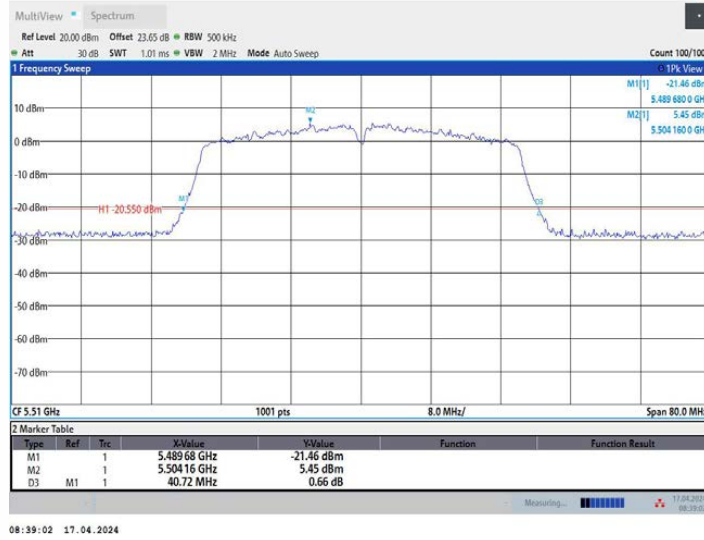

11N40MIMO\_Ant2\_5510

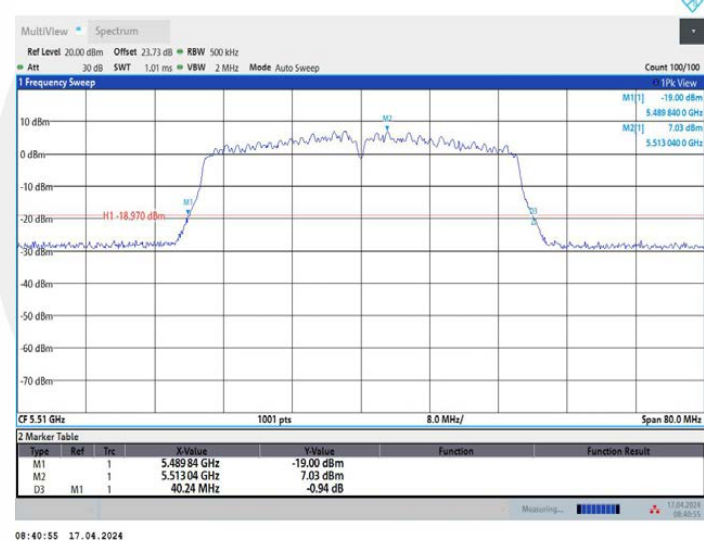

11N40MIMO\_Ant1\_5550

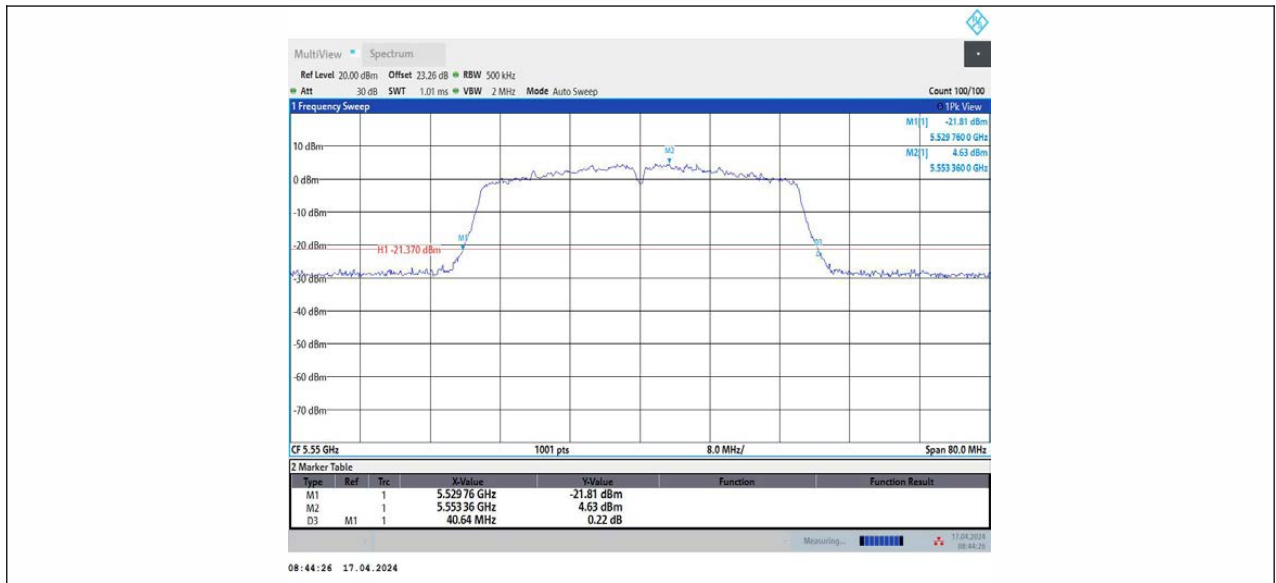

11N40MIMO\_Ant2\_5550

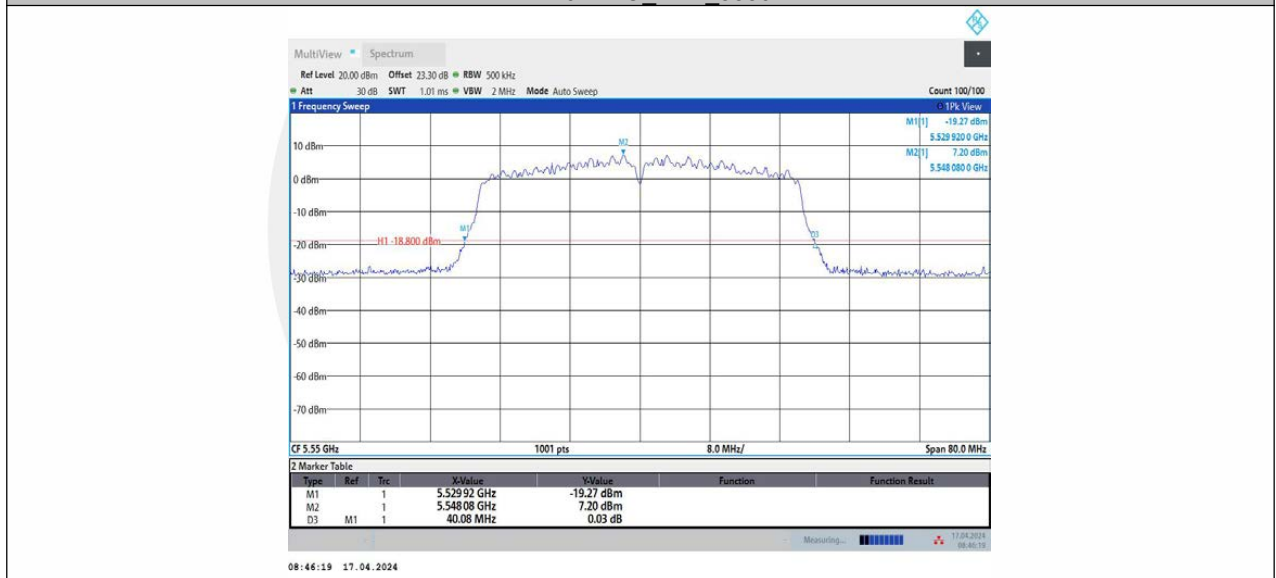

11N40MIMO\_Ant1\_5670

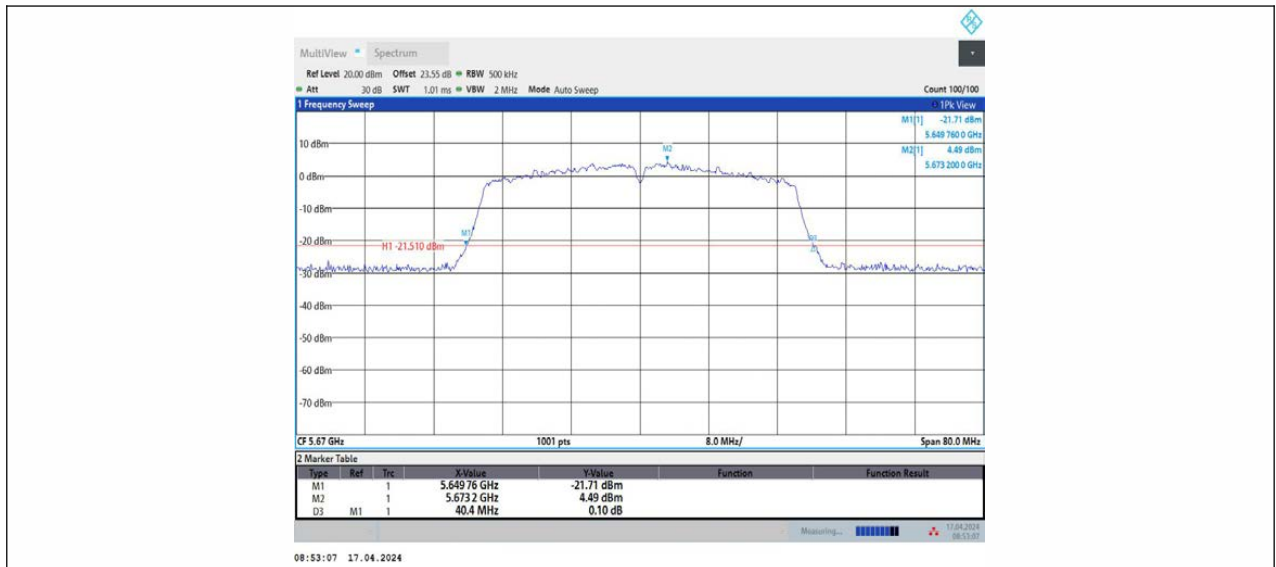

11N40MIMO\_Ant2\_5670

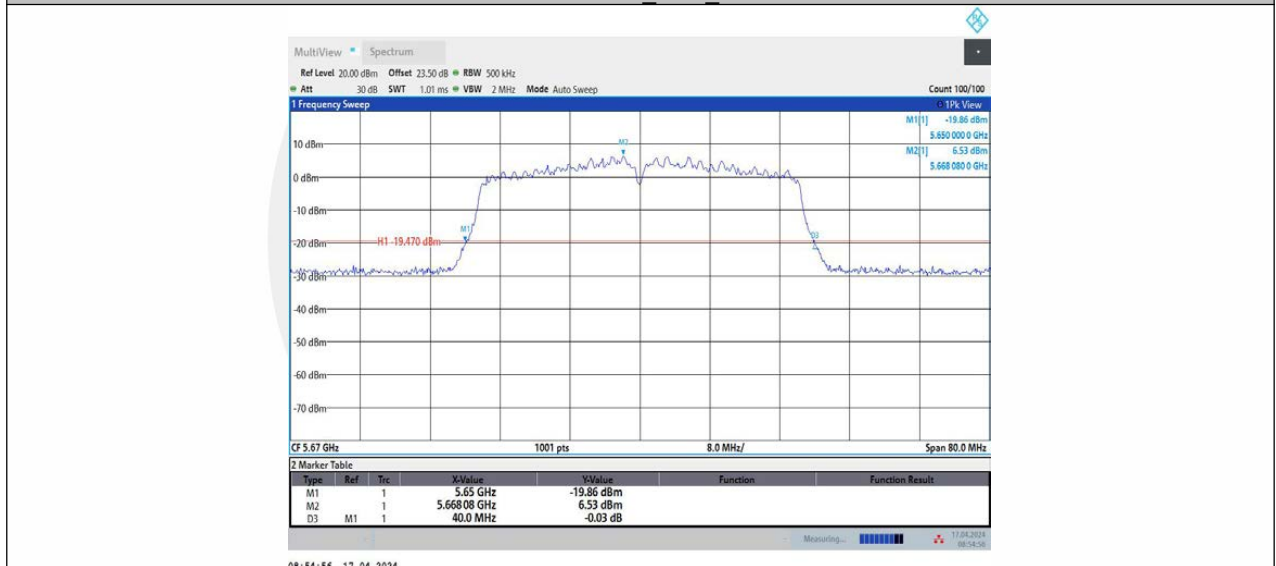

11N40MIMO\_Ant1\_5755

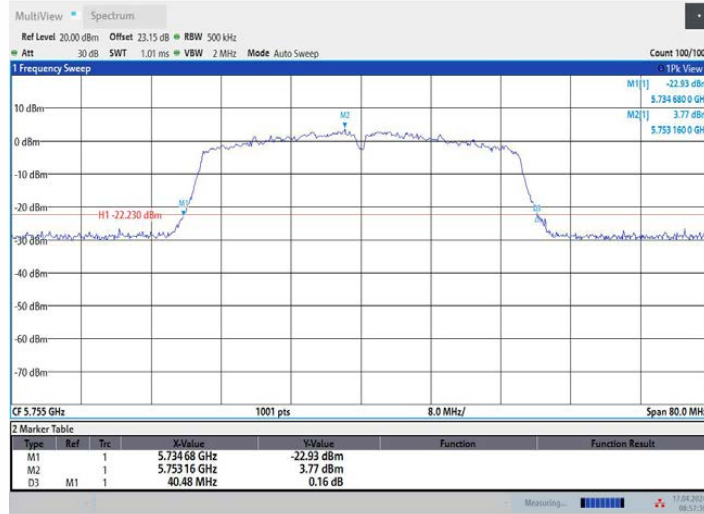

11N40MIMO\_Ant2\_5755

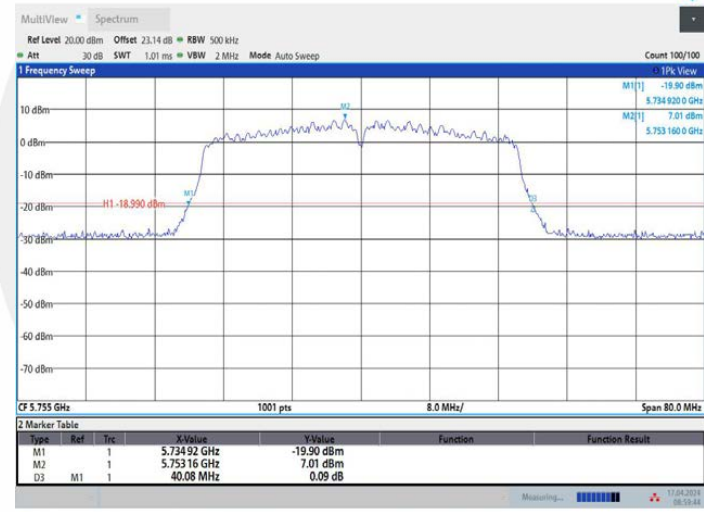

11N40MIMO\_Ant1\_5795



09:02:20 17.04.2024

11N40MIMO\_Ant2\_5795

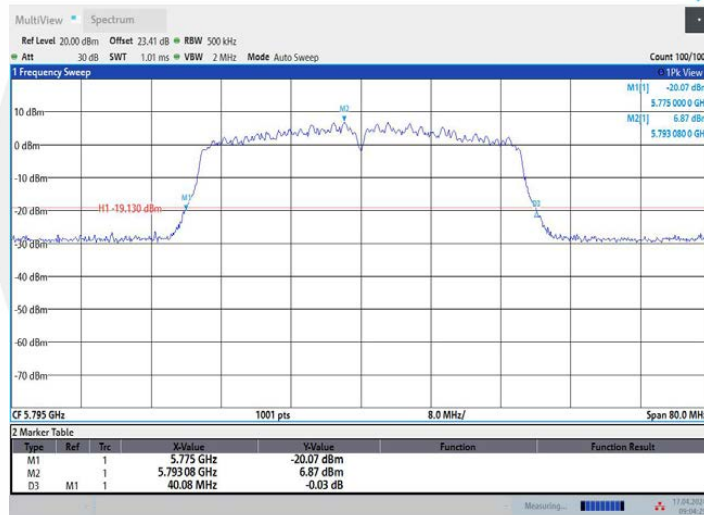

09:04:29 17.04.2024

11AC20MIMO\_Ant1\_5180



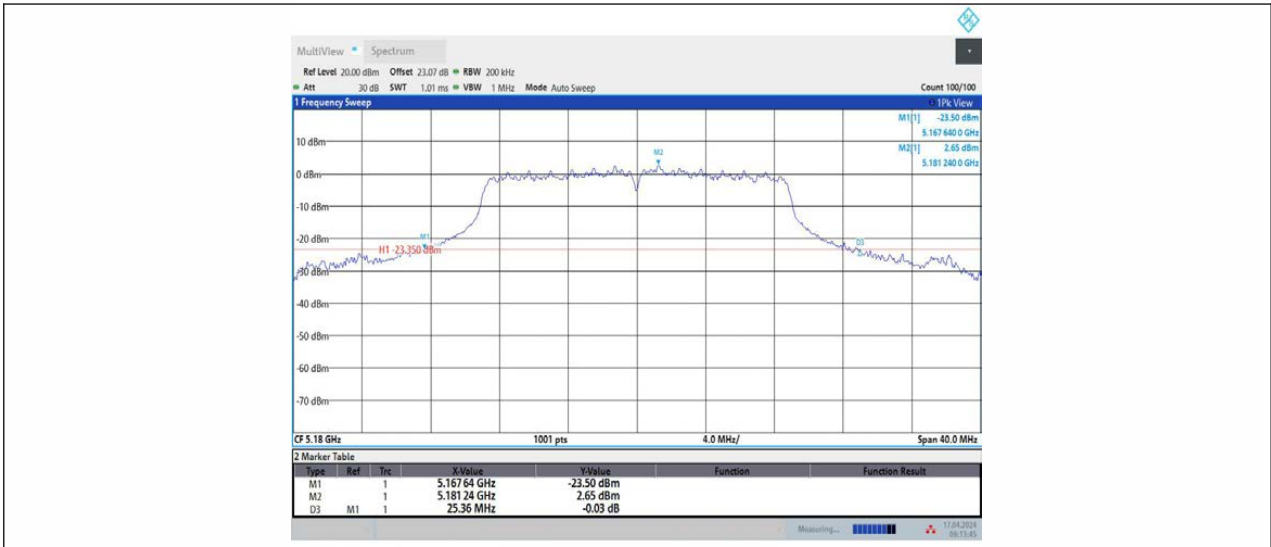

11AC20MIMO\_Ant2\_5180

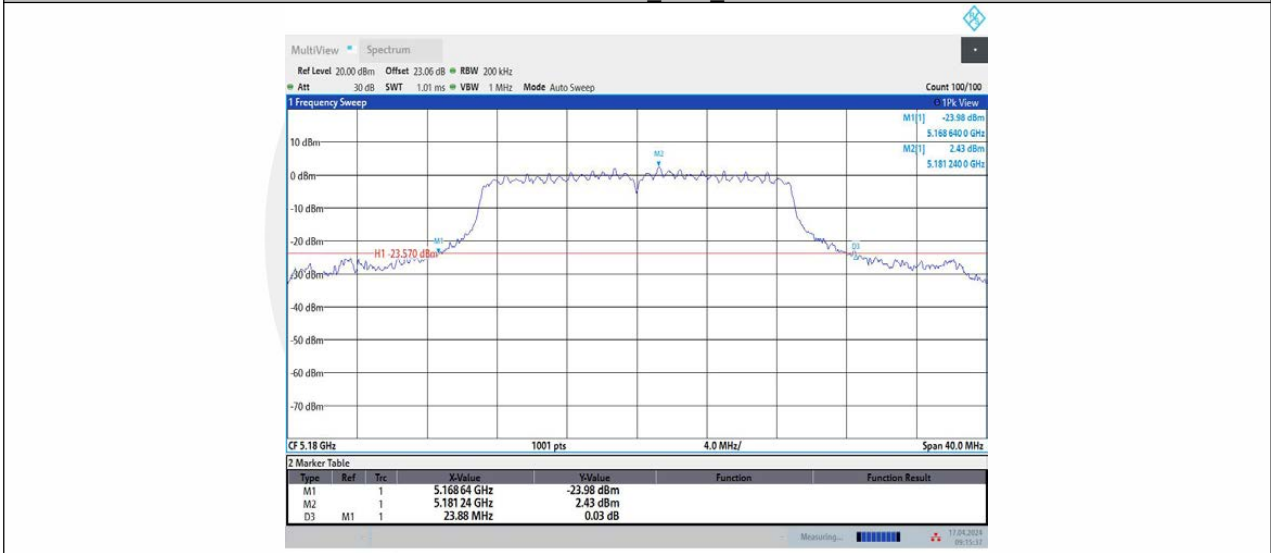

11AC20MIMO\_Ant1\_5200

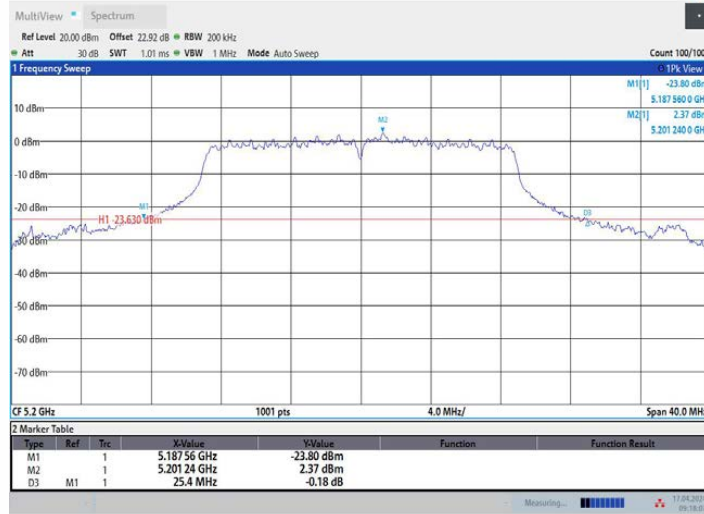

11AC20MIMO\_Ant2\_5200

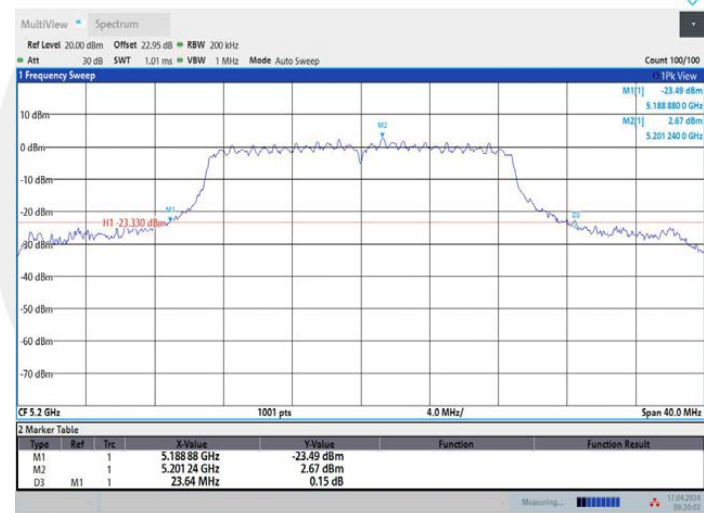

11AC20MIMO\_Ant1\_5240

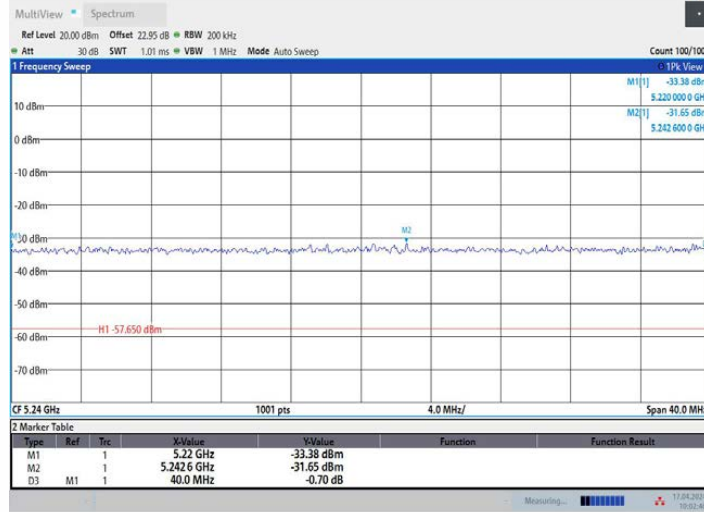

10:02:47 17.04.2024

11AC20MIMO\_Ant2\_5240



09:36:52 17.04.2024

11AC20MIMO\_Ant1\_5260

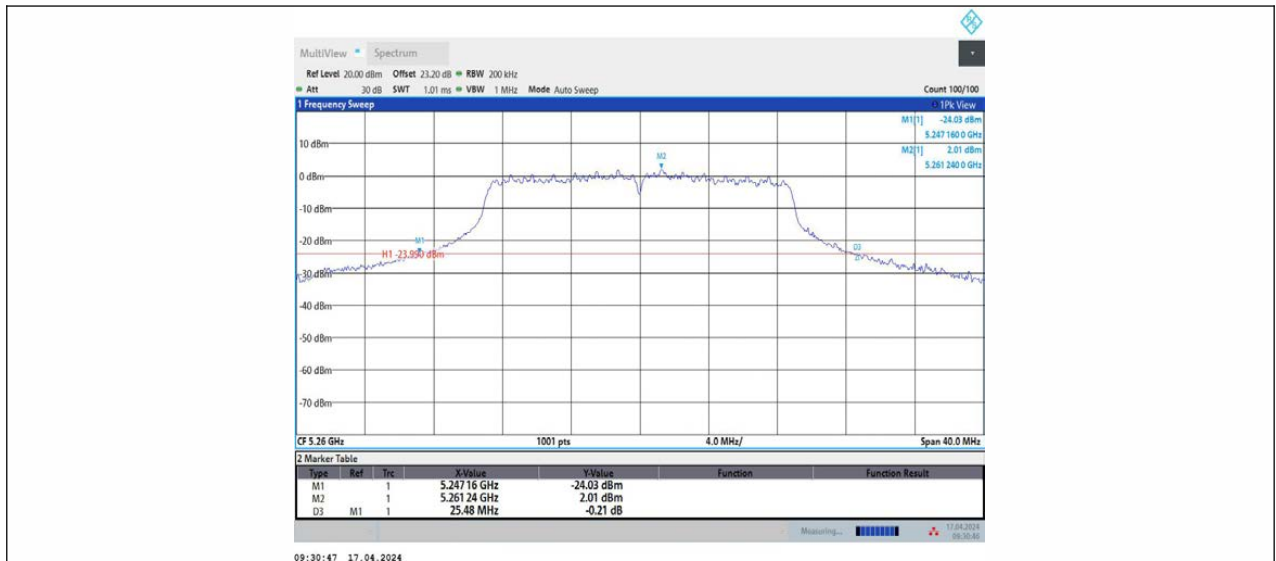

11AC20MIMO\_Ant2\_5260

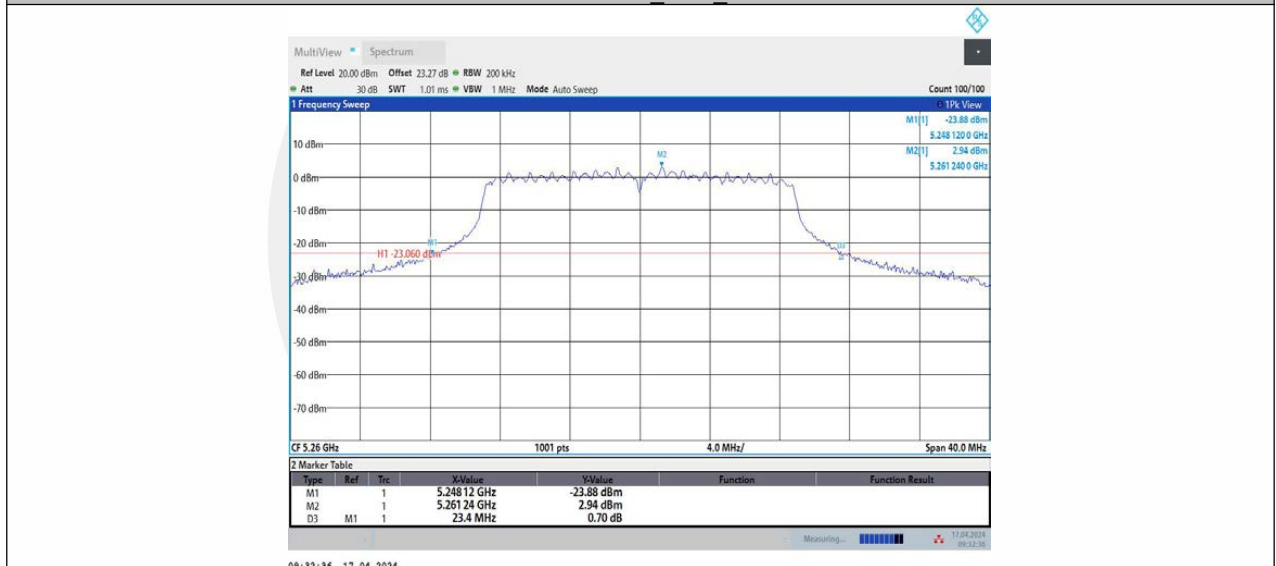

11AC20MIMO\_Ant1\_5280

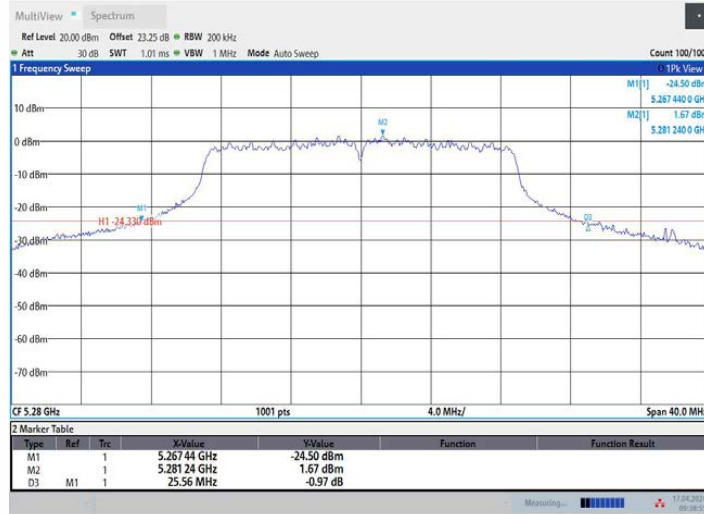

09:38:56 17.04.2024

11AC20MIMO\_Ant2\_5280

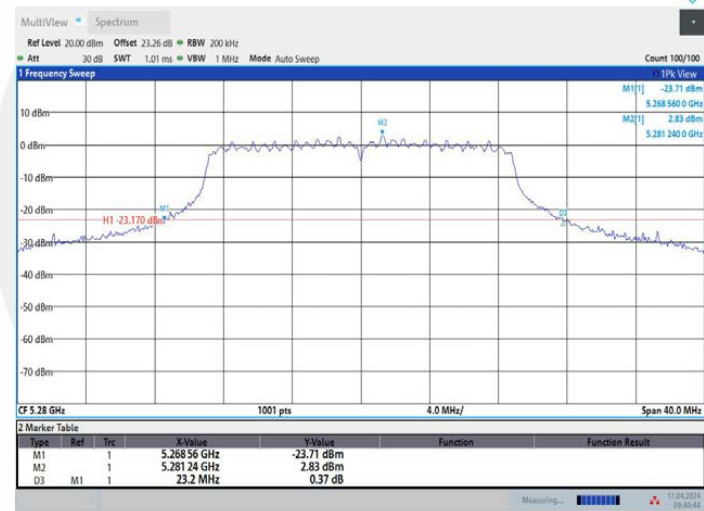

09:40:44 17.04.2024

11AC20MIMO\_Ant1\_5320

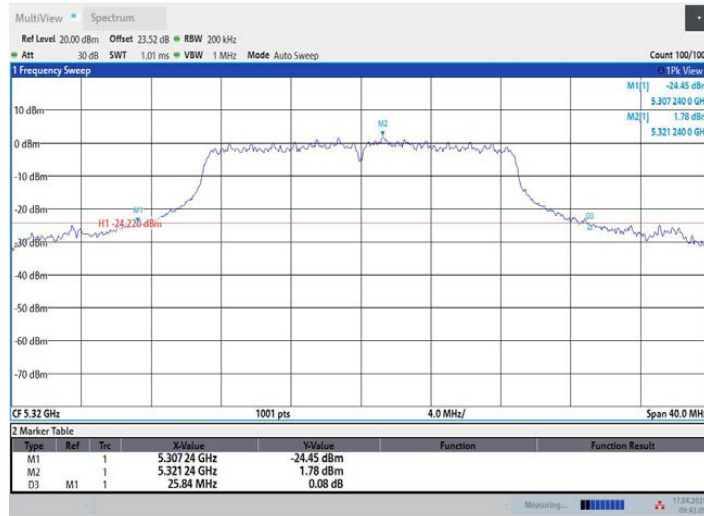

11AC20MIMO\_Ant2\_5320

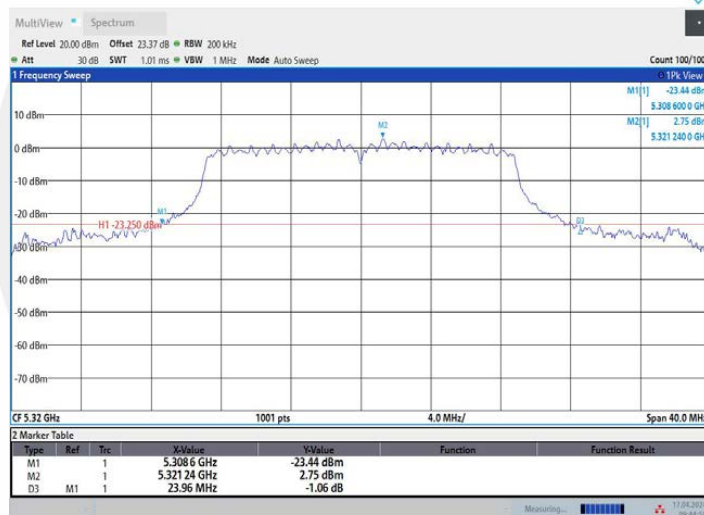

11AC20MIMO\_Ant1\_5500

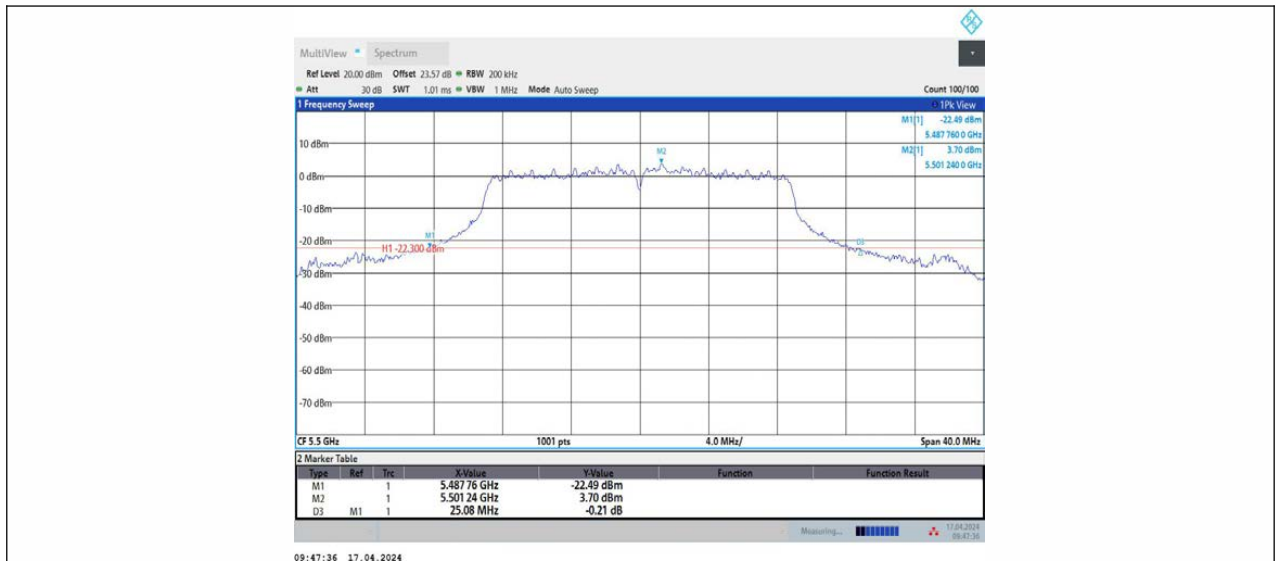

09:47:36 17.04.2024

11AC20MIMO\_Ant2\_5500

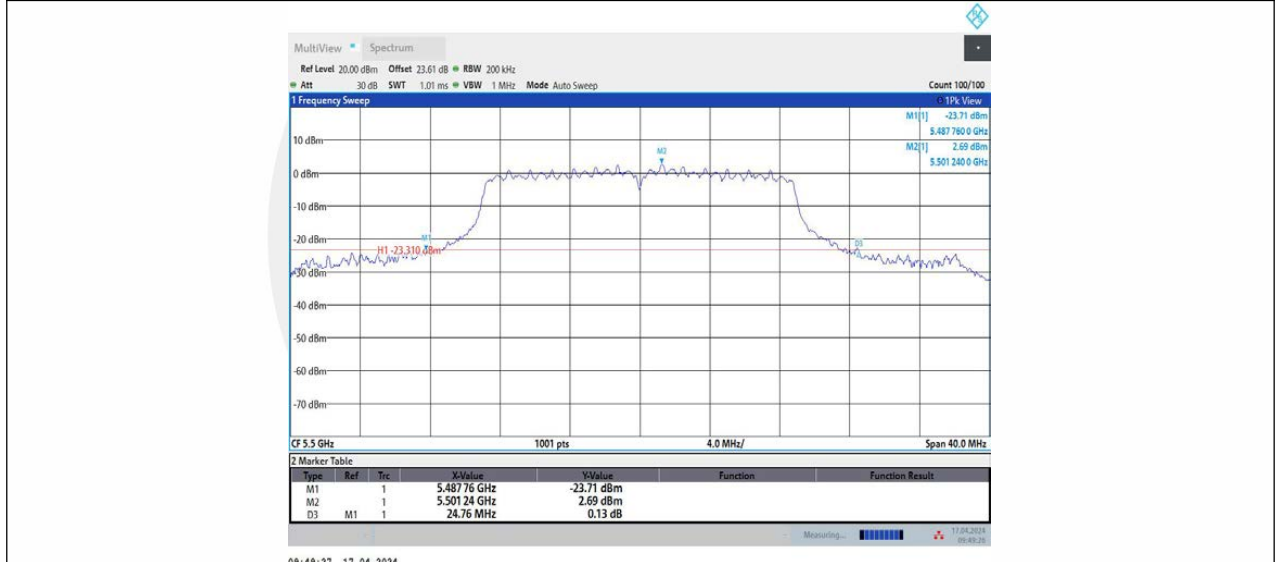

09:49:27 17.04.2024

11AC20MIMO\_Ant1\_5580

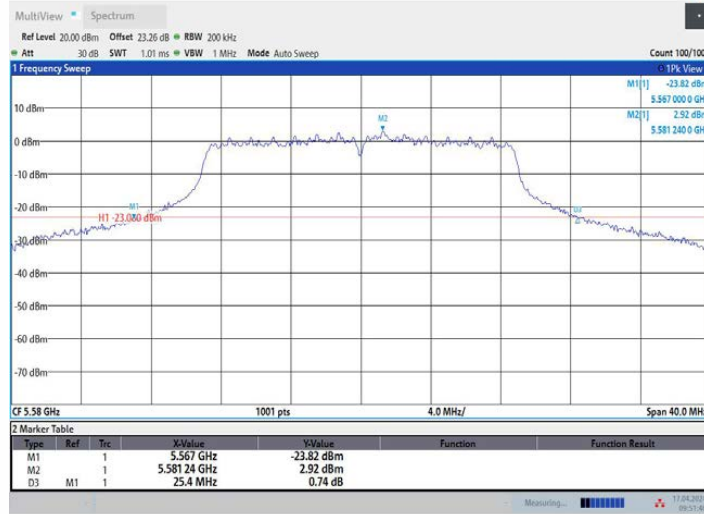

09:51:46 17.04.2024

11AC20MIMO\_Ant2\_5580



09:53:36 17.04.2024

11AC20MIMO\_Ant1\_5700



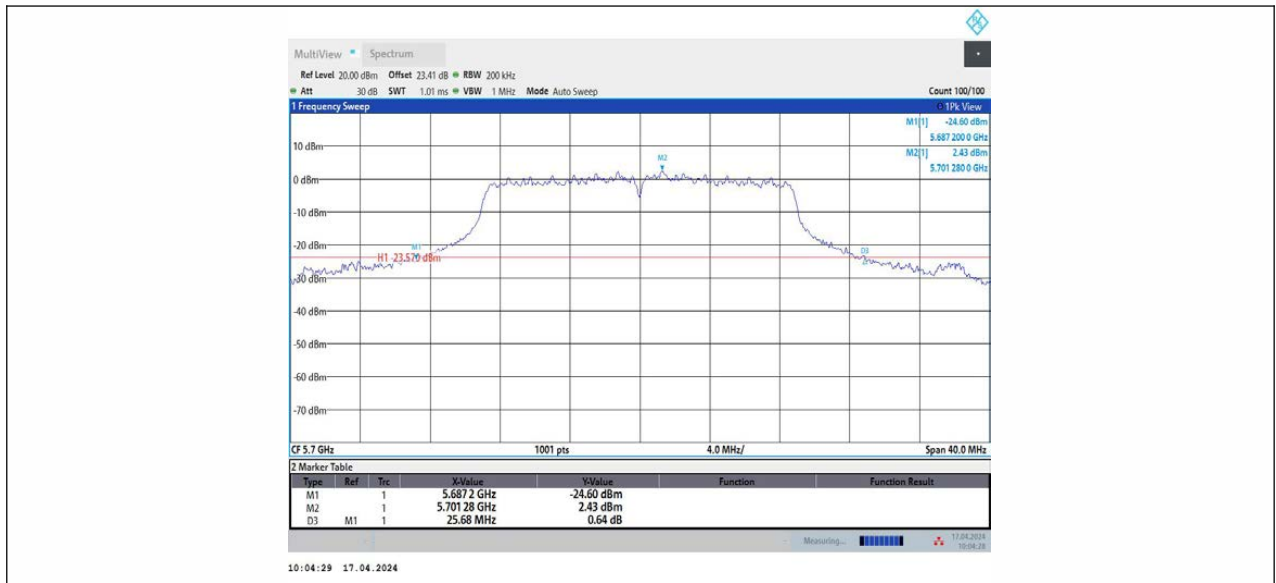

11AC20MIMO\_Ant2\_5700

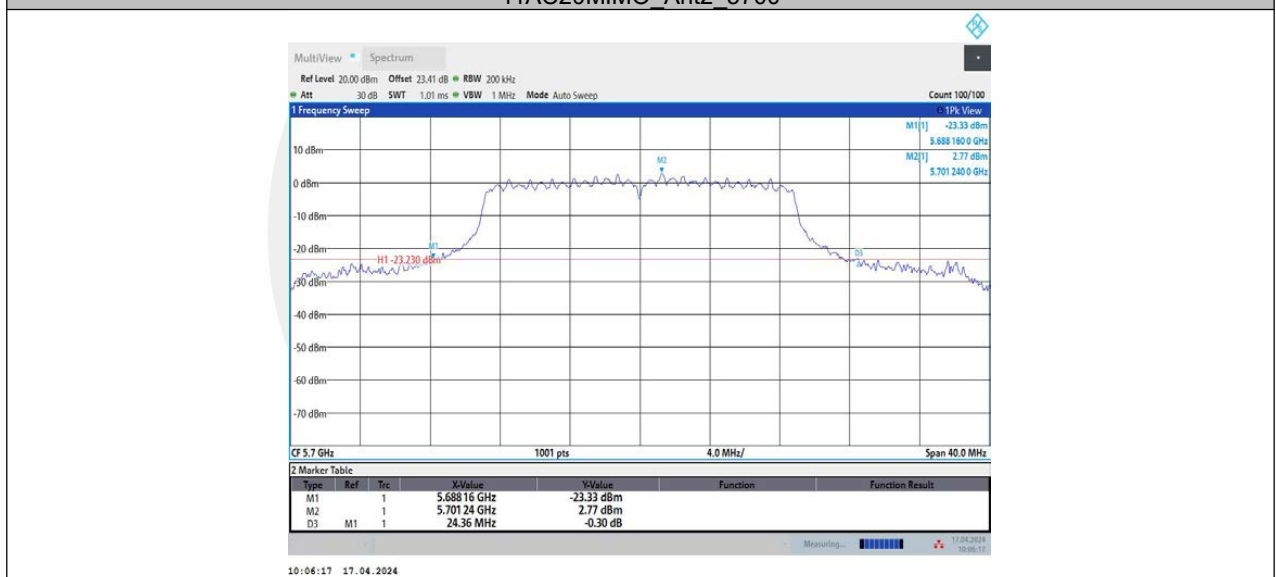

11AC20MIMO\_Ant1\_5745

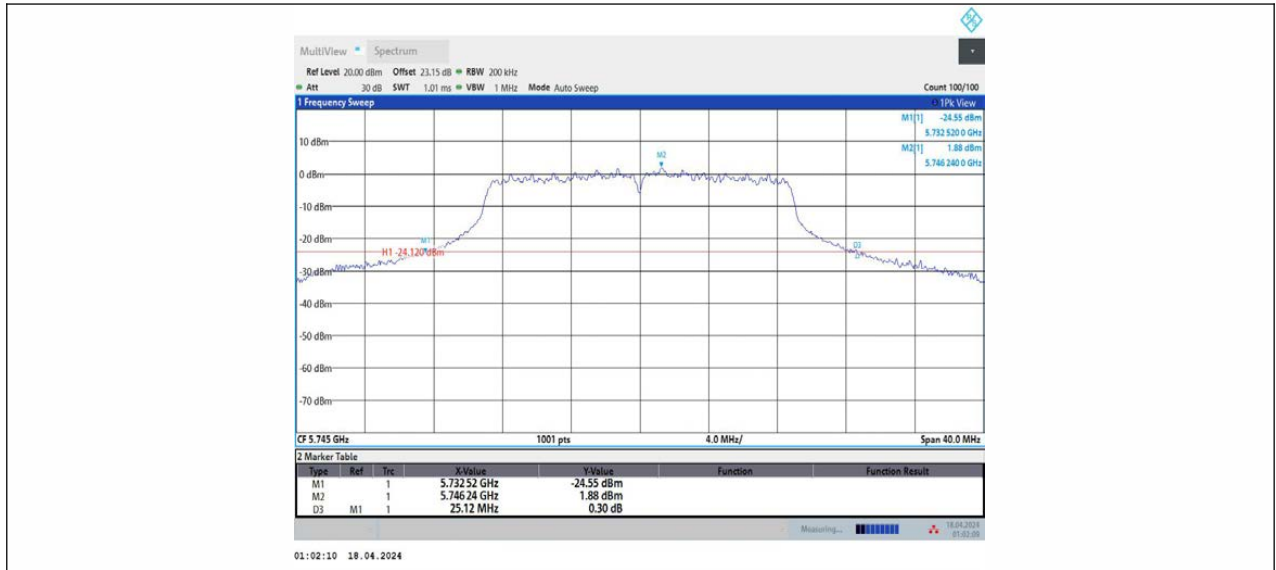

11AC20MIMO\_Ant2\_5745

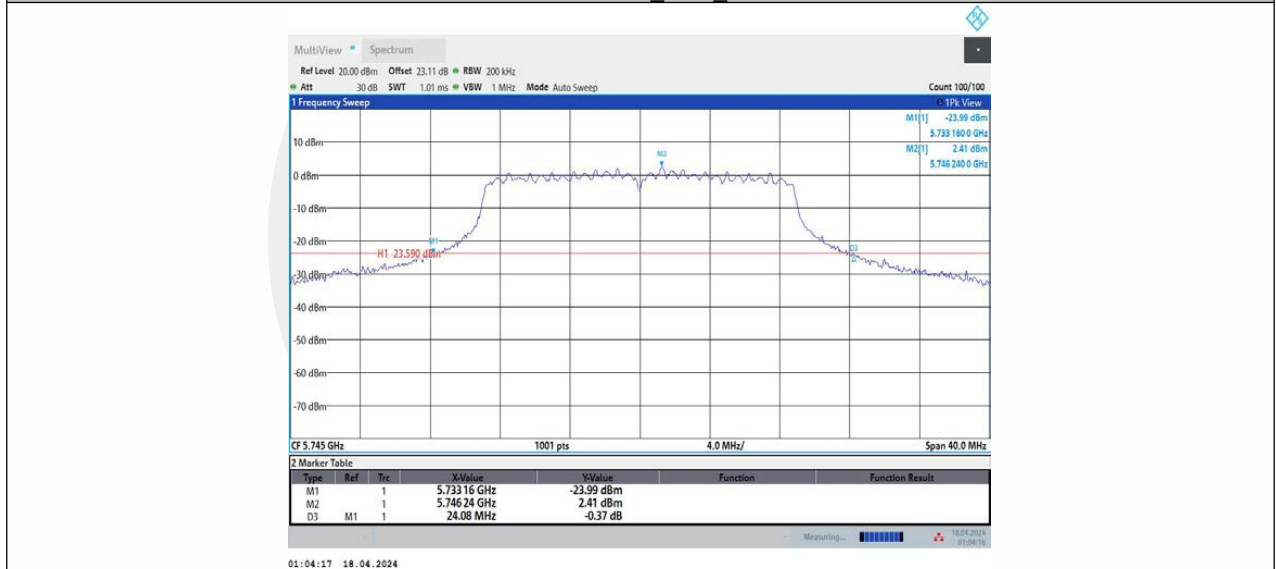

11AC20MIMO\_Ant1\_5785

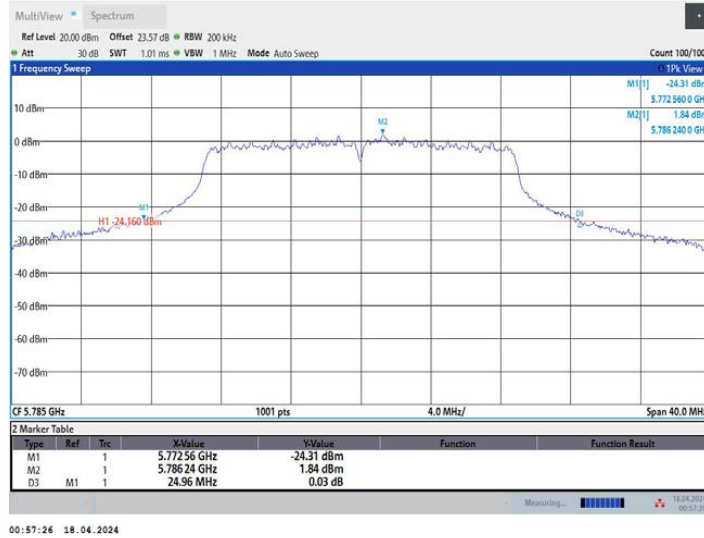

11AC20MIMO\_Ant2\_5785

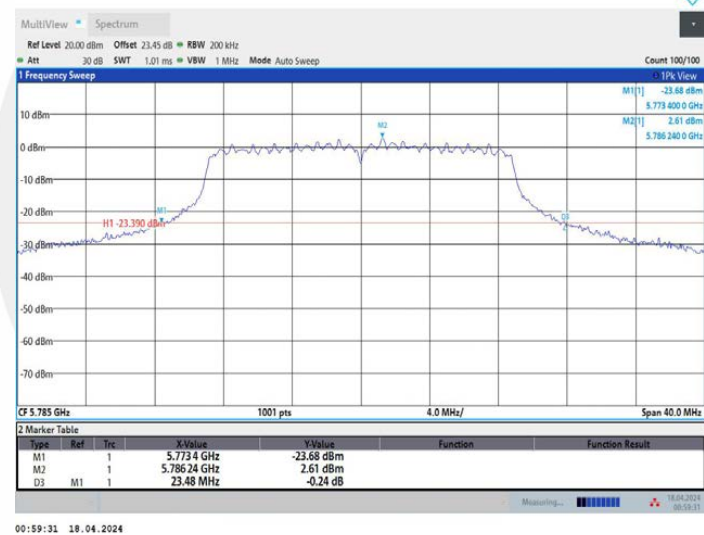

11AC20MIMO\_Ant1\_5825

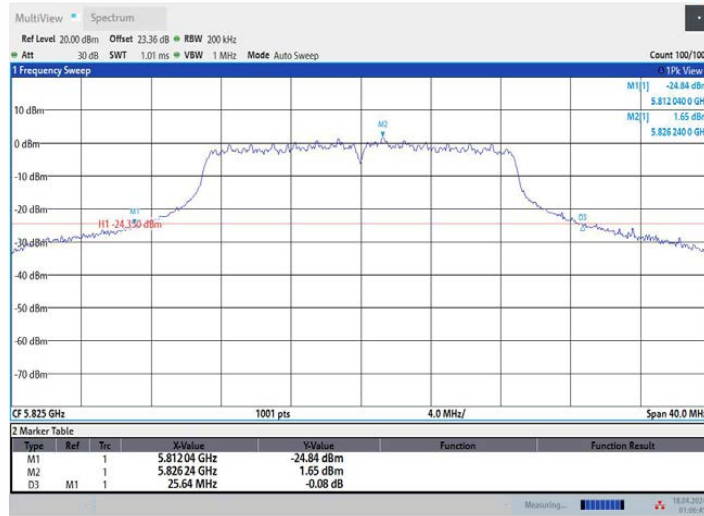

01:06:46 18.04.2024

11AC20MIMO Ant2 5825

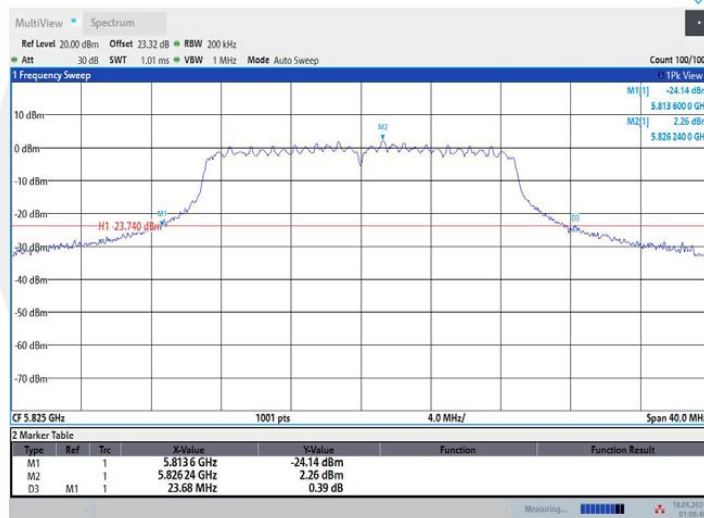

01:08:47 18.04.2024

11AC40MIMO Ant1 5190

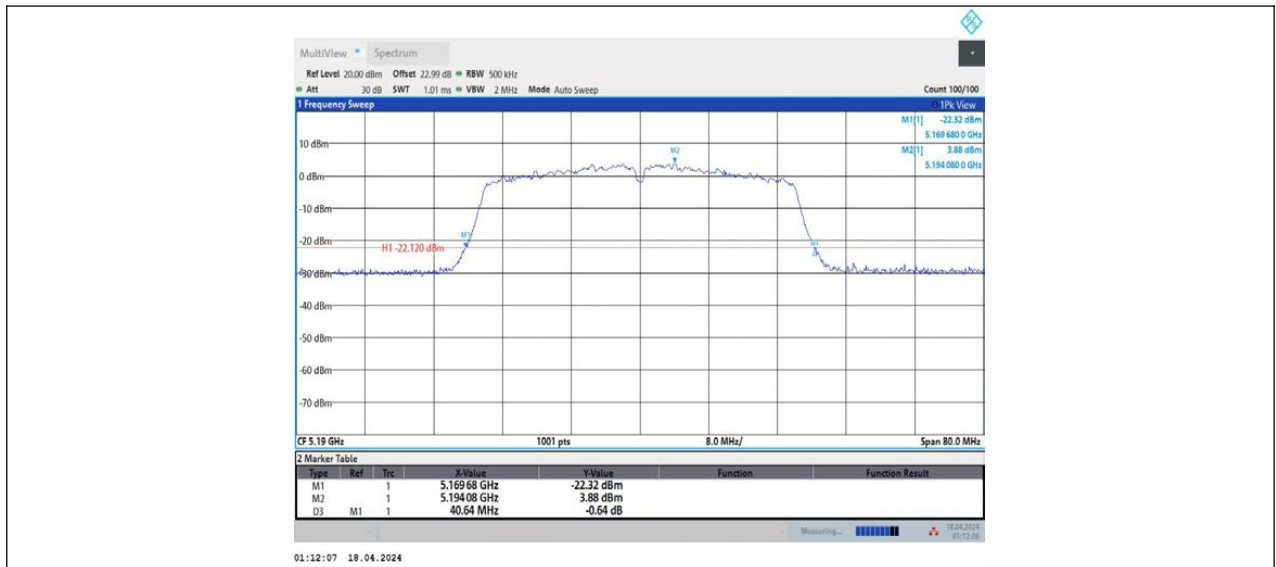

11AC40MIMO\_Ant2\_5190

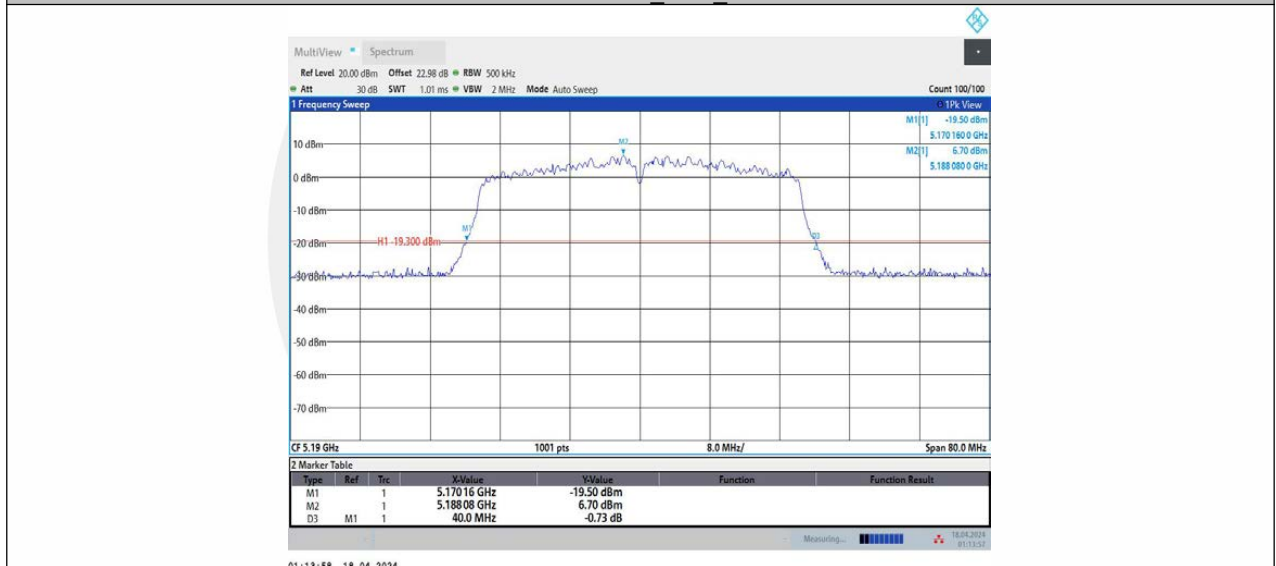

11AC40MIMO\_Ant1\_5230

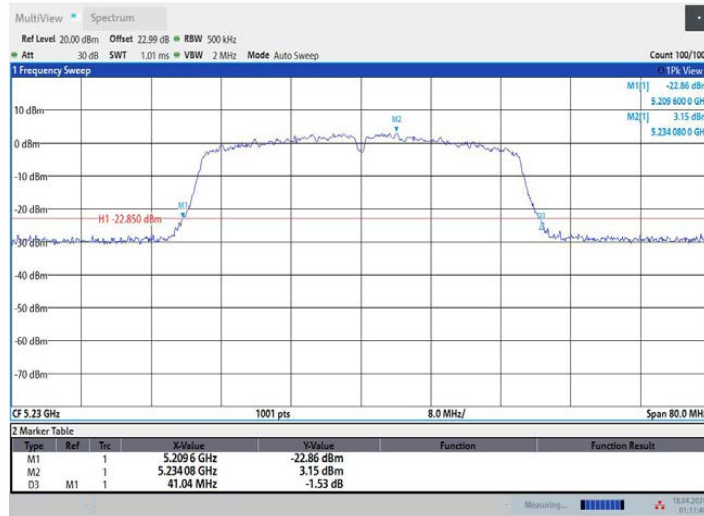

01:17:40 18.04.2024

11AC40MIMO\_Ant2\_5230

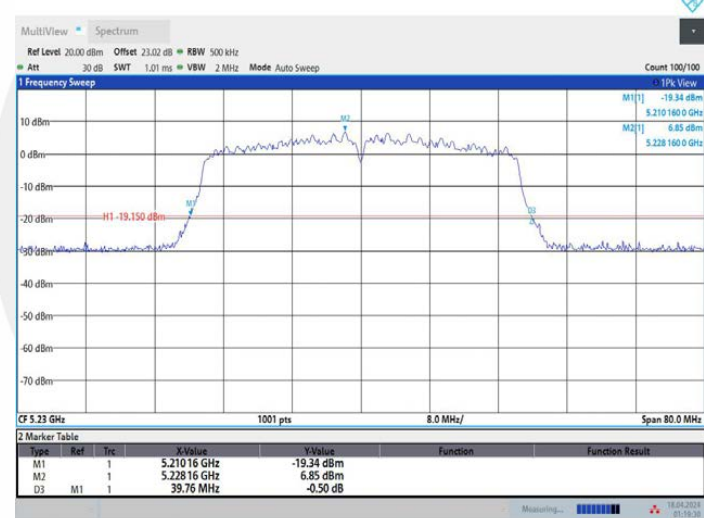

01:19:31 18.04.2024

11AC40MIMO\_Ant1\_5270

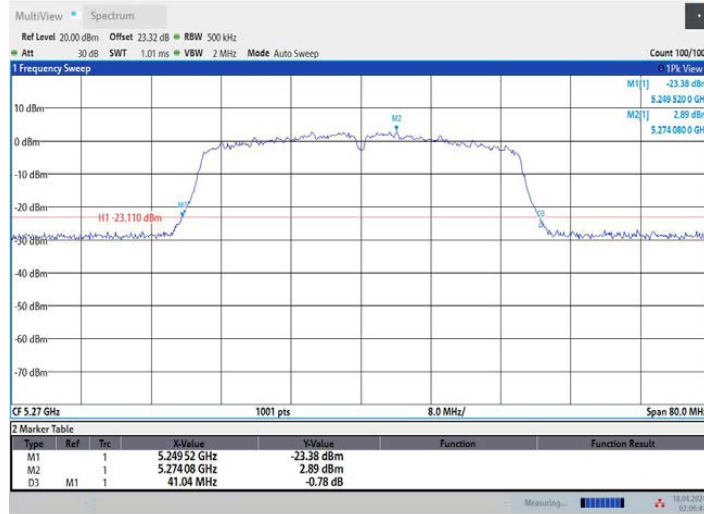

02:06:47 18.04.2024

11AC40MIMO\_Ant2\_5270

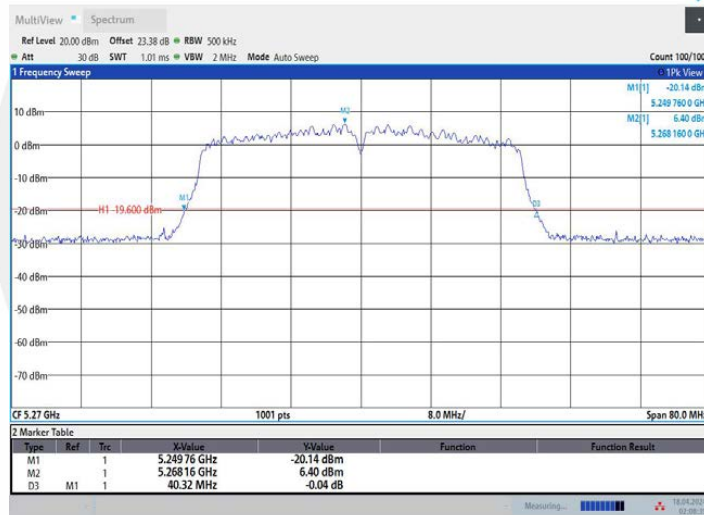

02:08:39 18.04.2024

11AC40MIMO\_Ant1\_5310

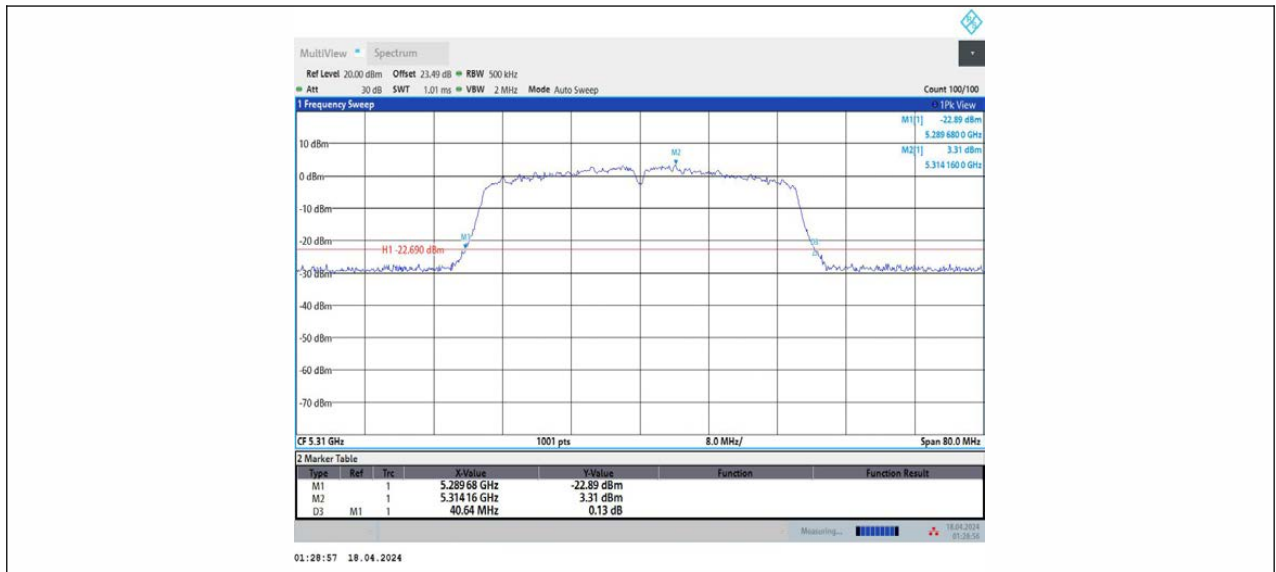

11AC40MIMO\_Ant2\_5310

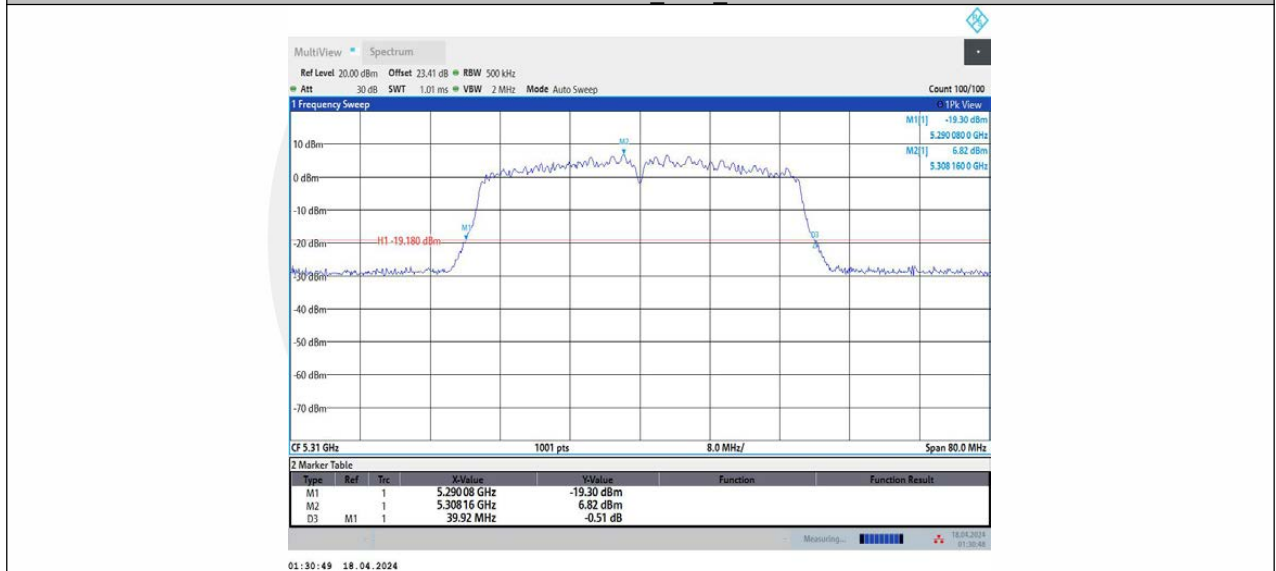

11AC40MIMO\_Ant1\_5510



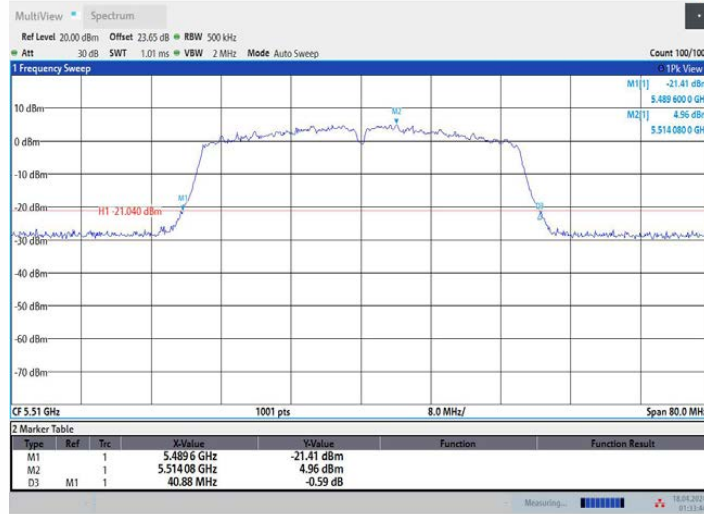

11AC40MIMO\_Ant2\_5510

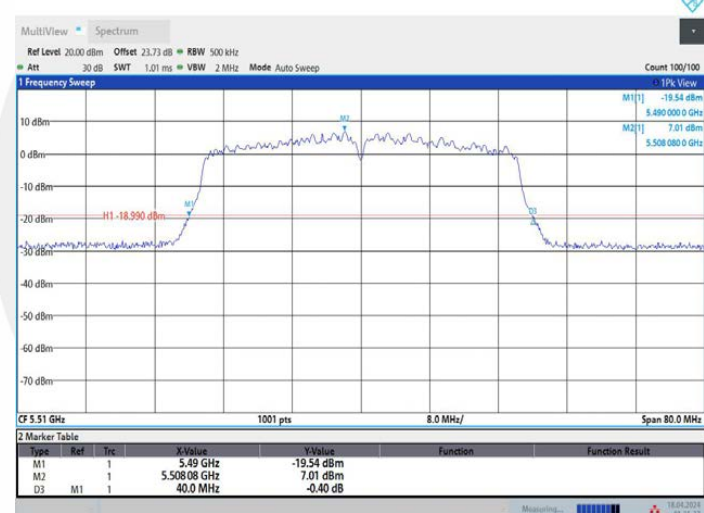

11AC40MIMO\_Ant1\_5550

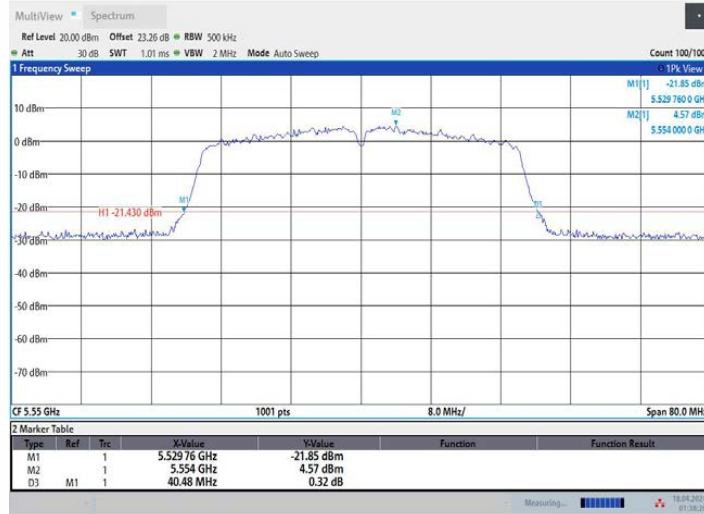

01:38:27 18.04.2024

11AC40MIMO\_Ant2\_5550



01:40:22 18.04.2024

11AC40MIMO\_Ant1\_5670

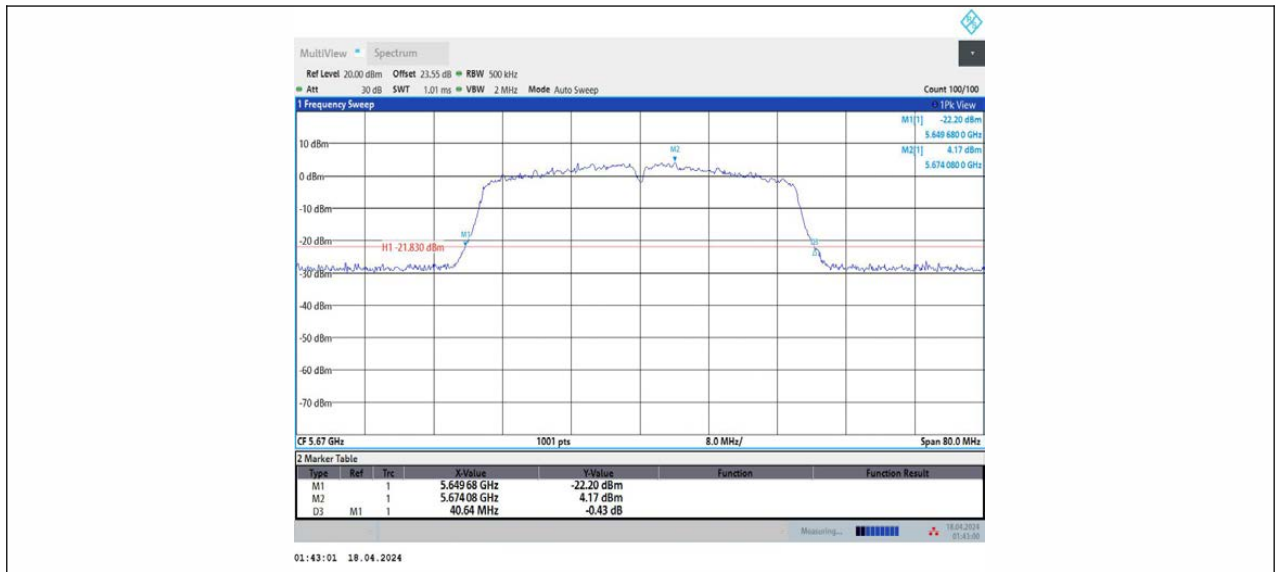

11AC40MIMO\_Ant2\_5670

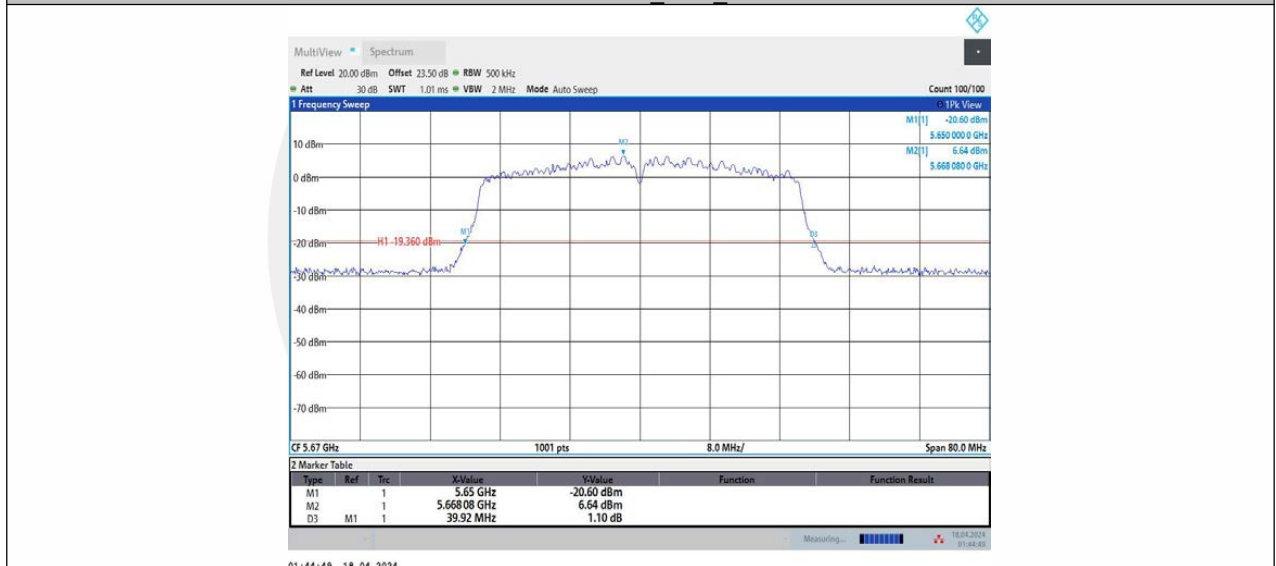

11AC40MIMO\_Ant1\_5755

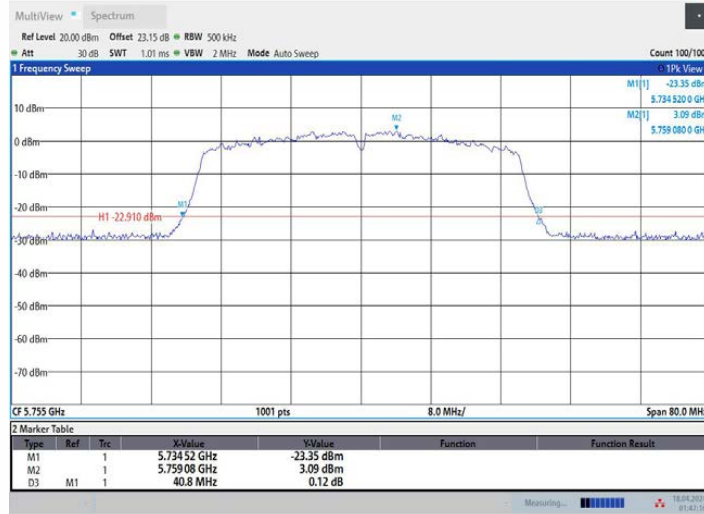

11AC40MIMO\_Ant2\_5755

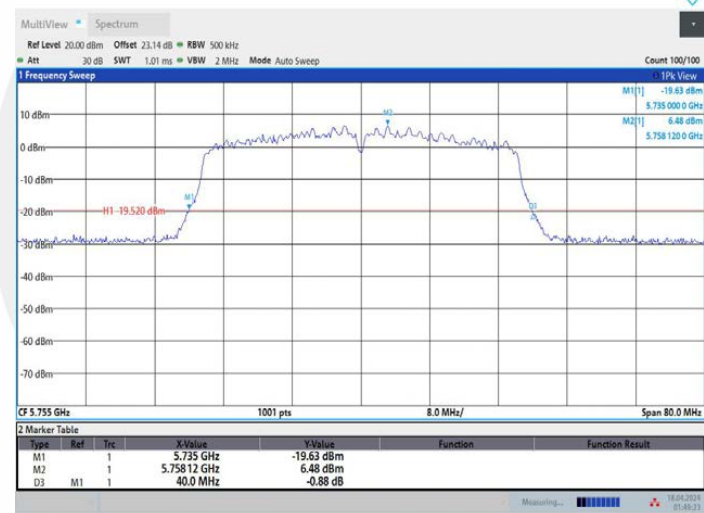

11AC40MIMO\_Ant1\_5795

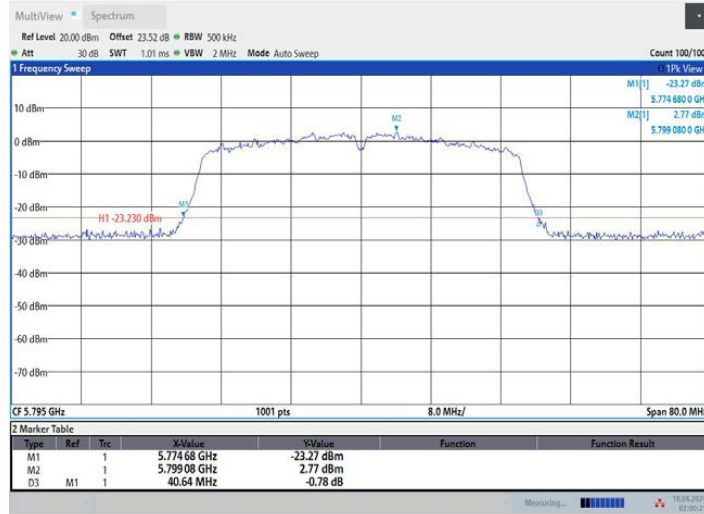

02:00:21 18.04.2024

11AC40MIMO Ant2 5795

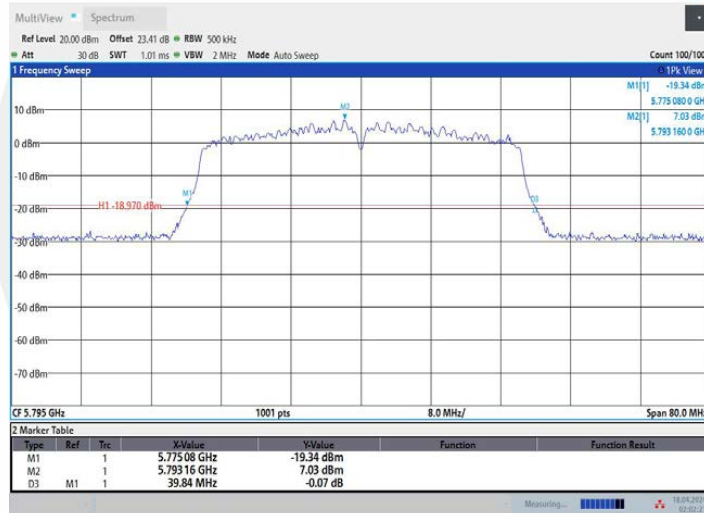

02:02:21 18.04.2024

11AC80MIMO Ant1 5210

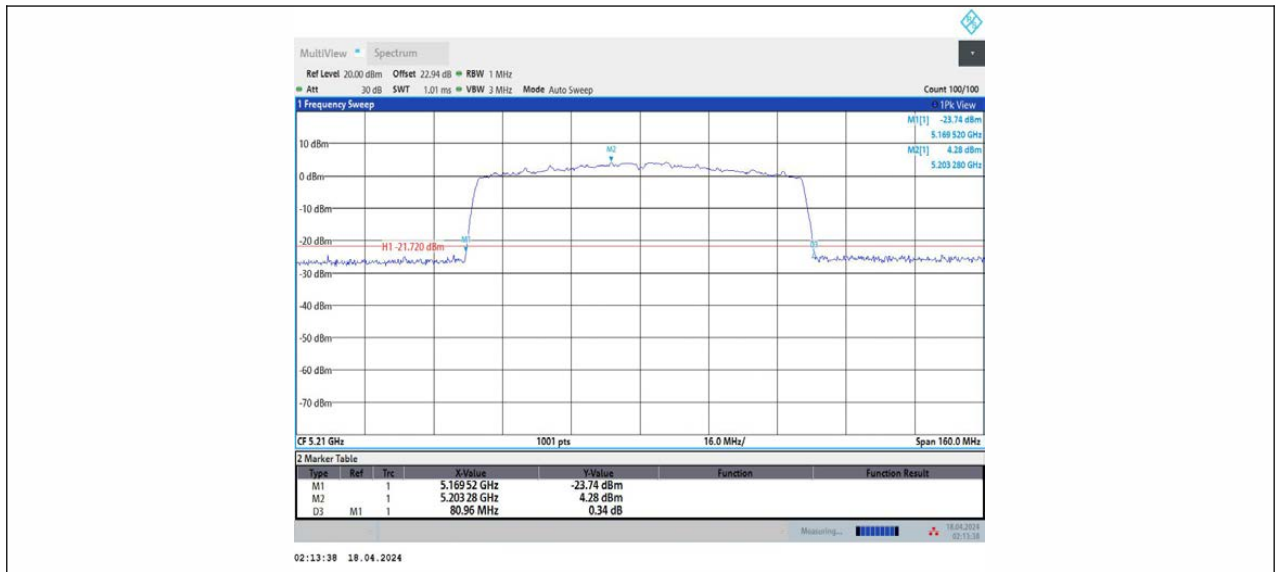

11AC80MIMO\_Ant2\_5210

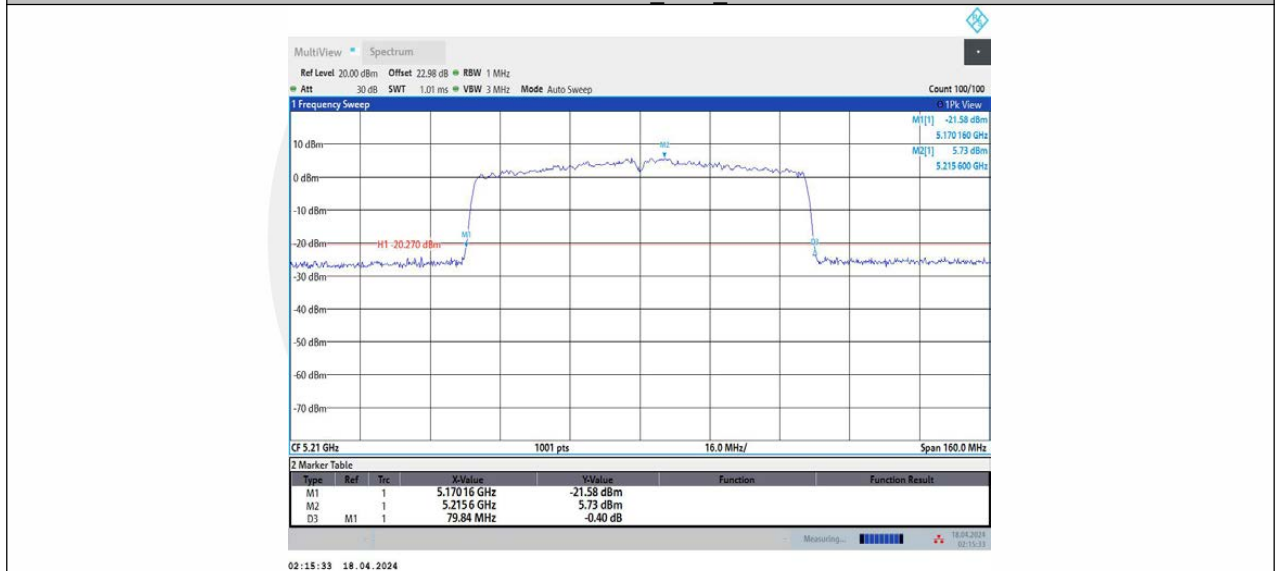

11AC80MIMO\_Ant1\_5290



11AC80MIMO\_Ant2\_5290

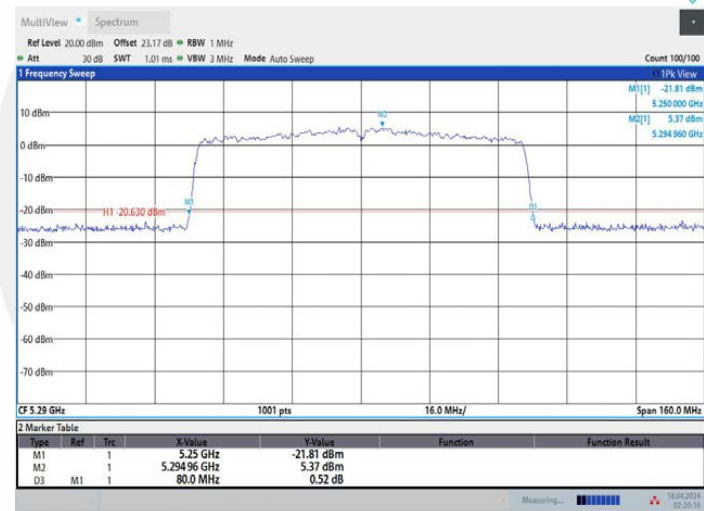

11AC80MIMO\_Ant1\_5530

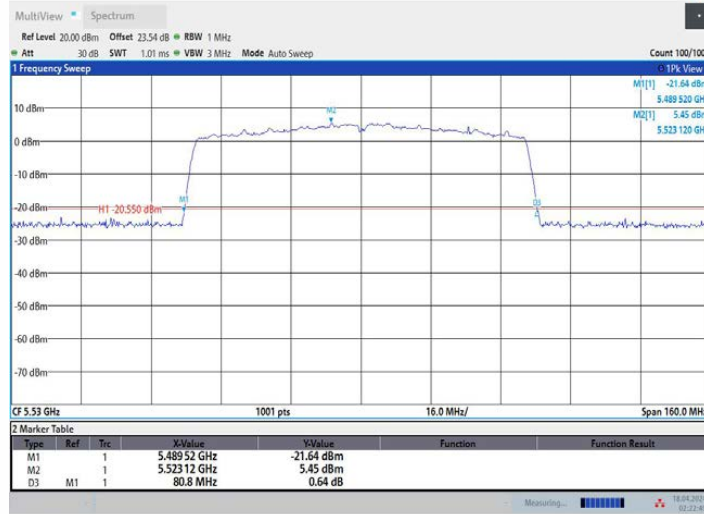

02:22:50 18.04.2024

11AC80MIMO\_Ant2\_5530

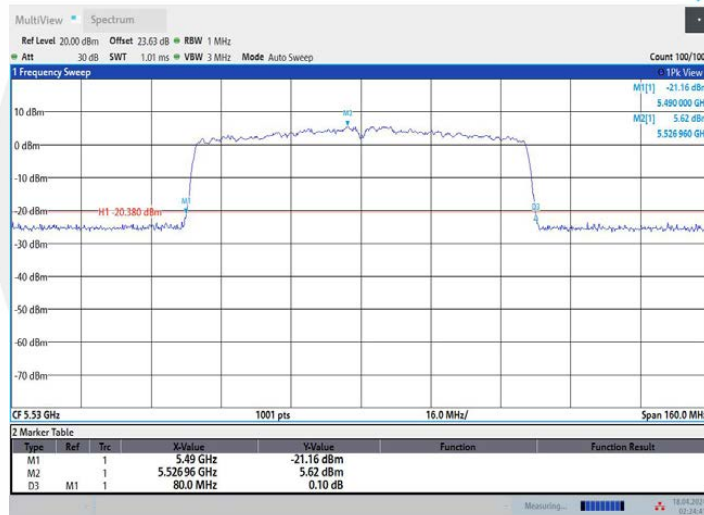

02:24:42 18.04.2024

11AC80MIMO\_Ant1\_5610



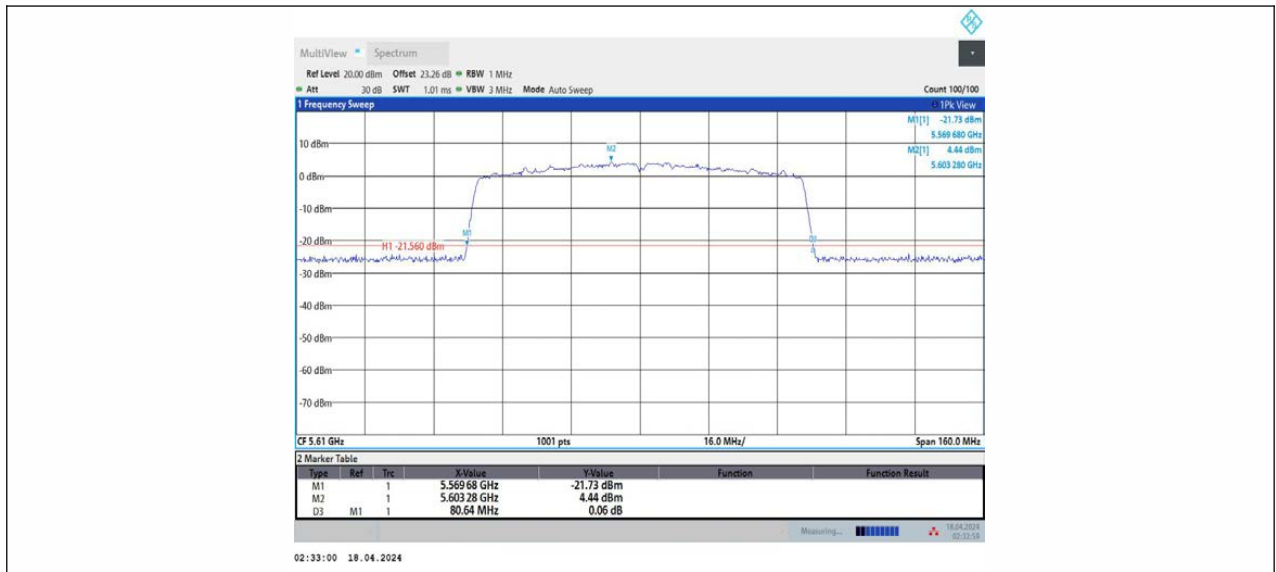

11AC80MIMO\_Ant2\_5610

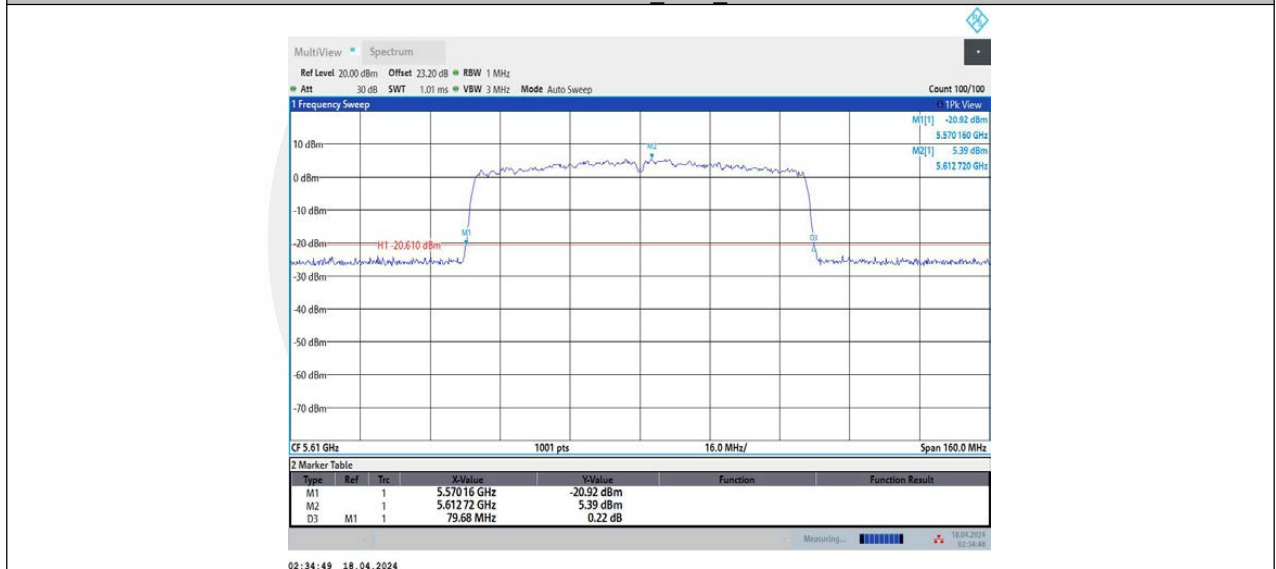

11AC80MIMO\_Ant1\_5775