

TEST REPORT

Product Name : Laser Projector
Model Number : L166FGN, L166***** (*=0-9, a-z, A-Z, - or blank, indicates for different market purposes)
FCC ID : 2AZNP-L166FGN

Prepared for : Formovie (Chongqing) Innovative Technology Co., Ltd.
Address : 4-401, #2 Longgang Road, Guojiatuo Area, Jiangbei District, Chongqing, China

Prepared by : EMTEK (SHENZHEN) CO., LTD.
Address : Building 69, Majialong Industry Zone, Nanshan District, Shenzhen, Guangdong, China

Tel: (0755) 26954280
Fax: (0755) 26954282

Report Number : ENS2403280299W00303R
Date(s) of Tests : March 29, 2024 to April 27, 2024
Date of issue : April 29, 2024

TABLE OF CONTENTS

1 TEST RESULT CERTIFICATION	3
2 EUT TECHNICAL DESCRIPTION	5
3 SUMMARY OF TEST RESULT	6
4 TEST METHODOLOGY	7
4.1 GENERAL DESCRIPTION OF APPLIED STANDARDS	7
4.2 MEASUREMENT EQUIPMENT USED	7
4.3 DESCRIPTION OF TEST MODES	8
5 FACILITIES AND ACCREDITATIONS	9
5.1 FACILITIES	9
5.2 EQUIPMENT	9
5.3 LABORATORY ACCREDITATIONS AND LISTINGS	9
6 TEST SYSTEM UNCERTAINTY	10
7 SETUP OF EQUIPMENT UNDER TEST	11
7.1 RADIO FREQUENCY TEST SETUP 1	11
7.2 RADIO FREQUENCY TEST SETUP 2	11
7.3 CONDUCTED EMISSION TEST SETUP	14
7.4 BLOCK DIAGRAM CONFIGURATION OF TEST SYSTEM	15
7.5 SUPPORT EQUIPMENT	15
8 TEST REQUIREMENTS	16
8.1 ON TIME AND DUTY CYCLE	16
8.2 DTS 6DB BANDWIDTH	33
8.3 DTS 99% BANDWIDTH	50
8.4 MAXIMUM PEAK CONDUCTED OUTPUT POWER	67
8.5 MAXIMUM POWER SPECTRAL DENSITY	84
8.6 UNWANTED EMISSIONS IN NON-RESTRICTED FREQUENCY BANDS	101
8.7 RADIATED SPURIOUS EMISSION	159
8.8 CONDUCTED EMISSION TEST	172
8.9 ANTENNA APPLICATION	175

1 TEST RESULT CERTIFICATION

Applicant : Formovie (Chongqing) Innovative Technology Co., Ltd.
 Address : 4-401, #2 Longgang Road, Guojiatuo Area, Jiangbei District, Chongqing, China
 Manufacturer : Formovie (Chongqing) Innovative Technology Co., Ltd.
 Address : 4-401, #2 Longgang Road, Guojiatuo Area, Jiangbei District, Chongqing, China
 EUT : Laser Projector
 Model Name : L166FGN, L166***** (*=0-9, a-z, A-Z, - or blank, indicates for different market purposes)
 Trademark : Formovie

Measurement Procedure Used:

APPLICABLE STANDARDS	
STANDARD	TEST RESULT
FCC 47 CFR Part 2 , Subpart J FCC 47 CFR Part 15, Subpart C	PASS
IC RSS-GEN, Issue 5(04-2018)+A1(03-2019)+A2(02-2021) IC RSS-247 Issue 2(02-2017)	PASS

The above equipment was tested by EMTEK(SHENZHEN) CO., LTD. The test data, data evaluation, test procedures, and equipment configurations shown in this report were made in accordance with the procedures given in ANSI C63.10 (2013) and the energy emitted by the sample EUT tested as described in this report is in compliance with the requirements of FCC Rules Part 2, Part 15.247, IC RSS-247 Issue 2 and IC RSS-GEN, Issue 5.

The test results of this report relate only to the tested sample identified in this report.

Date of Test : March 29, 2024 to April 27, 2024

Prepared by : 
 Una Yu /Editor

Reviewer : 
 Joe Xia /Supervisor

Approve & Authorized Signer : 
 Lisa Wang/Manager



Modified History

Version	Report No.	Revision Date	Summary
Ver.1.0	ENS2403280299W00303R	/	Original Report



2 EUT TECHNICAL DESCRIPTION

Characteristics	Description
Product:	Laser Projector
Model Number:	L166FGN, L166***** (*=0-9, a-z, A-Z, - or blank, indicates for different market purposes) (Note: All models are identical in circuitry and electrical, mechanical and physical construction; the difference are model number for trading purpose. Mode L166FGN was Chosen final test.)
Sample Number:	2#
IEEE 802.11 WLAN Mode Supported:	802.11b 802.11g 802.11n/ax(20MHz channel bandwidth) 802.11n/ax(40MHz channel bandwidth)
Modulation:	DSSS with DBPSK/DQPSK/CCK for 802.11b; OFDM with BPSK/QPSK/16QAM/64QAM for 802.11g/n; OFDM with BPSK/QPSK/16QAM/64QAM/256QAM/1024QAM for 802.11ax;
Operating Frequency Range:	2412-2462MHz for 802.11b/g/n(HT20)/ax(HE20); 2422-2452MHz for 802.11n(HT40)/ax(HE40);
Number of Channels:	11 channels for 802.11b/g/n(HT20)/ax(HE20); 7 Channels for 802.11n(HT40)/ax(HE40);
Transmit Power Max:	20.42 dBm
Antenna Type:	FPC Antenna
Antenna Gain:	Antenna 1: 3.89 dBi Antenna 2: 2.58 dBi
Power Supply:	AC 120V/60Hz
Date of Received	March 28, 2024
Temperature Range	0°C ~ +40°C
FVIN:	V7

Note: for more details, please refer to the User's manual of the EUT.

3 SUMMARY OF TEST RESULT

FCC Part Clause	IC Part Clause	Test Parameter	Verdict	Remark
15.247(a)(2)	RSS-247 5.2(a) RSS-Gen 6.7	Emission Bandwidth	PASS	
15.247(b)(3)	RSS-247 5.4(d) RSS-Gen 6.12	Maximum Peak Conducted Output Power	PASS	
15.247(e)	RSS-247 5.2(b) RSS-Gen 6.12	Maximum Power Spectral Density Level	PASS	
15.247(d)	RSS-247 5.5	Unwanted Emission Into Non-Restricted Frequency Bands	PASS	
15.247(d)	RSS-247 5.5	Unwanted Emission Into Restricted Frequency Bands (conducted)	PASS	
15.247(d) 15.209 15.205	RSS-Gen 8.9 RSS-Gen 8.10 RSS-Gen 6.13 RSS-247 3.3 RSS-247 5.5	Radiated Spurious Emission	PASS	
15.207	RSS-Gen 8.8	Conducted Emission Test	PASS	
15.203 15.247(b)	RSS-Gen 6.8 RSS-247 5.4	Antenna Application	PASS	
NOTE1: N/A (Not Applicable)				
NOTE2: According to FCC OET KDB 558074, the report use radiated measurements in the restricted frequency bands. In addition, the radiated test is also performed to ensure the emissions emanating from the device cabinet also comply with the applicable limits.				

RELATED SUBMITTAL(S) / GRANT(S):

This submittal(s) (test report) is intended for **FCC ID:2AZNP-L166FGN** filing to comply with Section 15.247 of the FCC Part 15, Subpart C Rules.

4 TEST METHODOLOGY

4.1 GENERAL DESCRIPTION OF APPLIED STANDARDS

According to its specifications, the EUT must comply with the requirements of the following standards:

FCC 47 CFR Part 2, Subpart J

FCC 47 CFR Part 15, Subpart C

IC RSS-GEN, Issue 5(04-2018)+A1(03-2019)+A2(02-2021)

IC RSS-247 Issue 2(02-2017)

FCC KDB 558074 D01 15.247 Meas Guidance v05r02

FCC KDB 662911 D01 Multiple Transmitter Output v02r01

4.2 MEASUREMENT EQUIPMENT USED

Conducted Emission Test Equipment

Equipment	Manufacturer	Model No.	Serial No.	Last Cal.	Cal. Interval
EMI Test Receiver	Rohde & Schwarz	ESCI	101384	2023/5/13	1Year
AMN	Rohde & Schwarz	ENV216	101161	2023/5/13	1Year

For Spurious Emissions Test

Equipment	Manufacturer	Model No.	Serial No.	Last Cal.	Cal. Interval
EMI Test Receiver	Rohde & Schwarz	ESU 26	100154	2023/5/13	1Year
Pre-Amplifie	Lunar EM	LNA30M3G-25	J10100000070	2023/5/13	1Year
Bilog Antenna	Schwarzbeck	VULB9163	660	2023/5/16	2 Year
Horn antenna	Schwarzbeck	BBHA9120D	9120D-1177	2023/5/12	2 Year
Pre-Amplifie	SKET	LNPA_0118G-45	SK2019051801	2023/5/10	1Year
Loop Antenna	Schwarzbeck	FMZB1519	1519-012	2023/5/12	2 Year
Spectrum Analyzer	Rohde & Schwarz	FSV40	100967	2023/5/10	1Year
Horn antenna	Schwarzbeck	BBHA9170	9170-399	2023/5/12	2 Year
Band reject Filter(50dB)	WI/DE	WRCGV-2400(2400-2485MHz)	2	2023/5/13	1 Year

For other test items:

Equipment	Manufacturer	Model No.	Serial No.	Last Cal.	Cal. Interval
Wideband Radio Communication Tester	R&S	CMW500	171168	2023/9/14	1Year
Frequency Extender	R&S	CMW-Z800A	100430	2023/11/2	1Year
Spectrum Analyzer	R&S	FSV3044	101289	2023/9/14	1Year
Analog Signal Generator	R&S	SMB100A	183237	2023/9/16	1Year
Vector Signal Generator	R&S	SMM100A	101808	2023/9/16	1Year
RF Control Unit(Power Meter)	Tonscend	JS0806-2	22C8060567	2023/9/14	1Year
Temperature&Humidity Chamber	ESPEC	EL-02KA	12107166	2023/5/10	1 Year

4.3 DESCRIPTION OF TEST MODES

The EUT has been tested under its typical operating condition.

The EUT configuration for testing is installed on RF field strength measurement to meet the Commissions requirement and operating in a manner which intends to maximize its emission characteristics in a continuous normal application.

The Transmitter was operated in the normal operating mode. The TX frequency was fixed which was for the purpose of the measurements.

Test of channel included the lowest and middle and highest frequency to perform the test, then record on this report.

Those data rates (802.11b: 1 Mbps; 802.11g: 6 Mbps; 802.11n (HT20): MCS0; 802.11n (HT40): MCS0; 802.11ax (HE20): MCS0; 802.11ax (HE40): MCS0;) were used for all test.

Pre-defined engineering program for regulatory testing used to control the EUT for staying in continuous transmitting and receiving mode is programmed.

Frequency and Channel list for 802.11 b/g/n(HT20)/ax(HE20):

Channel	Frequency (MHz)	Channel	Frequency (MHz)	Channel	Frequency (MHz)
1	2412	5	2432	9	2452
2	2417	6	2437	10	2457
3	2422	7	2442	11	2462
4	2427	8	2447		

Frequency and Channel list for 802.11n(HT40)/ax(HE40):

Channel	Frequency (MHz)	Channel	Frequency (MHz)	Channel	Frequency (MHz)
3	2422	6	2437	9	2452
4	2427	7	2442		
5	2432	8	2447		

Test Frequency and Channel for 802.11 b/g/n(HT20)/ax(HE20):

Lowest Frequency		Middle Frequency		Highest Frequency	
Channel	Frequency (MHz)	Channel	Frequency (MHz)	Channel	Frequency (MHz)
1	2412	6	2437	11	2462

Test Frequency and channel for 802.11n(HT40)/ax(HE40):

Lowest Frequency		Middle Frequency		Highest Frequency	
Channel	Frequency (MHz)	Channel	Frequency (MHz)	Channel	Frequency (MHz)
3	2422	6	2437	9	2452

Multi-antenna correlation:

<input checked="" type="checkbox"/>	Transmit Signals are Correlated Directional gain = $10 \log[(10^{G^1/20} + 10^{G^2/20} + \dots + 10^{G^N/20})^2 / N_{ANT}]$ dBi
<input type="checkbox"/>	All Transmit Signals are Completely Uncorrelated Directional gain = $10 \log[(10^{G^1/10} + 10^{G^2/10} + \dots + 10^{G^N/10}) / N_{ANT}]$ dBi

Directional gain = $10 \log [(10^{3.89/20} + 10^{2.58/20})^2/2]$ dBi=6.27 dBi

5 FACILITIES AND ACCREDITATIONS

5.1 FACILITIES

All measurement facilities used to collect the measurement data are located at:

EMTEK (Shenzhen) Co., Ltd.

Building 69, Majialong Industry Zone District, Nanshan District, Shenzhen, China

The sites are constructed in conformance with the requirements of ANSI C63.7, ANSI C63.4 and CISPR Publication 22.

5.2 EQUIPMENT

Radiated emissions are measured with one or more of the following types of linearly polarized antennas: tuned dipole, biconical, log periodic, bi-log, and/or ridged waveguide, horn. Spectrum analyzers with preselectors and quasi-peak detectors are used to perform radiated measurements.

Conducted emissions are measured with Line Impedance Stabilization Networks and EMI Test Receivers.

Calibrated wideband preamplifiers, coaxial cables, and coaxial attenuators are also used for making measurements.

All receiving equipment conforms to CISPR Publication 16-1, "Radio Interference Measuring Apparatus and Measurement Methods."

5.3 LABORATORY ACCREDITATIONS AND LISTINGS

Site Description

EMC Lab. : **Accredited by CNAS**
 The Certificate Registration Number is L2291.
 The Laboratory has been assessed and proved to be in compliance with CNAS-CL01 (identical to ISO/IEC 17025:2017)

Accredited by FCC
 Designation Number: CN1204
 Test Firm Registration Number: 882943

Accredited by A2LA
 The Certificate Number is 4321.01.

Accredited by Industry Canada
 The Conformity Assessment Body Identifier is CN0008

Name of Firm : EMTEK (SHENZHEN) CO., LTD.
 Site Location : Building 69, Majialong Industry Zone,
 Nanshan District, Shenzhen, Guangdong, China

6 TEST SYSTEM UNCERTAINTY

The following measurement uncertainty levels have been estimated for tests performed on the apparatus:

Test Parameter	Measurement Uncertainty
Radio Frequency	$\pm 1 \times 10^{-5}$
Maximum Peak Output Power Test	$\pm 1.0\text{dB}$
Conducted Emissions Test	$\pm 2.0\text{dB}$
Radiated Emission Test	$\pm 2.0\text{dB}$
Power Density	$\pm 2.0\text{dB}$
Occupied Bandwidth Test	$\pm 1.0\text{dB}$
Band Edge Test	$\pm 3\text{dB}$
All emission, radiated	$\pm 3\text{dB}$
Antenna Port Emission	$\pm 3\text{dB}$
Temperature	$\pm 0.5^\circ\text{C}$
Humidity	$\pm 3\%$

Measurement Uncertainty for a level of Confidence of 95%

7 SETUP OF EQUIPMENT UNDER TEST

7.1 RADIO FREQUENCY TEST SETUP 1

The WLAN component's antenna ports(s) of the EUT are connected to the measurement instrument per an appropriate attenuator. The EUT is controlled by PC/software to emit the specified signals for the purpose of measurements.

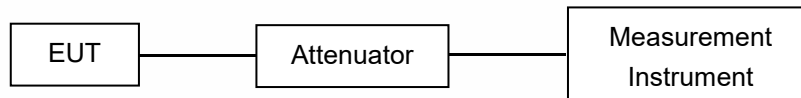

7.2 RADIO FREQUENCY TEST SETUP 2

The test site semi-anechoic chamber has met the requirement of NSA tolerance 4 dB according to the standards: ANSI C63.10. The test distance is 3m. The setup is according to the requirements in Section 13.1.4.1 of ANSI C63.10-2013 and CAN/CSA-CEI/IEC CISPR 22.

The maximal emission value is acquired by adjusting the antenna height, polarisation and turntable azimuth. Normally, the height range of antenna is 1 m to 4 m, the azimuth range of turntable is 0° to 360°, and the receive antenna has two polarizations Vertical (V) and Horizontal (H).

Below 30MHz:

The EUT is placed on a turntable 0.8 meters above the ground in the chamber, 3 meter away from the antenna (loop antenna). The Antenna should be positioned with its plane vertical at the specified distance from the EUT and rotated about its vertical axis for maximum response at each azimuth about the EUT. The center of the loop shall be 1 m above the ground. For certain applications, the loop antenna plane may also need to be positioned horizontally at the specified distance from the EUT.

Above 30MHz:

The EUT is placed on a turntable 0.8 meters above the ground in the chamber, 3 meter away from the antenna. The maximal emission value is acquired by adjusting the antenna height, polarisation and turntable azimuth. Normally, the height range of antenna is 1 m to 4 m, the azimuth range of turntable is 0° to 360°, and the receive antenna has two polarizations Vertical (V) and Horizontal (H).

Above 1GHz:

The EUT is placed on a turntable 1.5 meters above the ground in the chamber, 3 meter away from the antenna. The maximal emission value is acquired by adjusting the antenna height, polarisation and turntable azimuth. Normally, the height range of antenna is 1 m to 4 m, the azimuth range of turntable is 0° to 360°, and the receive antenna has two polarizations Vertical (V) and Horizontal (H).

Measurements shall be taken, using the following steps, at a test site that has been validated using the procedures of ANSI C63.4 or the latest CISPR 16-1-4 for measurements above 1 GHz, so as to simulate a near free-space environment (see RSS-Gen for applicable versions of ANSI and CISPR standards).

(1) Line the ground plane with absorbers between the transmitter and the receive antenna to minimize reflections. The absorbers used should have a minimum-rated attenuation of 20 dB through the measurement frequency range of interest. The absorbers shall be positioned to replicate the layout used when compliance with the applicable acceptability criterion was achieved, as set forth in the aforementioned standards on site validation.

(2) Set the height of the receive antenna to 1.5 m. The receive antenna must be one that was designed and fabricated to operate over the entire frequency range of interest, for example, an appropriate standard gain horn.

(3) The distance between the receive antenna and the radiating source shall be sufficient in order to ensure far-field conditions.

(4) Mount the transmitter at a height of 1.5 m.

(5) Configure the device under test (DUT) to produce the maximum power spectral density as measured while assessing compliance with Section 6.2.2 (i.e. channel frequency, modulation type and data rate). If the DUT is equipped with a detachable antenna and the antenna is intended for remote installation (i.e.

tower-mounted), the DUT may be substituted with a suitable signal generator. The level and frequency settings on the generator shall be set so as to reproduce the maximum power spectral density, measured within a 1 MHz bandwidth, obtained while assessing compliance to Section 6.2.2.

(6) Position the transmitter or the radiating antenna so that elevation pattern measurements can be taken.

(7) Find the 0° reference point in the horizontal plane.

(8) Care should be taken when positioning the receive antenna to avoid cross-polarization. Antennas of known mounting polarization should be assessed with the receive antenna oriented in the same polarity. If the polarization of the transmit antenna is unknown or the transmit antenna can be mounted in either polarization, e.i.r.p. measurements should be performed to find which mounting polarity provides the highest e.i.r.p. value. Testing shall be carried out with the receive antenna and the DUT mounted in each polarity.

(9) The emission shall be centred on the display of the spectrum analyzer with the following settings:

i. If the power spectral density of the DUT was assessed with a peak detector and the antenna cannot be detached from the DUT, the spectrum analyzer shall be set to a peak detector with a resolution bandwidth and video bandwidth of 1 MHz.

ii. If the power spectral density of the DUT was assessed using a sample detector with power averaging and the antenna cannot be detached from the DUT, the spectrum analyzer shall be set to a sample detector, configured to produce 100 power averages and set with a resolution bandwidth, as well as a video bandwidth of 1 MHz.

iii. If the antenna can be detached from the DUT, a continuous wave (CW) signal equal to that of the power spectral density measurement may be used, the spectrum analyzer shall be set to peak detector with a resolution bandwidth and video bandwidth of 1 MHz.

(10) Rotate the turntable 360° recording the field strength at each step. Throughout the main beam of the antenna, the step size shall be kept to a maximum of 1°.

Once outside the main beam of the antenna, the maximum step size shall be as follows, when compared to the requirements of Section 6.2.2:

i. Between 0° and 8°, maximum step size of 2°;

ii. Between 8° and 40°, maximum step size of 4°;

iii. Between 40° and 45°, maximum step size of 1°;

iv. Between 45° and 90°, maximum step size of 5°.

Once the mask reaches 90°, the mask will be inverted and the step size will follow in the same manner as above.

For the purpose of this procedure, the main beam of the antenna is defined as the 3 dB beamwidth.

(11) Convert the measured field strength values in terms of e.i.r.p. density (dBW/1 MHz) using the following equation:

$$\text{e.i.r.p. density (dBW/MHz)} = 10 \log((E \cdot r)^2 / 30)$$

E = field strength in V/m

r = measurement distance in metres

(12) Plot the results against the emission mask with reference to the horizontal plane.

(13) Using the plot, the 0° can be rotated to determine the worst-case installation tilt angle.

(14) Testing shall be performed using the highest gain antenna for every antenna type, if applicable.

(15) Antenna type(s), antenna model number(s), and worst-case tilt angle(s) necessary to remain compliant with the elevation mask requirement set forth in Section 6.2.2(3) of RSS-247 shall be clearly indicated in the user manual.

The following figure is an example of a polar elevation mask measured using the Method 1 reference to dBμV/m at 3 m.

(a) Radiated Emission Test Set-Up, Frequency Below 30MHz

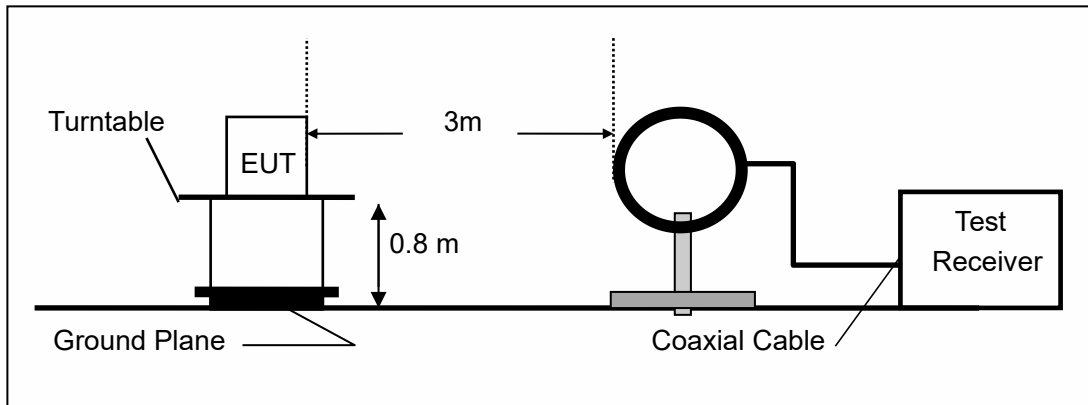

(b) Radiated Emission Test Set-Up, Frequency Below 1000MHz

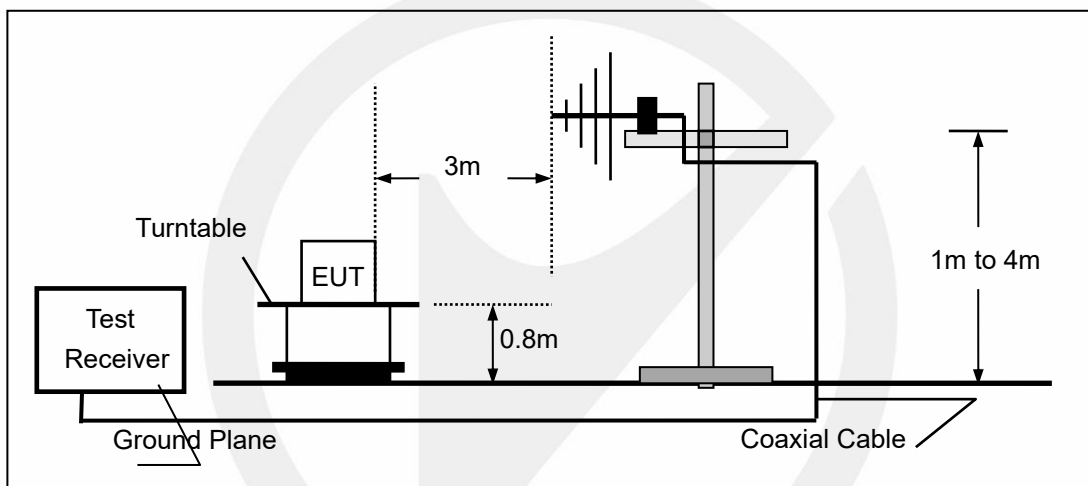

(c) Radiated Emission Test Set-Up, Frequency above 1000MHz

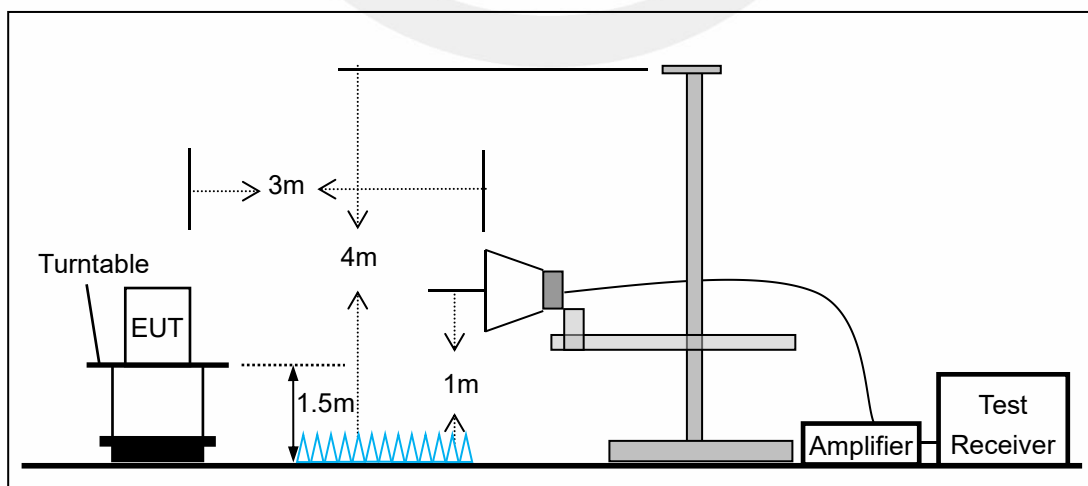

7.3 CONDUCTED EMISSION TEST SETUP

The mains cable of the EUT (maybe per AC/DC Adapter) must be connected to LISN. The LISN shall be placed 0.8 m from the boundary of EUT and bonded to a ground reference plane for LISN mounted on top of the ground reference plane. This distance is between the closest points of the LISN and the EUT. All other units of the EUT and associated equipment shall be at least 0.8m from the LISN.

Ground connections, where required for safety purposes, shall be connected to the reference ground point of the LISN and, where not otherwise provided or specified by the manufacturer, shall be of same length as the mains cable and run parallel to the mains connection at a separation distance of not more than 0.8 m.

According to the requirements in Section 13.1.4.1 of ANSI C63.10-2013 Conducted emissions from the EUT measured in the frequency range between 0.15 MHz and 30 MHz using CISPR Quasi-Peak and average detector mode.

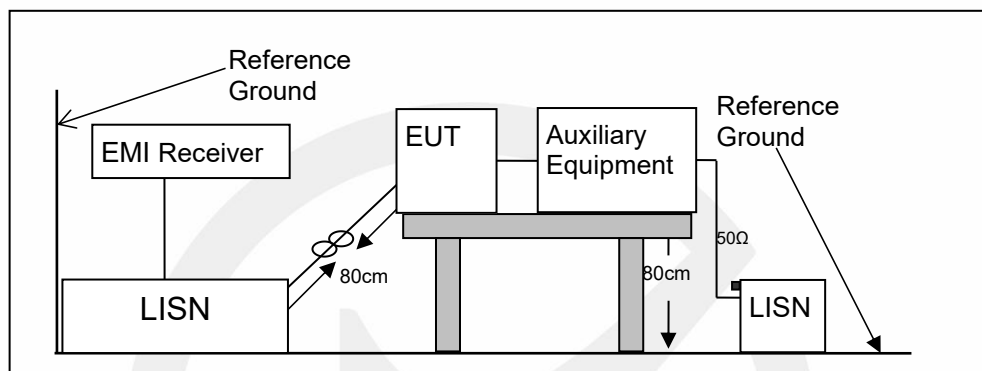

7.4 BLOCK DIAGRAM CONFIGURATION OF TEST SYSTEM

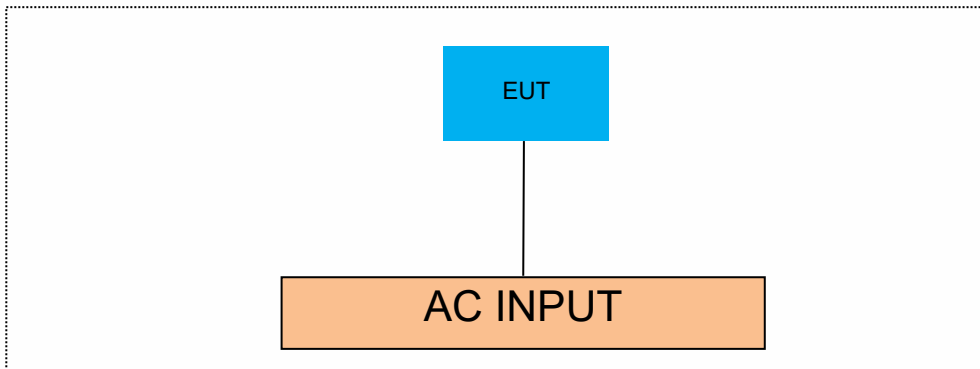

7.5 SUPPORT EQUIPMENT

EUT Cable List and Details			
Cable Description	Length (m)	Shielded/Unshielded	With / Without Ferrite
/	/	/	/

Auxiliary Cable List and Details			
Cable Description	Length (m)	Shielded/Unshielded	With / Without Ferrite
/	/	/	/

Auxiliary Equipment List and Details			
Description	Manufacturer	Model	Serial Number
/	/	/	/

Notes:

1. All the equipment/cables were placed in the worst-case configuration to maximize the emission during the test.
2. Grounding was established in accordance with the manufacturer's requirements and conditions for the intended use.

8 TEST REQUIREMENTS

8.1 ON TIME AND DUTY CYCLE

8.1.1 Applicable Standard

According to 558074 D01 Section 6

8.1.2 Conformance Limit

N/A; for reporting purposes only.

8.1.3 Test Configuration

Test according to clause 7.1 radio frequency test setup.

8.1.4 Test Procedure

The zero-span mode on a spectrum analyzer or EMI receiver, if the response time and spacing between bins on the sweep are sufficient to permit accurate measurements of the on and off times of the transmitted signal. Set the center frequency of the instrument to the center frequency of the transmission. Set $RBW \geq EBW$ if possible; otherwise, set RBW to the largest available value. Set $VBW \geq RBW$. Set detector = peak or average. The zero-span measurement method shall not be used unless both RBW and VBW are $> 50/T$, where T is the minimum transmission duration over which the transmitter is on and is transmitting at its maximum power control level for the tested mode of operation), and the number of sweep points across duration T exceeds 100. (For example, if VBW and/or RBW are limited to 3 MHz, then the zero-span method of measuring duty cycle shall not be used if $T \leq 16.7$ microseconds.)

8.1.5 Test Results

Temperature:	25°C
Relative Humidity:	45%
ATM Pressure:	1011 mbar

Note: N/A

TestMode	Antenna	Frequency[MHz]	Transmission Duration [ms]	Transmission Period [ms]	Duty Cycle [%]	Factor
11B	Ant1	2412	8.39	9.02	93.02	0.31
	Ant2	2412	8.38	8.41	99.64	0.02
	Ant1	2437	8.40	8.42	99.76	0.01
	Ant2	2437	8.40	8.43	99.64	0.02
	Ant1	2462	3.00	3.00	100.00	0.00
	Ant2	2462	8.38	8.41	99.64	0.02
11G	Ant1	2412	1.40	1.43	97.90	0.09
	Ant2	2412	1.39	1.43	97.20	0.12
	Ant1	2437	1.39	1.43	97.20	0.12
	Ant2	2437	1.39	1.43	97.20	0.12
	Ant1	2462	1.39	1.43	97.20	0.12
	Ant2	2462	1.39	1.42	97.89	0.09
11N20MIMO	Ant1	2412	1.30	1.33	97.74	0.10
	Ant2	2412	1.31	1.34	97.76	0.10
	Ant1	2437	1.30	1.34	97.01	0.13
	Ant2	2437	1.30	1.34	97.01	0.13
	Ant1	2462	1.30	1.33	97.74	0.10
	Ant2	2462	1.30	1.34	97.01	0.13
11N40MIMO	Ant1	2422	0.65	0.68	95.59	0.20
	Ant2	2422	0.65	0.69	94.20	0.26
	Ant1	2437	0.64	0.68	94.12	0.26
	Ant2	2437	0.65	0.69	94.20	0.26
	Ant1	2452	0.64	0.68	94.12	0.26
	Ant2	2452	0.65	0.69	94.20	0.26
11AX20MIMO	Ant1	2412	1.01	1.05	96.19	0.17
	Ant2	2412	1.02	1.05	97.14	0.13
	Ant1	2437	1.02	1.05	97.14	0.13
	Ant2	2437	1.02	1.05	97.14	0.13
	Ant1	2462	1.02	1.05	97.14	0.13
	Ant2	2462	1.02	1.05	97.14	0.13
11AX40MIMO	Ant1	2422	0.07	0.09	77.78	1.09
	Ant2	2422	0.06	0.08	75.00	1.25
	Ant1	2437	0.07	0.09	77.78	1.09
	Ant2	2437	0.07	0.09	77.78	1.09
	Ant1	2452	0.07	0.09	77.78	1.09
	Ant2	2452	0.07	0.09	77.78	1.09

11B_Ant1_2412

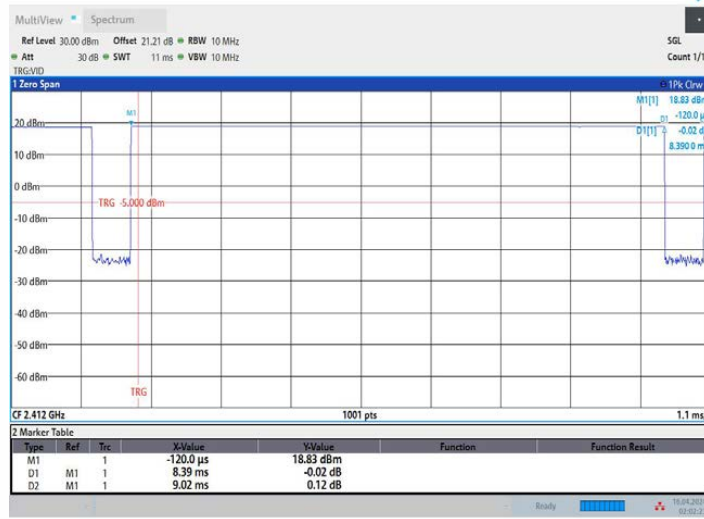

02:02:24 16.04.2024

11B_Ant2_2412

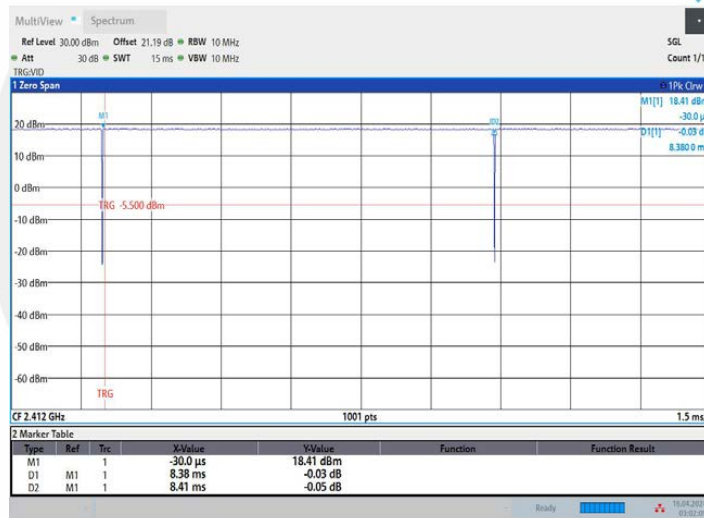

03:02:10 16.04.2024

11B_Ant1_2437

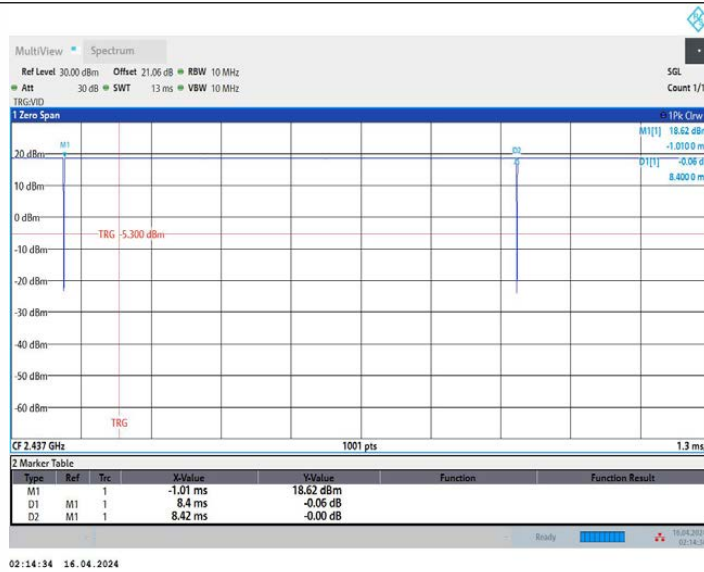

11B_Ant2_2437

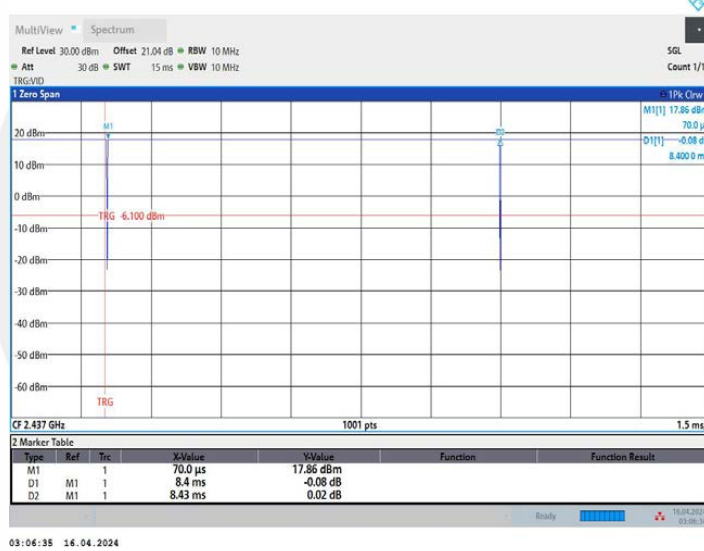

11B_Ant1_2462

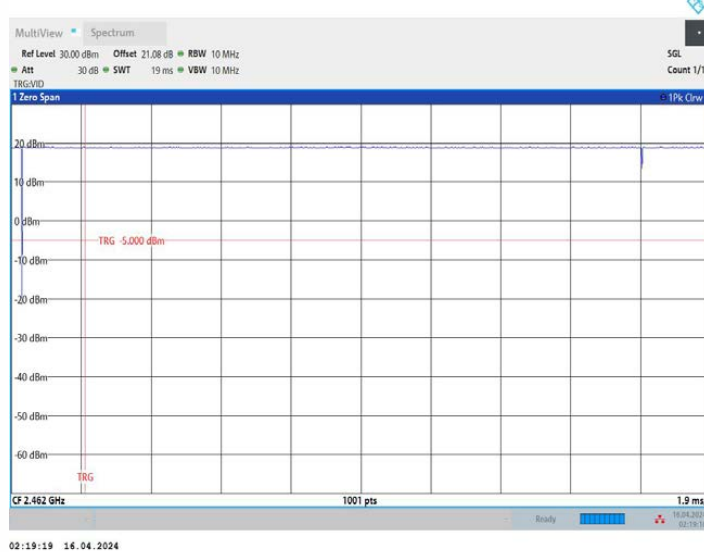

11B_Ant2_2462

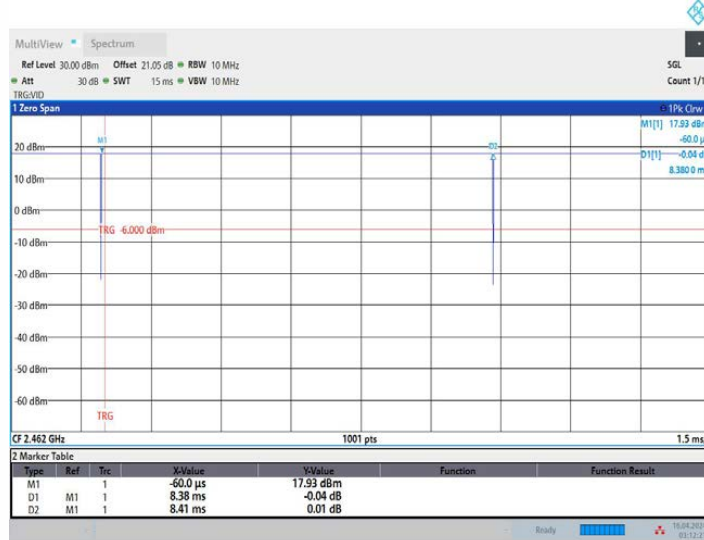

03:12:21 16.04.2024

11G_Ant1_2412

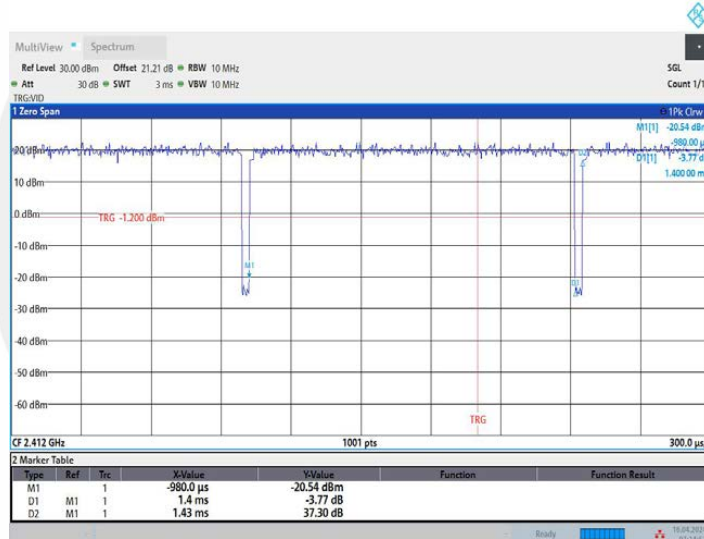

07:14:58 16.04.2024

11G_Ant2_2412

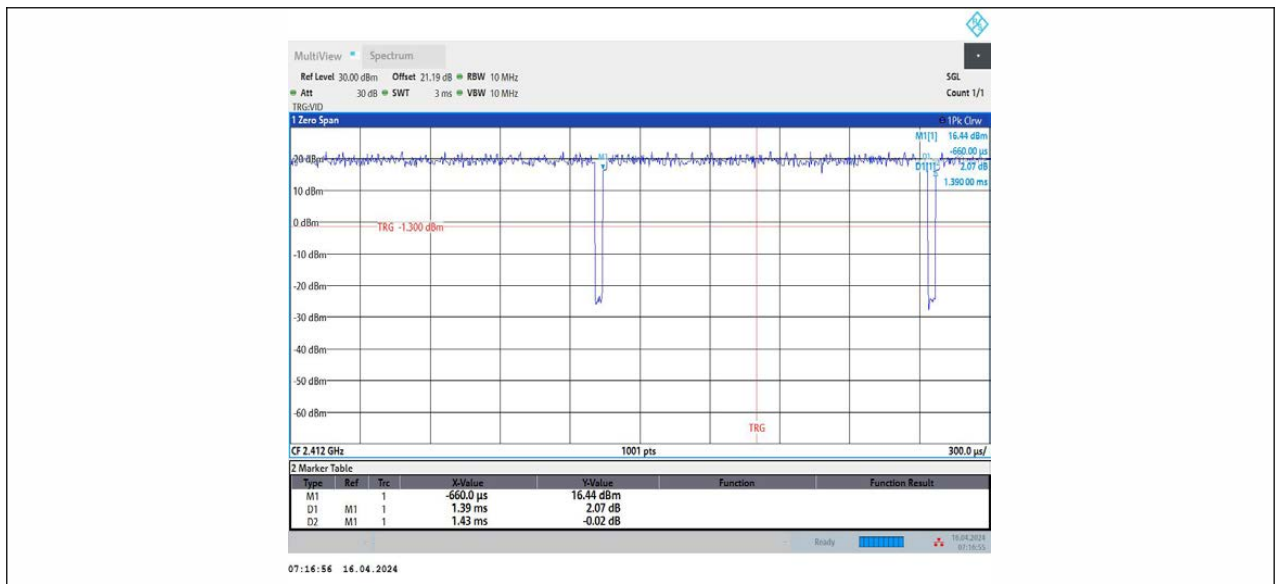

11G_Ant1_2437

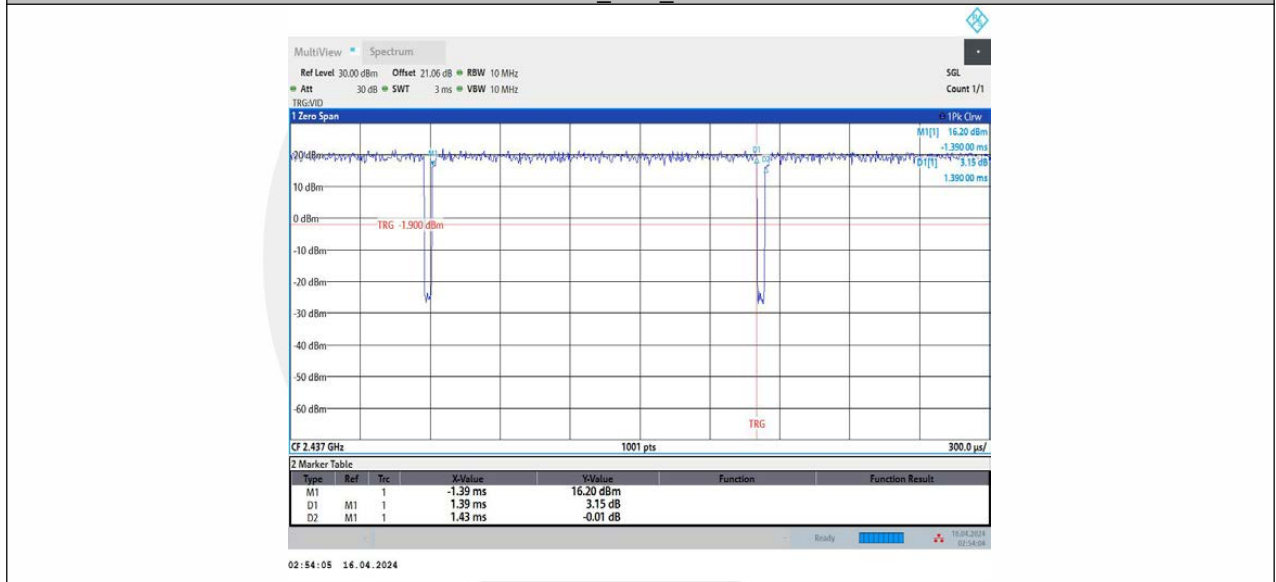

11G_Ant2_2437

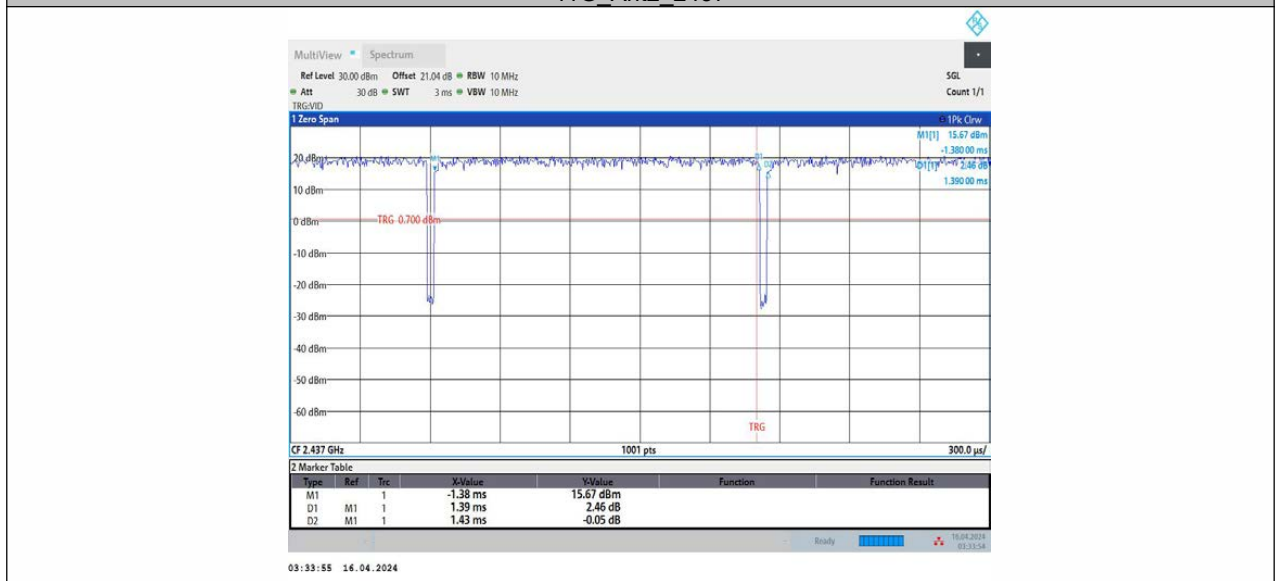

11G_Ant1_2462

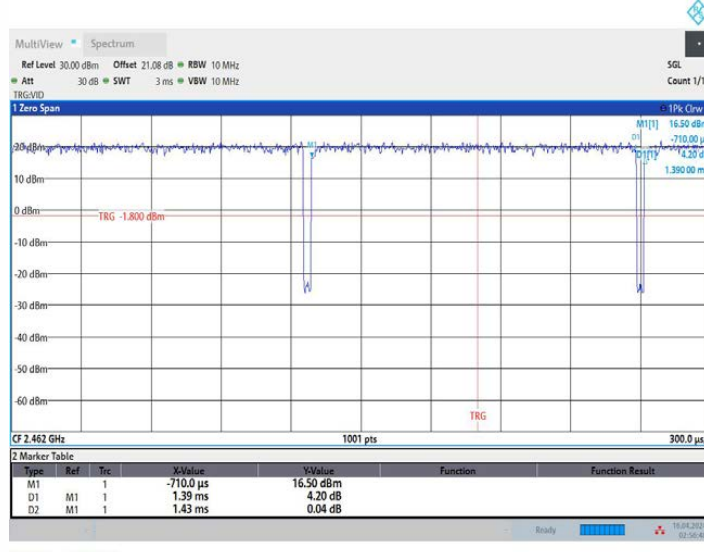

11G_Ant2_2462

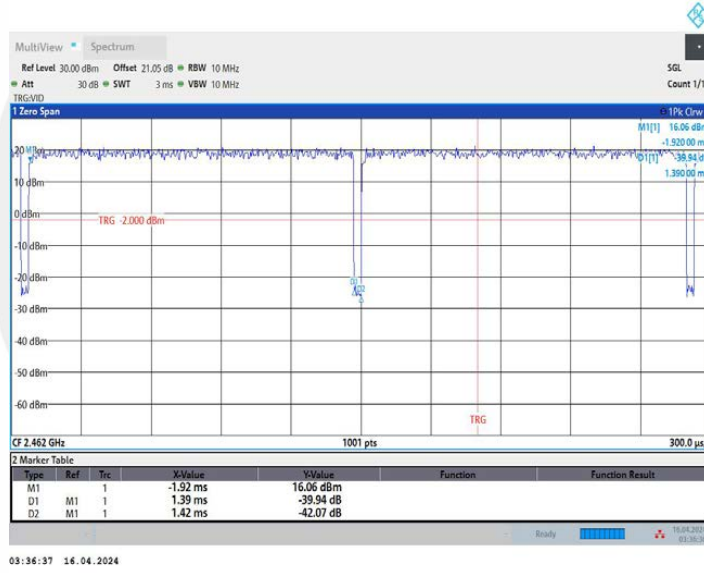

11N20MIMO_Ant1_2412



11N20MIMO_Ant2_2412

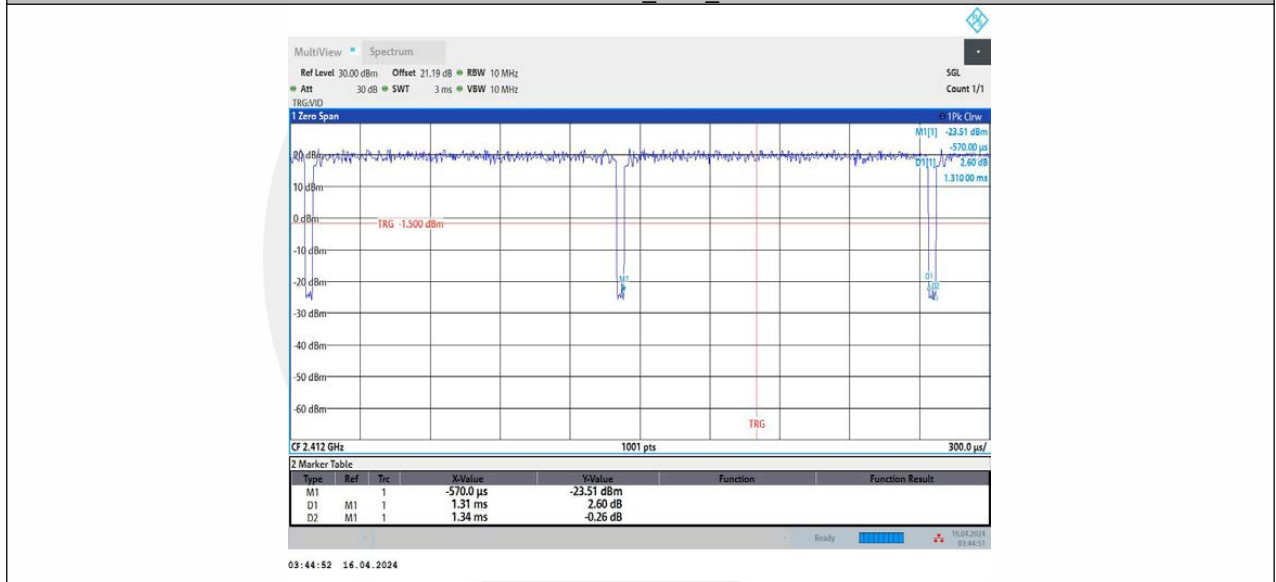

11N20MIMO_Ant1_2437

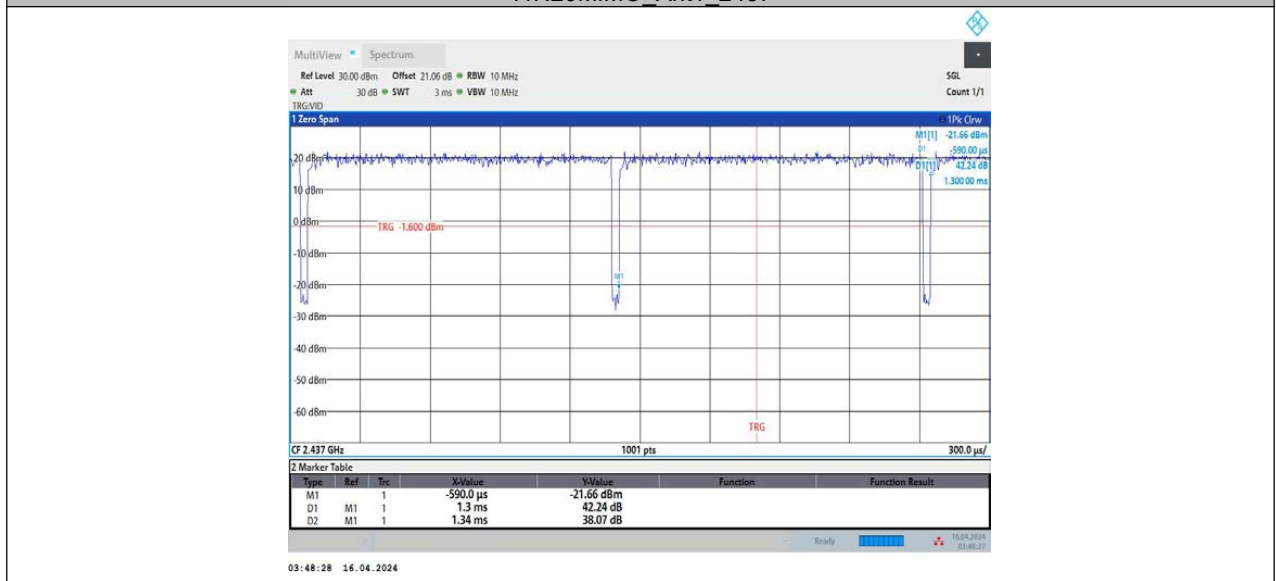

11N20MIMO_Ant2_2437

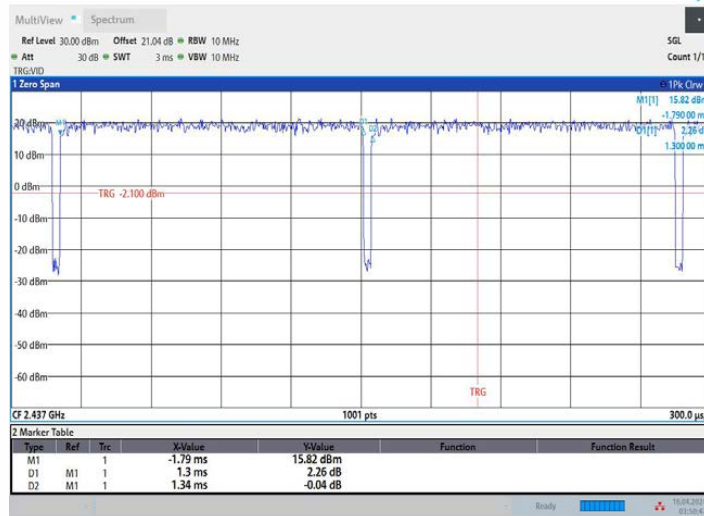

03:50:47 16.04.2024

11N20MIMO_Ant1_2462

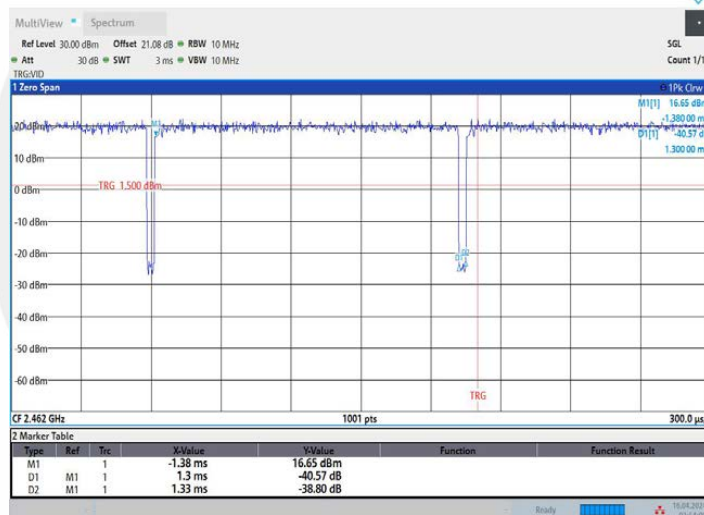

03:54:01 16.04.2024

11N20MIMO_Ant2_2462

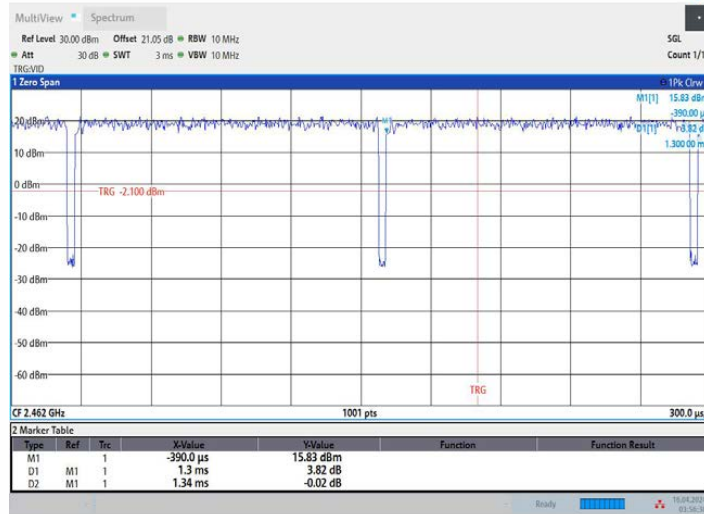

11N40MIMO_Ant1_2422

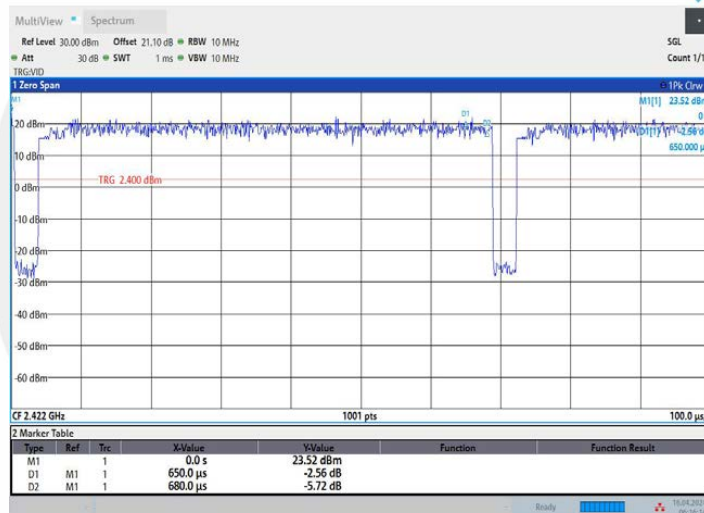

11N40MIMO_Ant2_2422

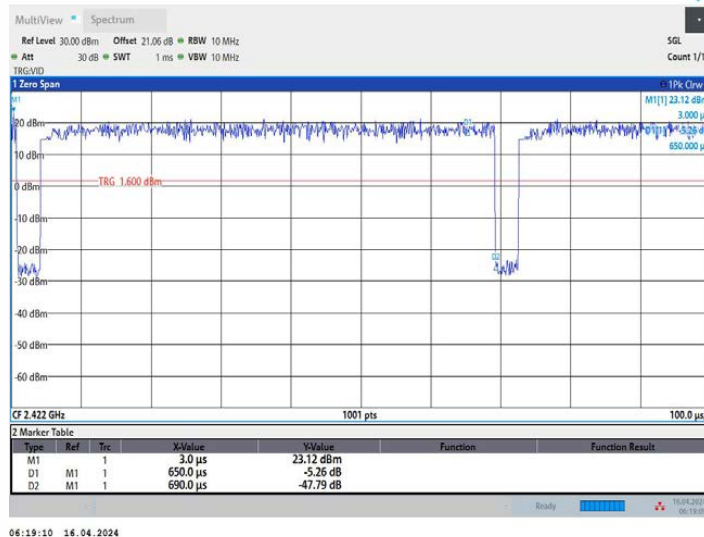

11N40MIMO_Ant1_2437

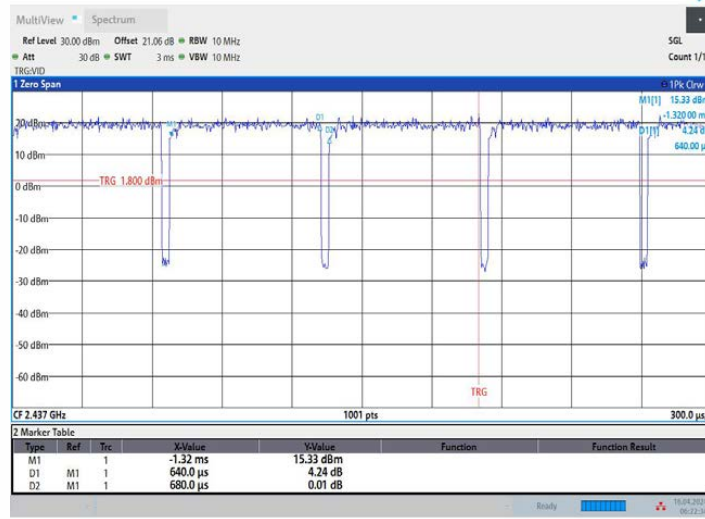

06:22:35 16.04.2024

11N40MIMO_Ant2_2437

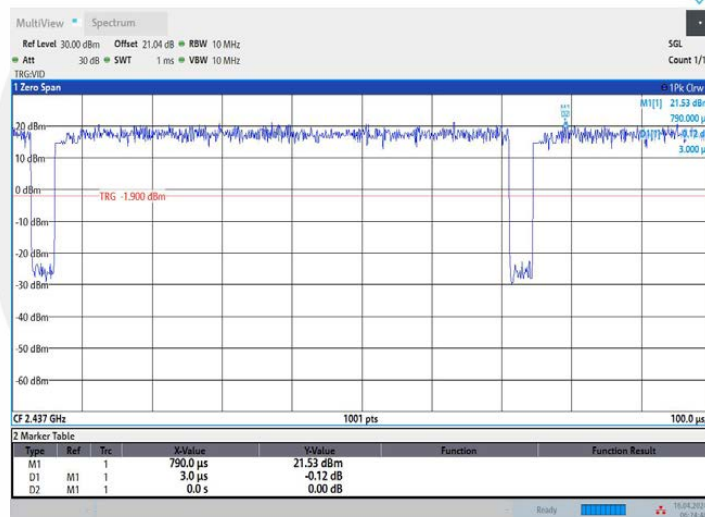

06:24:48 16.04.2024

11N40MIMO_Ant1_2452

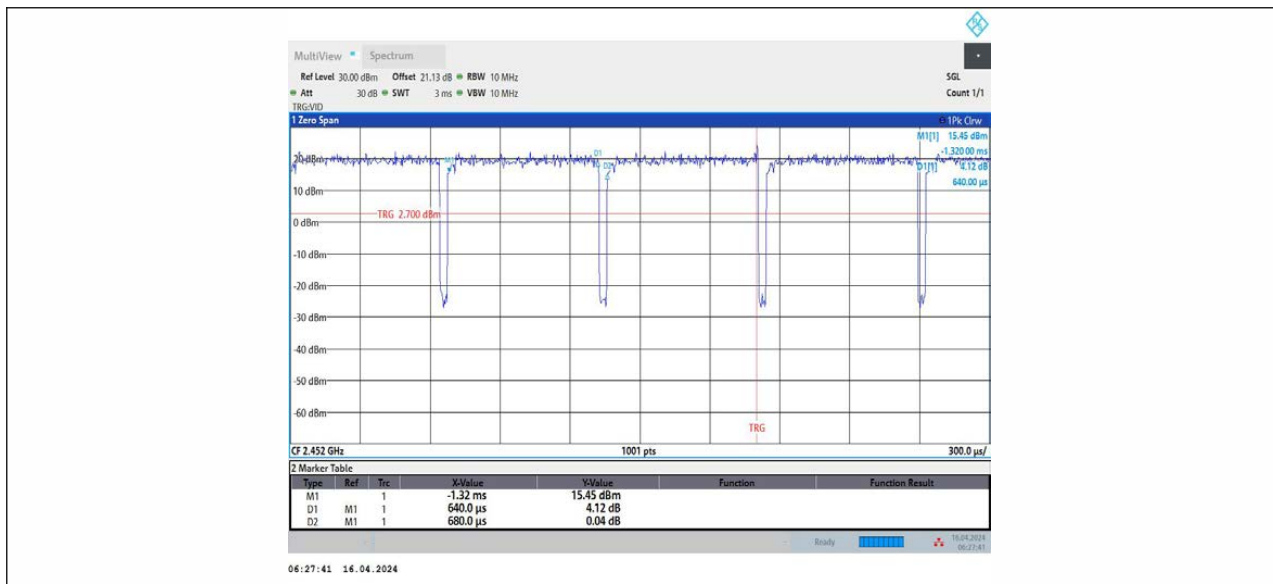

11N40MIMO_Ant2_2452

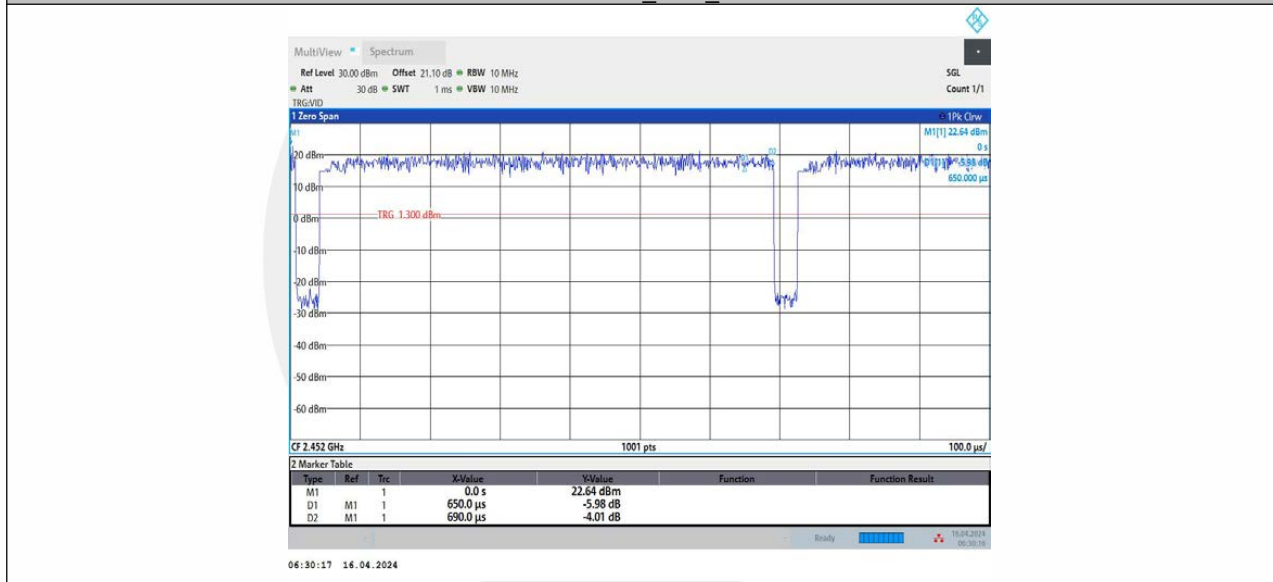

11AX20MIMO_Ant1_2412

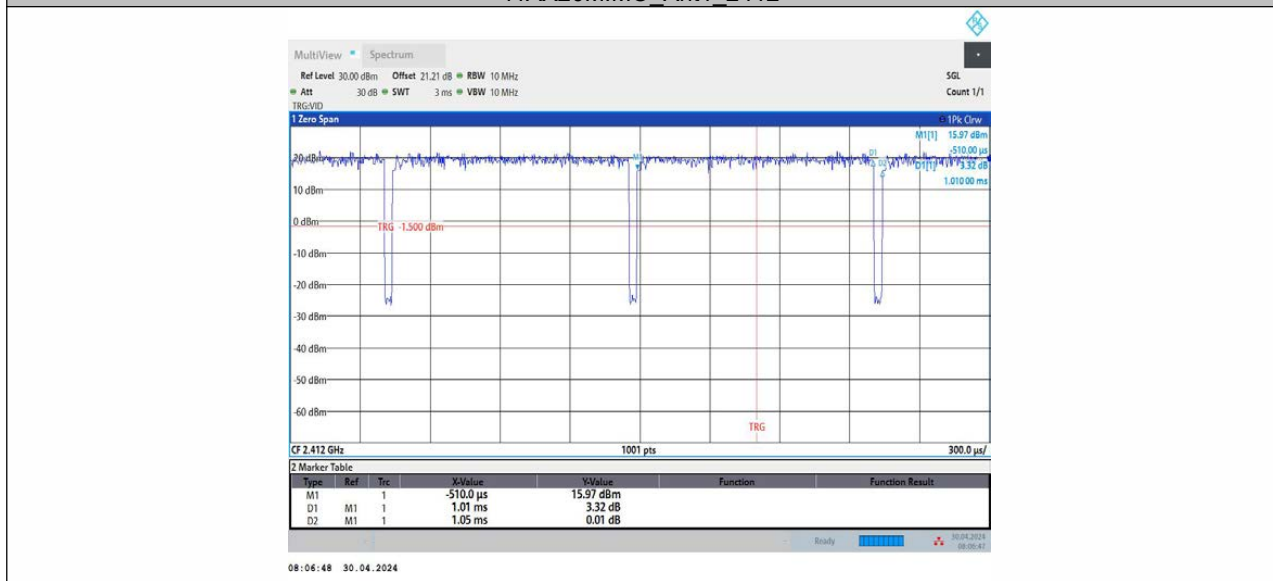

11AX20MIMO_Ant2_2412

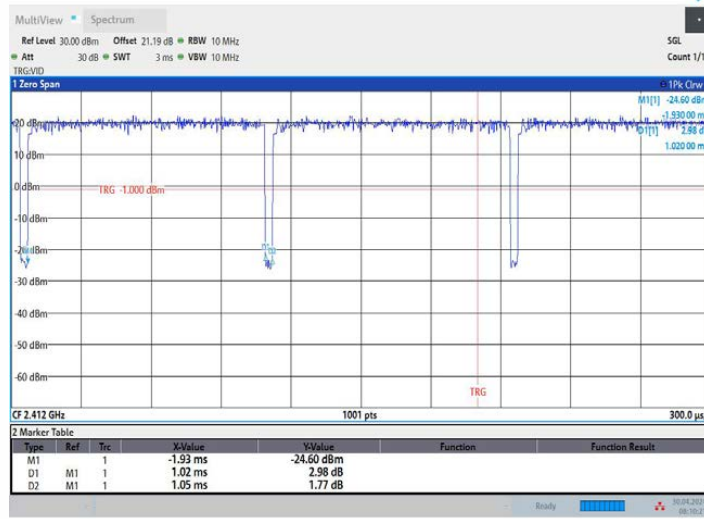

08:10:22 30.04.2024

11AX20MIMO_Ant1_2437

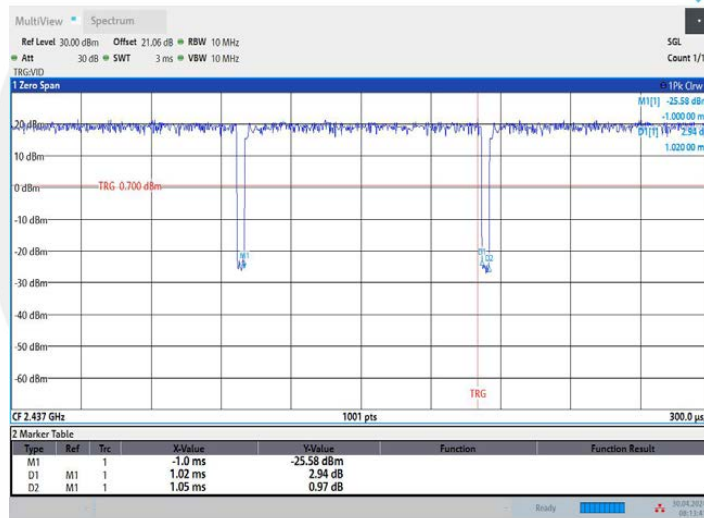

08:13:42 30.04.2024

11AX20MIMO_Ant2_2437



08:16:21 30.04.2024

11AX20MIMO_Ant1_2462

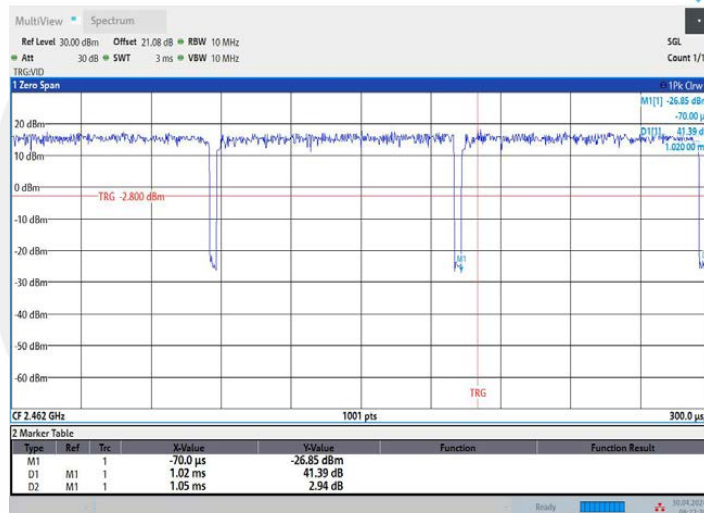

08:22:31 30.04.2024

11AX20MIMO_Ant2_2462

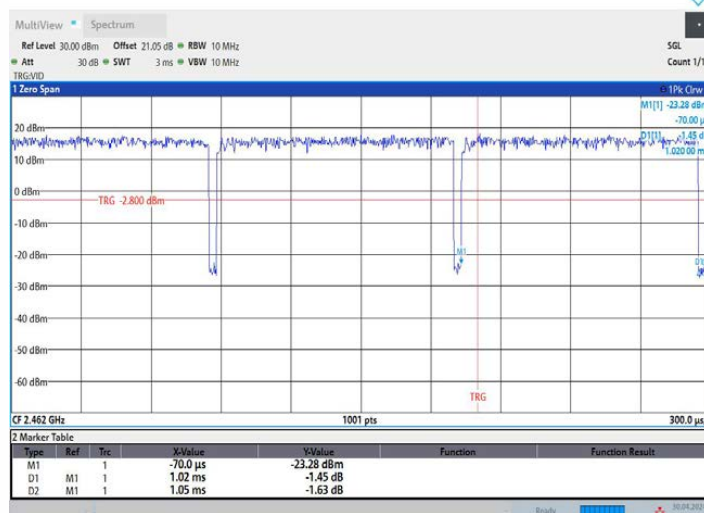

08:24:44 30.04.2024

11AX40MIMO_Ant1_2422

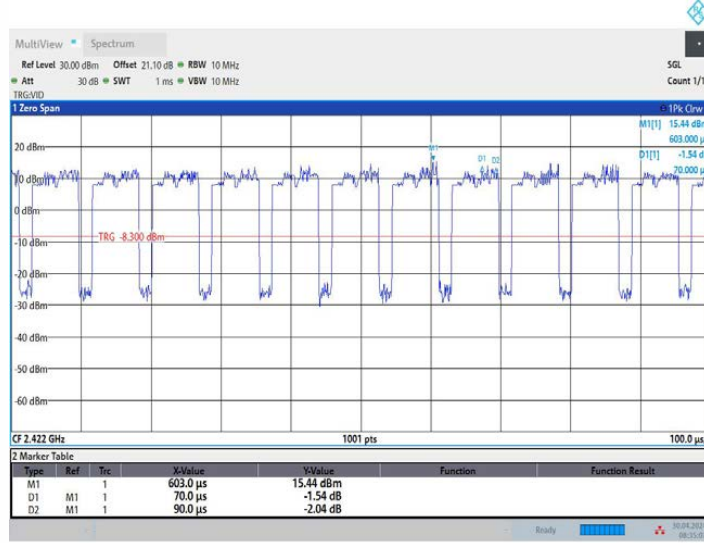

11AX40MIMO_Ant2_2422

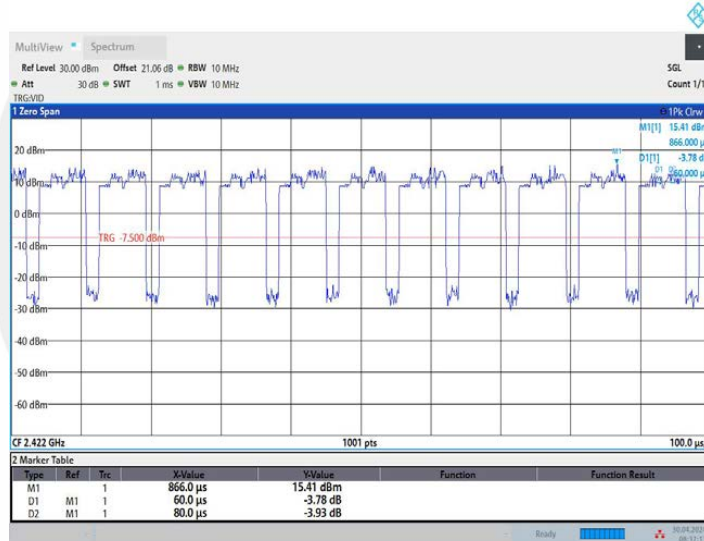

11AX40MIMO_Ant1_2437

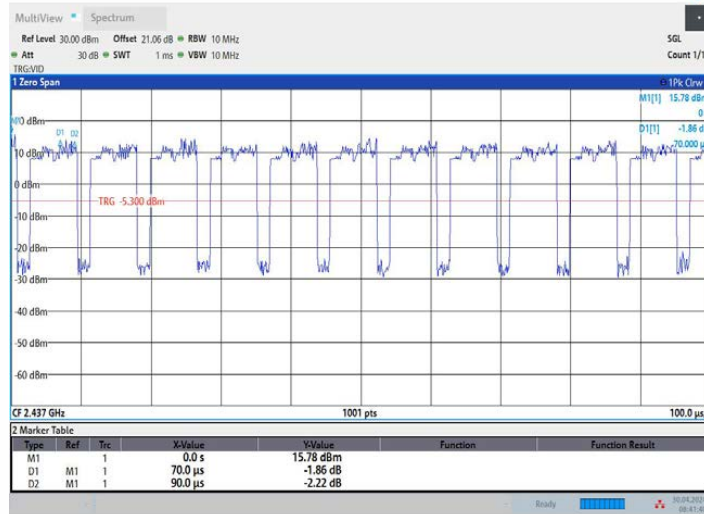

11AX40MIMO_Ant2_2437

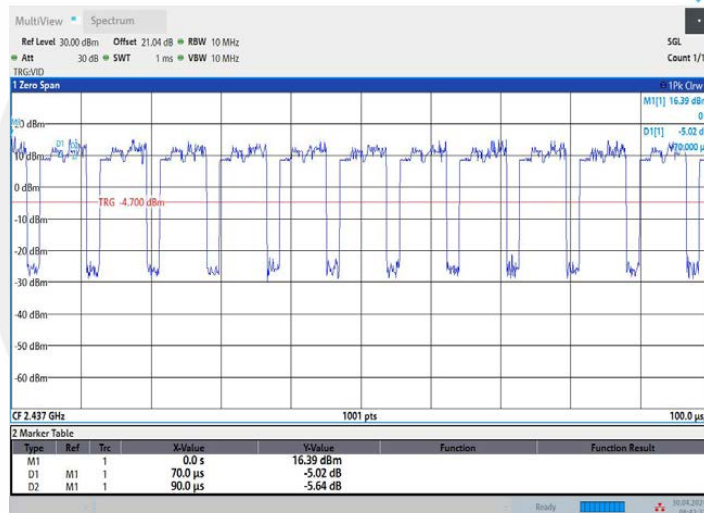

11AX40MIMO_Ant1_2452

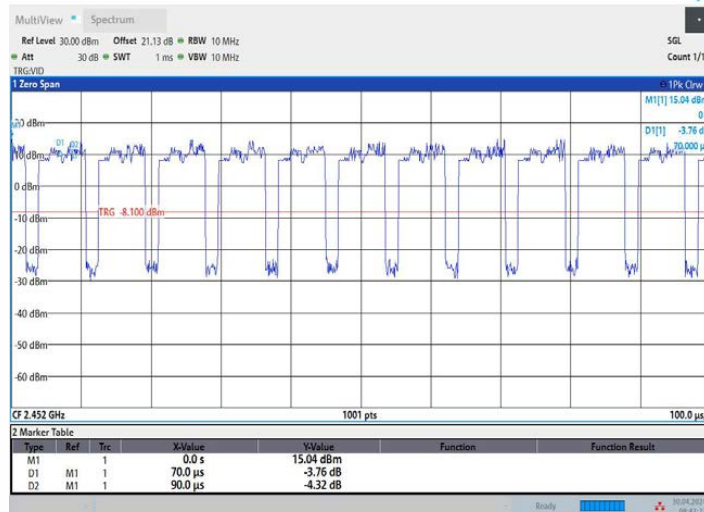

11AX40MIMO_Ant2_2452

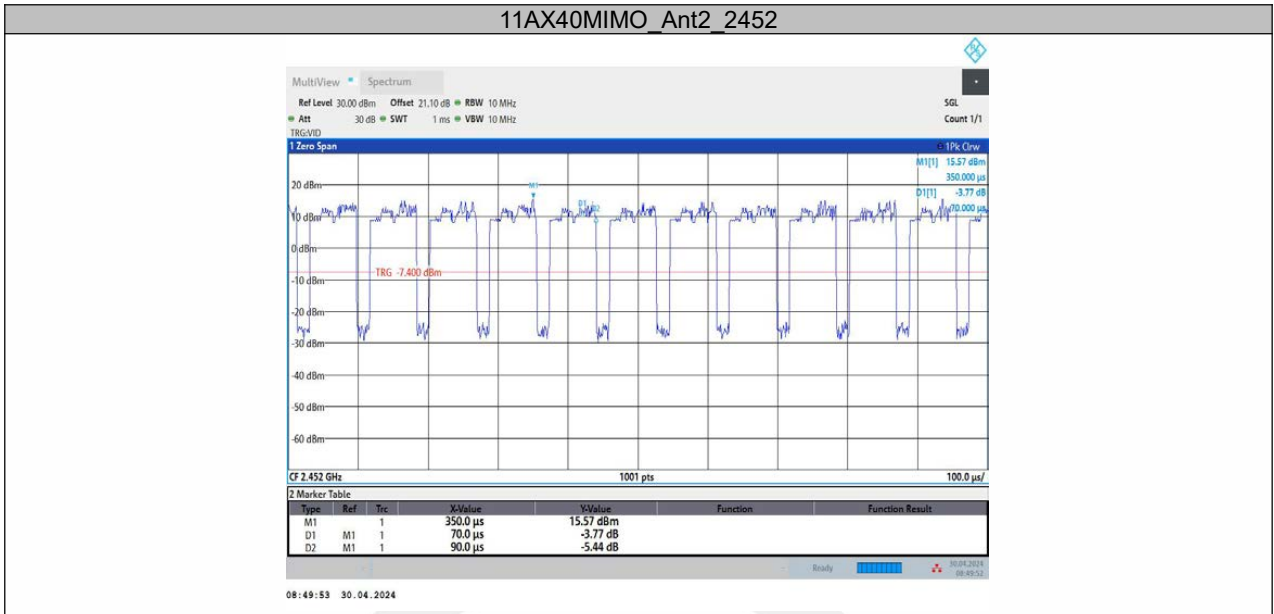

8.2 DTS 6DB BANDWIDTH

8.2.1 Applicable Standard

According to FCC Part15.247 (a)(2)

According to RSS-247 5.2(a)

According to 558074 D01 15.247 Meas Guidance v05r02 Section 8.2

According to ANSI C63.10 Section 11.8

8.2.2 Conformance Limit

The minimum -6 dB bandwidth shall be at least 500 kHz.

8.2.3 Test Configuration

Test according to clause 7.1 radio frequency test setup

8.2.4 Test Procedure

The EUT was operating in WIFI mode and controlled its channel. Printed out the test result from the spectrum by hard copy function.

The RF output of EUT was connected to the spectrum analyzer by RF cable and attenuator. The path loss was compensated to the results for each measurement.

Set to the maximum power setting and enable the EUT transmit continuously

Set RBW = 100 kHz.

Set the video bandwidth (VBW) =300 kHz.

Set Span=2 times OBW

Set Detector = Peak.

Set Trace mode = max hold.

Set Sweep = auto couple.

Allow the trace to stabilize.

Measure the maximum width of the emission that is constrained by the frequencies associated with the two outermost amplitude points (upper and lower frequencies) that are attenuated by 6 dB relative to the maximum level measured in the fundamental emission.

Measure and record the results in the test report.

8.2.5 Test Results

Temperature:	25°C
Relative Humidity:	45%
ATM Pressure:	1011 mbar
Test Engineer:	XXH

Note: N/A

TestMode	Antenna	Frequency[MHz]	DTS BW [MHz]	FL[MHz]	FH[MHz]	Limit[MHz]	Verdict
11B	Ant1	2412	8.08	2407.92	2416.00	0.5	PASS
	Ant2	2412	8.08	2407.92	2416.00	0.5	PASS
	Ant1	2437	8.08	2432.92	2441.00	0.5	PASS
	Ant2	2437	8.08	2432.92	2441.00	0.5	PASS
	Ant1	2462	8.08	2457.92	2466.00	0.5	PASS
	Ant2	2462	8.08	2457.92	2466.00	0.5	PASS
11G	Ant1	2412	15.08	2404.40	2419.48	0.5	PASS
	Ant2	2412	15.08	2404.44	2419.52	0.5	PASS
	Ant1	2437	15.80	2429.04	2444.84	0.5	PASS
	Ant2	2437	15.32	2429.20	2444.52	0.5	PASS
	Ant1	2462	15.52	2454.04	2469.56	0.5	PASS
	Ant2	2462	15.48	2454.04	2469.52	0.5	PASS
11N20MIMO	Ant1	2412	15.08	2404.44	2419.52	0.5	PASS
	Ant2	2412	16.32	2403.80	2420.12	0.5	PASS
	Ant1	2437	15.44	2429.40	2444.84	0.5	PASS
	Ant2	2437	16.56	2428.56	2445.12	0.5	PASS
	Ant1	2462	15.12	2454.40	2469.52	0.5	PASS
	Ant2	2462	16.68	2453.44	2470.12	0.5	PASS
11N40MIMO	Ant1	2422	35.12	2404.48	2439.60	0.5	PASS
	Ant2	2422	35.12	2404.48	2439.60	0.5	PASS
	Ant1	2437	35.12	2419.48	2454.60	0.5	PASS
	Ant2	2437	35.12	2419.48	2454.60	0.5	PASS
	Ant1	2452	35.12	2434.48	2469.60	0.5	PASS
	Ant2	2452	35.12	2434.48	2469.60	0.5	PASS
11AX20MIMO	Ant1	2412	17.80	2403.44	2421.24	0.5	PASS
	Ant2	2412	18.44	2402.80	2421.24	0.5	PASS
	Ant1	2437	18.28	2427.68	2445.96	0.5	PASS
	Ant2	2437	18.56	2427.68	2446.24	0.5	PASS
	Ant1	2462	18.32	2452.92	2471.24	0.5	PASS
	Ant2	2462	17.96	2452.84	2470.80	0.5	PASS
11AX40MIMO	Ant1	2422	35.76	2403.84	2439.60	0.5	PASS
	Ant2	2422	35.20	2404.40	2439.60	0.5	PASS
	Ant1	2437	35.76	2418.84	2454.60	0.5	PASS
	Ant2	2437	37.12	2418.28	2455.40	0.5	PASS
	Ant1	2452	35.76	2433.84	2469.60	0.5	PASS
	Ant2	2452	37.04	2433.28	2470.32	0.5	PASS

11B_Ant1_2412



02:02:40 16.04.2024

11B_Ant2_2412



03:02:28 16.04.2024

11B_Ant1_2437

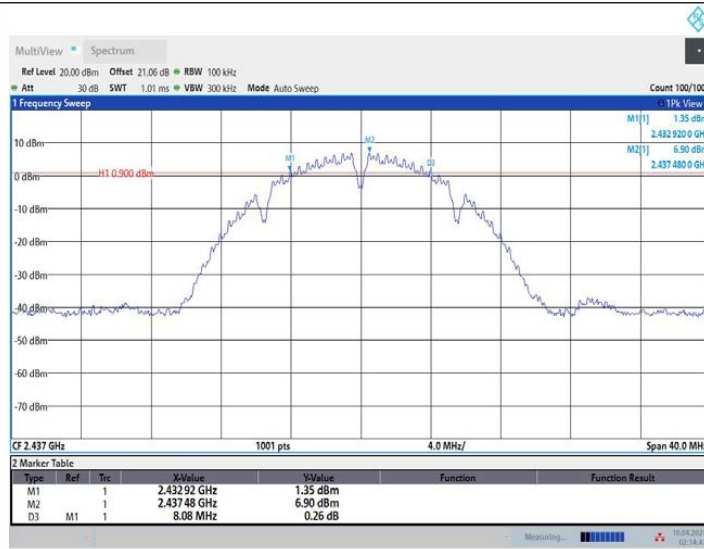

11B_Ant2_2437

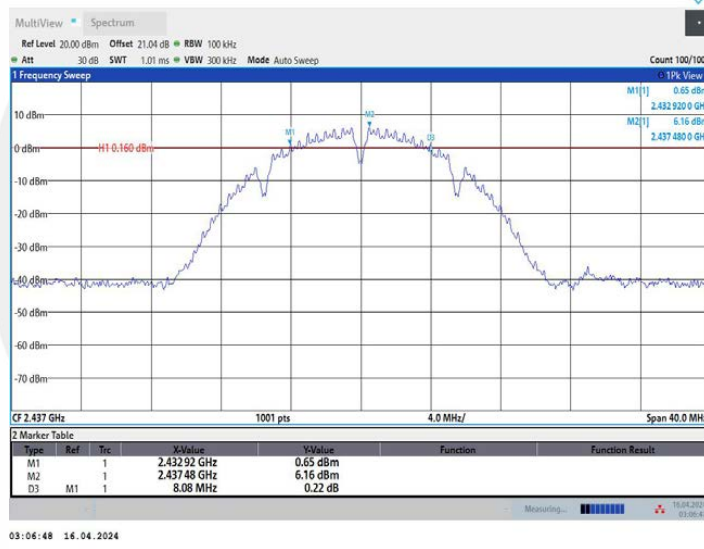

11B_Ant1_2462

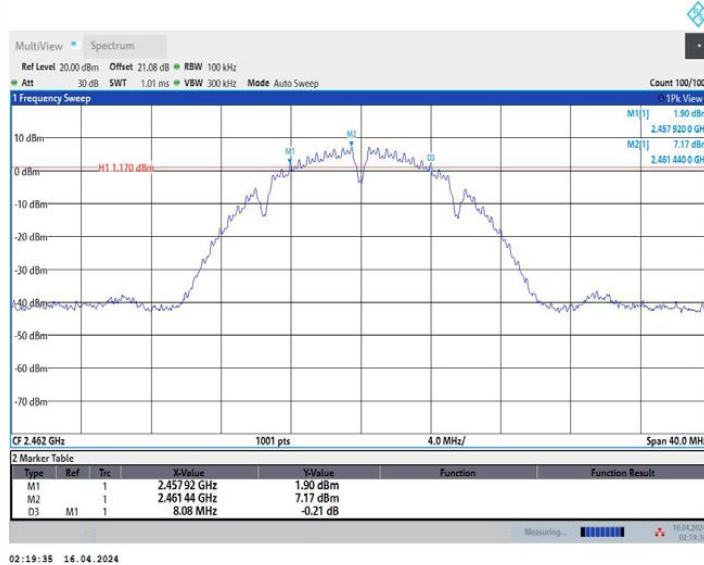

11B_Ant2_2462

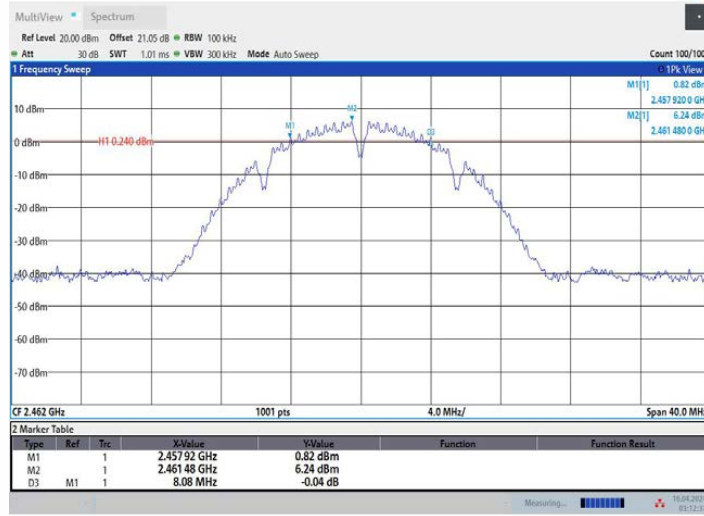

11G_Ant1_2412

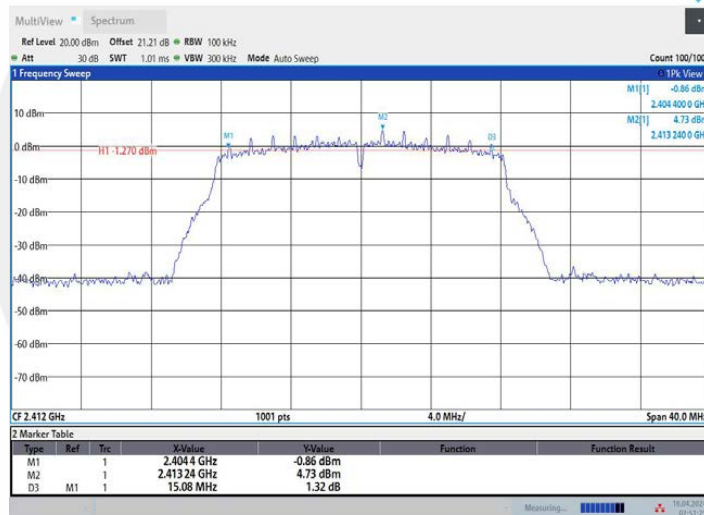

11G_Ant2_2412

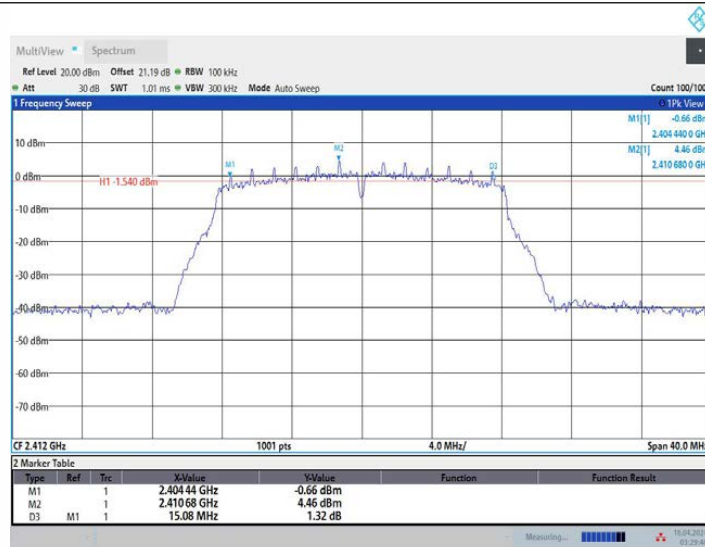

03:29:49 16.04.2024

11G_Ant1_2437

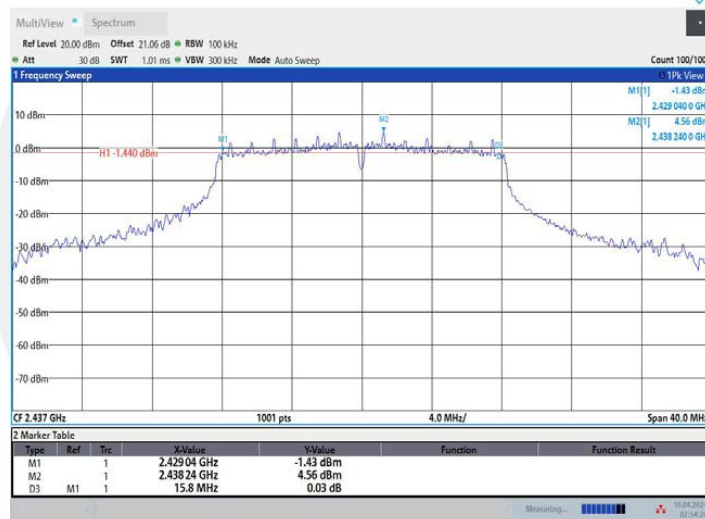

02:54:20 16.04.2024

11G_Ant2_2437

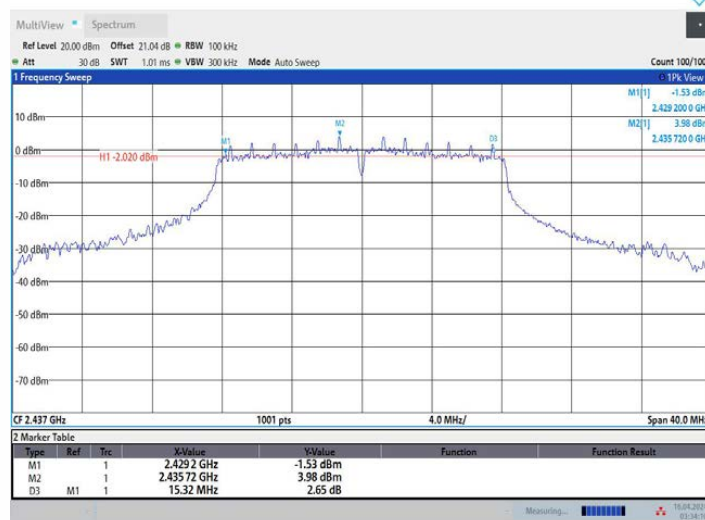

03:34:11 16.04.2024

11G_Ant1_2462

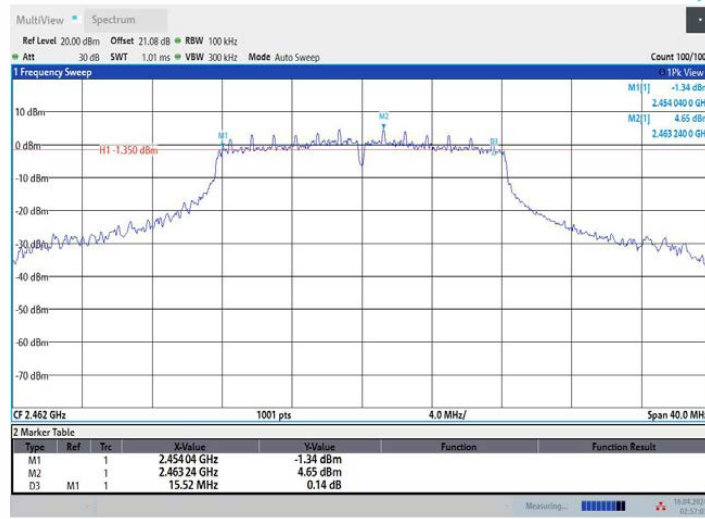

02:57:04 16.04.2024

11G_Ant2_2462

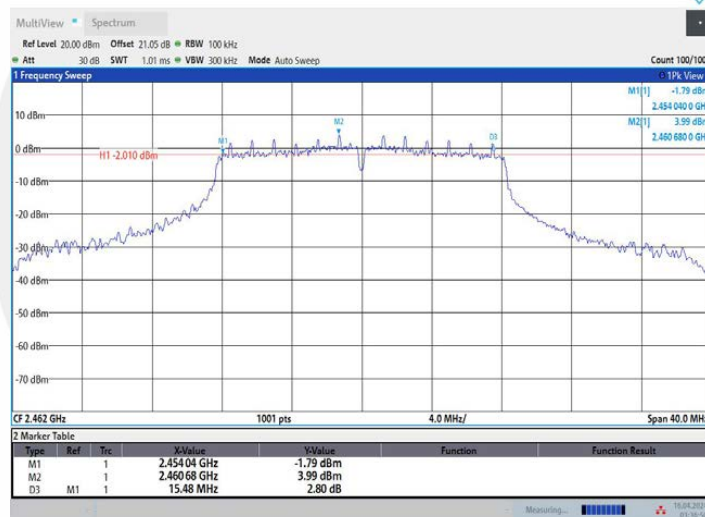

03:36:51 16.04.2024

11N20MIMO Ant1_2412

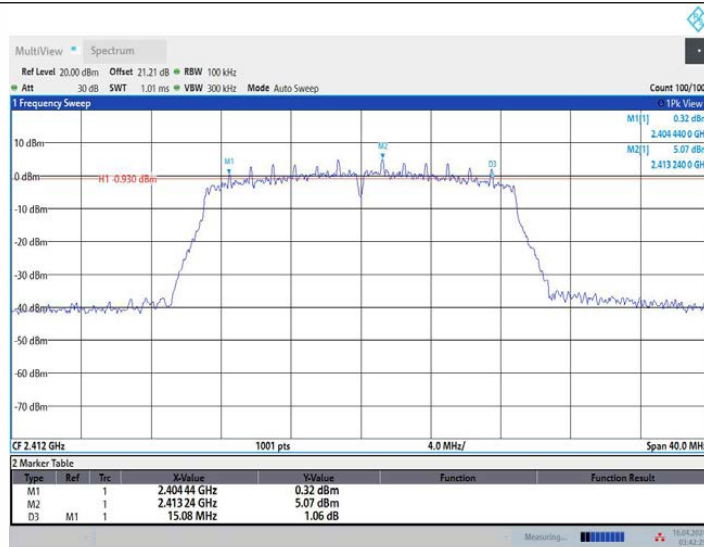

11N20MIMO_Ant2_2412

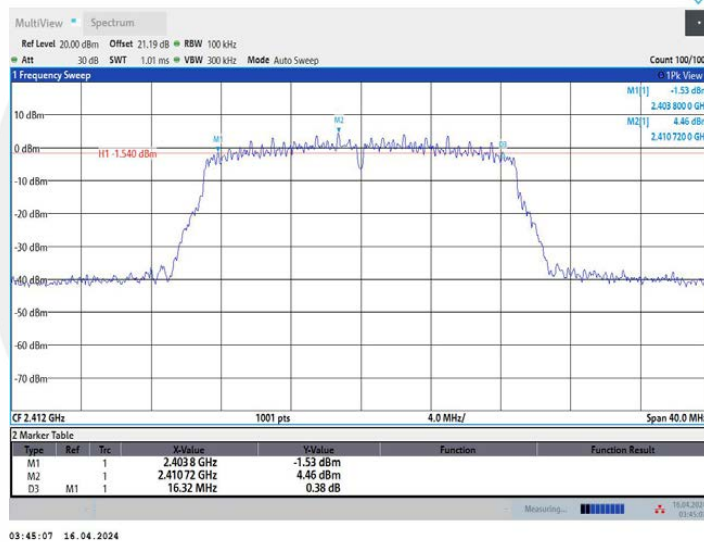

11N20MIMO_Ant1_2437

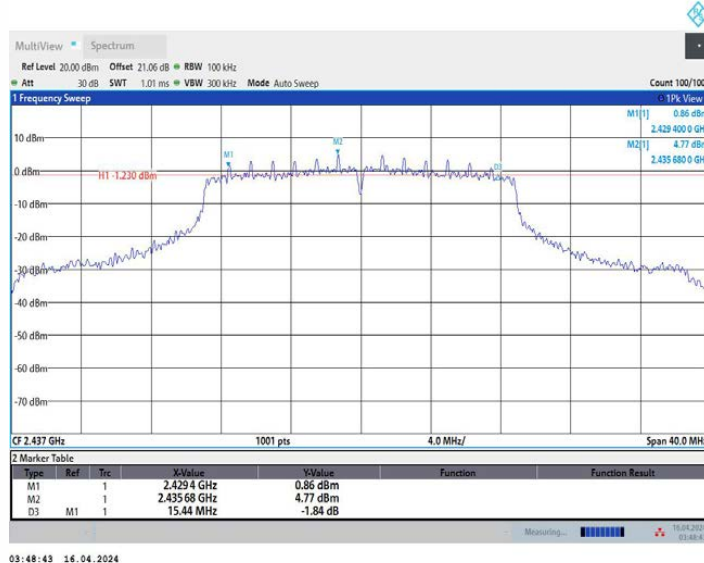

11N20MIMO_Ant2_2437

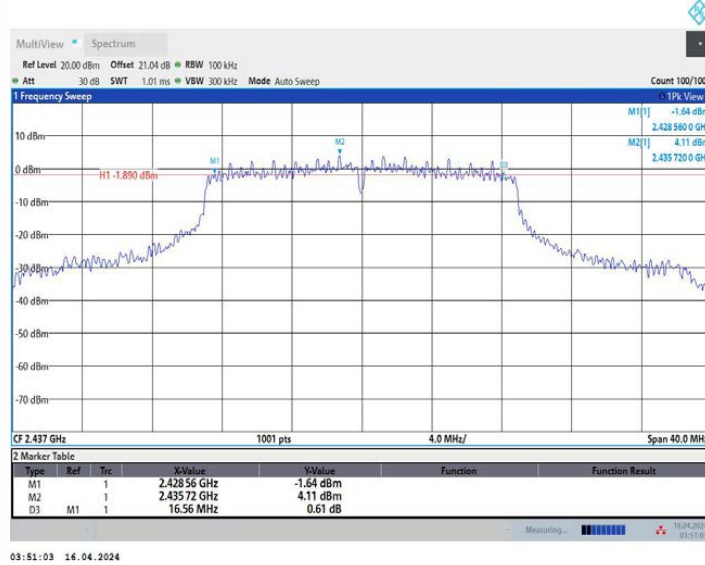

11N20MIMO_Ant1_2462

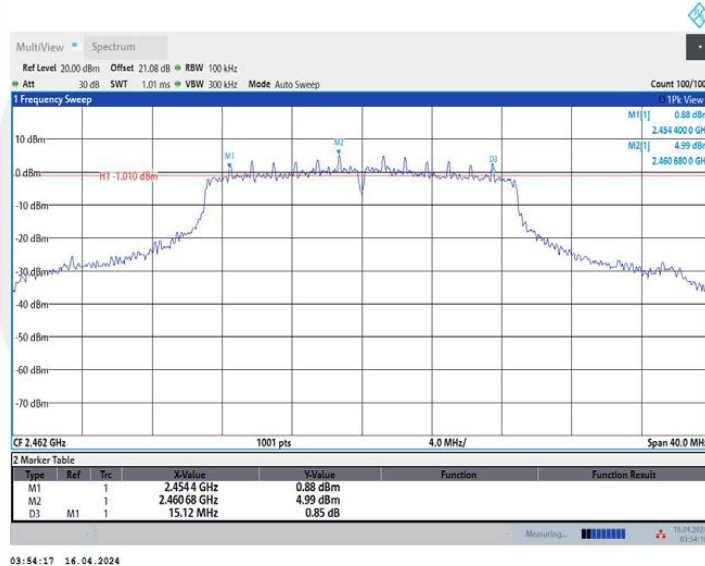

11N20MIMO_Ant2_2462

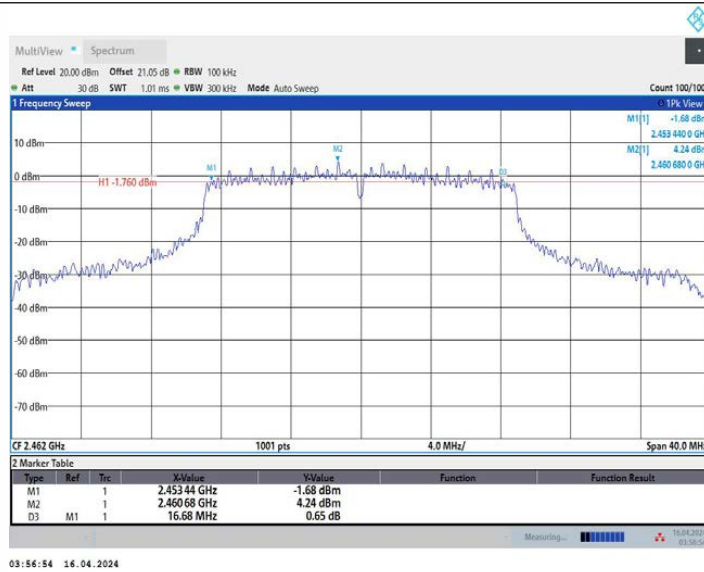

11N40MIMO_Ant1_2422

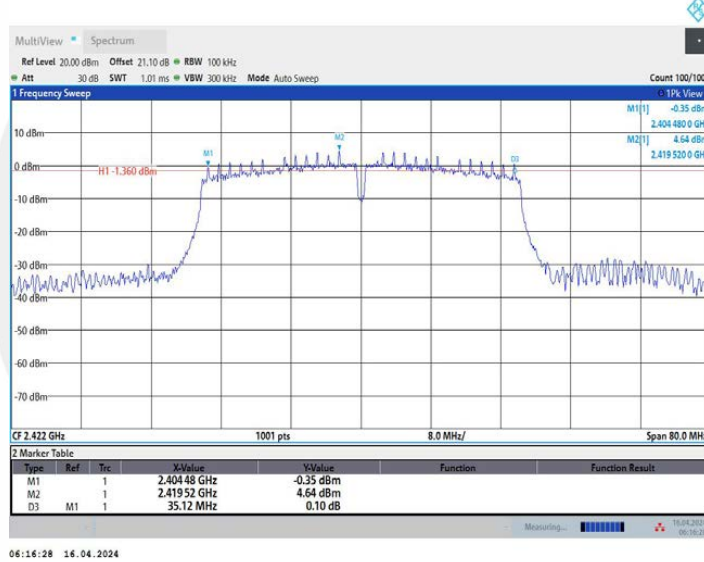

11N40MIMO_Ant2_2422

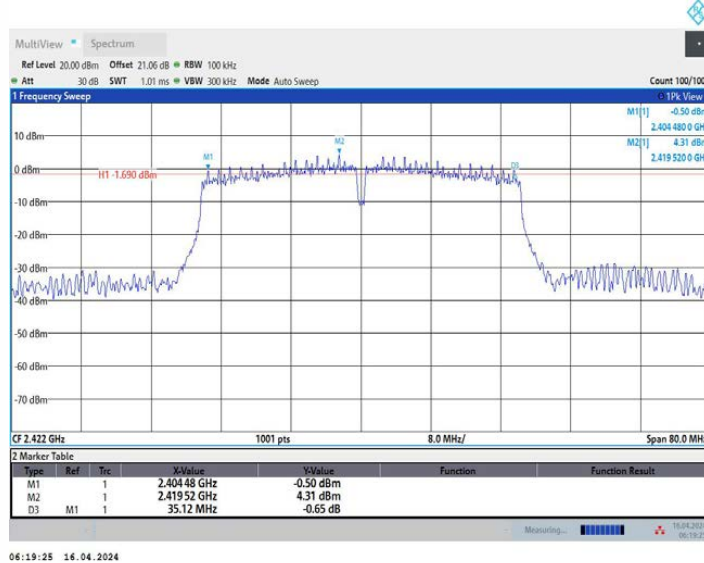

11N40MIMO_Ant1_2437

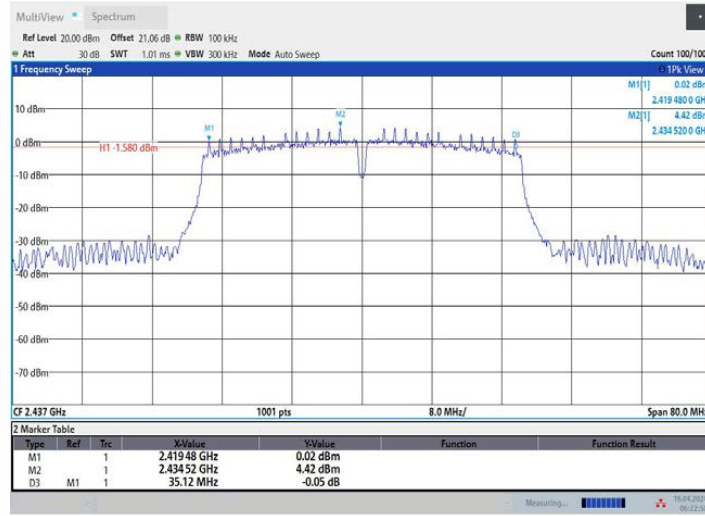

11N40MIMO_Ant2_2437

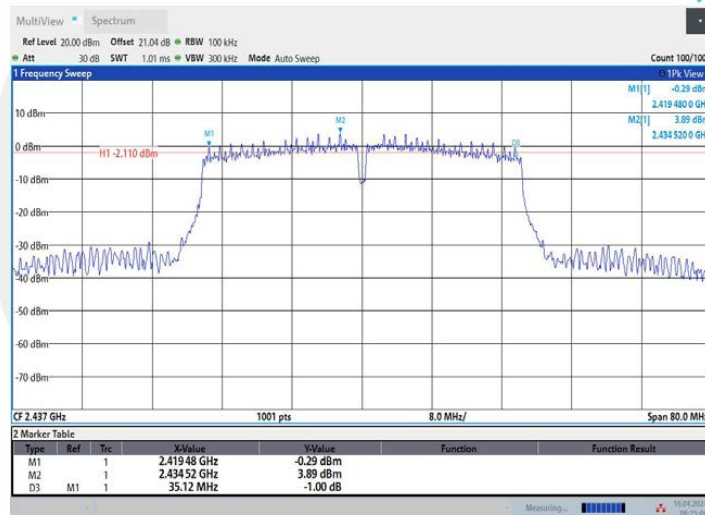

11N40MIMO_Ant1_2452

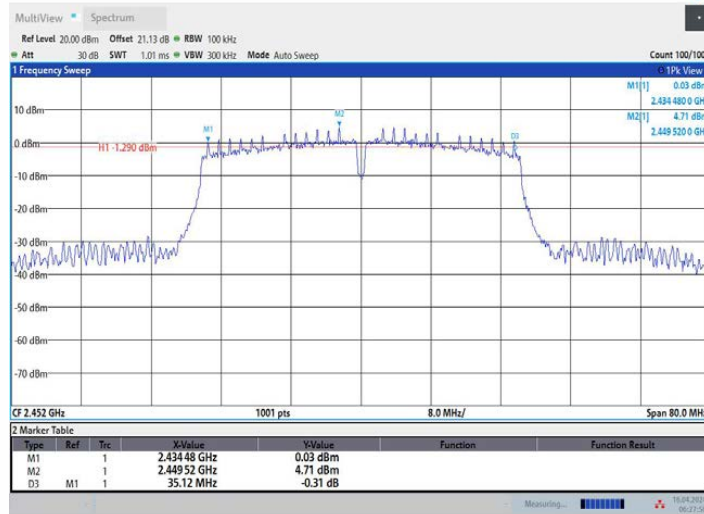

11N40MIMO_Ant2_2452

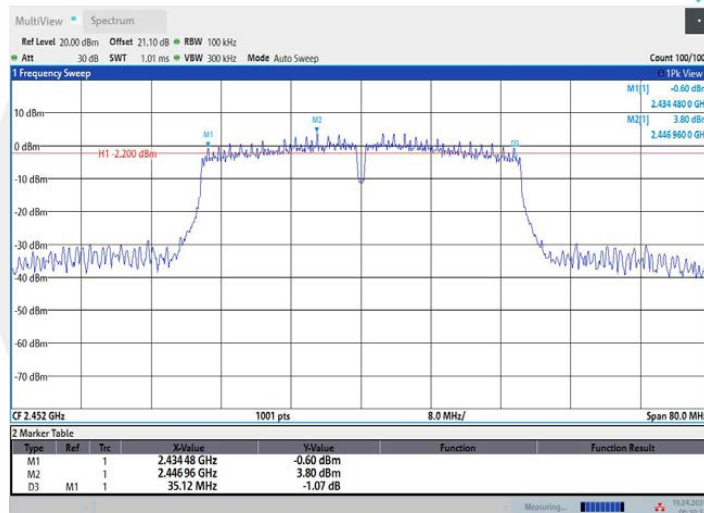

11AX20MIMO_Ant1_2412

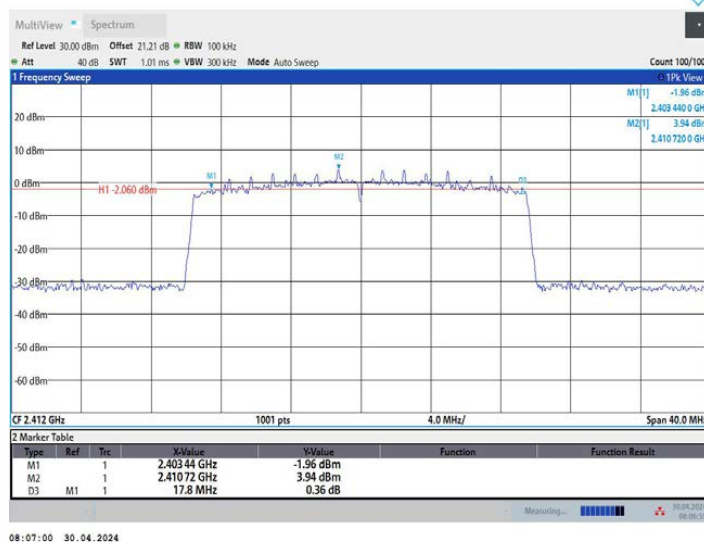

11AX20MIMO_Ant2_2412

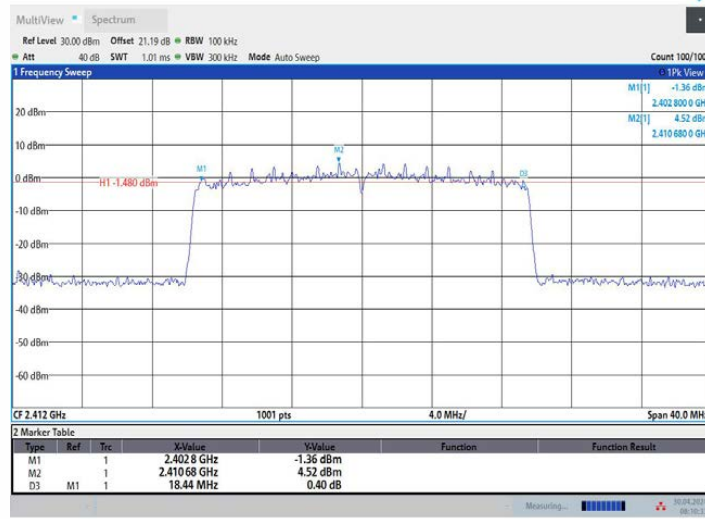

11AX20MIMO_Ant1_2437



11AX20MIMO_Ant2_2437



08:16:33 30.04.2024

11AX20MIMO_Ant1_2462

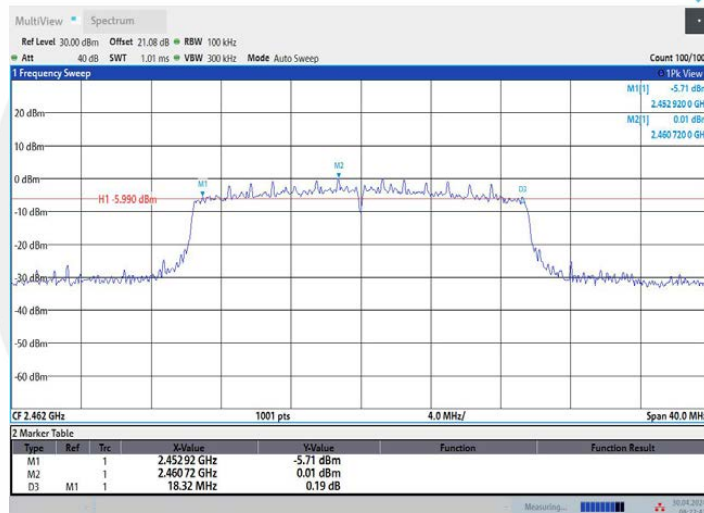

08:22:42 30.04.2024

11AX20MIMO_Ant2_2462

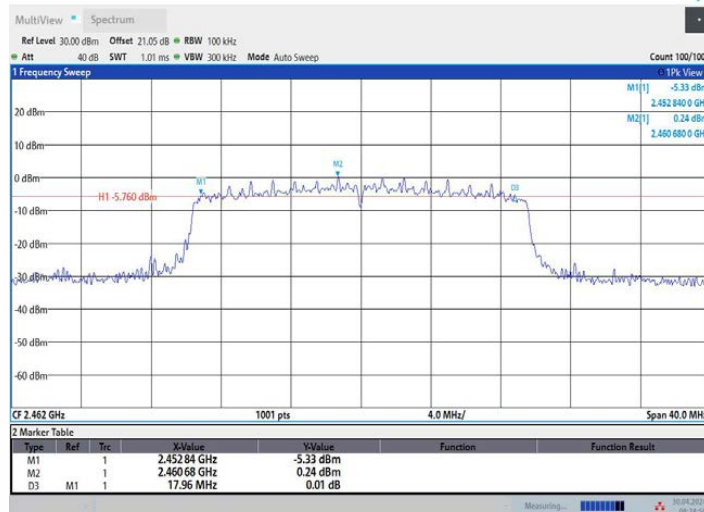

08:24:57 30.04.2024

11AX40MIMO_Ant1_2422

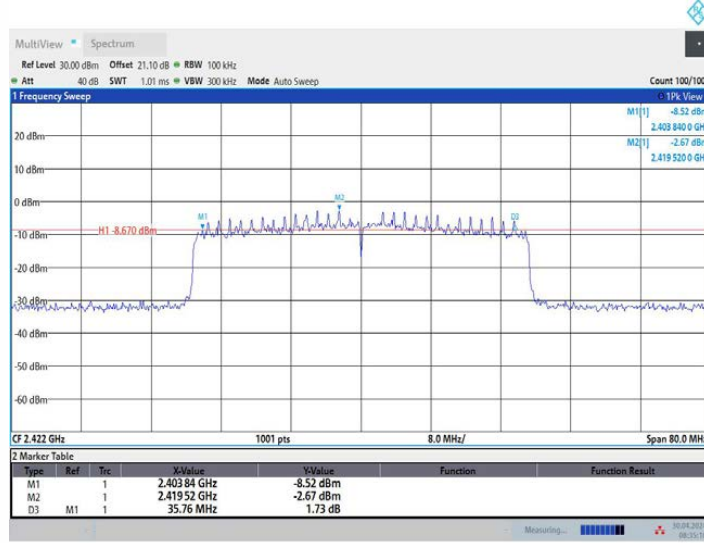

11AX40MIMO_Ant2_2422

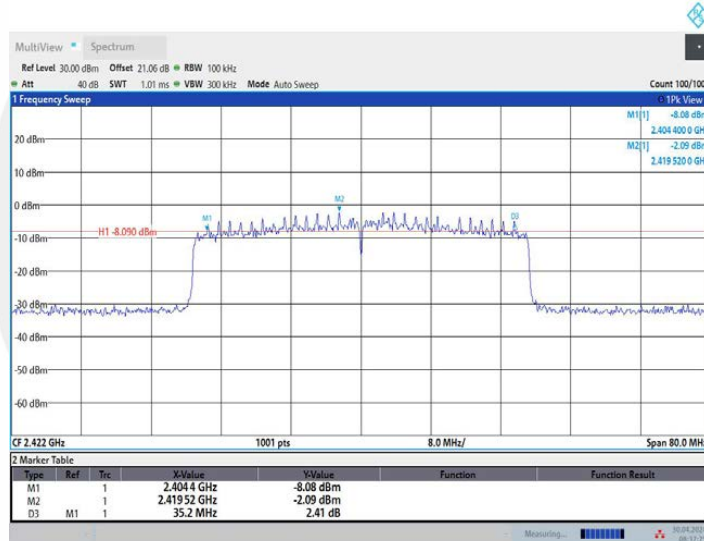

11AX40MIMO_Ant1_2437



11AX40MIMO_Ant2_2437

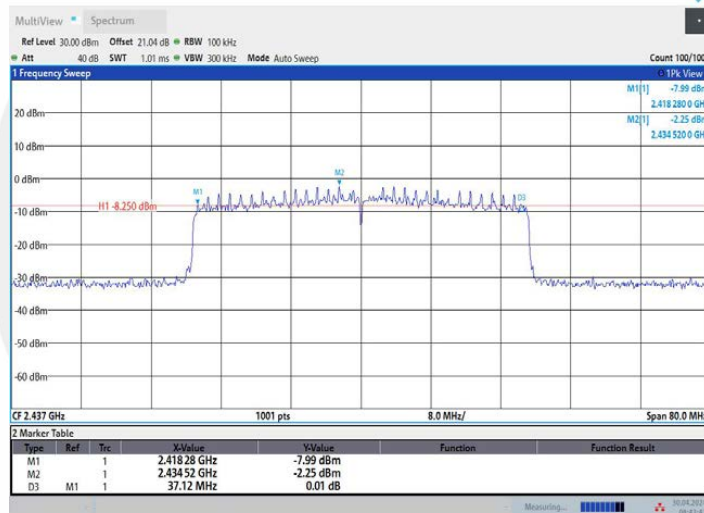

11AX40MIMO_Ant1_2452



11AX40MIMO_Ant2_2452

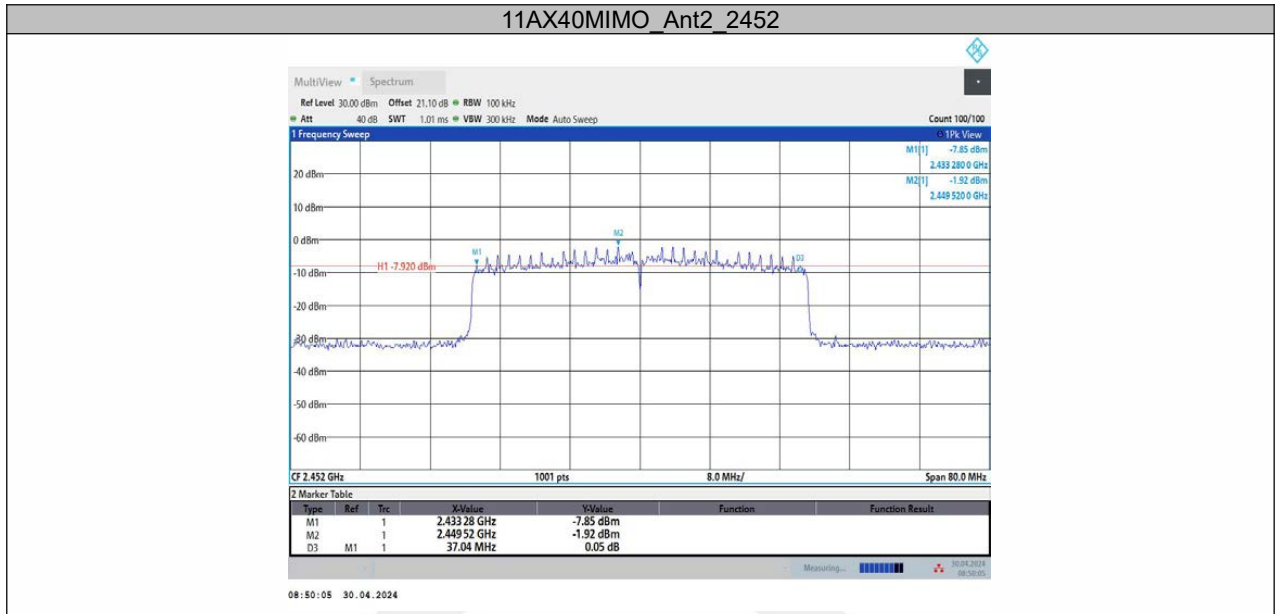

8.3 DTS 99% BANDWIDTH

8.3.1 Applicable Standard

According to RSS-Gen 6.7

8.3.2 Test Configuration

Test according to clause 7.1 radio frequency test setup 1

8.3.3 Test Procedure

The EUT was operating in WIFI mode and controlled its channel. Printed out the test result from the spectrum by hard copy function.

The RF output of EUT was connected to the spectrum analyzer by RF cable and attenuator. The path loss was compensated to the results for each measurement.

Set to the maximum power setting and enable the EUT transmit continuously

Set RBW = 1%-5% OBW.

Set the video bandwidth (VBW) $\geq 3 \times RBW$.

Set Span=approximately 2 to 3 times the 6 dB bandwidth.

Set Detector = Peak.

Set Trace mode = max hold.

Set Sweep = auto couple.

Allow the trace to stabilize.

Use the 99 % power bandwidth function of the instrument

Measure the maximum width of the emission.

If this value varies with different modes of operation (e.g., data rate, modulation format, etc.), repeat this test for each variation.

Measure and record the results in the test report.

8.3.4 Test Results

Temperature:	25°C
Relative Humidity:	45%
ATM Pressure:	1011 mbar
Test Engineer:	XXH

Note: N/A

TestMode	Antenna	Channel Frequency[MHz]	OCB [MHz]	FL[MHz]	FH[MHz]	Limit[MHz]	Verdict
11B	Ant1	2412	12.329	2405.8644	2418.1938	---	---
	Ant2	2412	12.419	2405.8355	2418.2542	---	---
	Ant1	2437	12.71	2430.6495	2443.3591	---	---
	Ant2	2437	12.881	2430.5539	2443.4347	---	---
	Ant1	2462	12.654	2455.6494	2468.3037	---	---
	Ant2	2462	12.857	2455.5360	2468.3935	---	---
11G	Ant1	2412	17.135	2403.4088	2420.5443	---	---
	Ant2	2412	17.103	2403.4106	2420.5138	---	---
	Ant1	2437	19.173	2427.3014	2446.4744	---	---
	Ant2	2437	19.212	2427.2474	2446.4595	---	---
	Ant1	2462	19.008	2452.3497	2471.3579	---	---
	Ant2	2462	19.068	2452.2841	2471.3517	---	---
11N20MIMO	Ant1	2412	17.892	2403.0619	2420.9537	---	---
	Ant2	2412	17.567	2403.2193	2420.7863	---	---
	Ant1	2437	19.668	2427.1652	2446.8327	---	---
	Ant2	2437	18.308	2427.8616	2446.1697	---	---
	Ant1	2462	19.534	2452.1654	2471.6995	---	---
	Ant2	2462	18.239	2452.8818	2471.1204	---	---
11N40MIMO	Ant1	2422	36.203	2403.9560	2440.1588	---	---
	Ant2	2422	36.441	2403.8301	2440.2708	---	---
	Ant1	2437	36.325	2418.8368	2455.1615	---	---
	Ant2	2437	36.512	2418.7444	2455.2563	---	---
	Ant1	2452	36.166	2433.8980	2470.0638	---	---
	Ant2	2452	36.474	2433.7519	2470.2263	---	---
11AX20MIMO	Ant1	2412	18.829	2402.5813	2421.4099	---	---
	Ant2	2412	18.868	2402.5646	2421.4329	---	---
	Ant1	2437	19.179	2427.4098	2446.5886	---	---
	Ant2	2437	19.19	2427.4037	2446.5939	---	---
	Ant1	2462	19.203	2452.3941	2471.5966	---	---
	Ant2	2462	19.225	2452.3560	2471.5805	---	---
11AX40MIMO	Ant1	2422	38.145	2402.9826	2441.1271	---	---
	Ant2	2422	38.002	2403.0513	2441.0534	---	---
	Ant1	2437	38.17	2417.8961	2456.0665	---	---
	Ant2	2437	38.022	2417.9935	2456.0155	---	---
	Ant1	2452	38.113	2432.9514	2471.0642	---	---
	Ant2	2452	38	2433.0030	2471.0028	---	---

11B_Ant1_2412

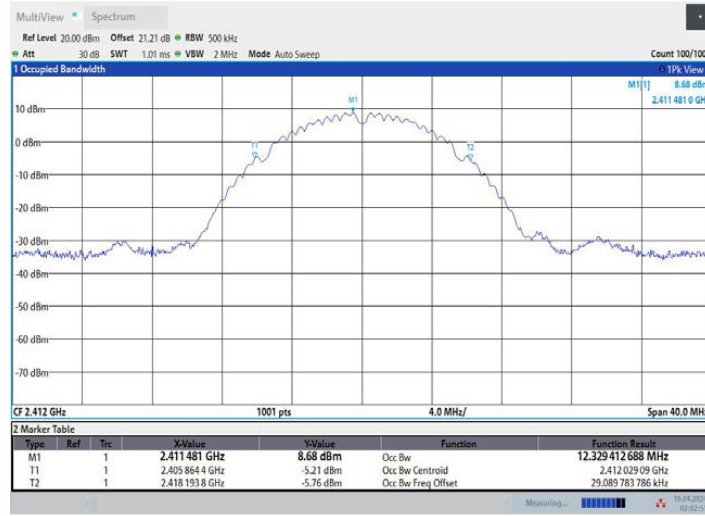

11B_Ant2_2412

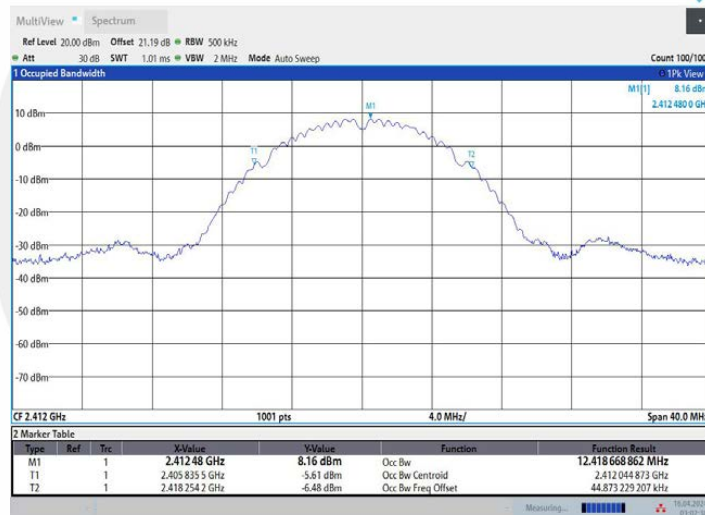

11B_Ant1_2437

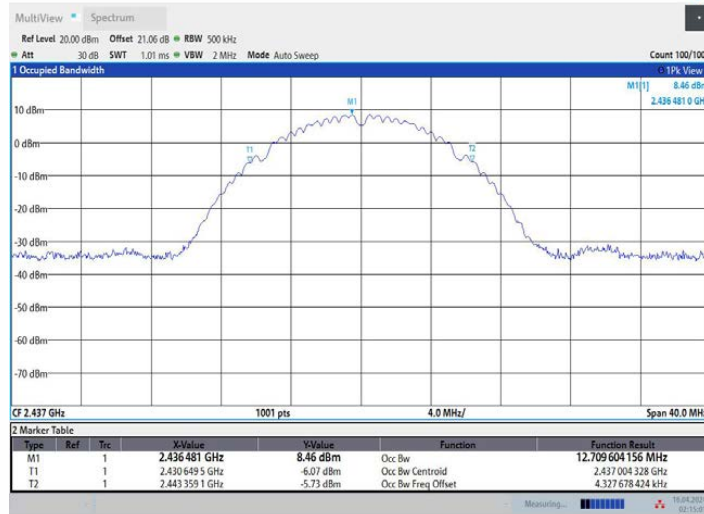

02:15:02 16.04.2024

11B_Ant2_2437



03:07:02 16.04.2024

11B_Ant1_2462

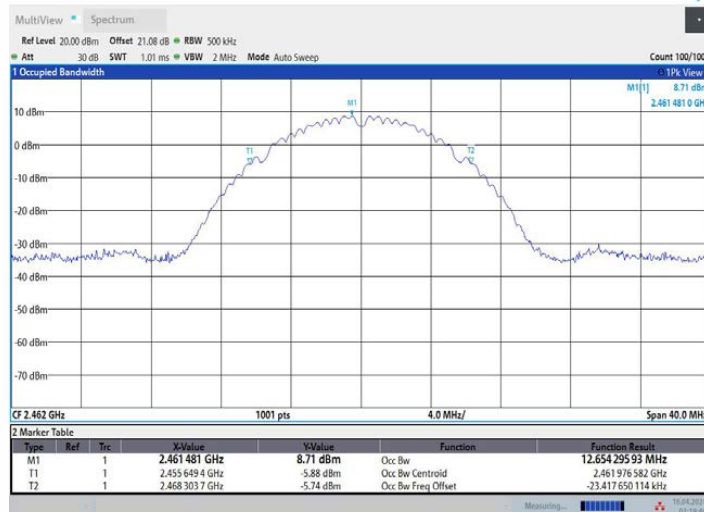

02:19:48 16.04.2024

11B_Ant2_2462

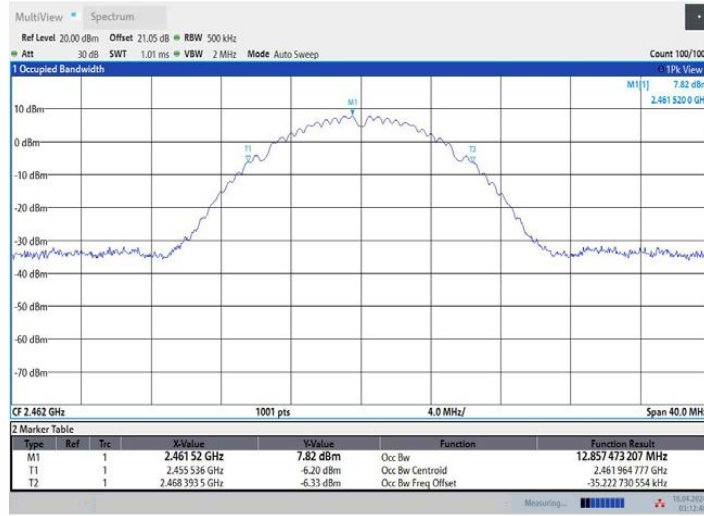

11G_Ant1_2412

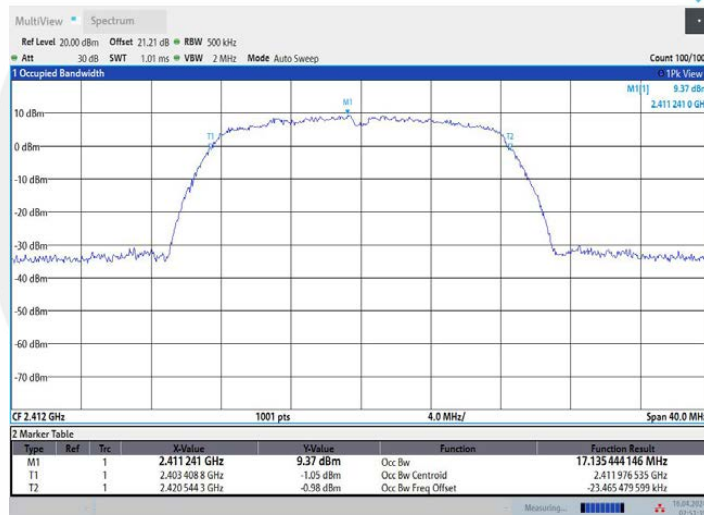

11G_Ant2_2412

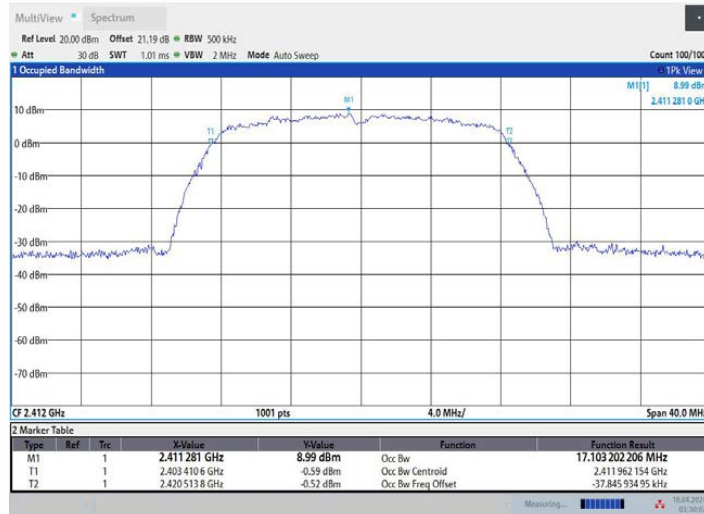

03:30:02 16.04.2024

11G_Ant1_2437

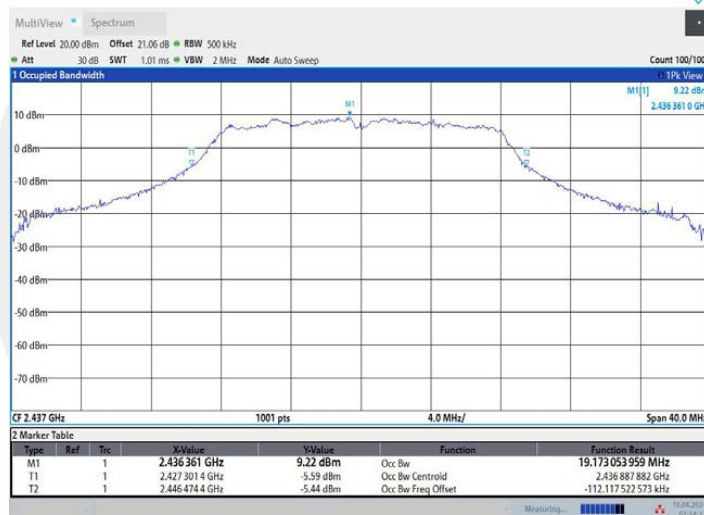

02:54:34 16.04.2024

11G_Ant2_2437

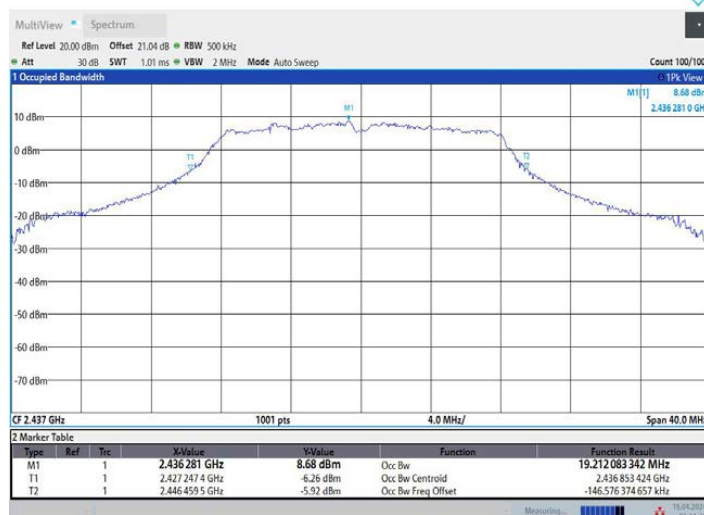

03:34:22 16.04.2024

11G_Ant1_2462

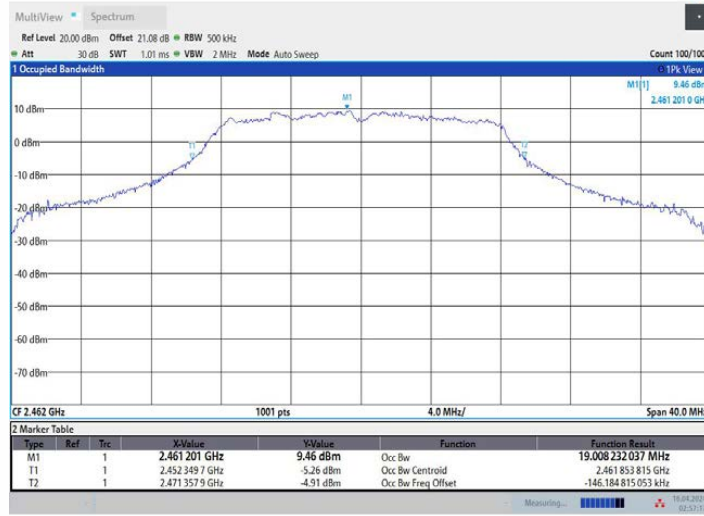

02:57:18 16.04.2024

11G_Ant2_2462



03:37:02 16.04.2024

11N20MIMO Ant1_2412

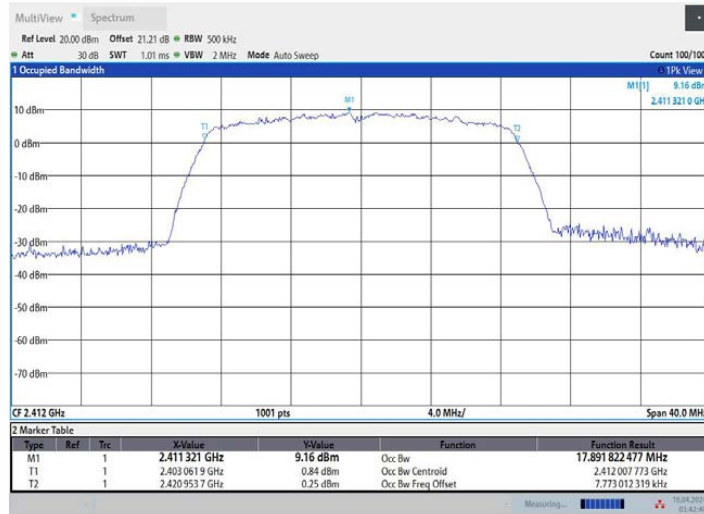

09:42:41 16.04.2024

11N20MIMO_Ant2_2412

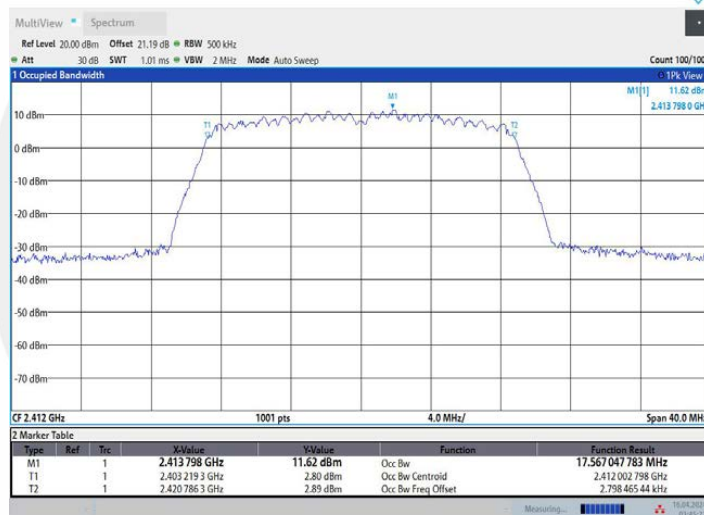

09:45:21 16.04.2024

11N20MIMO_Ant1_2437

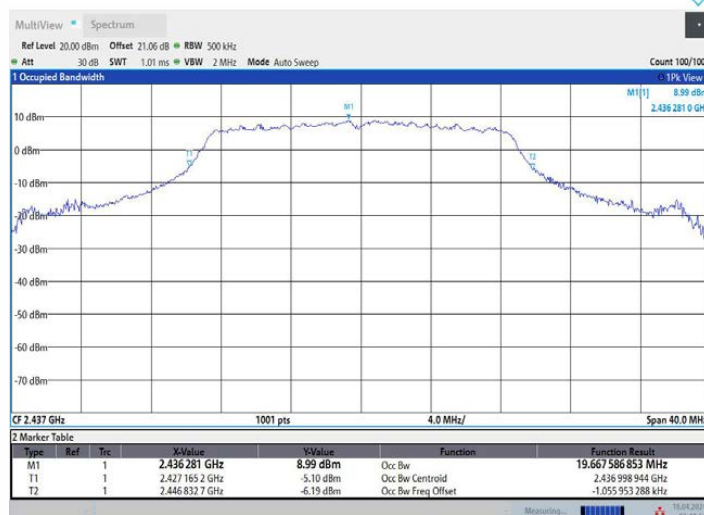

09:48:57 16.04.2024

11N20MIMO_Ant2_2437

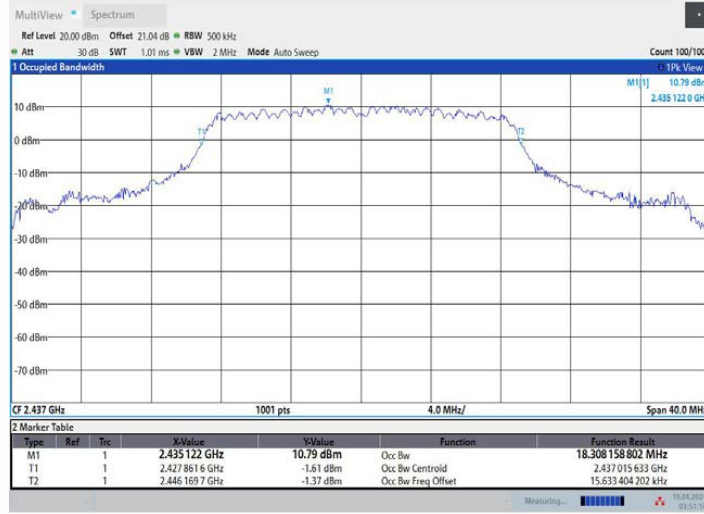

11N20MIMO_Ant1_2462

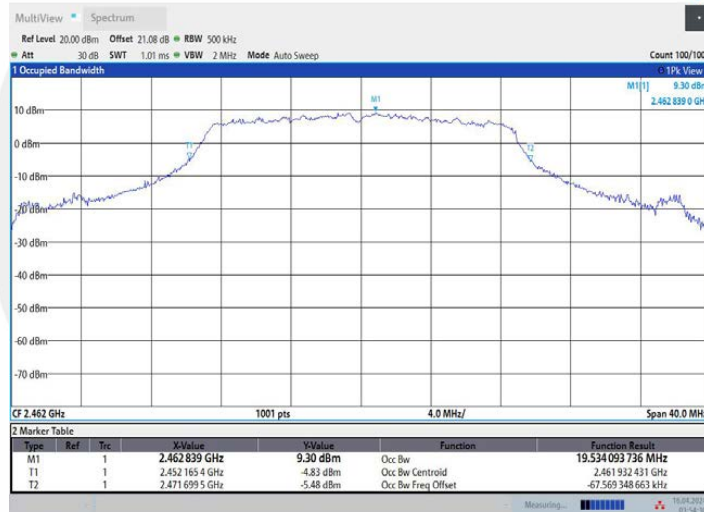

11N20MIMO_Ant2_2462

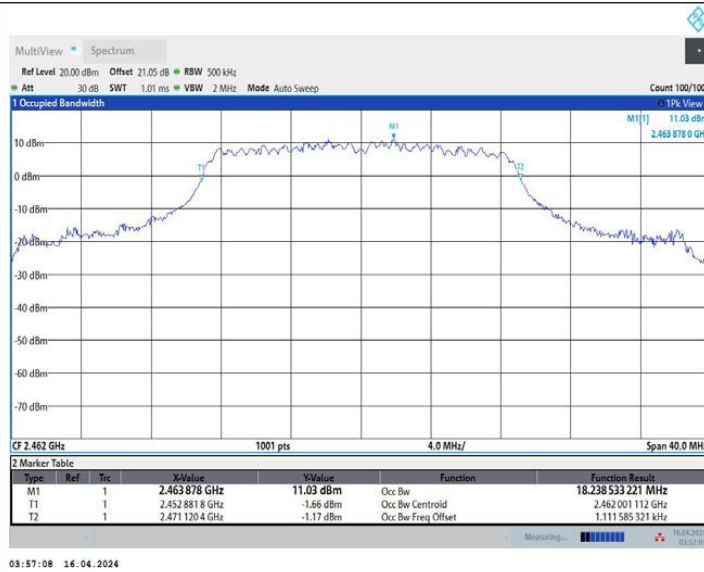

03:57:08 16.04.2024

11N40MIMO_Ant1_2422



06:16:40 16.04.2024

11N40MIMO_Ant2_2422

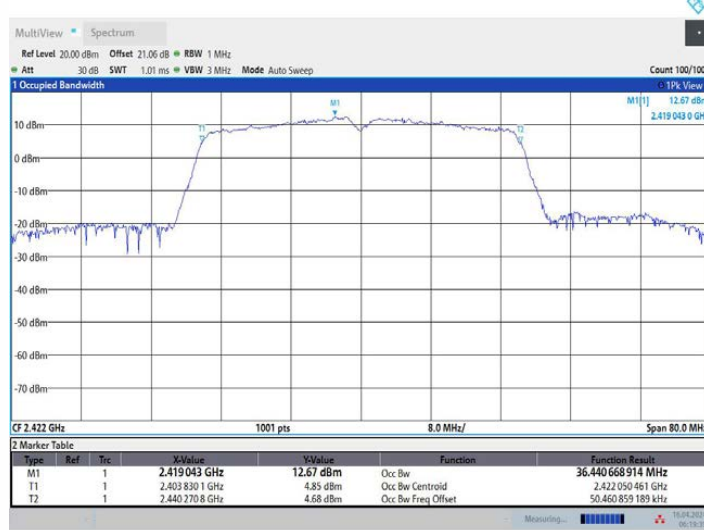

06:19:39 16.04.2024

11N40MIMO_Ant1_2437

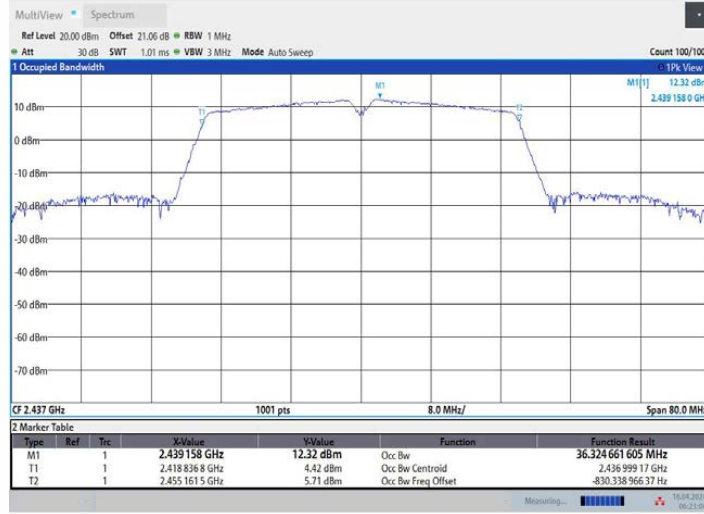

11N40MIMO_Ant2_2437



11N40MIMO_Ant1_2452

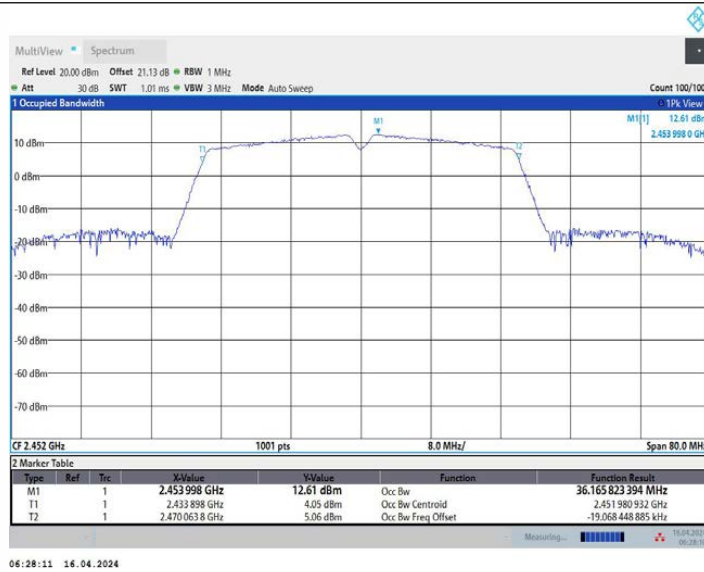

11N40MIMO_Ant2_2452

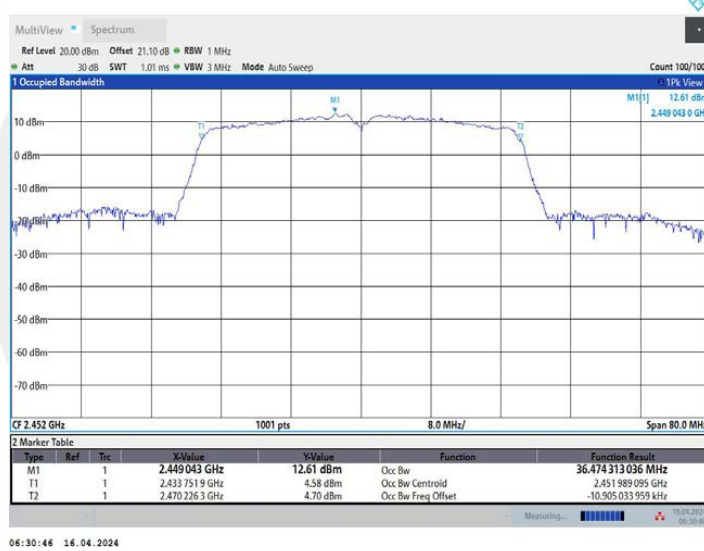

11AX20MIMO_Ant1_2412

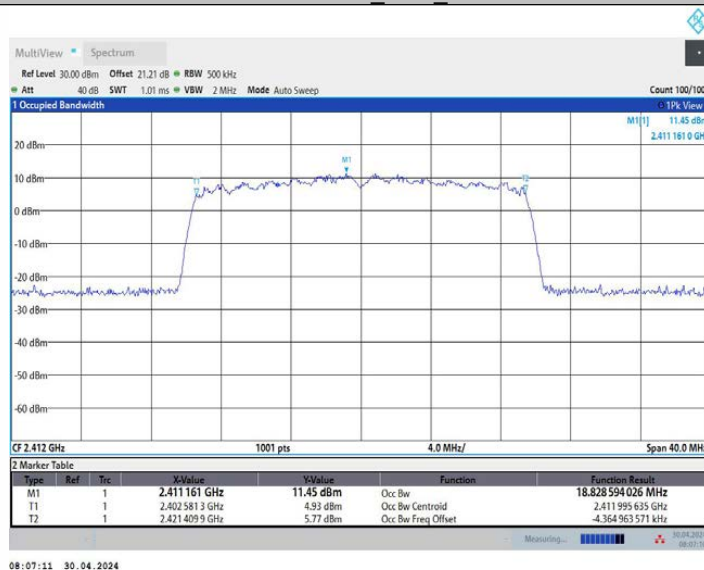

11AX20MIMO_Ant2_2412

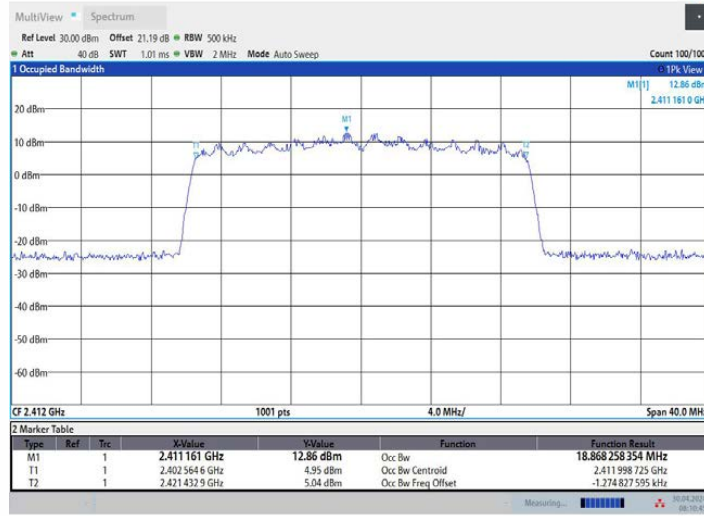

11AX20MIMO_Ant1_2437

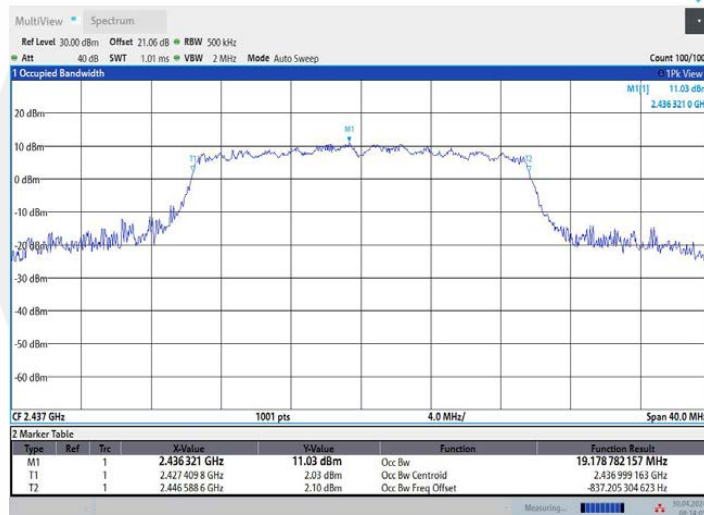

11AX20MIMO_Ant2_2437

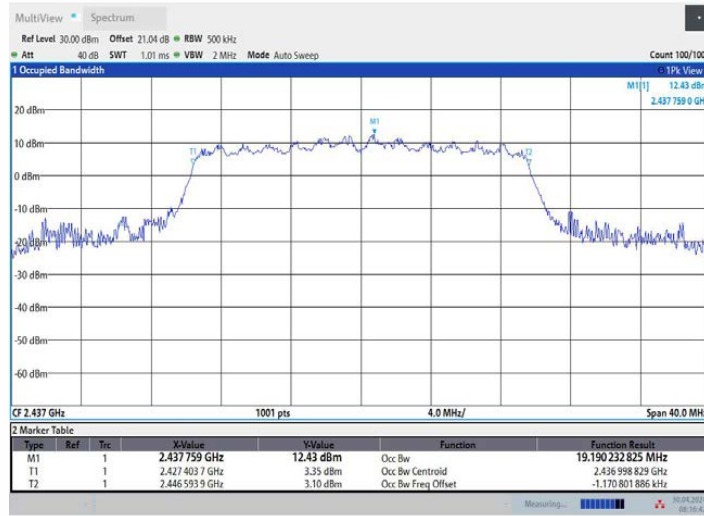

08:16:43 30.04.2024

11AX20MIMO_Ant1_2462

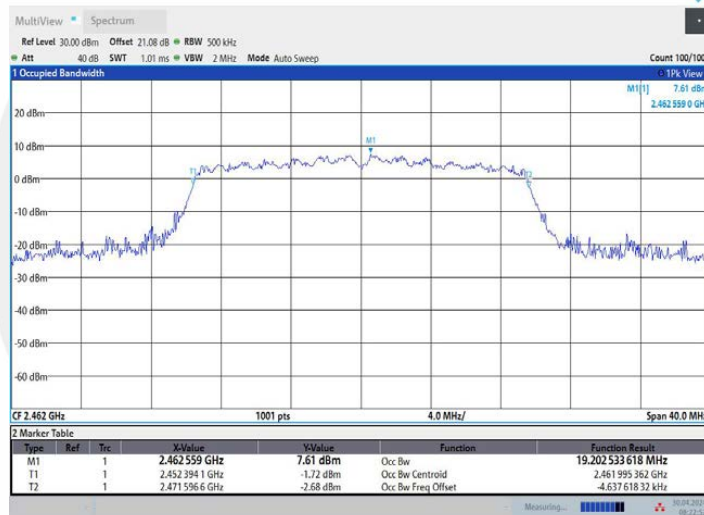

08:22:53 30.04.2024

11AX20MIMO_Ant2_2462

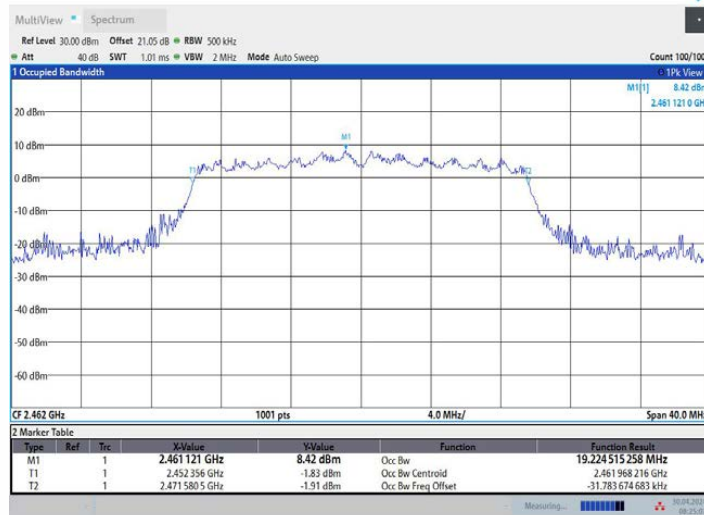

08:25:08 30.04.2024

11AX40MIMO_Ant1_2422

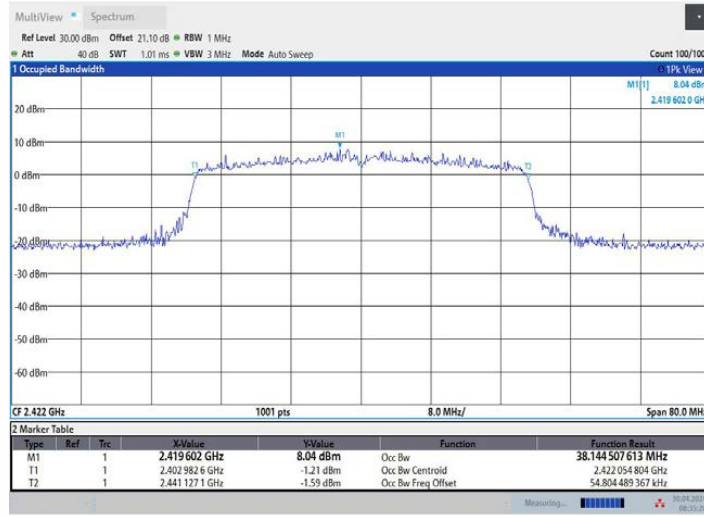

08:35:28 30.04.2024

11AX40MIMO_Ant2_2422

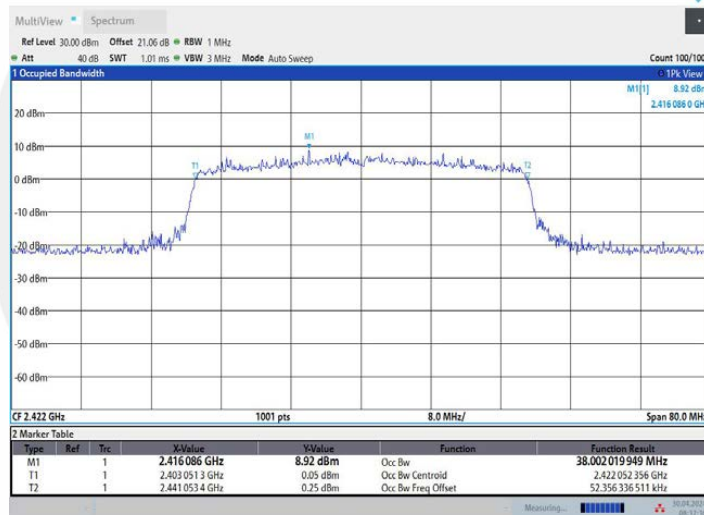

08:37:36 30.04.2024

11AX40MIMO_Ant1_2437

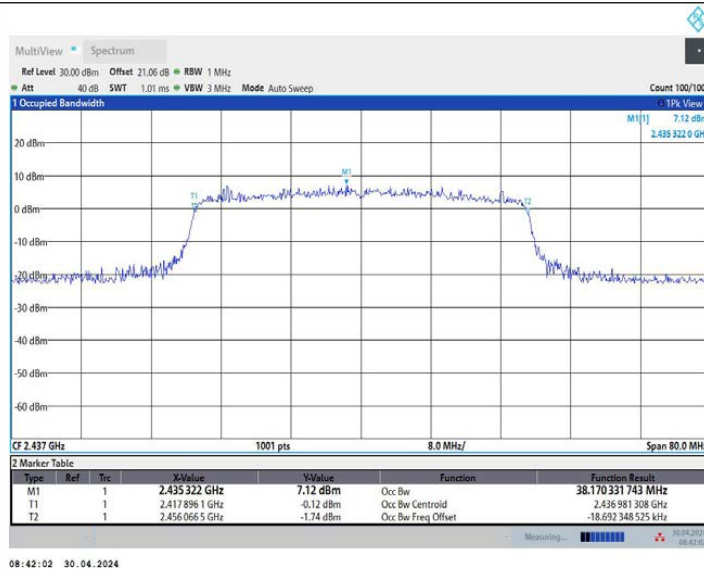

08:42:02 30.04.2024

11AX40MIMO_Ant2_2437

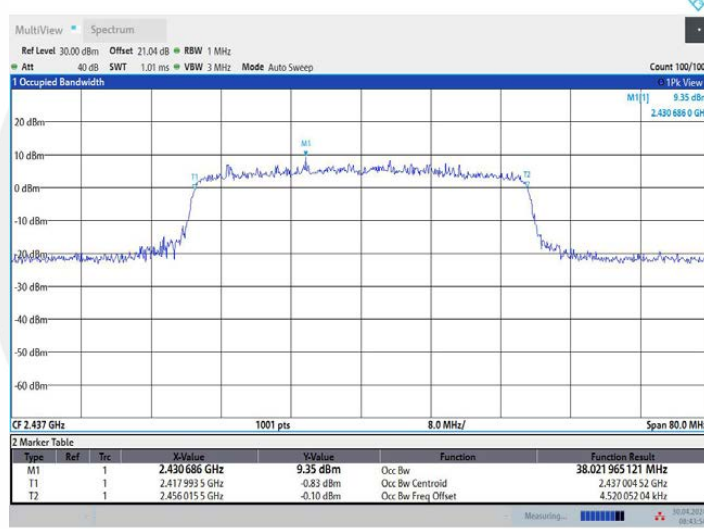

08:43:55 30.04.2024

11AX40MIMO_Ant1_2452

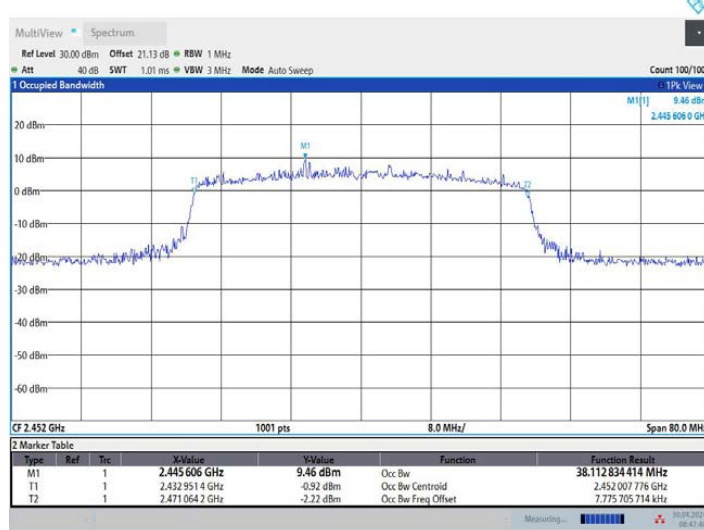

08:47:49 30.04.2024

11AX40MIMO_Ant2_2452

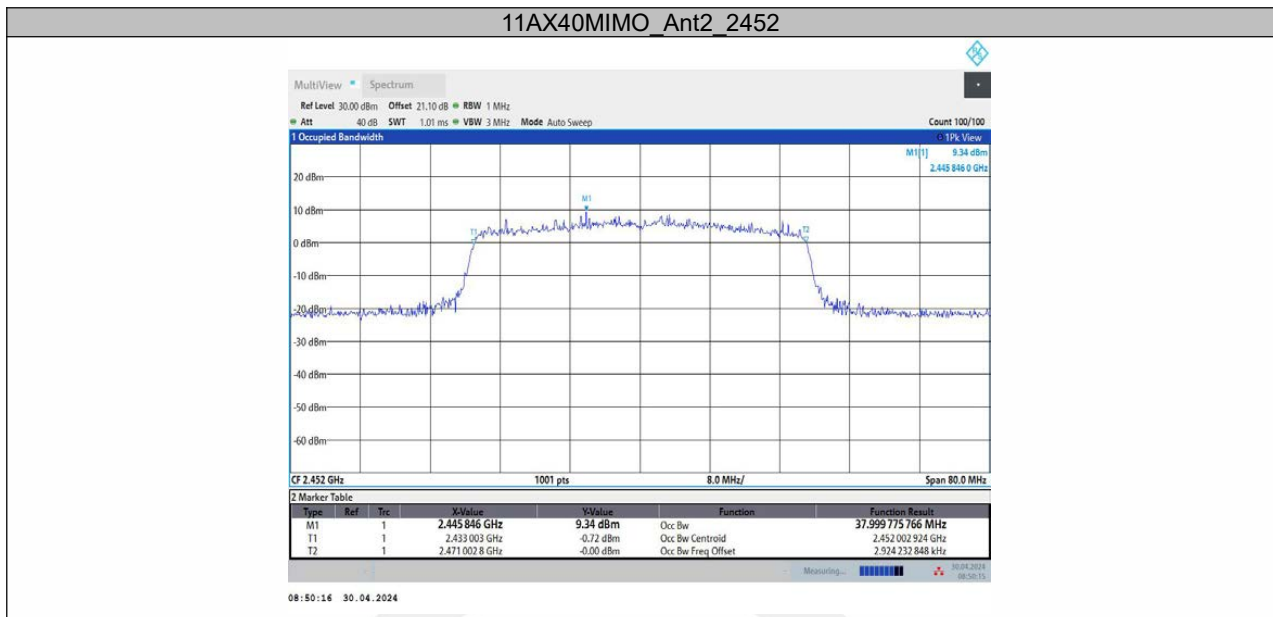

8.4 MAXIMUM PEAK CONDUCTED OUTPUT POWER

8.4.1 Applicable Standard

According to FCC Part 15.247 (b)(3)
 According to RSS-247 5.4(d)
 According to RSS-Gen 6.12
 According to 558074 D01 15.247 Meas Guidance v05r02 Section 8.3.2.2
 According to ANSI C63.10 Section 11.9.2.2.4

8.4.2 Conformance Limit

The maximum conducted output power of the intentional radiator for systems using digital modulation in the 2400 - 2483.5 MHz bands shall not exceed: 1 Watt (30dBm).

8.4.3 Test Configuration

Test according to clause 7.1 radio frequency test setup

8.4.4 Test Procedure

- a) Measure the duty cycle D of the transmitter output signal.
- b) Set span to at least 1.5 times the OBW.
- c) Set RBW = 1% to 5% of the OBW, not to exceed 1 MHz.
- d) Set VBW $\geq [3 \times \text{RBW}]$.
- e) Number of points in sweep $\geq [2 \times \text{span} / \text{RBW}]$. (This gives bin-to-bin spacing $\leq \text{RBW} / 2$, so that narrowband signals are not lost between frequency bins.)
- f) Sweep time = auto.
- g) Detector = RMS (i.e., power averaging), if available. Otherwise, use the sample detector mode.
- h) Do not use sweep triggering. Allow the sweep to "free run."
- i) Trace average at least 100 traces in power averaging (rms) mode; however, the number of traces to be averaged shall be increased above 100 as needed such that the average accurately represents the true average over the ON and OFF periods of the transmitter.
- j) Compute power by integrating the spectrum across the OBW of the signal using the instrument's band power measurement function with band limits set equal to the OBW band edges. If the instrument does not have a band power function, then sum the spectrum levels (in power units) at intervals equal to the RBW extending across the entire OBW of the spectrum.
- k) Add $[10 \log (1 / D)]$, where D is the duty cycle, to the measured power to compute the average power during the actual transmission times (because the measurement represents an average over both the ON and OFF times of the transmission). For example, add $[10 \log (1/0.25)] = 6 \text{ dB}$ if the duty cycle is 25%.

■ According to FCC Part 15.247(b)(4):

Conducted output power limit specified in paragraph (b) of this section is based on the use of antennas with directional gains that do not exceed 6 dBi. If transmitting antennas of directional gain greater than 6 dBi are used, the conducted output power from the intentional radiator shall be reduced below the stated values in paragraphs (b)(3) of this section, as appropriate, by the amount in dB that the directional gain of the antenna exceeds 6 dBi.

Note: If antenna Gain exceeds 6 dBi, then Output power Limit = $30 - (\text{Gain} - 6)$

8.4.5 Test Results

Temperature:	25 °C
Relative Humidity:	45%
ATM Pressure:	1011 mbar
Test Engineer:	XXH

Note: N/A

TestMode	Antenna	Frequency[MHz]	Peak Power[dBm]	Conducted Limit[dBm]	Verdict
11B	Ant1	2412	11.47	≤30.00	PASS
	Ant2	2412	12.15	≤30.00	PASS
	Ant1	2437	16.11	≤30.00	PASS
	Ant2	2437	15.38	≤30.00	PASS
	Ant1	2462	16.35	≤30.00	PASS
	Ant2	2462	15.45	≤30.00	PASS
11G	Ant1	2412	15.29	≤30.00	PASS
	Ant2	2412	14.91	≤30.00	PASS
	Ant1	2437	15.21	≤30.00	PASS
	Ant2	2437	14.62	≤30.00	PASS
	Ant1	2462	15.38	≤30.00	PASS
	Ant2	2462	14.67	≤30.00	PASS
11N20MIMO	Ant1	2412	15.34	≤30.00	PASS
	Ant2	2412	15.13	≤30.00	PASS
	total	2412	18.25	≤30.00	PASS
	Ant1	2437	15.27	≤30.00	PASS
	Ant2	2437	14.92	≤30.00	PASS
	total	2437	18.11	≤30.00	PASS
	Ant1	2462	15.38	≤30.00	PASS
	Ant2	2462	14.94	≤30.00	PASS
total	2462	18.18	≤30.00	PASS	
11N40MIMO	Ant1	2422	17.62	≤30.00	PASS
	Ant2	2422	17.07	≤30.00	PASS
	total	2422	20.36	≤30.00	PASS
	Ant1	2437	17.66	≤30.00	PASS
	Ant2	2437	16.99	≤30.00	PASS
	total	2437	20.35	≤30.00	PASS
	Ant1	2452	17.74	≤30.00	PASS
	Ant2	2452	17.06	≤30.00	PASS
total	2452	20.42	≤30.00	PASS	
11AX20MIMO	Ant1	2412	14.93	≤30.00	PASS
	Ant2	2412	15.21	≤30.00	PASS
	total	2412	18.08	≤30.00	PASS
	Ant1	2437	14.69	≤30.00	PASS
	Ant2	2437	15.19	≤30.00	PASS
	total	2437	17.96	≤30.00	PASS
	Ant1	2462	11.12	≤30.00	PASS
	Ant2	2462	11.13	≤30.00	PASS
total	2462	14.14	≤30.00	PASS	
11AX40MIMO	Ant1	2422	10.65	≤30.00	PASS
	Ant2	2422	11.47	≤30.00	PASS
	total	2422	14.09	≤30.00	PASS
	Ant1	2437	10.78	≤30.00	PASS
	Ant2	2437	11.32	≤30.00	PASS
	total	2437	14.07	≤30.00	PASS
	Ant1	2452	10.84	≤30.00	PASS
	Ant2	2452	10.71	≤30.00	PASS
total	2452	13.79	≤30.00	PASS	

11B_Ant1_2412

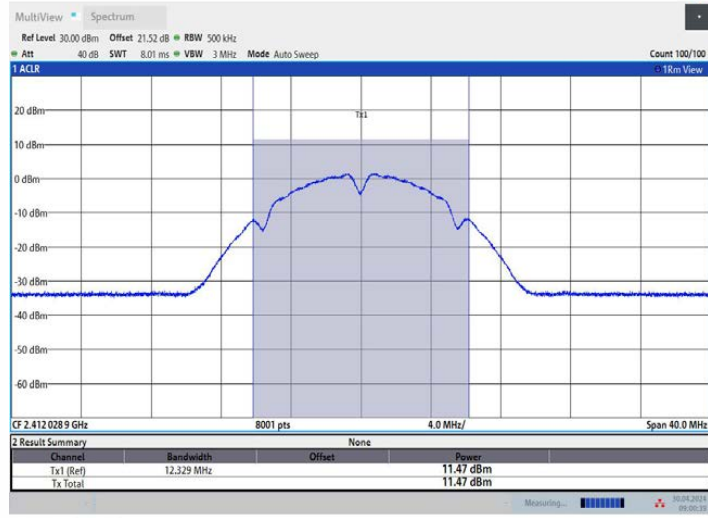

11B_Ant2_2412

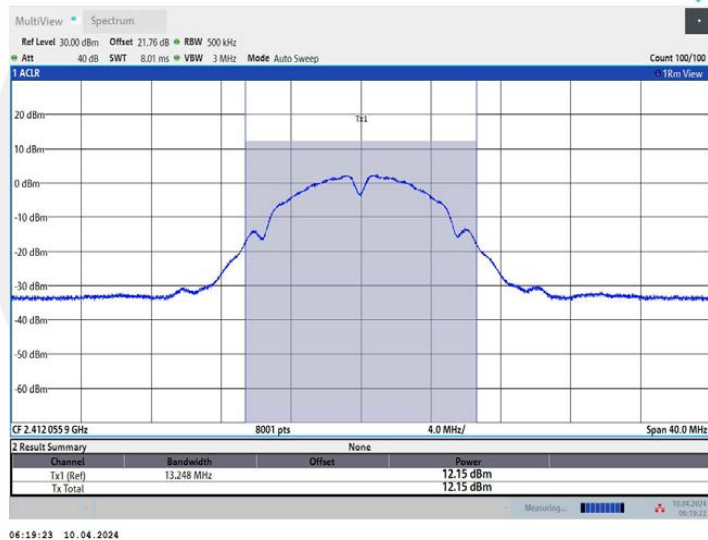

11B_Ant1_2437