

# TEST REPORT

**Product Name** : Mini Projector  
**Model Number** : C015FGE,C015\*\*\*\*\* (\*=0-9, a-z, A-Z, - or blank, indicates for different market purposes)  
**FCC ID** : 2AZNP-C015FGE

**Prepared for Address** : Formovie (Chongqing) Innovative Technology Co., Ltd.  
4-401, #2 Longgang Road, Guojiatuo Area, Jiangbei District, Chongqing, China

**Prepared by Address** : EMTEK (SHENZHEN) CO., LTD.  
Building 69, Majialong Industry Zone, Nanshan District, Shenzhen, Guangdong, China

Tel: (0755) 26954280  
Fax: (0755) 26954282

**Report Number** : ENS2108060161W00204R  
**Date(s) of Tests** : Aug 10,2021 to Sep 4,2021  
**Date of issue** : Sep 6,2021

# 1 TEST RESULT CERTIFICATION

Applicant : Formovie (Chongqing) Innovative Technology Co., Ltd.  
 Address : 4-401, #2 Longgang Road, Guojiatuo Area, Jiangbei District, Chongqing, China  
 Manufacturer : Formovie (Chongqing) Innovative Technology Co., Ltd.  
 Address : 4-401, #2 Longgang Road, Guojiatuo Area, Jiangbei District, Chongqing, China  
 EUT : Mini Projector  
 Model Name : C015FGE,C015\*\*\*\*\* (\*=0-9, a-z, A-Z, - or blank, indicates for different market purposes)  
 Trademark : HEYUP, WEWATCH,Xming

Measurement Procedure Used:

APPLICABLE STANDARDS	
STANDARD	TEST RESULT
FCC 47 CFR Part 2, Subpart J FCC 47 CFR Part 15, Subpart E	PASS

The above equipment was tested by EMTEK (SHENZHEN) CO., LTD. The test data, data evaluation, test procedures, and equipment configurations shown in this report were made in accordance with the procedures given in ANSI C63.10 (2013) and the energy emitted by the sample EUT tested as described in this report is in compliance with the requirements of FCC Rules Part 2 and Part 15.407

The test results of this report relate only to the tested sample identified in this report.

Date of Test : Aug 10,2021 to Sep 4,2021

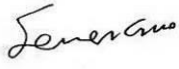
Prepared by :   
Sewen Guo /Editor

Reviewer :   
Sevin Li /Supervisor

Approve & Authorized Signer :   
Lisa Wang/Manager



## Modified History

Version	Report No.	Revision Date	Summary
V1.0	ENS2108060161W00204 R	/	Original Report



## TABLE OF CONTENTS

<b>1</b>	<b>TEST RESULT CERTIFICATION .....</b>	<b>2</b>
<b>2</b>	<b>EUT TECHNICAL DESCRIPTION .....</b>	<b>5</b>
<b>3</b>	<b>SUMMARY OF TEST RESULT .....</b>	<b>7</b>
<b>4</b>	<b>TEST METHODOLOGY .....</b>	<b>8</b>
4.1	GENERAL DESCRIPTION OF APPLIED STANDARDS .....	8
4.2	MEASUREMENT EQUIPMENT USED .....	8
4.3	DESCRIPTION OF TEST MODES .....	10
<b>5</b>	<b>FACILITIES AND ACCREDITATIONS .....</b>	<b>14</b>
5.1	FACILITIES .....	14
5.2	EQUIPMENT .....	14
5.3	LABORATORY ACCREDITATIONS AND LISTINGS .....	14
<b>6</b>	<b>TEST SYSTEM UNCERTAINTY .....</b>	<b>15</b>
<b>7</b>	<b>SETUP OF EQUIPMENT UNDER TEST .....</b>	<b>16</b>
7.1	RADIO FREQUENCY TEST SETUP .....	16
7.2	RADIO FREQUENCY TEST SETUP .....	16
7.3	CONDUCTED EMISSION TEST SETUP .....	18
7.4	BLOCK DIAGRAM CONFIGURATION OF TEST SYSTEM .....	19
7.5	SUPPORT EQUIPMENT .....	19
<b>8</b>	<b>TEST REQUIREMENTS .....</b>	<b>20</b>
8.1	BANDWIDTH MEASUREMENT .....	20
8.2	MAXIMUM CONDUCTED OUTPUT POWER .....	54
8.3	MAXIMUM PEAK POWER DENSITY .....	64
8.4	FREQUENCY STABILITY .....	134
8.5	UNDESIRABLE RADIATED SPURIOUS EMISSION .....	143
8.6	POWER LINE CONDUCTED EMISSIONS .....	172
8.7	ANTENNA APPLICATION .....	175

## 2 EUT TECHNICAL DESCRIPTION

Characteristics	Description
<b>Product:</b>	Mini Projector
<b>Model Number:</b>	C015FGE,C015***** (*=0-9, a-z, A-Z, - or blank, indicates for different market purposes) (These models are identical in circuitry and electrical, mechanical and physical construction; Only indicates for different market purposes; We chose C015FGE as the final test prototype)
<b>Sample Number:</b>	2#
<b>Wifi Type:</b>	<input checked="" type="checkbox"/> Wifi 5G with 5150MHz-5250MHz Band <input checked="" type="checkbox"/> Wifi 5G with 5250MHz-5350MHz Band <input checked="" type="checkbox"/> Wifi 5G with 5470MHz-5725MHz Band <input checked="" type="checkbox"/> Wifi 5G with 5725MHz-5850MHz Band
<b>WLAN Supported:</b>	<input checked="" type="checkbox"/> 802.11a <input checked="" type="checkbox"/> 802.11n(20MHz channel bandwidth) <input checked="" type="checkbox"/> 802.11n(40MHz channel bandwidth) <input checked="" type="checkbox"/> 802.11ac(20MHz channel bandwidth) <input checked="" type="checkbox"/> 802.11ac(40MHz channel bandwidth) <input checked="" type="checkbox"/> 802.11ac(80MHz channel bandwidth)
<b>Data Rate :</b>	<input checked="" type="checkbox"/> 802.11a:54/48/36/24/18/12/9/6Mbps <input checked="" type="checkbox"/> 802.11n:up to 300 Mbps <input checked="" type="checkbox"/> 802.11ac:up to 867 Mbps
<b>Modulation:</b>	<input checked="" type="checkbox"/> OFDM with BPSK/QPSK/16QAM/64QAM for 802.11a/n <input checked="" type="checkbox"/> OFDM with BPSK/QPSK/16QAM/64QAM/256QAM for 802.11ac
<b>Frequency Range:</b>	<input checked="" type="checkbox"/> UNII-1: 5150MHz-5250MHz Band
	<input checked="" type="checkbox"/> 5180-5240MHz for 802.11a; <input checked="" type="checkbox"/> 5180-5240MHz for 802.11n(HT20); <input checked="" type="checkbox"/> 5180-5240MHz for 802.11ac(HT20);
	<input checked="" type="checkbox"/> 5190-5230MHz for 802.11n(HT40); <input checked="" type="checkbox"/> 5190-5230MHz for 802.11ac(HT40); <input checked="" type="checkbox"/> 5210MHz for 802.11ac(HT80);
	<input checked="" type="checkbox"/> UNII-2A: 5250MHz-5350MHz Band
	<input checked="" type="checkbox"/> 5260-5320MHz for 802.11a; <input checked="" type="checkbox"/> 5260-5320MHz for 802.11n(HT20); <input checked="" type="checkbox"/> 5260-5320MHz for 802.11ac(HT20);
	<input checked="" type="checkbox"/> 5270-5310MHz for 802.11n(HT40); <input checked="" type="checkbox"/> 5270-5310MHz for 802.11ac(HT40); <input checked="" type="checkbox"/> 5290MHz for 802.11ac(HT80);
	<input checked="" type="checkbox"/> UNII-2C: 5470MHz-5725MHz Band
<input checked="" type="checkbox"/> 5500-5700MHz for 802.11a; <input checked="" type="checkbox"/> 5500-5700MHz for 802.11n(HT20); <input checked="" type="checkbox"/> 5500-5700MHz for 802.11ac(HT20);	
<input checked="" type="checkbox"/> 5510-5670MHz for 802.11n(HT40); <input checked="" type="checkbox"/> 5510-5670MHz for 802.11ac(HT40); <input checked="" type="checkbox"/> 5530MHz for 802.11ac(HT80);	
<input checked="" type="checkbox"/> UNII-3 with 5725MHz-5850MHz Band	
<input checked="" type="checkbox"/> 5745-5825MHz for 802.11a; <input checked="" type="checkbox"/> 5745-5825MHz for 802.11n(HT20); <input checked="" type="checkbox"/> 5745-5825MHz for 802.11ac(HT20);	
<input checked="" type="checkbox"/> 5755-5795MHz for 802.11n(HT40); <input checked="" type="checkbox"/> 5755-5795MHz for 802.11ac(HT40); <input checked="" type="checkbox"/> 5775MHz for 802.11ac(HT80);	
<b>TPC Function:</b>	<input type="checkbox"/> Applicable <input checked="" type="checkbox"/> Not Applicable

<b>Antenna Port:</b>	<input checked="" type="checkbox"/> Antenna port 1 <input checked="" type="checkbox"/> Antenna port 2
<b>Antenna Type:</b>	FPC Antenna
<b>Antenna Gain:</b>	<input checked="" type="checkbox"/> ANT 1: 1.96 dBi <input checked="" type="checkbox"/> ANT 2: 1.94 dBi
<b>Transmit Power:</b>	5150MHz-5250MHz : 18.91 dBm 5250MHz-5350MHz : 18.96 dBm 5470MHz-5725MHz : 17.81 dBm 5725MHz-5850MHz : 16.74 dBm
<b>Power Supply :</b>	DC 11.1V from Battery
<b>Adapter :</b>	Model:AY65AA-W-US Input:100-240V~50/60Hz 1.5A Output:PD3.0:5V=3A,9V=3A,12V=3A,15V=3A,20V=3.25A 65W Max
<b>Date of Received:</b>	Aug 10,2021
<b>Temperature Range:</b>	0°C ~ +40°C

**Note:** For more details, please refer to the User's manual of the EUT.

### 3 SUMMARY OF TEST RESULT

FCC Part Clause	Test Parameter	Verdict	Remark
15.407 (a) 15.407 (e)	99% , 6dB and 26dB Bandwidth	PASS	
15.407 (a)	Maximum Conducted Output Power	PASS	
15.407 (a)	Peak Power Spectral Density	PASS	
15.407 (b)	Radiated Spurious Emission	PASS	
15.407(g)	Frequency Stability	PASS	
15.407 (b)(6) 15.207	Power Line Conducted Emission	PASS	
15.407(a) 15.203	Antenna Application	PASS	
NOTE1: N/A (Not Applicable) NOTE2: According to FCC OET KDB 789033 D2 General UNII Test Procedures New Rules v02r01, In addition, the radiated test is also performed to ensure the emissions emanating from the device cabinet also comply with the applicable limits.			

**RELATED SUBMITTAL(S) / GRANT(S):**

This submittal(s) (test report) is intended for FCC ID: 2AZNP-C015FGE filing to comply with Section 15.247 of the FCC Part 15, Subpart C Rules.

## 4 TEST METHODOLOGY

### 4.1 GENERAL DESCRIPTION OF APPLIED STANDARDS

According to its specifications, the EUT must comply with the requirements of the following standards:

FCC 47 CFR Part 2, Subpart J

FCC 47 CFR Part 15, Subpart E

FCC KDB 662911 D01 Multiple Transmitter Output v02r01

FCC KDB 789033 D2 General UNII Test Procedures New Rules v02r01

### 4.2 MEASUREMENT EQUIPMENT USED

#### Conducted Emission Test Equipment

Equipment	Manufacturer	Model No.	Serial No.	Last Cal.	Cal. Interval
Test Receiver	Rohde & Schwarz	ESCI	101384	May 15, 2021	1 Year
L.I.S.N.	Rohde & Schwarz	ENV216	5	May 15, 2021	1 Year
L.I.S.N.	Kyoritsu	KNW-407	8-1492-9	May 16, 2021	1 Year
Absorbing Clamp	Rohde & Schwarz	MDS-21	833711/025	May 15, 2021	1 Year
Loop antenna	Laplace	RF300	8006	May 15, 2021	1 Year
Van der Hoofden test-head	Schwarzbeck	VDHH 9502	9502-054	May 15, 2021	1 Year
Pulse Limiter	Rohde & Schwarz	ESH3-Z2	100107	May 15, 2021	1 Year

#### For Spurious Emissions Test

Equipment	Manufacturer	Model No.	Serial No.	Last Cal.	Cal. Interval
EMI Test Receiver	Rohde & Schwarz	ESU 26	100154	May 15, 2021	1 Year
Pre-Amplifie	Lunar EM	LNA30M3G-25	J10100000070	May 15, 2021	1 Year
Bilog Antenna	Schwarzbeck	VULB9163	659	Sep 22, 2019	2 Year
Horn antenna	Schwarzbeck	BBHA9120D	9120D-1177	July 4, 2020	2 Year
Pre-Amplifie	SKET	LNPA_0118G-45	SK2019051801	May 15, 2021	1 Year
Loop Antenna	Schwarzbeck	FMZB1519	1519-012	May 15, 2021	2 Year
Spectrum Analyzer	Rohde & Schwarz	FSV40	100967	May 15, 2021	1 Year
Horn antenna	Schwarzbeck	BBHA9120D	9120D-1198	May 15, 2021	2 Year
Bilog Antenna	Schwarzbeck	VULB9163	660	May 15, 2021	2 Year
Cable	H+B	NmSm-05-C15052	N/A	May 15, 2021	1 Year
Cable	H+B	NmSm-2-C15201	N/A	May 15, 2021	1 Year
Cable	H+B	NmNm-7-C15702	N/A	May 15, 2021	1 Year
Cable	H+B	SAC-40G-1	414	May 15, 2021	1 Year
Cable	H+B	SUCOFLEX104	MY14871/4	May 15, 2021	
Cable	H+B	BLU18A-NmSm-6500	D8501	May 15, 2021	1 Year
Band reject Filter(50dB)	WI/DE	WRCGV-2400(2400-2485MHz)	2	May 15, 2021	1 Year



**For other test items:**

Equipment	Manufacturer	Model No.	Serial No.	Last Cal.	Cal. Interval
Vector Signal Generator	Agilent	N5182B	My53050553	May 15, 2021	1 Year
Analog Signal Generator	Agilent	N5171B	My53050878	May 15, 2021	1 Year
Signal Analyzer	Agilent	N9010A	My53470879	May 15, 2021	1 Year
Power Analyzer	Agilent	PS-X10-200	N/A	May 15, 2021	1 Year
Wideband Radio Communication Tester	R&S	CMW500	1201.0002K50-140822zk	May 15, 2021	1 Year
Test Accessories	Agilent	PS-X10-100	N/A	May 15, 2021	1 Year
Temperature&Humidity test chamber	ESPEC	EL-02KA	12107166	May 15, 2021	1 Year
Blocking Box	Agilent	AD211	N/A	May 15, 2021	1 Year

**Remark:** Each piece of equipment is scheduled for calibration once a year.



### 4.3 DESCRIPTION OF TEST MODES

The EUT has been tested under its typical operating condition.

The EUT configuration for testing is installed on RF field strength measurement to meet the Commissions requirement and operating in a manner which intends to maximize its emission characteristics in a continuous normal application.

The Transmitter was operated in the normal operating mode. The TX frequency was fixed which was for the purpose of the measurements.

Test of channel included the lowest and middle and highest frequency to perform the test, then record on this report.

Pre-defined engineering program for regulatory testing used to control the EUT for staying in continuous transmitting and receiving mode is programmed.

Wifi 5G with U-NII - 1

Frequency and Channel list for 802.11a, 802.11n (HT20), 802.11ac (HT20):

Channel	Frequency (MHz)	Channel	Frequency (MHz)	Channel	Frequency (MHz)
36	5180	44	5220		
40	5200	48	5240		

Frequency and Channel list for 802.11n (HT40), 802.11ac (HT40):

Channel	Frequency (MHz)	Channel	Frequency (MHz)	Channel	Frequency (MHz)
38	5190	46	5230		

Frequency and Channel list for 802.11ac (HT80):

Channel	Frequency (MHz)	Channel	Frequency (MHz)	Channel	Frequency (MHz)
42	5210				

Test Frequency and Channel for 802.11a, 802.11n (HT20), 802.11ac (HT20):

Lowest Frequency		Middle Frequency		Highest Frequency	
Channel	Frequency (MHz)	Channel	Frequency (MHz)	Channel	Frequency (MHz)
36	5180	40	5200	48	5240

Test Frequency and channel for 802.11n (HT40), 802.11ac (HT40):

Lowest Frequency		Middle Frequency		Highest Frequency	
Channel	Frequency (MHz)	Channel	Frequency (MHz)	Channel	Frequency (MHz)
38	5190	N/A	N/A	46	5230

Test Frequency and channel for 802.11ac (HT80):

Lowest Frequency		Middle Frequency		Highest Frequency	
Channel	Frequency (MHz)	Channel	Frequency (MHz)	Channel	Frequency (MHz)
42	5210	N/A	N/A	N/A	N/A

Wifi 5G with U-NII -2A

Frequency and Channel list 802.11a, 802.11n (HT20), 802.11ac (HT20):

Channel	Frequency (MHz)	Channel	Frequency (MHz)	Channel	Frequency (MHz)
52	5260	60	5300		
56	5280	64	5320		

Frequency and Channel list for 802.11n (HT40), 802.11ac (HT40):

Channel	Frequency (MHz)	Channel	Frequency (MHz)	Channel	Frequency (MHz)
54	5270				
62	5310				

Frequency and Channel list for 802.11ac (HT80):

Channel	Frequency (MHz)	Channel	Frequency (MHz)	Channel	Frequency (MHz)
58	5290				

Test Frequency and Channel for 802.11a, 802.11n (HT20), 802.11ac (HT20):

Lowest Frequency		Middle Frequency		Highest Frequency	
Channel	Frequency (MHz)	Channel	Frequency (MHz)	Channel	Frequency (MHz)
52	5260	56	5280	64	5320

Test Frequency and channel for 802.11n (HT40), 802.11ac (HT40):

Lowest Frequency		Middle Frequency		Highest Frequency	
Channel	Frequency (MHz)	Channel	Frequency (MHz)	Channel	Frequency (MHz)
54	5270	N/A	N/A	62	5310

Test Frequency and channel for 802.11ac (HT80):

Lowest Frequency		Middle Frequency		Highest Frequency	
Channel	Frequency (MHz)	Channel	Frequency (MHz)	Channel	Frequency (MHz)
58	5290				

Wifi 5G with U-NII -2C

Frequency and Channel list for 802.11a, 802.11n (HT20), 802.11ac (HT20):

Channel	Frequency (MHz)	Channel	Frequency (MHz)	Channel	Frequency (MHz)
100	5500	116	5580	132	5660
104	5520	120	5600	136	5680
108	5540	124	5620	140	5700
112	5560	128	5640		

Frequency and Channel list for 802.11n (HT40), 802.11ac (HT40):

Channel	Frequency (MHz)	Channel	Frequency (MHz)	Channel	Frequency (MHz)
102	5510	118	5590	134	5670
110	5550	126	5630		

Frequency and Channel list for 802.11ac (HT80):

Channel	Frequency (MHz)	Channel	Frequency (MHz)	Channel	Frequency (MHz)
106	5530	122	5610		

Test Frequency and Channel for 802.11a, 802.11n (HT20), 802.11ac (HT20):

Lowest Frequency		Middle Frequency		Highest Frequency	
Channel	Frequency (MHz)	Channel	Frequency (MHz)	Channel	Frequency (MHz)
100	5500	120	5600	140	5700

Test Frequency and channel for 802.11n (HT40), 802.11ac (HT40):

Lowest Frequency		Middle Frequency		Highest Frequency	
Channel	Frequency (MHz)	Channel	Frequency (MHz)	Channel	Frequency (MHz)
102	5510			134	5670

Test Frequency and channel for 802.11ac (HT80):

Lowest Frequency		Middle Frequency		Highest Frequency	
Channel	Frequency (MHz)	Channel	Frequency (MHz)	Channel	Frequency (MHz)
106	5530				

Wifi 5G with U-NII -3

Frequency and Channel list for 802.11a, 802.11n (HT20), 802.11ac (HT20):

Channel	Frequency (MHz)	Channel	Frequency (MHz)	Channel	Frequency (MHz)
149	5745	157	5785	165	5825
153	5765	161	5805		

Frequency and Channel list for 802.11n (HT40), 802.11ac (HT40):

Channel	Frequency (MHz)	Channel	Frequency (MHz)	Channel	Frequency (MHz)
151	5755	159	5795		

Frequency and Channel list for 802.11ac (HT80):

Channel	Frequency (MHz)	Channel	Frequency (MHz)	Channel	Frequency (MHz)
155	5775				

Test Frequency and Channel for 802.11a, 802.11n (HT20), 802.11ac (HT20):

Lowest Frequency		Middle Frequency		Highest Frequency	
Channel	Frequency (MHz)	Channel	Frequency (MHz)	Channel	Frequency (MHz)
149	5745	157	5785	165	5825

Test Frequency and channel for 802.11n (HT40), 802.11ac (HT40):

Lowest Frequency		Middle Frequency		Highest Frequency	
Channel	Frequency (MHz)	Channel	Frequency (MHz)	Channel	Frequency (MHz)
151	5755	N/A	N/A	159	5795

Test Frequency and channel for 802.11ac (HT80):

Lowest Frequency		Middle Frequency		Highest Frequency	
Channel	Frequency (MHz)	Channel	Frequency (MHz)	Channel	Frequency (MHz)
155	5775				

The 5G WIFI has two antennas and support Multiple Outputs for 802.11n/ac mode for this report; Antenna 1 Gain is 1.96dBi; Antenna 2 Gain is 1.94dBi; for this function is belong to Correlated Categorization equipment

According to KDB 662911, for Unequal antenna gains,

$$\text{Directional gain} = 10 \log [(10^{1.96/20} + 10^{1.94/20})^2/2] \text{ dBi} = 4.96 \text{ dBi}$$

## 5 FACILITIES AND ACCREDITATIONS

### 5.1 FACILITIES

All measurement facilities used to collect the measurement data are located at:

EMTEK (Shenzhen) Co., Ltd.

Building 69, Majialong Industry Zone District, Nanshan District, Shenzhen, China

The sites are constructed in conformance with the requirements of ANSI C63.7, ANSI C63.4 and CISPR Publication 22.

### 5.2 EQUIPMENT

Radiated emissions are measured with one or more of the following types of linearly polarized antennas: tuned dipole, biconical, log periodic, bi-log, and/or ridged waveguide, horn. Spectrum analyzers with preselectors and quasi-peak detectors are used to perform radiated measurements.

Conducted emissions are measured with Line Impedance Stabilization Networks and EMI Test Receivers.

Calibrated wideband preamplifiers, coaxial cables, and coaxial attenuators are also used for making measurements.

All receiving equipment conforms to CISPR Publication 16-1, "Radio Interference Measuring Apparatus and Measurement Methods."

### 5.3 LABORATORY ACCREDITATIONS AND LISTINGS

Site Description	
EMC Lab.	<p><b>Accredited by CNAS</b> The Certificate Registration Number is L2291. The Laboratory has been assessed and proved to be in compliance with CNAS-CL01 (identical to ISO/IEC 17025:2017)</p> <p><b>Accredited by FCC</b> Designation Number: CN1204 Test Firm Registration Number: 882943</p> <p><b>Accredited by A2LA</b> The Certificate Number is 4321.01.</p> <p>Accredited by Industry Canada The Conformity Assessment Body Identifier is CN0008</p>
Name of Firm	: EMTEK (SHENZHEN) CO., LTD.
Site Location	: Building 69, Majialong Industry Zone, Nanshan District, Shenzhen, Guangdong, China

## 6 TEST SYSTEM UNCERTAINTY

The following measurement uncertainty levels have been estimated for tests performed on the apparatus:

Parameter	Uncertainty
Radio Frequency	$\pm 1 \times 10^{-5}$
Maximum Peak Output Power Test	$\pm 1.0\text{dB}$
Conducted Emissions Test	$\pm 2.0\text{dB}$
Radiated Emission Test	$\pm 2.0\text{dB}$
Power Density	$\pm 2.0\text{dB}$
Occupied Bandwidth Test	$\pm 1.0\text{dB}$
Band Edge Test	$\pm 3\text{dB}$
All emission, radiated	$\pm 3\text{dB}$
Antenna Port Emission	$\pm 3\text{dB}$
Temperature	$\pm 0.5^\circ\text{C}$
Humidity	$\pm 3\%$

Measurement Uncertainty for a level of Confidence of 95%

## 7 SETUP OF EQUIPMENT UNDER TEST

### 7.1 RADIO FREQUENCY TEST SETUP

The WLAN component's antenna ports(s) of the EUT are connected to the measurement instrument per an appropriate attenuator. The EUT is controlled by PC/software to emit the specified signals for the purpose of measurements.

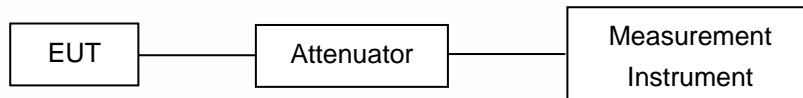

### 7.2 RADIO FREQUENCY TEST SETUP

The test site semi-anechoic chamber has met the requirement of NSA tolerance 4 dB according to the standards: ANSI C63.10. The test distance is 3m. The setup is according to the requirements in Section 13.1.4.1 of ANSI C63.10-2013 and CAN/CSA-CEI/IEC CISPR 22.

Below 30MHz:

The EUT is placed on a turntable 0.8 meters above the ground in the chamber, 3 meter away from the antenna (loop antenna). The Antenna should be positioned with its plane vertical at the specified distance from the EUT and rotated about its vertical axis for maximum response at each azimuth about the EUT. The center of the loop shall be 1 m above the ground. For certain applications, the loop antenna plane may also need to be positioned horizontally at the specified distance from the EUT.

Above 30MHz:

The EUT is placed on a turntable 0.8 meters above the ground in the chamber, 3 meter away from the antenna. The maximal emission value is acquired by adjusting the antenna height, polarisation and turntable azimuth. Normally, the height range of antenna is 1 m to 4 m, the azimuth range of turntable is 0° to 360°, and the receive antenna has two polarizations Vertical (V) and Horizontal (H).

Above 1GHz:

(Note: the FCC's permission to use 1.5m as an alternative per TCBC Conf call of Dec. 2, 2014.)

The EUT is placed on a turntable 1.5 meters above the ground in the chamber, 3 meter away from the antenna. The maximal emission value is acquired by adjusting the antenna height, polarisation and turntable azimuth. Normally, the height range of antenna is 1 m to 4 m, the azimuth range of turntable is 0° to 360°, and the receive antenna has two polarizations Vertical (V) and Horizontal (H).

(a) Radiated Emission Test Set-Up, Frequency Below 30MHz

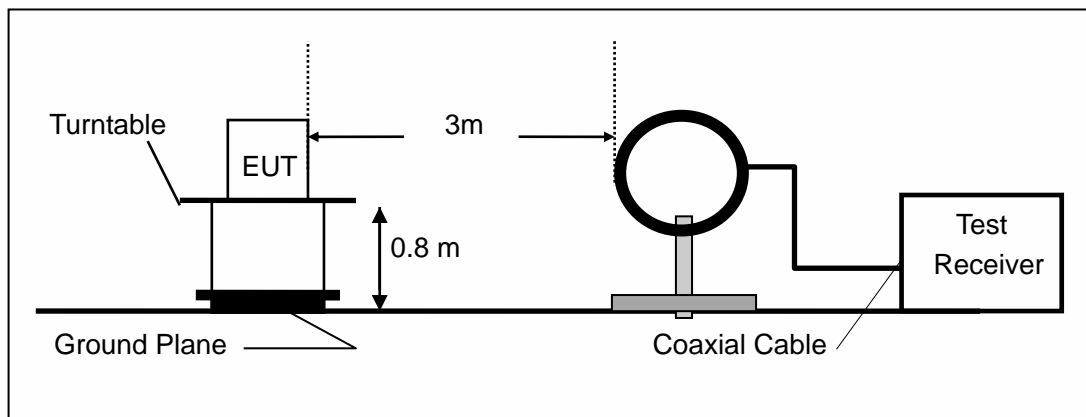



(b) Radiated Emission Test Set-Up, Frequency Below 1000MHz

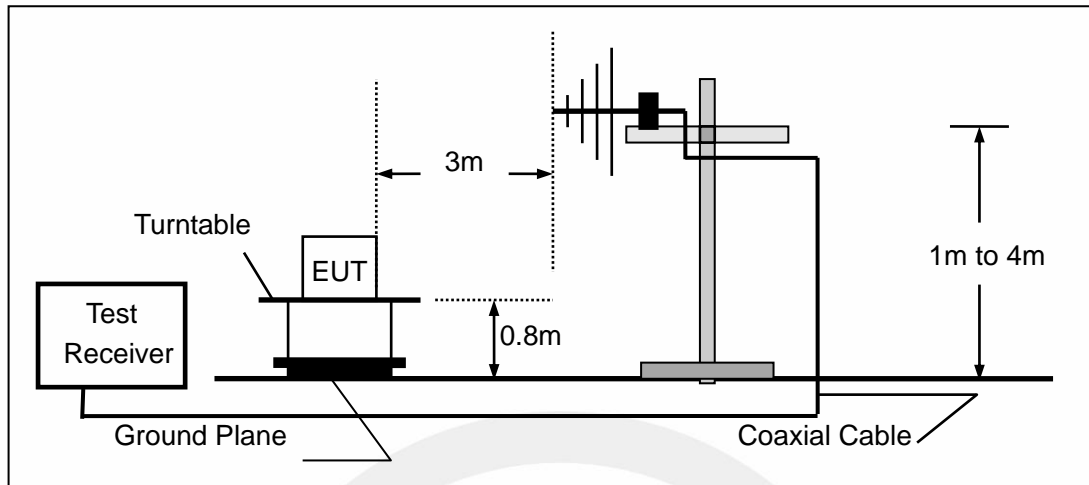

(c) Radiated Emission Test Set-Up, Frequency above 1000MHz

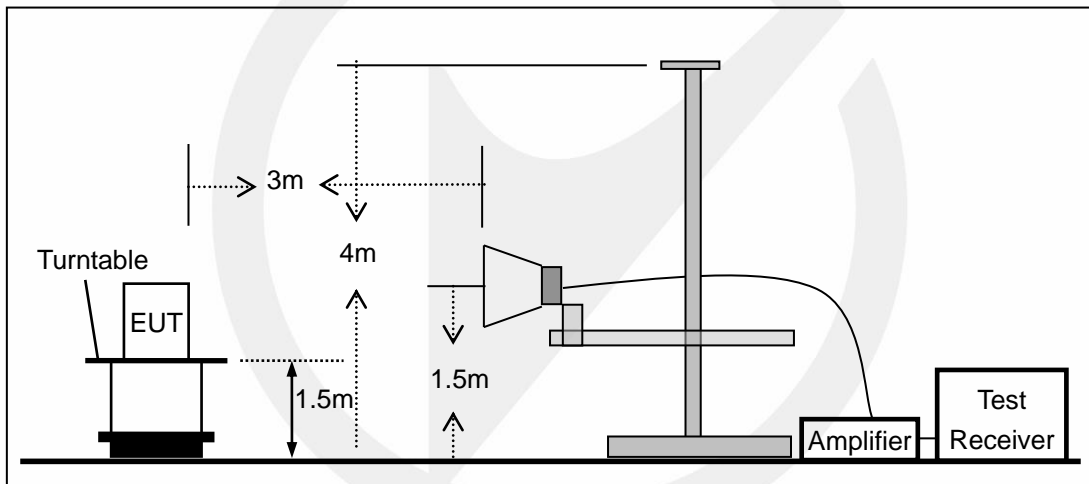

### 7.3 CONDUCTED EMISSION TEST SETUP

The mains cable of the EUT (maybe per AC/DC Adapter) must be connected to LISN. The LISN shall be placed 0.8 m from the boundary of EUT and bonded to a ground reference plane for LISN mounted on top of the ground reference plane. This distance is between the closest points of the LISN and the EUT. All other units of the EUT and associated equipment shall be at least 0.8m from the LISN.

Ground connections, where required for safety purposes, shall be connected to the reference ground point of the LISN and, where not otherwise provided or specified by the manufacturer, shall be of same length as the mains cable and run parallel to the mains connection at a separation distance of not more than 0.1 m.

According to the requirements in Section 13.1.4.1 of ANSI C63.10-2013 Conducted emissions from the EUT measured in the frequency range between 0.15 MHz and 30 MHz using CISPR Quasi-Peak and average detector mode.

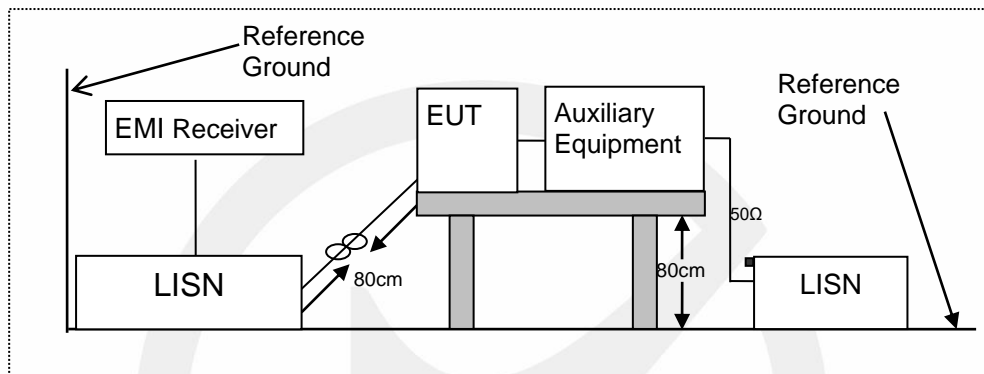

### 7.4 BLOCK DIAGRAM CONFIGURATION OF TEST SYSTEM

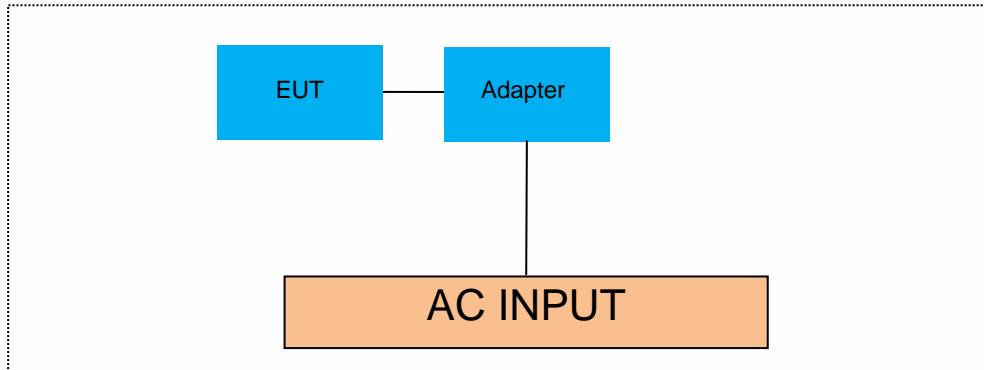

### 7.5 SUPPORT EQUIPMENT

EUT Cable List and Details			
Cable Description	Length (m)	Shielded/Unshielded	With / Without Ferrite
/	/	/	/

Auxiliary Cable List and Details			
Cable Description	Length (m)	Shielded/Unshielded	With / Without Ferrite
/	/	/	/

Auxiliary Equipment List and Details			
Description	Manufacturer	Model	Serial Number
Notebook	acer	ZR1	LXTECOCO76643158 372500

**Notes:**

- 1.All the equipment/cables were placed in the worst-case configuration to maximize the emission during the test.
- 2.Grounding was established in accordance with the manufacturer’s requirements and conditions for the intended use.

## 8 TEST REQUIREMENTS

### 8.1 BANDWIDTH MEASUREMENT

#### 8.1.1 Applicable Standard

According to FCC Part 15.407(a)(1) for UNII Band I  
According to FCC Part 15.407(a)(2) for UNII Band II-A and UNII Band II-C  
According to FCC Part 15.407(a)(3) for UNII Band III  
According to FCC Part 15.407(e) for UNII Band III  
According to 789033 D02 Section II(C)  
According to 789033 D02 Section II(D)

#### 8.1.2 Conformance Limit

(1) For the band 5.15-5.25 GHz.

(iv) For mobile and portable client devices in the 5.15-5.25 GHz band, the maximum conducted output power over the frequency band of operation shall not exceed 250 mW provided the maximum antenna gain does not exceed 6 dBi. In addition, the maximum power spectral density shall not exceed 11 dBm in any 1 megahertz band. If transmitting antennas of directional gain greater than 6 dBi are used, both the maximum conducted output power and the maximum power spectral density shall be reduced by the amount in dB that the directional gain of the antenna exceeds 6 dBi.

(2) For the 5.25-5.35 GHz and 5.47-5.725 GHz bands, the maximum conducted output power over the frequency bands of operation shall not exceed the lesser of 250 mW or 11 dBm + 10 log B, where B is the 26 dB emission bandwidth in megahertz. In addition, the maximum power spectral density shall not exceed 11 dBm in any 1 megahertz band. If transmitting antennas of directional gain greater than 6 dBi are used, both the maximum conducted output power and the maximum power spectral density shall be reduced by the amount in dB that the directional gain of the antenna exceeds 6 dBi.

(3) For the band 5.725-5.85 GHz, the maximum conducted output power over the frequency band of operation shall not exceed 1 W. In addition, the maximum power spectral density shall not exceed 30 dBm in any 500-kHz band. If transmitting antennas of directional gain greater than 6 dBi are used, both the maximum conducted output power and the maximum power spectral density shall be reduced by the amount in dB that the directional gain of the antenna exceeds 6 dBi. However, fixed point-to-point U-NII devices operating in this band may employ transmitting antennas with directional gain greater than 6 dBi without any corresponding reduction in transmitter conducted power. Fixed, point-to-point operations exclude the use of point-to-multipoint systems, omnidirectional applications, and multiple collocated transmitters transmitting the same information. The operator of the U-NII device, or if the equipment is professionally installed, the installer, is responsible for ensuring that systems employing high gain directional antennas are used exclusively for fixed, point-to-point operations.

(e) Within the 5.725-5.85 GHz band, the minimum 6 dB bandwidth of U-NII devices shall be at least 500 kHz.

#### 8.1.3 Test Configuration

Test according to clause 7.1 radio frequency test setup

#### 8.1.4 Test Procedure

According to 789033 D02 v02r01 section C&D, the following is the measurement procedure.

##### 1. Emission Bandwidth (EBW)

- a) Set RBW = approximately 1% of the emission bandwidth.
- b) Set the VBW > RBW.
- c) Detector = Peak.
- d) Trace mode = max hold.
- e) Measure the maximum width of the emission that is 26 dB down from the maximum of the emission.

Compare this with the RBW setting of the analyzer. Readjust RBW and repeat measurement as needed until the RBW/EBW ratio is approximately 1%.

## 2. Minimum Emission Bandwidth for the band 5.725-5.85 GHz

Section 15.407(e) specifies the minimum 6 dB emission bandwidth of at least 500 KHz for the band 5.715-5.85 GHz. The following procedure shall be used for measuring this bandwidth:

- a) Set RBW = 100 kHz.
- b) Set the video bandwidth (VBW)  $\geq 3 \times$  RBW.
- c) Detector = Peak.
- d) Trace mode = max hold.
- e) Sweep = auto couple.
- f) Allow the trace to stabilize.
- g) Measure the maximum width of the emission that is constrained by the frequencies associated with the two outermost amplitude points (upper and lower frequencies) that are attenuated by 6 dB relative to the maximum level measured in the fundamental emission.

Note: The automatic bandwidth measurement capability of a spectrum analyzer or EMI receiver may be employed if it implements the functionality described above.

## D. 99 Percent Occupied Bandwidth

The 99-percent occupied bandwidth is the frequency bandwidth such that, below its lower and above its upper frequency limits, the mean powers are each equal to 0.5 % of the total mean power of the given emission. Measurement of the 99-percent occupied bandwidth is required only as a condition for using the optional band-edge measurement techniques described in section II.G.3.d). Measurements of 99-percent occupied bandwidth may also optionally be used in lieu of the EBW to 789033 D02 v01r02 General UNII Test Procedures New Rules v01 define the minimum frequency range over which the spectrum is integrated when measuring maximum conducted output power as described in section II.E. However, the EBW must be measured to determine bandwidth dependent limits on maximum conducted output power in accordance with 15.407(a).

The following procedure shall be used for measuring (99 %) power bandwidth:

1. Set center frequency to the nominal EUT channel center frequency.
2. Set span = 1.5 times to 5.0 times the OBW.
3. Set RBW = 1 % to 5 % of the OBW
4. Set VBW  $\geq 3 \cdot$  RBW
5. Video averaging is not permitted. Where practical, a sample detection and single sweep mode shall be used. Otherwise, peak detection and max hold mode (until the trace stabilizes) shall be used.
6. Use the 99 % power bandwidth function of the instrument (if available).
7. If the instrument does not have a 99 % power bandwidth function, the trace data points are recovered and directly summed in power units. The recovered amplitude data points, beginning at the lowest frequency, are placed in a running sum until 0.5 % of the total is reached; that frequency is recorded as the lower frequency. The process is repeated until 99.5 % of the total is reached; that frequency is recorded as the upper frequency. The 99% occupied bandwidth is the difference between these two frequencies.

8.1.5 Test Results

5150-5250MHz

Test Mode	Test Channel MHz		26 dB Bandwidth MHz	99% Bandwidth MHz	Verdict
802.11a	CH36	5180	20.09	16.586	Pass
	CH40	5200	20.00	16.644	Pass
	CH48	5240	20.31	16.661	Pass
802.11n-HT20	CH36	5180	20.27	17.630	Pass
	CH40	5200	20.41	17.680	Pass
	CH48	5240	20.26	17.631	Pass
802.11ac(HT20)	CH36	5180	20.32	17.709	Pass
	CH40	5200	20.25	17.689	Pass
	CH48	5240	20.19	17.633	Pass
802.11n-HT40	CH38	5190	40.84	36.129	Pass
	CH46	5230	40.71	36.094	Pass
802.11ac(HT40)	CH38	5190	40.10	36.026	Pass
	CH46	5230	40.98	36.056	Pass
802.11ac(HT80)	CH42	5210	80.91	75.565	Pass

99% & -26 dB Emission Bandwidth  
Test Model 802.11a

U-NII - 1  
Frequency(MHz)

5180



99% & -26 dB Emission Bandwidth  
Test Model 802.11a

U-NII - 1  
Frequency(MHz)

5200

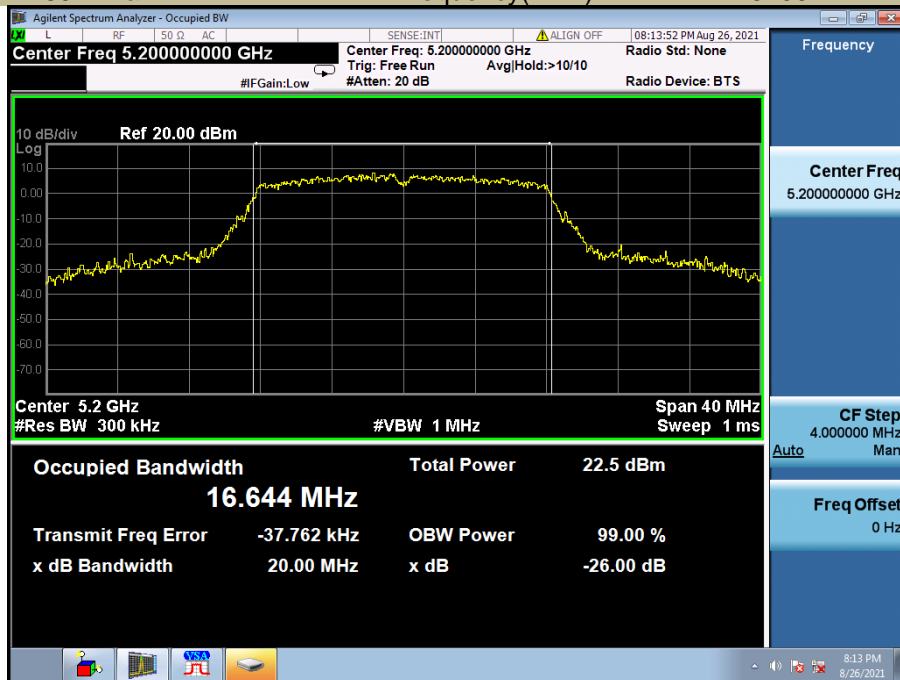

99% & -26 dB Emission Bandwidth  
Test Model 802.11a

U-NII - 1  
Frequency(MHz)

5240

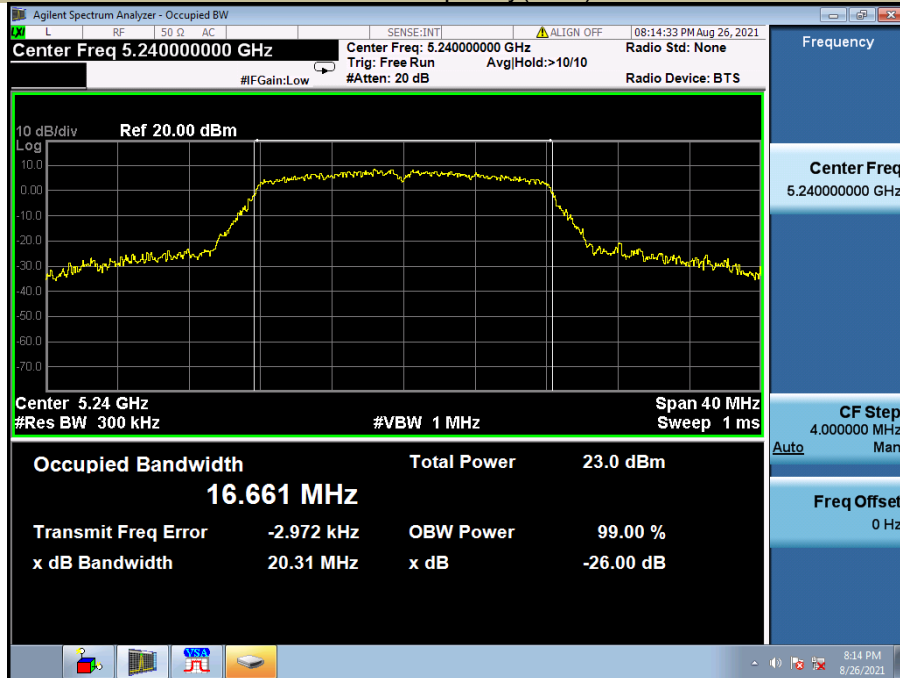

99% & -26 dB Emission Bandwidth  
Test Model 802.11n-HT20

U-NII - 1  
Frequency(MHz)

5180





99% & -26 dB Emission Bandwidth  
Test Model 802.11n-HT20

U-NII - 1  
Frequency(MHz)

5200

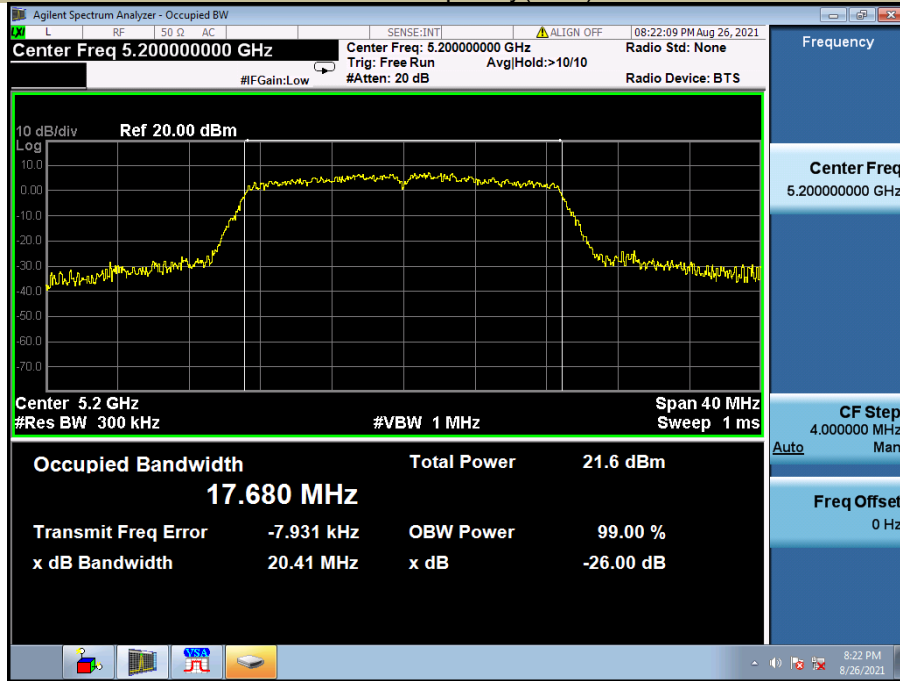

99% & -26 dB Emission Bandwidth  
Test Model 802.11n-HT20

U-NII - 1  
Frequency(MHz)

5240

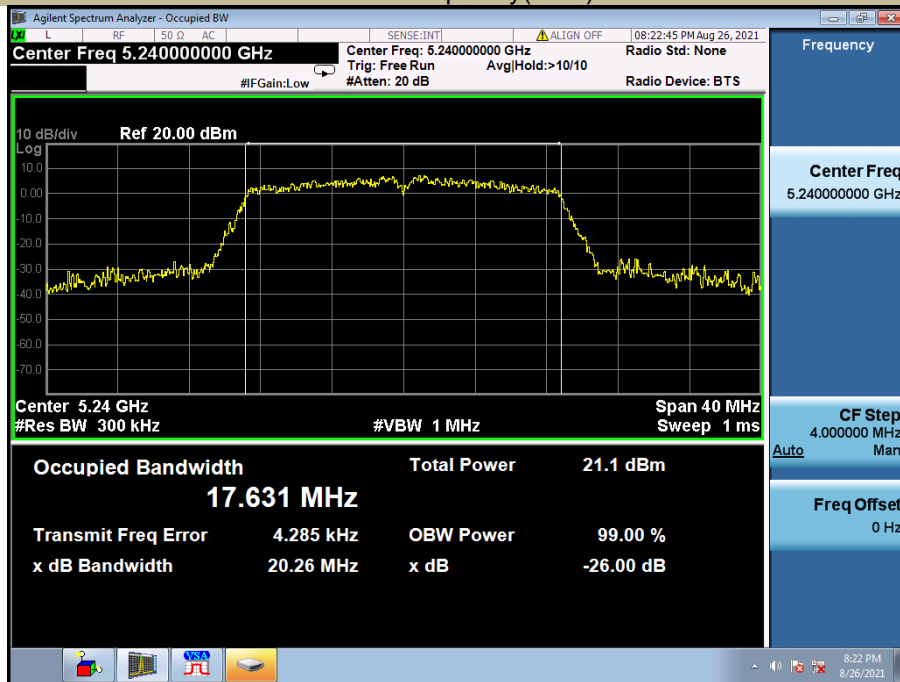

99% & -26 dB Emission Bandwidth  
Test Model 802.11ac(HT20)

U-NII - 1  
Frequency(MHz)

5180

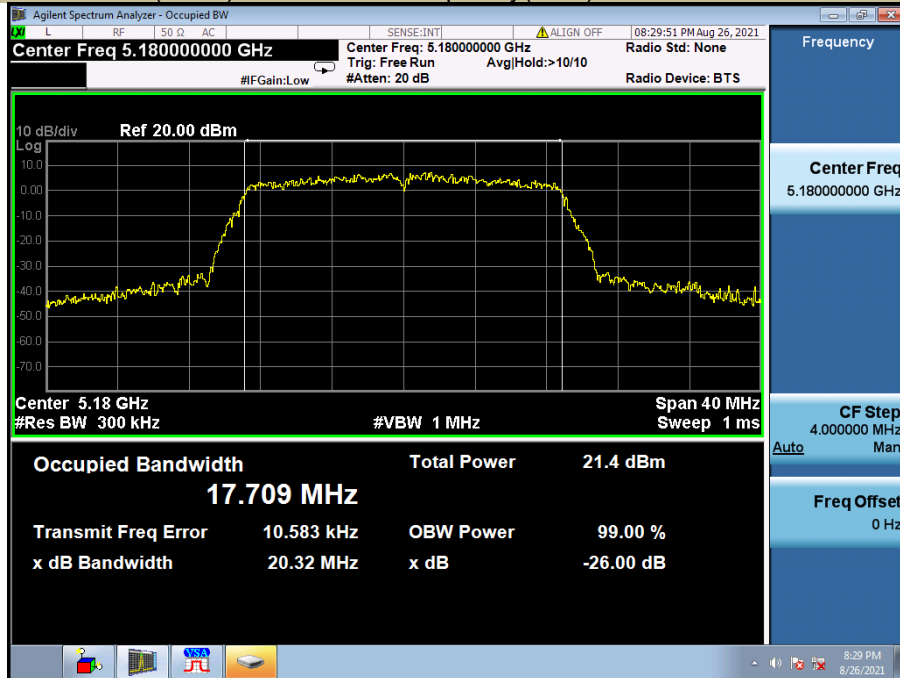

99% & -26 dB Emission Bandwidth  
Test Model 802.11ac(HT20)

U-NII - 1  
Frequency(MHz)

5200

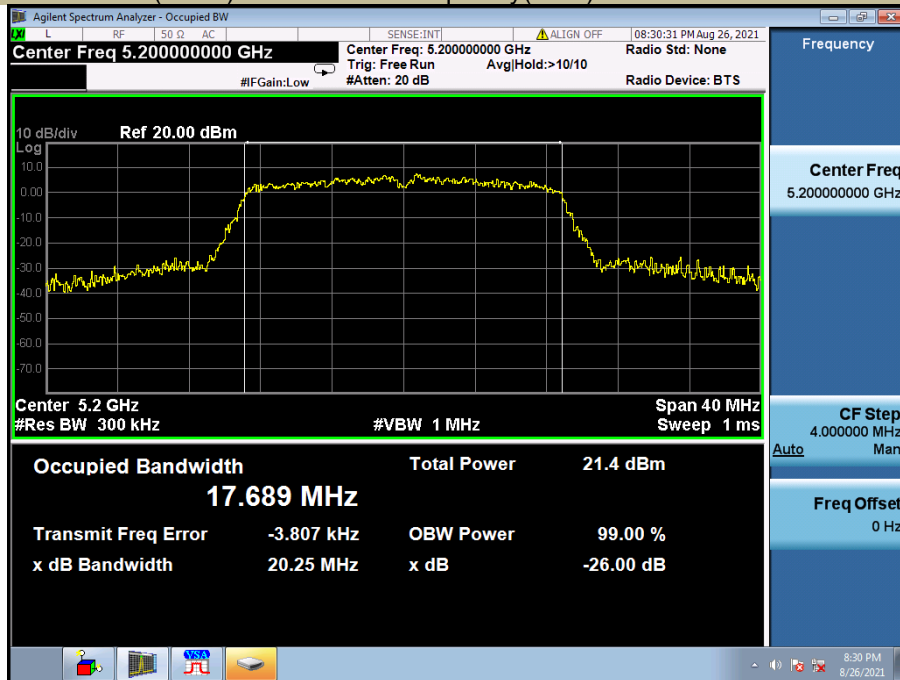

99% & -26 dB Emission Bandwidth  
Test Model 802.11ac(HT20)

U-NII - 1  
Frequency(MHz)

5240

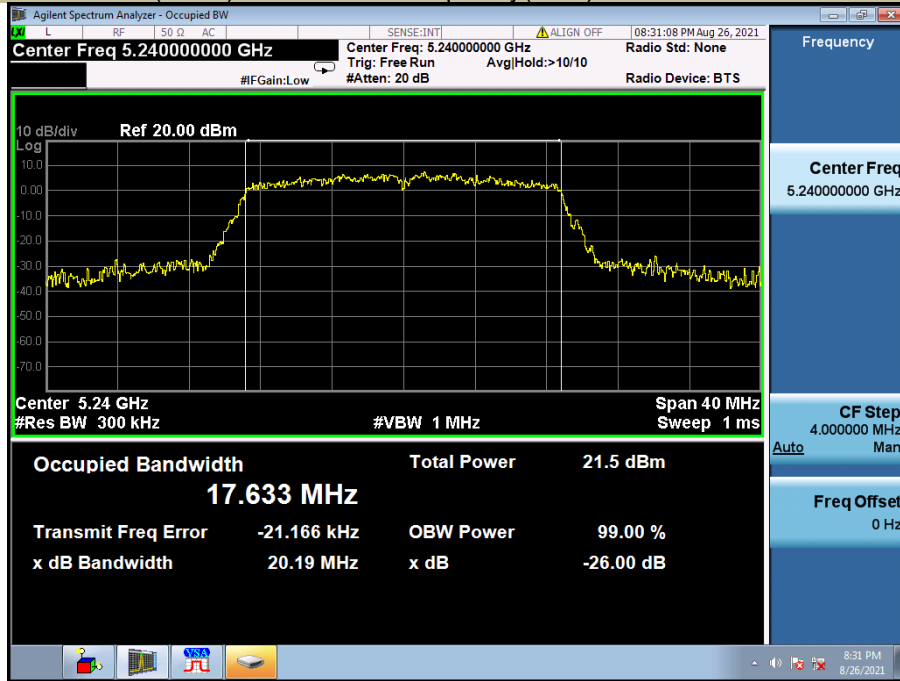

99% & -26 dB Emission Bandwidth  
Test Model 802.11n-HT40

U-NII - 1  
Frequency(MHz)

5190

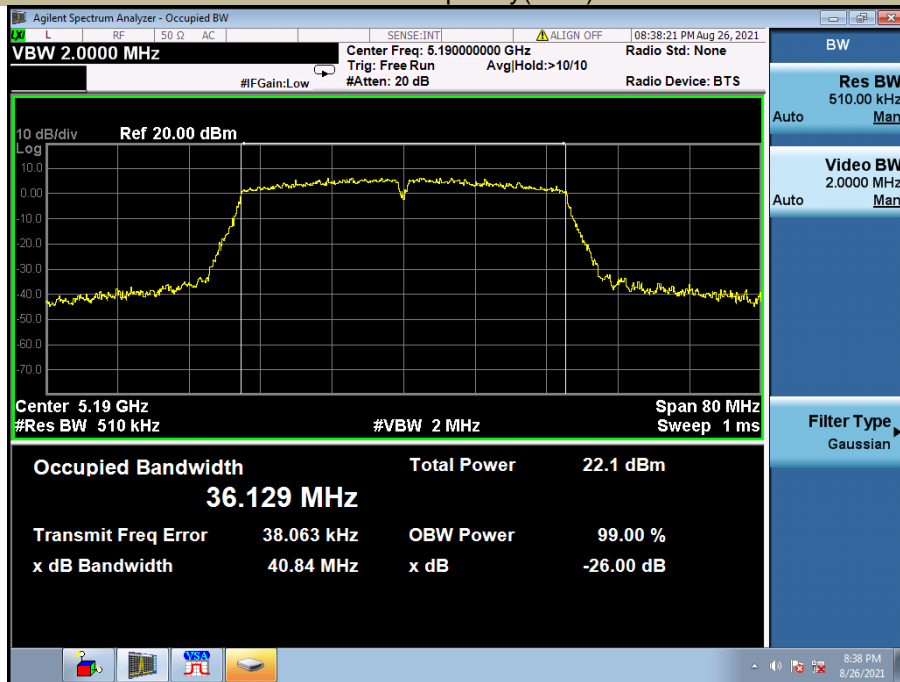

99% & -26 dB Emission Bandwidth  
Test Model 802.11n-HT40

U-NII - 1  
Frequency(MHz) 5230



99% & -26 dB Emission Bandwidth  
Test Model 802.11ac(HT40)

U-NII - 1  
Frequency(MHz) 5190



99% & -26 dB Emission Bandwidth  
Test Model 802.11ac(HT40)

U-NII - 1  
Frequency(MHz)

5230

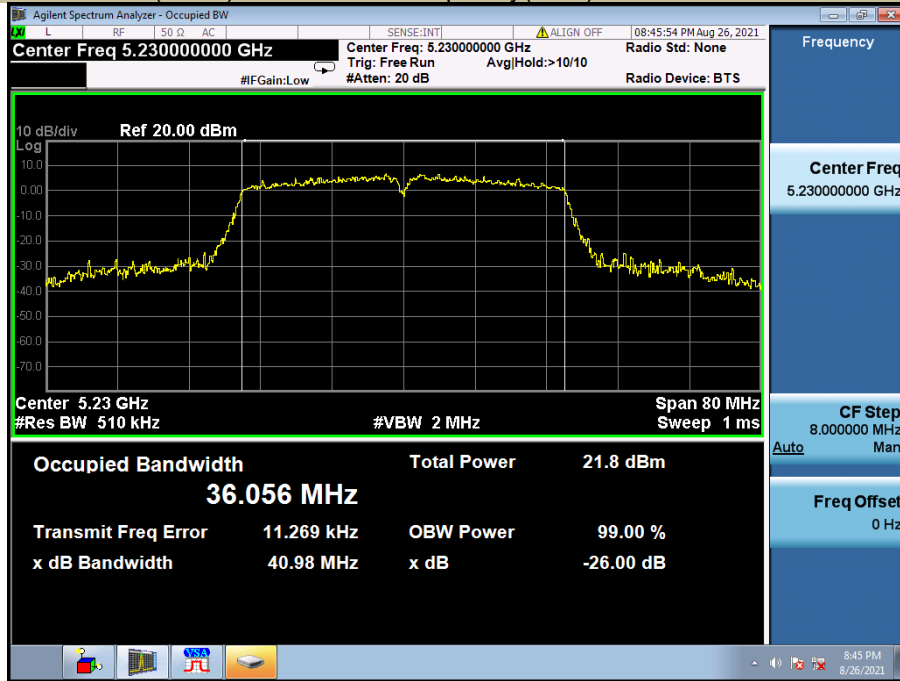

99% & -26 dB Emission Bandwidth  
Test Model 802.11ac 80

U-NII - 1  
Frequency(MHz)

5210

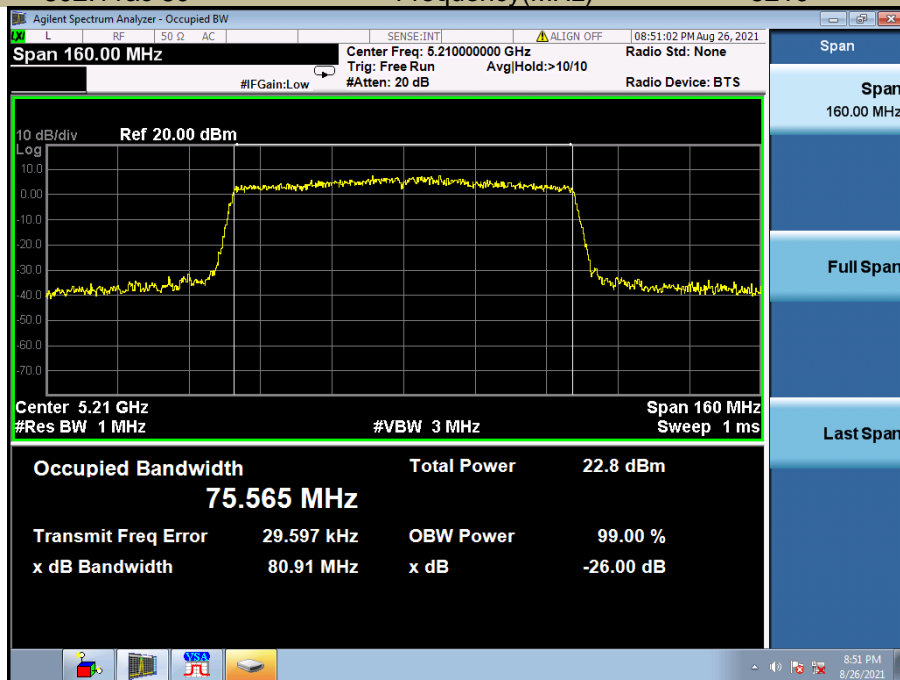

5250-5350MHz

Test Mode	Test Channel MHz		26 dB Bandwidth MHz	99% Bandwidth MHz	Verdict
802.11a	CH52	5260	19.95	16.726	Pass
	CH56	5280	20.45	16.754	Pass
	CH64	5320	20.01	16.651	Pass
802.11n-HT20	CH52	5260	20.43	17.675	Pass
	CH56	5280	20.40	17.708	Pass
	CH64	5320	20.35	17.661	Pass
802.11ac(HT20)	CH52	5260	20.42	17.690	Pass
	CH56	5280	20.42	17.725	Pass
	CH64	5320	20.38	17.667	Pass
802.11n-HT40	CH54	5270	40.57	36.123	Pass
	CH62	5310	40.45	36.076	Pass
802.11ac(HT40)	CH54	5270	40.70	36.080	Pass
	CH62	5310	40.23	36.006	Pass
802.11ac(HT80)	CH58	5290	81.45	75.487	Pass

99% & -26 dB Emission Bandwidth  
Test Model 802.11a

U-NII – 2A  
Frequency(MHz)

5260

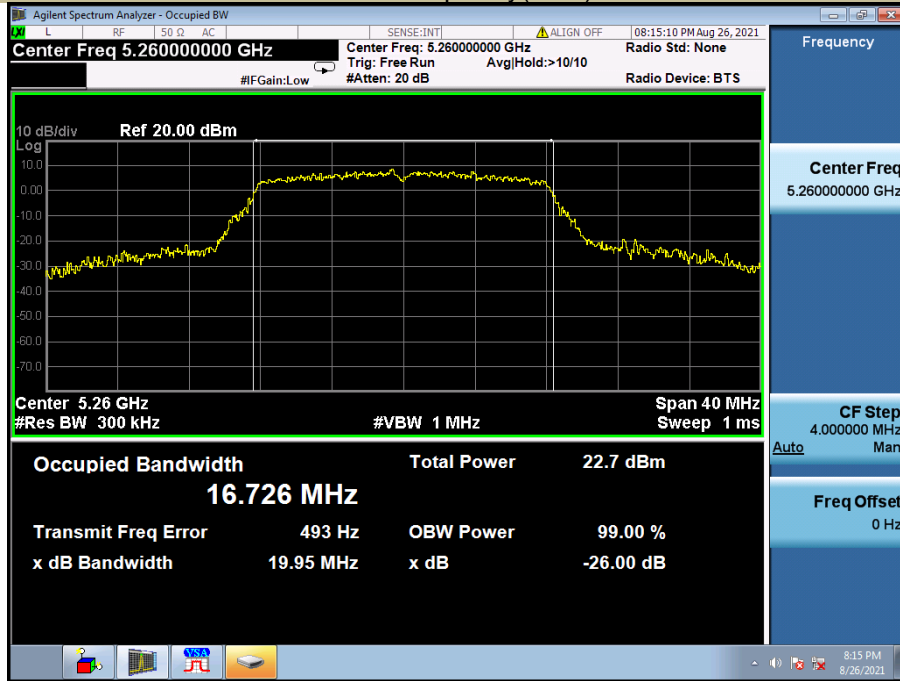

99% & -26 dB Emission Bandwidth  
Test Model 802.11a

U-NII – 2A  
Frequency(MHz)

5280



99% & -26 dB Emission Bandwidth  
Test Model 802.11a

U-NII – 2A  
Frequency(MHz) 5320



99% & -26 dB Emission Bandwidth  
Test Model 802.11n-HT20

U-NII – 2A  
Frequency(MHz) 5260

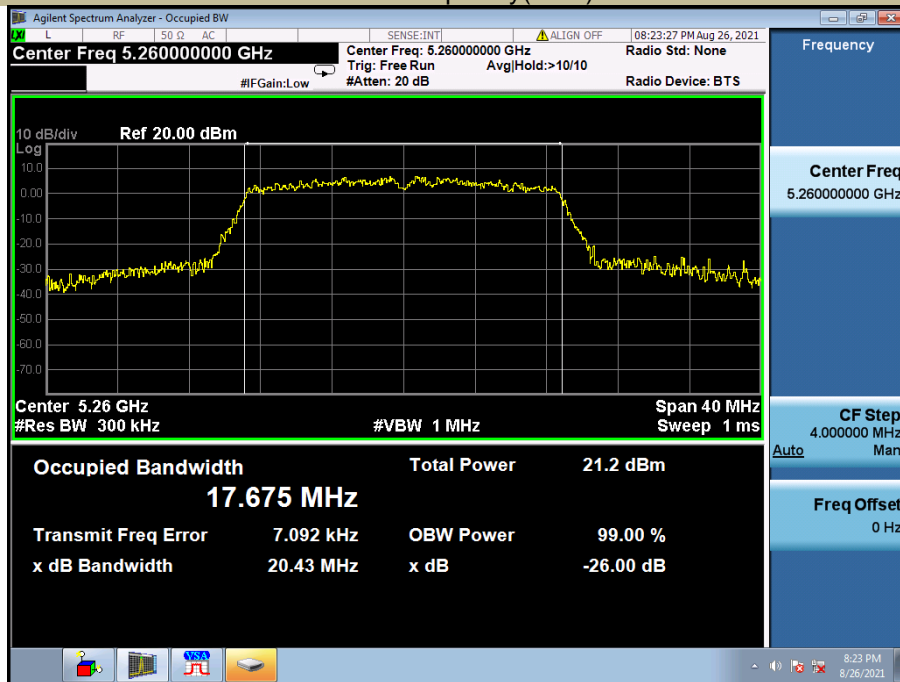



99% & -26 dB Emission Bandwidth  
Test Model 802.11n-HT20

U-NII – 2A  
Frequency(MHz) 5280

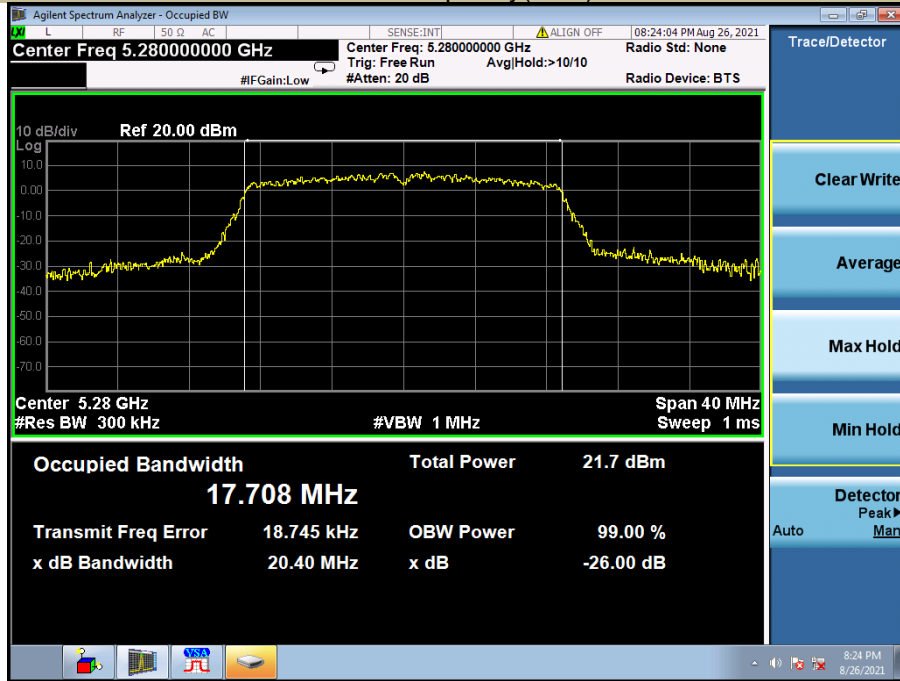

99% & -26 dB Emission Bandwidth  
Test Model 802.11n-HT20

U-NII – 2A  
Frequency(MHz) 5320

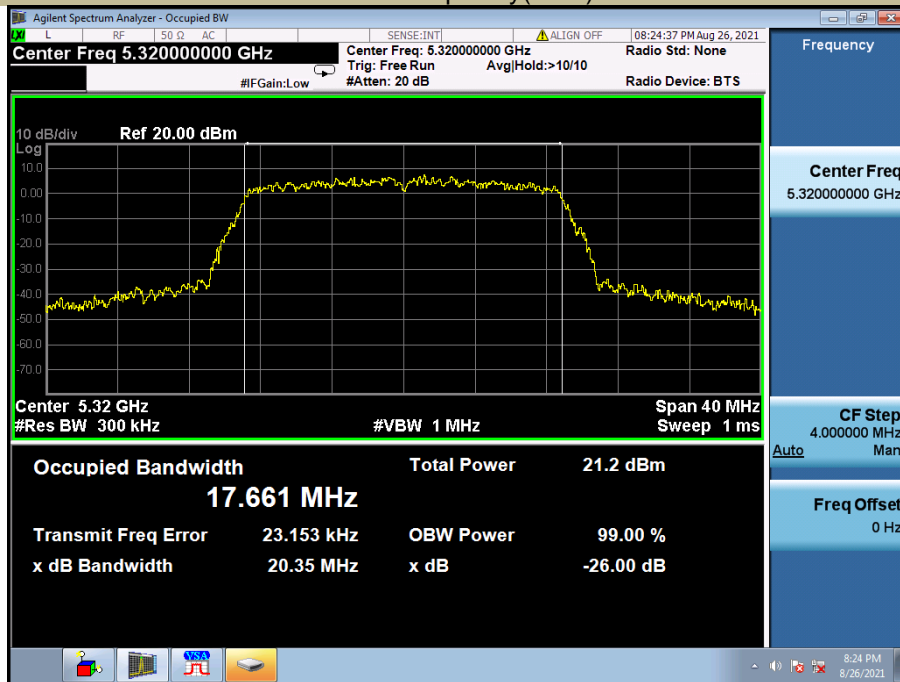

99% & -26 dB Emission Bandwidth  
Test Model 802.11ac(HT20)

U-NII – 2A  
Frequency(MHz) 5260

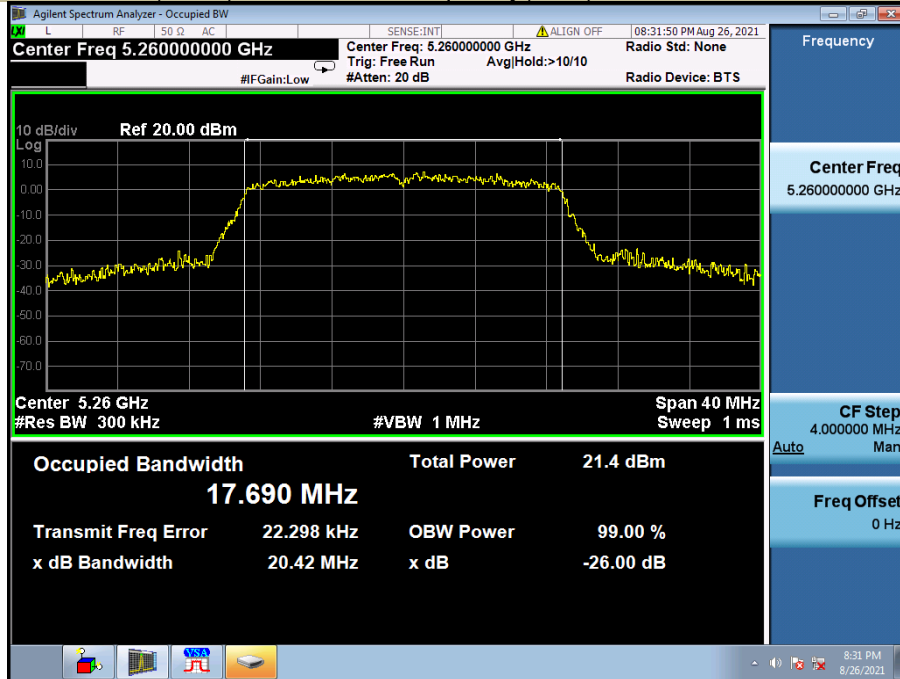

99% & -26 dB Emission Bandwidth  
Test Model 802.11ac(HT20)

U-NII – 2A  
Frequency(MHz) 5280

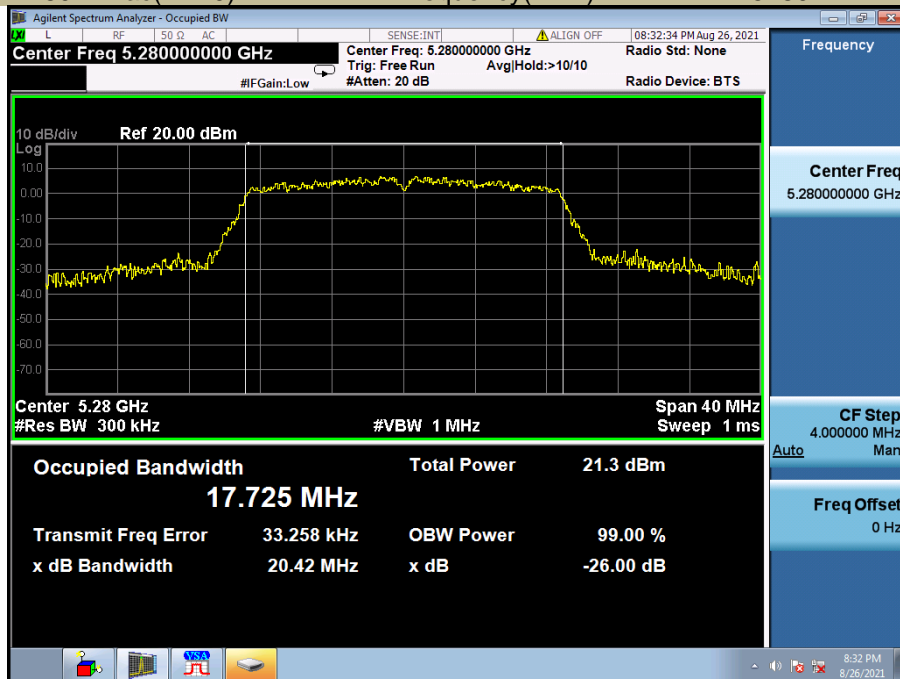

99% & -26 dB Emission Bandwidth  
Test Model 802.11ac(HT20)

U-NII – 2A  
Frequency(MHz) 5320

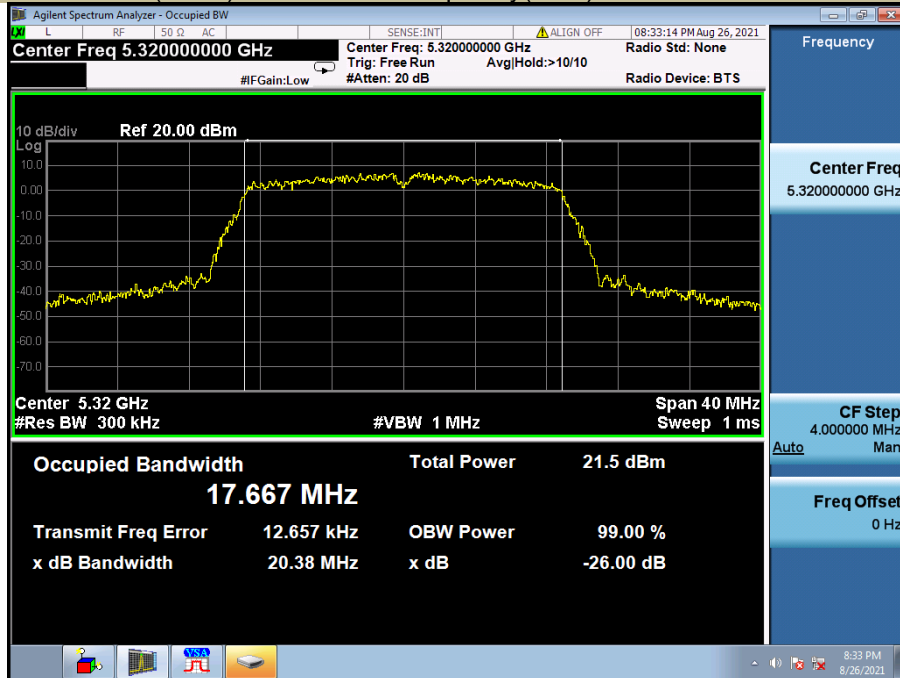

99% & -26 dB Emission Bandwidth  
Test Model 802.11n-HT40

U-NII – 2A  
Frequency(MHz) 5270

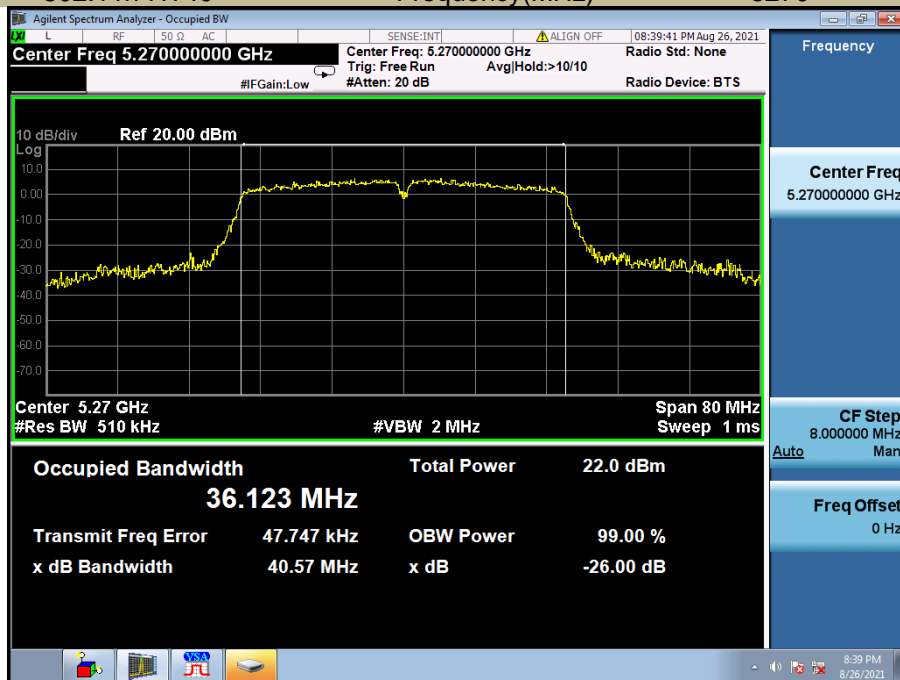

99% & -26 dB Emission Bandwidth  
Test Model 802.11n-HT40

U-NII – 2A  
Frequency(MHz) 5310



99% & -26 dB Emission Bandwidth  
Test Model 802.11ac(HT40)

U-NII – 2A  
Frequency(MHz) 5270



99% & -26 dB Emission Bandwidth U-NII – 2A  
 Test Model 802.11ac(HT40) Frequency(MHz) 5310

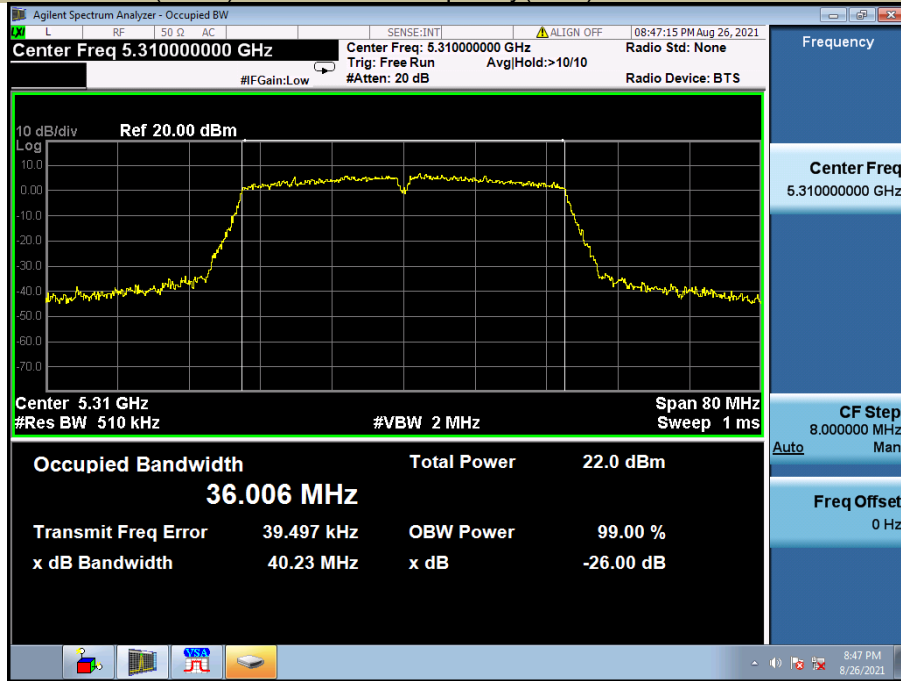

99% & -26 dB Emission Bandwidth U-NII – 2A  
 Test Model 802.11ac 80 Frequency(MHz) 5290

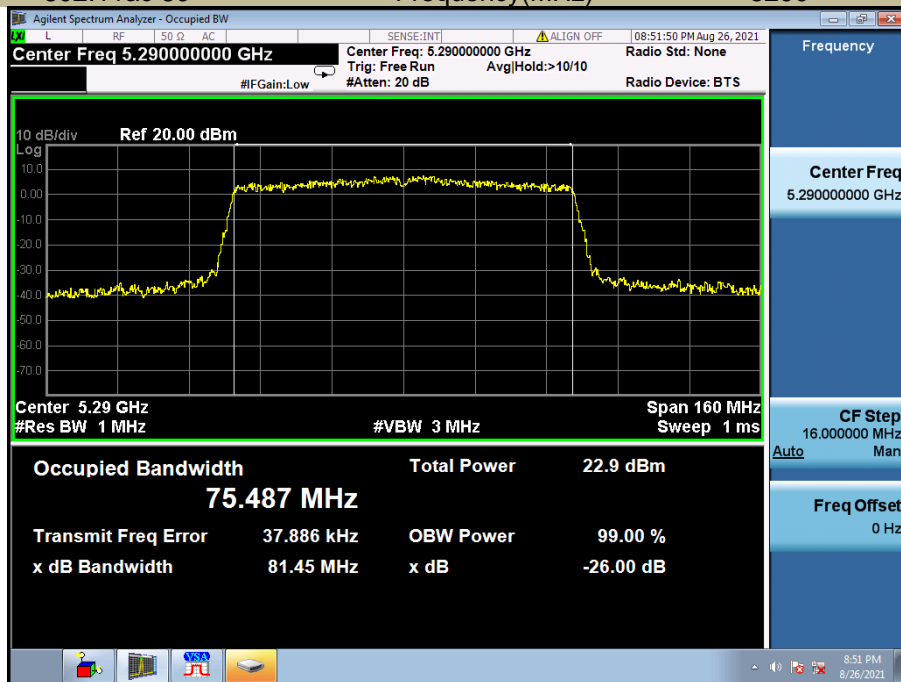

5470-5725MHz

Test Mode	Test Channel MHz		26dB Bandwidth MHz	99% Bandwidth MHz	Verdict
802.11a	CH100	5500	20.01	16.554	Pass
	CH116	5600	19.92	16.647	Pass
	CH140	5700	22.17	16.741	Pass
802.11n-HT20	CH100	5500	20.38	17.668	Pass
	CH116	5600	20.52	17.680	Pass
	CH140	5700	20.53	17.753	Pass
802.11ac(HT20)	CH100	5500	20.44	17.675	Pass
	CH116	5600	20.41	17.663	Pass
	CH140	5700	20.95	17.764	Pass
802.11n-HT40	CH102	5510	40.37	36.110	Pass
	CH134	5670	40.58	36.051	Pass
802.11ac(HT40)	CH102	5510	40.64	36.015	Pass
	CH134	5670	40.26	36.122	Pass
802.11ac(HT80)	CH106	5530	81.15	75.301	Pass

99% & -26 dB Emission Bandwidth  
Test Model 802.11a

U-NII – 2C  
Frequency(MHz) 5500

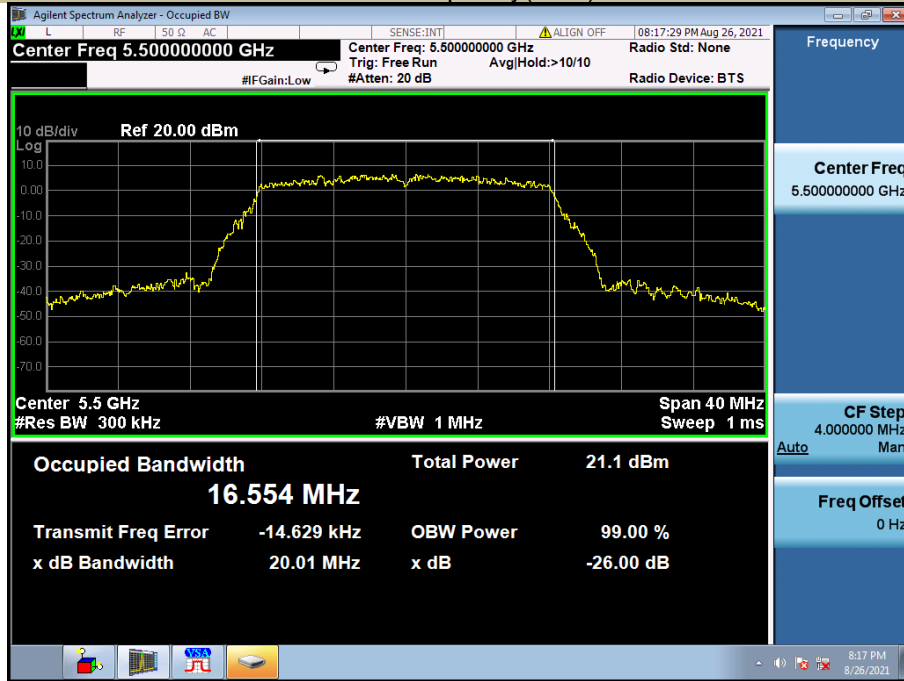

99% & -26 dB Emission Bandwidth  
Test Model 802.11a

U-NII – 2C  
Frequency(MHz) 5600

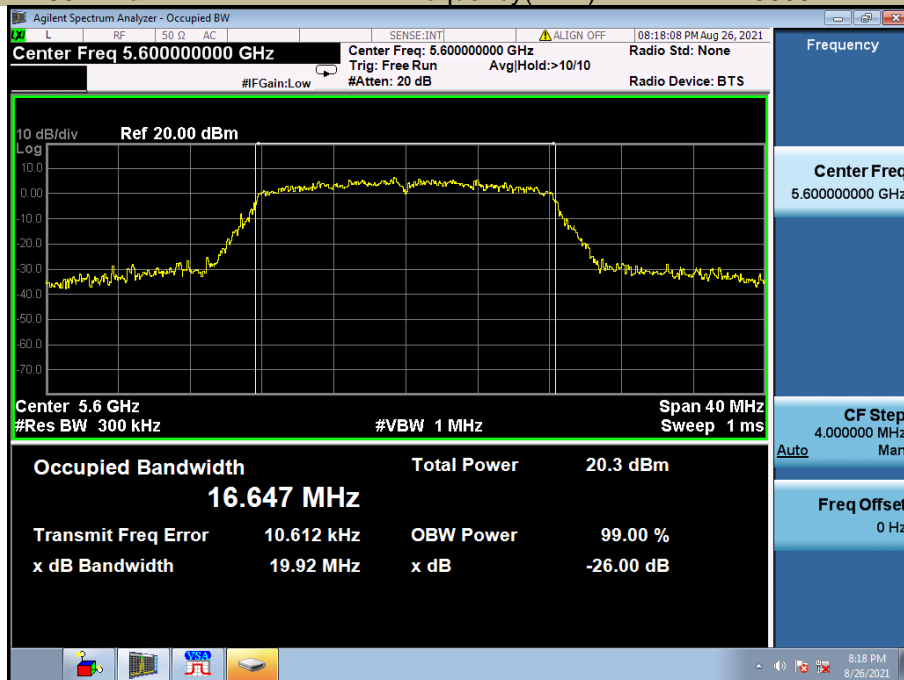

99% & -26 dB Emission Bandwidth  
Test Model 802.11a

U-NII – 2C  
Frequency(MHz) 5700

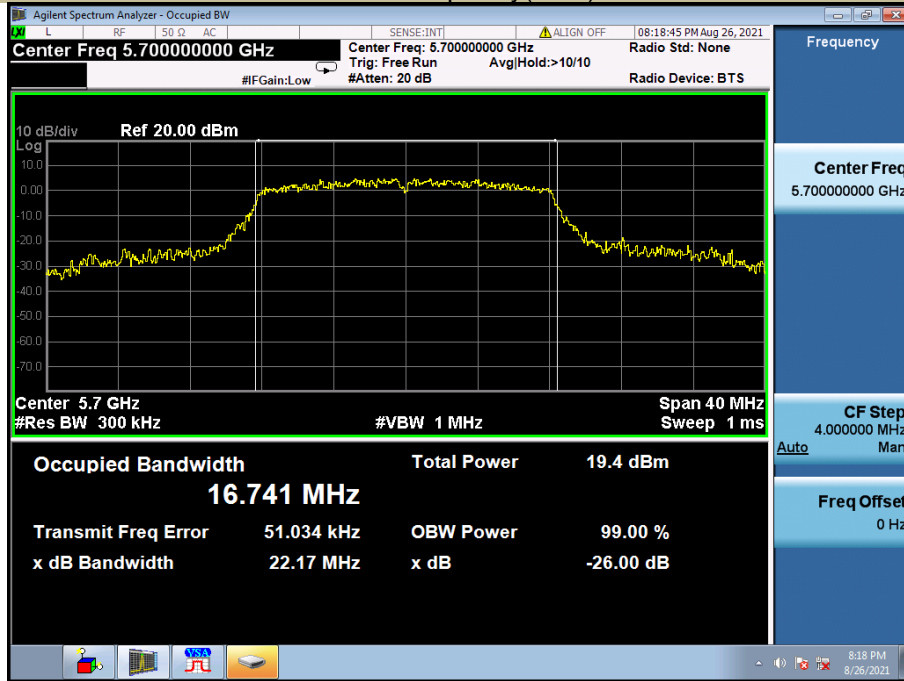

99% & -26 dB Emission Bandwidth  
Test Model 802.11n-HT20

U-NII – 2C  
Frequency(MHz) 5500

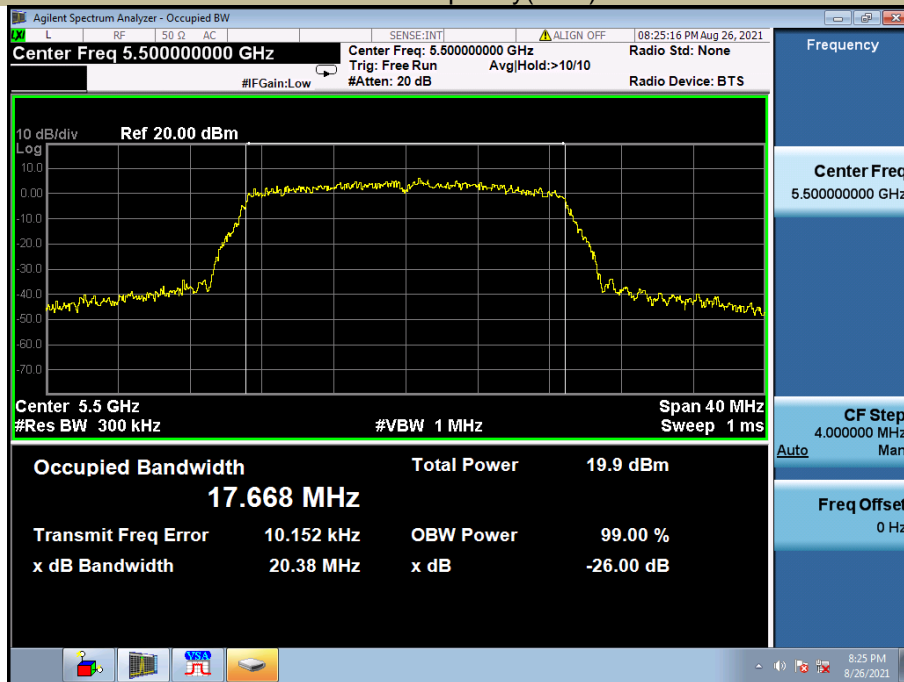



99% & -26 dB Emission Bandwidth  
Test Model 802.11n-HT20

U-NII – 2C  
Frequency(MHz) 5600

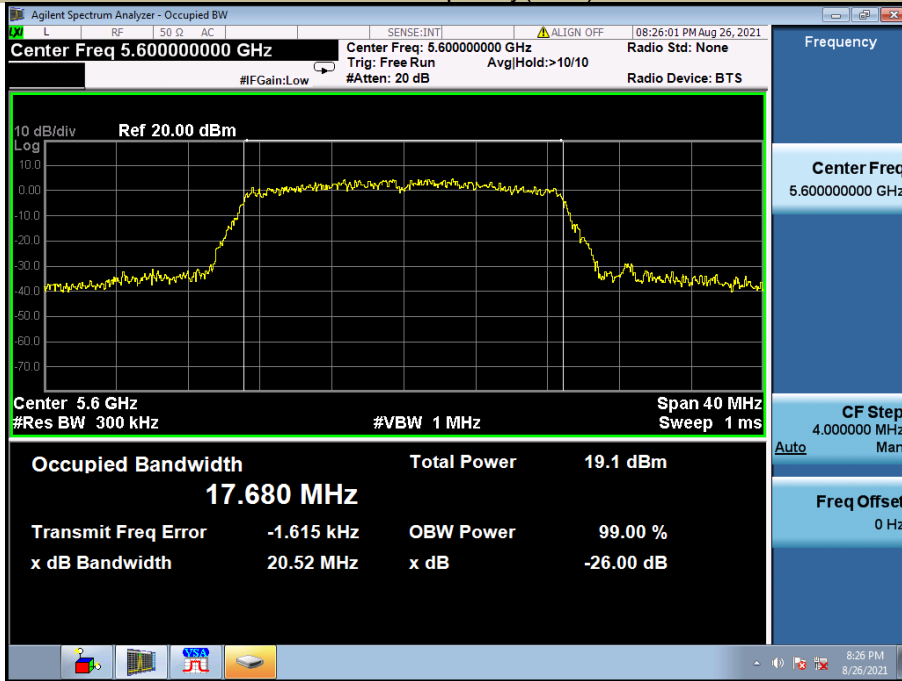

99% & -26 dB Emission Bandwidth  
Test Model 802.11n-HT20

U-NII – 2C  
Frequency(MHz) 5700

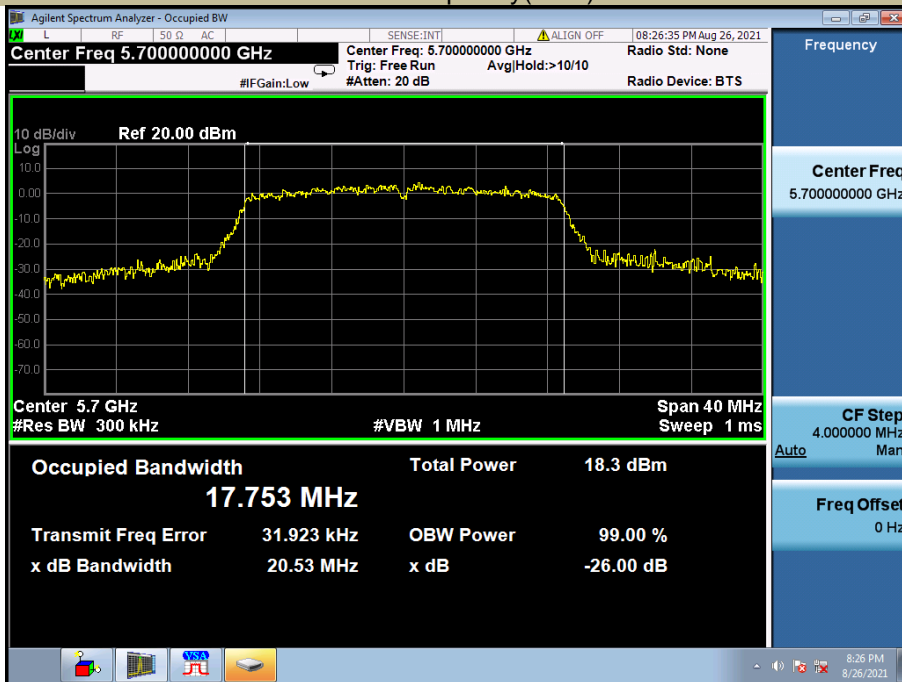

99% & -26 dB Emission Bandwidth  
Test Model 802.11ac(HT20)

U-NII – 2C  
Frequency(MHz) 5500

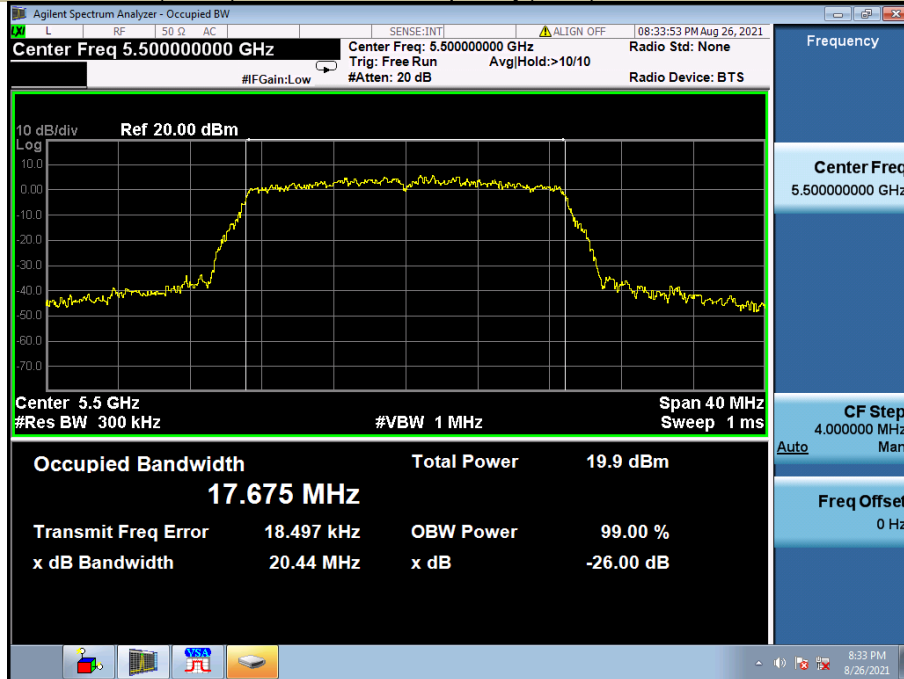

99% & -26 dB Emission Bandwidth  
Test Model 802.11ac(HT20)

U-NII – 2C  
Frequency(MHz) 5600

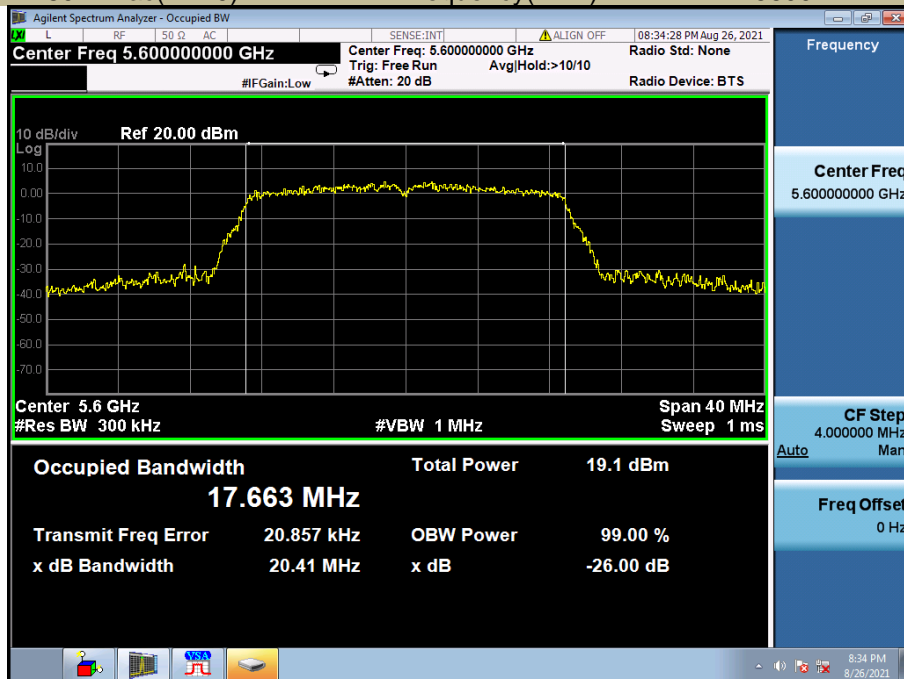

99% & -26 dB Emission Bandwidth  
Test Model 802.11ac(HT20)

U-NII – 2C  
Frequency(MHz) 5700

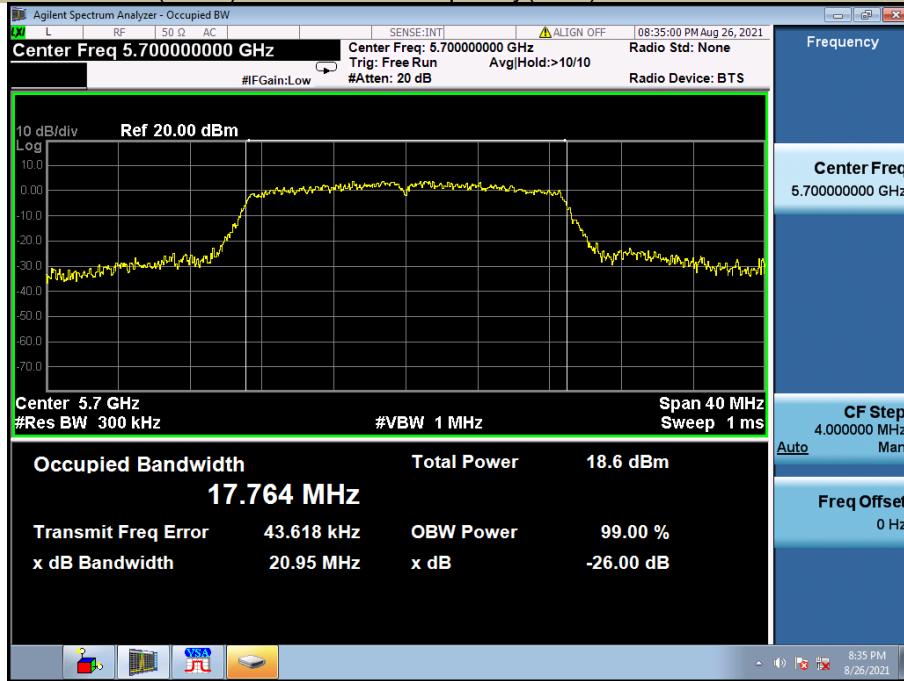

99% & -26 dB Emission Bandwidth  
Test Model 802.11n-HT40

U-NII – 2C  
Frequency(MHz) 5510

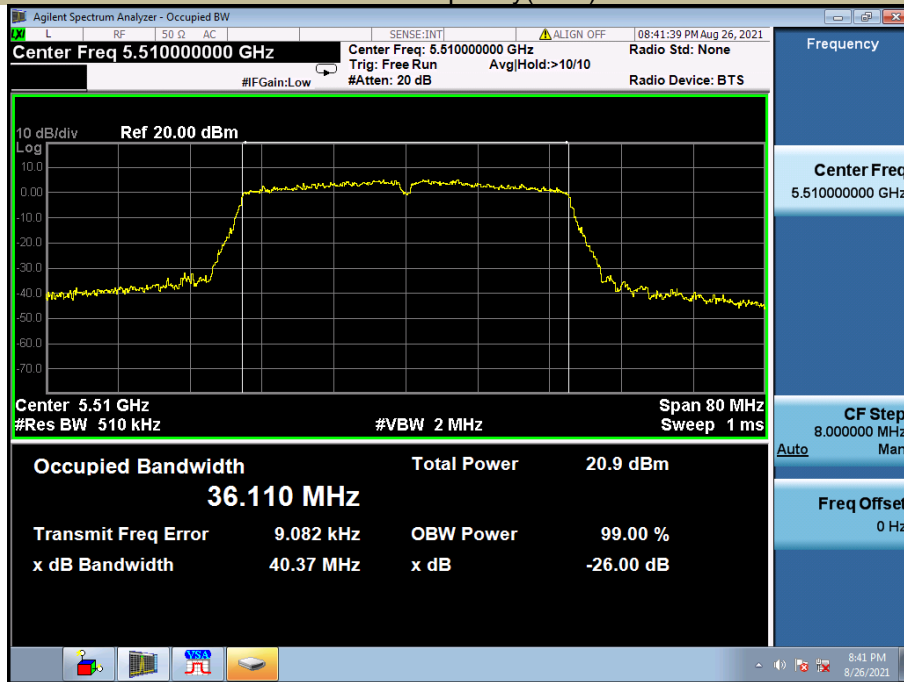

99% & -26 dB Emission Bandwidth  
Test Model 802.11n-HT40

U-NII – 2C  
Frequency(MHz) 5670

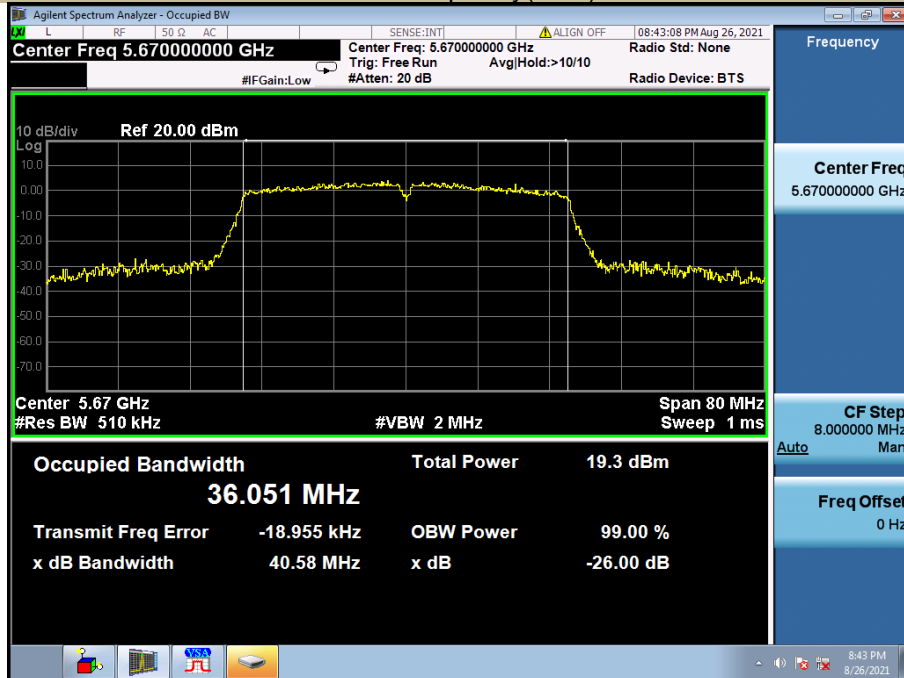

99% & -26 dB Emission Bandwidth  
Test Model 802.11ac(HT40)

U-NII – 2C  
Frequency(MHz) 5510

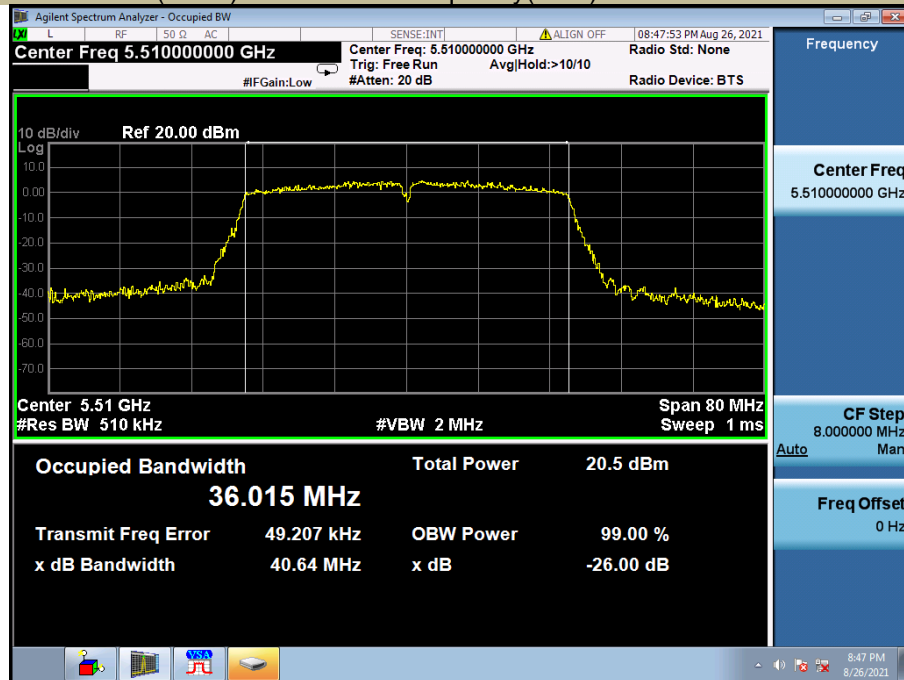

99% & -26 dB Emission Bandwidth U-NII – 2C  
 Test Model 802.11ac(HT40) Frequency(MHz) 5670

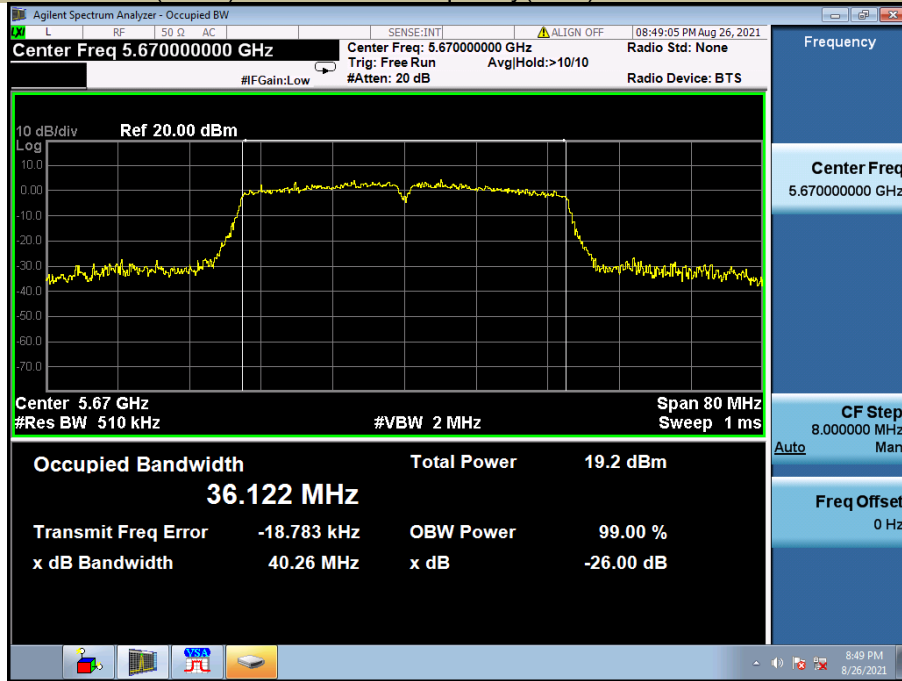

99% & -26 dB Emission Bandwidth U-NII – 2C  
 Test Model 802.11ac 80 Frequency(MHz) 5530

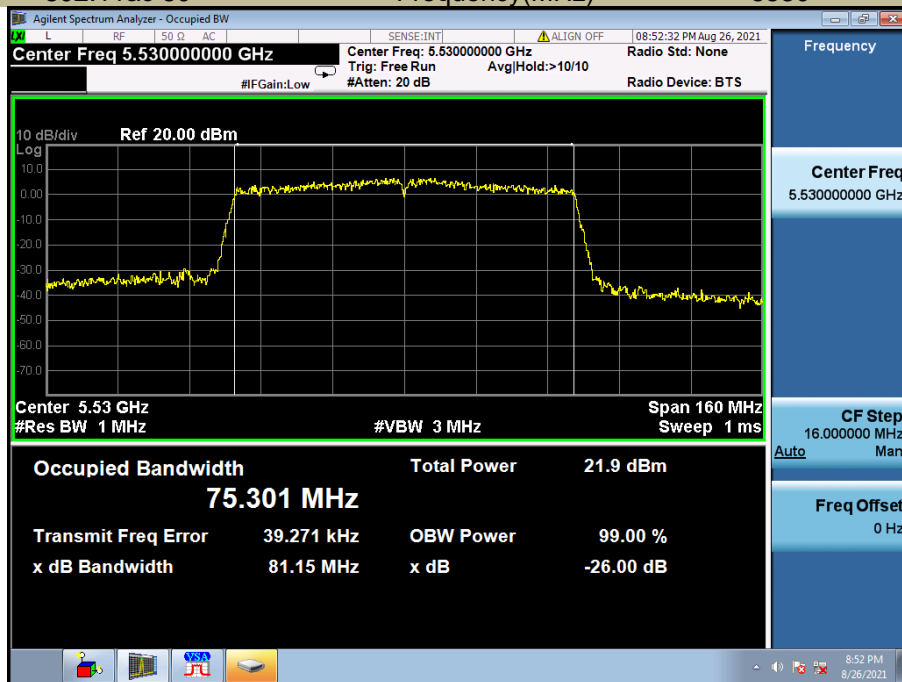

5725-5850MHz

Test Mode	Test Channel MHz		6 dB Bandwidth MHz	99% Bandwidth MHz	Limit kHz
802.11a	CH149	5745	15.15	16.513	≥500
	CH157	5785	15.07	17.406	≥500
	CH165	5825	15.16	17.328	≥500
802.11n-HT20	CH149	5745	15.04	17.600	≥500
	CH157	5785	15.11	17.770	≥500
	CH165	5825	15.13	17.763	≥500
802.11ac(HT20)	CH149	5745	15.16	17.599	≥500
	CH157	5785	15.16	17.757	≥500
	CH165	5825	15.05	17.750	≥500
802.11n-HT40	CH151	5755	35.17	36.006	≥500
	CH159	5795	35.21	36.274	≥500
802.11ac(HT40)	CH151	5755	35.16	35.986	≥500
	CH159	5795	35.19	36.294	≥500
802.11ac(HT80)	CH155	5775	75.44	75.852	≥500

99% Occupied Bandwidth  
Test Model 802.11a

U-NII - 3  
Frequency(MHz)

5745

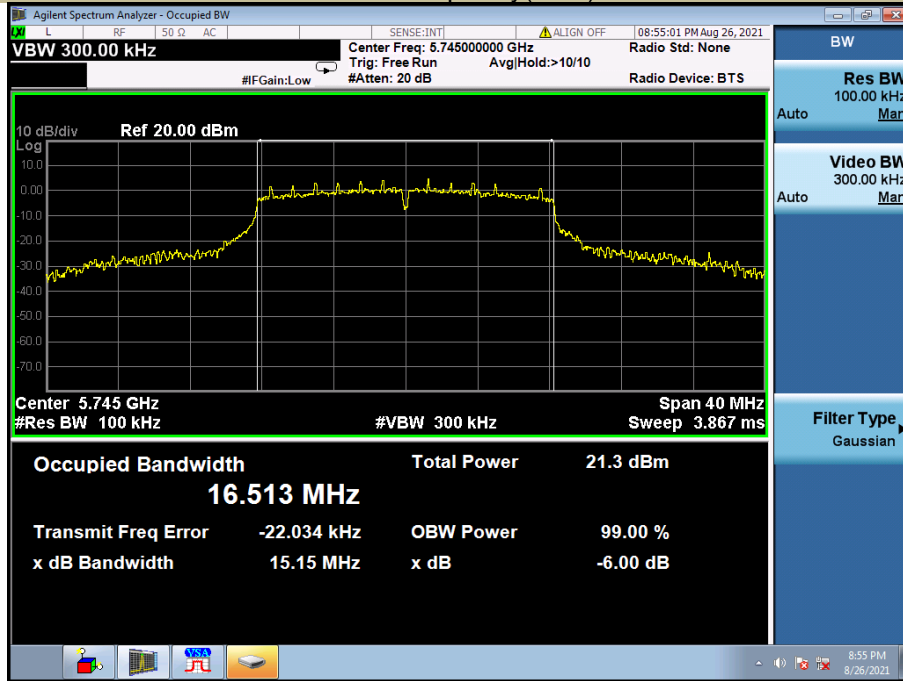

99% Occupied Bandwidth  
Test Model 802.11a

U-NII - 3  
Frequency(MHz)

5785

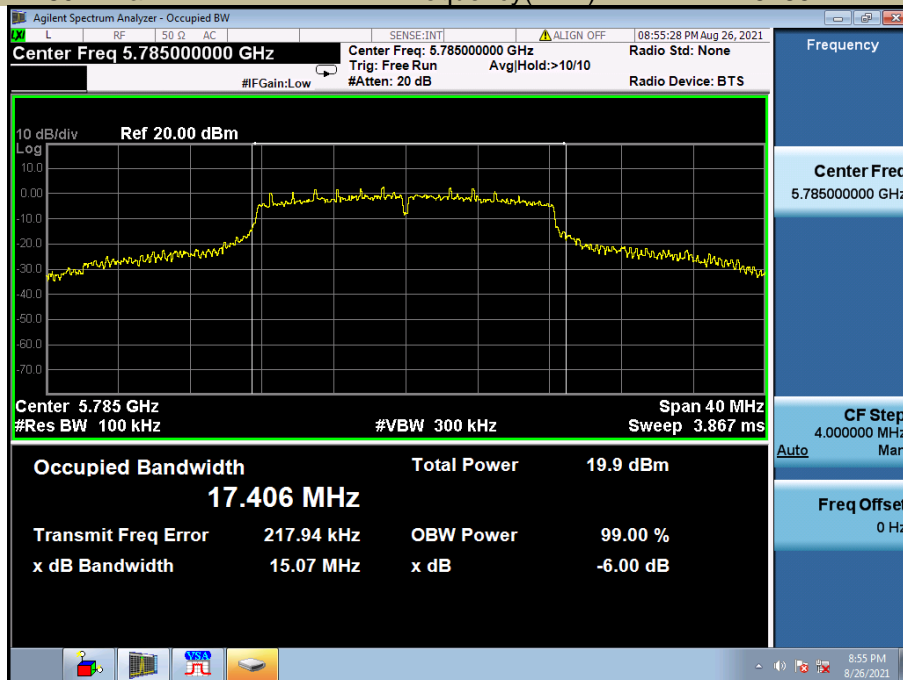



99% Occupied Bandwidth  
Test Model 802.11a

U-NII - 3  
Frequency(MHz)

5825

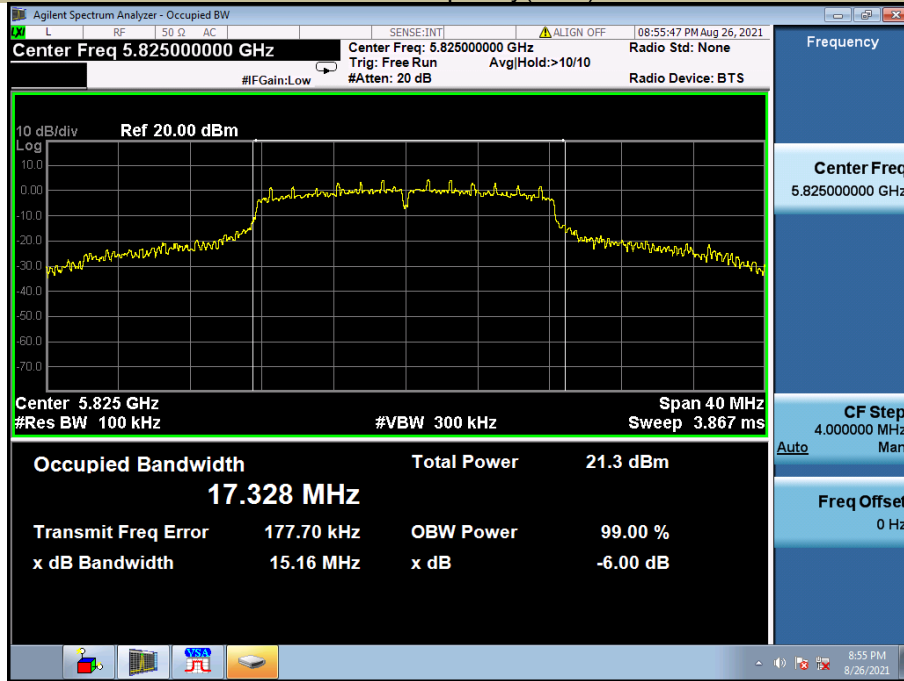

99% Occupied Bandwidth  
Test Model 802.11n-HT20

U-NII - 3  
Frequency(MHz)

5745

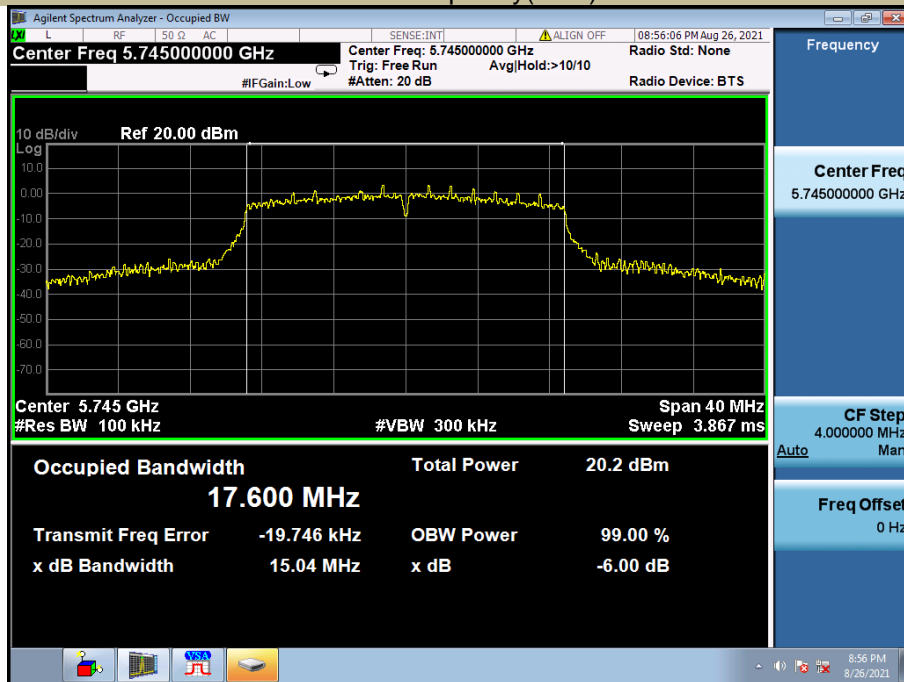



99% Occupied Bandwidth  
Test Model 802.11n-HT20

U-NII - 3  
Frequency(MHz) 5785

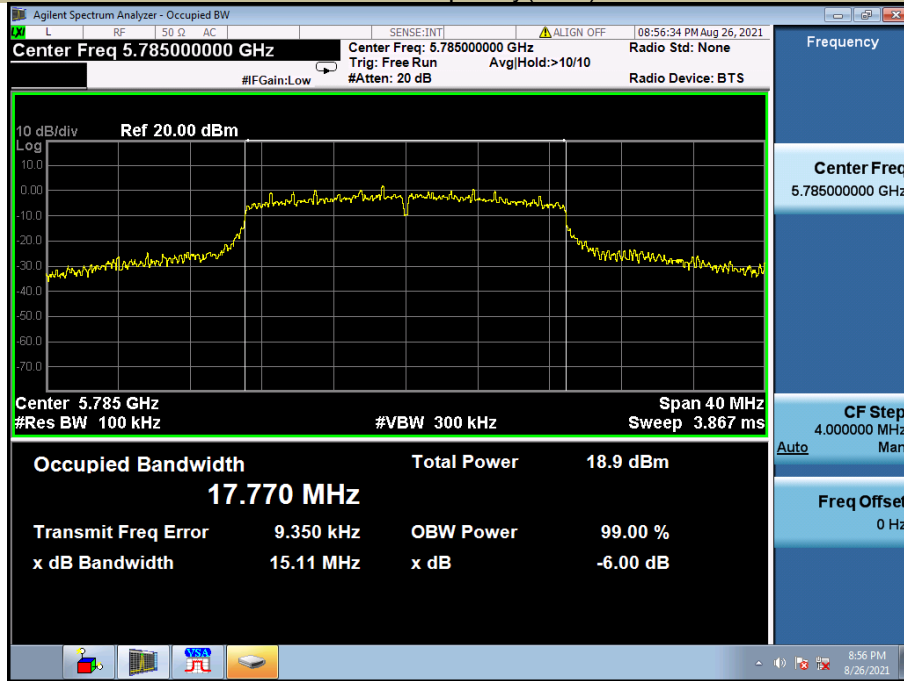

99% Occupied Bandwidth  
Test Model 802.11n-HT20

U-NII - 3  
Frequency(MHz) 5825

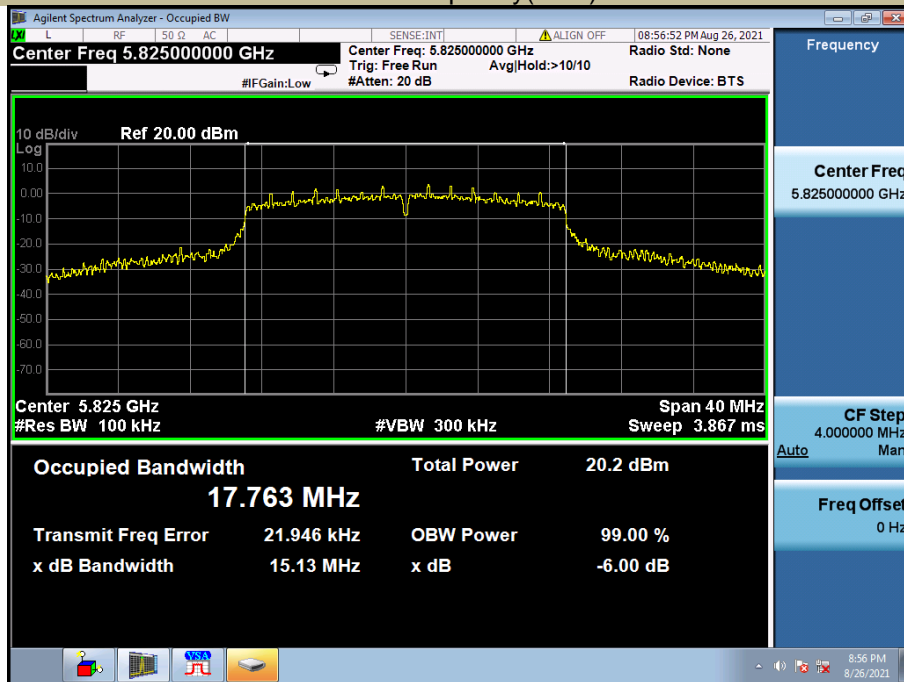

99% Occupied Bandwidth

U-NII - 3

Test Model 802.11ac(HT20)

Frequency(MHz)

5745

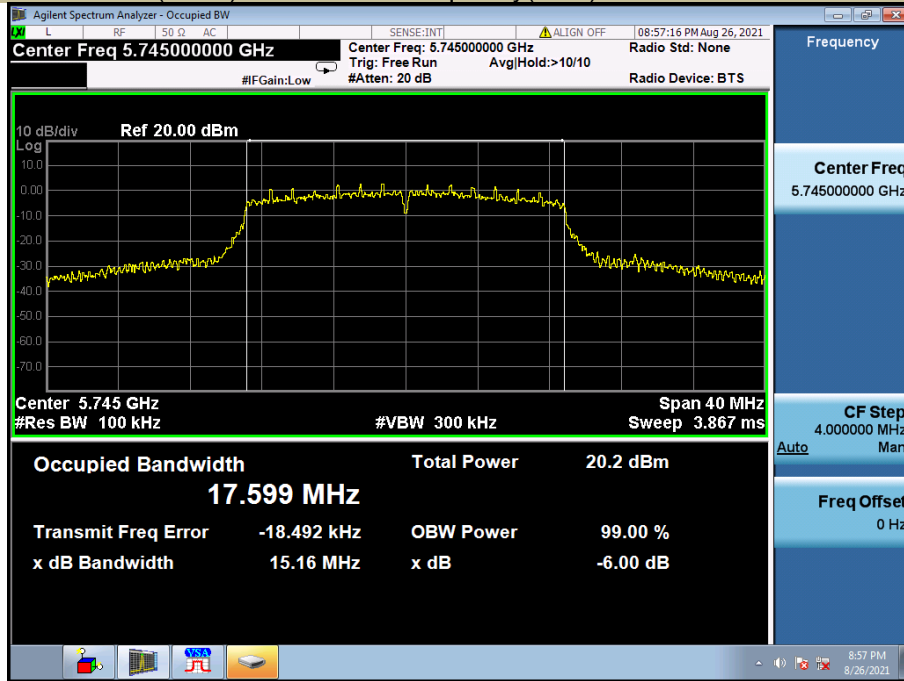

99% Occupied Bandwidth

U-NII - 3

Test Model 802.11ac(HT20)

Frequency(MHz)

5785

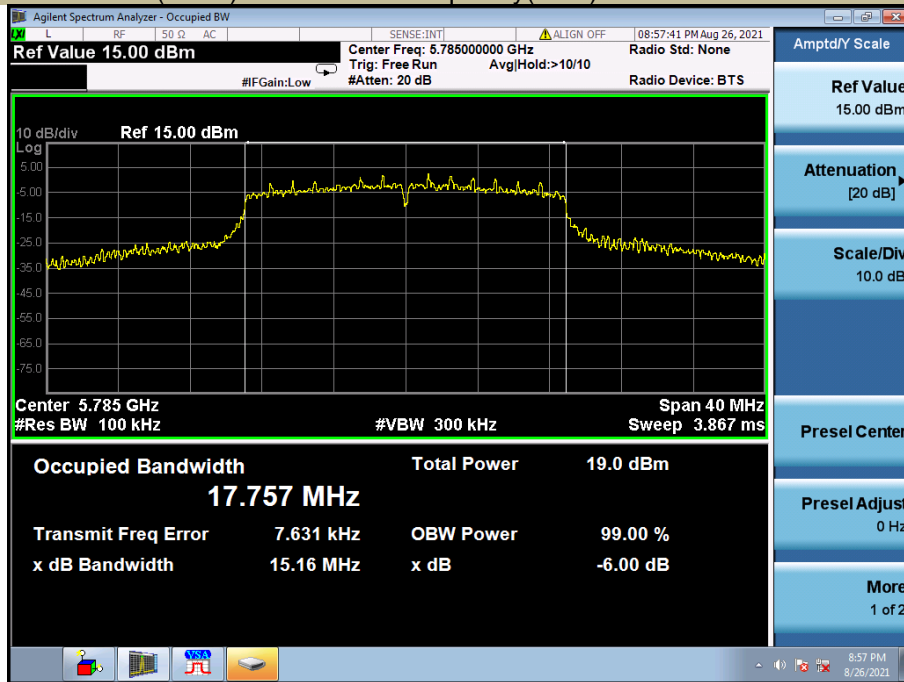

99% Occupied Bandwidth

U-NII - 3

Test Model 802.11ac(HT20)

Frequency(MHz)

5825

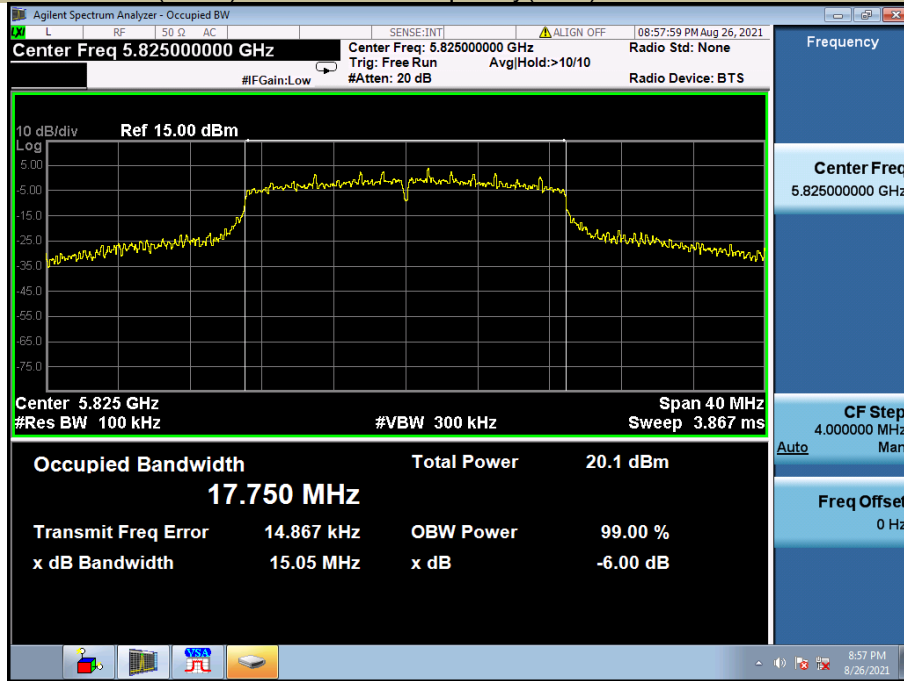

99% Occupied Bandwidth

U-NII - 3

Test Model 802.11n-HT40

Frequency(MHz)

5755

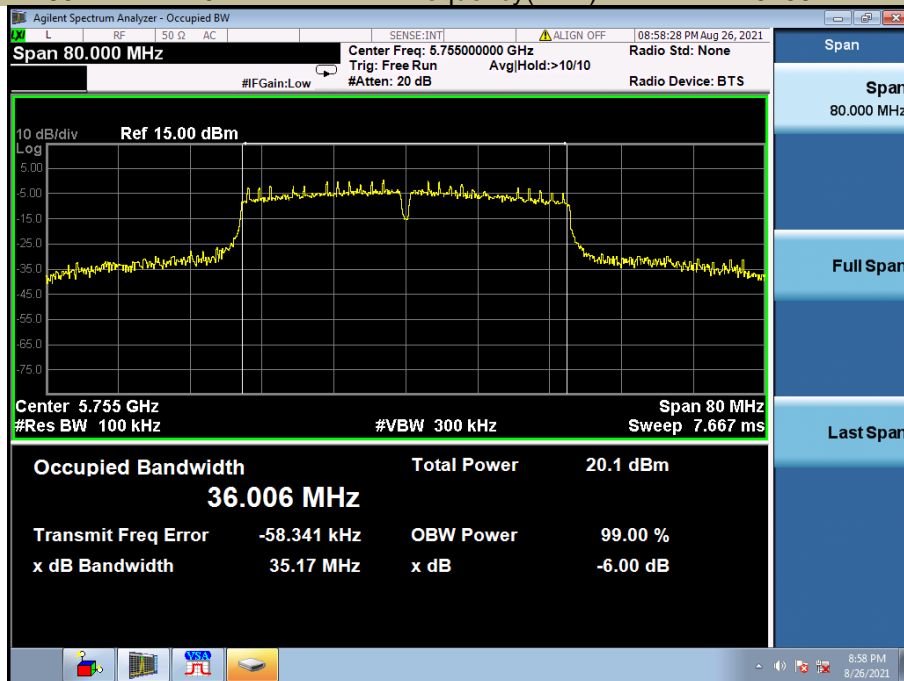

99% Occupied Bandwidth  
Test Model 802.11n-HT40

U-NII - 3  
Frequency(MHz) 5795

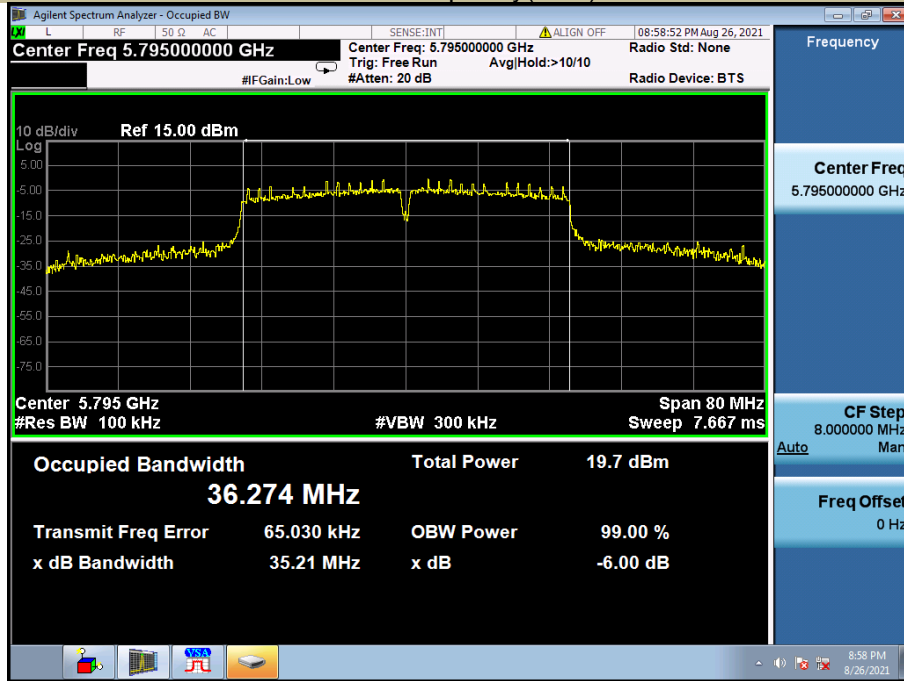

99% Occupied Bandwidth  
Test Model 802.11ac(HT40)

U-NII - 3  
Frequency(MHz) 5755

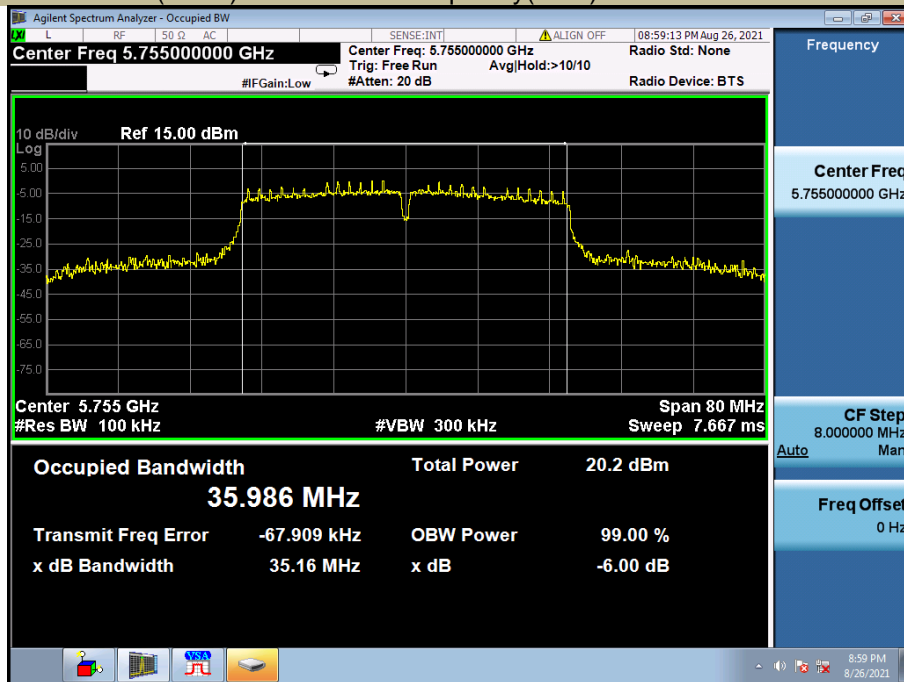

99% Occupied Bandwidth

U-NII - 3

Test Model 802.11ac(HT40)

Frequency(MHz)

5795

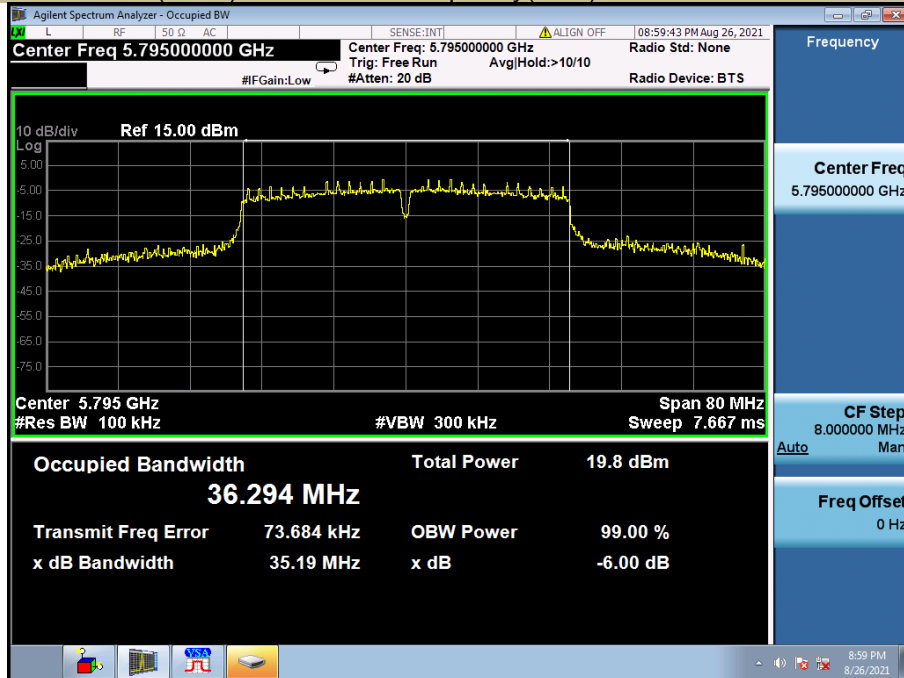

99% Occupied Bandwidth

U-NII - 3

Test Model 802.11ac 80

Frequency(MHz)

5775

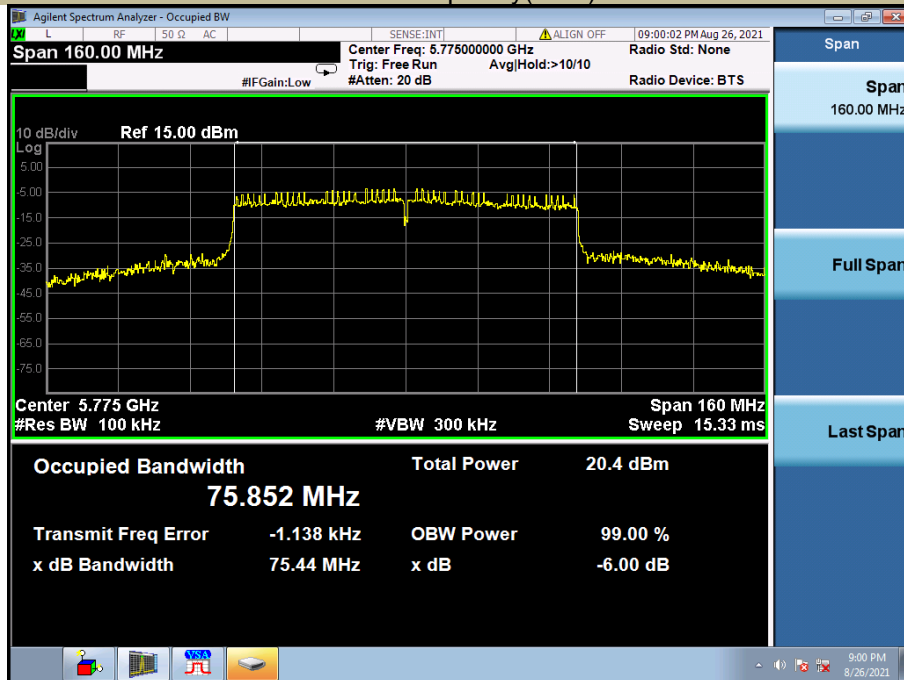

## 8.2 MAXIMUM CONDUCTED OUTPUT POWER

### 8.2.1 Applicable Standard

According to FCC Part 15.407(a)(1) for UNII Band I

According to FCC Part 15.407(a)(2) for UNII Band II-A and UNII Band II-C

According to FCC Part 15.407(a)(3) for UNII Band III

According to 789033 D02 Section II(E)

### 8.2.2 Conformance Limit

■ For the band 5.15-5.25 GHz,

(a) (1) (i) For an outdoor access point operating in the band 5.15-5.25 GHz, the maximum conducted output power over the frequency band of operation shall not exceed 1 W provided the maximum antenna gain does not exceed 6 dBi. In addition, the maximum power spectral density shall not exceed 17 dBm in any 1 megahertz band. If transmitting antennas of directional gain greater than 6 dBi are used, both the maximum conducted output power and the maximum power spectral density shall be reduced by the amount in dB that the directional gain of the antenna exceeds 6 dBi. The maximum e.i.r.p. at any elevation angle above 30 degrees as measured from the horizon must not exceed 125 mW (21 dBm).

(a) (1) (ii) For an indoor access point operating in the band 5.15-5.25 GHz, the maximum conducted output power over the frequency band of operation shall not exceed 1 W provided the maximum antenna gain does not exceed 6 dBi. In addition, the maximum power spectral density shall not exceed 17 dBm in any 1 megahertz band. If transmitting antennas of directional gain greater than 6 dBi are used, both the maximum conducted output power and the maximum power spectral density shall be reduced by the amount in dB that the directional gain of the antenna exceeds 6 dBi.

(a) (1) (iii) For fixed point-to-point access points operating in the band 5.15-5.25 GHz, the maximum conducted output power over the frequency band of operation shall not exceed 1 W. In addition, the maximum power spectral density shall not exceed 17 dBm in any 1 megahertz band. Fixed point-to-point U-NII devices may employ antennas with directional gain up to 23 dBi without any corresponding reduction in the maximum conducted output power or maximum power spectral density. For fixed point-to-point transmitters that employ a directional antenna gain greater than 23 dBi, a 1 dB reduction in maximum conducted output power and maximum power spectral density is required for each 1 dB of antenna gain in excess of 23 dBi. Fixed, point-to-point operations exclude the use of point-to-multipoint systems, omnidirectional applications, and multiple collocated transmitters transmitting the same information. The operator of the U-NII device, or if the equipment is professionally installed, the installer, is responsible for ensuring that systems employing high gain directional antennas are used exclusively for fixed, point-to-point operations.

(a) (1) (iv) For client devices in the 5.15-5.25 GHz band, the maximum conducted output power over the frequency band of operation shall not exceed 250 mW provided the maximum antenna gain does not exceed 6 dBi. In addition, the maximum power spectral density shall not exceed 11 dBm in any 1 megahertz band. If transmitting antennas of directional gain greater than 6 dBi are used, both the maximum conducted output power and the maximum power spectral density shall be reduced by the amount in dB that the directional gain of the antenna exceeds 6 dBi.

■ For the 5.25-5.35 GHz and 5.47-5.725 GHz bands

(a) (2) The maximum conducted output power over the frequency bands of operation shall not exceed the lesser of 250 mW or  $11 \text{ dBm} + 10 \log B$ , where B is the 26 dB emission bandwidth in megahertz. In addition, the maximum power spectral density shall not exceed 11 dBm in any 1 megahertz band. If transmitting antennas of directional gain greater than 6 dBi are used, both the maximum conducted output power and the maximum power spectral density shall be reduced by the amount in dB that the directional gain of the antenna exceeds 6 dBi.

■ For the band 5.725-5.85 GHz

(a) (3) for the band 5.725-5.85 GHz, the maximum conducted output power over the frequency band of operation shall not exceed 1 W. In addition, the maximum power spectral density shall not exceed 30



dBm in any 500-kHz band. If transmitting antennas of directional gain greater than 6 dBi are used, both the maximum conducted output power and the maximum power spectral density shall be reduced by the amount in dB that the directional gain of the antenna exceeds 6 dBi. However, fixed point-to-point U-NII devices operating in this band may employ transmitting antennas with directional gain greater than 6 dBi without any corresponding reduction in transmitter conducted power. Fixed, point-to-point operations exclude the use of point-to-multipoint systems, omnidirectional applications, and multiple collocated transmitters transmitting the same information. The operator of the U-NII device, or if the equipment is professionally installed, the installer, is responsible for ensuring that systems employing high gain directional antennas are used exclusively for fixed, point-to-point operations

### 8.2.3 Test Configuration

Test according to clause 6.1 radio frequency test setup

### 8.2.4 Test Procedure

The maximum average conducted output power can be measured using Method PM-G (Measurement using a gated RF average power meter):

Measurements may be performed using a wideband gated RF power meter provided that the gate parameters are adjusted such that the power is measured only when the EUT is transmitting at its maximum power control level. Since the measurement is made only during the ON time of the transmitter, no duty cycle correction factor is required.

- a. The Transmitter output (antenna port) was connected to the power meter.
- b. Turn on the EUT and power meter and then record the power value.
- c. Repeat above procedures on all channels needed to be tested.

### 8.2.5 Test Results

**For 1T1R**

Band	Operating mode	Channel Number	Channel Freq. (MHz)	Conducted Output Power(dBm)		Limit (dBm)	Verdict
				Antenna 1	Antenna 2		
U-NII – 1	802.11a	CH36	5180	16.74	17.24	24	Pass
		CH40	5200	16.40	17.06	24	Pass
		CH48	5240	16.74	17.02	24	Pass
	802.11n-HT20	CH36	5180	15.78	15.98	24	Pass
		CH40	5200	15.59	15.82	24	Pass
		CH48	5240	15.61	15.79	24	Pass
	802.11ac(HT20)	CH36	5180	15.81	15.98	24	Pass
		CH40	5200	15.67	15.83	24	Pass
		CH48	5240	15.66	15.88	24	Pass
	802.11n-HT40	CH38	5190	15.75	15.89	24	Pass
		CH46	5230	15.63	15.89	24	Pass
	802.11ac(HT40)	CH38	5190	15.67	15.89	24	Pass
		CH46	5230	15.65	15.89	24	Pass
	802.11ac(HT80)	CH42	5210	15.14	15.29	24	Pass



Band	Operating mode	Channel Number	Channel Freq. (MHz)	Conducted Output Power(dBm)		Limit (dBm)	Verdict
				Antenna 1	Antenna 2		
U-NII – 2A	802.11a	CH52	5260	16.68	16.95	24	Pass
		CH56	5280	16.66	16.89	24	Pass
		CH64	5320	16.87	17.21	24	Pass
	802.11n-HT20	CH52	5260	15.62	15.77	24	Pass
		CH56	5280	15.52	15.66	24	Pass
		CH64	5320	15.75	15.97	24	Pass
	802.11ac(HT20)	CH52	5260	15.59	15.77	24	Pass
		CH56	5280	15.47	15.65	24	Pass
		CH64	5320	15.70	16.08	24	Pass
	802.11n-HT40	CH54	5270	15.63	15.90	24	Pass
		CH62	5310	15.84	16.05	24	Pass
	802.11ac(HT40)	CH54	5270	15.63	15.94	24	Pass
		CH62	5310	15.82	16.05	24	Pass
	802.11ac(HT80)	CH58	5290	15.39	15.53	24	Pass

Band	Operating mode	Channel Number	Channel Freq. (MHz)	Conducted Output Power(dBm)		Limit (dBm)	Verdict
				Antenna 1	Antenna 2		
U-NII – 2C	802.11a	CH100	5500	15.29	15.89	24	Pass
		CH116	5600	14.47	15.27	24	Pass
		CH140	5700	13.83	14.64	24	Pass
	802.11n-HT20	CH100	5500	14.09	14.61	24	Pass
		CH116	5600	13.28	14.15	24	Pass
		CH140	5700	12.66	13.42	24	Pass
	802.11ac(HT20)	CH100	5500	14.07	14.65	24	Pass
		CH116	5600	13.35	14.06	24	Pass
		CH140	5700	12.64	13.49	24	Pass
	802.11n-HT40	CH102	5510	14.41	15.13	24	Pass
		CH134	5670	12.97	13.74	24	Pass
	802.11ac(HT40)	CH102	5510	14.50	15.08	24	Pass
		CH134	5670	13.00	13.76	24	Pass
	802.11ac(HT80)	CH106	5530	14.35	14.90	24	Pass

Band	Operating mode	Channel Number	Channel Freq. (MHz)	Conducted Output Power(dBm)		Limit (dBm)	Verdict
				Antenna 1	Antenna 2		
U-NII – 3	802.11a	CH149	5745	14.33	15.27	30	Pass
		CH157	5785	13.15	14.01	30	Pass
		CH165	5825	14.24	15.16	30	Pass
	802.11n-HT20	CH149	5745	13.29	14.12	30	Pass
		CH157	5785	12.08	12.84	30	Pass
		CH165	5825	13.25	14.02	30	Pass
	802.11ac(HT20)	CH149	5745	13.31	14.00	30	Pass
		CH157	5785	12.04	12.87	30	Pass
		CH165	5825	13.20	13.94	30	Pass
	802.11n-HT40	CH151	5755	12.82	13.67	30	Pass
		CH159	5795	12.13	13.07	30	Pass
	802.11ac(HT40)	CH151	5755	12.84	13.78	30	Pass
		CH159	5795	12.27	13.10	30	Pass
	802.11ac(HT80)	CH155	5775	12.04	12.92	30	Pass

### For 2T2R

Band	Operating mode	Channel Number	Channel Freq. (MHz)	Conducted Output Power(dBm)	Limit (dBm)	Verdict
U-NII – 1	802.11n-HT20	CH36	5180	18.89	24	Pass
		CH40	5200	18.72	24	Pass
		CH48	5240	18.71	24	Pass
	802.11ac(HT20)	CH36	5180	18.91	24	Pass
		CH40	5200	18.76	24	Pass
		CH48	5240	18.78	24	Pass
	802.11n-HT40	CH38	5190	18.83	24	Pass
		CH46	5230	18.77	24	Pass
	802.11ac(HT40)	CH38	5190	18.79	24	Pass
		CH46	5230	18.78	24	Pass
	802.11ac(HT80)	CH42	5210	18.23	24	Pass

Band	Operating mode	Channel Number	Channel Freq. (MHz)	Conducted Output Power(dBm)	Limit (dBm)	Verdict
U-NII – 2A	802.11n-HT20	CH52	5260	18.71	24	Pass
		CH56	5280	18.60	24	Pass
		CH64	5320	18.87	24	Pass
	802.11ac(HT20)	CH52	5260	18.69	24	Pass
		CH56	5280	18.57	24	Pass
		CH64	5320	18.90	24	Pass
	802.11n-HT40	CH54	5270	18.78	24	Pass
		CH62	5310	18.96	24	Pass
	802.11ac(HT40)	CH54	5270	18.80	24	Pass
		CH62	5310	18.95	24	Pass
	802.11ac(HT80)	CH58	5290	18.47	24	Pass

Band	Operating mode	Channel Number	Channel Freq. (MHz)	Conducted Output Power(dBm)	Limit (dBm)	Verdict
U-NII – 2C	802.11n-HT20	CH100	5500	17.37	24	Pass
		CH116	5600	16.75	24	Pass
		CH140	5700	16.07	24	Pass
	802.11ac(HT20)	CH100	5500	17.38	24	Pass
		CH116	5600	16.73	24	Pass
		CH140	5700	16.10	24	Pass
	802.11n-HT40	CH102	5510	17.80	24	Pass
		CH134	5670	16.38	24	Pass
	802.11ac(HT40)	CH102	5510	17.81	24	Pass
		CH134	5670	16.41	24	Pass
	802.11ac(HT80)	CH106	5530	17.64	24	Pass

Band	Operating mode	Channel Number	Channel Freq. (MHz)	Conducted Output Power(dBm)	Limit (dBm)	Verdict
U-NII – 3	802.11n-HT20	CH149	5745	16.74	30	Pass
		CH157	5785	15.49	30	Pass
		CH165	5825	16.66	30	Pass
	802.11ac(HT20)	CH149	5745	16.68	30	Pass
		CH157	5785	15.49	30	Pass
		CH165	5825	16.60	30	Pass
	802.11n-HT40	CH151	5755	16.28	30	Pass
		CH159	5795	15.64	30	Pass
	802.11ac(HT40)	CH151	5755	16.35	30	Pass
		CH159	5795	15.72	30	Pass
	802.11ac(HT80)	CH155	5775	15.51	30	Pass

## 8.3 MAXIMUM PEAK POWER DENSITY

### 8.3.1 Applicable Standard

According to FCC Part 15.407(a)(1) for UNII Band I

According to FCC Part 15.407(a)(2) for UNII Band II-A and UNII Band II-C

According to FCC Part 15.407(a)(3) for UNII Band III

According to 789033 D02 Section II(F)

### 8.3.2 Conformance Limit

#### ■ For the band 5.15-5.25 GHz,

(a) (1) (i) For an outdoor access point operating in the band 5.15-5.25 GHz, the maximum conducted output power over the frequency band of operation shall not exceed 1 W provided the maximum antenna gain does not exceed 6 dBi. In addition, the maximum power spectral density shall not exceed 17 dBm in any 1 megahertz band. If transmitting antennas of directional gain greater than 6 dBi are used, both the maximum conducted output power and the maximum power spectral density shall be reduced by the amount in dB that the directional gain of the antenna exceeds 6 dBi. The maximum e.i.r.p. at any elevation angle above 30 degrees as measured from the horizon must not exceed 125 mW (21 dBm).

(a) (1) (ii) For an indoor access point operating in the band 5.15-5.25 GHz, the maximum conducted output power over the frequency band of operation shall not exceed 1 W provided the maximum antenna gain does not exceed 6 dBi. In addition, the maximum power spectral density shall not exceed 17 dBm in any 1 megahertz band. If transmitting antennas of directional gain greater than 6 dBi are used, both the maximum conducted output power and the maximum power spectral density shall be reduced by the amount in dB that the directional gain of the antenna exceeds 6 dBi.

(a) (1) (iii) For fixed point-to-point access points operating in the band 5.15-5.25 GHz, the maximum conducted output power over the frequency band of operation shall not exceed 1 W. In addition, the maximum power spectral density shall not exceed 17 dBm in any 1 megahertz band. Fixed point-to-point U-NII devices may employ antennas with directional gain up to 23 dBi without any corresponding reduction in the maximum conducted output power or maximum power spectral density. For fixed point-to-point transmitters that employ a directional antenna gain greater than 23 dBi, a 1 dB reduction in maximum conducted output power and maximum power spectral density is required for each 1 dB of antenna gain in excess of 23 dBi. Fixed, point-to-point operations exclude the use of point-to-multipoint systems, omnidirectional applications, and multiple collocated transmitters transmitting the same information. The operator of the U-NII device, or if the equipment is professionally installed, the installer, is responsible for ensuring that systems employing high gain directional antennas are used exclusively for fixed, point-to-point operations.

(a) (1) (iv) For client devices in the 5.15-5.25 GHz band, the maximum conducted output power over the frequency band of operation shall not exceed 250 mW provided the maximum antenna gain does not exceed 6 dBi. In addition, the maximum power spectral density shall not exceed 11 dBm in any 1 megahertz band. If transmitting antennas of directional gain greater than 6 dBi are used, both the maximum conducted output power and the maximum power spectral density shall be reduced by the amount in dB that the directional gain of the antenna exceeds 6 dBi.

#### ■ For the 5.25-5.35 GHz and 5.47-5.725 GHz bands

(b) (2) The maximum conducted output power over the frequency bands of operation shall not exceed the lesser of 250 mW or  $11 \text{ dBm} + 10 \log B$ , where B is the 26 dB emission bandwidth in megahertz. In addition, the maximum power spectral density shall not exceed 11 dBm in any 1 megahertz band. If transmitting antennas of directional gain greater than 6 dBi are used, both the maximum conducted output power and the maximum power spectral density shall be reduced by the amount in dB that the directional gain of the antenna exceeds 6 dBi.

#### ■ For the band 5.725-5.85 GHz

(a) (3) for the band 5.725-5.85 GHz, the maximum conducted output power over the frequency band of operation shall not exceed 1 W. In addition, the maximum power spectral density shall not exceed 30



dBm in any 500-kHz band. If transmitting antennas of directional gain greater than 6 dBi are used, both the maximum conducted output power and the maximum power spectral density shall be reduced by the amount in dB that the directional gain of the antenna exceeds 6 dBi. However, fixed point-to-point U-NII devices operating in this band may employ transmitting antennas with directional gain greater than 6 dBi without any corresponding reduction in transmitter conducted power. Fixed, point-to-point operations exclude the use of point-to-multipoint systems, omnidirectional applications, and multiple collocated transmitters transmitting the same information. The operator of the U-NII device, or if the equipment is professionally installed, the installer, is responsible for ensuring that systems employing high gain directional antennas are used exclusively for fixed, point-to-point operations

### 8.3.3 Test Configuration

Test according to clause 6.1 radio frequency test setup

### 8.3.4 Test Procedure

Methods refer to FCC KDB 789033

For devices operating in the bands 5.15-5.25 GHz, 5.25-5.35 GHz, and 5.47-5.725 GHz, the above procedures make use of 1 MHz RBW to satisfy directly the 1 MHz reference bandwidth specified in § 15.407(a)(5). For devices operating in the band 5.725-5.85 GHz, the rules specify a measurement bandwidth of 500 kHz. Many spectrum analyzers do not have 500 kHz RBW, thus a narrower RBW may need to be used. The rules permit the use of a RBWs less than 1 MHz, or 500 kHz, “provided that the measured power is integrated over the full reference bandwidth” to show the total power over the specified measurement bandwidth (i.e., 1 MHz, or 500 kHz). If measurements are performed using a reduced resolution bandwidth (< 1 MHz, or < 500 kHz) and integrated over 1 MHz, or 500 KHz bandwidth, the following adjustments to the procedures apply:

- a) Set  $RBW \geq 1/T$ , where T is defined in section II.B.I.a).
- b) Set  $VBW \geq 3 RBW$ .
- c) If measurement bandwidth of Maximum PSD is specified in 500 kHz, add  $10\log(500\text{kHz}/RBW)$  to the measured result, whereas  $RBW (< 500 \text{ KHz})$  is the reduced resolution bandwidth of the spectrum analyzer set during measurement.
- d) If measurement bandwidth of Maximum PSD is specified in 1 MHz, add  $10\log(1\text{MHz}/RBW)$  to the measured result, whereas  $RBW (< 1 \text{ MHz})$  is the reduced resolution bandwidth of spectrum analyzer set during measurement.
- e) Care must be taken to ensure that the measurements are performed during a period of continuous transmission or are corrected upward for duty cycle.

Note: As a practical matter, it is recommended to use reduced RBW of 100 KHz for the sections 5.c) and 5.d) above, since  $RBW=100 \text{ KHz}$  is available on nearly all spectrum analyzers.

8.3.5 Test Results

**For 1T1R-Antenna 1**

*5150-5250MHz*

Operating mode	Test Channel	Power Spectral Density dBm/MHz	Limit (dBm/MHz)
802.11a	5180	6.80	11
	5200	6.50	11
	5240	6.74	11
802.11n-HT20	5180	5.74	11
	5200	5.22	11
	5240	5.14	11
802.11ac(HT20)	5180	5.61	11
	5200	5.13	11
	5240	5.49	11
802.11n-HT40	5190	2.29	11
	5230	2.36	11
802.11ac(HT40)	5190	2.42	11
	5230	2.49	11
802.11ac(HT80)	5210	-1.42	11

Power Spectral Density  
Test Model 802.11a

U-NII - 1  
Frequency(MHz)

5180

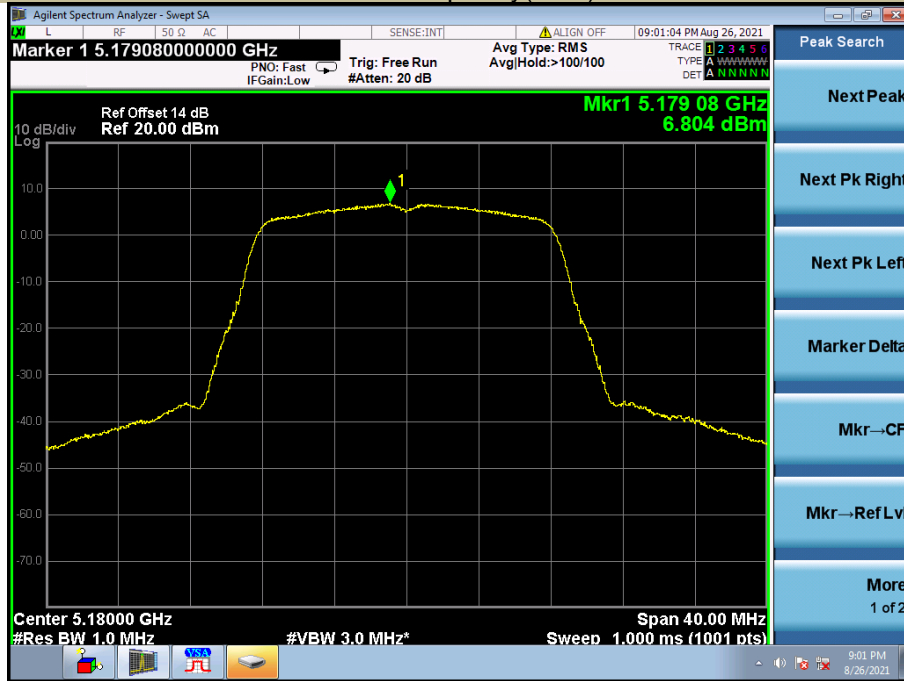

Power Spectral Density  
Test Model 802.11a

U-NII - 1  
Frequency(MHz)

5200

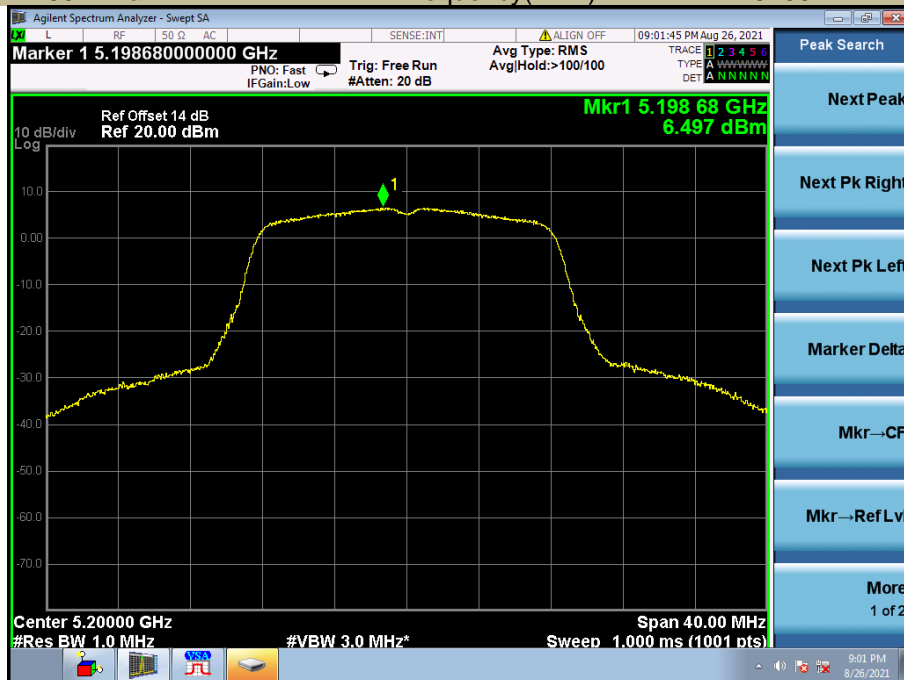

Power Spectral Density U-NII - 1  
 Test Model 802.11a Frequency(MHz) 5240

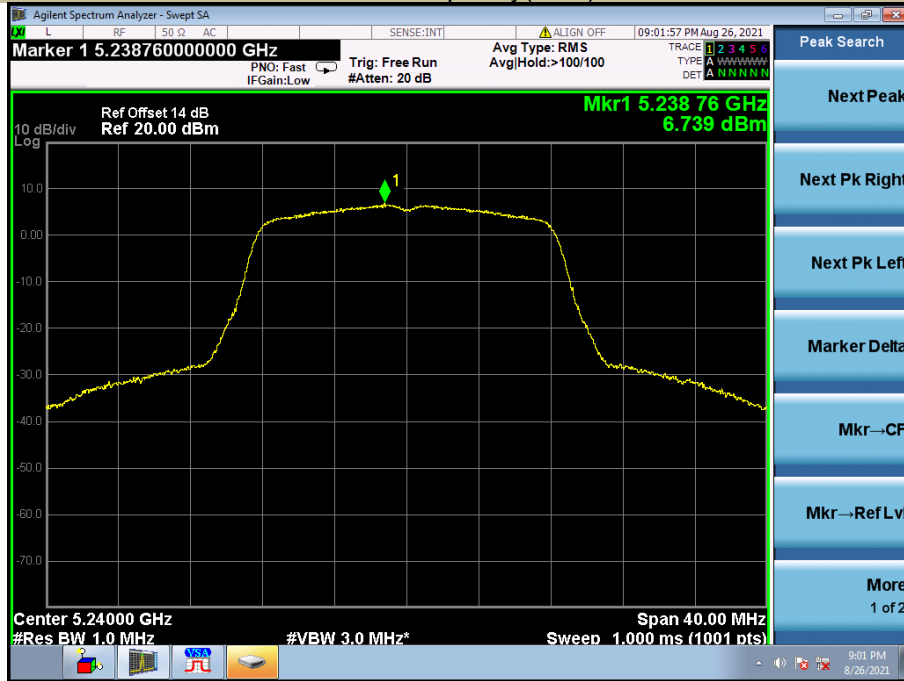

Power Spectral Density U-NII - 1  
 Test Model 802.11n-HT20 Frequency(MHz) 5180

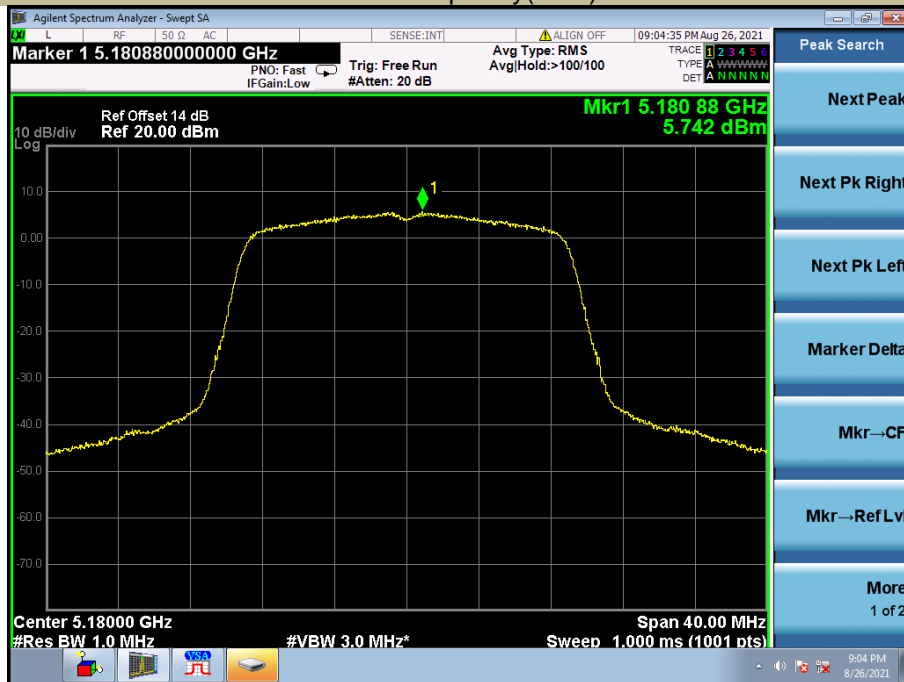

Power Spectral Density U-NII - 1  
 Test Model 802.11n-HT20 Frequency(MHz) 5200

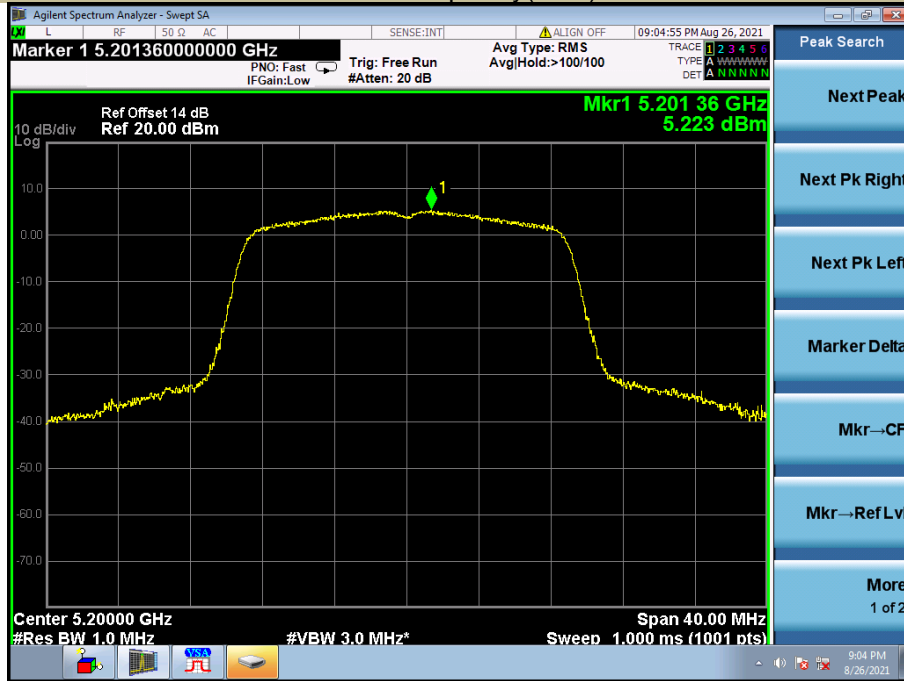

Power Spectral Density U-NII - 1  
 Test Model 802.11n-HT20 Frequency(MHz) 5240

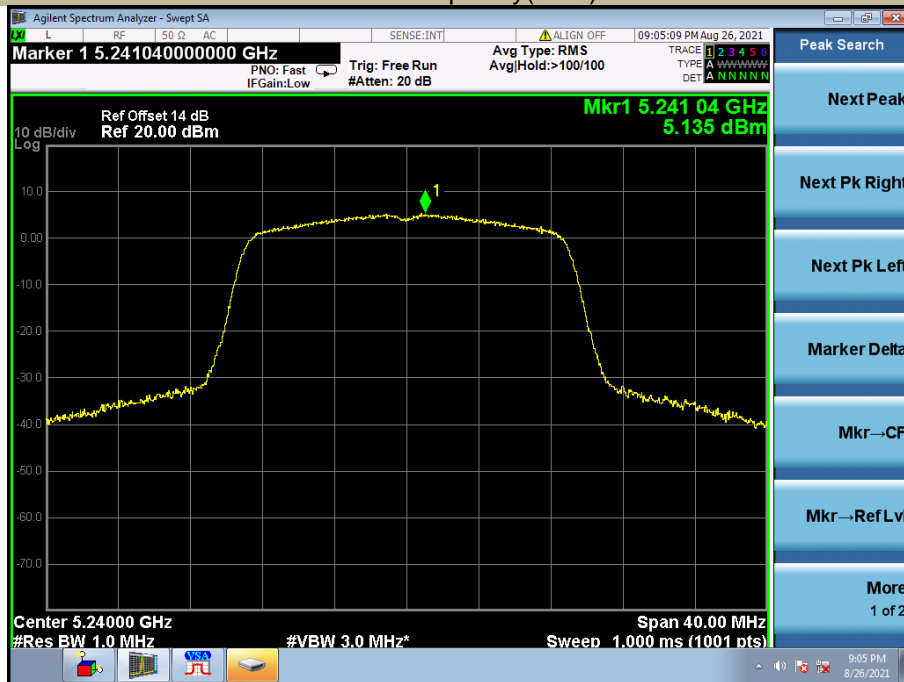

Power Spectral Density U-NII - 1  
 Test Model 802.11ac(HT20) Frequency(MHz) 5180

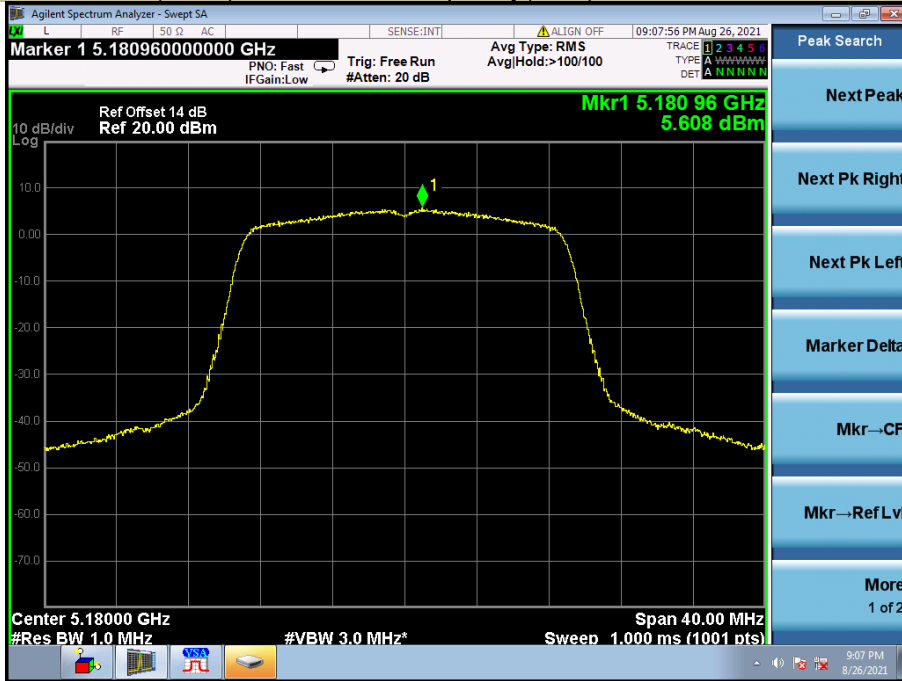

Power Spectral Density U-NII - 1  
 Test Model 802.11ac(HT20) Frequency(MHz) 5200

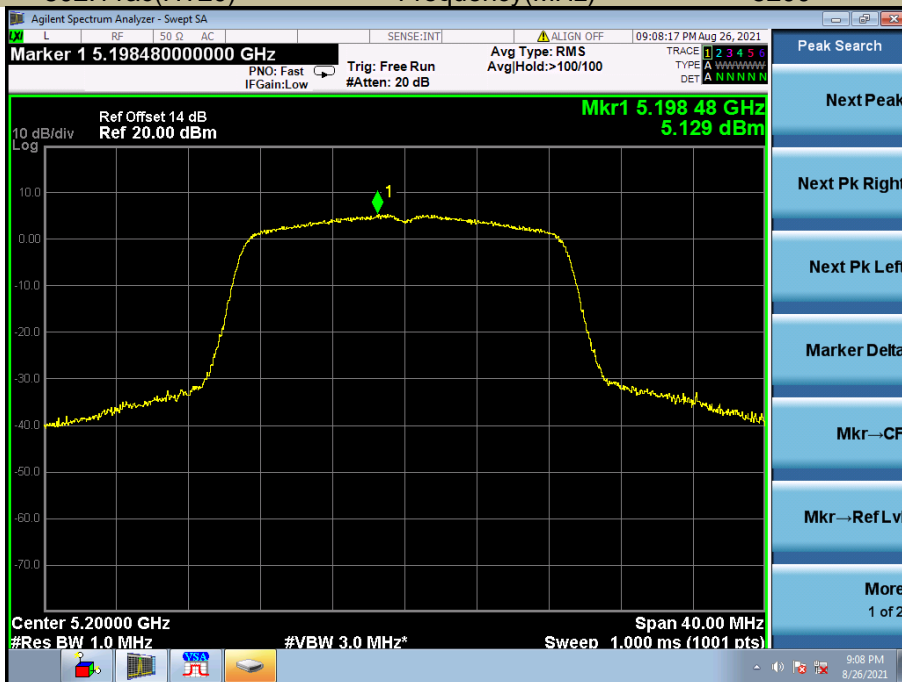

Power Spectral Density U-NII - 1  
 Test Model 802.11ac(HT20) Frequency(MHz) 5240

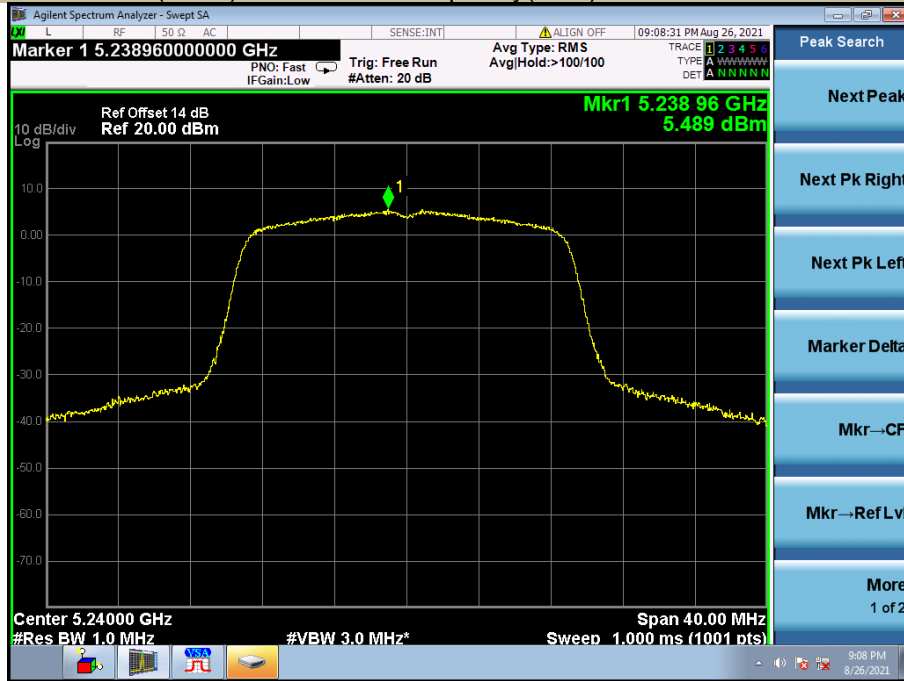

Power Spectral Density U-NII - 1  
 Test Model 802.11n-HT40 Frequency(MHz) 5190

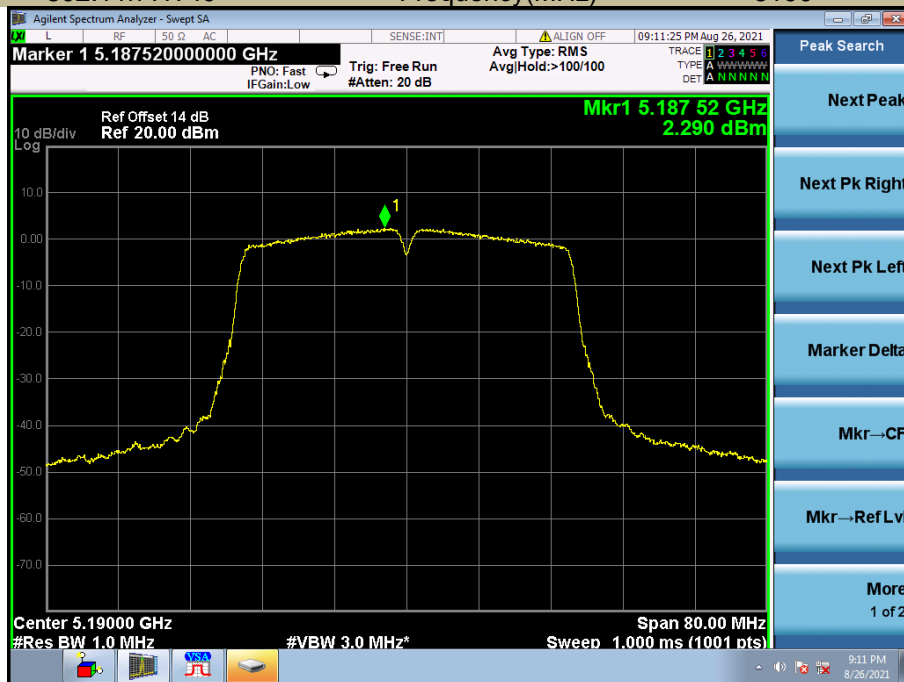



Power Spectral Density U-NII - 1  
 Test Model 802.11n-HT40 Frequency(MHz) 5230

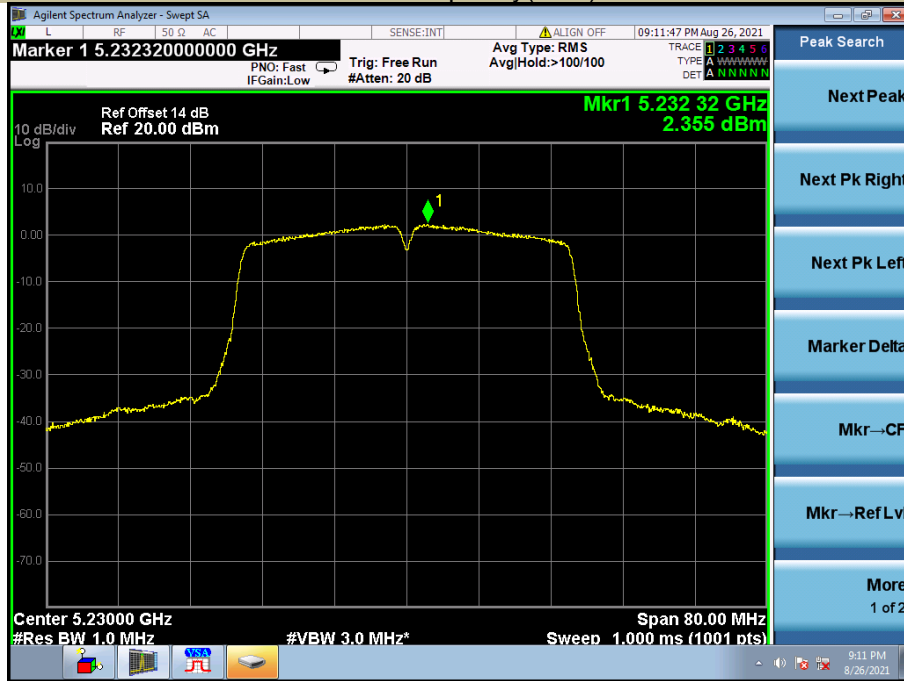

Power Spectral Density U-NII - 1  
 Test Model 802.11ac(HT40) Frequency(MHz) 5190

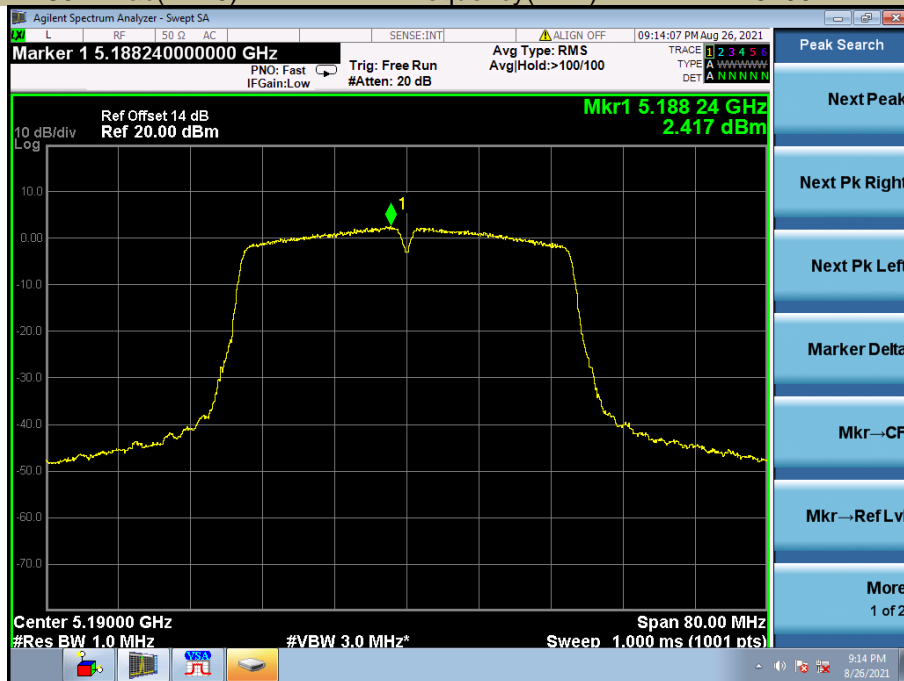



Power Spectral Density U-NII - 1  
 Test Model 802.11ac(HT40) Frequency(MHz) 5230

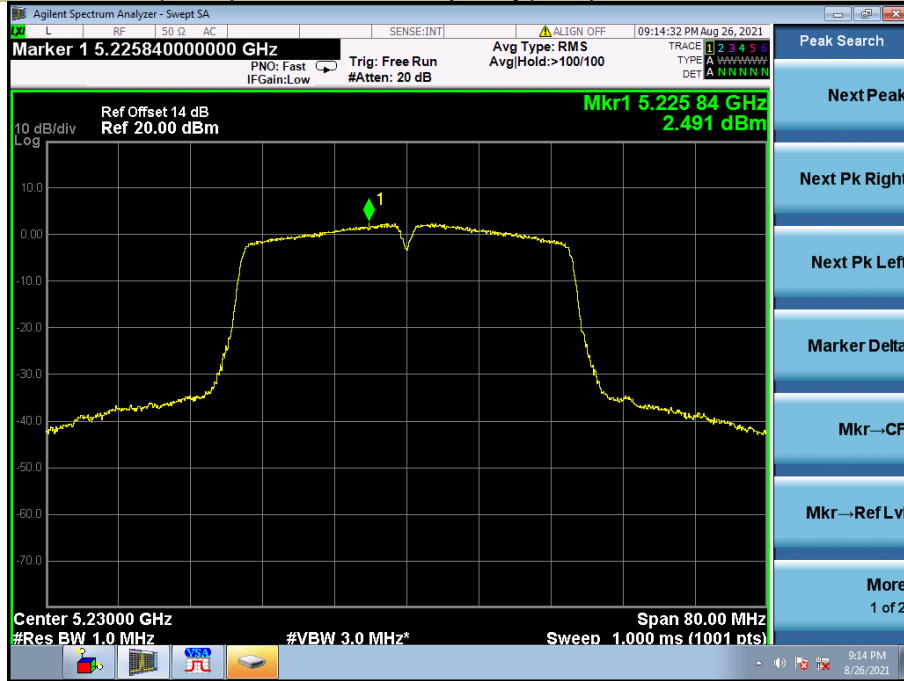

Power Spectral Density U-NII - 1  
 Test Model 802.11ac 80 Frequency(MHz) 5210

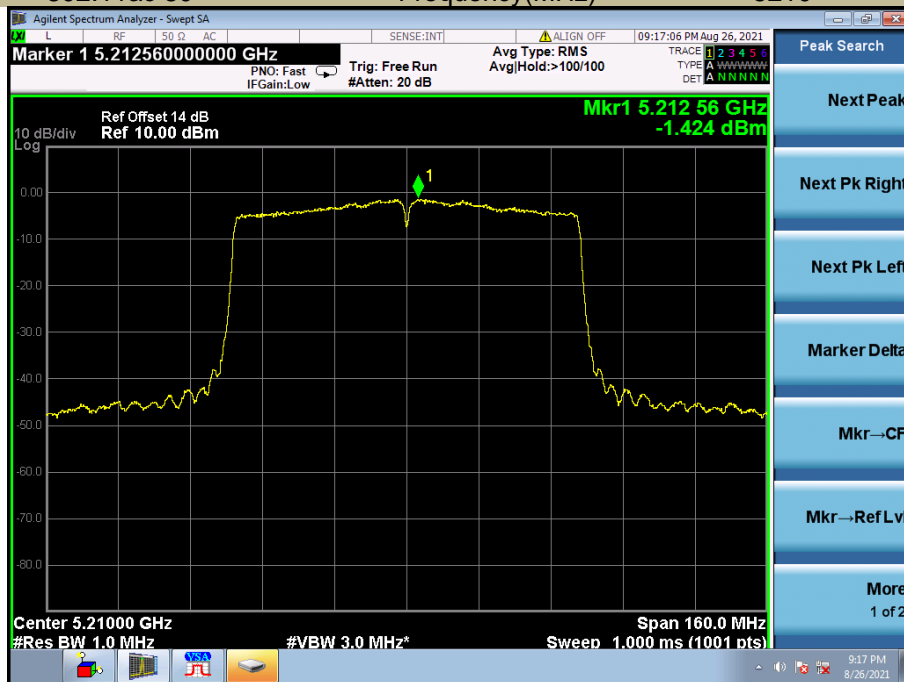

5250-5350MHz

Operating mode	Test Channel	Power Spectral Density dBm/MHz	Limit (dBm/MHz)
802.11a	5260	6.34	11
	5280	6.68	11
	5320	6.87	11
802.11n-HT20	5260	5.31	11
	5280	5.20	11
	5320	5.60	11
802.11ac(HT20)	5260	5.22	11
	5280	5.30	11
	5320	5.41	11
802.11n-HT40	5270	2.03	11
	5310	2.37	11
802.11ac(HT40)	5270	2.12	11
	5310	2.46	11
802.11ac(HT80)	5290	-1.12	11

Power Spectral Density U-NII – 2A  
 Test Model 802.11a Frequency(MHz) 5260

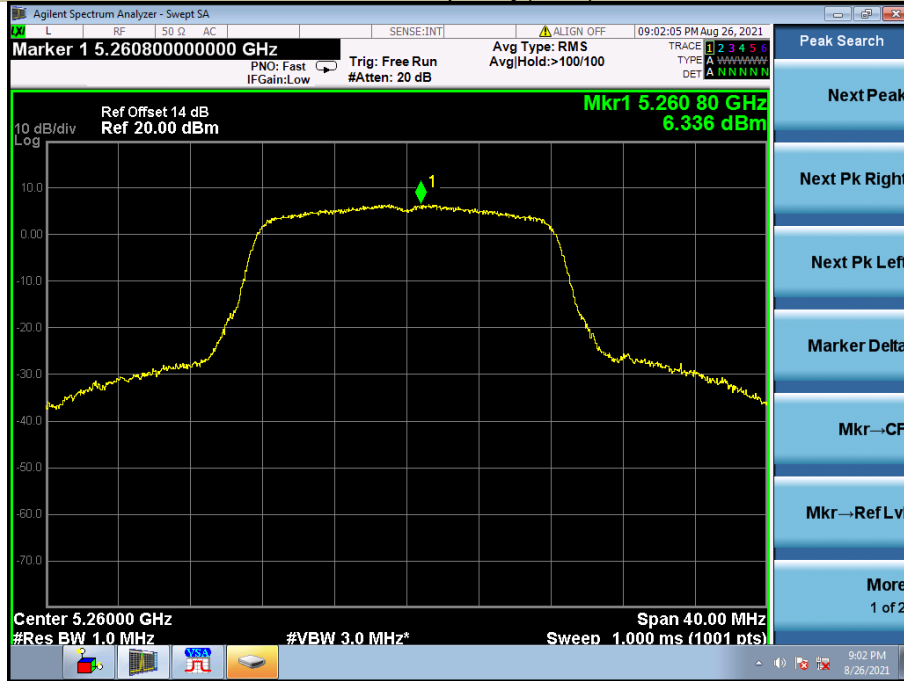

Power Spectral Density U-NII – 2A  
 Test Model 802.11a Frequency(MHz) 5280

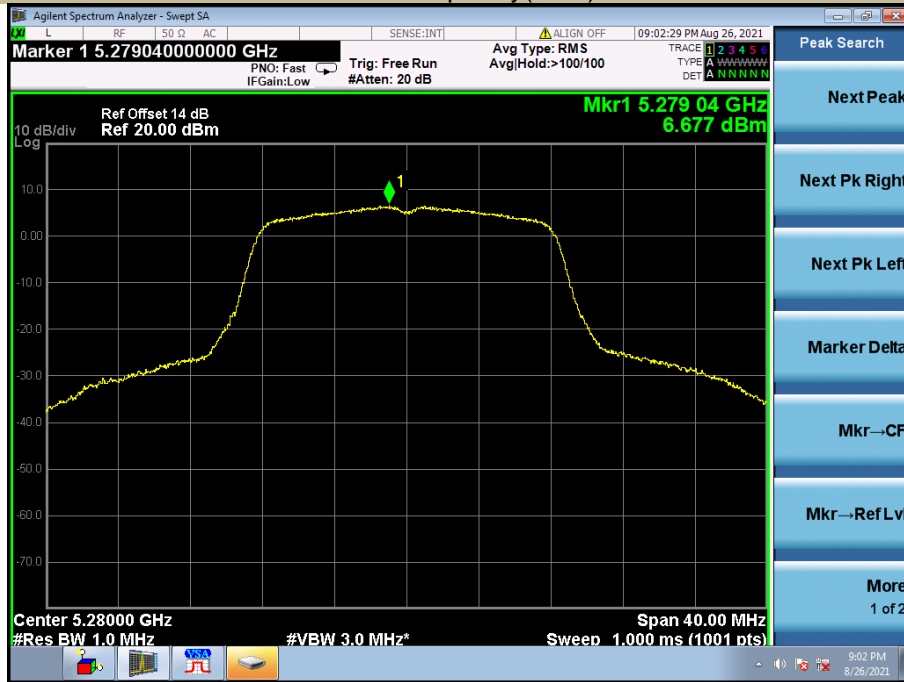

Power Spectral Density U-NII – 2A  
 Test Model 802.11a Frequency(MHz) 5320

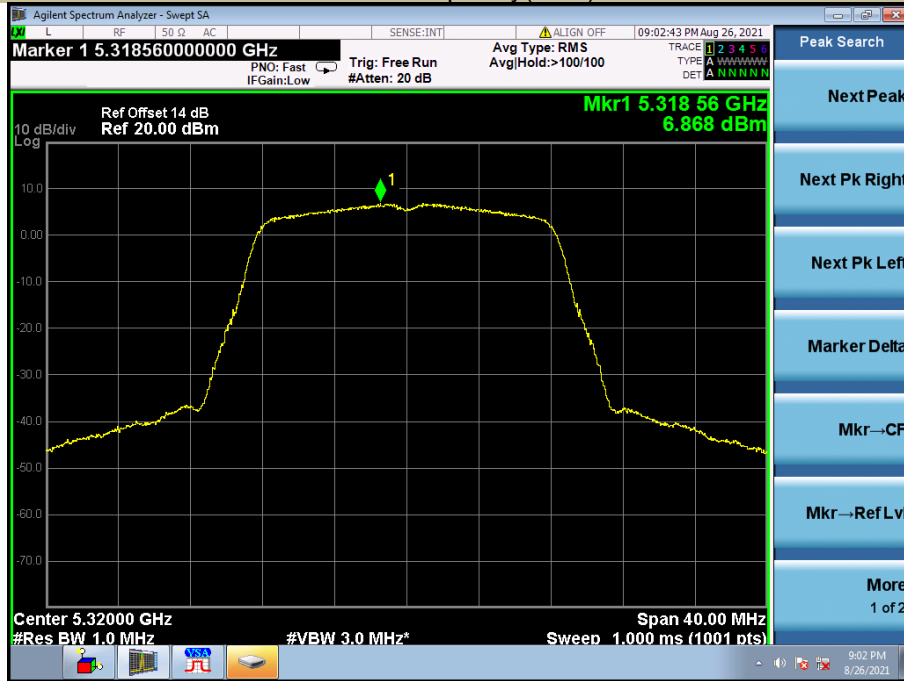

Power Spectral Density U-NII – 2A  
 Test Model 802.11n-HT20 Frequency(MHz) 5260

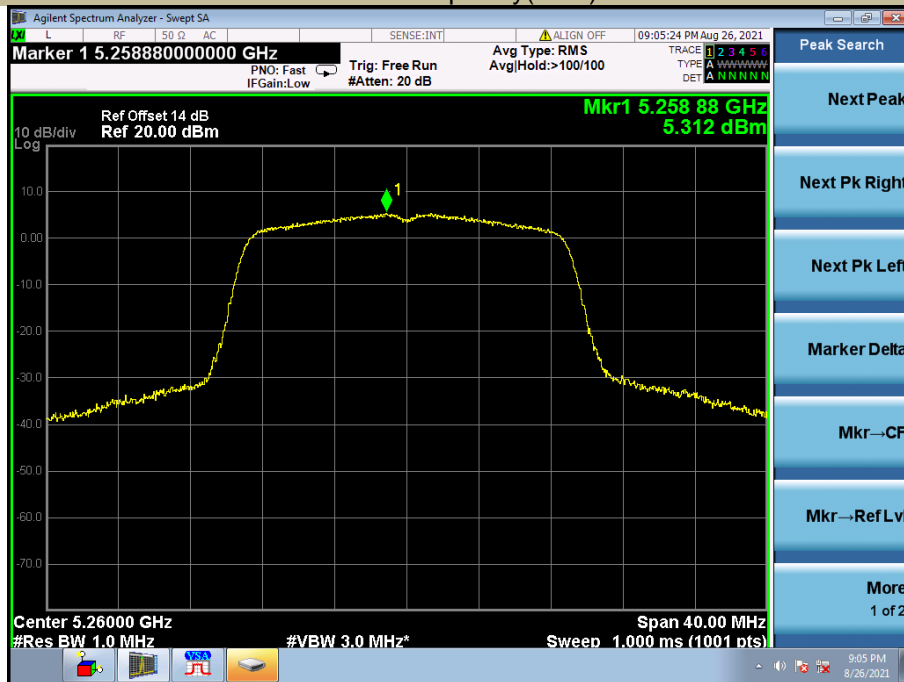

Power Spectral Density  
Test Model 802.11n-HT20

U-NII – 2A  
Frequency(MHz) 5280

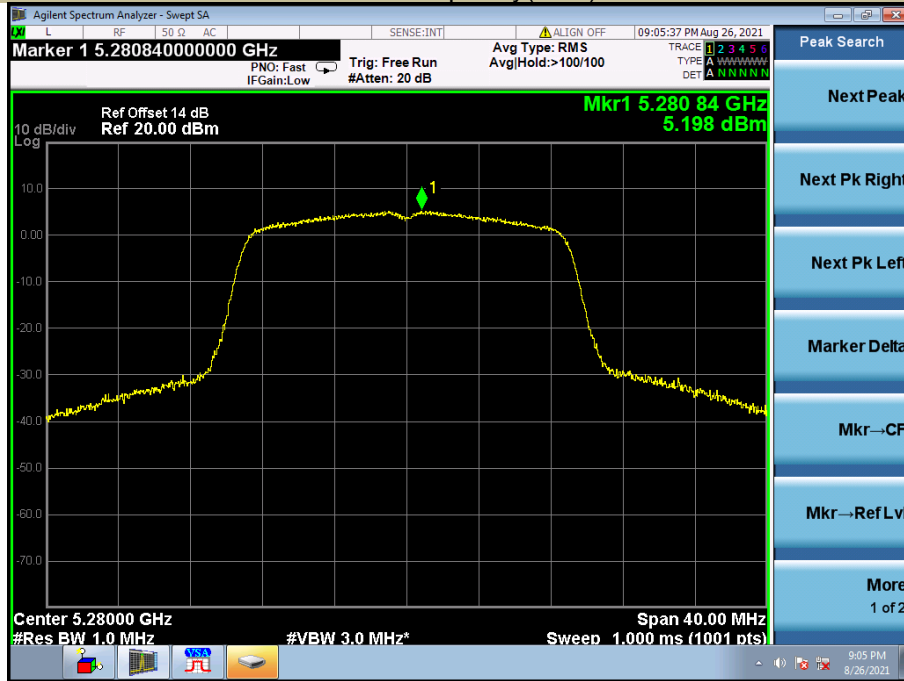

Power Spectral Density  
Test Model 802.11n-HT20

U-NII – 2A  
Frequency(MHz) 5320

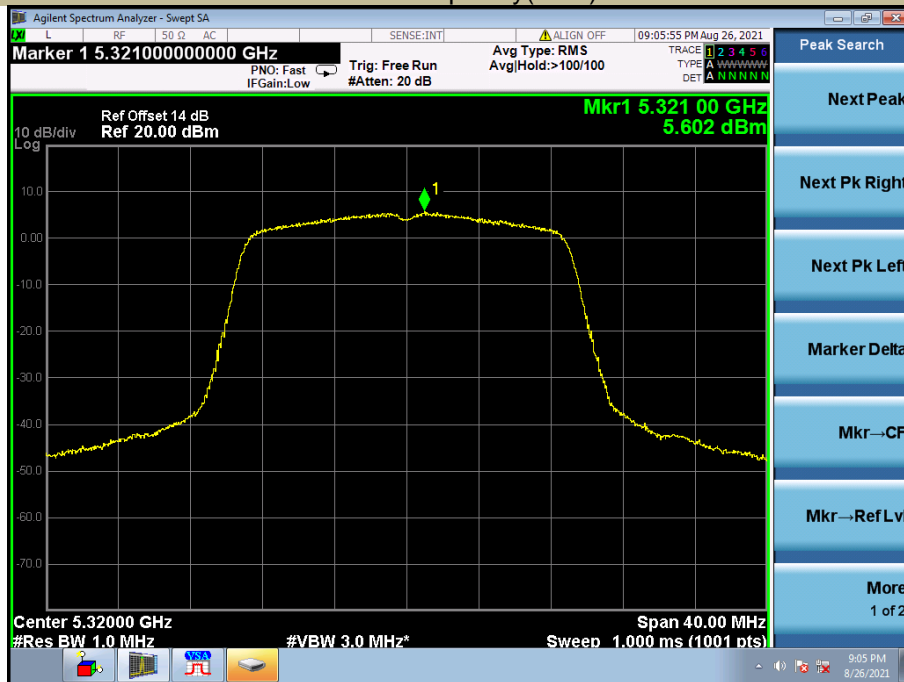

Power Spectral Density U-NII – 2A  
 Test Model 802.11ac(HT20) Frequency(MHz) 5260

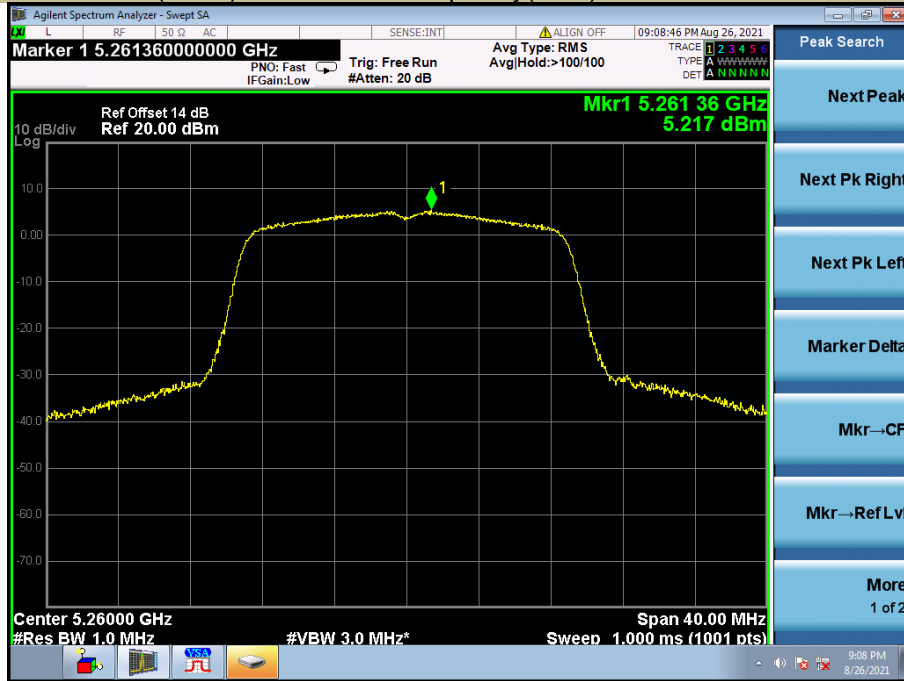

Power Spectral Density U-NII – 2A  
 Test Model 802.11ac(HT20) Frequency(MHz) 5280

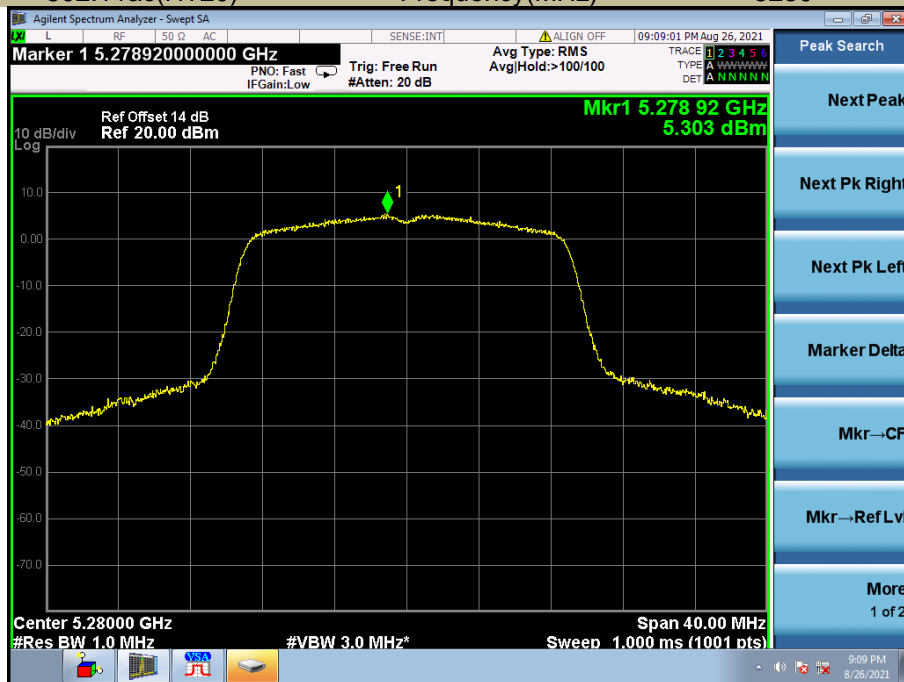

Power Spectral Density  
Test Model 802.11ac(HT20)

U-NII – 2A  
Frequency(MHz) 5320

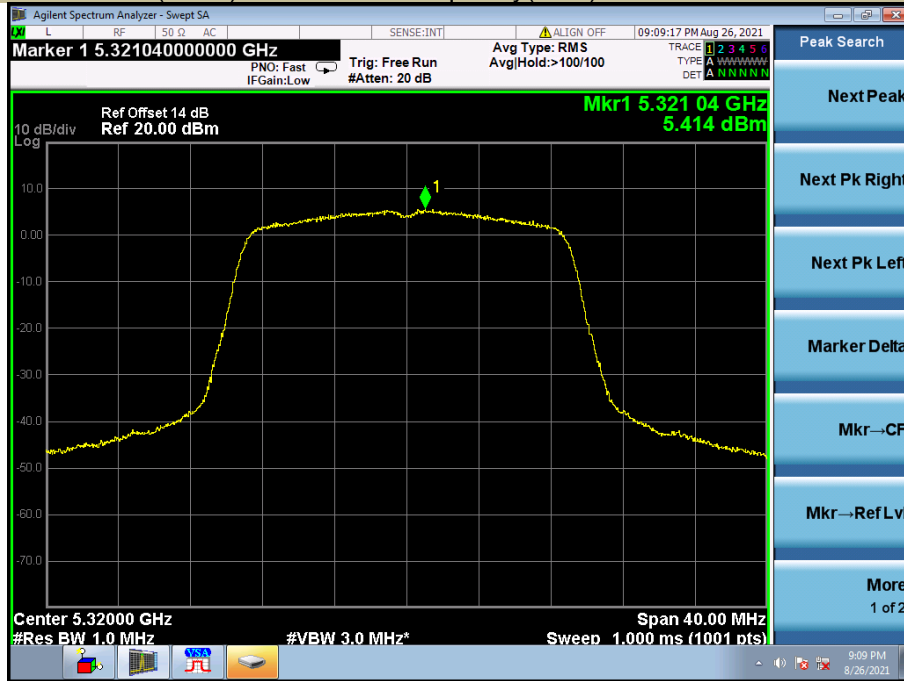

Power Spectral Density  
Test Model 802.11n-HT40

U-NII – 2A  
Frequency(MHz) 5270

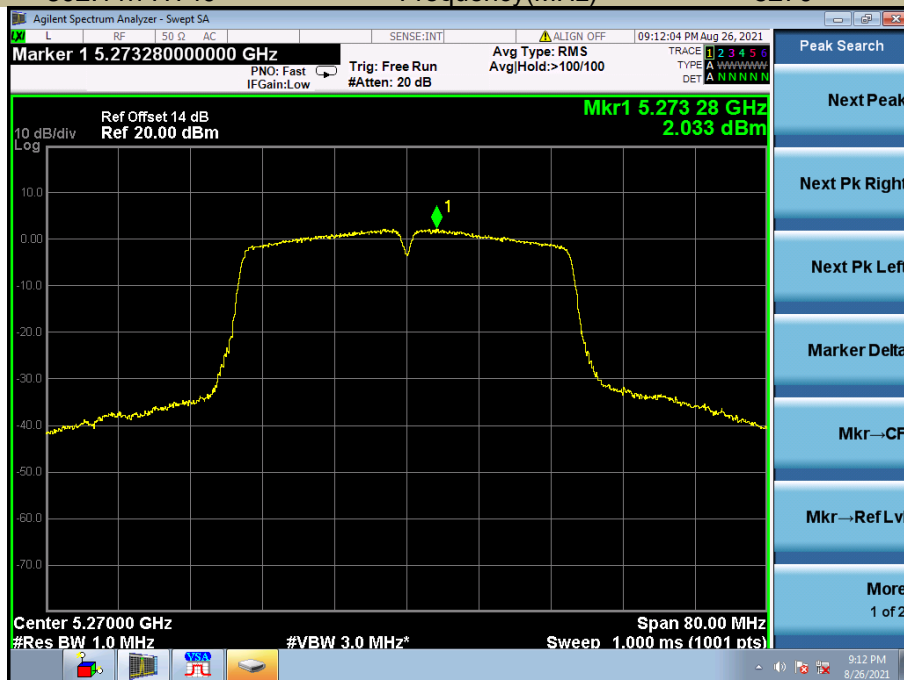

Power Spectral Density U-NII – 2A  
 Test Model 802.11n-HT40 Frequency(MHz) 5310

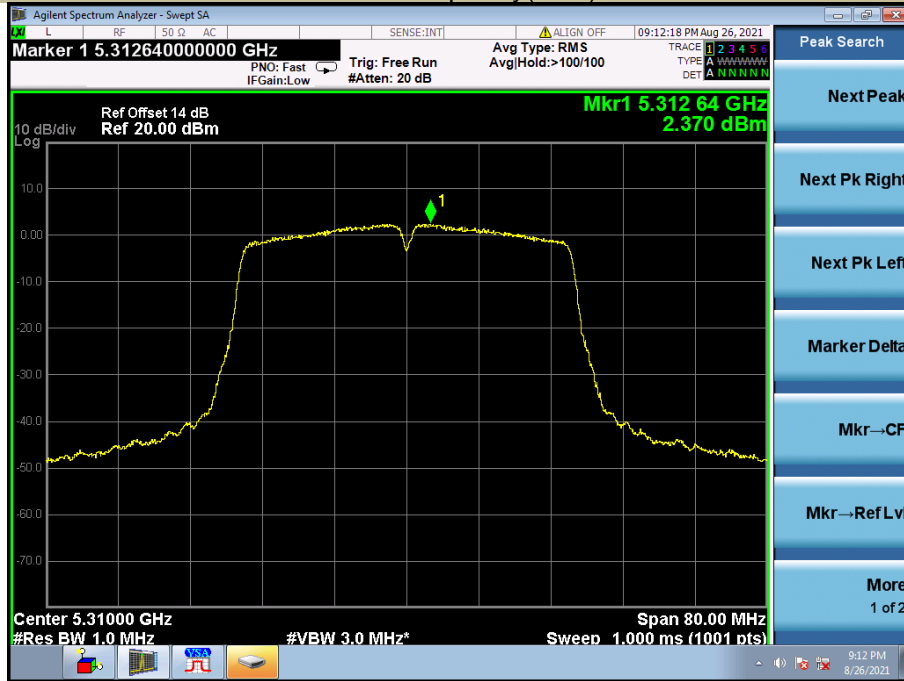

Power Spectral Density U-NII – 2A  
 Test Model 802.11ac(HT40) Frequency(MHz) 5270

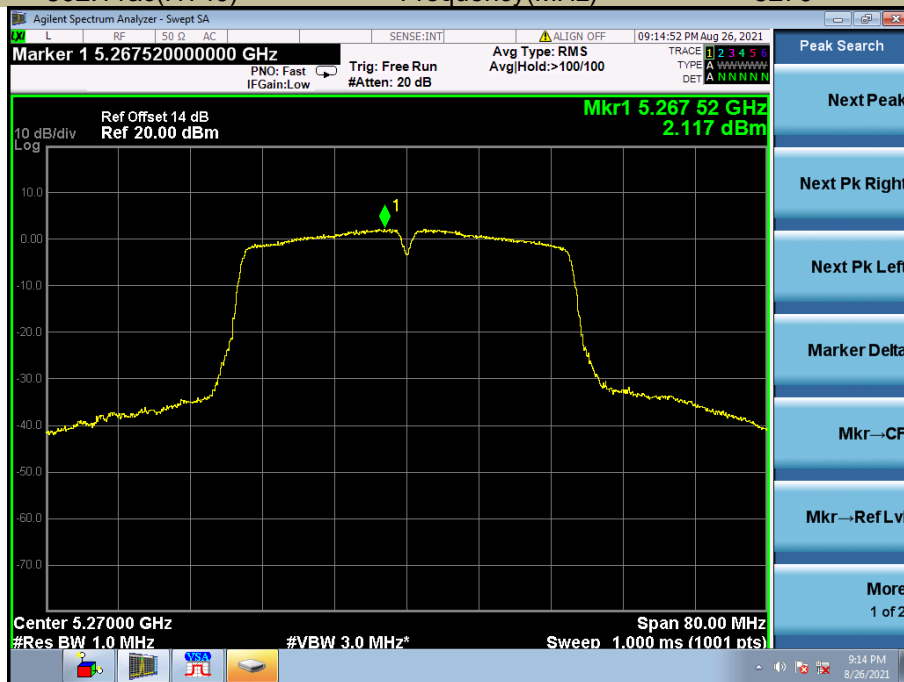



Power Spectral Density U-NII – 2A  
 Test Model 802.11ac(HT40) Frequency(MHz) 5310

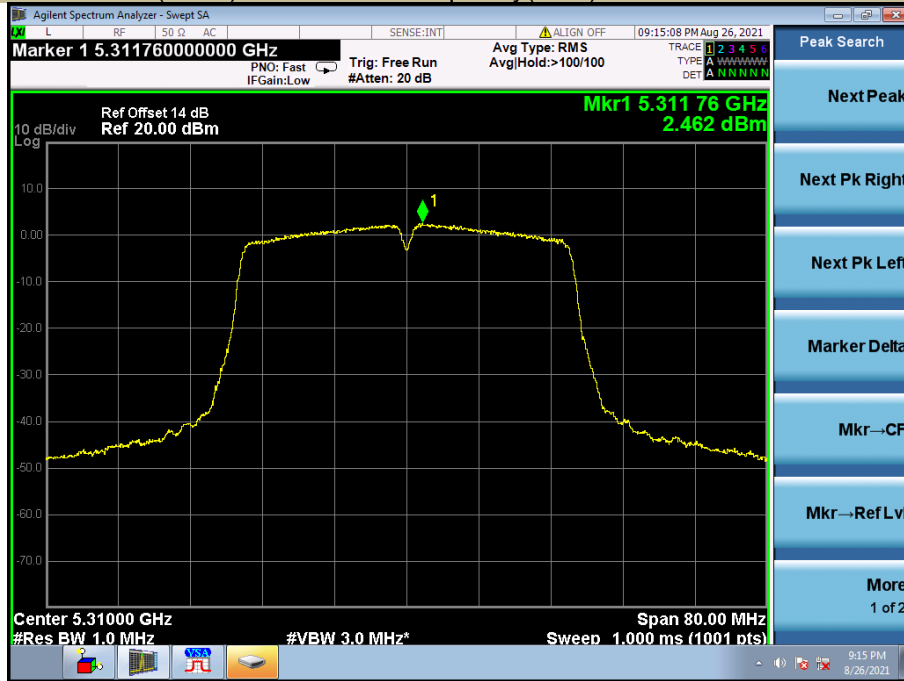

Power Spectral Density U-NII – 2A  
 Test Model 802.11ac 80 Frequency(MHz) 5290

