



243 Jubug-Ri, Yangji-Myeon, Yongin-Si, Gyeonggi-Do, Korea 17159
 Tel: +82-31-323-6008 Fax: +82-31-323-6010
<http://www.ltalab.com>

Dates of Tests: April 10 ,2023 ~ May 02 ,2023
 Test Report S/N: LR500112305C
 Test Site : LTA CO., LTD.

CERTIFICATION OF COMPLIANCE

FCC ID.	2AZKWREBL-MZ29E
APPLICANT	ATEC IoT CO., LTD.

Equipment Class	:	Digital Transmission System (DTS)
Manufacturing Description	:	Electronic Shelf Label
Manufacturer	:	SUZHOU NIHONE Electronic Technology Co., LTD
Model name	:	REBL-MZ29E
Variant Model name	:	REBL-MZ29P
Test Device Serial No.:	:	Identical prototype
Rule Part(s)	:	FCC Part 15.247 Subpart C ; ANSI C63.10 - 2013
Frequency Range	:	2405 ~ 2480 MHz Zigbee
Max. Output Power	:	Max -1.09 dBm - Conducted
Data of issue	:	May 08 ,2023

This test report is issued under the authority of:

JaBeom.Koo

Ja-Beom Koo, Manager

The test was supervised by:

Eun-Hwan Jung, Test Engineer

This test result only responds to the tested sample. It is not allowed to copy this report even partly without the allowance of the test laboratory. The report must not be used by the client to claim product certification, approval, or endorsement by NVLAP, NIST, or any agency of the Federal Government.



NVLAP LAB Code.: 200723-0

TABLE OF CONTENTS

1. GENERAL INFORMATION	-----	3
2. INFORMATION ABOUT TEST ITEM	-----	4
3. TEST REPORT	-----	5
3.1 SUMMARY OF TESTS	-----	5
3.2 TECHNICAL CHARACTERISTICS TEST	-----	6
3.2.1 6 dB BANDWIDTH	-----	6
3.2.2 PEAK OUTPUT POWER	-----	10
3.2.3 POWER SPECTRAL DENSITY	-----	13
3.2.4 BAND EDGE	-----	16
3.2.5 CONDUCTED SPURIOUS EMISSIONS	-----	19
3.2.6 RADIATED SPURIOUS EMISSIONS	-----	22
APPENDIX		
APPENDIX TEST EQUIPMENT USED FOR TESTS	-----	32

1. General information

1-1 Test Performed

Company name : LTA Co., Ltd.
 Address : 243, Jubug-ri, Yangji-Myeon, Youngin-Si, Kyunggi-Do, Korea. 17159
 Web site : <http://www.ltalab.com>
 E-mail : chahn@ltalab.com
 Telephone : +82-31-323-6008
 Facsimile : +82-31-323-6010

Quality control in the testing laboratory is implemented as per ISO/IEC 17025 which is the “General requirements for the competents of calibration and testing laboratory”.

1-2 Accredited agencies

LTA Co., Ltd. is approved to perform EMC testing by the following agencies:

Agency	Country	Accreditation No.	Validity	Reference
NVLAP	U.S.A	200723-0	2023-09-28	ECT accredited Lab.
RRA	KOREA	KR0049	-	EMC accredited Lab.
FCC	U.S.A	649054	2024-04-08	FCC CAB
VCCI	JAPAN	C-4948,	2023-09-10	VCCI registration
VCCI	JAPAN	T-2416,	2023-09-10	VCCI registration
VCCI	JAPAN	R-4483(10 m),	2023-10-15	VCCI registration
VCCI	JAPAN	G-847	2024-12-13	VCCI registration
IC	CANADA	5799A-1	2024-08-15	IC filing

2. Information about test item

2-1 Client & Manufacturer

Client Company name : ATEC IoT CO., LTD.
 Address : 289, Pangyo-ro, Bundang-gu, Seongnam-si, Gyeonggi-do, Republic of Korea
 Tel / Fax : +82-31-696-9829 / +82-31-696-9899
 Manufacturer : SUZHOU NIHONE Electronic Technology Co., LTD
 Address : No. 185,Xiaoxiang Road, Suzhou New District, Suzhou City, Jiangsu Province, P.R. China
 Tel / Fax : +82-31-696-9829 / +82-31-696-9899

2-2 Equipment Under Test (EUT)

Model name : REBL-MZ29E
 Serial number : Identical prototype
 Date of receipt : April 10 ,2023
 EUT condition : Pre-production, not damaged
 Antenna type : Pattern Antenna (Ant1 Gain : -6.56 dBi, Ant2 Gain : -6.33 dBi)
 Frequency Range : 2405 ~ 2480 MHz
 RF output power : Max -1.09 dBm – Conducted
 Type of Modulation : Pi/4 DQPSK, 8DPSK
 Power Source : DC 3 V

This product uses two antennas at one oscillation, and both antennas cannot operate at the same time, but only antennas operate at one time when transmitting.

2-3 Tested frequency

	LOW	MID	HIGH
Frequency (MHz) Zigbee	2405	2440	2480

2-4 Ancillary Equipment

Equipment	Model No.	Serial No.	Manufacturer
Notebook	-	MS-1736	MSI

3. Test Report

3.1 Summary of tests

FCC Part Section(s)	Parameter	Test Condition	Status (note 1)
15.247(a)	6 dB Bandwidth	Conducted	C
15.247(b)	Transmitter Peak Output Power		C
15.247(e)	Transmitter Power Spectral Density		C
15.247(d)	Band Edge & Conducted Spurious emission		C
15.209	Transmitter emission	Radiated	C
15.207	AC Conducted Emissions	Conducted	N/A
15.203	Antenna requirement	-	C

N/A : This product is only operated with DC voltage.

The above equipment was tested by LTA Co., Ltd. The test data, data evaluation, test procedures, and equipment configurations shown in this report were made in accordance with the procedures given in ANSI C63.10-2013 and the energy emitted by the sample EUT tested as described in this report is in compliance with the requirements of FCC Rules Part 2 and Part 15.247 The test results of this report relate only to the tested sample identified in this report.

The tests were performed according to the method of measurements prescribed in KDB No.558074.

→ Antenna Requirement

ATEC IoT CO., LTD. FCC ID: 2AZKWREBL-MZ29E unit complies with the requirement of §15.203.

The antenna type is Pattern Antenna

3.2 Technical Characteristics Test

3.2.1 6 dB Bandwidth

Procedure:

The bandwidth at 6 dB below the highest in-band spectral density was measured with a spectrum analyzer connected to the antenna terminal, while EUT is operating in transmission mode at the appropriate frequencies.

After the trace being stable, Use the marker-to-peak function to set the marker to the peak of the emission. Use the marker-delta function to measure 6 dB down one side of the emission. Reset the marker-delta function, and move the marker to the other side of the emission, until it is (as close as possible to) even with the reference marker level. The marker-delta reading at this point is the 6 dB bandwidth of the emission.

The spectrum analyzer is set to:

Center frequency = the highest, middle and the lowest channels

RBW = 100 kHz

Span = 3 X RBW

VBW = 3 X RBW

Sweep = auto

Trace = max hold

Detector function = peak

Measurement Data : Complies

Mode Ant 1

Frequency (MHz)	Test Results	
	Measured Bandwidth (MHz)	Result
2405	1.69	Complies
2440	1.70	Complies
2480	1.70	Complies

Measurement Data : Complies

Mode Ant 1

Frequency (MHz)	Test Results	
	Measured Bandwidth (MHz)	Result
2405	1.71	Complies
2440	1.69	Complies
2480	1.70	Complies

- See next pages for actual measured spectrum plots.

Minimum Standard:

6 dB Bandwidth \geq 500 kHz

Measurement Setup

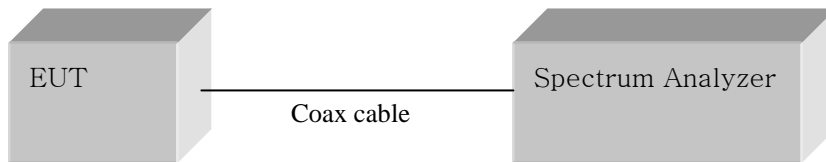
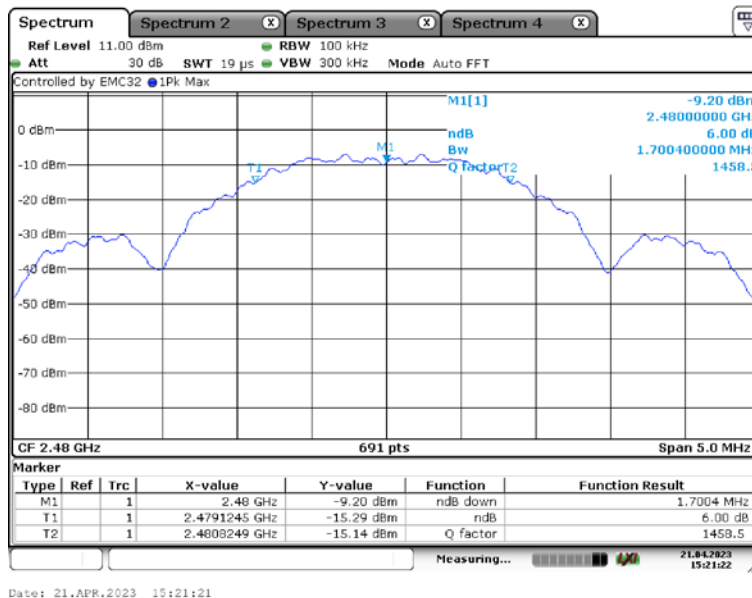
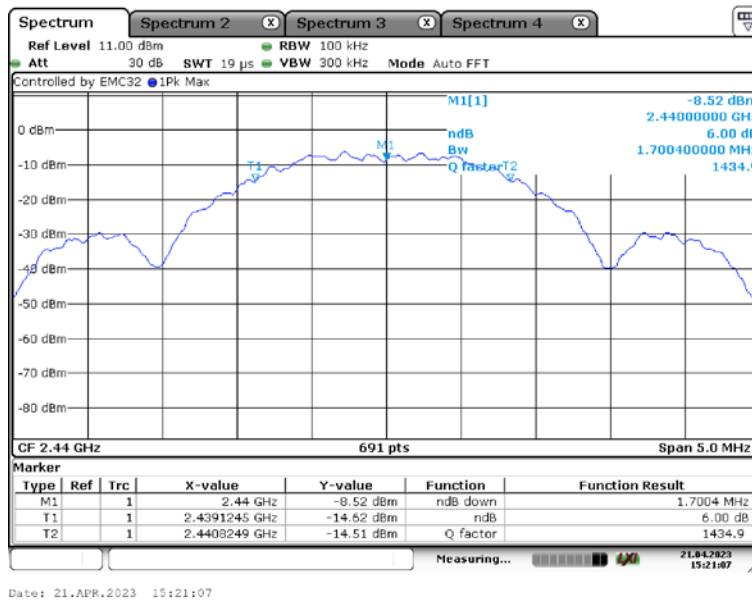
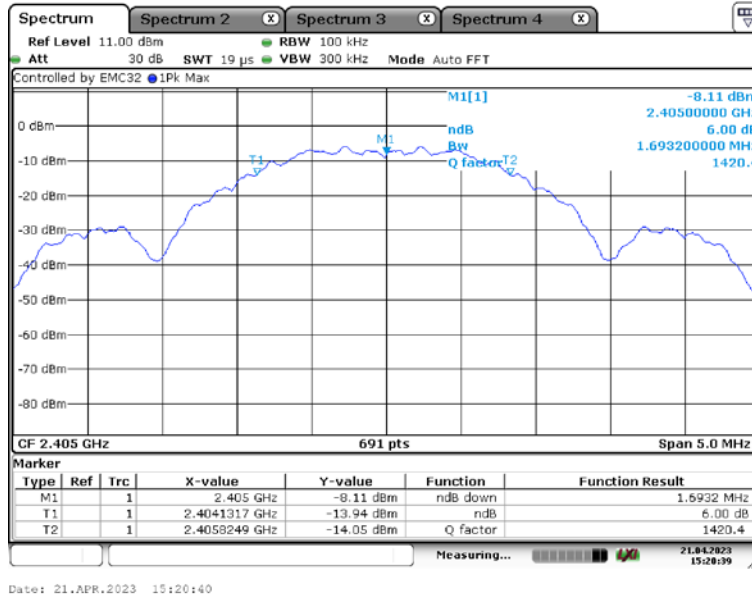
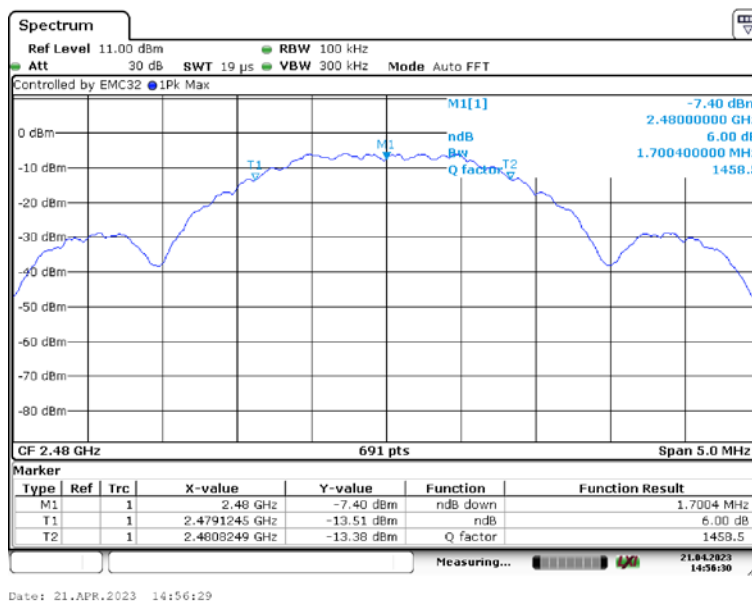
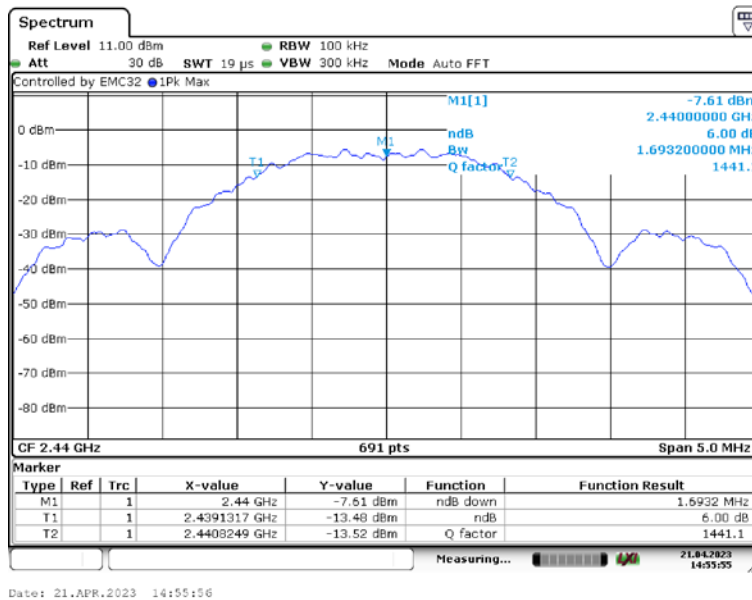
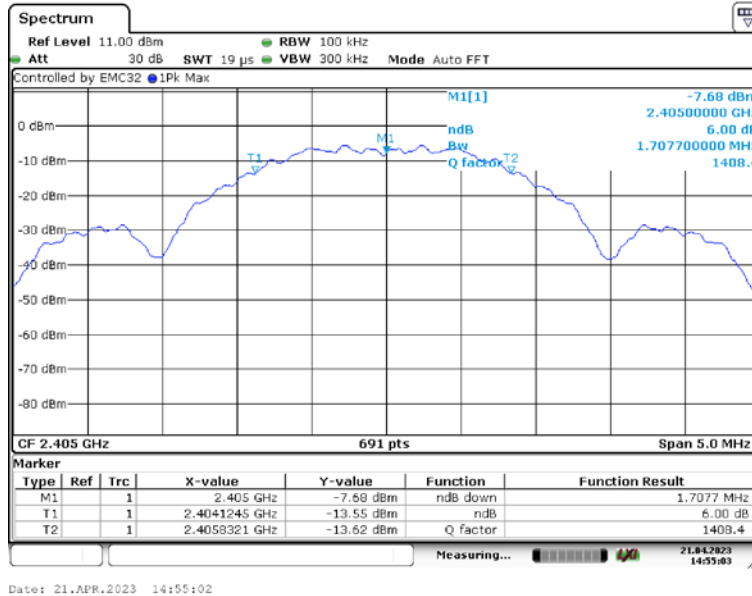

Figure 1: Measurement setup for the carrier frequency separation

Zigbee Ant1



Zigbee Ant2



3.2.2 Peak Output Power Measurement

Procedure:

The following procedure can be used when the maximum available RBW of the instrument is less than the DTS bandwidth :

The spectrum analyzer is set to:

Center frequency = the highest, middle and the lowest channels

RBW \geq DTS Bandwidth

Span \geq 3 X RBW

VBW = 3 X RBW

Sweep = auto

Detector function = peak

Measurement Data : Complies

Mode Ant 1

Frequency (MHz)	Test Results	
	Measured data (dBm)	Result
2405	-1.92	Complies
2440	-2.21	Complies
2480	-2.93	Complies

Mode Ant 2

Frequency (MHz)	Test Results	
	Measured data (dBm)	Result
2405	-1.43	Complies
2440	-1.53	Complies
2480	-1.09	Complies

- See next pages for actual measured spectrum plots.

Minimum Standard:

Peak output power	\leq 1 W(30 dBm)
-------------------	--------------------

Measurement Setup

Same as the Chapter 3.2.1 (Figure 1)

Zigbee Ant1

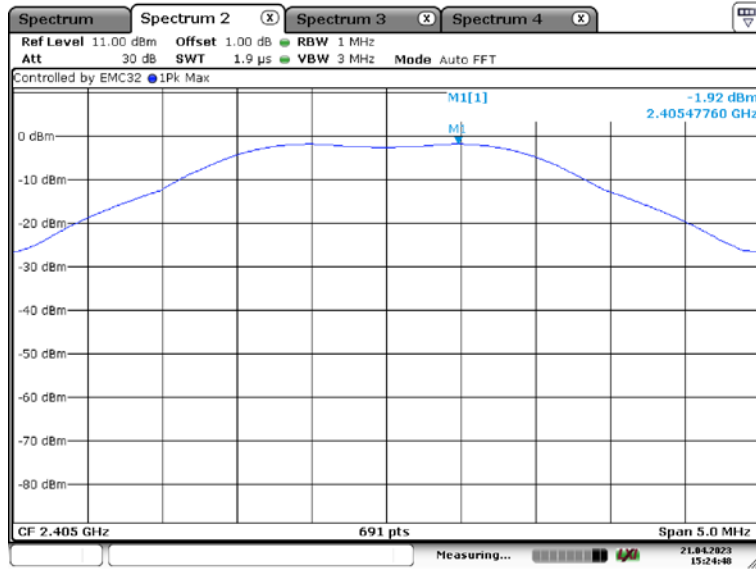

Date: 21.APR.2023 15:24:49

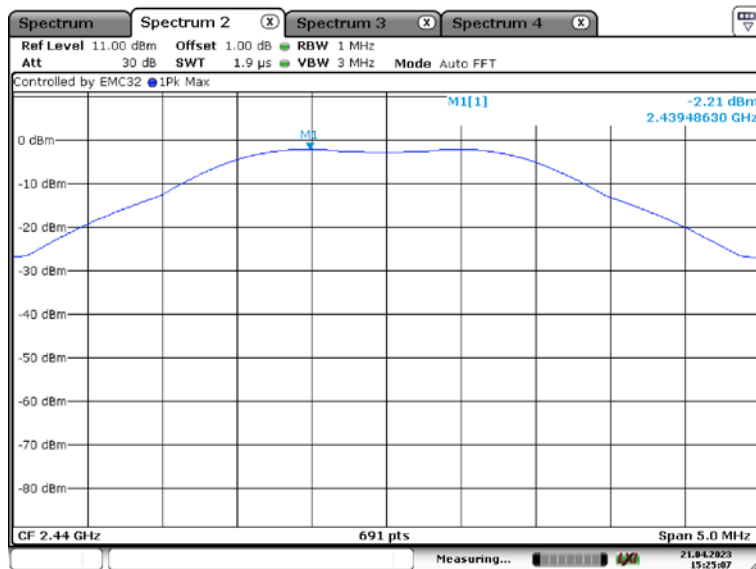

Date: 21.APR.2023 15:25:06

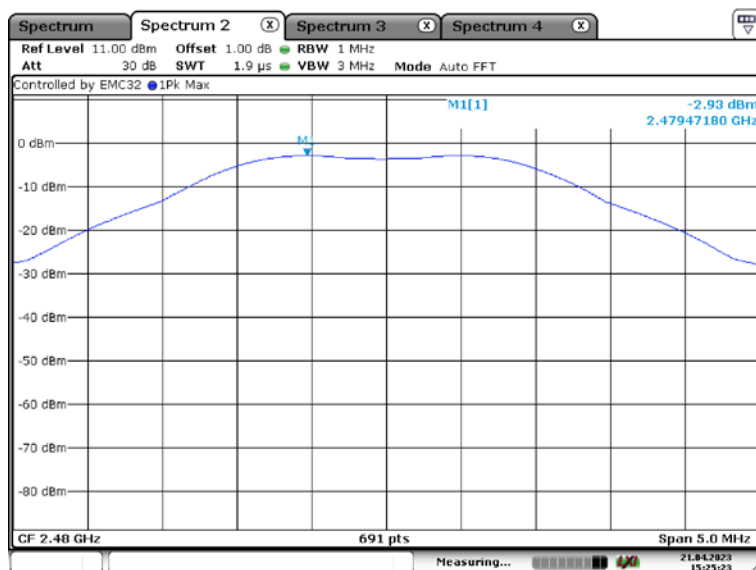

Date: 21.APR.2023 15:25:24

Zigbee Ant2

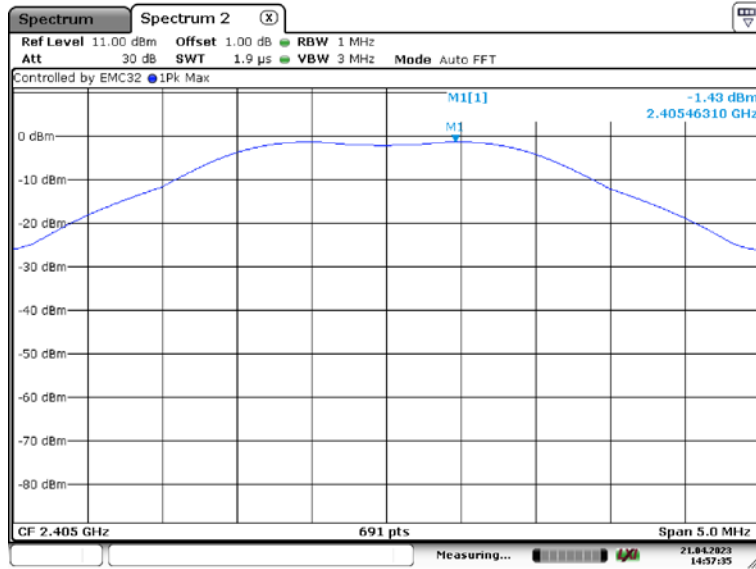

Date: 21.APR.2023 14:57:34

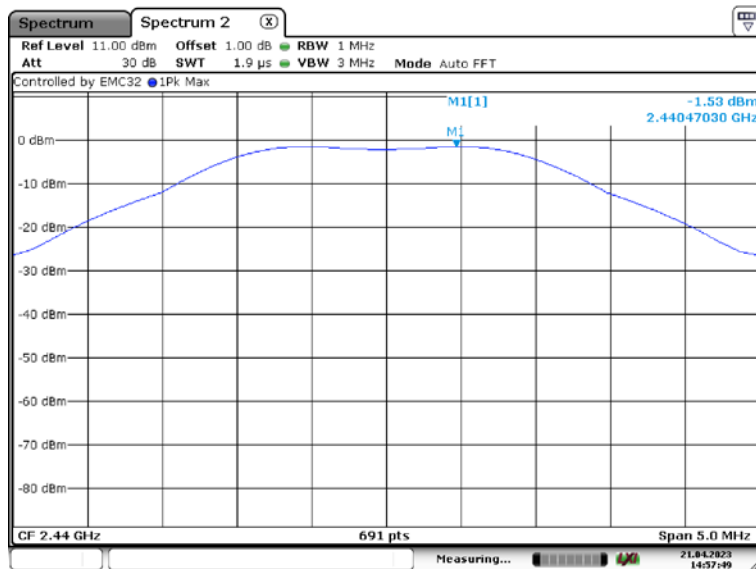

Date: 21.APR.2023 14:57:50

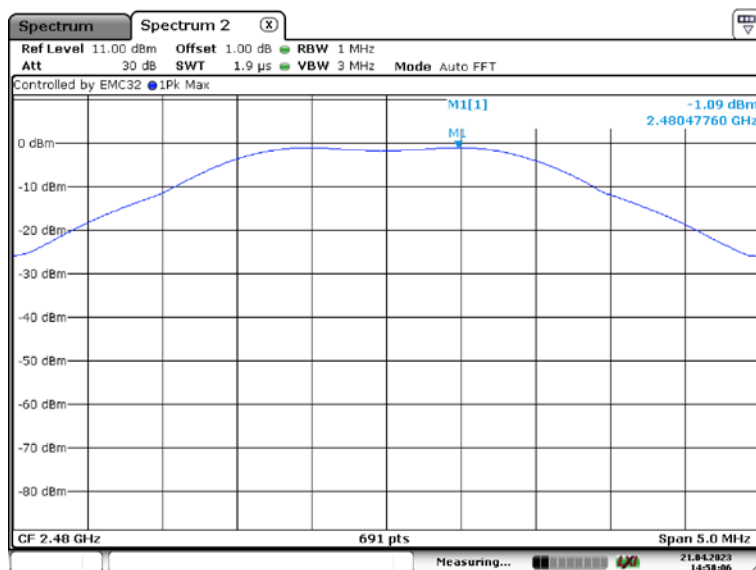

Date: 21.APR.2023 14:58:07

3.2.3 Power Spectral Density

Procedure:

This procedure shall be used if maximum peak conducted output power was used to demonstrate compliance.

The spectrum analyzer is set to:

RBW = 3 kHz ($3 \text{ kHz} \leq \text{RBW} \leq 100 \text{ kHz}$)

Span ≥ 1.5 times the DTS bandwidth

VBW = 3 X RBW

Sweep = auto

Detector function = peak

Trace = max hold

Measurement Data : Complies

Mode Ant 1

Frequency (MHz)	Test Results	
	dBm / 3 kHz BW	Result
2405	-18.15	Complies
2440	-17.92	Complies
2480	-18.25	Complies

Mode Ant 2

Frequency (MHz)	Test Results	
	dBm / 3 kHz BW	Result
2405	-15.20	Complies
2440	-16.92	Complies
2480	-16.09	Complies

- See next pages for actual measured spectrum plots.

Minimum Standard:

Power Spectral Density	$\leq 8 \text{ dBm @ } 3 \text{ kHz BW}$
------------------------	--

Measurement Setup

Same as the Chapter 3.2.1 (Figure 1)

Zigbee Ant1

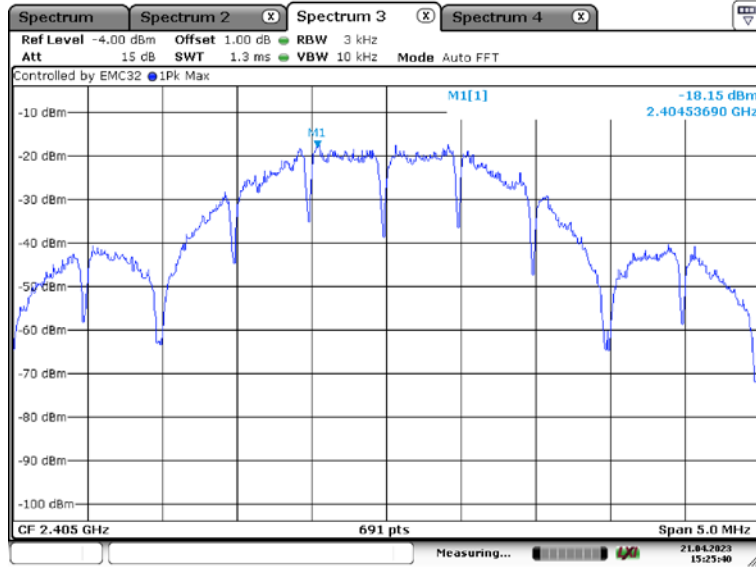

Date: 21.APR.2023 15:25:41

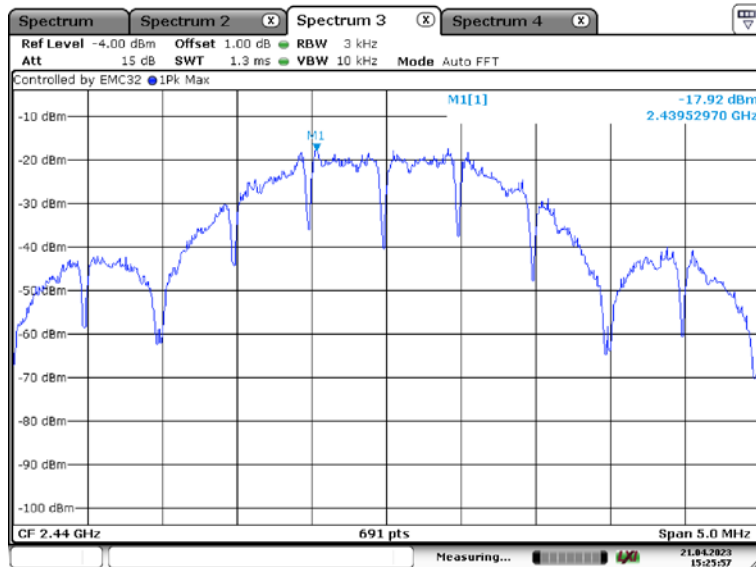

Date: 21.APR.2023 15:25:58

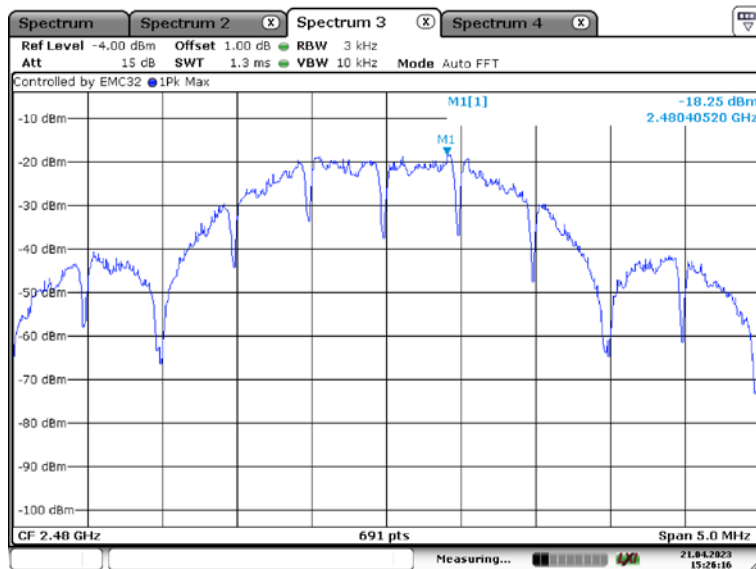

Date: 21.APR.2023 15:26:17

Zigbee Ant2

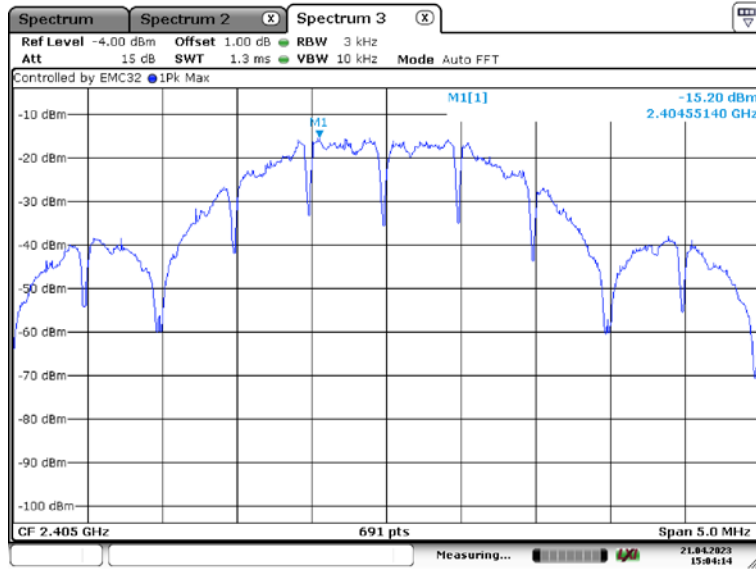

Date: 21.APR.2023 15:04:15

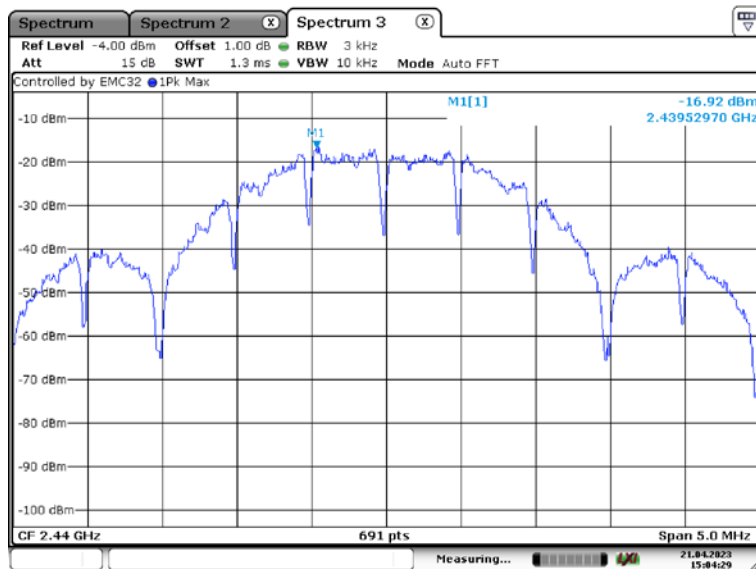

Date: 21.APR.2023 15:04:30

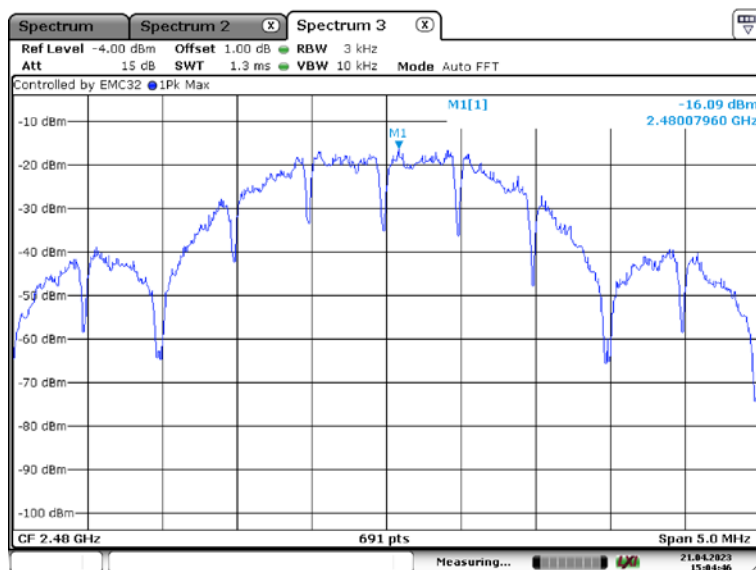

Date: 21.APR.2023 15:04:45

3.2.4 Band Edge

Procedure:

The Unwanted emission from the EUT were measured according to the dictates PKPSD measurement procedure in section 11.11 of ANSI C63.10-2013.

In any 100 kHz bandwidth outside the frequency band in which the spread spectrum or digitally modulated device is operating, the RF power that is produced shall be at least 20 dB below that in the 100 kHz bandwidth within the band that contains the highest level of the desired power, based on either an RF conducted or a radiated measurement, provided that the transmitter demonstrates compliance with the peak conducted power limits.

If the transmitter complies with the conducted power limits based on the use of root-mean-square averaging over a time interval, as permitted under Section 5.4(4), the attenuation required shall be 30 dB instead of 20 dB..

The spectrum analyzer is set to:

Center frequency = the highest, middle and the lowest channels

RBW = 100 kHz

VBW \geq 3 X RBW

Detector function = peak

Trace = max hold

Sweep = auto

Measurement Data: Complies

Ant 1

Frequency (MHz)	Test Results	
	dBc	Result
Low edge	41.25	Complies
High edge	35.71	Complies

Ant 2

Frequency (MHz)	Test Results	
	dBc	Result
Low edge	41.03	Complies
High edge	36.47	Complies

- All conducted emission in any 100 kHz bandwidth outside of the spread spectrum band was at least 20 dB lower than the highest inband spectral density. Therefore the applying equipment meets the requirement.

- See next pages for actual measured spectrum plots.

Minimum Standard:	\leq 20 dBc
--------------------------	---------------

Ant 1

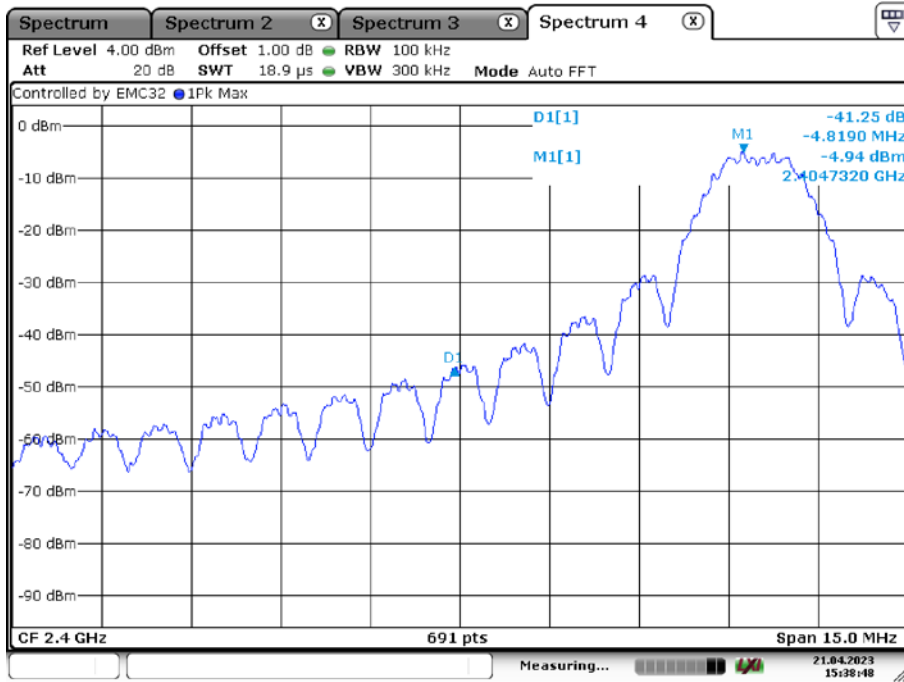

Date: 21.APR.2023 15:38:49

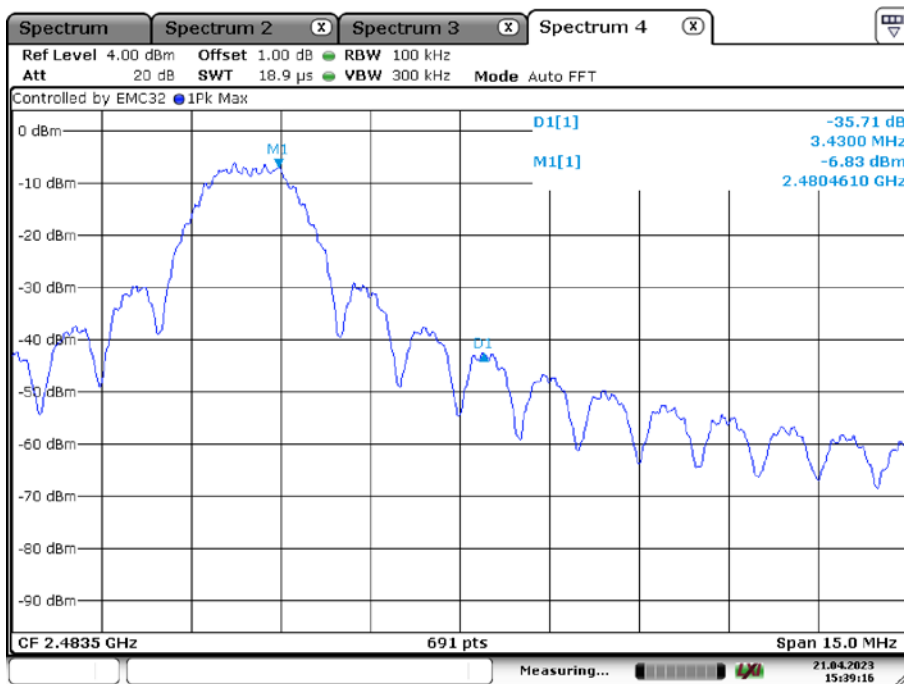

Date: 21.APR.2023 15:39:17

Ant 2

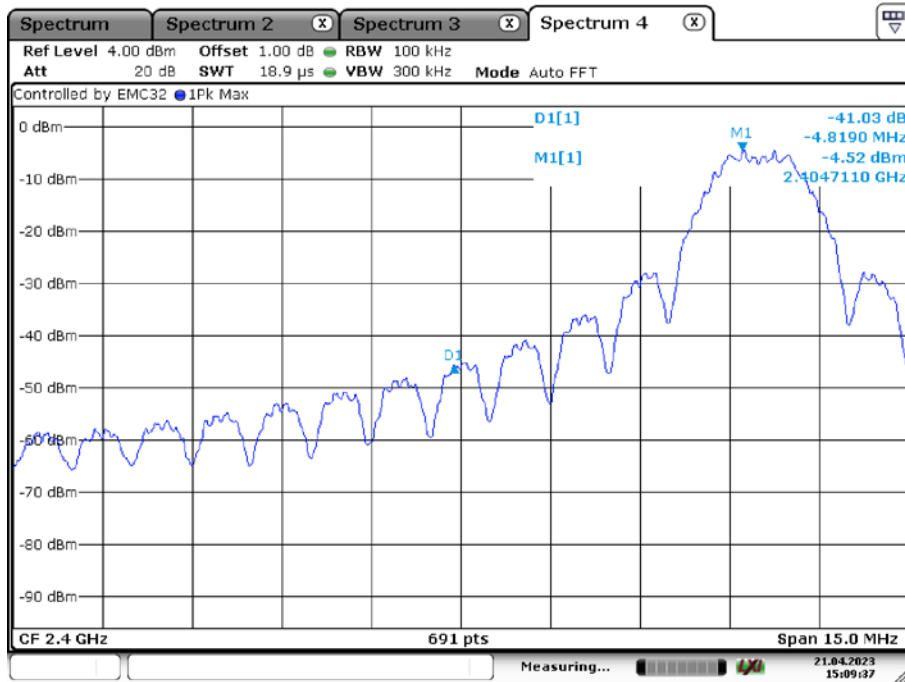

Date: 21.APR.2023 15:09:38

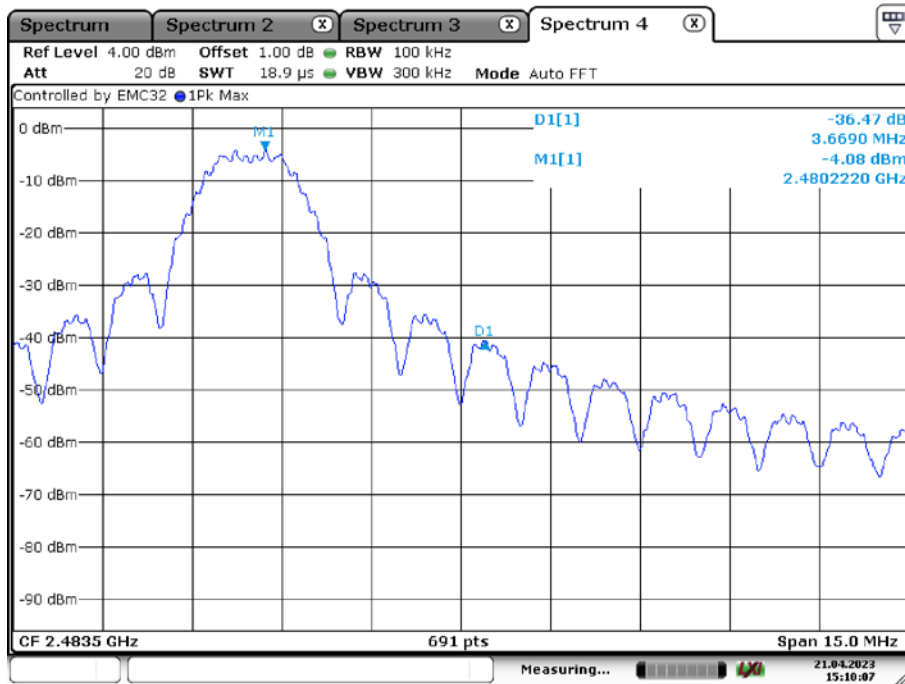

Date: 21.APR.2023 15:10:08

3.2.5 Conducted Spurious Emissions

Procedure:

The test follows KDB558074. The conducted spurious emissions were measured with a spectrum analyzer connected to the antenna terminal, while EUT had its hopping function disabled at the highest, middle and the lowest available channels.

After the trace being stable, set the marker on the peak of any spurious emission recorded.

The spectrum analyzer is set to:

Span = wide enough to capture the peak level of the in-band emission and all spurious emissions

RBW = 100 kHz

Sweep = auto

VBW = 100 kHz

Detector function = peak

Trace = max hold

Measurement Data: Complies

Ant1

Frequency (MHz)	Test Results	
	dBc	Result
2405	47.35	Complies
2440	45.43	Complies
2480	48.48	Complies

Ant2

Frequency (MHz)	Test Results	
	dBc	Result
2405	50.83	Complies
2440	51.60	Complies
2480	54.05	Complies

- All conducted emission in any 100 kHz bandwidth outside of the spread spectrum band was at least 20 dB lower than the highest inband spectral density. Therefore the applying equipment meets the requirement.
- See next pages for actual measured spectrum plots.

Minimum Standard:	≥ 20 dBc
--------------------------	---------------

Measurement Setup

Same as the Chapter 3.2.1 (Figure 1)

Unwanted Emission – Ant1 (Low,Middle,High)

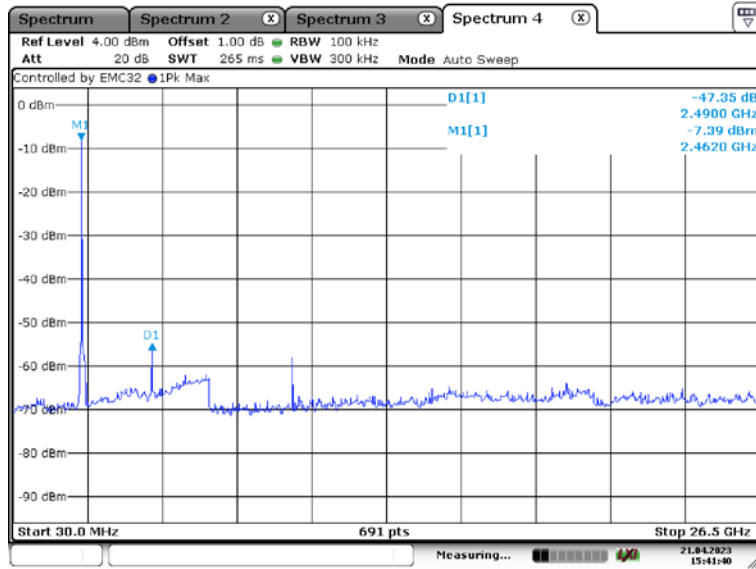

Date: 21.APR.2023 15:41:41

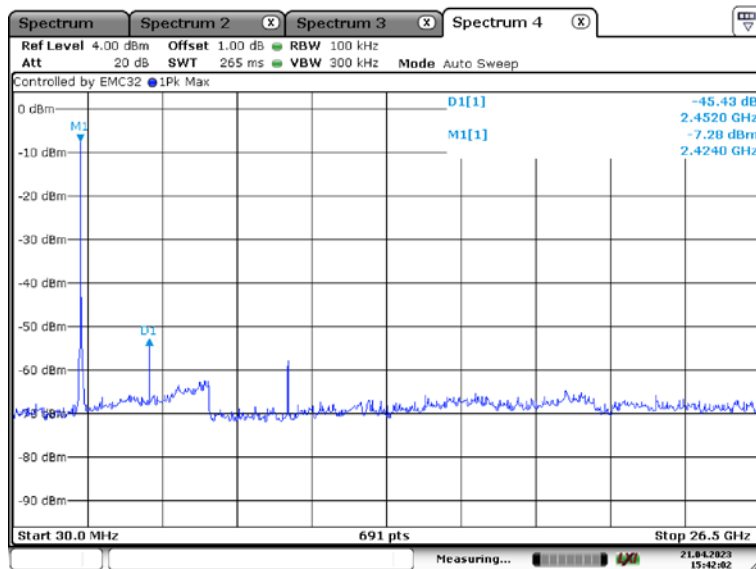

Date: 21.APR.2023 15:42:03

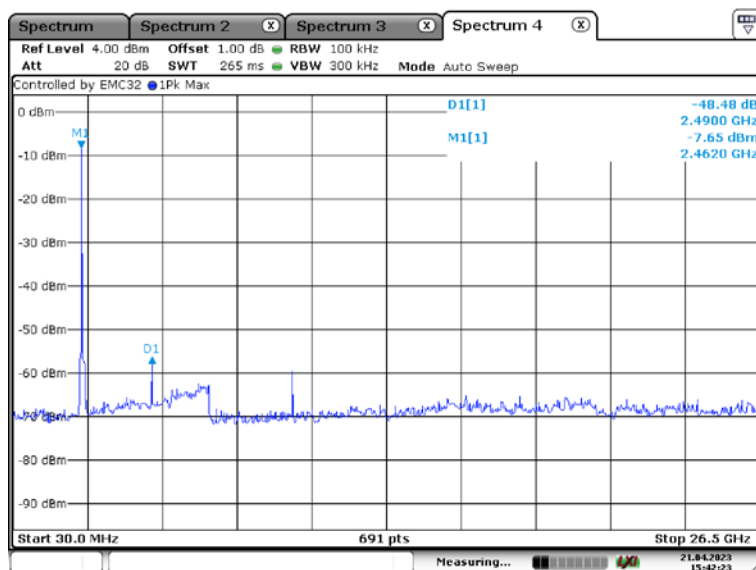

Date: 21.APR.2023 15:42:24

Unwanted Emission – Ant2 (Low,Middle,High)

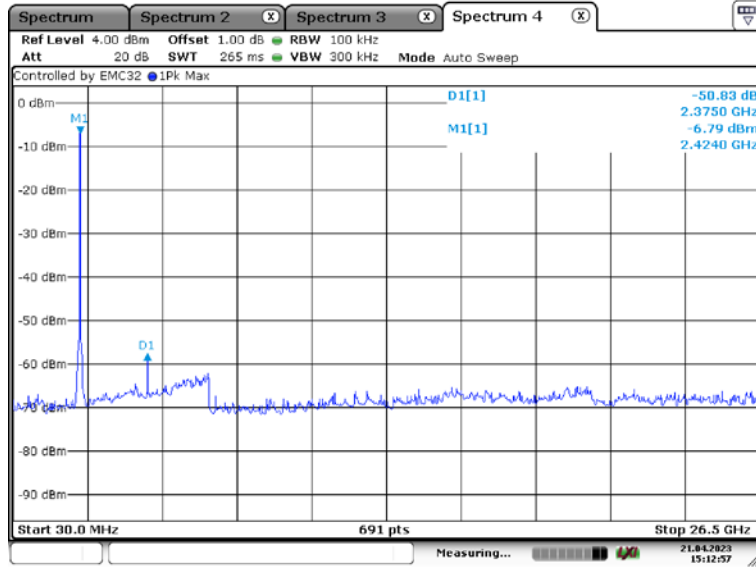

Date: 21.APR.2023 15:12:58

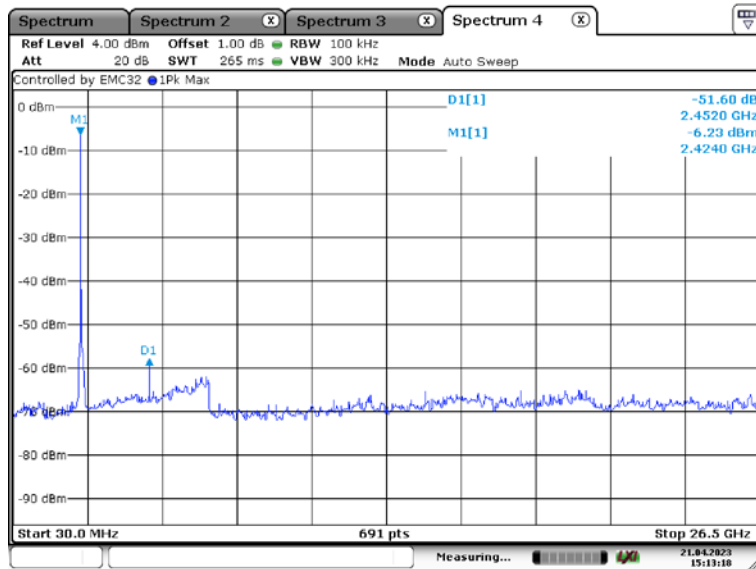

Date: 21.APR.2023 15:13:19

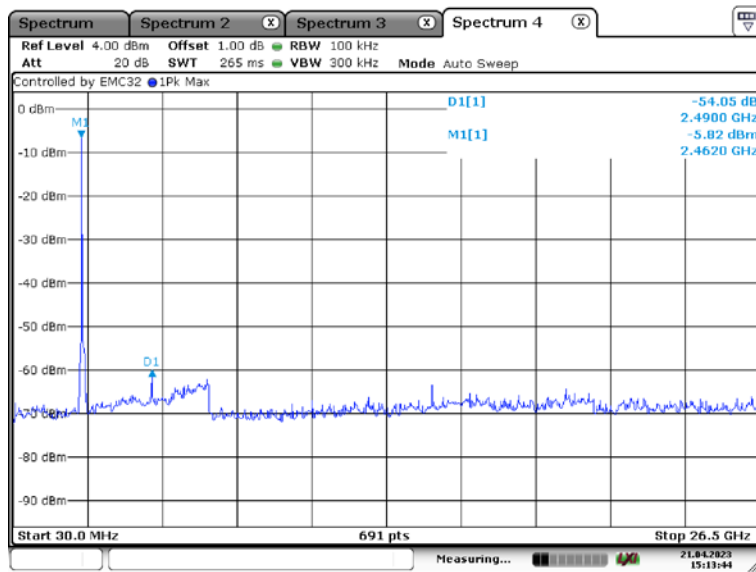

Date: 21.APR.2023 15:13:45

3.2.6 Radiated Spurious Emissions

Procedure:

Radiated emissions from 30 MHz to 25 GHz were measured according to the methods defines in ANSI C63.10-2013.

The EUT is a placed on as turn table. For emissions testing at or below 1 GHz, the table height shall be 0.8 m above the reference ground plane. For emission measurements above 1 GHz, the table height shall be 1.5 m. The turn table shall rotate 360 degrees to determine the position of maximum emission level. EUT is set 3m away from the receiving antenna which varied from 1m to 4m to find out the highest emission. And also, each emission was to be maximized by changing the polarization of receiving antenna both horizontal and vertical. In order to find out the max. emission, the relative positions of this hand-held transmitter (EUT) was rotated through three orthogonal axes and measurement procedures for electric field radiated emissions above 1 GHz the EUT measurement is to be made “while keeping the antenna in the ‘cone of radiation’ from that area and pointed at the area both in azimuth and elevation, with polarization oriented for maximum response.” is still within the 3dB illumination BW of the measurement antenna.

The spectrum analyzer is set to:

Center frequency = the worst channel

Frequency Range = 9 kHz ~ 10th harmonic.

RBW = 120 kHz (30 MHz ~ 1 GHz)

VBW \geq RBW

= 1 MHz (1 GHz ~ 10th harmonic)

Trace = max hold

Detector function = peak

Sweep = auto

Duty cycle : 98.89 %

The EUT configureal to transmit continuously(D \geq 98%)/ Duty Factor = 0

below 30 MHz

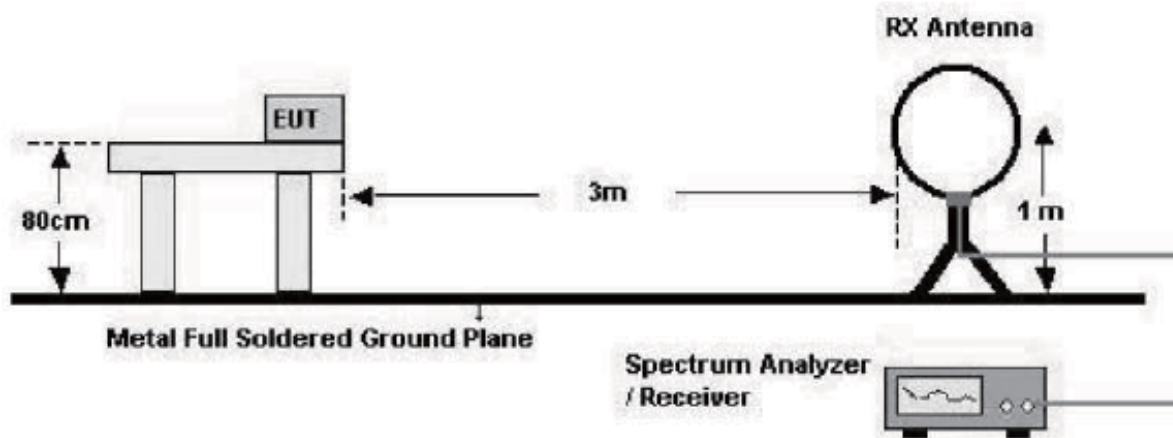

below 1 GHz (30 MHz to 1 GHz)

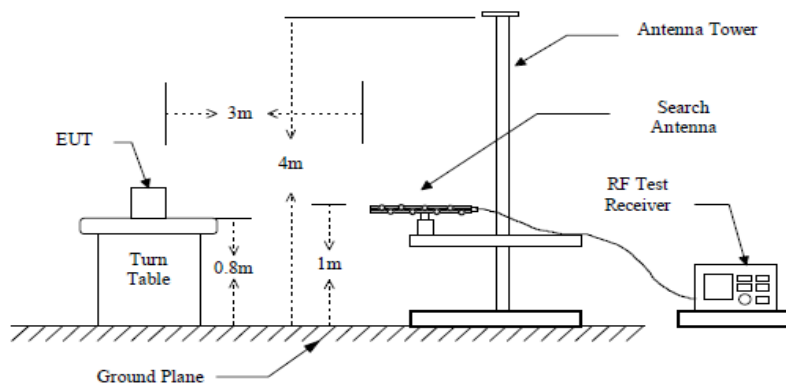

above 1 GHz

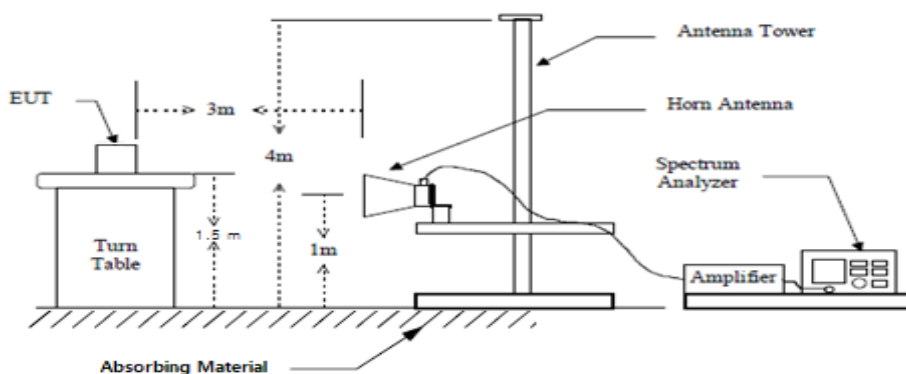

Measurement Data: Complies

- See next pages for actual measured data.
- No other emissions were detected at a level greater than 20 dB below limit include from 9 kHz to 30MHz.
- The test results for the worst of the various operating modes are presented in accordance with 6.3.4 of ANSI C63.10.
- Checked with a red circle is the fundamental frequency.

Minimum Standard: FCC Part 15.209(a)

Frequency (MHz)	Limit (uV/m) @ 3 m
0.009 ~ 0.490	2400/F(kHz) (@ 30 m)
0.490 ~ 1.705	24000/F(kHz) (@ 30 m)
1.705 ~ 30	30(@ 30 m)
30 ~ 88	100 **
88 ~ 216	150 **
216 ~ 960	200 **
Above 960	500

** Except as provided in 15.209(g), fundamental emissions from intentional radiators operating under this Section shall not be located in the frequency bands 54-72 MHz, 76-88 MHz, 174-216 MHz or 470-806 MHz. However, operation within these frequency bands is permitted under other sections of this Part, e.g. 15.231 and 15.241.

Radiated Emissions – Zigbee An1

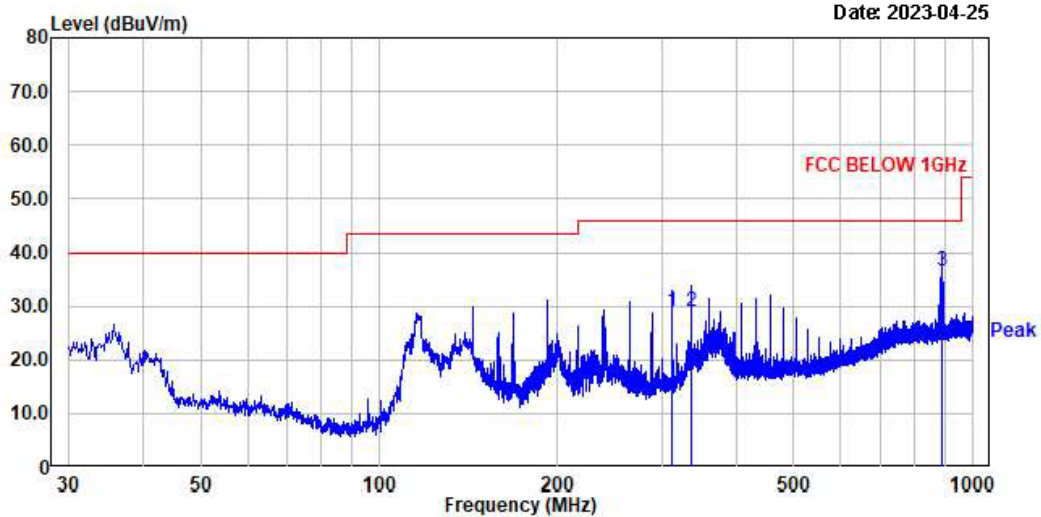

No.	Freq MHz	Reading dBμV	C.F dB	Result QP dBμV/m	Limit dBμV/m	Margin dB	Height cm	Angle deg	Polarity
1.	312.03	38.41	-9.47	28.94	46.00	17.06	-----	-----	horizontal
2.	336.04	37.71	-8.83	28.88	46.00	17.12	-----	-----	horizontal
3.	888.09	34.50	2.12	36.62	46.00	9.38	-----	-----	horizontal

Remarks: C.F (Correction Factor) = Antenna factor + Cable loss - Preamp gain

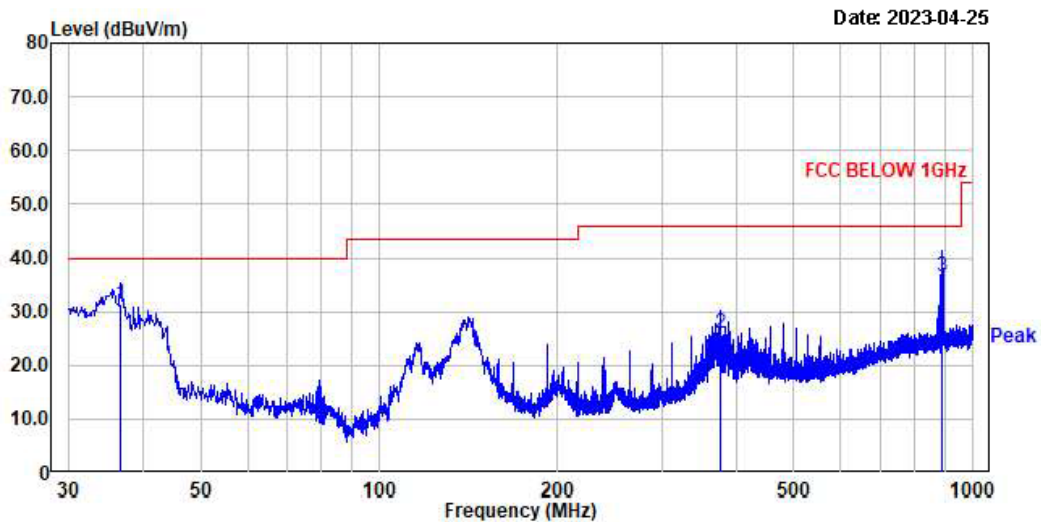

No.	Freq MHz	Reading dBμV	C.F dB	Result QP dBμV/m	Limit dBμV/m	Margin dB	Height cm	Angle deg	Polarity
1.	36.55	45.00	-13.74	31.26	40.00	8.74	-----	-----	vertical
2.	376.05	34.11	-8.08	26.03	46.00	19.97	-----	-----	vertical
3.	888.09	35.00	1.46	36.46	46.00	9.54	-----	-----	vertical

Remarks: C.F (Correction Factor) = Antenna factor + Cable loss - Preamp gain

Date: 2023-04-25

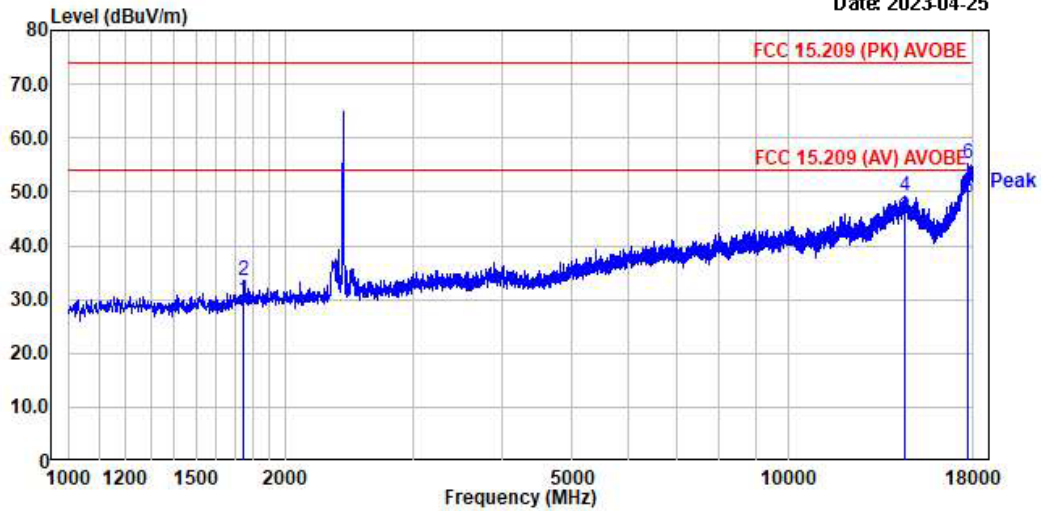

No.	Freq MHz	RD		C.F dB	Result		Limit		Margin		Height cm	Angle deg	Polarity
		PK dBμV	AV dBμV		PK dBμV	AV dBμV	PK dB	AV dB					
2.	1750.13	40.29	36.49	-6.63	33.66	29.86	74.00	54.00	40.34	24.14	100	266	horizontal
4.	14515.00	30.20	26.40	18.95	49.15	45.35	74.00	54.00	24.85	8.65	100	216	horizontal
6.	17783.25	30.87	24.60	24.32	55.19	48.92	74.00	54.00	18.81	5.08	100	328	horizontal

Remarks: C.F (Correction Factor) = Antenna factor + Cable loss - Preamp gain

Date: 2023-04-25

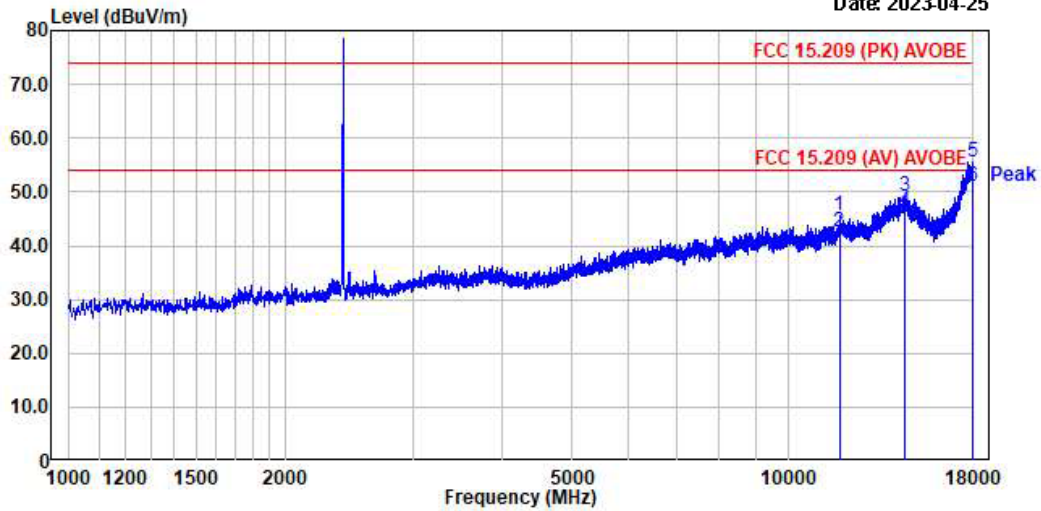

No.	Freq MHz	RD		C.F dB	Result		Limit		Margin		Height cm	Angle deg	Polarity
		PK dBμV	AV dBμV		PK dBμV	AV dBμV	PK dB	AV dB					
1.	11758.88	31.72	-----	13.94	45.66	-----	74.00	-----	28.34	-----	100	299	vertical
2.	11758.88	-----	28.60	13.94	-----	42.54	-----	54.00	-----	11.46	100	299	vertical
3.	14512.88	30.11	-----	18.96	49.07	-----	74.00	-----	24.93	-----	100	235	vertical
4.	14512.88	-----	27.39	18.96	-----	46.35	-----	54.00	-----	7.65	100	235	vertical
5.	17989.38	31.19	-----	24.46	55.65	-----	74.00	-----	18.35	-----	100	254	vertical
6.	17989.38	-----	26.70	24.46	-----	51.16	-----	54.00	-----	2.84	100	254	vertical

Remarks: C.F (Correction Factor) = Antenna factor + Cable loss - Preamp gain

Date: 2023-04-26

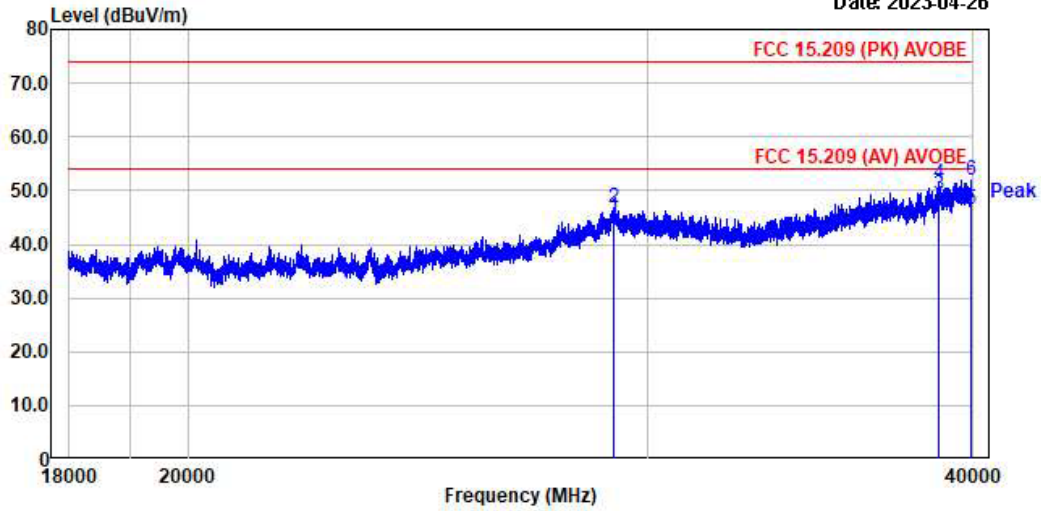

No.	Freq	RD	RD	C.F	Result	Result	Limit	Limit	Margin	Margin	Height	Angle	Polarity
	MHz	PK	AV	dB	PK	AV	PK	AV	PK	AV	cm	deg	
2.	29143.88	22.15	28.38	24.64	46.79	44.94	74.88	54.88	27.21	9.86	188	8	horizontal
4.	38828.58	26.93	24.78	24.54	51.47	49.24	74.88	54.88	22.53	4.76	188	253	horizontal
6.	39975.25	25.52	28.18	26.42	51.94	46.52	74.88	54.88	22.86	7.48	188	8	horizontal

Remarks: C.F (Correction Factor) = Antenna factor + Cable loss - Preamp gain

Date: 2023-04-26

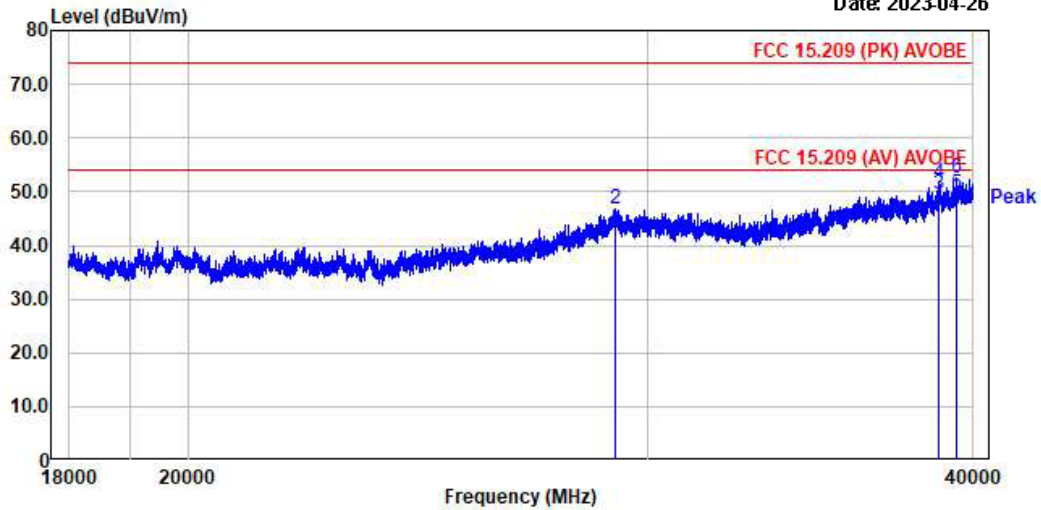

No.	Freq	RD	RD	C.F	Result	Result	Limit	Limit	Margin	Margin	Height	Angle	Polarity
	MHz	PK	AV	dB	PK	AV	PK	AV	PK	AV	cm	deg	
2.	29189.75	22.67	18.48	24.22	46.89	42.62	74.88	54.88	27.11	11.38	188	368	vertical
4.	38858.58	26.94	24.91	24.66	51.68	49.57	74.88	54.88	22.48	4.43	188	271	vertical
6.	39439.88	26.21	23.18	26.27	52.48	49.37	74.88	54.88	21.52	4.63	188	368	vertical

Remarks: C.F (Correction Factor) = Antenna factor + Cable loss - Preamp gain

Radiated Emissions – Zigbee Ant 2

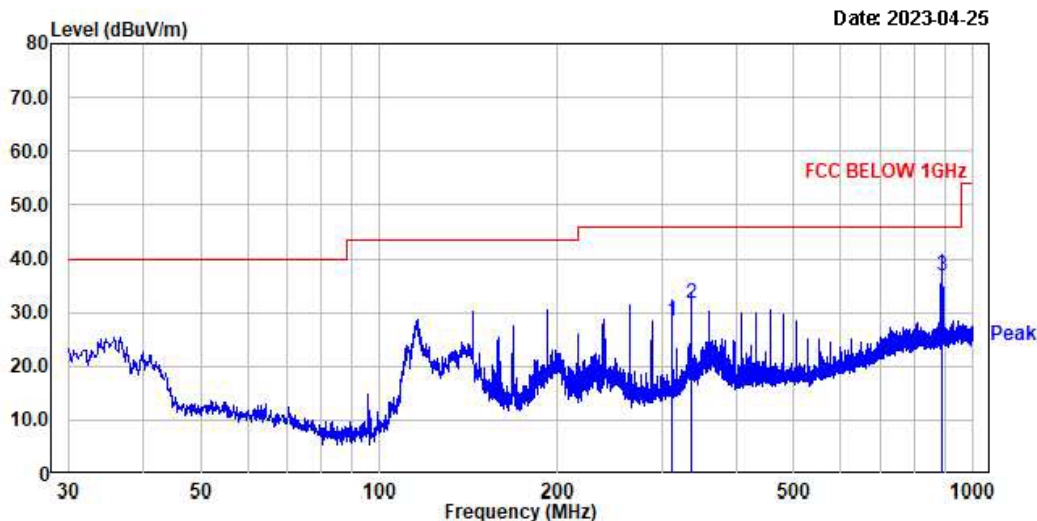

No.	Freq MHz	Reading dBμV	C.F dB	Result QP dBμV/m	Limit dBμV/m	Margin dB	Height cm	Angle deg	Polarity
1.	312.03	37.71	-9.47	28.24	46.00	17.76	-----	-----	horizontal
2.	336.04	40.61	-8.83	31.78	46.00	14.22	-----	-----	horizontal
3.	888.09	34.60	2.12	36.72	46.00	9.28	-----	-----	horizontal

Remarks: C.F (Correction Factor) = Antenna factor + Cable loss - Preamp gain

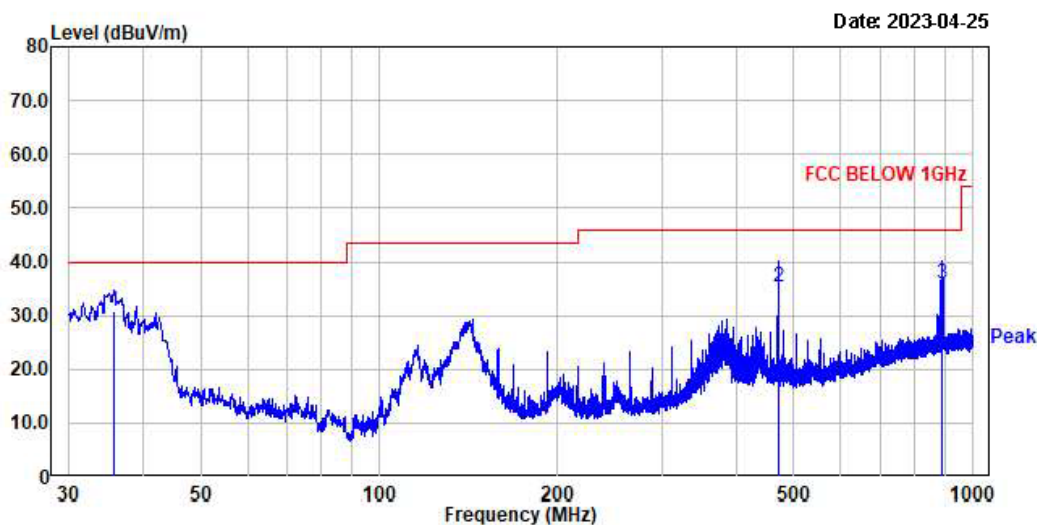

No.	Freq MHz	Reading dBμV	C.F dB	Result QP dBμV/m	Limit dBμV/m	Margin dB	Height cm	Angle deg	Polarity
1.	35.82	44.69	-13.91	30.78	40.00	9.22	-----	-----	vertical
2.	470.02	41.90	-6.64	35.26	46.00	10.74	-----	-----	vertical
3.	888.21	34.51	1.46	35.97	46.00	10.03	-----	-----	vertical

Remarks: C.F (Correction Factor) = Antenna factor + Cable loss - Preamp gain

Date: 2023-04-25

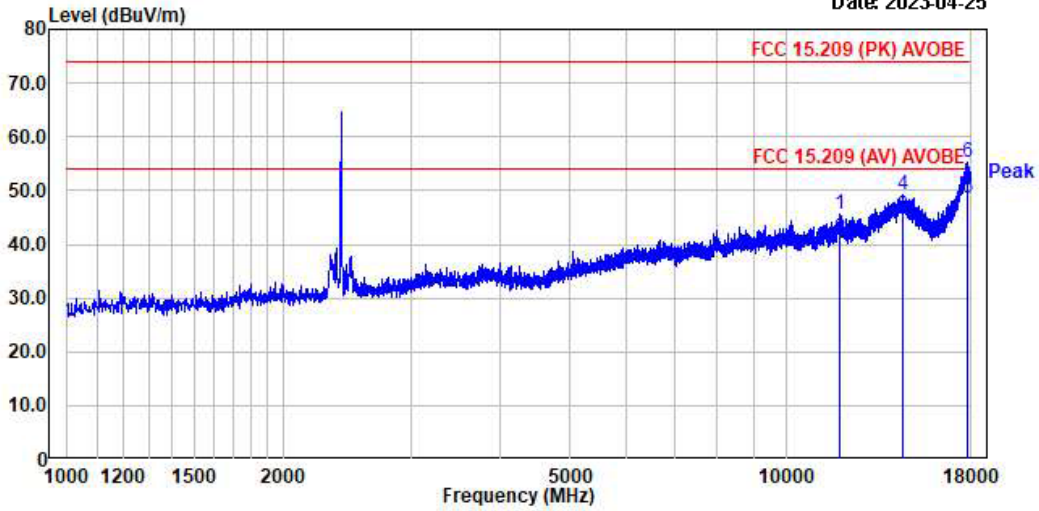

No.	Freq MHz	RD PK dBμV	RD AV dBμV	C.F dB	Result PK dBμV	Result AV dBμV	Limit PK dBμV	Limit AV dBμV	Margin PK dB	Margin AV dB	Height cm	Angle deg	Polarity
1.	11856.63	31.70	-----	13.91	45.61	-----	74.00	-----	28.39	-----	100	28	horizontal
2.	11856.63	-----	27.10	13.91	-----	41.01	-----	54.00	-----	12.99	100	28	horizontal
4.	14506.50	30.19	26.30	18.94	49.13	45.24	74.00	54.00	24.87	8.76	100	253	horizontal
6.	17872.50	30.80	24.20	24.55	55.35	48.75	74.00	54.00	18.65	5.25	100	106	horizontal

Remarks: C.F (Correction Factor) = Antenna factor + Cable loss - Preamp gain

Date: 2023-04-25

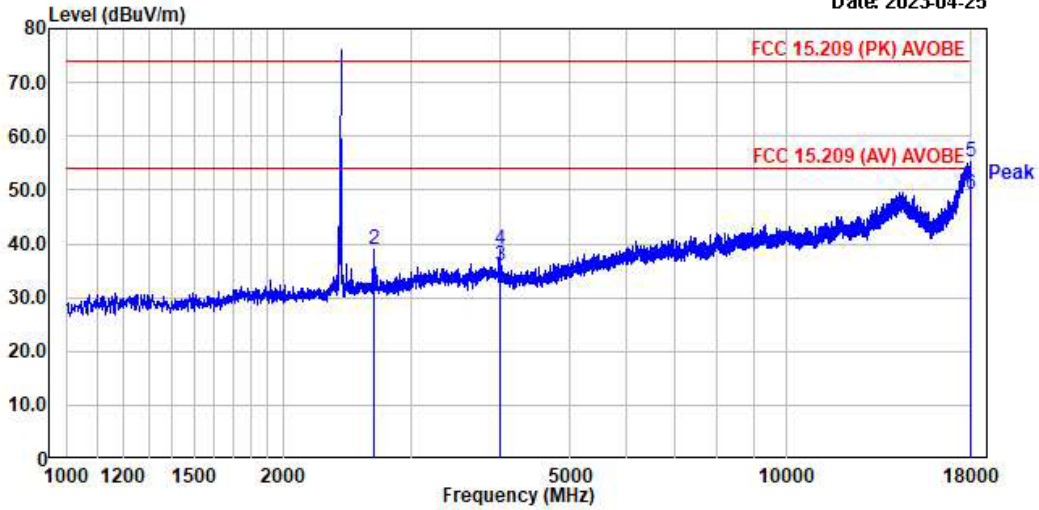

No.	Freq MHz	RD PK dBμV	RD AV dBμV	C.F dB	Result PK dBμV	Result AV dBμV	Limit PK dBμV	Limit AV dBμV	Margin PK dB	Margin AV dB	Height cm	Angle deg	Polarity
2.	2663.88	41.89	34.90	-3.05	38.84	31.85	74.00	54.00	35.16	22.15	100	206	vertical
4.	3989.88	36.49	33.20	2.60	39.09	35.80	74.00	54.00	34.91	18.20	100	268	vertical
5.	17997.88	30.79	-----	24.44	55.23	-----	74.00	-----	18.77	-----	100	66	vertical
6.	17997.88	-----	24.80	24.44	-----	49.24	-----	54.00	-----	4.76	100	66	vertical

Remarks: C.F (Correction Factor) = Antenna factor + Cable loss - Preamp gain

Date: 2023-04-26

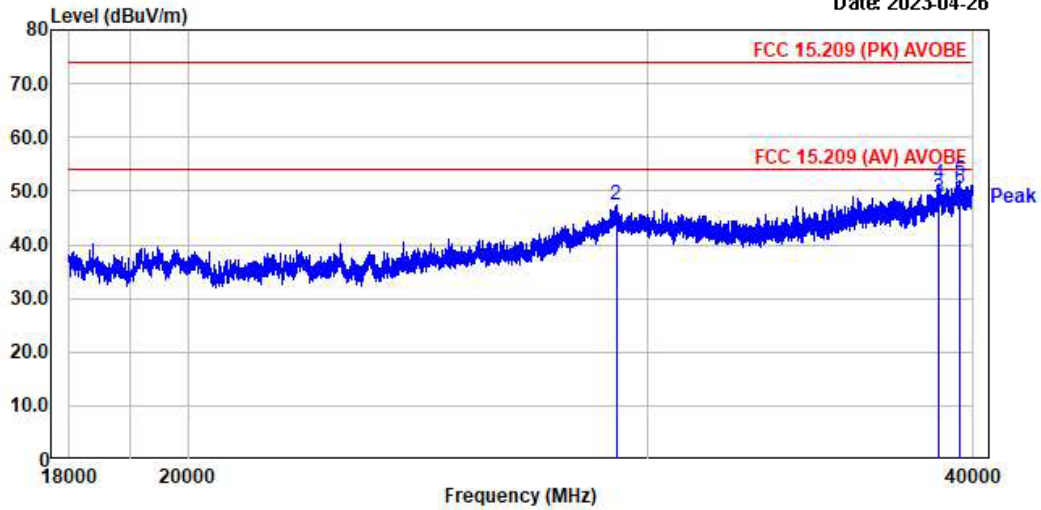

No.	Freq	RD	RD	C.F	Result	Result	Limit	Limit	Margin	Margin	Height	Angle	Polarity
	MHz	PK	AV	dB	PK	AV	PK	AV	PK	AV	cm	deg	
		dBμV	dBμV		dBμV	dBμV	dBμV	dBμV	dB	dB			
2.	29195.25	22.65	18.59	24.62	47.27	43.21	74.00	54.00	26.73	10.79	100	360	horizontal
4.	38847.75	26.81	24.01	24.51	51.32	48.52	74.00	54.00	22.68	5.48	100	360	horizontal
6.	39549.88	24.10	-----	26.21	50.31	-----	74.00	-----	23.69	-----	100	297	horizontal

Remarks: C.F (Correction Factor) = Antenna factor + Cable loss - Preamp gain

Date: 2023-04-26

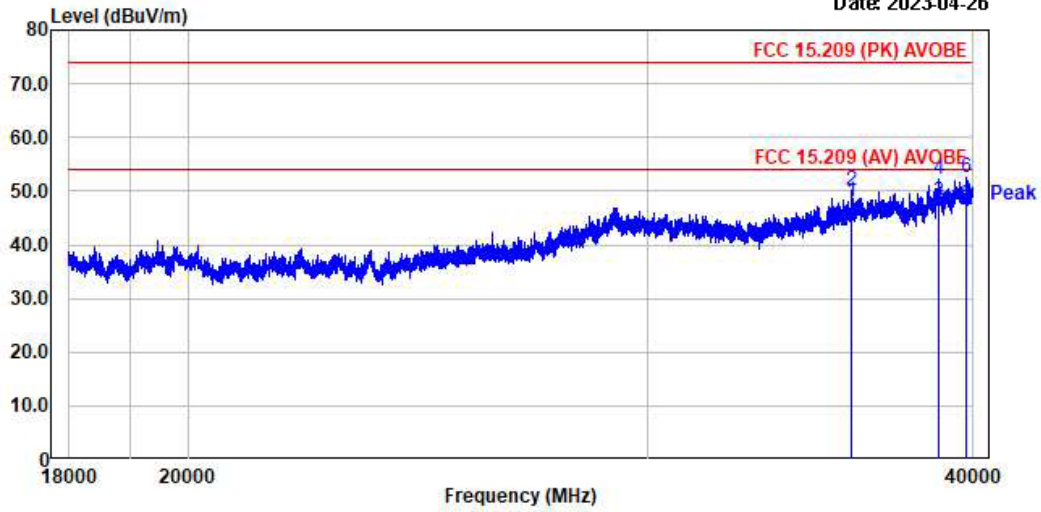

No.	Freq	RD	RD	C.F	Result	Result	Limit	Limit	Margin	Margin	Height	Angle	Polarity
	MHz	PK	AV	dB	PK	AV	PK	AV	PK	AV	cm	deg	
		dBμV	dBμV		dBμV	dBμV	dBμV	dBμV	dB	dB			
2.	35949.25	24.08	21.80	26.06	50.14	47.86	74.00	54.00	23.86	6.14	100	360	vertical
4.	38820.25	27.52	23.30	24.62	52.14	47.92	74.00	54.00	21.86	6.08	100	284	vertical
6.	39780.88	25.98	20.80	26.49	52.47	47.29	74.00	54.00	21.53	6.71	100	269	vertical

Remarks: C.F (Correction Factor) = Antenna factor + Cable loss - Preamp gain

3.2.7 AC Conducted Emissions

Procedure:

The conducted emissions are measured in the shielded room with a spectrum analyzer in peak hold. While the measurement, EUT had its hopping function disabled at the middle channels in line with Section 15.31(m). Emissions closest to the limit are measured in the quasi-peak mode (QP) with the tuned receiver using a bandwidth of 9 kHz. The emissions are maximized further by cable manipulation and Exerciser operation. The highest emissions relative to the limit are listed.

Minimum Standard: FCC Part 15.207(a) / EN 55022

Measurement Data: N/A

Class B

Frequency Range	quasi-peak	Average
0.15 ~ 0.5	66 to 56 *	56 to 46 *
0.5 ~ 5	56	46
5 ~ 30	60	50

* Decreases with the logarithm of the frequency

APPENDIX
TEST EQUIPMENT USED FOR TESTS

○	Use	Description	Model No.	Serial No.	Manufacturer	Interval	Next Cal. Date
1	■	Signal Analyzer (9 kHz ~ 30 GHz)	FSV30	100757	R&S	1 year	2023-08-30
2	■	Signal Generator (~3.2 GHz)	8648C	3623A02597	HP	1 year	2024-03-14
3		SYNTHESIZED CW GENERATOR	83711B	US34490456	HP	1 year	2024-03-14
4		Attenuator (3 dB)	8491A	37822	HP	1 year	2023-08-30
5		Attenuator (10 dB)	8491A	63196	HP	1 year	2023-08-30
6	■	EMI Test Receiver (~7 GHz)	ESCI7	100722	R&S	1 year	2023-08-30
7		RF Amplifier (~1.3 GHz)	8447D OPT 010	2944A07684	HP	1 year	2023-08-30
8		RF Amplifier (1~26.5 GHz)	8449B	3008A02126	HP	1 year	2024-03-14
9	■	Horn Antenna (1~18 GHz)	3115	00114105	ETS	2 year	2023-08-30
10	■	DRG Horn (Small)	3116B	81109	ETS-Lindgren	2 year	2024-03-18
11	■	DRG Horn (Small)	3116B	133350	ETS-Lindgren	2 year	2024-03-18
12	■	TRILOG Antenna	VULB 9160	9160-3237	SCHWARZBECK	2 year	2024-03-14
13		Temp.Humidity Data Logger	SK-L200TH II A	00801	SATO	1 year	2024-03-14
14		Splitter (SMA)	ZFSC-2-2500	SF617800326	Mini-Circuits	-	-
15	■	DC Power Supply	6674A	3637A01657	Agilent	-	-
17	■	Power Meter	EPM-441A	GB32481702	HP	1 year	2024-03-14
18	■	Power Sensor	8481A	3318A94972	HP	1 year	2023-08-30
19		Audio Analyzer	8903B	3729A18901	HP	1 year	2023-08-30
20		Modulation Analyzer	8901B	3749A05878	HP	1 year	2023-08-30
21		TEMP & HUMIDITY Chamber	YJ-500	LTAS06041	JinYoung Tech	1 year	2023-08-30
22		Stop Watch	HS-3	812Q08R	CASIO	2 year	2026-03-14
23		LISN	KNW-407	8-1430-1	Kyoritsu	1 year	2024-03-14
24		Two-Lime V-Network	ESH3-Z5	893045/017	R&S	1 year	2024-03-14
25		UNIVERSAL RADIO COMMUNICATION TESTER	CMU200	106243	R&S	1 year	2024-03-14
26		Highpass Filter	WHKX1.5/15G-10SS	74	Wainwright Instruments	1 year	2024-03-14
27		Highpass Filter	WHKX3.0/18G-10SS	118	Wainwright Instruments	1 year	2024-03-14
28		OSP120 BASE UNIT	OSP120	101230	R&S	1 year	2024-03-14
29	■	Signal Generator(100 kHz ~ 40 GHz)	SMB100A03	177621	R&S	1 year	2024-03-14
30	■	Signal Analyzer (10 Hz ~ 40 GHz)	FSV40	101367	R&S	1 year	2024-03-14
31	■	Active Loop Antenna	FMZB 1519	1519-031	SCHWARZBECK	2 year	2024-03-16