

Dates of Tests: June 17, 2021 ~ July 14, 2021
Test Report S/N: LR500112107E
Test Site : LTA CO., LTD.

CERTIFICATION OF COMPLIANCE

FCC ID.

2AZKWREBE-TZ21C

APPLICANT

ATEC IoT CO., LTD.

Equipment Class	:	Digital Transmission System (DTS)
Manufacturing Description	:	Electronic Shelf Label
Manufacturer	:	SUZHOU NIHONE Electronics Technology Co., LTD
Model name	:	REBE-TZ21C
Test Device Serial No.:	:	Identical prototype
Rule Part(s)	:	FCC Part 15.247 Subpart C ; ANSI C63.10 - 2013
Frequency Range	:	Zigbee 2405 ~ 2480 MHz
Max. Output Power	:	Max 1.41 dBm - Conducted
Data of issue	:	July 15, 2021

This test report is issued under the authority of:



Ja-Beom Koo, Manager

The test was supervised by:



Jae-Huem, Yun, Test Engineer

This test result only responds to the tested sample. It is not allowed to copy this report even partly without the allowance of the test laboratory. The report must not be used by the client to claim product certification, approval, or endorsement by NVLAP, NIST, or any agency of the Federal Government.



NVLAP LAB Code.: 200723-0

TAZigbee OF CONTENTS

1. GENERAL INFORMATION	-----	3
2. INFORMATION ABOUT TEST ITEM	-----	4
3. TEST REPORT	-----	5
3.1 SUMMARY OF TESTS	-----	5
3.2 TECHNICAL CHARACTERISTICS TEST	-----	6
3.2.1 6 dB BANDWIDTH	-----	6
3.2.2 PEAK OUTPUT POWER	-----	9
3.2.3 POWER SPECTRAL DENSITY	-----	12
3.2.4 BAND EDGE	-----	15
3.2.5 CONDUCTED SPURIOUS EMISSIONS	-----	17
3.2.6 RADIATED SPURIOUS EMISSIONS	-----	20
3.2.7 AC CONDUCTED EMISSIONS	-----	32
APPENDIX		
APPENDIX TEST EQUIPMENT USED FOR TESTS	-----	33

1. General information

1-1 Test Performed

Company name : LTA Co., Ltd.
 Address : 243, Jubug-ri, Yangji-Myeon, Youngin-Si, Kyunggi-Do, Korea. 17159
 Web site : <http://www.ltalab.com>
 E-mail : chahn@ltalab.com
 Telephone : +82-31-323-6008
 Facsimile : +82-31-323-6010

Quality control in the testing laboratory is implemented as per ISO/IEC 17025 which is the “General requirements for the competents of calibration and testing laboratory”.

1-2 Accredited agencies

LTA Co., Ltd. is approved to perform EMC testing by the following agencies:

Agency	Country	Accreditation No.	Validity	Reference
NVLAP	U.S.A	200723-0	2021-09-30	ECT accredited Lab.
RRA	KOREA	KR0049	-	EMC accredited Lab.
FCC	U.S.A	649054	2023-01-15	FCC CAB
VCCI	JAPAN	C-4948,	2023-09-10	VCCI registration
VCCI	JAPAN	T-2416,	2023-09-10	VCCI registration
VCCI	JAPAN	R-4483(10 m),	2023-08-15	VCCI registration
VCCI	JAPAN	G-847	2021-12-13	VCCI registration
IC	CANADA	5799A-1	2022-10-18	IC filing
KOLAS	KOREA	NO.551	2021-08-20	KOLAS accredited Lab.

2. Information about test item

2-1 Client & Manufacturer

Client Company name : ATEC IoT CO., LTD.
 Address : 289, Pangyo-ro, Bundang-gu, Seongnam-si, Gyeonggi-do, 13488, South Korea
 Tel / Fax : +82-10-5790-6171 / +82-31-696-1534
 Manufacturer : SUZHOU NIHONE Electronics Technology Co., LTD
 Address : No. 185, Xiaoxiang Road, Suzhou New District, Suzhou City, Jiangsu Province, P.R. China
 Tel / Fax : +82-10-5790-6171 / +82-31-696-1534

2-2 Equipment Under Test (EUT)

Model name : ATEC IoT CO., LTD.
 Serial number : Identical prototype
 Date of receipt : June 17, 2021
 EUT condition : Pre-production, not damaged
 Antenna type : FPCB Antenna (Max Gain : -5.51 dBi)
 Frequency Range : Zigbee 2405 ~ 2480 MHz
 RF output power : Max 1.41 dBm – Conducted
 Type of Modulation : Pi/4 DQPSK, 8DPSK
 Power Source : DC 3.0 V

2-3 Tested frequency

	LOW	MID	HIGH
Frequency (MHz) Zigbee	2405	2440	2480

2-4 Ancillary Equipment

Equipment	Model No.	Serial No.	Manufacturer
Notebook	-	MS-1736	MSI

3. Test Report

3.1 Summary of tests

FCC Part Section(s)	Parameter	Test Condition	Status (note 1)
15.247(a)	6 dB Bandwidth	Conducted	C
15.247(b)	Transmitter Peak Output Power		C
15.247(e)	Transmitter Power Spectral Density		C
15.247(d)	Band Edge & Conducted Spurious emission		C
15.209	Transmitter emission	Radiated	C
15.207	AC Conducted Emissions	Conducted	N/A
15.203	Antenna requirement	-	C

N/A : This product is battery-enabled and excludes the test.

The above equipment was tested by LTA Co., Ltd. The test data, data evaluation, test procedures, and equipment configurations shown in this report were made in accordance with the procedures given in ANSI C63.10-2013 and the energy emitted by the sample EUT tested as described in this report is in compliance with the requirements of FCC Rules Part 2 and Part 15.247 The test results of this report relate only to the tested sample identified in this report.

The tests were performed according to the method of measurements prescribed in KDB No.558074.

→ Antenna Requirement

ATEC IoT CO., LTD. FCC ID: 2AZKWREBE-TZ21C unit complies with the requirement of §15.203.

The antenna type is PCB Antenna

3.2 Technical Characteristics Test

3.2.1 6 dB Bandwidth

Procedure:

The bandwidth at 6 dB below the highest in-band spectral density was measured with a spectrum analyzer connected to the antenna terminal, while EUT is operating in transmission mode at the appropriate frequencies.

After the trace being stable, Use the marker-to-peak function to set the marker to the peak of the emission. Use the marker-delta function to measure 6 dB down one side of the emission. Reset the marker-delta function, and move the marker to the other side of the emission, until it is (as close as possible to) even with the reference marker level. The marker-delta reading at this point is the 6 dB bandwidth of the emission.

The spectrum analyzer is set to:

Center frequency = the highest, middle and the lowest channels

RBW = 100 kHz

Span = 3 X RBW

VBW = 3 X RBW

Sweep = auto

Trace = max hold

Detector function = peak

Measurement Data : Complies

Zigbee Mode

Frequency (MHz)	Test Results	
	Measured Bandwidth (MHz)	Result
2405	1.729	Complies
2440	1.787	Complies
2480	1.700	Complies

- See next pages for actual measured spectrum plots.

Minimum Standard:

6 dB Bandwidth \geq 500 kHz

Measurement Setup

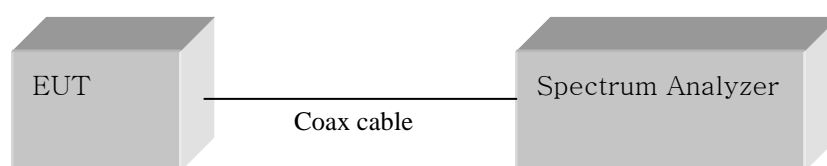
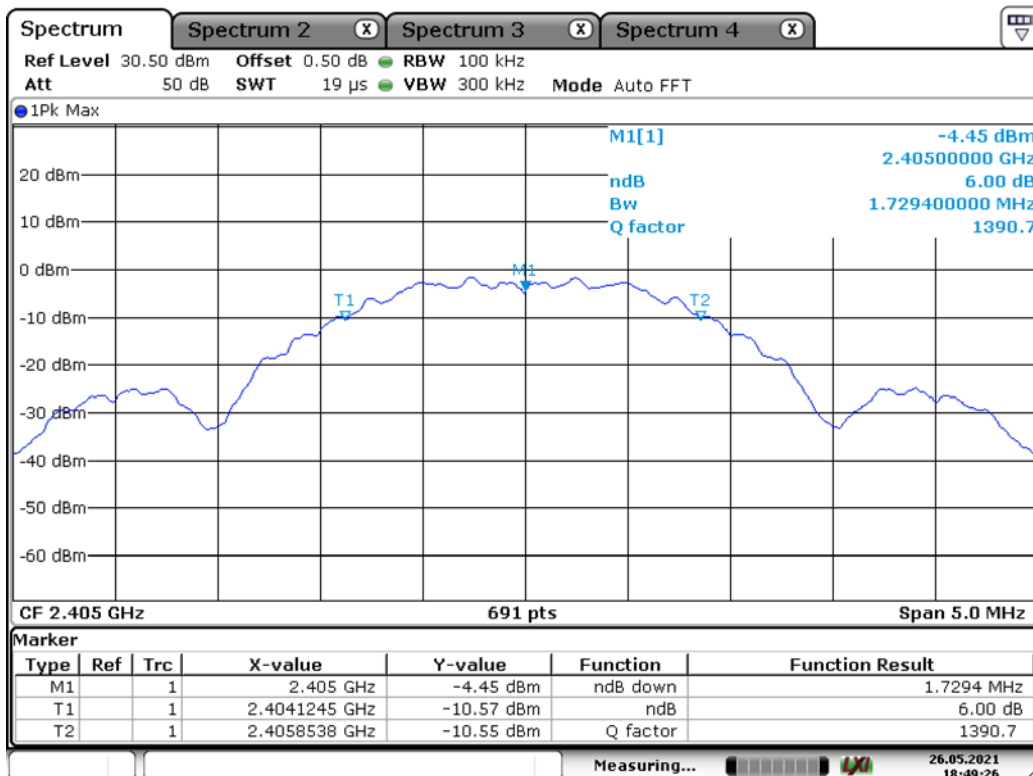

Figure 1: Measurement setup for the carrier frequency separation

Low Channel



Date: 26.MAY.2021 18:49:27

Middle Channel

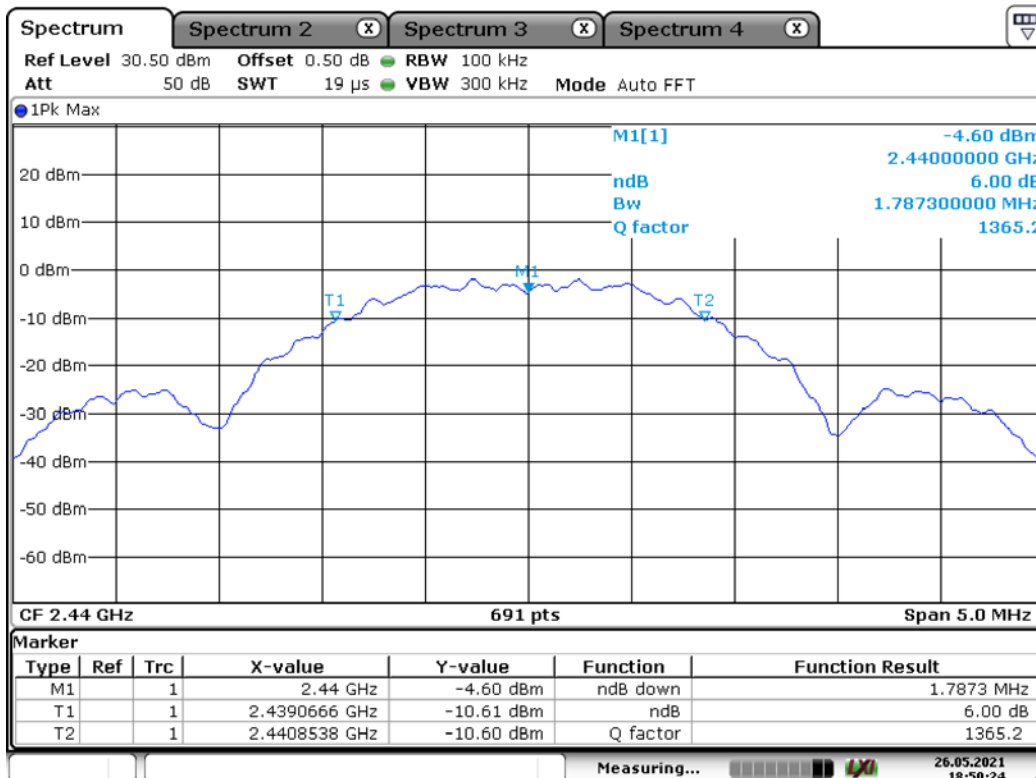

Date: 26.MAY.2021 18:50:25

High Channel

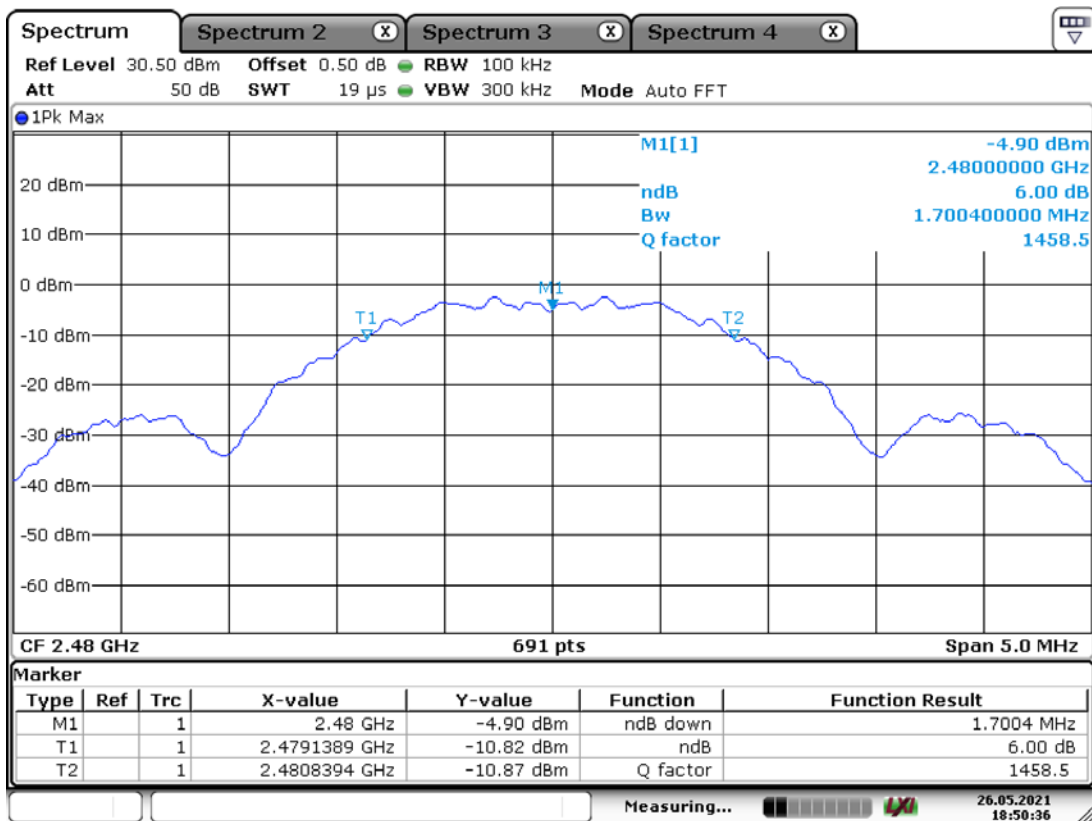

Date: 26.MAY.2021 18:50:37

3.2.2 Peak Output Power Measurement

Procedure:

The following procedure can be used when the maximum available RBW of the instrument is less than the DTS bandwidth :

The spectrum analyzer is set to:

Center frequency = the highest, middle and the lowest channels

RBW \geq DTS Bandwidth

Span \geq 3 X RBW

VBW = 3 X RBW

Sweep = auto

Detector function = peak

Measurement Data : Complies

Zigbee Mode

Frequency (MHz)	Test Results	
	Measured data (dBm)	Result
2405	1.41	Complies
2440	1.17	Complies
2480	0.59	Complies

- See next pages for actual measured spectrum plots.

Minimum Standard:

Peak output power	\leq 1 W(30 dBm)
-------------------	--------------------

Measurement Setup

Same as the Chapter 3.2.1 (Figure 1)

Low Zigbee

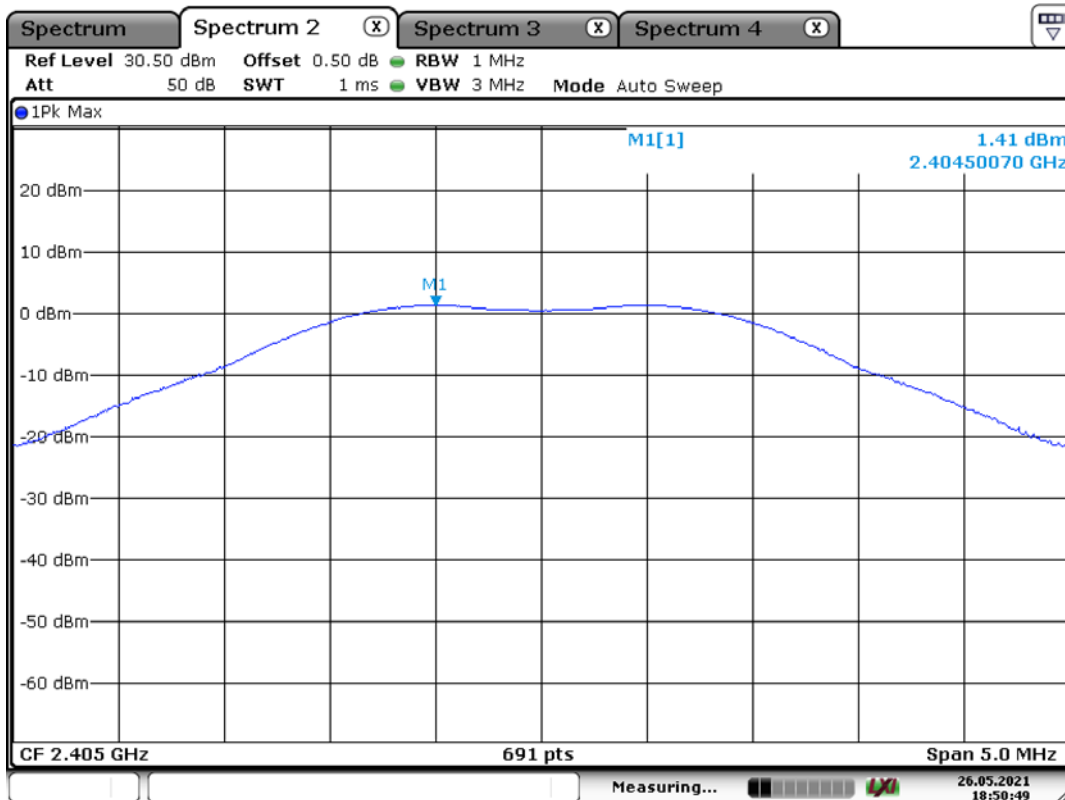

Date: 26.MAY.2021 18:50:49

Middle Zigbee

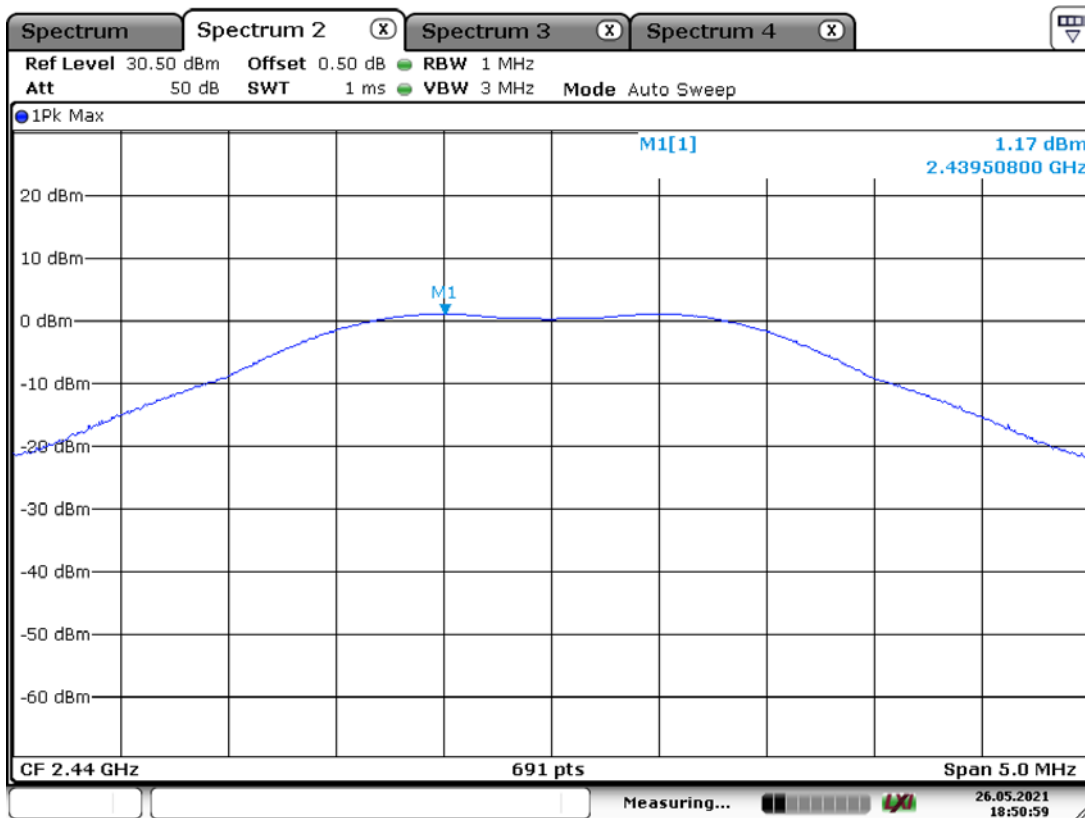

Date: 26.MAY.2021 18:50:59

High Zigbee

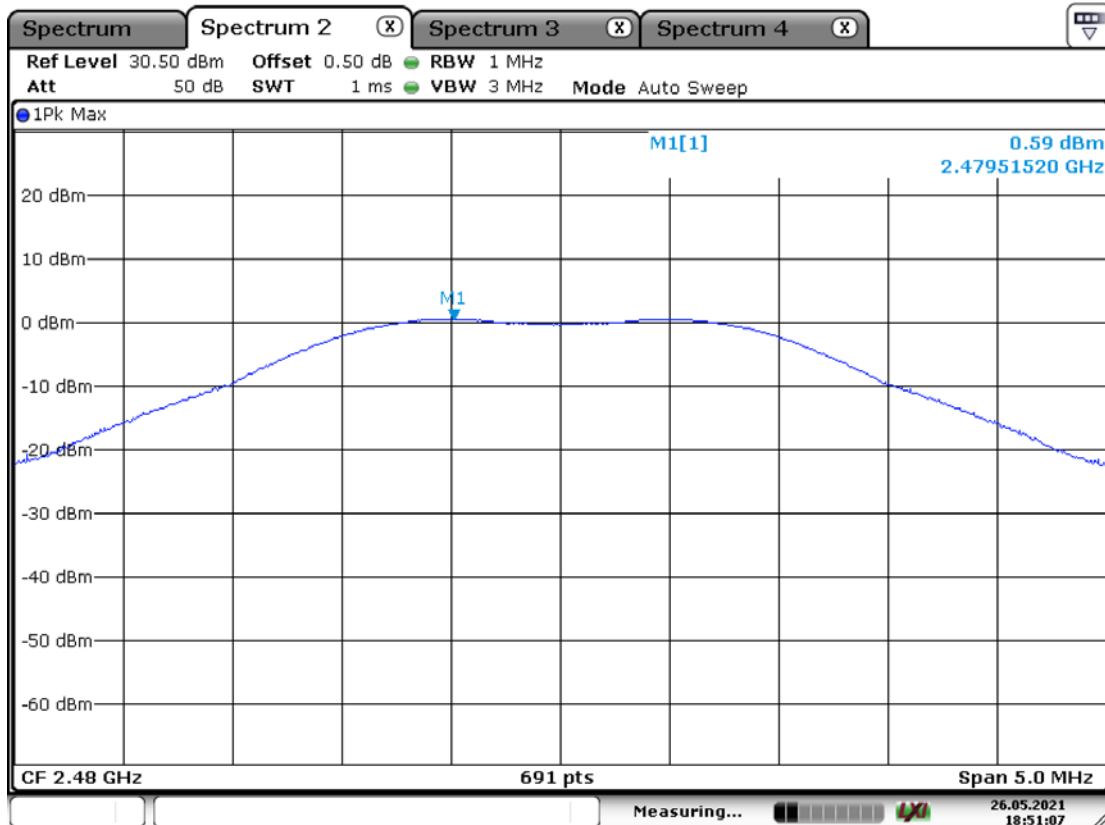

Date: 26.MAY.2021 18:51:07

3.2.3 Power Spectral Density

Procedure:

This procedure shall be used if maximum peak conducted output power was used to demonstrate compliance.

The spectrum analyzer is set to:

RBW = 3 kHz ($3 \text{ kHz} \leq \text{RBW} \leq 100 \text{ kHz}$)

Span ≥ 1.5 times the DTS bandwidth

VBW = 3 X RBW

Sweep = auto

Detector function = peak

Trace = max hold

Measurement Data : Complies

Zigbee Mode-Ant 1

Frequency (MHz)	Test Results	
	dBm / 3 kHz BW	Result
2405	-13.77	Complies
2440	-13.75	Complies
2480	-14.11	Complies

- See next pages for actual measured spectrum plots.

Minimum Standard:

Power Spectral Density	$\leq 8 \text{ dBm @ } 3 \text{ kHz BW}$
------------------------	--

Measurement Setup

Same as the Chapter 3.2.1 (Figure 1)

Low Zigbee

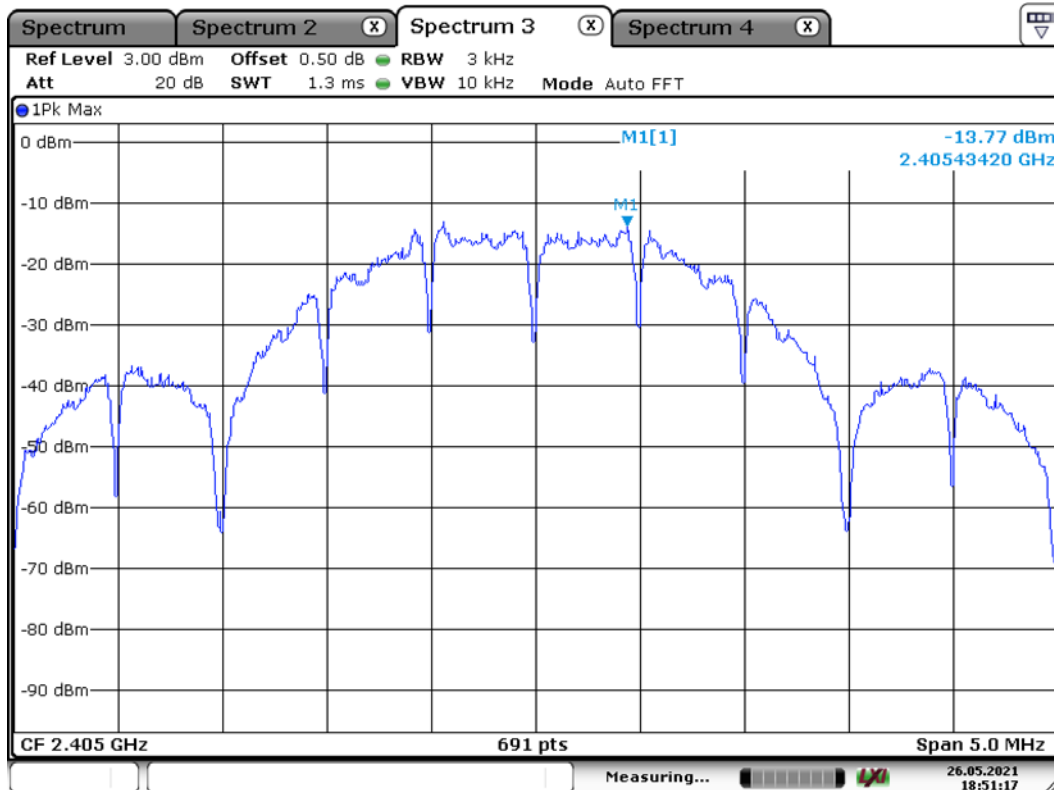

Date: 26.MAY.2021 18:51:17

Middle Zigbee

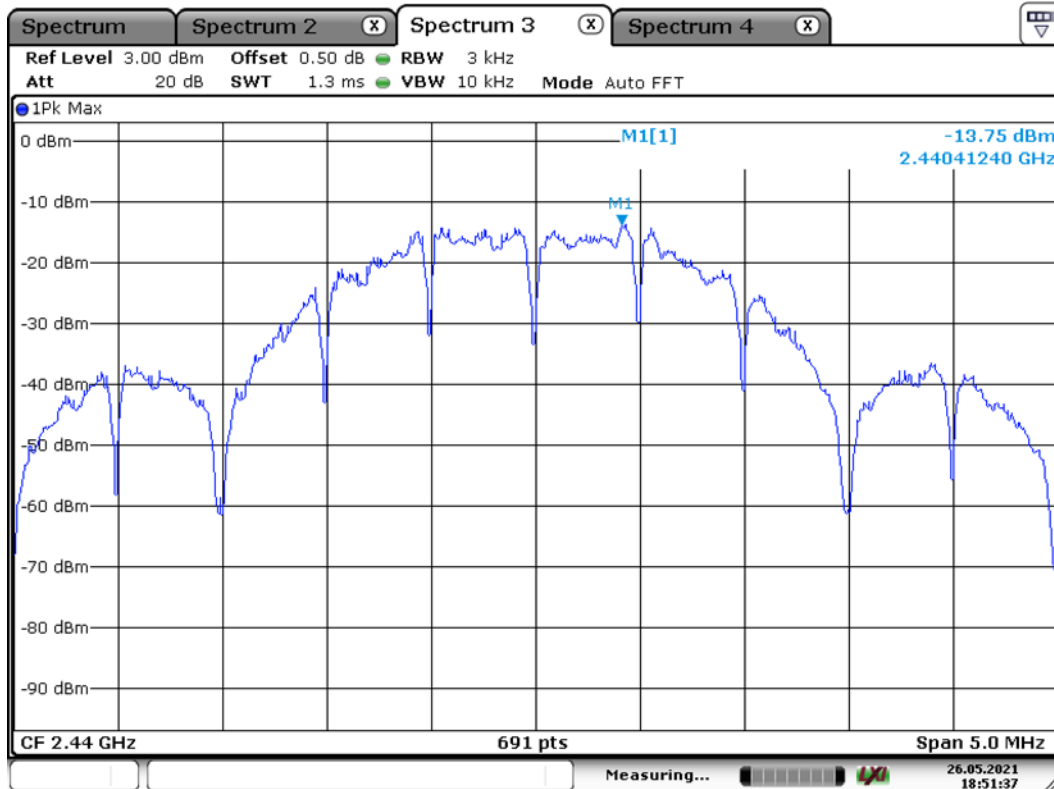

Date: 26.MAY.2021 18:51:37

High Zigbee

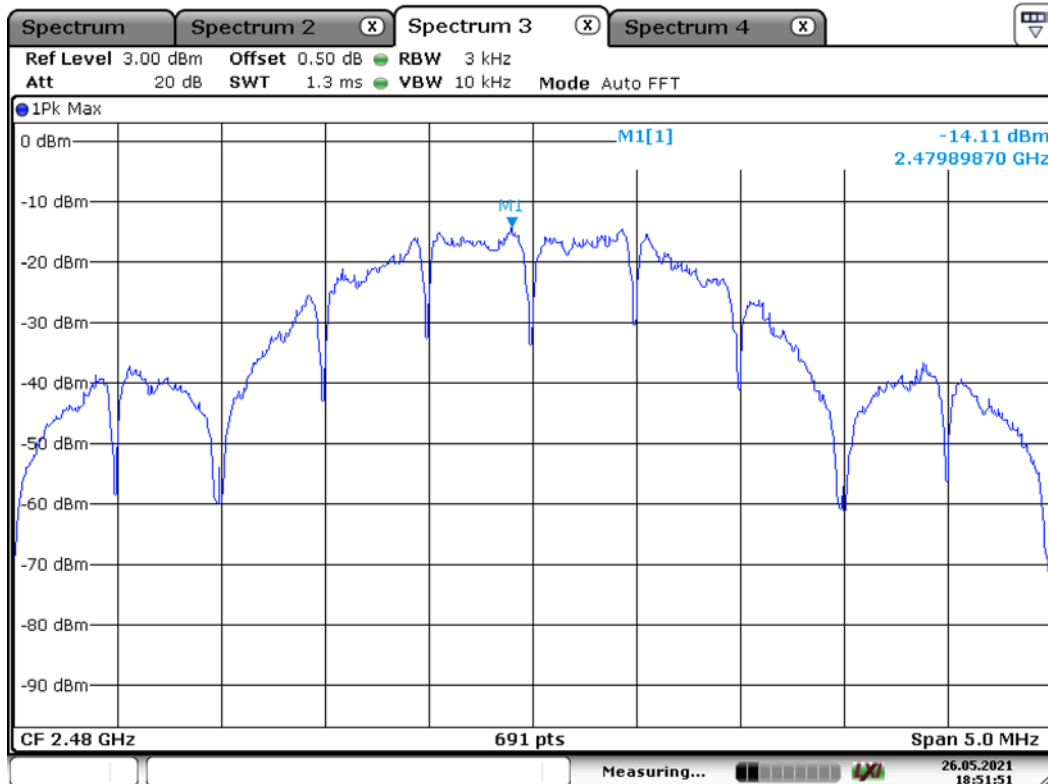

Date: 26.MAY.2021 18:51:52

3.2.4 Band Edge

Procedure:

The Unwanted emission from the EUT were measured according to the dictates PKPSD measurement procedure in section 11.11 of ANSI C63.10-2013.

In any 100 kHz bandwidth outside the frequency band in which the spread spectrum or digitally modulated device is operating, the RF power that is produced shall be at least 20 dB below that in the 100 kHz bandwidth within the band that contains the highest level of the desired power, based on either an RF conducted or a radiated measurement, provided that the transmitter demonstrates compliance with the peak conducted power limits.

If the transmitter complies with the conducted power limits based on the use of root-mean-square averaging over a time interval, as permitted under Section 5.4(4), the attenuation required shall be 30 dB instead of 20 dB..

The spectrum analyzer is set to:

Center frequency = the highest, middle and the lowest channels

RBW = 1 MHz

VBW \geq 3 X RBW

Detector function = peak

Trace = max hold

Sweep = auto

Measurement Data: Complies

- All conducted emission in any 100 kHz bandwidth outside of the spread spectrum band was at least 20 dB lower than the highest inband spectral density. Therefore the applying equipment meets the requirement.
- See next pages for actual measured spectrum plots.

Minimum Standard:	\leq 20 dBc
--------------------------	---------------

Lower edge

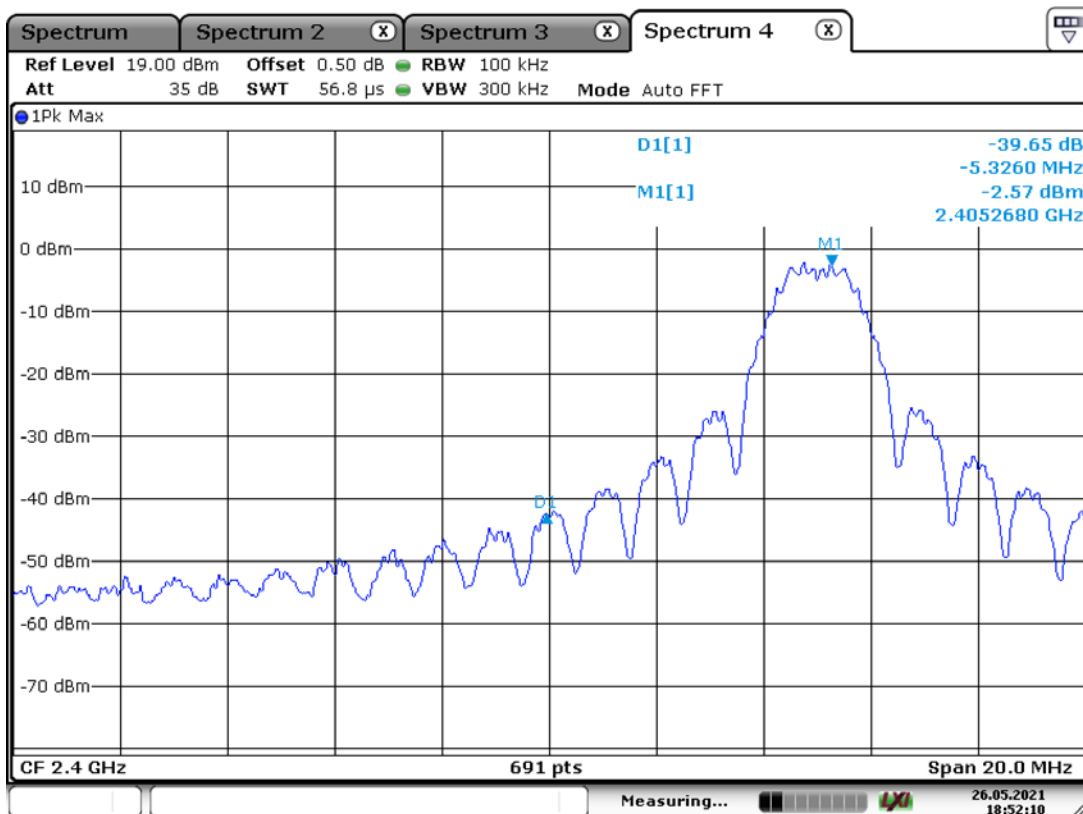

Date: 26.MAY.2021 18:52:10

Upper edge

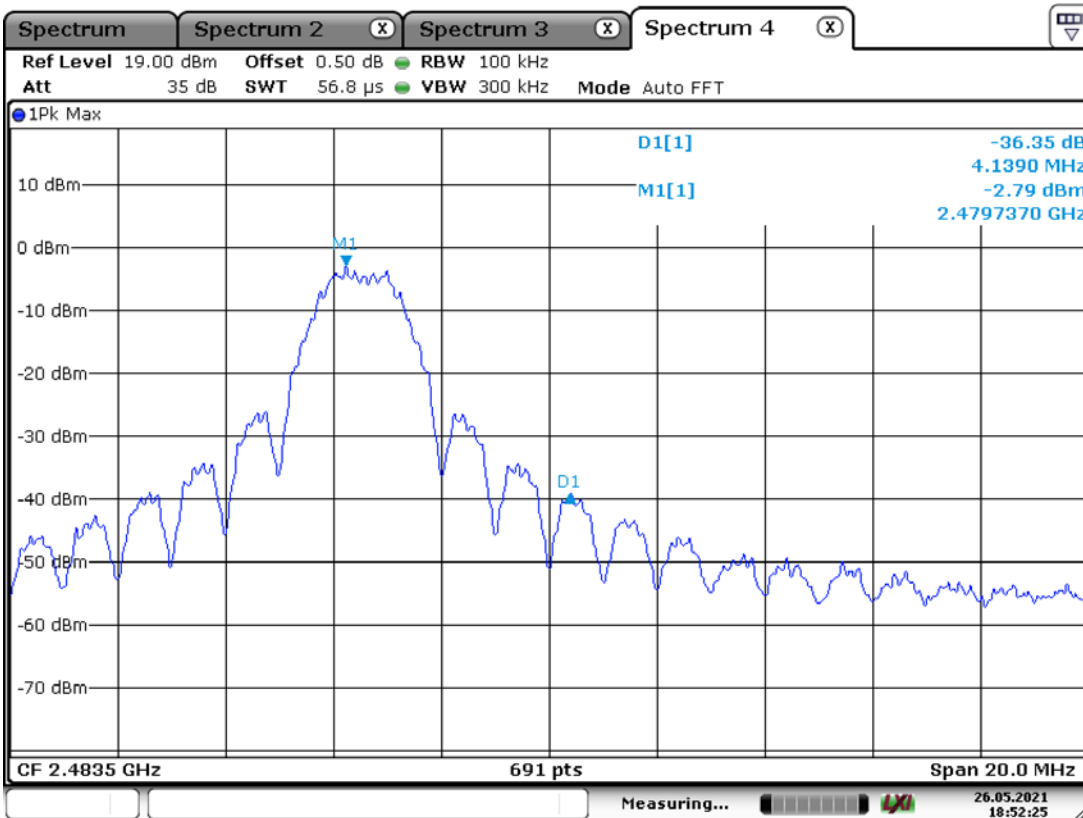

Date: 26.MAY.2021 18:52:25

3.2.5 Conducted Spurious Emissions

Procedure:

The test follows KDB558074. The conducted spurious emissions were measured with a spectrum analyzer connected to the antenna terminal, while EUT had its hopping function disabled at the highest, middle and the lowest available channels.

After the trace being stable, set the marker on the peak of any spurious emission recorded.

The spectrum analyzer is set to:

Span = wide enough to capture the peak level of the in-band emission and all spurious emissions

RBW = 100 kHz

Sweep = auto

VBW = 100 kHz

Detector function = peak

Trace = max hold

Measurement Data: Complies

- All conducted emission in any 100 kHz bandwidth outside of the spread spectrum band was at least 20 dB lower than the highest inband spectral density. Therefore the applying equipment meets the requirement.
- See next pages for actual measured spectrum plots.

Minimum Standard:	≥ 20 dBc
--------------------------	---------------

Measurement Setup

Same as the Chapter 3.2.1 (Figure 1)

Unwanted Emission – Low Channel
Frequency Range = 30 MHz ~ 26.5 GHz

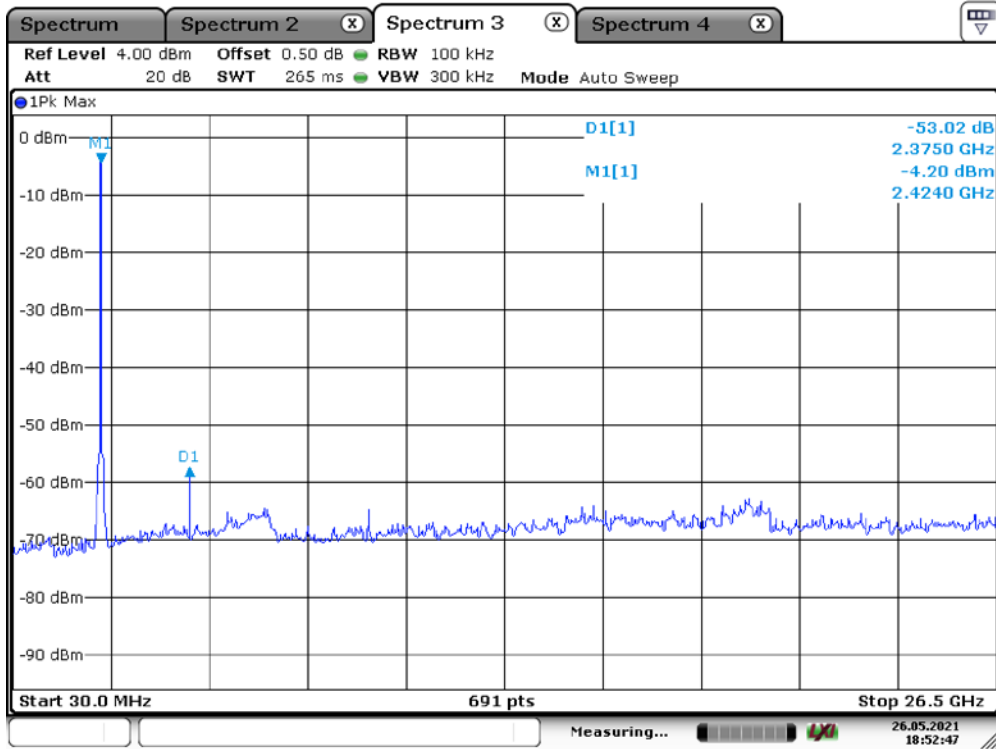

Date: 26.MAY.2021 18:52:47

Unwanted Emission – Middle Channel
Frequency Range = 30 MHz ~ 26.5 GHz

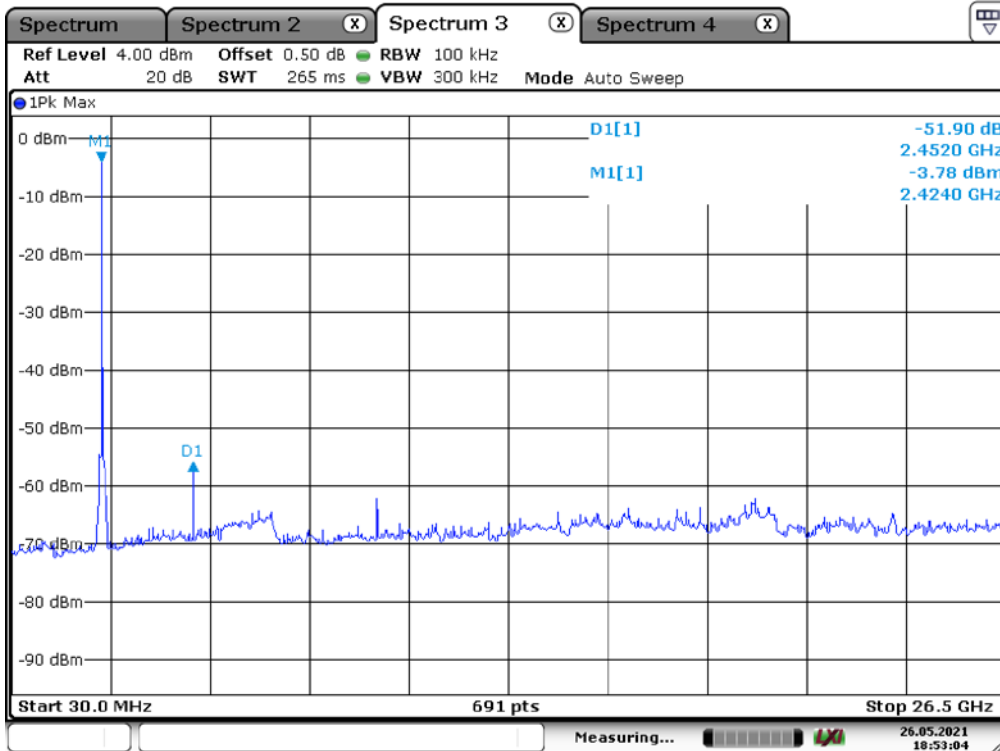

Date: 26.MAY.2021 18:53:05

Unwanted Emission – High Channel
\Frequency Range = 30 MHz ~ 26.5 GHz

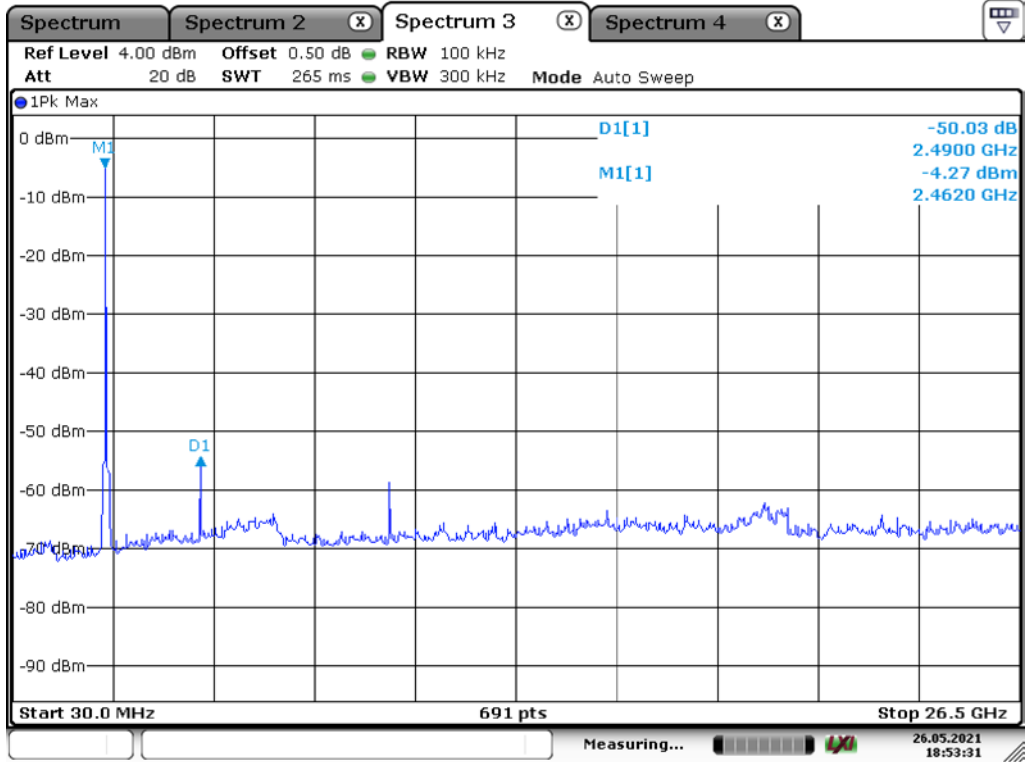

Date: 26.MAY.2021 18:53:31

3.2.6 Radiated Spurious Emissions

Procedure:

Radiated emissions from 30 MHz to 25 GHz were measured according to the methods defines in ANSI C63.10-2013. The EUT is a placed on as turn table. For emissions testing at or below 1 GHz, the table height shall be 0.8 m above the reference ground plane. For emission measurements above 1 GHz, the table height shall be 1.5 m. The turn table shall rotate 360 degrees to determine the position of maximum emission level. EUT is set 3m away from the receiving antenna which varied from 1m to 4m to find out the highest emission. And also, each emission was to be maximized by changing the polarization of receiving antenna both horizontal and vertical. In order to find out the max. emission, the relative positions of this hand-held transmitter (EUT) was rotated through three orthogonal axes and measurement procedures for electric field radiated emissions above 1 GHz the EUT measurement is to be made “while keeping the antenna in the ‘cone of radiation’ from that area and pointed at the area both in azimuth and elevation, with polarization oriented for maximum response.” is still within the 3dB illumination BW of the measurement antenna.

The spectrum analyzer is set to:

Center frequency = the worst channel

Frequency Range = 9 kHz ~ 10th harmonic.

RBW = 120 kHz (30 MHz ~ 1 GHz)

VBW \geq RBW

= 1 MHz (1 GHz ~ 10th harmonic)

Trace = max hold

Detector function = peak

Sweep = auto

Duty cycle : 98.89 %

The EUT configureal to transmit continuously(D \geq 98%)/ Duty Factor = 0

below 30 MHz

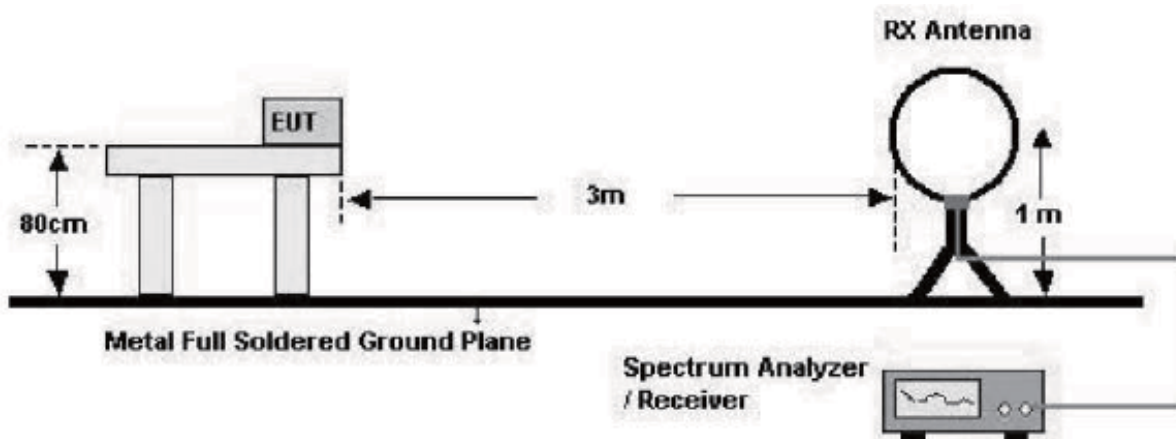

below 1 GHz (30 MHz to 1 GHz)

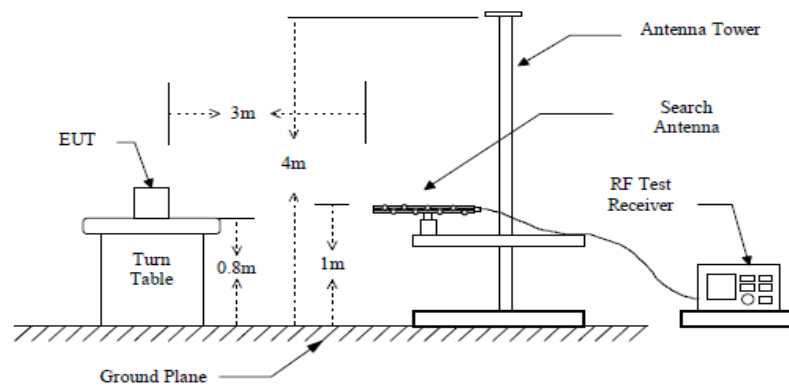

above 1 GHz

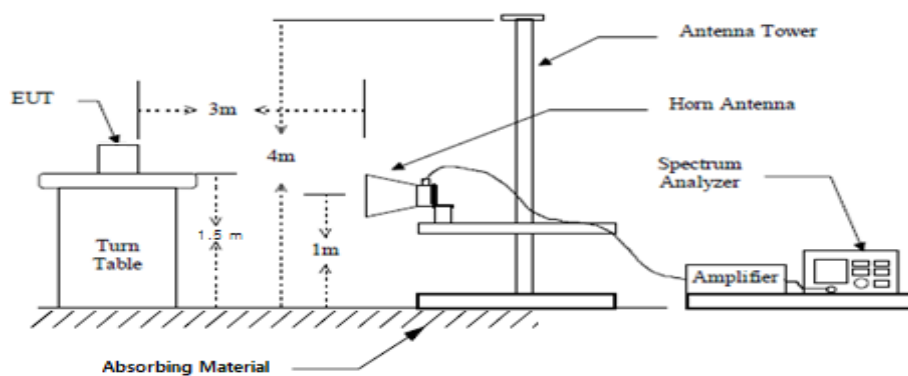

Measurement Data: Complies

- See next pages for actual measured data.
- No other emissions were detected at a level greater than 20 dB below limit include from 9 kHz to 30MHz.
- The test results for the worst of the various operating modes are presented in accordance with 6.3.4 of ANSI C63.10.
- Checked with a red circle is the fundamental frequency.

Minimum Standard: FCC Part 15.209(a)

Frequency (MHz)	Limit (uV/m) @ 3 m
0.009 ~ 0.490	2400/F(kHz) (@ 30 m)
0.490 ~ 1.705	24000/F(kHz) (@ 30 m)
1.705 ~ 30	30(@ 30 m)
30 ~ 88	100 **
88 ~ 216	150 **
216 ~ 960	200 **
Above 960	500

** Except as provided in 15.209(g), fundamental emissions from intentional radiators operating under this Section shall not be located in the frequency bands 54-72 MHz, 76-88 MHz, 174-216 MHz or 470-806 MHz. However, operation within these frequency bands is permitted under other sections of this Part, e.g. 15.231 and 15.241.

Radiated Emissions – Zigbee(Low)

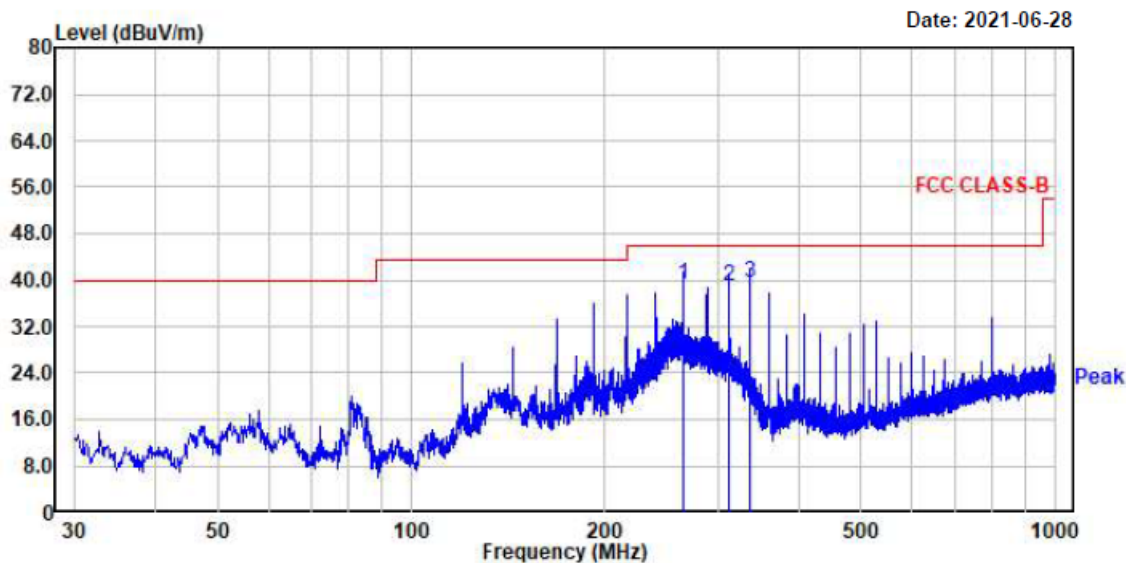

No.	Freq MHz	Reading dB μ V	C.F dB	Result QP dB μ V/m	Limit dB μ V/m	Margin dB	Height cm	Angle deg	Polarity
1.	264.01	56.23	-16.93	39.30	46.00	6.70	100	0	horizontal
2.	312.03	54.10	-15.06	39.04	46.00	6.96	100	0	horizontal
3.	336.04	53.98	-14.33	39.65	46.00	6.35	100	11	horizontal

Remarks: C.F (Correction Factor) = Antenna factor + Cable loss - Preamp gain

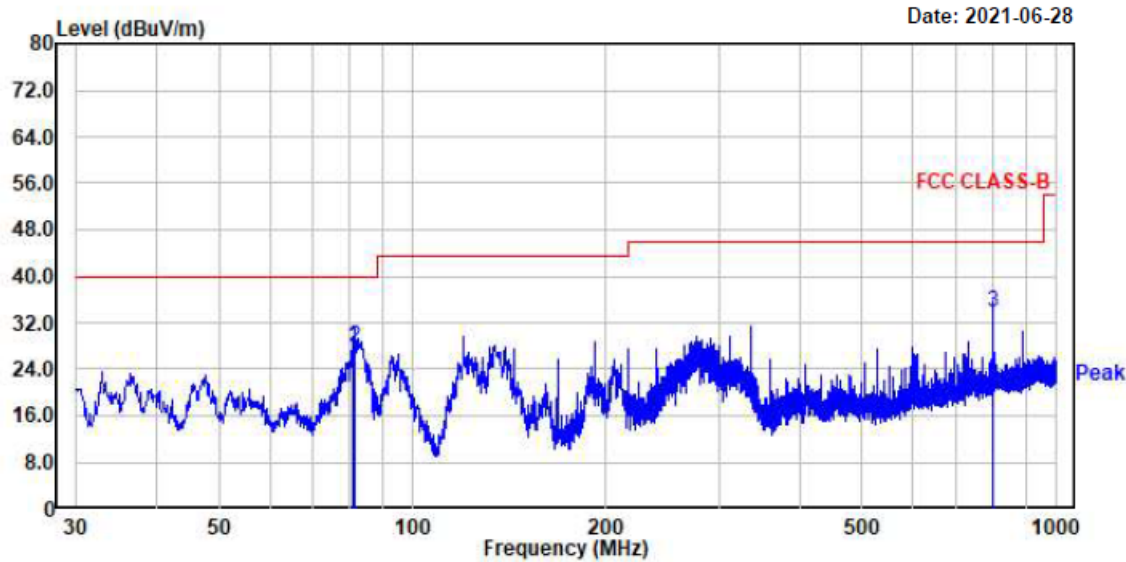

No.	Freq MHz	Reading dB μ V	C.F dB	Result QP dB μ V/m	Limit dB μ V/m	Margin dB	Height cm	Angle deg	Polarity
1.	80.93	48.69	-21.06	27.63	40.00	12.37	100	128	vertical
2.	81.29	49.01	-21.17	27.84	40.00	12.16	100	112	vertical
3.	799.94	37.85	-4.16	33.69	46.00	12.31	150	0	vertical

Remarks: C.F (Correction Factor) = Antenna factor + Cable loss - Preamp gain

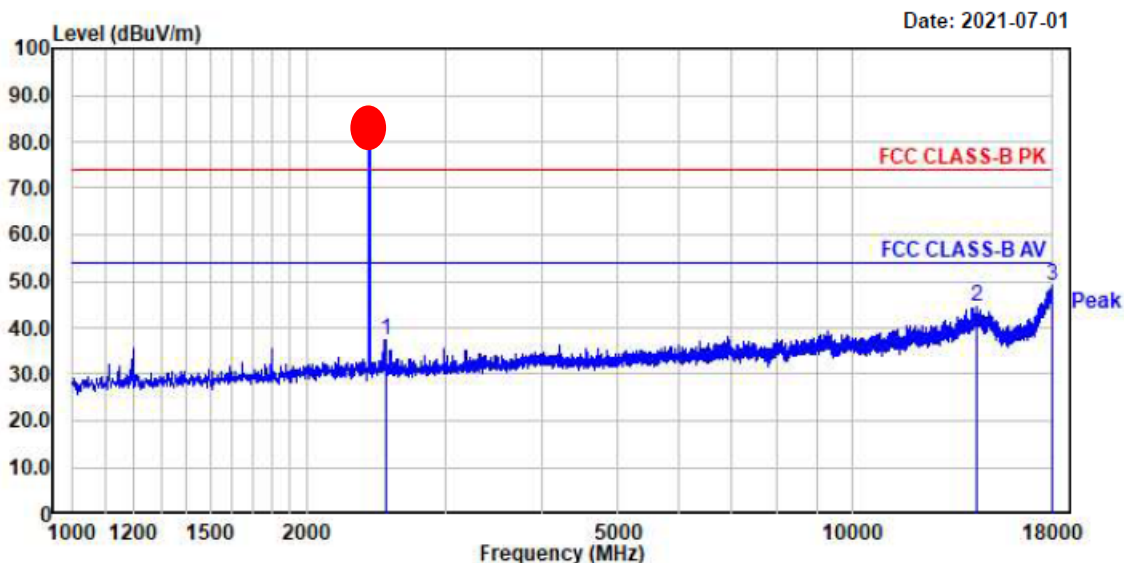

No.	Freq MHz	Reading dBμV	C.F dB	Result QP dBμV/m	Limit dBμV/m	Margin dB	Height cm	Angle deg	Polarity
1.	2525.75	44.90	-7.41	37.49	74.00	36.51	303	310	horizontal
2.	14438.50	34.23	10.22	44.45	74.00	29.55	162	168	horizontal
3.	17989.38	33.98	14.98	48.96	74.00	25.04	240	246	horizontal

Remarks: C.F (Correction Factor) = Antenna factor + Cable loss - Preamp gain

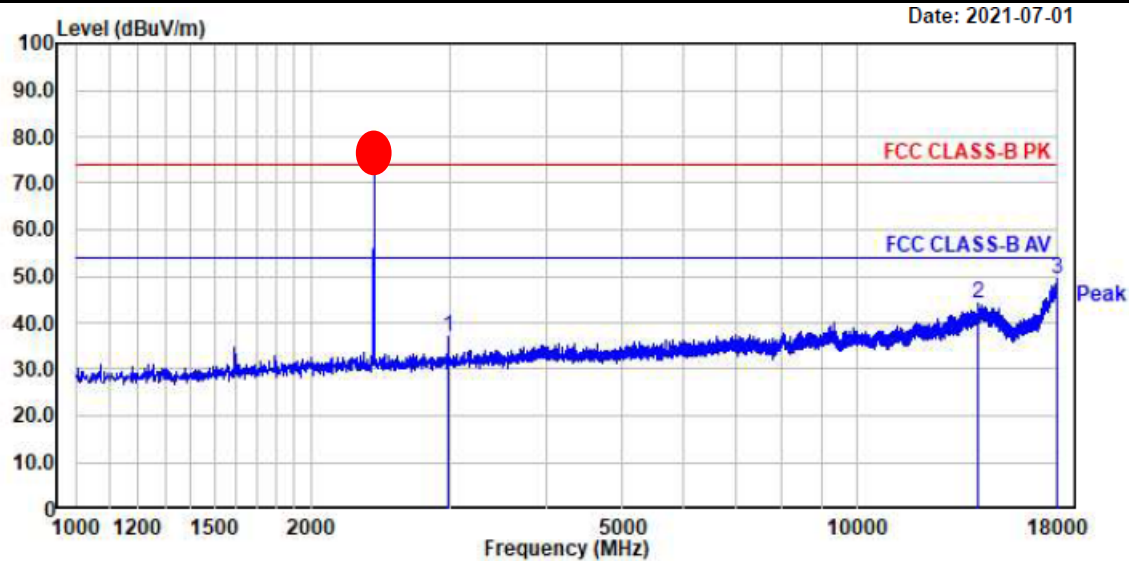

No.	Freq MHz	Reading dBμV	C.F dB	Result QP dBμV/m	Limit dBμV/m	Margin dB	Height cm	Angle deg	Polarity
1.	2991.13	42.87	-5.98	36.89	74.00	37.11	293	287	vertical
2.	14257.88	34.26	9.72	43.98	74.00	30.02	360	360	vertical
3.	17980.88	34.39	14.94	49.33	74.00	24.67	360	360	vertical

Remarks: C.F (Correction Factor) = Antenna factor + Cable loss - Preamp gain

Date: 2021-07-01

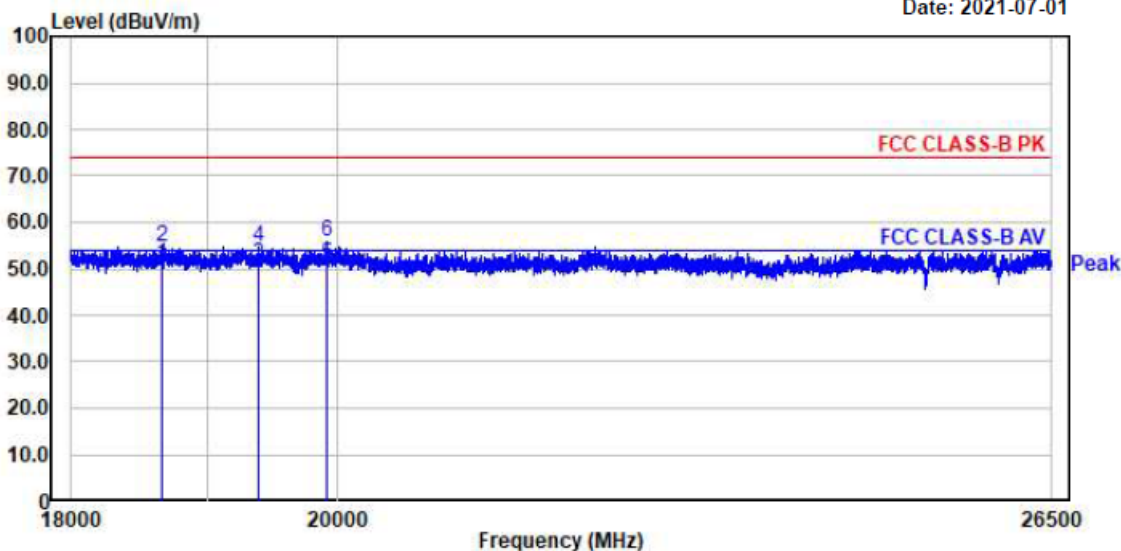

No.	Freq MHz	RD PK dBμV	RD AV dBμV	C.F dB	Result PK dBμV	Result AV dBμV	Limit PK dBμV	Limit AV dBμV	Margin PK dB	Margin AV dB	Height cm	Angle deg	Polarity
2.	18655.56	37.97	33.97	16.87	54.84	50.84	74.00	54.00	19.16	3.16	230	238	horizontal
4.	19375.94	38.55	34.55	16.28	54.83	50.83	74.00	54.00	19.17	3.17	24	31	horizontal
6.	19907.19	40.36	35.36	15.66	56.02	51.02	74.00	54.00	17.98	2.98	313	318	horizontal

Remarks: C.F (Correction Factor) = Antenna factor + Cable loss - Preamp gain

Date: 2021-07-01

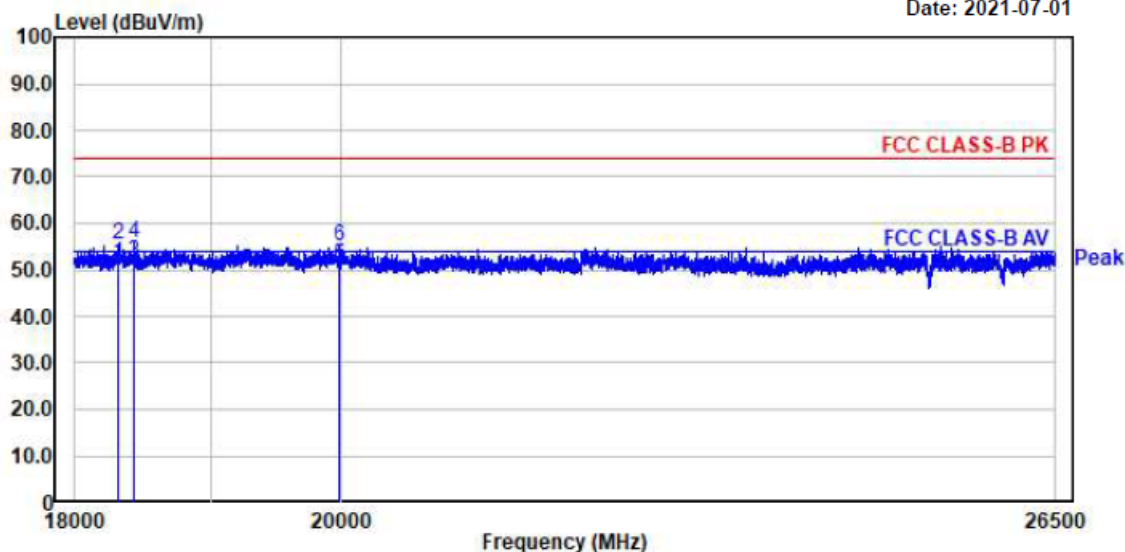

No.	Freq MHz	RD PK dBμV	RD AV dBμV	C.F dB	Result PK dBμV	Result AV dBμV	Limit PK dBμV	Limit AV dBμV	Margin PK dB	Margin AV dB	Height cm	Angle deg	Polarity
2.	18307.06	38.32	34.32	17.05	55.37	51.37	74.00	54.00	18.63	2.63	114	107	vertical
4.	18430.31	38.85	34.85	17.00	55.85	51.85	74.00	54.00	18.15	2.15	360	360	vertical
6.	19977.31	39.58	35.58	15.51	55.09	51.09	74.00	54.00	18.91	2.91	178	171	vertical

Remarks: C.F (Correction Factor) = Antenna factor + Cable loss - Preamp gain

Radiated Emissions – Zigbee(Middle)

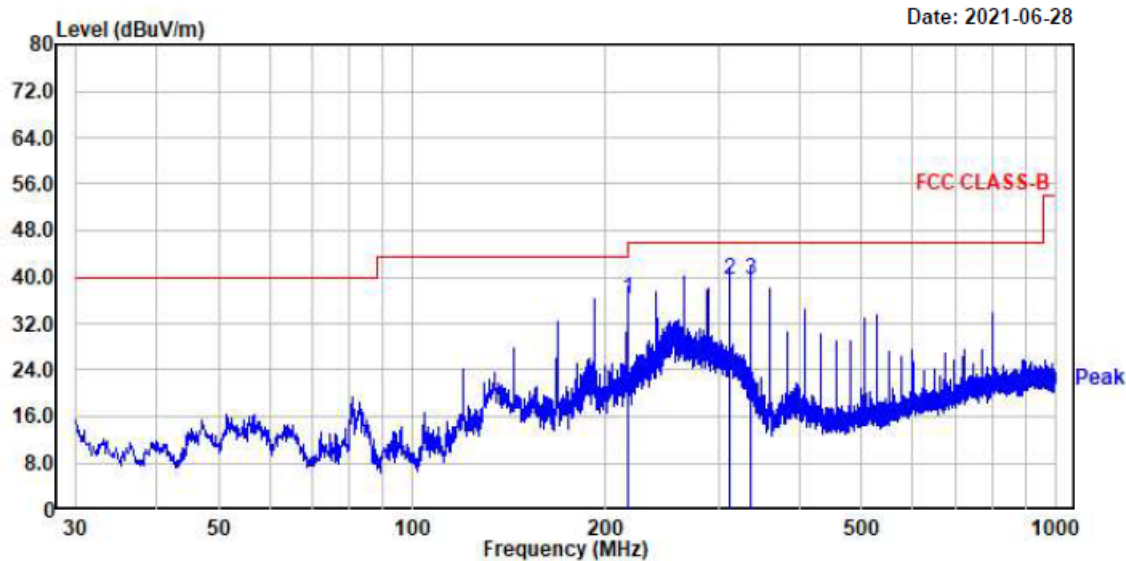

No.	Freq MHz	Reading dBμV	C.F dB	Result QP dBμV/m	Limit dBμV/m	Margin dB	Height cm	Angle deg	Polarity
1.	216.00	55.54	-19.21	36.33	43.50	7.17	172	0	horizontal
2.	312.03	54.65	-15.06	39.59	46.00	6.41	100	3	horizontal
3.	336.04	53.98	-14.33	39.65	46.00	6.35	100	3	horizontal

Remarks: C.F (Correction Factor) = Antenna factor + Cable loss - Preamp gain

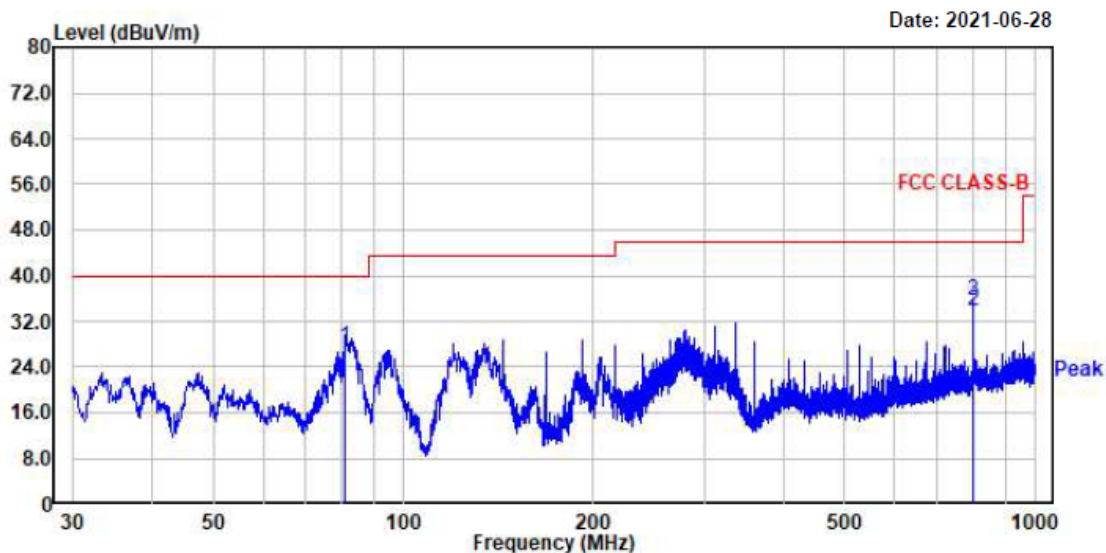

No.	Freq MHz	Reading dBμV	C.F dB	Result QP dBμV/m	Limit dBμV/m	Margin dB	Height cm	Angle deg	Polarity
1.	80.93	48.50	-21.06	27.44	40.00	12.56	100	134	vertical
2.	796.54	38.27	-4.31	33.96	46.00	12.04	153	0	vertical
3.	799.82	39.70	-4.17	35.53	46.00	10.47	153	0	vertical

Remarks: C.F (Correction Factor) = Antenna factor + Cable loss - Preamp gain

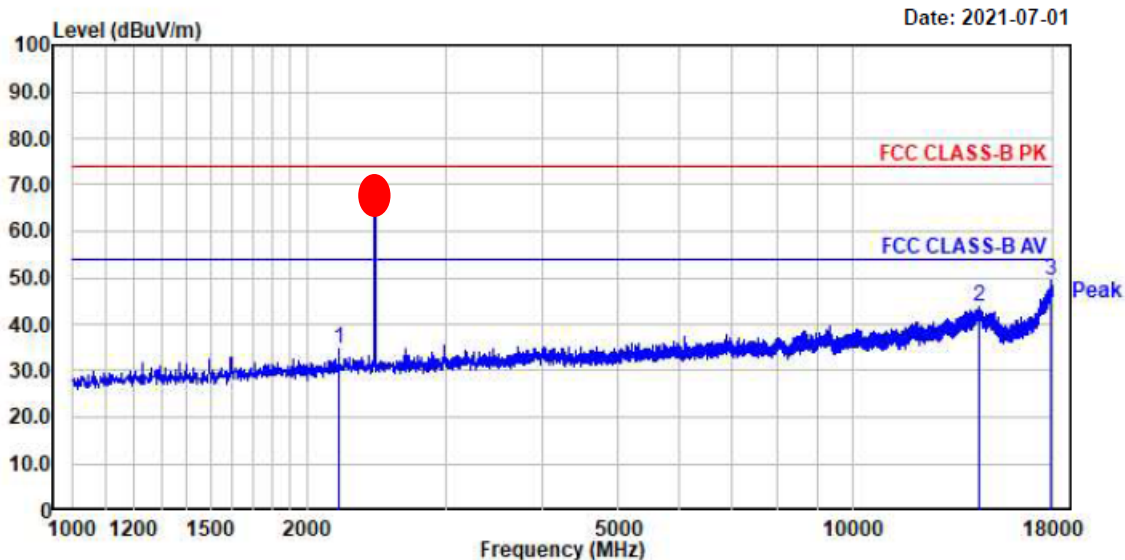

No.	Freq MHz	Reading dB μ V	C.F dB	Result QP dB μ V/m	Limit dB μ V/m	Margin dB	Height cm	Angle deg	Polarity
1.	2194.25	43.29	-8.61	34.68	74.00	39.32	360	360	horizontal
2.	14489.50	33.36	10.36	43.72	74.00	30.28	54	60	horizontal
3.	17966.00	34.65	14.85	49.50	74.00	24.50	9	14	horizontal

Remarks: C.F (Correction Factor) = Antenna factor + Cable loss - Preamp gain

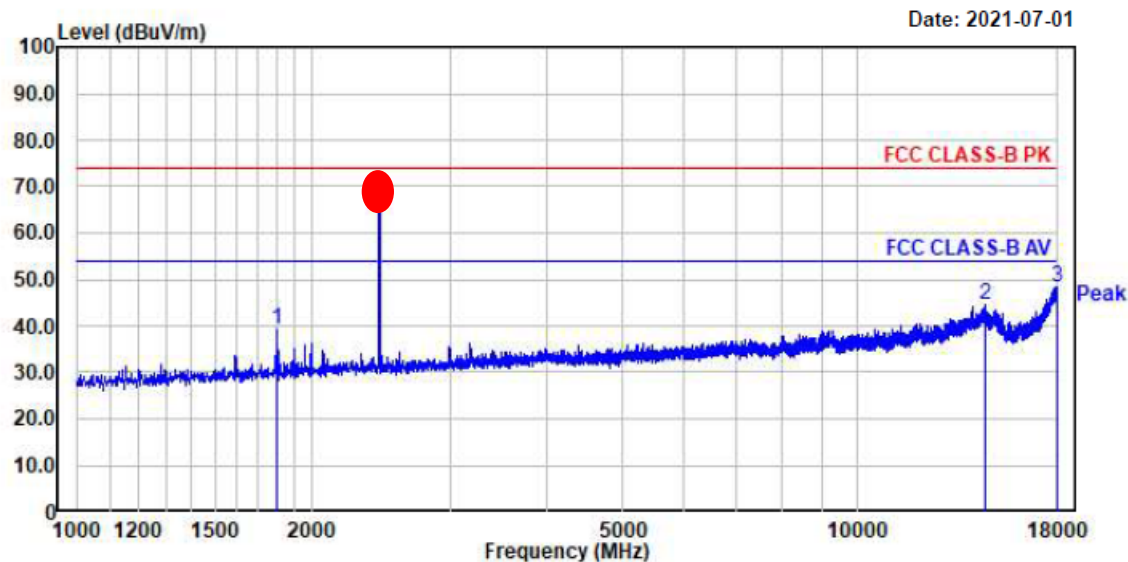

No.	Freq MHz	Reading dB μ V	C.F dB	Result QP dB μ V/m	Limit dB μ V/m	Margin dB	Height cm	Angle deg	Polarity
1.	1805.38	49.53	-10.41	39.12	74.00	34.88	165	157	vertical
2.	14540.50	34.43	10.27	44.70	74.00	29.30	85	78	vertical
3.	17976.63	33.48	14.91	48.39	74.00	25.61	179	172	vertical

Remarks: C.F (Correction Factor) = Antenna factor + Cable loss - Preamp gain

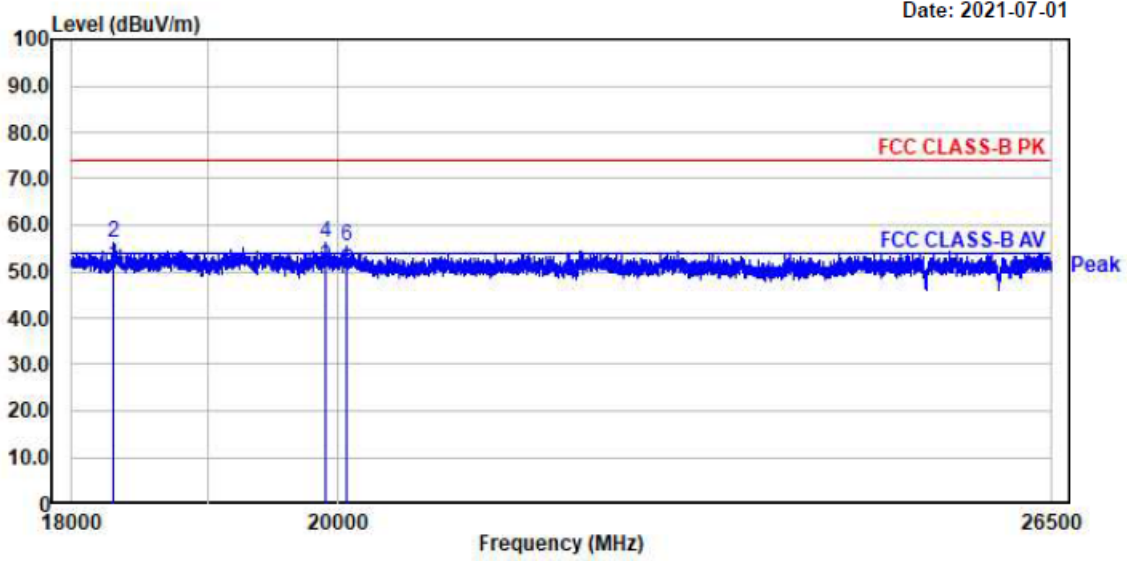

No.	Freq MHz	RD PK dBμV	RD AV dBμV	C.F dB	Result PK dBμV	Result AV dBμV	Limit PK dBμV	Limit AV dBμV	Margin PK dB	Margin AV dB	Height cm	Angle deg	Polarity
2.	18298.56	39.22	34.22	17.06	56.28	51.28	74.00	54.00	17.72	2.72	154	162	horizontal
4.	19899.75	40.37	35.37	15.67	56.04	51.04	74.00	54.00	17.96	2.96	282	288	horizontal
6.	20059.13	39.91	34.91	15.39	55.30	50.30	74.00	54.00	18.70	3.70	296	302	horizontal

Remarks: C.F (Correction Factor) = Antenna factor + Cable loss - Preamp gain

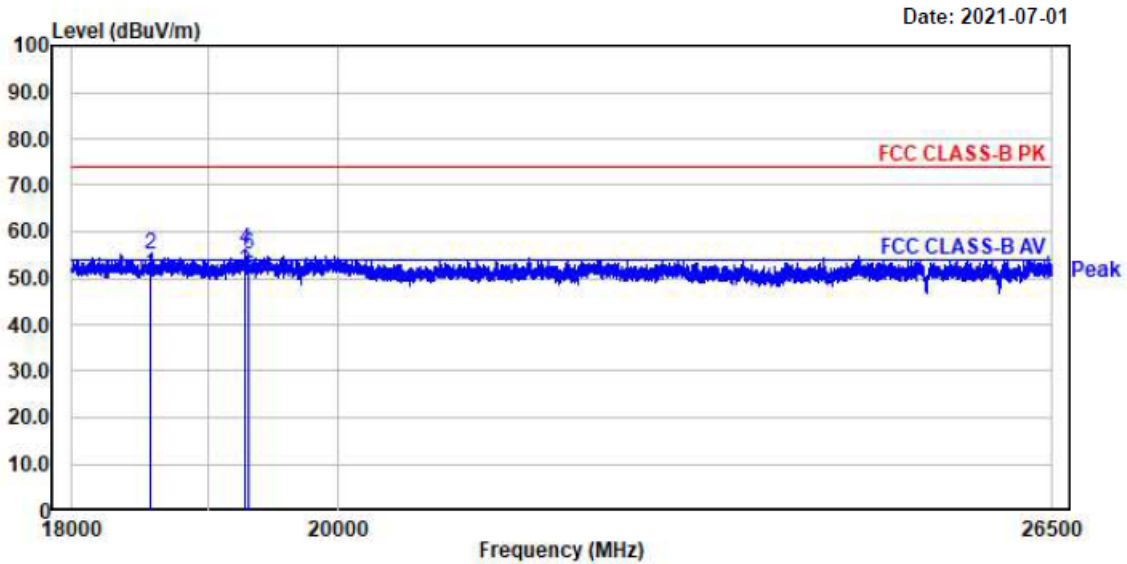

No.	Freq MHz	RD PK dBμV	RD AV dBμV	C.F dB	Result PK dBμV	Result AV dBμV	Limit PK dBμV	Limit AV dBμV	Margin PK dB	Margin AV dB	Height cm	Angle deg	Polarity
2.	18565.25	38.16	34.16	16.93	55.09	51.09	74.00	54.00	18.91	2.91	132	125	vertical
4.	19277.13	39.83	34.83	16.38	56.21	51.21	74.00	54.00	17.79	2.79	360	360	vertical
6.	19306.88	38.81	33.81	16.35	55.16	50.16	74.00	54.00	18.84	3.84	225	220	vertical

Remarks: C.F (Correction Factor) = Antenna factor + Cable loss - Preamp gain

Radiated Emissions – Zigbee(High)

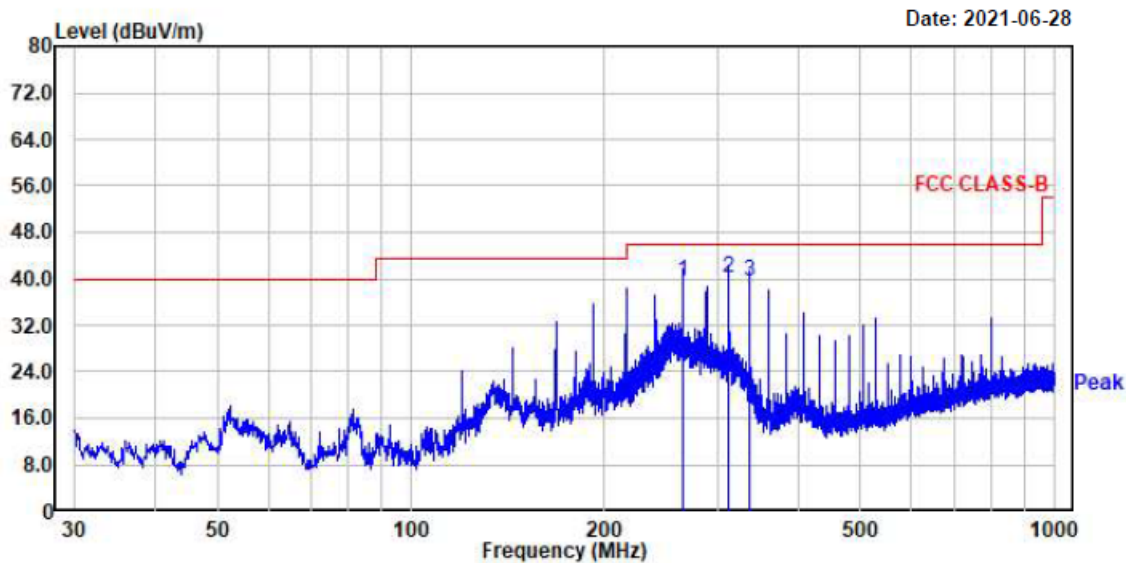

No.	Freq MHz	Reading dBμV	C.F dB	Result QP dBμV/m	Limit dBμV/m	Margin dB	Height cm	Angle deg	Polarity
1.	264.01	56.50	-16.93	39.57	46.00	6.43	100	4	horizontal
2.	312.03	55.33	-15.06	40.27	46.00	5.73	100	4	horizontal
3.	336.04	53.73	-14.33	39.40	46.00	6.60	100	15	horizontal

Remarks: C.F (Correction Factor) = Antenna factor + Cable loss - Preamp gain

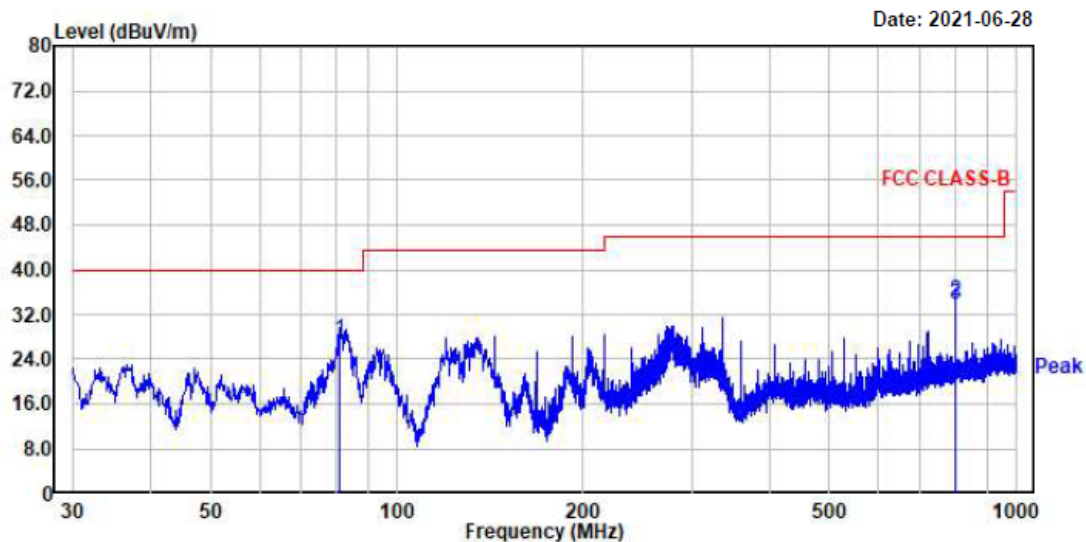

No.	Freq MHz	Reading dBμV	C.F dB	Result QP dBμV/m	Limit dBμV/m	Margin dB	Height cm	Angle deg	Polarity
1.	80.93	48.61	-21.06	27.55	40.00	12.45	100	147	vertical
2.	796.54	38.69	-4.31	34.38	46.00	11.62	150	0	vertical
3.	799.82	37.94	-4.17	33.77	46.00	12.23	150	0	vertical

Remarks: C.F (Correction Factor) = Antenna factor + Cable loss - Preamp gain

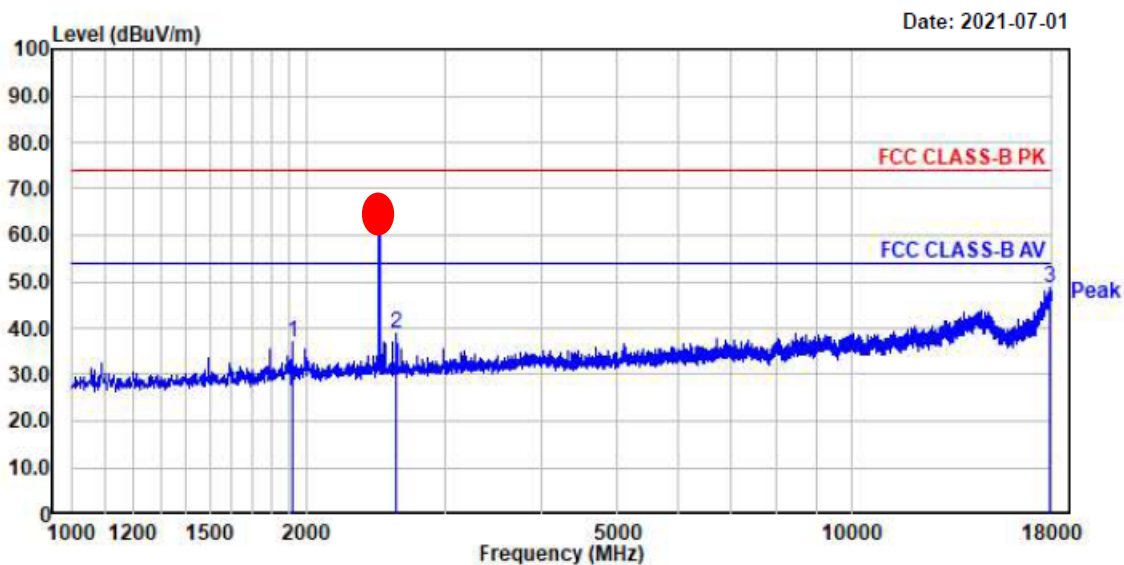

Date: 2021-07-01

No.	Freq MHz	Reading dB μ V	C.F dB	Result QP dB μ V/m	Limit dB μ V/m	Margin dB	Height cm	Angle deg	Polarity
1.	1915.88	46.86	-9.80	37.06	74.00	36.94	197	205	horizontal
2.	2600.13	46.10	-7.18	38.92	74.00	35.08	280	287	horizontal
3.	17902.25	34.28	14.48	48.76	74.00	25.24	360	360	horizontal

Remarks: C.F (Correction Factor) = Antenna factor + Cable loss - Preamp gain

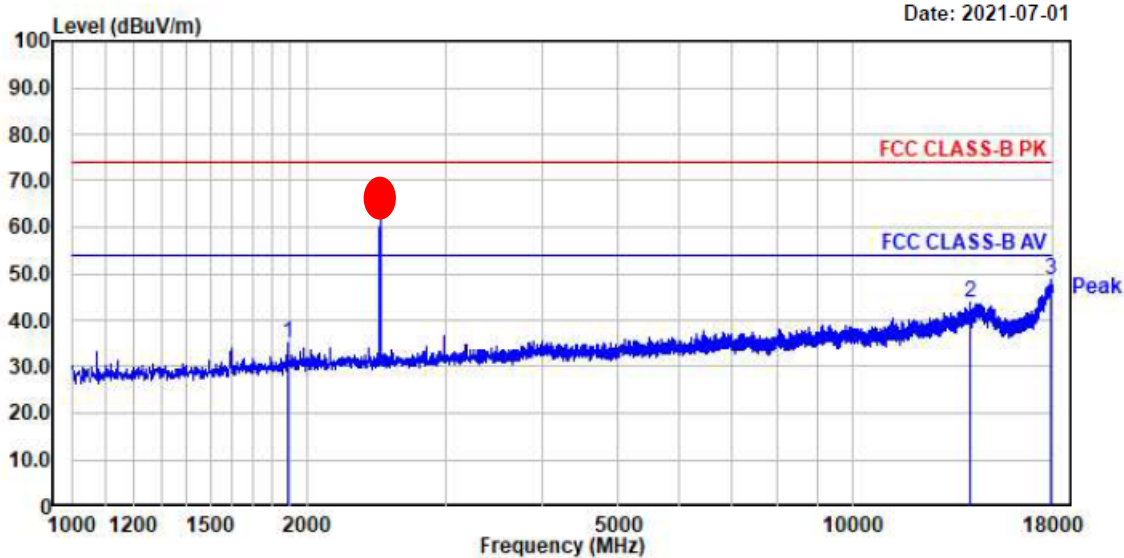

Date: 2021-07-01

No.	Freq MHz	Reading dB μ V	C.F dB	Result QP dB μ V/m	Limit dB μ V/m	Margin dB	Height cm	Angle deg	Polarity
1.	1890.38	45.15	-9.94	35.21	74.00	38.79	196	188	vertical
2.	14153.75	34.32	9.44	43.76	74.00	30.24	306	298	vertical
3.	17904.38	34.01	14.49	48.50	74.00	25.50	260	252	vertical

Remarks: C.F (Correction Factor) = Antenna factor + Cable loss - Preamp gain

Date: 2021-07-01

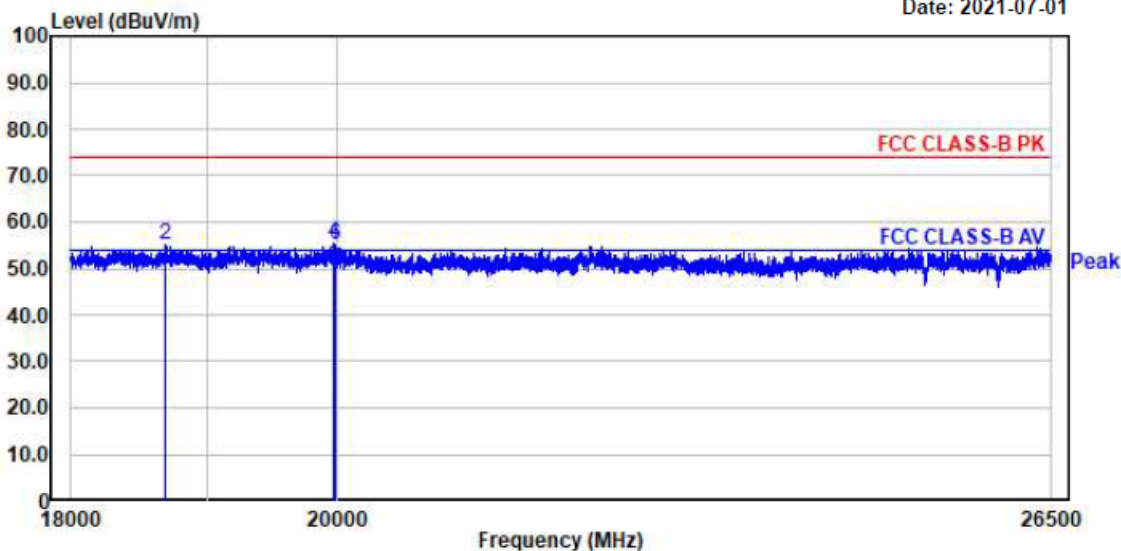

No.	Freq MHz	RD PK dBμV	RD AV dBμV	C.F dB	Result PK dBμV	Result AV dBμV	Limit PK dBμV	Limit AV dBμV	Margin PK dB	Margin AV dB	Height cm	Angle deg	Polarity
2.	18683.19	38.32	33.32	16.85	55.17	50.17	74.00	54.00	18.83	3.83	163	170	horizontal
4.	19970.94	39.82	34.82	15.52	55.34	50.34	74.00	54.00	18.66	3.66	360	360	horizontal
6.	19976.25	39.40	34.40	15.51	54.91	49.91	74.00	54.00	19.09	4.09	39	44	horizontal

Remarks: C.F (Correction Factor) = Antenna factor + Cable loss - Preamp gain

Date: 2021-07-01

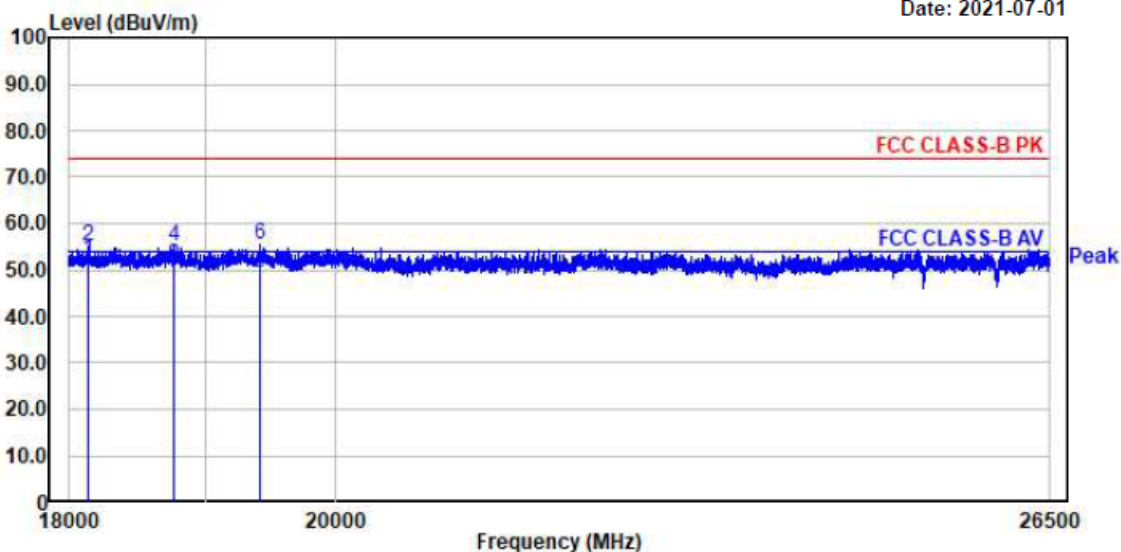

No.	Freq MHz	RD PK dBμV	RD AV dBμV	C.F dB	Result PK dBμV	Result AV dBμV	Limit PK dBμV	Limit AV dBμV	Margin PK dB	Margin AV dB	Height cm	Angle deg	Polarity
2.	18136.00	37.98	34.98	16.98	54.96	51.96	74.00	54.00	19.04	2.04	229	221	vertical
4.	18756.50	38.14	34.14	16.78	54.92	50.92	74.00	54.00	19.08	3.08	360	360	vertical
6.	19415.25	39.21	33.21	16.23	55.44	49.44	74.00	54.00	18.56	4.56	353	348	vertical

Remarks: C.F (Correction Factor) = Antenna factor + Cable loss - Preamp gain

3.2.7 AC Conducted Emissions

Procedure:

The conducted emissions are measured in the shielded room with a spectrum analyzer in peak hold. While the measurement, EUT had its hopping function disabled at the middle channels in line with Section 15.31(m). Emissions closest to the limit are measured in the quasi-peak mode (QP) with the tuned receiver using a bandwidth of 9 kHz. The emissions are maximized further by cable manipulation and Exerciser operation. The highest emissions relative to the limit are listed.

Minimum Standard: FCC Part 15.207(a)

Measurement Data: N/A

Class B

Frequency Range	quasi-peak	Average
0.15 ~ 0.5	66 to 56 *	56 to 46 *
0.5 ~ 5	56	46
5 ~ 30	60	50

* Decreases with the logarithm of the frequency

APPENDIX
TEST EQUIPMENT USED FOR TESTS

	Use	Description	Model No.	Serial No.	Manufacturer	Interval	Next Cal. Date
1	■	Signal Analyzer (9 kHz ~ 30 GHz)	FSV30	100757	R&S	1 year	2021-09-06
2	■	Signal Generator (~3.2 GHz)	8648C	3623A02597	HP	1 year	2022-03-16
3		SYNTHESIZED CW GENERATOR	83711B	US34490456	HP	1 year	2022-03-16
4		Attenuator (3 dB)	8491A	37822	HP	1 year	2021-09-06
5		Attenuator (10 dB)	8491A	63196	HP	1 year	2021-09-06
6	■	EMI Test Receiver (~7 GHz)	ESCI7	100722	R&S	1 year	2021-09-06
7		RF Amplifier (~1.3 GHz)	8447D OPT 010	2944A07684	HP	1 year	2021-09-06
8		RF Amplifier (1~26.5 GHz)	8449B	3008A02126	HP	1 year	2022-03-16
9	■	Horn Antenna (1~18 GHz)	3115	00114105	ETS	2 year	2022-09-06
10	■	DRG Horn (Small)	3116B	81109	ETS-Lindgren	2 year	2022-03-18
11		DRG Horn (Small)	3116B	133350	ETS-Lindgren	2 year	2022-03-18
12	■	TRILOG Antenna	VULB 9160	9160-3237	SCHWARZBECK	2 year	2023-03-20
13		Temp.Humidity Data Logger	SK-L200TH II A	00801	SATO	1 year	2022-03-16
14		Splitter (SMA)	ZFSC-2-2500	SF617800326	Mini-Circuits	-	-
15	■	DC Power Supply	6674A	3637A01657	Agilent	-	-
17	■	Power Meter	EPM-441A	GB32481702	HP	1 year	2022-03-16
18	■	Power Sensor	8481A	3318A94972	HP	1 year	2021-09-06
19		Audio Analyzer	8903B	3729A18901	HP	1 year	2021-09-06
20		Modulation Analyzer	8901B	3749A05878	HP	1 year	2021-09-06
21		TEMP & HUMIDITY Chamber	YJ-500	LTAS06041	JinYoung Tech	1 year	2021-09-06
22		Stop Watch	HS-3	812Q08R	CASIO	2 year	2022-03-18
23		LISN	KNW-407	8-1430-1	Kyoritsu	1 year	2021-09-06
24		Two-Lime V-Network	ESH3-Z5	893045/017	R&S	1 year	2022-03-16
25		UNIVERSAL RADIO COMMUNICATION TESTER	CMU200	106243	R&S	1 year	2022-03-16
26		Highpass Filter	WHKX1.5/15G-10SS	74	Wainwright Instruments	1 year	2022-03-16
27		Highpass Filter	WHKX3.0/18G-10SS	118	Wainwright Instruments	1 year	2022-03-16
28		OSP120 BASE UNIT	OSP120	101230	R&S	1 year	2022-03-16
29		Signal Generator(100 kHz ~ 40 GHz)	SMB100A03	177621	R&S	1 year	2022-03-16
30		Signal Analyzer (10 Hz ~ 40 GHz)	FSV40	101367	R&S	1 year	2022-03-16
31	■	Active Loop Antenna	FMZB 1519	1519-031	SCHWARZBECK	2 year	2023-02-26