

FCC Test Report

Product Name : JP6S
Model No. : P06SC, P06SA
FCC ID : 2AZJJP6S

Applicant : Securus Technologies, LLC
Address : 4000 International Parkway, Carrollton Texas, United States 75007

Date of Receipt : Jul. 08, 2021
Issued Date : Nov. 24, 2021
Report No. : 2170323R-E3032110108-A
Report Version : V1.0



The test results relate only to the samples tested.

The test results shown in the test report are traceable to the national/international standard through the calibration of the equipment and evaluated measurement uncertainty herein.

This report must not be used to claim product endorsement by TAF or any agency of the government.

Measurement uncertainties evaluated for each testing system and associated connections are given here to provide the system information for reference. Compliance determinations do not take into account measurement uncertainties for each testing system but are based on the results of the compliance measurement.

The test report shall not be reproduced except in full without the written approval of DEKRA Testing and Certification Co., Ltd.

Revision History

Version	Description	Issued Date
V1.0	Initial issue of report	Nov. 24, 2021

TABLE OF CONTENTS

Description	Page
1. General Information	6
1.1. EUT Description	6
1.2. Test Mode.....	8
1.3. Comments and Remarks	9
1.4. Tested System Details	9
1.5. Configuration of tested System.....	9
1.6. EUT Operation of during Test	9
1.7. Test Facility	10
1.8. List of Test Equipment	12
1.9. Measurement Uncertainty.....	13
1.10. Duty Cycle	14
2. AC Power Line Conducted Emission	15
2.1. Test Setup	15
2.2. Test Limit	15
2.3. Test Procedure	15
2.4. Test Specification	15
2.5. Test Result of AC Power Line Conducted Emission	16
3. Maximum Conducted Output Power	18
3.1. Test Setup	18
3.2. Test Limit	18
3.3. Test Procedures	18
3.4. Test Specification	18
3.5. Test Result of Maximum Conducted Output Power	19
4. Radiated Emission	20
4.1. Test Setup	20
4.2. Test Limit	21
4.3. Test Procedure	21
4.4. Test Specification	21
4.5. Test Result of Radiated Emissions (30 MHz ~ 1 GHz).....	22
4.6. Test Result of Radiated Emissions (1 GHz ~ 10 th Harmonic)	24
5. Antenna Port Conducted Emission	28
5.1. Test Setup	28
5.2. Test Limit	28
5.3. Test Procedure	28
5.4. Test Specification	28
5.5. Test Result of Antenna Port Conducted Emission.....	29

6.	Radiated Emission Band Edge	31
6.1.	Test Setup	31
6.2.	Test Limit	31
6.3.	Test Procedure	32
6.4.	Test Specification	32
6.5.	Test Result of Radiated Emission Band Edge.....	33
7.	Number of Hopping Frequency	38
7.1.	Test Setup	38
7.2.	Test Limit	38
7.3.	Test Procedures	38
7.4.	Test Specification	38
7.5.	Test Result of Number of Hopping Frequency	39
8.	Carrier Frequency Separation.....	40
8.1.	Test Setup	40
8.2.	Test Limit	40
8.3.	Test Procedures	40
8.4.	Test Specification	40
8.5.	Test Result of Carrier Frequency Separation	41
9.	20dB Bandwidth.....	43
9.1.	Test Setup	43
9.2.	Test Limit	43
9.3.	Test Procedures	43
9.4.	Test Specification	43
9.5.	Test Result of 20dB Bandwidth.....	44
10.	Dwell Time.....	46
10.1.	Test Setup	46
10.2.	Test Limit	46
10.3.	Test Procedures	46
10.4.	Test Specification	46
10.5.	Test Result of Dwell Time	47
Appendix A	49
	Test Setup Photograph	49

1. General Information

1.1. EUT Description

Product Name	JP6S
Model No.	P06SC, P06SA
Frequency Range	2402 ~ 2480 MHz
Channel Number	79 Channels
Type of Modulation	Frequency Hopping Spread Spectrum
Data Rate	BR uses a GFSK (1 Mbps)
	EDR uses a combination of $\pi/4$ -DQPSK (2 Mbps) and 8DPSK (3 Mbps)

Accessories Information				
No.	Equipment Name	Brand Name	Model No.	Rating
1	Lithium Ion Battery	DongGuan GanFeng	6494A0	DC 3.7V 8000mAh/29.6Wh

The difference for each model is shown as below:

EUT	Model No.	Description
1	P06SC (Main Model)	The main model is P06SC with camera design. For the variant model P06SA, the Camera, FPC connector, and related RCs are not populated.
2	P06SA (Variant Model)	

Antenna Information				
Ant.	Brand Name	Model No.	Type	Gain (dBi)
0	PCI Private Limited	SRPC000101	PCB	2.86

Working Frequency of Each Channel							
Channel	Frequency	Channel	Frequency	Channel	Frequency	Channel	Frequency
00	2402 MHz	20	2422 MHz	40	2442 MHz	60	2462 MHz
01	2403 MHz	21	2423 MHz	41	2443 MHz	61	2463 MHz
02	2404 MHz	22	2424 MHz	42	2444 MHz	62	2464 MHz
03	2405 MHz	23	2425 MHz	43	2445 MHz	63	2465 MHz
04	2406 MHz	24	2426 MHz	44	2446 MHz	64	2466 MHz
05	2407 MHz	25	2427 MHz	45	2447 MHz	65	2467 MHz
06	2408 MHz	26	2428 MHz	46	2448 MHz	66	2468 MHz
07	2409 MHz	27	2429 MHz	47	2449 MHz	67	2469 MHz
08	2410 MHz	28	2430 MHz	48	2450 MHz	68	2470 MHz
09	2411 MHz	29	2431 MHz	49	2451 MHz	69	2471 MHz
10	2412 MHz	30	2432 MHz	50	2452 MHz	70	2472 MHz
11	2413 MHz	31	2433 MHz	51	2453 MHz	71	2473 MHz
12	2414 MHz	32	2434 MHz	52	2454 MHz	72	2474 MHz
13	2415 MHz	33	2435 MHz	53	2455 MHz	73	2475 MHz
14	2416 MHz	34	2436 MHz	54	2456 MHz	74	2476 MHz
15	2417 MHz	35	2437 MHz	55	2457 MHz	75	2477 MHz
16	2418 MHz	36	2438 MHz	56	2458 MHz	76	2478 MHz
17	2419 MHz	37	2439 MHz	57	2459 MHz	77	2479 MHz
18	2420 MHz	38	2440 MHz	58	2460 MHz	78	2480 MHz
19	2421 MHz	39	2441 MHz	59	2461 MHz	-	-

Note:

1. Regards to the frequency band operation; the lowest , middle and highest frequency of channel were selected to perform the test, and then shown on this report.
2. The above EUT information is declared by the manufacturer.

1.2. Test Mode

DEKRA has verified the construction and function in typical operation. All the test modes were carried out with the EUT in transmitting operation, which was shown in this test report and defined as follows:

Test Mode	Mode 1: Transmit				
Test Items	Test Mode	EUT	Modulation	Channel	Result
AC Power Line Conducted Emission	Mode 1	1	GFSK	39	Pass
Maximum Conducted Output Power	Mode 1	1	GFSK	00/39/78	Pass
			8-DPSK	00/39/78	Pass
Radiated Emission Below 1 GHz	Mode 1	1/2	GFSK	39	Pass
Radiated Emission Above 1 GHz	Mode 1	1	GFSK	00/39/78	Pass
			8-DPSK	00/39/78	Pass
		2	GFSK	39	Pass
Antenna Port Conducted Emission	Mode 1	1	GFSK	00/39/78	Pass
			8-DPSK	00/39/78	Pass
Radiated Emission Band Edge	Mode 1	1	GFSK	00/39/78	Pass
			8-DPSK	00/39/78	Pass
		2	GFSK	39	Pass
Number of Hopping Frequency	Mode 1	1	GFSK	Hopping mode	Pass
Carrier Frequency Separation	Mode 1	1	GFSK	00/39/78	Pass
			8-DPSK	00/39/78	Pass
20dB Bandwidth	Mode 1	1	GFSK	00/39/78	Pass
			8-DPSK	00/39/78	Pass
Dwell Time	Mode 1	1	GFSK	00/39/78	Pass
			8-DPSK	00/39/78	Pass

Note:

- Determining compliance shall be based on the results of the compliance measurement, not taking into account measurement instrumentation uncertainty.
- Pre-Scan has been conducted to determine the worst-case mode from all possible combinations between available modulations, data rates and antenna ports (if EUT with antenna diversity architecture).
- For below 1 GHz radiated emission and AC Power Line Conducted Emission have performed all modes of operation were investigated and the worst-case emissions are reported.
- The EUT was performed at X axis, Y axis and Z axis position for radiated emission and band edge tests. The worst case was found at Z axis, so the measurement will follow this same test configuration.
- The EUT 2 was performed radiated emission and radiated emission band edge test only, and measurement was followed the worst case of EUT 1.

1.3. Comments and Remarks

The product specification and testing instructions for the EUT declared in the report are provided by the manufacturer who will take all responsibilities for the accuracy.

1.4. Tested System Details

The types for all equipment, plus descriptions of all cables used in the tested system (including inserted cards):

	Product	Manufacturer	Model No.	Serial No.
1	Adapter	Shenzhen Mi Delan Electronic Technology Co., Ltd.	AS015C-0502500UC	N/A
2	Earphone	Shenzhen Huaxunxing Technology Co., Ltd.	HX-20208002	N/A

1.5. Configuration of tested System

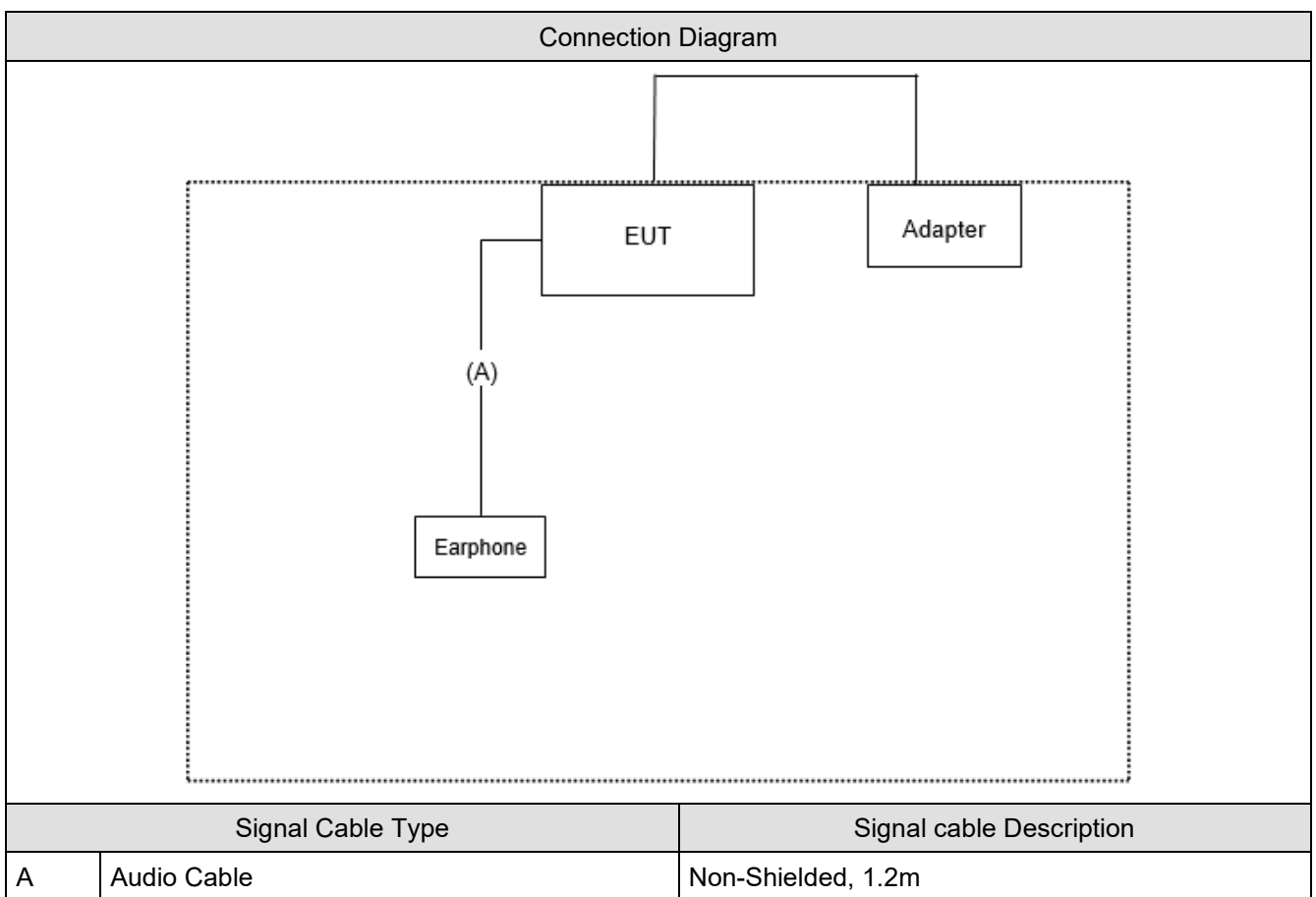

1.6. EUT Operation of during Test

1	Set the EUT as shown.
2	Start engineering mode
3	Configure test mode, test channel and data rate.
4	Let the EUT start sending transmit continuously
5	Verify that device is working properly.

1.7. Test Facility

Ambient conditions in the laboratory:

Items	Test Item	EUT	Actually	Tested by	Test Date	Test Site
Temperature (°C)	AC Power Line Conducted Emission	1	25.6	Lion Wang	2021/10/8	SR2-H
Humidity (%RH)			55.7			
Temperature (°C)	Maximum Conducted Output Power	1	23 ~ 24	Elwin Lin	2021/10/1 ~ 2021/10/4	SR12-H
Humidity (%RH)			59 ~ 67	Clemens Fang		
Temperature (°C)	Radiated Emission	1	25.5	Ling Chen	2021/9/14	CB2-H
Humidity (%RH)			59			
Temperature (°C)		2	23.5 ~ 24.1	Getaz Yang	2021/11/3 ~ 2021/11/4	CB2-H
Humidity (%RH)			61 ~ 64			
Temperature (°C)	Antenna Port Conducted Emission	1	23 ~ 25	Clemens Fang	2021/10/7 ~ 2021/10/19	SR12-H
Humidity (%RH)			67 ~ 68			
Temperature (°C)	Radiated Emission Band Edge	1	24.3	Cyril Chen	2021/9/15	CB2-H
Humidity (%RH)			63.8			
Temperature (°C)		2	23.5 ~ 24.1	Getaz Yang	2021/11/3 ~ 2021/11/4	CB2-H
Humidity (%RH)			61 ~ 64			
Temperature (°C)	Number of Hopping Frequency	1	25	Clemens Fang	2021/10/7	SR12-H
Humidity (%RH)			67			
Temperature (°C)	Carrier Frequency Separation	1	25	Clemens Fang	2021/10/7	SR12-H
Humidity (%RH)			67			
Temperature (°C)	20dB Bandwidth	1	25	Clemens Fang	2021/10/7	SR12-H
Humidity (%RH)			67			
Temperature (°C)	Dwell Time	1	24	Clemens Fang	2021/10/15	SR12-H
Humidity (%RH)			68			

Note: Test site information refers to Laboratory Information.

Laboratory Information

USA : **FCC Registration Number: TW3024**
Canada : **CAB identifier : TW3024**

The address and introduction of DEKRA Testing and Certification Co., Ltd. laboratories can be founded in our Web site: <http://www.dekra.com.tw>

If you have any comments, please don't hesitate to contact us. Our test sites as below:

Test Laboratory	DEKRA Testing and Certification Co., Ltd.
Address	1. No.372-2, Sec. 4, Zhongxing Rd., Zhudong Township, Hsinchu County 31061, Taiwan, R.O.C. 2. No.372, Sec. 4, Zhongxing Rd., Zhudong Township, Hsinchu County 31061, Taiwan, R.O.C.
Phone number	1. +886-3-582-8001 2. +886-3-582-8001
Fax number	1. +886-3-582-8958 2. +886-3-582-8958
Email address	info.tw@dekra.com
Website	http://www.dekra.com.tw
Note: Test site number for address 1 includes SR2-H. Test site number for address 2 includes CB2-H, CB3-H, CB4-H, SR10-H and SR12-H.	

1.8. List of Test Equipment

SR2-H

Instrument	Manufacturer	Model No.	Serial No.	Cal. Date	Next Cal. Date
Artificial Mains Network	R&S	ENV4200	848411/010	2020/12/24	2021/12/23
Test Receiver	R&S	ESCS 30	836858/022	2021/02/22	2022/02/21
LISN	R&S	ENV216	100092	2021/06/08	2022/06/07
Coaxial Cable(9 m)	Harbour	RG-400	SR2-H	2021/08/15	2022/08/14
DEKRA Testing System	DEKRA	Version 2.0	SR2-H	NA	NA

SR12-H

Instrument	Manufacturer	Model No.	Serial No.	Cal. Date	Next Cal. Date
High Speed Peak Power Meter Dual Input	Anritsu	ML2496A	1602004	2020/11/30	2021/11/29
Pulse Power Sensor	Anritsu	MA2411B	1531043	2020/11/30	2021/11/29
EXA Signal Analyzer	Keysight	N9010A	MY51440132	2021/01/25	2022/01/24
Pulse Power Sensor	Anritsu	MA2411B	1531044	2020/11/30	2021/11/29
Power Meter	Keysight	8990B	MY51000248	2021/05/21	2022/05/20
Power Sensor	Keysight	N1923A	MY57240005	2021/05/21	2022/05/20
Spectrum Analyzer	Keysight	N9030B	MY57140404	2021/05/14	2022/05/13
Spectrum Analyzer	Keysight	N9010B	MY57110159	2021/03/29	2022/03/28
Spectrum Analyzer	Agilent	N9010A	US47140172	2021/05/28	2022/05/27
Signal & Spectrum Analyzer	R&S	FSV40	101049	2021/03/31	2022/03/30

CB2-H

Instrument	Manufacturer	Model No.	Serial No.	Cal. Date	Next Cal. Date
Signal Analyzer	R&S	FSVA40	101455	2020/10/12	2021/10/11
Signal Analyzer	R&S	FSVA40	101455	2021/10/21	2022/10/20
Signal & Spectrum Analyzer	R&S	FSV40	101049	2021/03/31	2022/03/30
Signal Analyzer	R&S	FSVA40	101435	2021/06/04	2022/06/03
EXA Signal Analyzer	Keysight	N9010A	MY51440132	2021/01/25	2022/01/24
Trilog Broadband Antenna	Schwarzbeck	VULB 9168	1272	2021/08/20	2022/08/19
Bilog Antenna	Teseq	CBL6112D	23191	2021/02/26	2022/02/25
Horn Antenna	Schwarzbeck	BBHA 9120D	639	2021/05/17	2022/05/16
Horn Antenna	Schwarzbeck	BBHA 9170	202	2020/12/16	2021/12/15
Pre-Amplifier	EMCI	EMC01820I	980365	2021/05/28	2022/05/27
Pre-Amplifier	EMEC	EM01G18GA	060741	2021/07/02	2022/07/01
Pre-Amplifier	DEKRA	AP-400C	201801231	2020/11/16	2021/11/15
Coaxial Cable(13m)	Huber+Suhner	SF104	CB2-H	2021/08/17	2022/08/16
Radiated Software	AUDIX	e3 V9	CB2-H	N/A	N/A

Note: All equipment upon which need to calibrated are with calibration period of 1 year.

1.9. Measurement Uncertainty

Uncertainties have been calculated according to the DEKRA internal document with the emissions test results be included in the report. The measurement uncertainties given below are based on a 95% confidence level (based on a coverage factor (k=2)).

Test item	Uncertainty
AC Power Line Conducted Emission	± 2.10 dB
Maximum Conducted Output Power	± 1.16 dB
Radiated Emission	± 3.25 dB below 1 GHz ± 3.32 dB above 1 GHz
Antenna Port Conducted Emission	± 1.60 dB
Band Edge	± 3.32 dB above 1GHz
Number of Hopping Frequency	N/A
Carrier Frequency Separation	± 282.55 Hz
20dB Bandwidth	± 282.55 Hz
Dwell Time	± 19.555 msec

1.10. Duty Cycle

Modulation	On Times (ms)	On+Off Times (ms)	Duty Cycle (%)	Duty Cycle Correction Factor (dB)
GFSK	2.875	100.000	2.88	-30.83
8-DPSK	2.875	100.000	2.88	-30.83

Note: If the duty cycle correction factor lower than -20dB, the Max. duty cycle correction factor is -20dB.

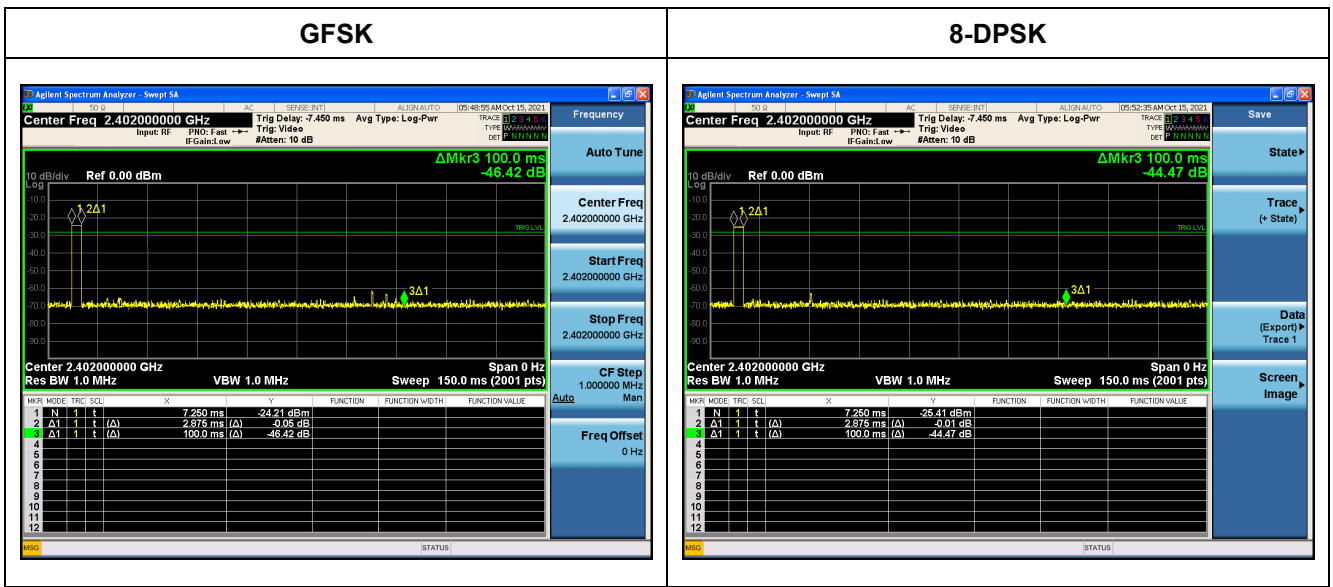

2. AC Power Line Conducted Emission

2.1. Test Setup

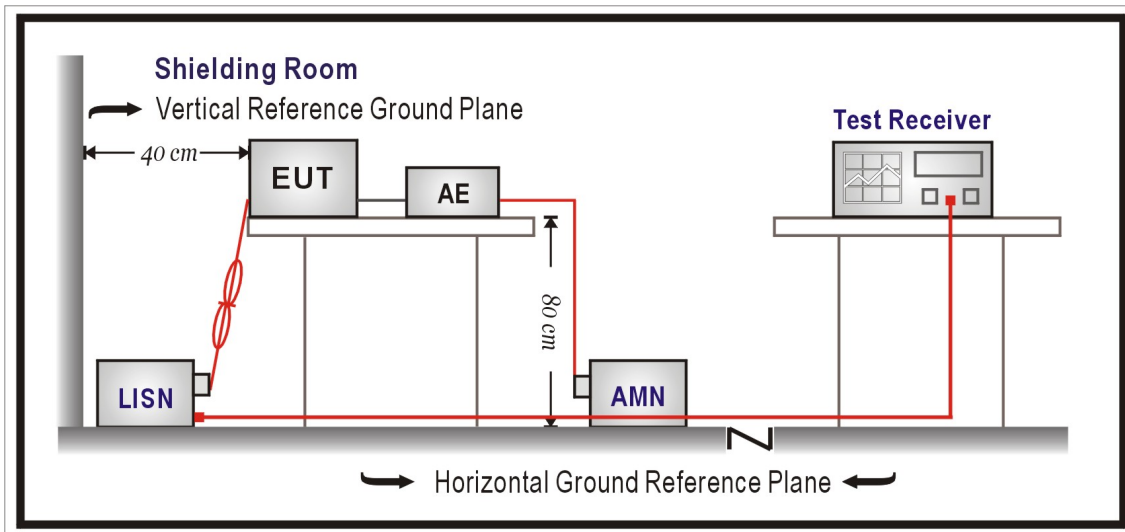

2.2. Test Limit

Frequency (MHz)	QP (dBuV)	AV (dBuV)
0.15 - 0.50	66 - 56	56 - 46
0.50 - 5.0	56	46
5.0 - 30	60	50

Remarks: In the above table, the tighter limit applies at the band edges.

2.3. Test Procedure

The EUT and simulators are connected to the main power through a line impedance stabilization network (L.I.S.N.). This provides a 50 ohm /50uH coupling impedance for the measuring equipment. The peripheral devices are also connected to the main power through a LISN that provides a 50ohm /50uH coupling impedance with 50 ohm termination. (Please refer to the block diagram of the test setup and photographs.)

Both sides of A.C. line are checked for maximum conducted interference. In order to find the maximum emission, the relative positions of equipment and all of the interface cables must be changed according to ANSI C63.10: 2013 on conducted measurement.

Conducted emissions were investigated over the frequency range from 0.15 MHz to 30 MHz using a receiver bandwidth of 9 kHz.

2.4. Test Specification

According to FCC Part 15 Subpart C Paragraph 15.207.

2.5. Test Result of AC Power Line Conducted Emission

Test Mode	Mode 1: Transmit	Phase	Line
Test Condition	GFSK / 2441MHz		

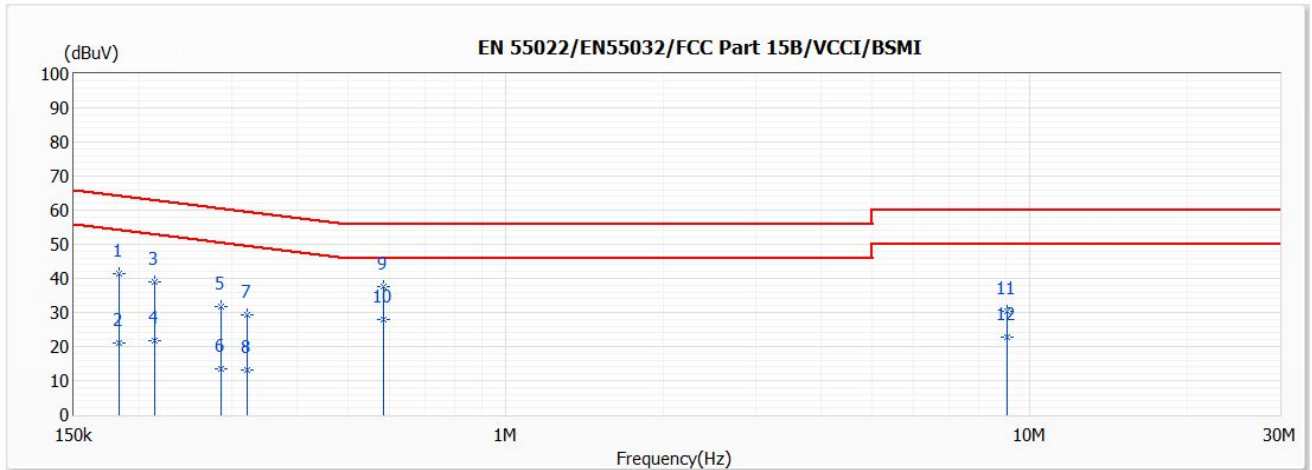

No	Frequency (MHz)	Emission Level (dBuV)	Limit (dBuV)	Margin (dB)	Reading Level (dBuV)	Correct Factor (dB)	Detector Type
1	0.183	41.52	64.37	-22.85	31.89	9.63	QP
2	0.183	20.99	54.37	-33.38	11.36	9.63	AV
3	0.214	39.04	63.04	-24.00	29.40	9.64	QP
4	0.214	21.89	53.04	-31.15	12.25	9.64	AV
5	0.287	31.87	60.61	-28.74	22.22	9.65	QP
6	0.287	13.44	50.61	-37.17	3.79	9.65	AV
7	0.321	29.24	59.68	-30.44	19.59	9.65	QP
8	0.321	13.27	49.68	-36.41	3.62	9.65	AV
9	0.585	37.72	56.00	-18.28	28.04	9.68	QP
*10	0.585	27.78	46.00	-18.22	18.10	9.68	AV
11	9.075	30.22	60.00	-29.78	20.14	10.08	QP
12	9.075	22.85	50.00	-27.15	12.77	10.08	AV

Remark:

1. "*" means this data is the worst emission level.
2. Emission Level = Reading Level + Correct Factor (Correct Factor = LISN Insertion Loss + Cable Loss).
3. Margin = Emission Level - Limit.

Test Mode	Mode 1: Transmit	Phase	Neutral
Test Condition	GFSK / 2441MHz		

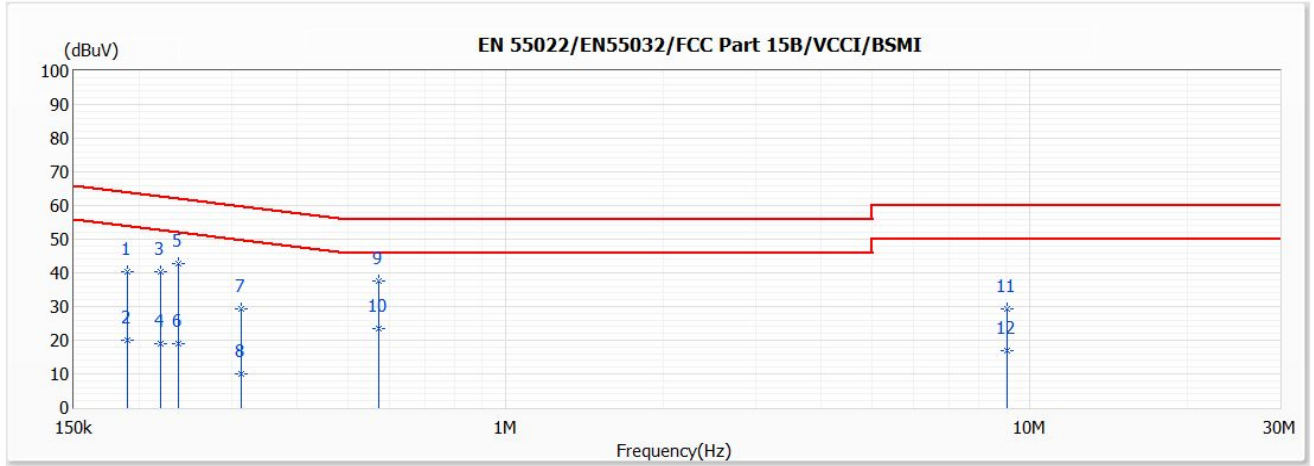

No	Frequency (MHz)	Emission Level (dBuV)	Limit (dBuV)	Margin (dB)	Reading Level (dBuV)	Correct Factor (dB)	Detector Type
1	0.189	40.18	64.06	-23.88	30.55	9.63	QP
2	0.189	20.03	54.06	-34.03	10.40	9.63	AV
3	0.219	40.46	62.86	-22.40	30.82	9.64	QP
4	0.219	19.01	52.86	-33.85	9.37	9.64	AV
5	0.238	42.80	62.18	-19.38	33.16	9.64	QP
6	0.238	19.09	52.18	-33.09	9.45	9.64	AV
7	0.313	29.32	59.89	-30.57	19.66	9.66	QP
8	0.313	9.95	49.89	-39.94	0.29	9.66	AV
*9	0.573	37.61	56.00	-18.39	27.92	9.69	QP
10	0.573	23.46	46.00	-22.54	13.77	9.69	AV
11	9.063	29.19	60.00	-30.81	19.08	10.11	QP
12	9.063	16.95	50.00	-33.05	6.84	10.11	AV

Remark:

1. "*" means this data is the worst emission level.
2. Emission Level = Reading Level + Correct Factor (Correct Factor = LISN Insertion Loss + Cable Loss).
3. Margin = Emission Level - Limit.

3. Maximum Conducted Output Power

3.1. Test Setup

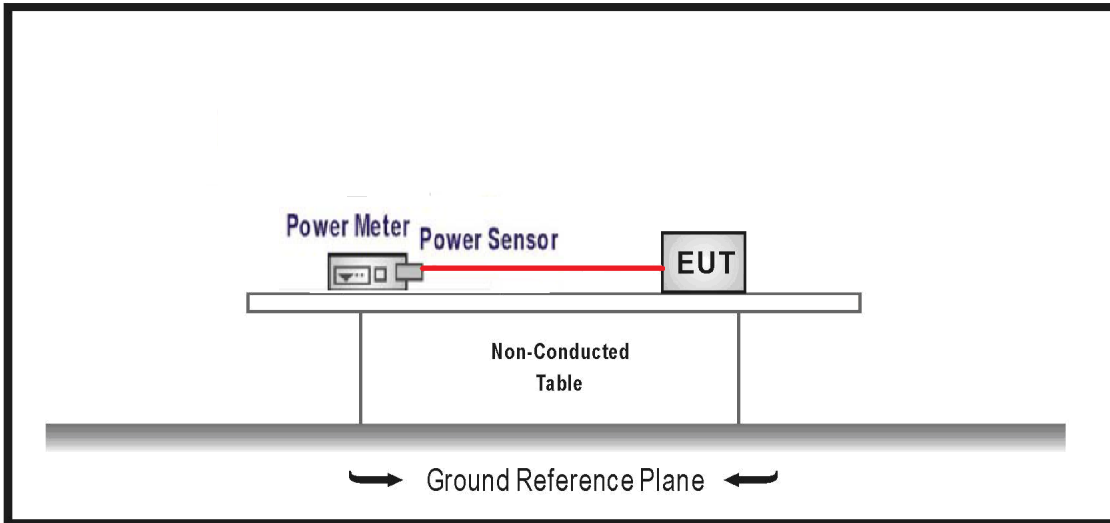

3.2. Test Limit

For frequency hopping systems operating in the 902 ~ 928 MHz band: 1 Watt for systems employing at least 50 hopping channels; and, 0.25 Watts for systems employing less than 50 hopping channels.

For frequency hopping systems operating in the 2400 ~ 2483.5 MHz band employing at least 75 non-overlapping hopping channels, and all frequency hopping systems in the 5725 ~ 5850 MHz band: 1 watt. For all other frequency hopping systems in the 2400 ~ 2483.5 MHz band: 0.125 watts.

3.3. Test Procedures

The EUT was setup according to ANSI C63.10: 2013 and tested according to FHSS test procedure of FCC KDB 558074 D01 v05r02 for compliance to FCC 47CFR 15.247 requirements.

3.4. Test Specification

According to FCC Part 15 Subpart C Paragraph 15.247.

3.5. Test Result of Maximum Conducted Output Power

Modulation	Channel	Frequency (MHz)	Measure Level (dBm)	Limit (dBm)	Result
GFSK	00	2402	7.850	≤ 30.00	Pass
	39	2441	7.720	≤ 30.00	Pass
	78	2480	7.870	≤ 30.00	Pass
8-DPSK	00	2402	6.420	≤ 30.00	Pass
	39	2441	6.360	≤ 30.00	Pass
	78	2480	6.470	≤ 30.00	Pass

4. Radiated Emission

4.1. Test Setup

9 kHz ~ 30 MHz

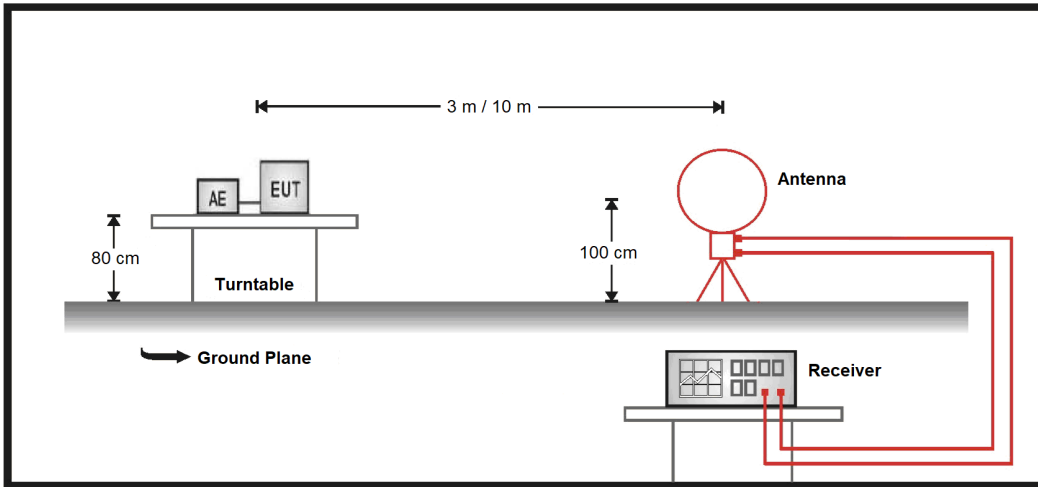

30 MHz ~ 1 GHz

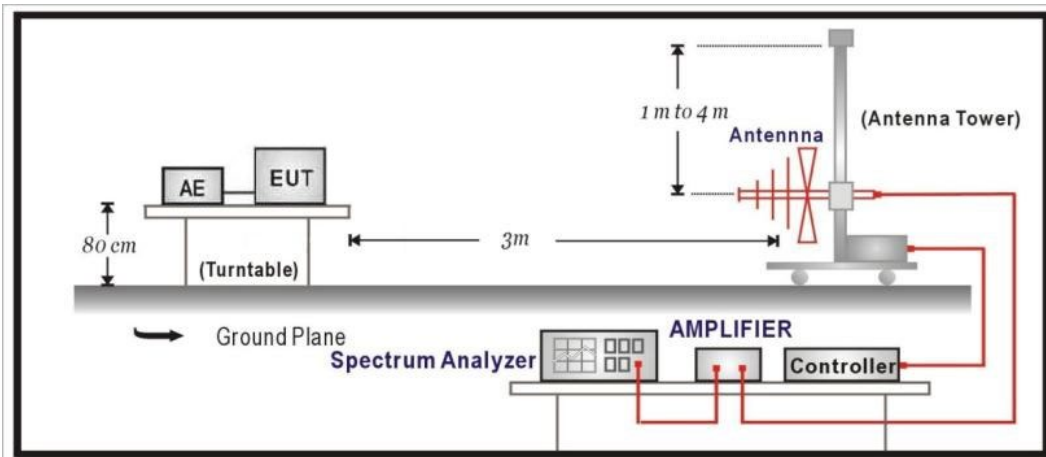

Above 1 GHz

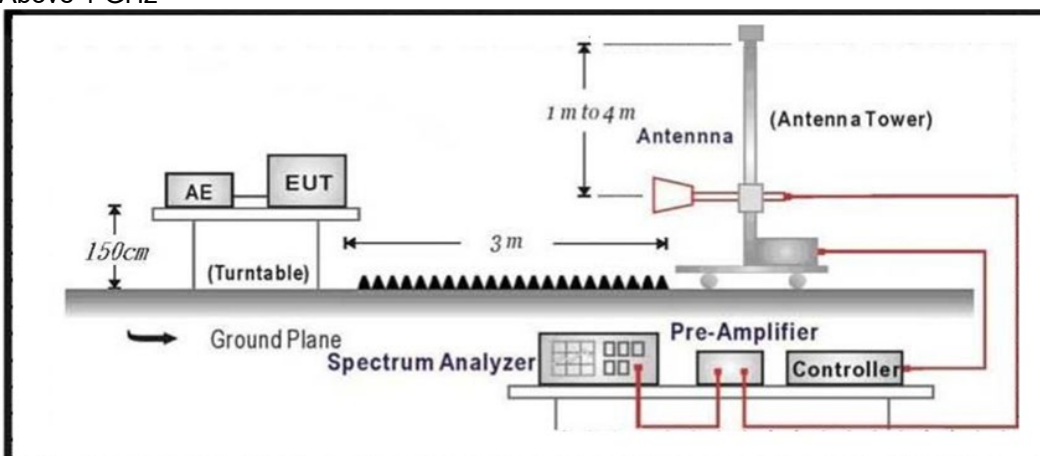

4.2. Test Limit

Emissions radiated outside of the specified frequency bands, except for harmonics, shall be attenuated by at least 20 dB below the level of the fundamental or to the general radiated emission limit in paragraph 15.209, whichever is the lesser attenuation.

Frequency (MHz)	Field strength (uV/m)	Field strength (dBuV/m)	Measurement distance (m)
0.009 – 0.490	2400/F(kHz)	20 log (2400/F(kHz))	300
0.490 – 1.705	24000/F(kHz)	20 log (24000/F(kHz))	30
1.705 - 30	30	29.5	30
30 - 88	100	40	3
88 - 216	150	43.5	3
216 - 960	200	46	3
Above 960	500	54	3

Remarks:

1. Field strength (dBuV/m) = 20 log Field strength (uV/m)
2. In the Above Table, the tighter limit applies at the band edges.
3. Distance refers to the distance in meters between the measuring instrument antenna and the closed point of any part of the device or system

4.3. Test Procedure

The EUT was setup according to ANSI C63.10: 2013 and tested according to FHSS test procedure of FCC KDB 558074 D01 v05r02 for compliance to FCC 47CFR 15.247 requirements.

The EUT and its simulators are placed on a turn table which is 0.8 or 1.5 meter above ground. The turn table can rotate 360 degrees to determine the position of the maximum emission level. The antenna can move up and down between 1 meter and 4 meters to find out the maximum emission level.

Both horizontal and vertical polarization of the antenna are set on measurement. In order to find the maximum emission, all of the interface cables must be manipulated according to ANSI C63.10: 2013 on radiated measurement.

On any frequency or frequencies from 9kHz(inclde The the lowest oscillator frequency generated within the device up to the 10th harmonic) to 1000 MHz, the limit shown are based on measuring equipment employing a quasi-peak detector function and on any frequency or frequencies above 1000 MHz the radiated limit shown are based upon the use of measurement instrumentation employing an average detector function. When average radiated emission measurement are included emission measurement below 1000 MHz, there also is a limit on the radio frequency emissions, as measured using instrumentation with a peak detector function, corresponding to 20 dB above the maximum permitted average limit.

The bandwidth below 1 GHz setting on the field strength meter is 120 kHz and above 1 GHz is 1MHz.

4.4. Test Specification

According to FCC Part 15 Subpart C Paragraph 15.247.

4.5. Test Result of Radiated Emissions (30 MHz ~ 1 GHz)

<For EUT 1>

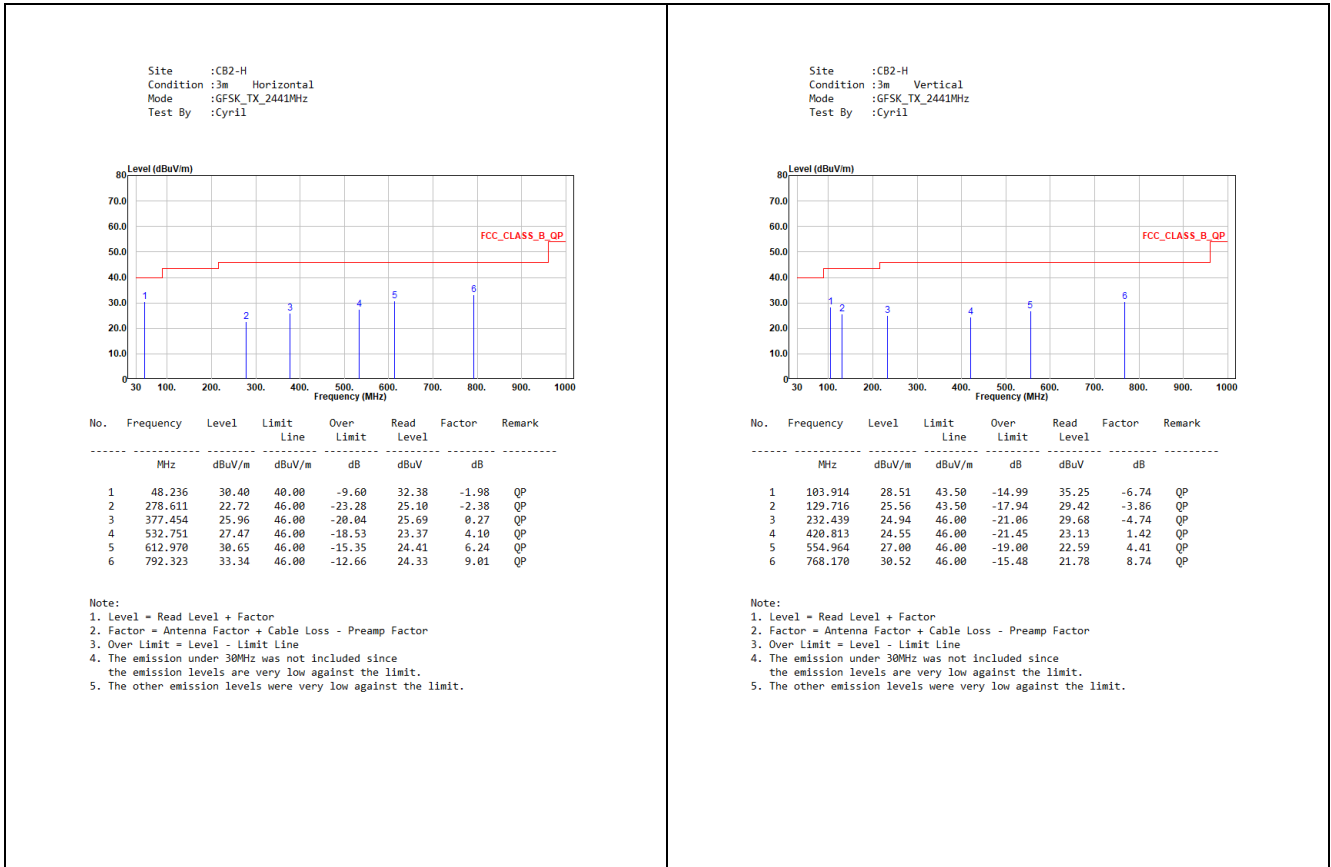

<For EUT 2>

Site :CB2-H
 Condition :3m Horizontal
 Mode :GFSK_TX_2441MHz
 Test By :Getaz

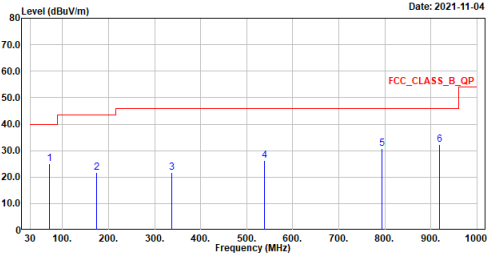

No.	Frequency MHz	Level dBuV/m	Limit dBuV/m	Over Limit dB	Read Level dBuV	Factor dB	Remark
1	70.740	24.97	40.00	-15.03	29.37	-4.40	QP
2	173.560	21.75	43.50	-21.75	24.86	-3.11	QP
3	337.490	21.88	46.00	-24.12	22.59	-0.71	QP
4	539.250	26.18	46.00	-19.82	21.94	4.24	QP
5	794.360	30.80	46.00	-15.20	21.78	9.02	QP
6	918.520	32.29	46.00	-13.71	21.67	10.62	QP

Note:
 1. Level = Read Level + Factor
 2. Factor = Antenna Factor + Cable Loss - Preamp Factor
 3. Over Limit = Level - Limit Line
 4. The emission under 30MHz was not included since the emission levels are very low against the limit.
 5. The other emission levels were very low against the limit.

Site :CB2-H
 Condition :3m Vertical
 Mode :GFSK_TX_2441MHz
 Test By :Getaz

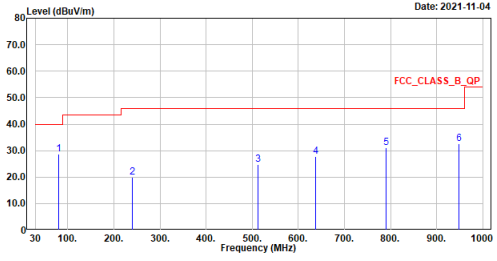

No.	Frequency MHz	Level dBuV/m	Limit dBuV/m	Over Limit dB	Read Level dBuV	Factor dB	Remark
1	79.470	28.78	40.00	-11.22	35.30	-6.52	QP
2	240.490	19.83	46.00	-26.17	23.86	-4.03	QP
3	512.090	24.84	46.00	-21.16	21.20	3.64	QP
4	638.190	27.88	46.00	-18.12	21.36	6.52	QP
5	789.510	31.02	46.00	-14.98	22.02	9.00	QP
6	948.590	32.67	46.00	-13.33	21.54	11.13	QP

Note:
 1. Level = Read Level + Factor
 2. Factor = Antenna Factor + Cable Loss - Preamp Factor
 3. Over Limit = Level - Limit Line
 4. The emission under 30MHz was not included since the emission levels are very low against the limit.
 5. The other emission levels were very low against the limit.

4.6. Test Result of Radiated Emissions (1 GHz ~ 10th Harmonic)

<For EUT 1>

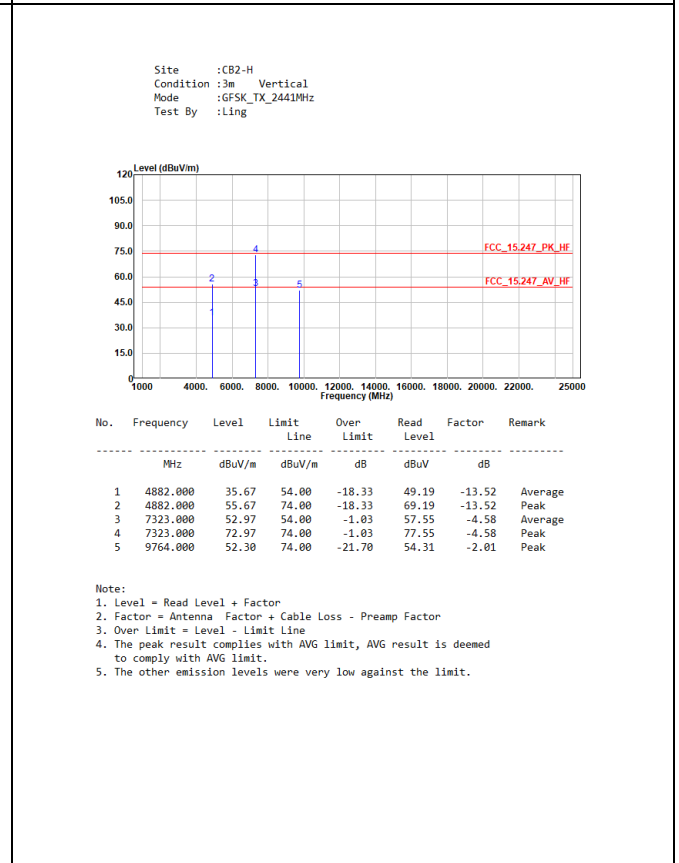
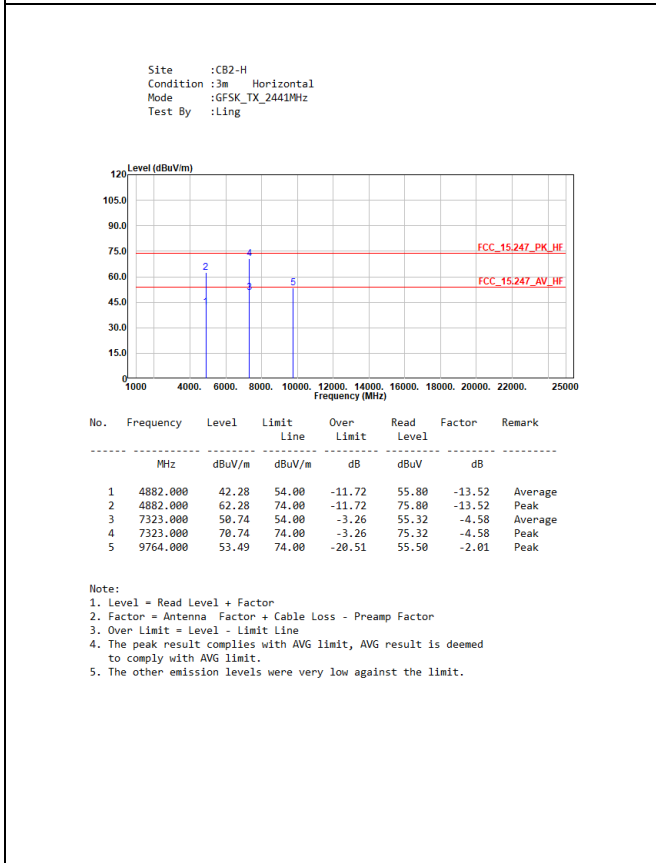
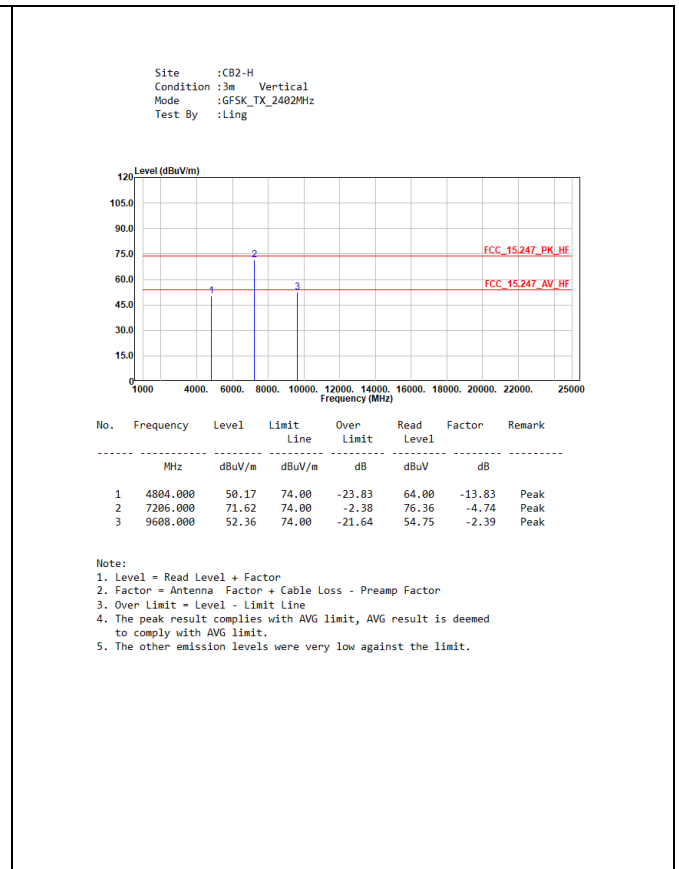
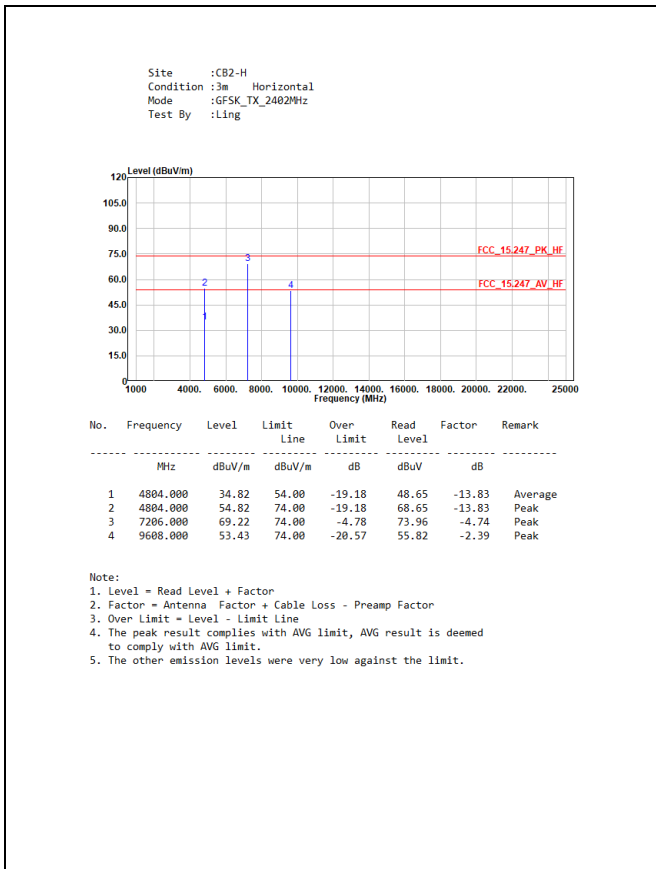

Site :CB2-H
 Condition :3m Horizontal
 Mode :GFSK_TX_2480MHz
 Test By :Ling

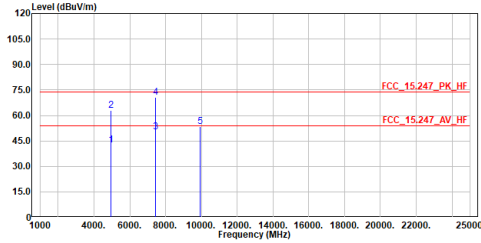

No.	Frequency	Level	Limit	Over	Read	Factor	Remark
	MHz	dBuV/m	dBuV/m	dB	dBuV	dB	
1	4960.000	42.78	54.00	-11.22	56.01	-13.23	Average
2	4960.000	62.78	74.00	-11.22	76.01	-13.23	Peak
3	7440.000	50.46	54.00	-3.54	54.90	-4.44	Average
4	7440.000	70.46	74.00	-3.54	74.90	-4.44	Peak
5	9920.000	53.21	74.00	-20.79	54.85	-1.64	Peak

Note:
 1. Level = Read Level + Factor
 2. Factor = Antenna Factor + Cable Loss - Preamp Factor
 3. Over Limit = Level - Limit Line
 4. The peak result complies with AVG limit, AVG result is deemed to comply with AVG limit.
 5. The other emission levels were very low against the limit.

Site :CB2-H
 Condition :3m Vertical
 Mode :GFSK_TX_2480MHz
 Test By :Ling

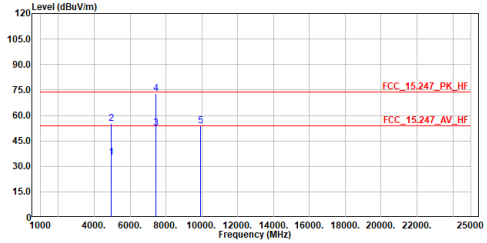

No.	Frequency	Level	Limit	Over	Read	Factor	Remark
	MHz	dBuV/m	dBuV/m	dB	dBuV	dB	
1	4960.000	35.34	54.00	-18.66	48.57	-13.23	Average
2	4960.000	55.34	74.00	-18.66	68.57	-13.23	Peak
3	7440.000	52.68	54.00	-1.32	57.12	-4.44	Average
4	7440.000	72.68	74.00	-1.32	77.12	-4.44	Peak
5	9920.000	54.01	74.00	-19.99	55.65	-1.64	Peak

Note:
 1. Level = Read Level + Factor
 2. Factor = Antenna Factor + Cable Loss - Preamp Factor
 3. Over Limit = Level - Limit Line
 4. The peak result complies with AVG limit, AVG result is deemed to comply with AVG limit.
 5. The other emission levels were very low against the limit.

Site :CB2-H
 Condition :3m Horizontal
 Mode :8DPSK_TX_2402MHz
 Test By :Ling

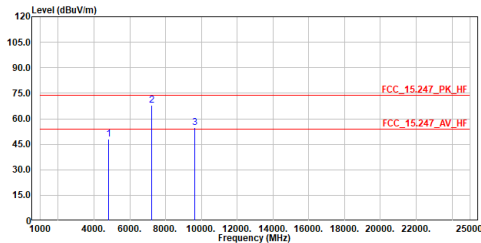

No.	Frequency	Level	Limit	Over	Read	Factor	Remark
	MHz	dBuV/m	dBuV/m	dB	dBuV	dB	
1	4804.000	47.99	74.00	-26.01	61.82	-13.83	Peak
2	7206.000	67.78	74.00	-6.22	72.52	-4.74	Peak
3	9608.000	54.95	74.00	-19.05	57.34	-2.39	Peak

Note:
 1. Level = Read Level + Factor
 2. Factor = Antenna Factor + Cable Loss - Preamp Factor
 3. Over Limit = Level - Limit Line
 4. The peak result complies with AVG limit, AVG result is deemed to comply with AVG limit.
 5. The other emission levels were very low against the limit.

Site :CB2-H
 Condition :3m Vertical
 Mode :8DPSK_TX_2402MHz
 Test By :Ling

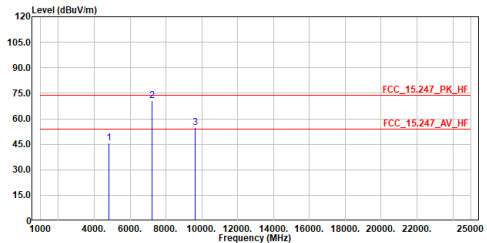

No.	Frequency	Level	Limit	Over	Read	Factor	Remark
	MHz	dBuV/m	dBuV/m	dB	dBuV	dB	
1	4804.000	45.85	74.00	-28.15	59.68	-13.83	Peak
2	7206.000	70.45	74.00	-3.55	75.19	-4.74	Peak
3	9608.000	54.77	74.00	-19.23	57.16	-2.39	Peak

Note:
 1. Level = Read Level + Factor
 2. Factor = Antenna Factor + Cable Loss - Preamp Factor
 3. Over Limit = Level - Limit Line
 4. The peak result complies with AVG limit, AVG result is deemed to comply with AVG limit.
 5. The other emission levels were very low against the limit.

Site :CB2-H
 Condition :3m Horizontal
 Mode :8DPSK_TX_2441MHz
 Test By :Ling

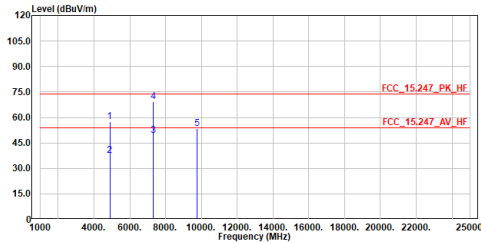

No.	Frequency	Level	Limit	Over	Read	Factor	Remark
	MHz	dBuV/m	dBuV/m	dB	dBuV	dB	
1	4882.000	57.63	74.00	-16.37	71.15	-13.52	Peak
2	4882.000	37.63	74.00	-36.37	51.15	-13.52	Peak
3	7323.000	49.23	54.00	-4.77	53.81	-4.58	Average
4	7323.000	69.23	74.00	-4.77	73.81	-4.58	Peak
5	9764.000	53.58	74.00	-20.42	55.59	-2.01	Peak

Note:
 1. Level = Read Level + Factor
 2. Factor = Antenna Factor + Cable Loss - Preamp Factor
 3. Over Limit = Level - Limit Line
 4. The peak result complies with AVG limit, AVG result is deemed to comply with AVG limit.
 5. The other emission levels were very low against the limit.

Site :CB2-H
 Condition :3m Vertical
 Mode :8DPSK_TX_2441MHz
 Test By :Ling

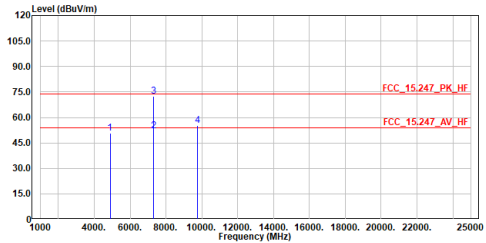

No.	Frequency	Level	Limit	Over	Read	Factor	Remark
	MHz	dBuV/m	dBuV/m	dB	dBuV	dB	
1	4882.000	50.53	74.00	-23.47	64.05	-13.52	Peak
2	7323.000	52.25	54.00	-1.75	56.83	-4.58	Average
3	7323.000	72.25	74.00	-1.75	76.83	-4.58	Peak
4	9764.000	55.31	74.00	-18.69	57.32	-2.01	Peak

Note:
 1. Level = Read Level + Factor
 2. Factor = Antenna Factor + Cable Loss - Preamp Factor
 3. Over Limit = Level - Limit Line
 4. The peak result complies with AVG limit, AVG result is deemed to comply with AVG limit.
 5. The other emission levels were very low against the limit.

Site :CB2-H
 Condition :3m Horizontal
 Mode :8DPSK_TX_2480MHz
 Test By :Ling

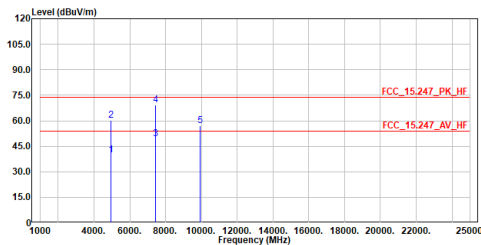

No.	Frequency	Level	Limit	Over	Read	Factor	Remark
	MHz	dBuV/m	dBuV/m	dB	dBuV	dB	
1	4960.000	40.03	54.00	-13.97	53.26	-13.23	Average
2	4960.000	60.03	74.00	-13.97	73.26	-13.23	Peak
3	7440.000	49.37	54.00	-4.63	53.81	-4.44	Average
4	7440.000	69.37	74.00	-4.63	73.81	-4.44	Peak
5	9920.000	56.91	74.00	-17.09	58.55	-1.64	Peak

Note:
 1. Level = Read Level + Factor
 2. Factor = Antenna Factor + Cable Loss - Preamp Factor
 3. Over Limit = Level - Limit Line
 4. The peak result complies with AVG limit, AVG result is deemed to comply with AVG limit.
 5. The other emission levels were very low against the limit.

Site :CB2-H
 Condition :3m Vertical
 Mode :8DPSK_TX_2480MHz
 Test By :Ling

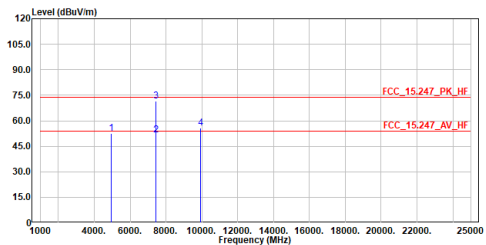

No.	Frequency	Level	Limit	Over	Read	Factor	Remark
	MHz	dBuV/m	dBuV/m	dB	dBuV	dB	
1	4960.000	52.49	74.00	-21.51	65.72	-13.23	Peak
2	7440.000	51.56	54.00	-2.44	56.00	-4.44	Average
3	7440.000	71.56	74.00	-2.44	76.00	-4.44	Peak
4	9920.000	55.61	74.00	-18.39	57.25	-1.64	Peak

Note:
 1. Level = Read Level + Factor
 2. Factor = Antenna Factor + Cable Loss - Preamp Factor
 3. Over Limit = Level - Limit Line
 4. The peak result complies with AVG limit, AVG result is deemed to comply with AVG limit.
 5. The other emission levels were very low against the limit.

<For EUT 2>

Site :CB2-H
 Condition :3m Horizontal
 Mode :GFSK_TX_2441MHz
 Test By :Getaz

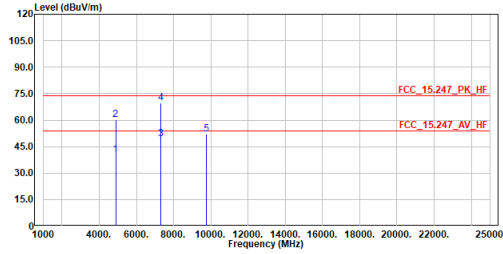

No.	Frequency MHz	Level dBuV/m	Limit dBuV/m	Over Limit dB	Read Level dBuV	Factor dB	Remark
1	4882.000	40.24	54.00	-13.76	53.76	-13.52	Average
2	4882.000	60.24	74.00	-13.76	73.76	-13.52	Peak
3	7323.000	49.53	54.00	-4.47	54.11	-4.58	Average
4	7323.000	69.53	74.00	-4.47	74.11	-4.58	Peak
5	9764.000	52.16	74.00	-21.84	54.17	-2.01	Peak

Note:
 1. Level = Read Level + Factor
 2. Factor = Antenna Factor + Cable Loss - Preamp Factor
 3. Over Limit = Level - Limit Line
 4. The peak result complies with AVG limit, AVG result is deemed to comply with AVG limit.
 5. The other emission levels were very low against the limit.

Site :CB2-H
 Condition :3m Vertical
 Mode :GFSK_TX_2441MHz
 Test By :Getaz

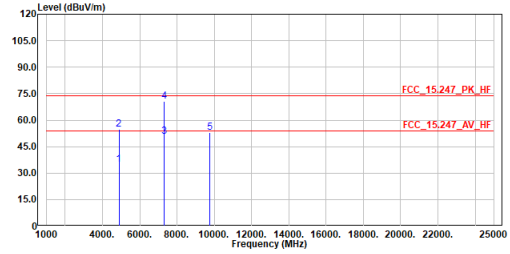

No.	Frequency MHz	Level dBuV/m	Limit dBuV/m	Over Limit dB	Read Level dBuV	Factor dB	Remark
1	4882.000	34.77	54.00	-19.23	48.29	-13.52	Average
2	4882.000	54.77	74.00	-19.23	68.29	-13.52	Peak
3	7323.000	50.63	54.00	-3.37	55.21	-4.58	Average
4	7323.000	70.63	74.00	-3.37	75.21	-4.58	Peak
5	9764.000	52.85	74.00	-21.15	54.86	-2.01	Peak

Note:
 1. Level = Read Level + Factor
 2. Factor = Antenna Factor + Cable Loss - Preamp Factor
 3. Over Limit = Level - Limit Line
 4. The peak result complies with AVG limit, AVG result is deemed to comply with AVG limit.
 5. The other emission levels were very low against the limit.

5. Antenna Port Conducted Emission

5.1. Test Setup

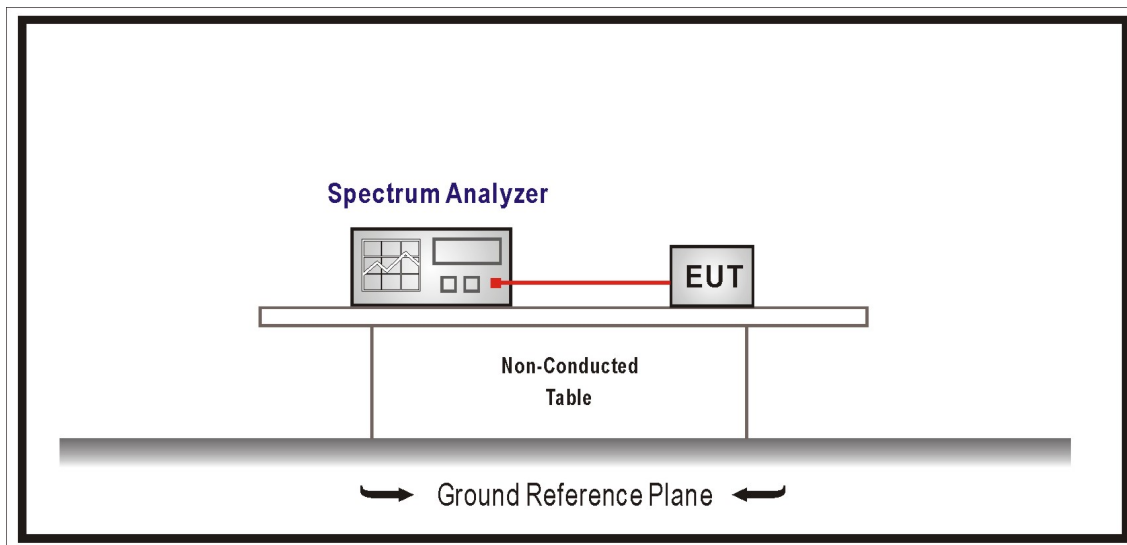

5.2. Test Limit

In any 100 kHz bandwidth outside the frequency band in which the spread spectrum intentional radiator is operating, the radio frequency power that is produced by the intentional radiator shall be at least 20 dB below that in the 100 kHz bandwidth within the band that contains the highest level of the desired power, based on an RF conducted or radiated measurement. Attenuation below the general limit specified in Section 15.209(a) is not required. In addition, radiated emissions which fall in the restricted bands, as defined in Section 15.205(a), must also comply with the radiated emission limit specified in Section 15.209(a) (see Section 15.205(c)).

5.3. Test Procedure

The EUT was setup according to ANSI C63.10: 2013 and tested according to FHSS test procedure of FCC KDB 558074 D01 v05r02 for compliance to FCC 47CFR 15.247

5.4. Test Specification

According to FCC Part 15 Subpart C Paragraph 15.247.

5.5. Test Result of Antenna Port Conducted Emission

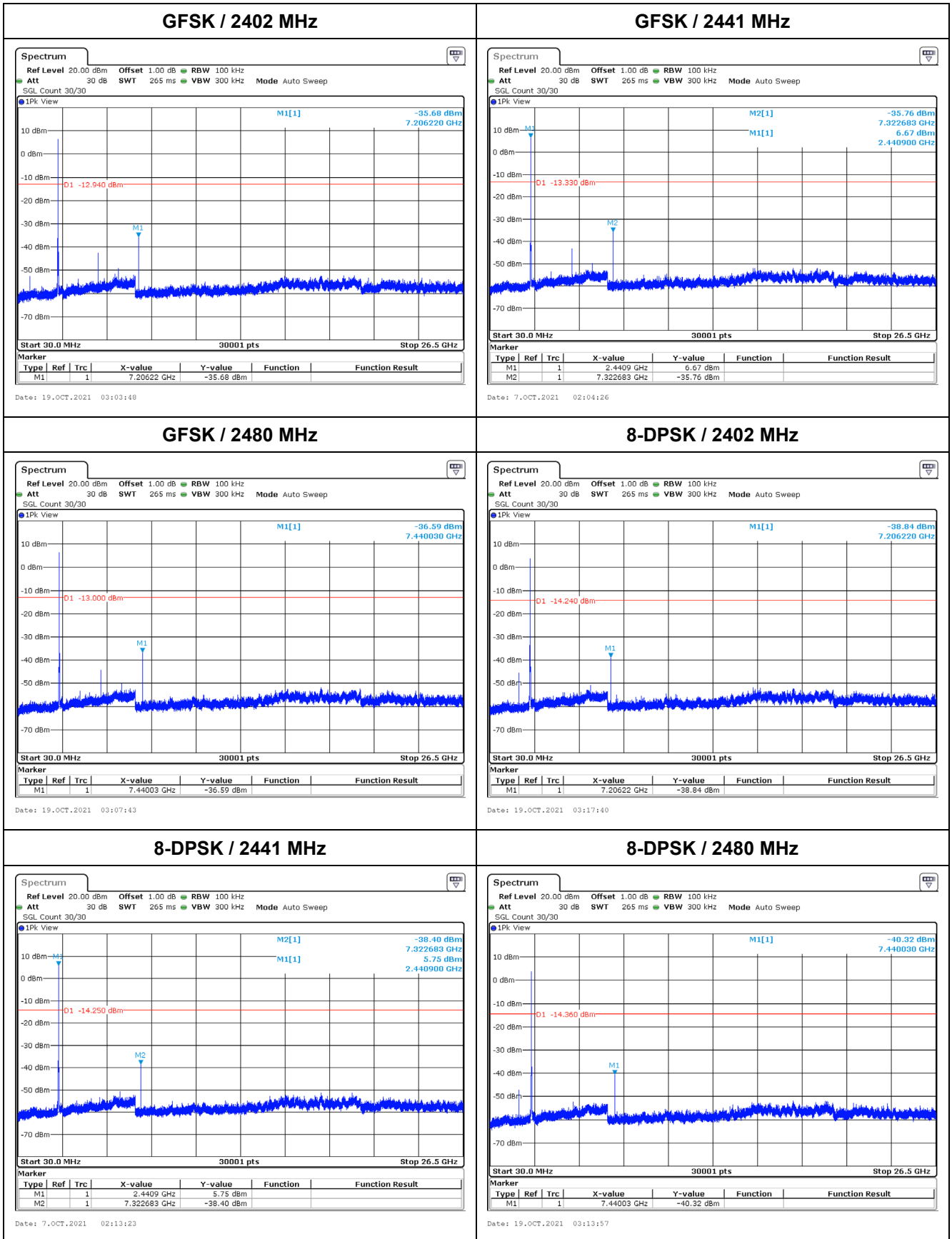

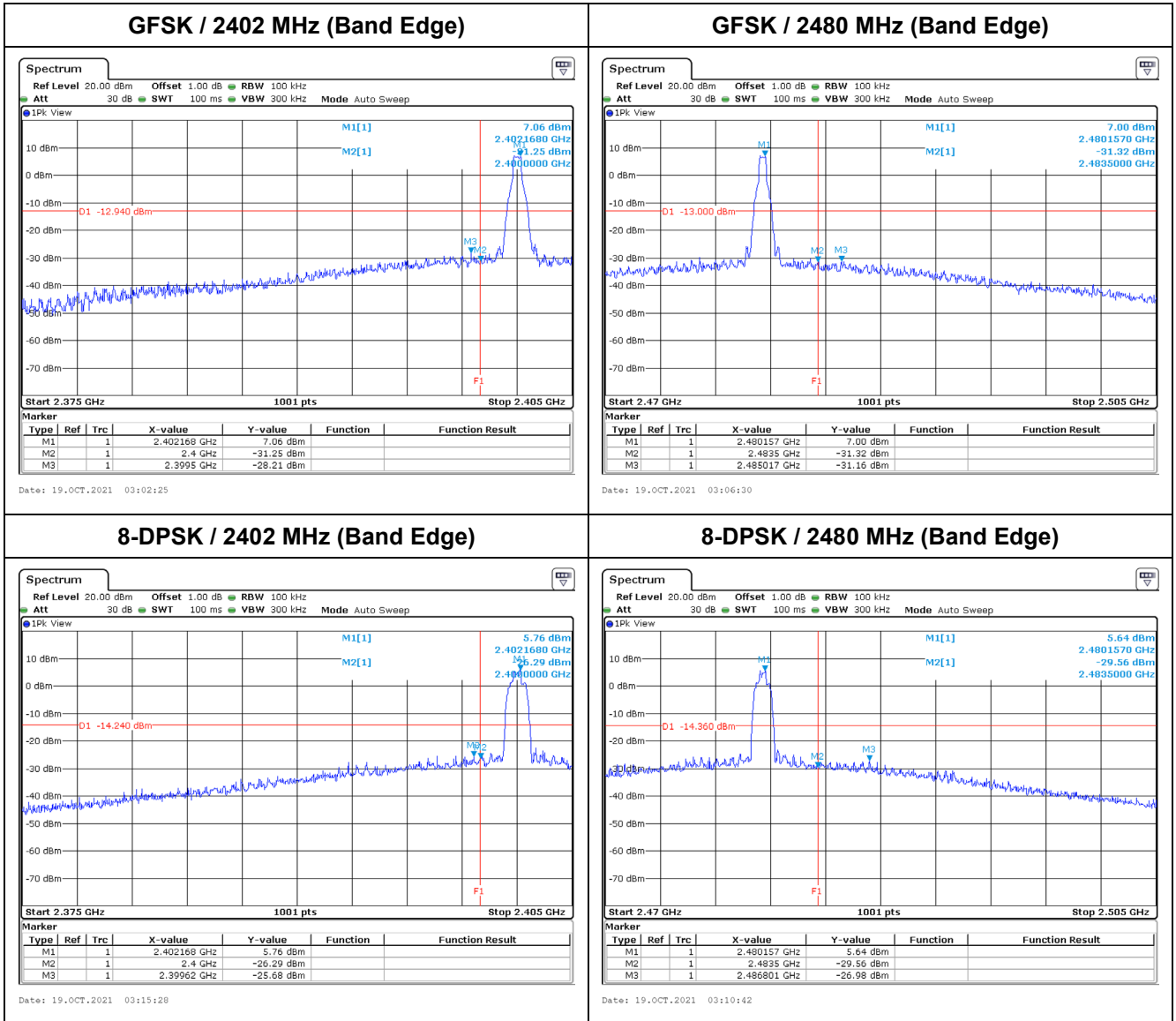

6. Radiated Emission Band Edge

6.1. Test Setup

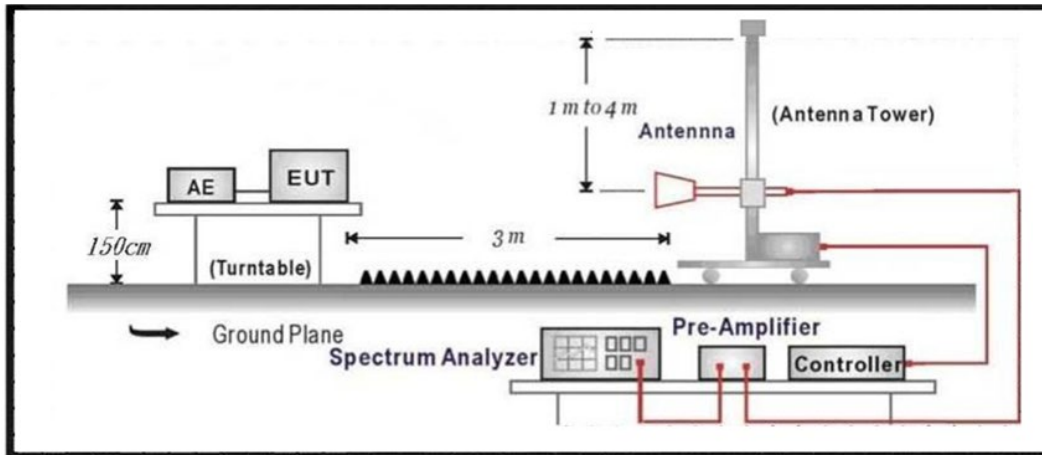

6.2. Test Limit

Emissions radiated outside of the specified frequency bands, except for harmonics, shall be attenuated by at least 20 dB below the level of the fundamental or to the general radiated emission limit in paragraph 15.209, whichever is the lesser attenuation.

Frequency (MHz)	Field strength (uV/m)	Field strength (dBuV/m)	Measurement distance (m)
30 - 88	100	40	3
88 - 216	150	43.5	3
216 - 960	200	46	3
Above 960	500	54	3

Remarks:

1. Field strength (dBuV/m) = 20 log Field strength (uV/m)
2. In the Above Table, the tighter limit applies at the band edges.
3. Distance refers to the distance in meters between the measuring instrument antenna and the closed point of any part of the device or system

6.3. Test Procedure

The EUT was setup according to ANSI C63.10: 2013 and tested according to FHSS test procedure of FCC KDB 558074 D01 v05r02 for compliance to FCC 47CFR 15.247 requirements.

The EUT and its simulators are placed on a turn table which is 1.5 meter above ground. The turn table can rotate 360 degrees to determine the position of the maximum emission level. The antenna can move up and down between 1 meter and 4 meters to find out the maximum emission level.

Both horizontal and vertical polarization of the antenna are set on measurement. In order to find the maximum emission, all of the interface cables must be manipulated according to ANSI C63.10: 2013 on radiated measurement.

6.4. Test Specification

According to FCC Part 15 Subpart C Paragraph 15.247.

6.5. Test Result of Radiated Emission Band Edge

<For EUT 1>

Band Edge

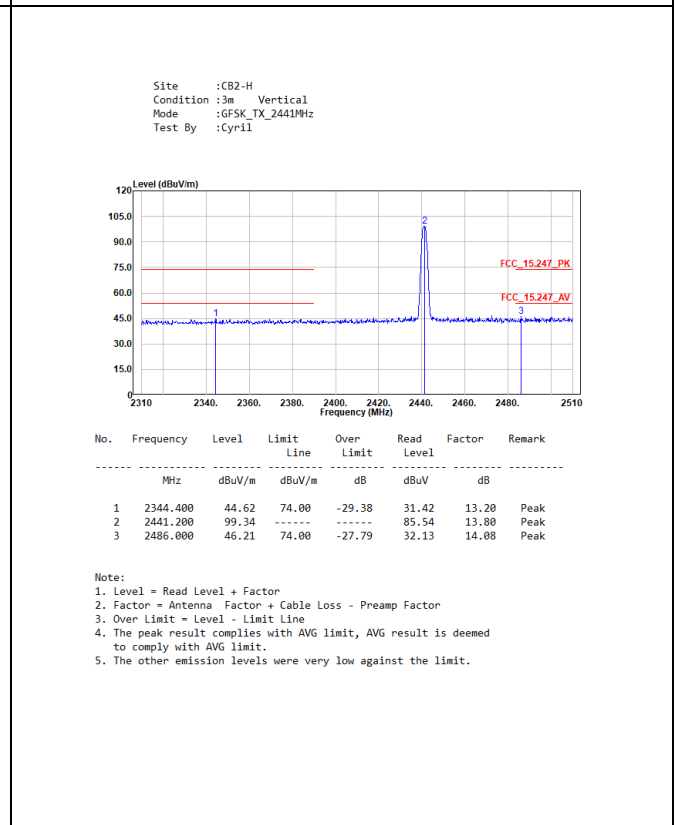
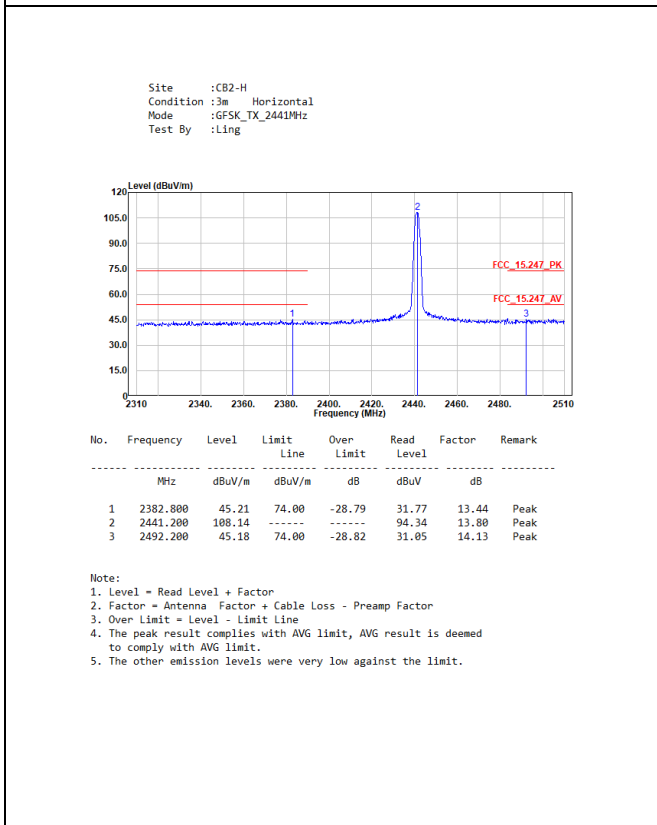
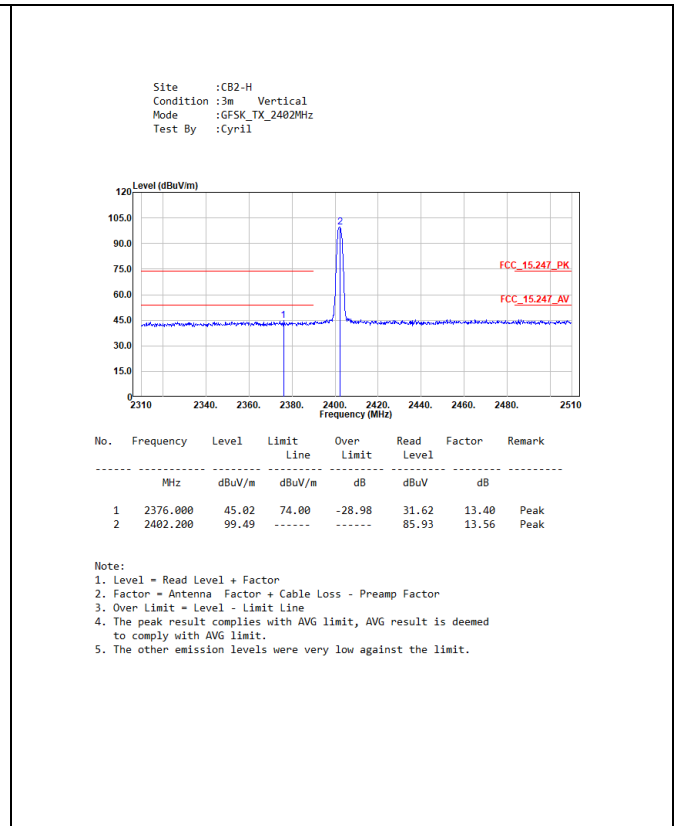
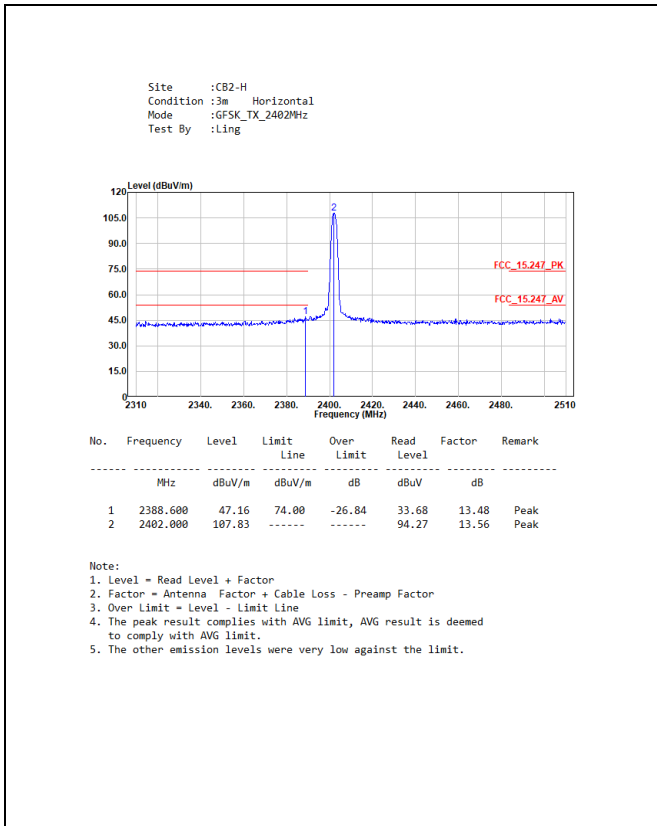

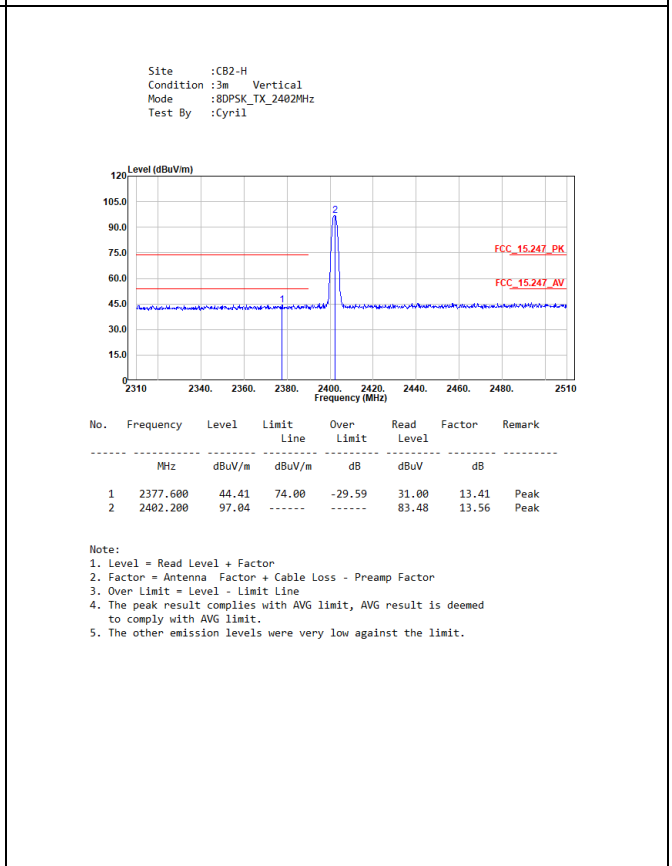
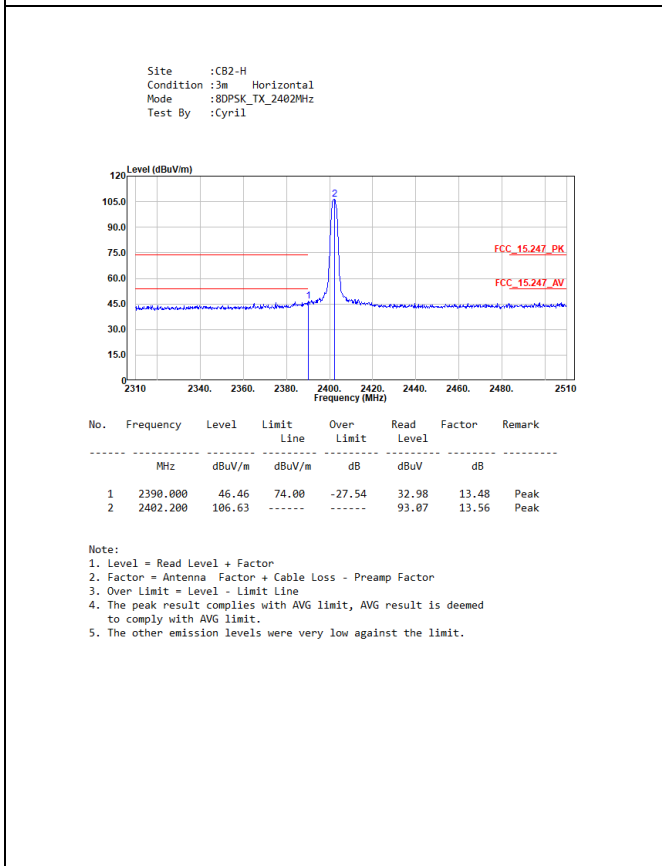
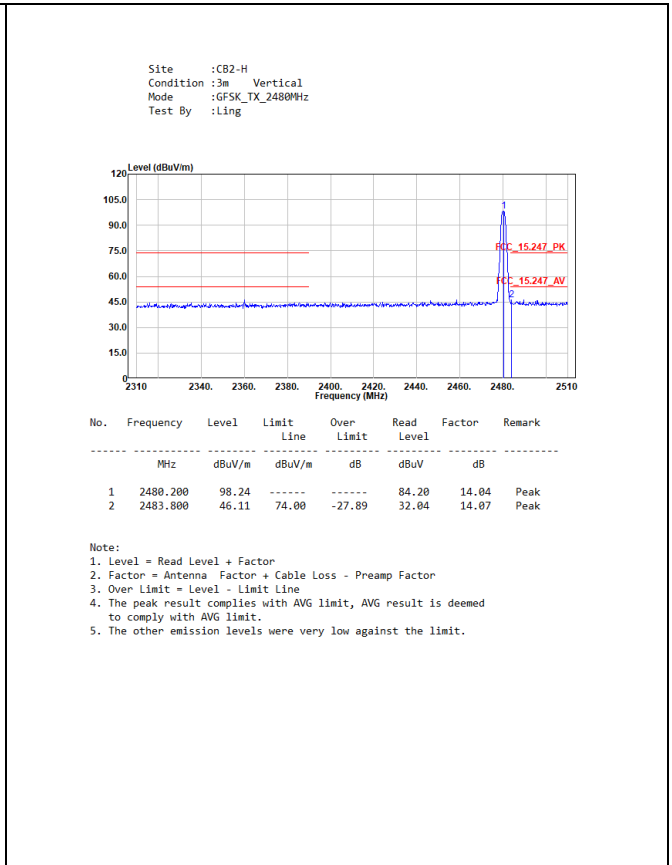
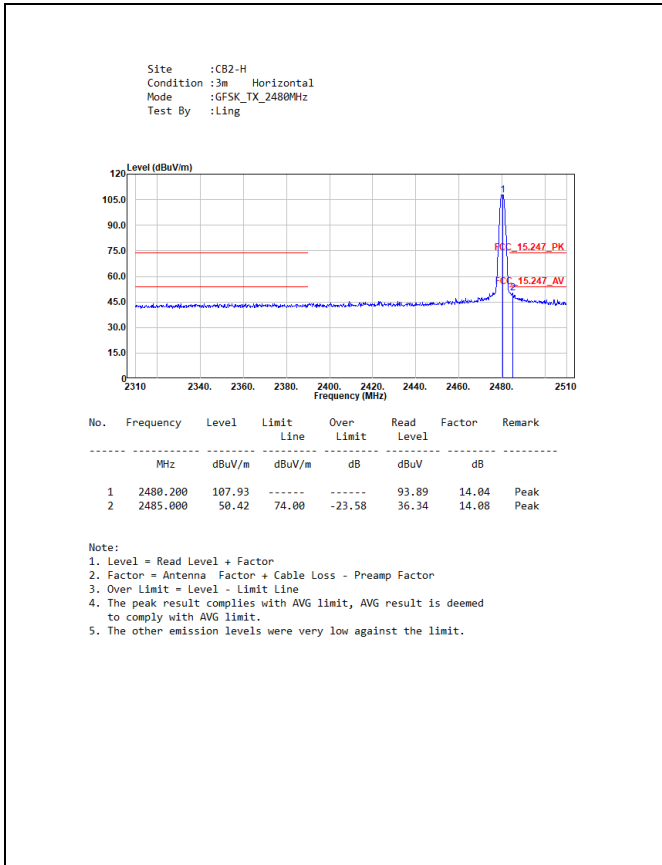

Site :CB2-H
 Condition :3m Horizontal
 Mode :8DPSK_TX_2441MHz
 Test By :Cyril

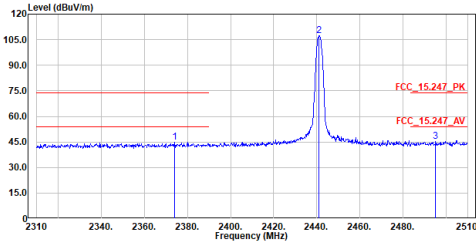

No.	Frequency	Level	Limit	Over	Read	Factor	Remark
	MHz	dBuV/m	dBuV/m	dB	dBuV	dB	
1	2374.000	44.69	74.00	-29.31	31.31	13.38	Peak
2	2441.000	107.20	---	93.40	93.40	13.80	Peak
3	2495.200	45.13	74.00	-28.87	30.99	14.14	Peak

Note:
 1. Level = Read Level + Factor
 2. Factor = Antenna Factor + Cable Loss - Preamp Factor
 3. Over Limit = Level - Limit Line
 4. The peak result complies with AVG limit, AVG result is deemed to comply with AVG limit.
 5. The other emission levels were very low against the limit.

Site :CB2-H
 Condition :3m Vertical
 Mode :8DPSK_TX_2441MHz
 Test By :Cyril

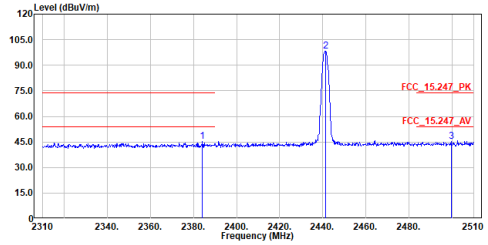

No.	Frequency	Level	Limit	Over	Read	Factor	Remark
	MHz	dBuV/m	dBuV/m	dB	dBuV	dB	
1	2384.200	45.18	74.00	-28.82	31.73	13.45	Peak
2	2441.200	98.38	---	84.58	84.58	13.80	Peak
3	2499.600	45.25	74.00	-28.75	31.08	14.17	Peak

Note:
 1. Level = Read Level + Factor
 2. Factor = Antenna Factor + Cable Loss - Preamp Factor
 3. Over Limit = Level - Limit Line
 4. The peak result complies with AVG limit, AVG result is deemed to comply with AVG limit.
 5. The other emission levels were very low against the limit.

Site :CB2-H
 Condition :3m Horizontal
 Mode :8DPSK_TX_2480MHz
 Test By :Cyril

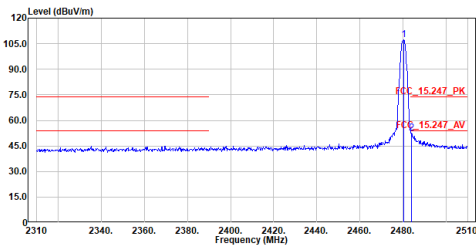

No.	Frequency	Level	Limit	Over	Read	Factor	Remark
	MHz	dBuV/m	dBuV/m	dB	dBuV	dB	
1	2480.200	107.33	---	93.29	93.29	14.04	Peak
2	2483.800	52.63	74.00	-21.37	38.56	14.07	Peak

Note:
 1. Level = Read Level + Factor
 2. Factor = Antenna Factor + Cable Loss - Preamp Factor
 3. Over Limit = Level - Limit Line
 4. The peak result complies with AVG limit, AVG result is deemed to comply with AVG limit.
 5. The other emission levels were very low against the limit.

Site :CB2-H
 Condition :3m Vertical
 Mode :8DPSK_TX_2480MHz
 Test By :Cyril

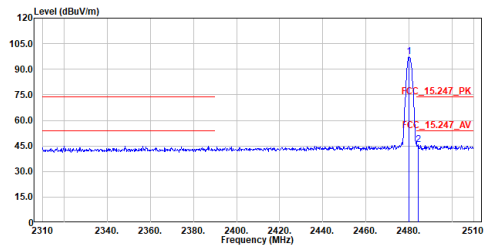

No.	Frequency	Level	Limit	Over	Read	Factor	Remark
	MHz	dBuV/m	dBuV/m	dB	dBuV	dB	
1	2480.000	97.15	---	83.11	83.11	14.04	Peak
2	2484.200	45.58	74.00	-28.42	31.51	14.07	Peak

Note:
 1. Level = Read Level + Factor
 2. Factor = Antenna Factor + Cable Loss - Preamp Factor
 3. Over Limit = Level - Limit Line
 4. The peak result complies with AVG limit, AVG result is deemed to comply with AVG limit.
 5. The other emission levels were very low against the limit.

Band Edge – Hopping

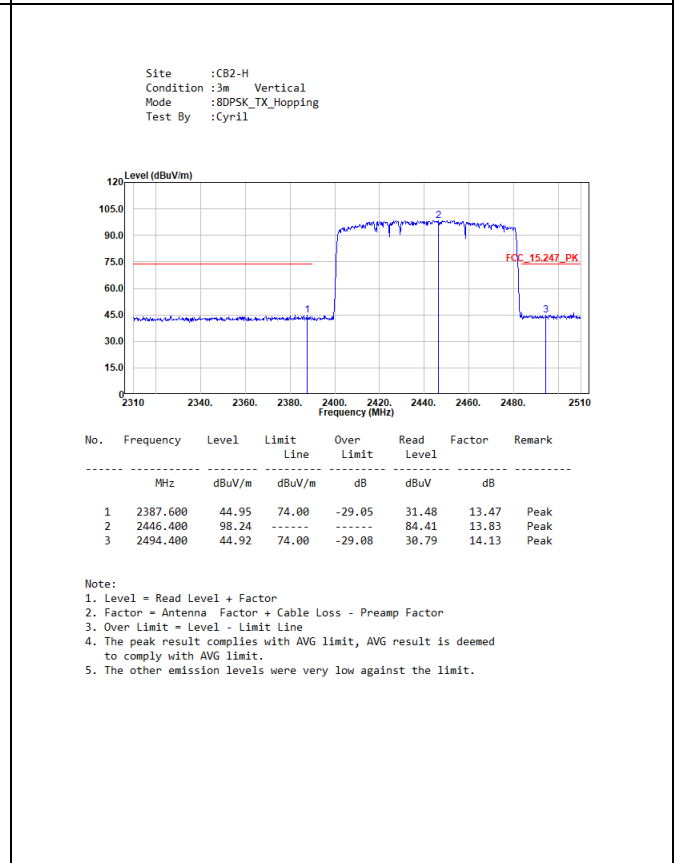
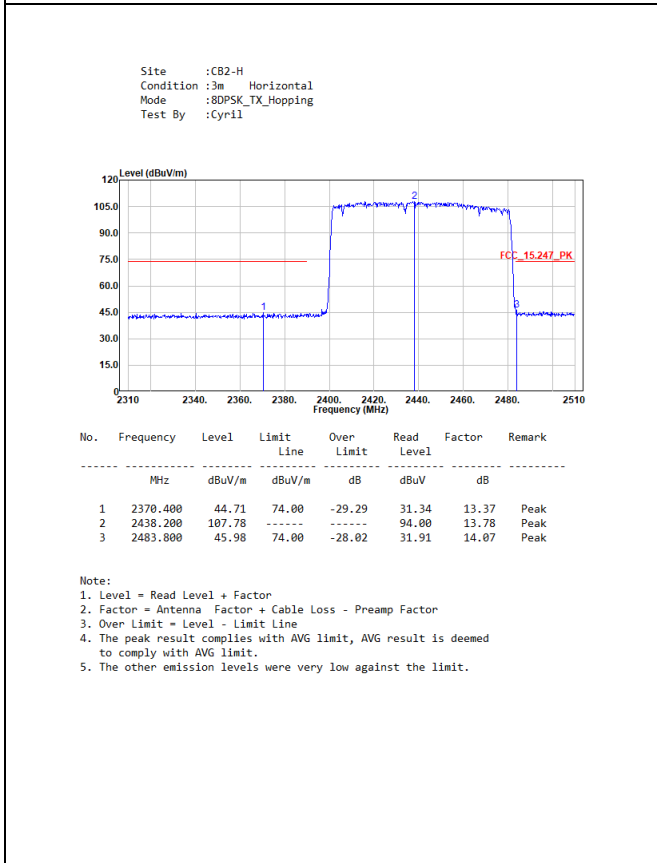
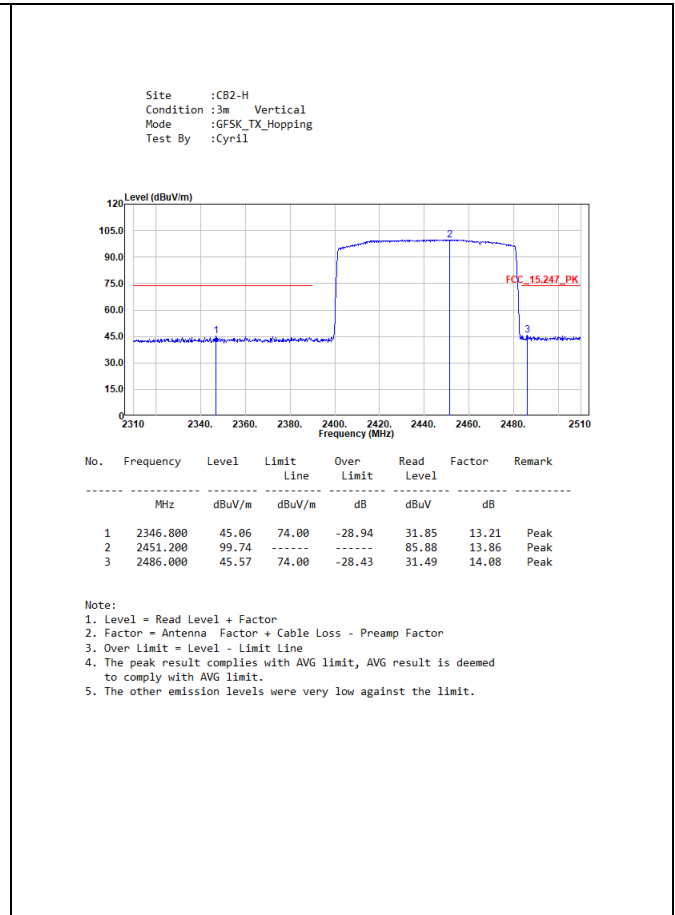
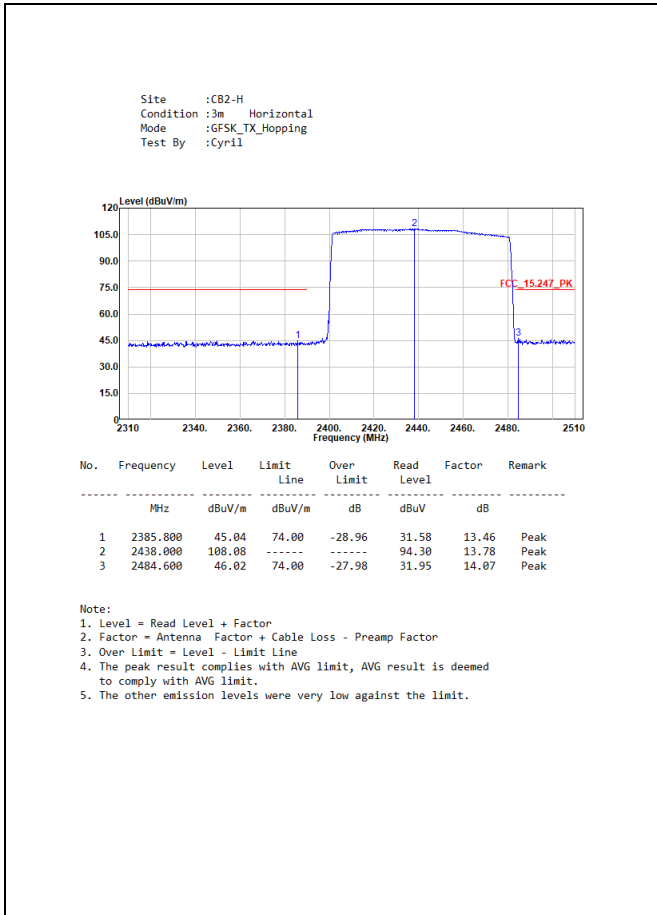

<For EUT 2>

Site :CB2-H
 Condition :3m Horizontal
 Mode :GFSK_TX_2441MHz
 Test By :Getaz

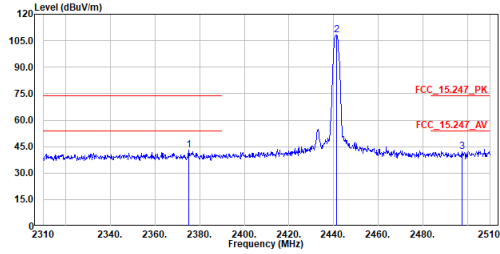

No.	Frequency MHz	Level dBuV/m	Limit dBuV/m	Over Limit dB	Read Level dBuV	Factor dB	Remark
1	2375.000	42.86	74.00	-31.14	29.46	13.40	Peak
2	2441.200	108.45	-----	-----	94.65	13.80	Peak
3	2497.600	42.24	74.00	-31.76	28.08	14.16	Peak

Note:
 1. Level = Read Level + Factor
 2. Factor = Antenna Factor + Cable Loss - Preamp Factor
 3. Over Limit = Level - Limit Line
 4. The peak result complies with AVG limit, AVG result is deemed to comply with AVG limit.
 5. The other emission levels were very low against the limit.

Site :CB2-H
 Condition :3m Vertical
 Mode :GFSK_TX_2441MHz
 Test By :Getaz

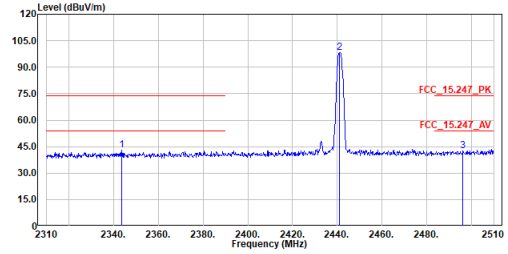

No.	Frequency MHz	Level dBuV/m	Limit dBuV/m	Over Limit dB	Read Level dBuV	Factor dB	Remark
1	2343.600	42.82	74.00	-31.18	29.62	13.20	Peak
2	2441.000	98.24	-----	-----	84.44	13.80	Peak
3	2496.200	42.76	74.00	-31.24	28.62	14.14	Peak

Note:
 1. Level = Read Level + Factor
 2. Factor = Antenna Factor + Cable Loss - Preamp Factor
 3. Over Limit = Level - Limit Line
 4. The peak result complies with AVG limit, AVG result is deemed to comply with AVG limit.
 5. The other emission levels were very low against the limit.

7. Number of Hopping Frequency

7.1. Test Setup

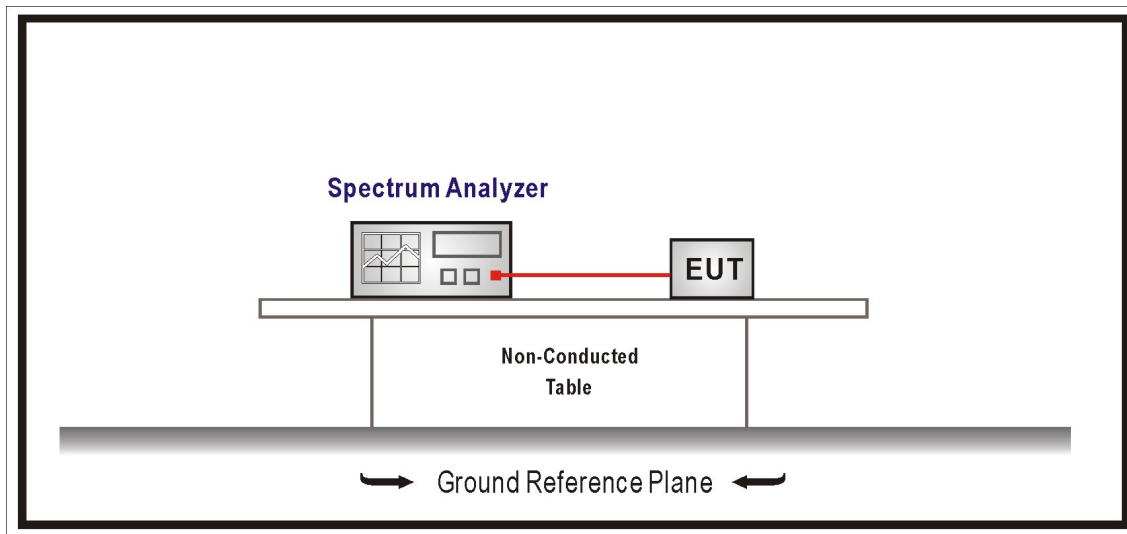

7.2. Test Limit

For frequency hopping systems operating in the 902 ~ 928 MHz band: if the 20 dB bandwidth of the hopping channel is less than 250 kHz, the system shall use at least 50 hopping frequencies and the average time of occupancy on any frequency shall not be greater than 0.4 seconds within a 20 second period; if the 20 dB bandwidth of the hopping channel is 250 kHz or greater, the system shall use at least 25 hopping frequencies and the average time of occupancy on any frequency shall not be greater than 0.4 seconds within a 10 second period. The maximum allowed 20 dB bandwidth of the hopping channel is 500 kHz.

Frequency hopping systems in the 2400 ~ 2483.5 MHz band shall use at least 15 channels. The average time of occupancy on any channel shall not be greater than 0.4 seconds within a period of 0.4 seconds multiplied by the number of hopping channels employed. Frequency hopping systems may avoid or suppress transmissions on a particular hopping frequency provided that a minimum of 15 channels are used.

Frequency hopping systems operating in the 5725 ~ 5850 MHz band shall use at least 75 hopping frequencies. The maximum 20 dB bandwidth of the hopping channel is 1 MHz. The average time of occupancy on any frequency shall not be greater than 0.4 seconds within a 30 second period.

7.3. Test Procedures

The EUT was setup according to ANSI C63.10: 2013 and tested according to FHSS test procedure of FCC KDB 558074 D01 v05r02 for compliance to FCC 47CFR 15.247 requirements.

7.4. Test Specification

According to FCC Part 15 Subpart C Paragraph 15.247.

7.5. Test Result of Number of Hopping Frequency

Frequency Range (MHz)	Measure Level (Channels)	Limit (Channels)
2402 ~ 2480	79	≥ 75

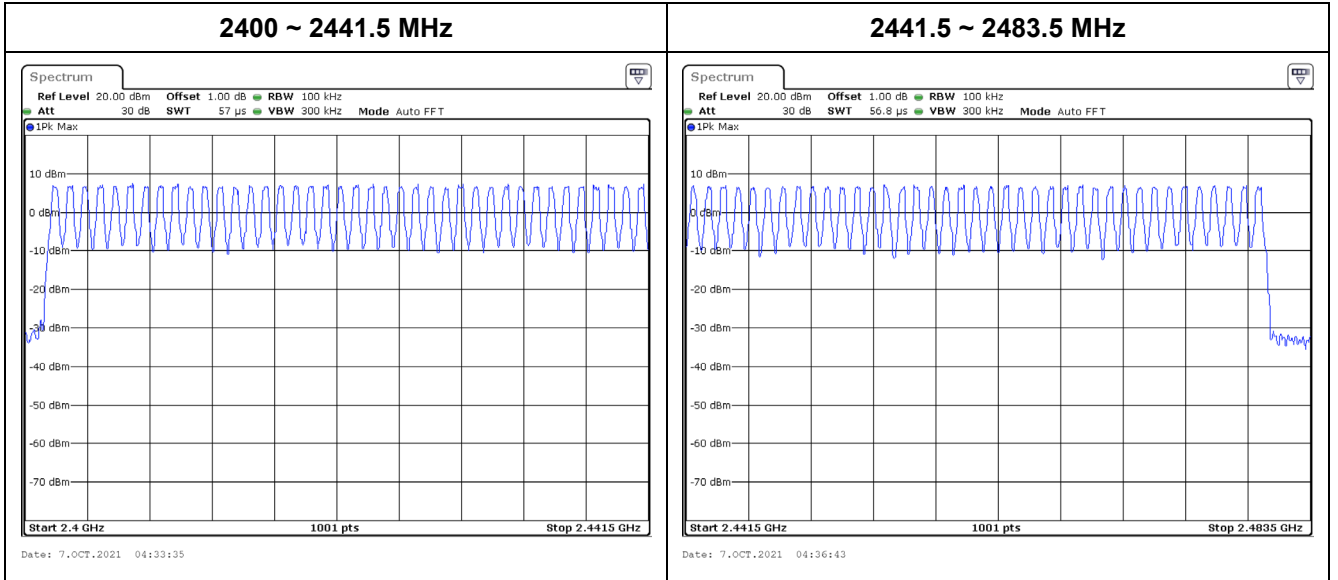

8. Carrier Frequency Separation

8.1. Test Setup

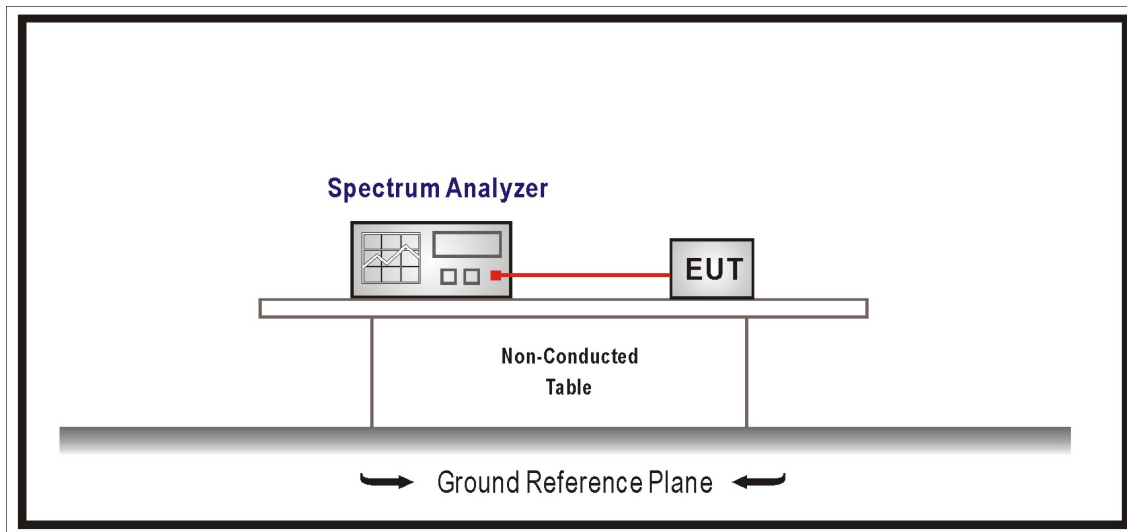

8.2. Test Limit

Frequency hopping systems shall have hopping channel carrier frequencies separated by a minimum of 25 kHz or the 20 dB bandwidth of the hopping channel, whichever is greater. Alternatively, frequency hopping systems operating in the 2400 ~ 2483.5 MHz band may have hopping channel carrier frequencies that are separated by 25 kHz or two-thirds of the 20 dB bandwidth of the hopping channel, whichever is greater, provided the systems operate with an Maximum Conducted Output Power no greater than 125 mW. The system shall hop to channel frequencies that are selected at the system hopping rate from a pseudo randomly ordered list of hopping frequencies. Each frequency must be used equally on the average by each transmitter. The system receivers shall have input bandwidths that match the hopping channel bandwidths of their corresponding transmitters and shall shift frequencies in synchronization with the transmitted signals.

8.3. Test Procedures

The EUT was setup according to ANSI C63.10: 2013 and tested according to FHSS test procedure of FCC KDB 558074 D01 v05r02 for compliance to FCC 47CFR 15.247 requirements.

8.4. Test Specification

According to FCC Part 15 Subpart C Paragraph 15.247.

8.5. Test Result of Carrier Frequency Separation

Modulation	Channel	Frequency (MHz)	Measure Level (MHz)	Limit (MHz)	Result
GFSK	00	2402	0.998	> 0.64	Pass
	39	2441	0.998	> 0.64	Pass
	78	2480	1.001	> 0.66	Pass
8-DPSK	00	2402	0.998	> 0.86	Pass
	39	2441	1.001	> 0.85	Pass
	78	2480	1.001	> 0.85	Pass

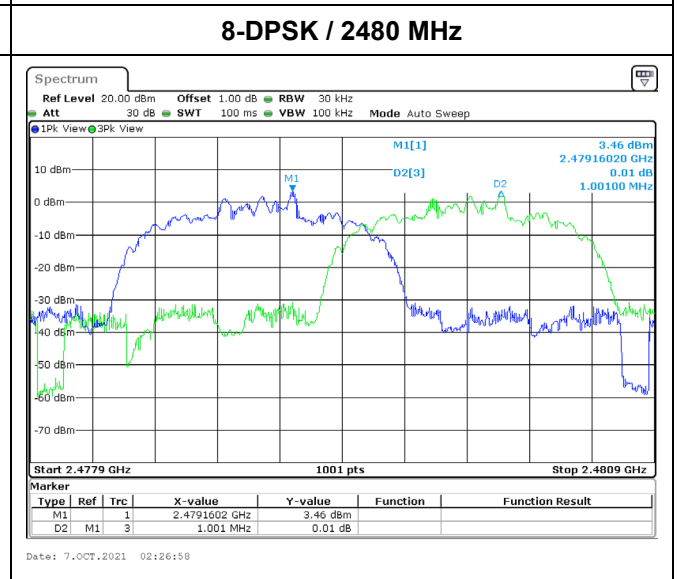
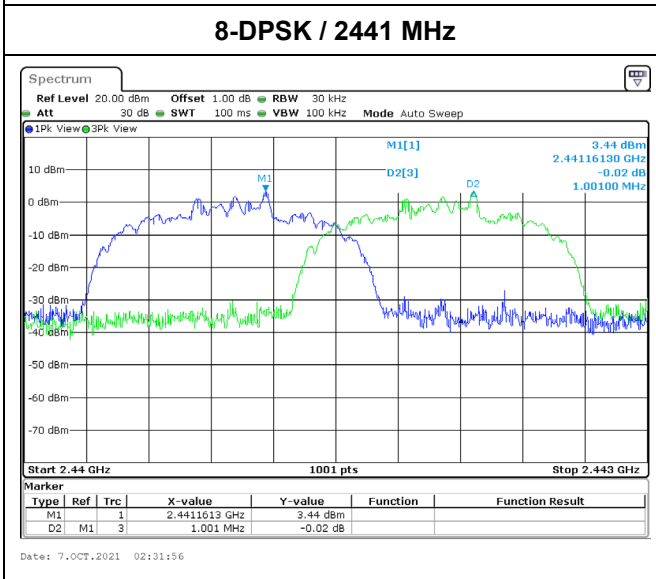
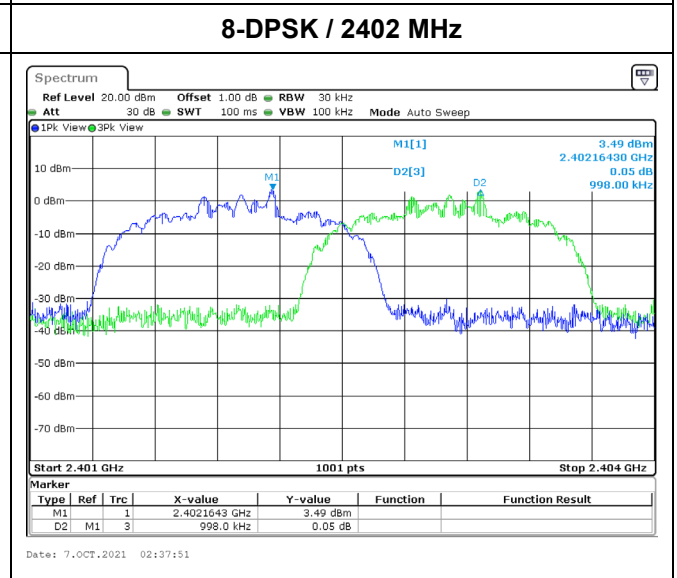
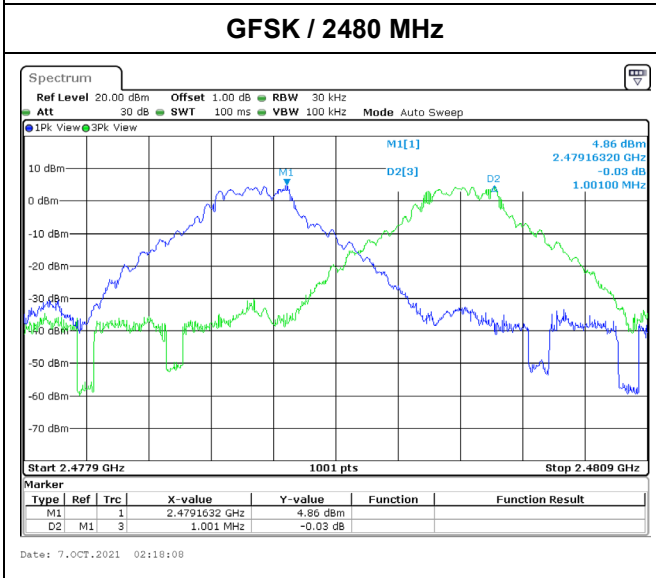
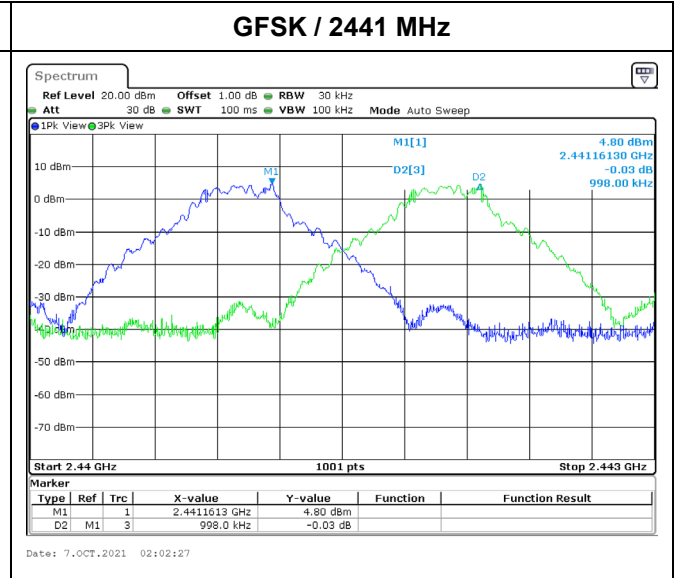
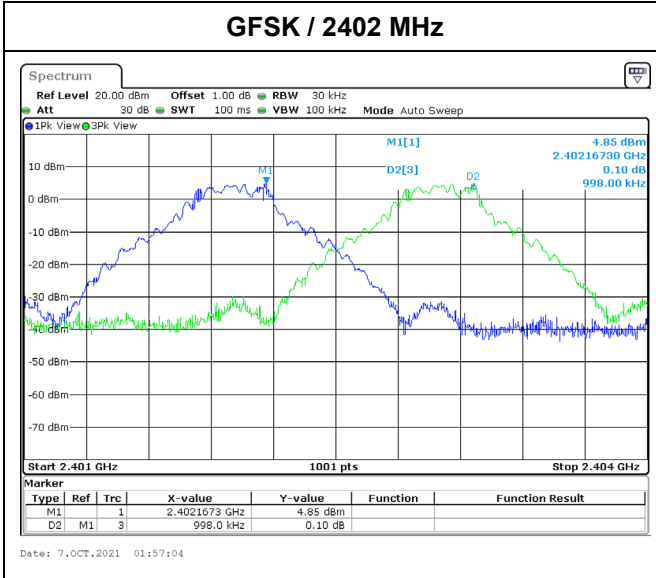

9. 20dB Bandwidth

9.1. Test Setup

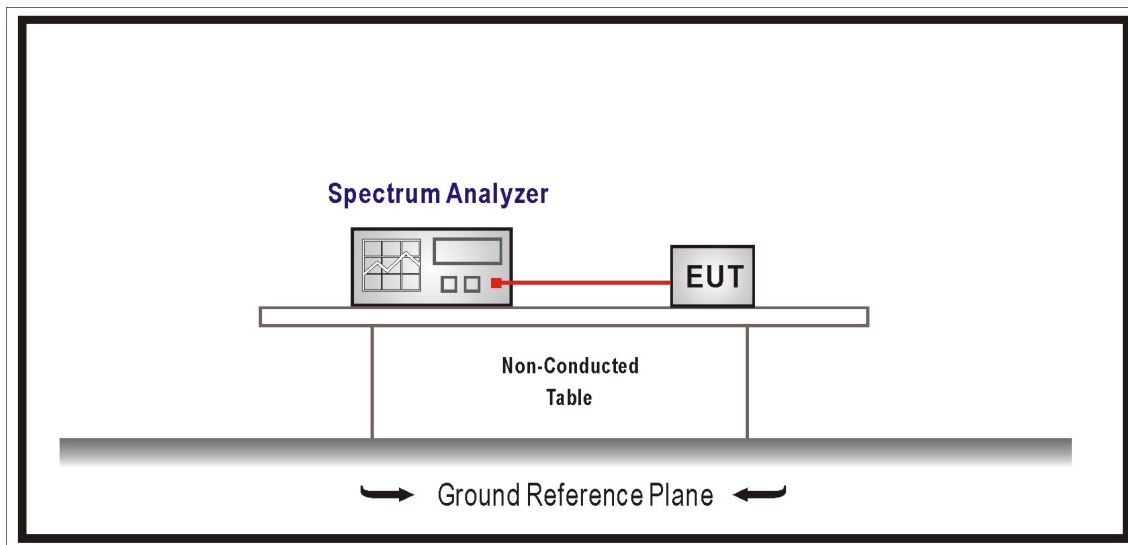

9.2. Test Limit

N/A

9.3. Test Procedures

The EUT was setup according to ANSI C63.10: 2013 and tested according to FHSS test procedure of FCC KDB 558074 D01 v05r02 for compliance to FCC 47CFR 15.247 requirements

Use the following spectrum analyzer settings:

Span = approximately 2 to 3 times the 20 dB bandwidth, centered on a hopping channel

RBW \geq 1% of the 20 dB bandwidth, VBW \geq RBW, Sweep = auto, Detector function = peak, Trace = max hold,

The EUT should be transmitting at its maximum data rate.

9.4. Test Specification

According to FCC Part 15 Subpart C Paragraph 15.247.

9.5. Test Result of 20dB Bandwidth

Modulation	Channel	Frequency (MHz)	Measure Level (MHz)	Limit (MHz)
GFSK	00	2402	0.965	-
	39	2441	0.962	-
	78	2480	0.983	-
8-DPSK	00	2402	1.285	-
	39	2441	1.276	-
	78	2480	1.276	-

GFSK / 2402 MHz

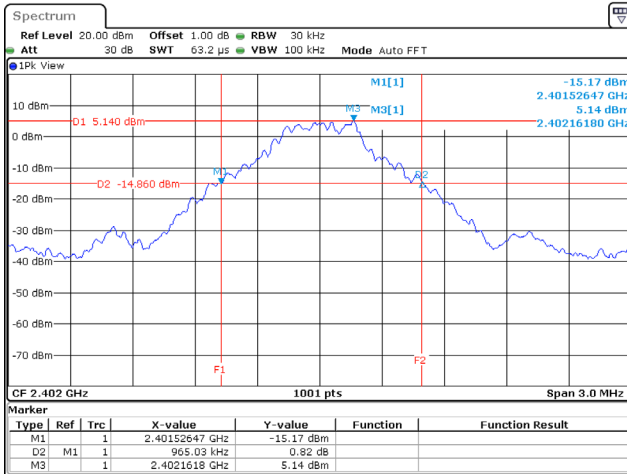

Date: 7.OCT.2021 01:53:26

GFSK / 2441 MHz

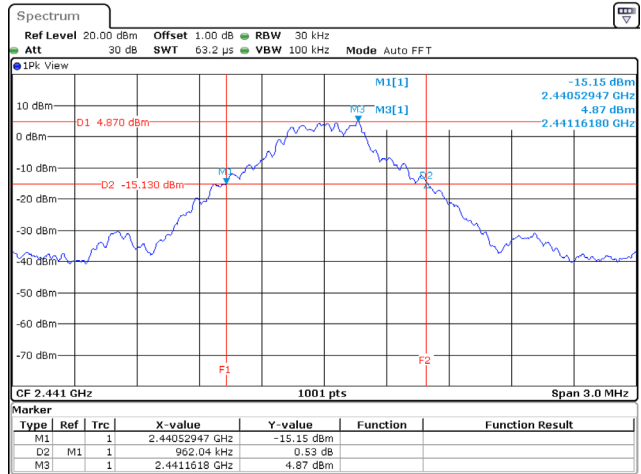

Date: 7.OCT.2021 02:01:05

GFSK / 2480 MHz

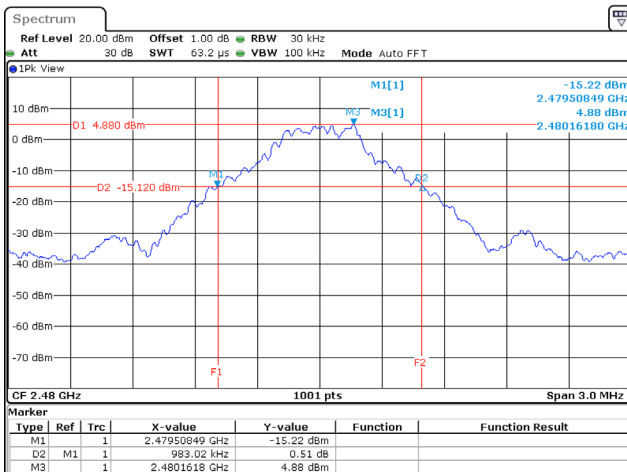

Date: 7.OCT.2021 02:09:32

8-DPSK / 2402 MHz

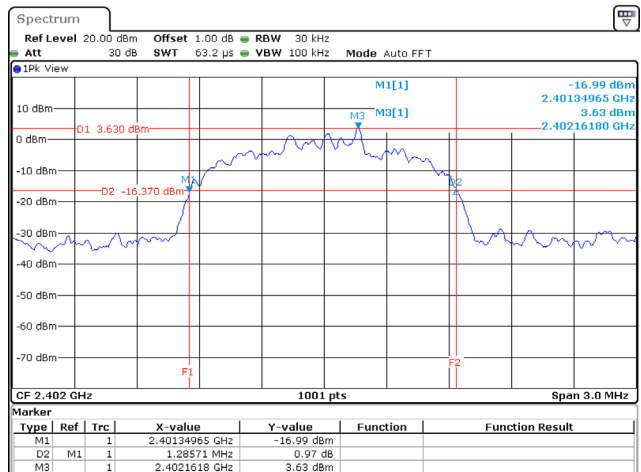

Date: 7.OCT.2021 02:32:53

8-DPSK / 2441 MHz

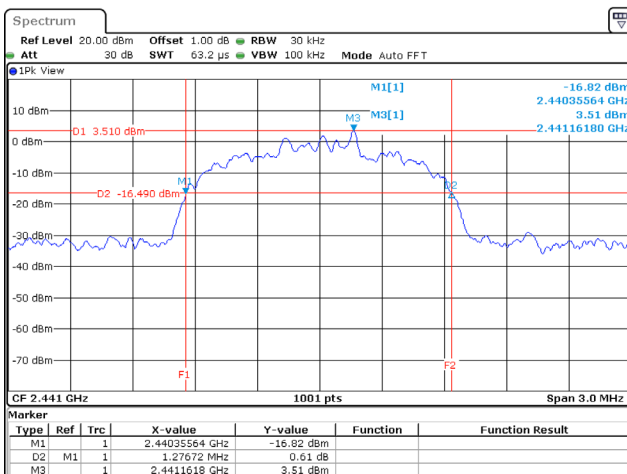

Date: 7.OCT.2021 02:28:02

8-DPSK / 2480 MHz

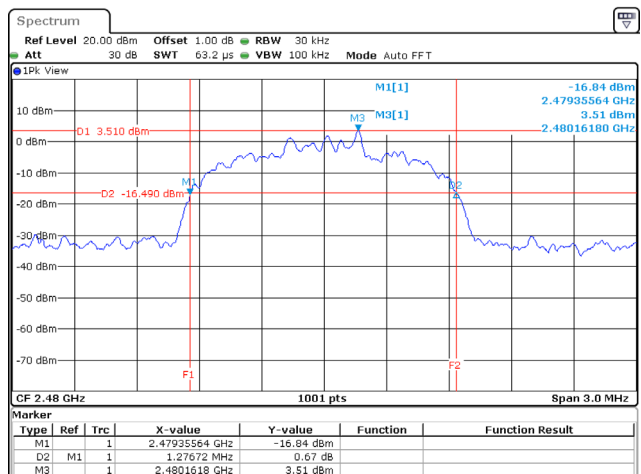

Date: 7.OCT.2021 02:20:35

10. Dwell Time

10.1. Test Setup

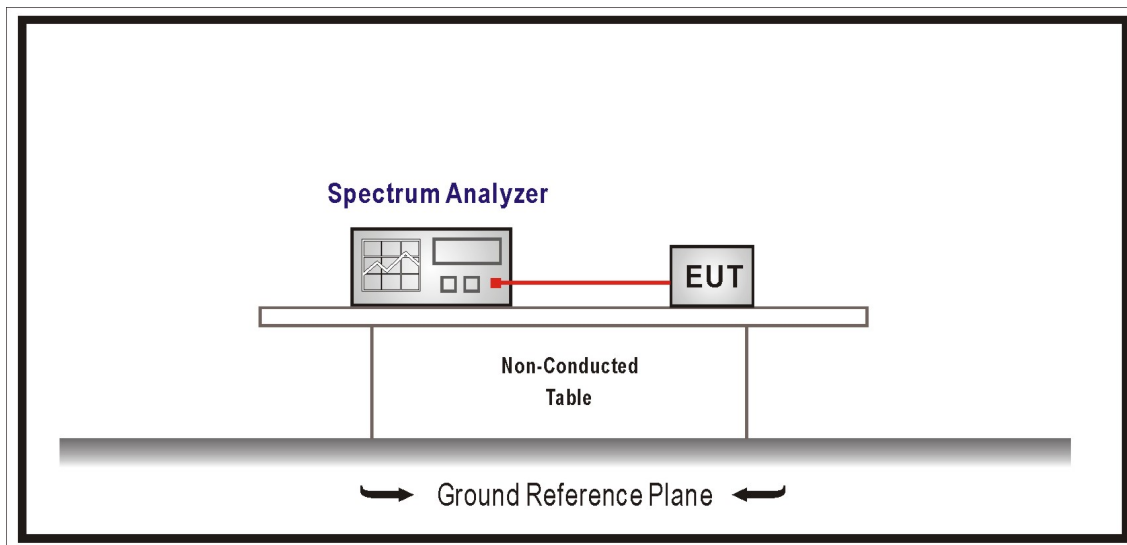

10.2. Test Limit

For frequency hopping systems operating in the 902-928 MHz band: if the 20 dB bandwidth of the hopping channel is less than 250 kHz, the system shall use at least 50 hopping frequencies and the average time of occupancy on any frequency shall not be greater than 0.4 seconds within a 20 second period; if the 20 dB bandwidth of the hopping channel is 250 kHz or greater, the system shall use at least 25 hopping frequencies and the average time of occupancy on any frequency shall not be greater than 0.4 seconds within a 10 second period.

For frequency hopping systems operating in the 2400-2483.5 MHz bands. The average time of occupancy on any channel shall not be greater than 0.4 seconds within a period of 0.4 seconds multiplied by the number of hopping channels employed.

For frequency hopping systems operating in the 5725-5850 MHz bands. The average time of occupancy on any frequency shall not be greater than 0.4 seconds within a 30 second period.

10.3. Test Procedures

The EUT was setup according to ANSI C63.10: 2013 and tested according to FHSS test procedure of FCC KDB 558074 D01 v05r02 for compliance to FCC 47CFR 15.247 requirements

Span = zero span, centered on a hopping channel, RBW = 1 MHz, VBW \geq RBW,

Sweep = as necessary to capture the entire dwell time per hopping channel,

Detector function = peak, Trace = max hold.

10.4. Test Specification

According to FCC Part 15 Subpart C Paragraph 15.247

10.5. Test Result of Dwell Time

Modulation	Occupancy Time of Frequency Hopping System
GFSK	A) 2402 MHz Test Time Period: $0.4 \times 79 = 31.60$ sec, Time slot length : 2.870 ms = 0.002870 sec Dwell Time : $0.002870 \times (266.67/79) \times 31.60 = 0.3061$ sec.
	B) 2441 MHz Test Time Period: $0.4 \times 79 = 31.60$ sec, Time slot length : 2.870 ms = 0.002870 sec Dwell Time : $0.002870 \times (266.67/79) \times 31.60 = 0.3061$ sec.
	C) 2480 MHz Test Time Period: $0.4 \times 79 = 31.60$ sec, Time slot length : 2.870 ms = 0.002870 sec Dwell Time : $0.002870 \times (266.67/79) \times 31.60 = 0.3061$ sec.
	A) 2402 MHz Test Time Period: $0.4 \times 79 = 31.60$ sec, Time slot length : 2.880 ms = 0.002880 sec Dwell Time : $0.002880 \times (266.67/79) \times 31.60 = 0.3072$ sec.
	B) 2441 MHz Test Time Period: $0.4 \times 79 = 31.60$ sec, Time slot length : 2.880 ms = 0.002880 sec Dwell Time : $0.002880 \times (266.67/79) \times 31.60 = 0.3072$ sec.
	C) 2480 MHz Test Time Period: $0.4 \times 79 = 31.60$ sec, Time slot length : 2.880 ms = 0.002880 sec Dwell Time : $0.002880 \times (266.67/79) \times 31.60 = 0.3072$ sec.
Test Result: The Average Occupancy Time of Each Highest, Middle and Lowest Channel Is Less Than 0.4 sec, And Corresponds to The Standard.	

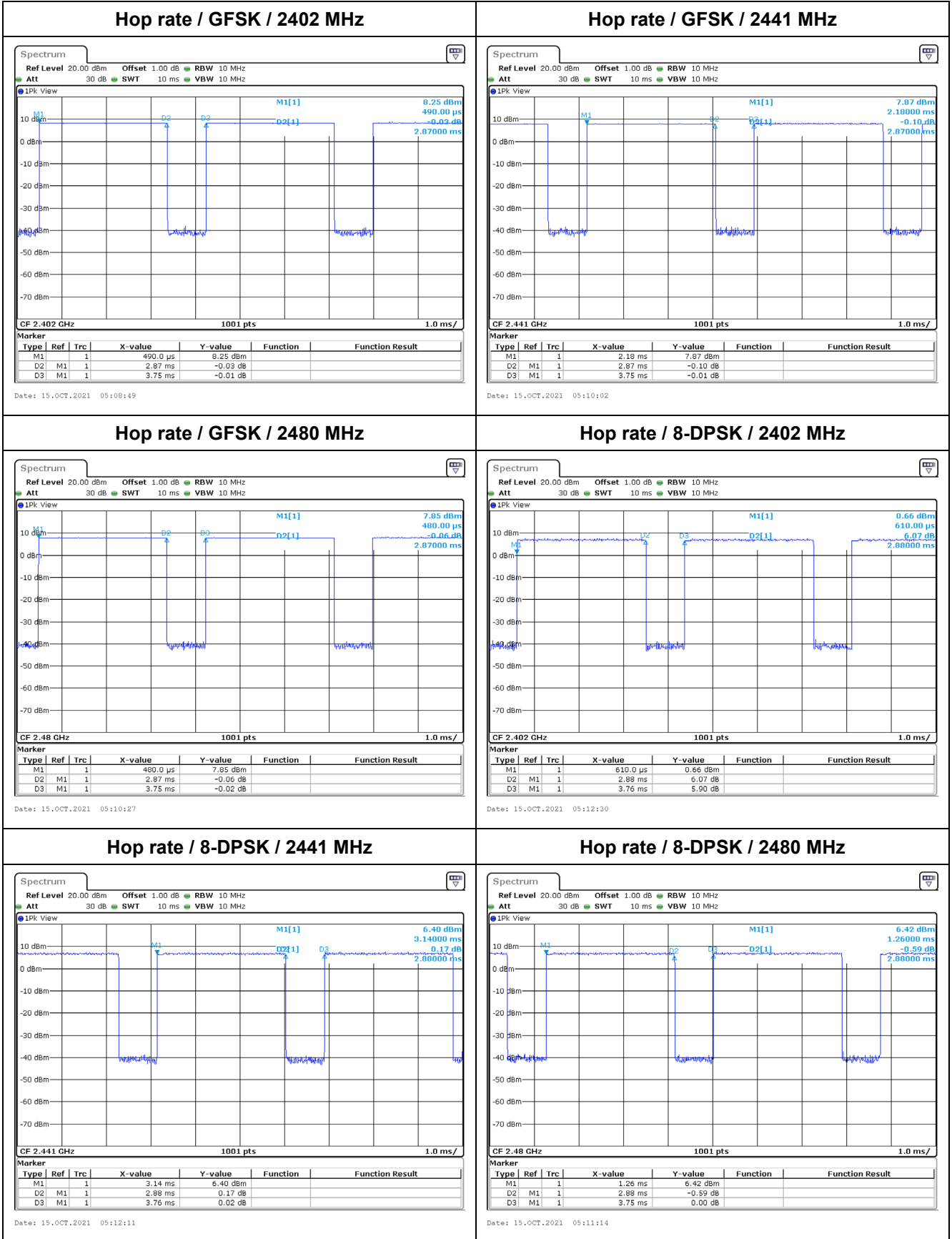

Note: Dwell time = time slot length * hop rate / number of hopping channels * period