

FCC AND ISED SDoC TEST REPORT

FOR

Applicant	:	Infinet LLC
Address	:	69/75 Vavilova str. Off. 425, 117997, Moscow, Russian Federation
Equipment under Test	:	Fixed Use Equipment
Model No.	:	E5-ST18 / 06000, E6-ST18 / 06400
Trade Mark	:	N/A
Manufacturer	:	Infinet LLC
Address	:	S.Deryabina str., 24, off. 701, 620149, Ekaterinburg, Russian Federation

Issued By: Dongguan Dongdian Testing Service Co., Ltd.

Add: No. 17, Zongbu Road 2, Songshan Lake Sci&Tech, Industry Park, Dongguan
City, Guangdong Province, China, 523808

Tel: +86-0769-38826678, **E-mail:** ddt@dgddt.com, **http://**www.dgddt.com

REPORT

TABLE OF CONTENTS

	Test report declare	3
1.	Summary of Test Results.....	5
2.	General Test Information	6
2.1.	Description of EUT	6
2.2.	Accessories of EUT.....	6
2.3.	Assistant equipment used for test.....	6
2.4.	Block diagram EUT configuration for test	7
2.5.	Decision of final test mode	7
2.6.	Test environment conditions	7
2.7.	Deviations of test standard.....	7
2.8.	Test laboratory	7
2.9.	Measurement uncertainty.....	8
3.	Conducted Emission Test Report	9
3.1.	Test equipment.....	9
3.2.	Block diagram of test setup.....	9
3.3.	Limits	10
3.4.	Test procedure	11
3.5.	Test result.....	11
3.6.	Test photo	14
4.	Radiated Emissions Test	15
4.1.	Test equipment.....	15
4.2.	Block diagram of test setup.....	16
4.3.	Limits	18
4.4.	Test Procedure.....	18
4.5.	Test result.....	19
4.6.	Test photo	24
5.	Photos of the EUT	26

TEST REPORT DECLARE

Applicant	:	Infinet LLC
Address	:	69/75 Vavilova str. Off. 425, 117997, Moscow, Russian Federation
Equipment under Test	:	Fixed Use Equipment
Model No.	:	E5-ST18 / 06000, E6-ST18 / 06400
Trade Mark	:	N/A
Manufacturer	:	Infinet LLC
Address	:	S.Deryabina str., 24, off. 701, 620149, Ekaterinburg, Russian Federation

Test Standard Used:

FCC Rules and Regulations Part 15 Subpart B, ICES-003 Issue 7

Test Procedure Used:

ANSI C63.4-2014, ANSI C63.4a-2017, ICES-GEN Issue 1

We Declare:

The equipment described above is tested by Dongguan Dongdian Testing Service Co., Ltd. and in the configuration tested the equipment complied with the standards specified above. The test results are contained in this test report and Dongguan Dongdian Testing Service Co., Ltd. is assumed of full responsibility for the accuracy and completeness of these tests.

After test and evaluation, our opinion is that the equipment provided for test compliance with the requirement of the above FCC and ISED standards.

Report No.:	DDT-R21070824-1E04		
Date of Receipt:	Dec. 23, 2021	Date of Test:	Dec. 23, 2021 ~ Dec. 27, 2021

Prepared By:

Eddie Liu

Eddie Liu /Engineer

Approved By:



Damon Hu/EMC Manager

Note: This report applies to above tested sample only. This report shall not be reproduced in parts without written approval of Dongguan Dongdian Testing Service Co., Ltd.

Revision History

Rev.	Revisions	Issue Date	Revised By
---	Initial issue	Jan. 11, 2022	

1. Summary of Test Results

Description of Test Item	Standard	Result
Conducted disturbance at AC mains terminals	FCC Rules and Regulations Part 15 Subpart B, ICES-003 Issue 7, ANSI C63.4-2014, ANSI C63.4a-2017, ICES-GEN Issue 1	PASS
Radiated disturbance test	FCC Rules and Regulations Part 15 Subpart B, ICES-003 Issue 7, ANSI C63.4-2014, ANSI C63.4a-2017, ICES-GEN Issue 1	PASS

2. General Test Information

2.1. Description of EUT

EUT* Name	: Fixed Use Equipment
Model Number	: E5-ST18 / 06000, E6-ST18 / 06400
EUT function description	: Please reference user manual of this device
Power supply	: DC 48V 0.5A from Indoor Power Supply Unit
EUT Class	: Class B
Maximum work frequency	: 5610 MHz
Sample Type	: Series production
Serial Number	: N/A

Note 1: EUT is the abbreviation of equipment under test.

2.2. Accessories of EUT

Description of Accessories	Manufacturer	Model number	Serial No.	Other
Indoor Power Supply Unit	INFINET	IDU-CPE-G(24W)	N/A	INPUT: 100-240V AC~ 50/60 Hz 1.5A OUTPUT: 48V 0.5A(24W)
Network cable	N/A	N/A	N/A	N/A

2.3. Assistant equipment used for test

Assistant equipment	Manufacturer	Model number	Serial No.	other
Laptop	HP	HP ProBook 445 G6	5CD9112VSV	N/A

2.4. Block diagram EUT configuration for test

For mode 1: EUT ON

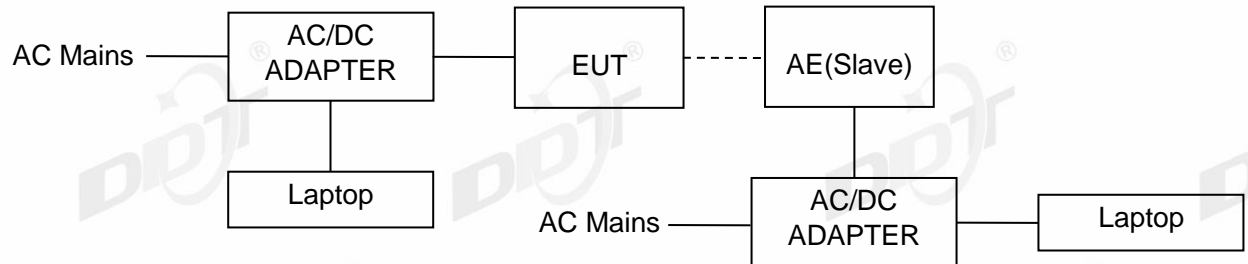

Note: According exploration test, adjust the volume of EUT radiated the maximum emissions.

2.5. Decision of final test mode

Emission	Conducted Emission	Mode 1
	Radiated emission	Mode 1

2.6. Test environment conditions

During the measurement the environmental conditions were within the listed ranges:

Temperature range:	21-25°C
Humidity range:	40-75%
Pressure range:	86-106kPa

2.7. Deviations of test standard

No Deviation

2.8. Test laboratory

Dongguan Dongdian Testing Service Co., Ltd.

Add.: No. 17, Zongbu Road 2, Songshan Lake Sci&Tech, Industry Park, Dongguan City, Guangdong Province, China, 523808.

Tel.: +86-0769-38826678, <http://www.dgddt.com>, Email: ddt@dgddt.com.

CNAS Accreditation No. L6451; A2LA Accreditation Number: 3870.01

FCC Designation Number: CN1182, Test Firm Registration Number: 540522

Innovation, Science and Economic Development Canada Site Registration Number: 10288A

Conformity Assessment Body identifier: CN0048

VCCI facility registration number: C-20087, T-20088, R-20123, G-20118

2.9. Measurement uncertainty

Test Item	Uncertainty
Conducted disturbance at mains terminals	3.32dB (150KHz-30MHz)
Uncertainty for telecommunication port conduction emission test	AAN with aLCL = 55 ... 40 dBc: 3.64 dB AAN with aLCL = 65 ... 50 dBc: 4.08 dB AAN with aLCL = 75 ... 60 dBc: 4.56 dB
Uncertainty for Radiation Emission test (30MHz-1GHz)	4.70 dB (Antenna Polarize: V)
	4.84 dB (Antenna Polarize: H)
Uncertainty for Radiation disturbance test (1GHz to 40GHz)	4.10 dB(1-6GHz)
	4.40 dB (6GHz-18GHz)
	4.58 dB (18GHz-40GHz)
Temperature	0.4 °C
Humidity	2%

Note: This uncertainty represents an expanded uncertainty expressed at approximately the 95% confidence level using a coverage factor of k=2.

3. Conducted Emission Test Report

3.1. Test equipment

Equipment	Manufacturer	Model No.	Serial No.	Last Cal.	Cal. Interval
<input checked="" type="checkbox"/> 2# Conducted emission					
Test Receiver	R&S	ESCI	101028	Sep. 02, 2021	1 Year
LISN 1	R&S	ENV216	101170	Sep. 07, 2021	1 Year
LISN 2	R&S	ENV216	101209	Sep. 02, 2021	1 Year
Pulse Limiter	R&S	KH43101	4310118015 68-12#	Jun. 01, 2021	1 Year
CE Cable 2	HUBSER	RG214-5	N/A	Jun. 01, 2021	1 Year
Test software	Audix	E3	V 6.11111b	N/A	N/A
<input type="checkbox"/> 1# Conducted emission					
Test Receiver	R&S	ESCI	100551	Sep. 02, 2021	1 Year
LISN 1	R&S	ENV216	101109	Sep. 07, 2021	1 Year
LISN 2	R&S	ESH2-Z5	100309	Sep. 07, 2021	1 Year
Pulse Limiter	R&S	ESH3-Z2	101242	Sep. 02, 2021	1 Year
CE Cable 1	HUBSER	N/A	W10.01	Sep. 02, 2021	1 Year
LISN 3	SCHWARZBECK	NSLK 8163	00017	Sep. 02, 2021	1 Year
Test software	Audix	E3	V 6.11111b	N/A	N/A

3.2. Block diagram of test setup

For table-top equipment

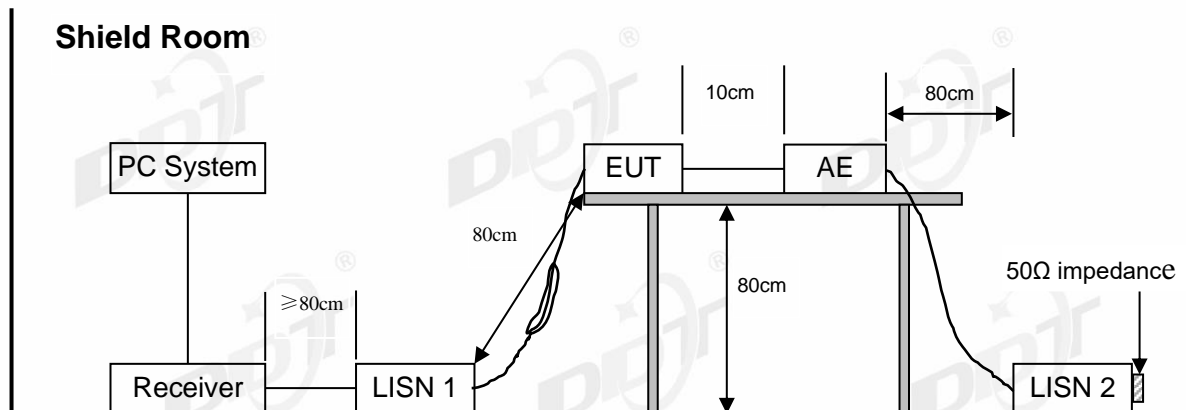

For floor standing equipment

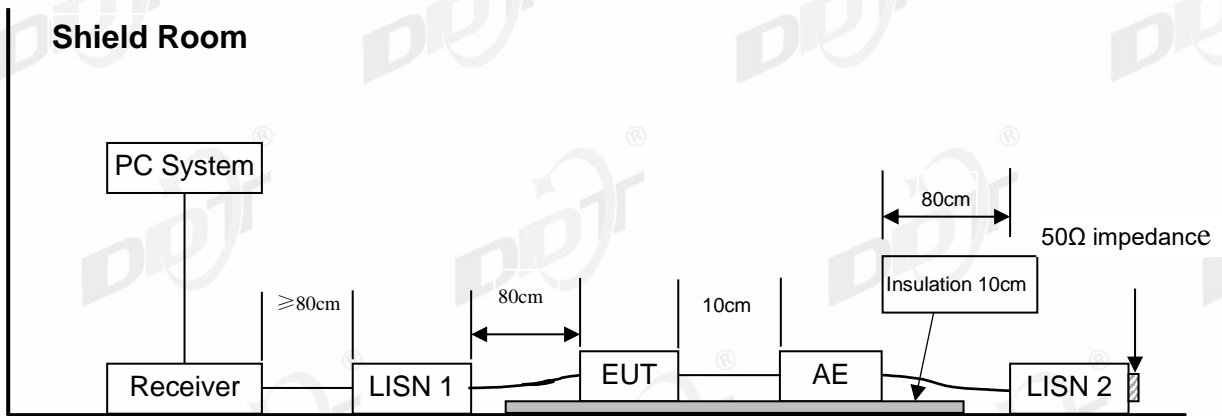

For combinations equipment

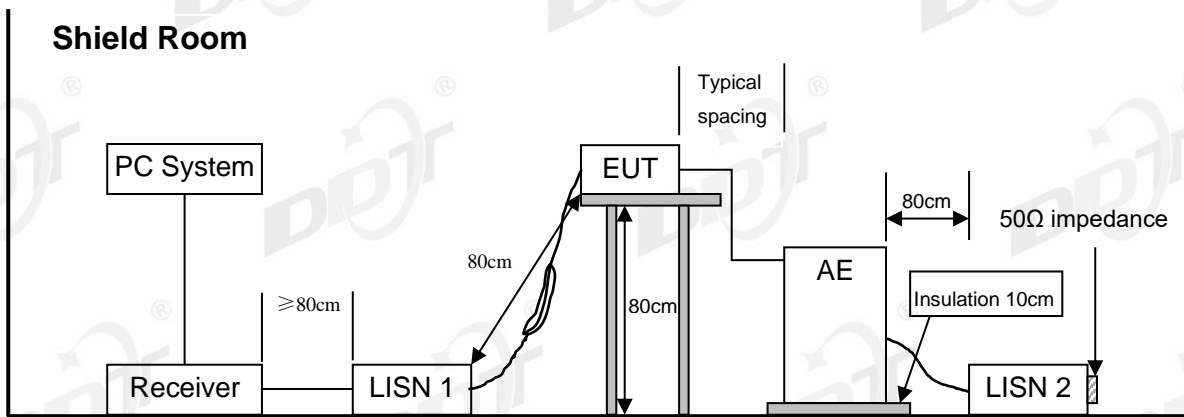

3.3. Limits

Class A

Frequency	Quasi-Peak Level dB(μV)	Average Level dB(μV)
150 kHz ~ 500 kHz	79	66
500 kHz ~ 30 MHz	73	60

Class B

Frequency	Quasi-Peak Level dB(μV)	Average Level dB(μV)
150 kHz ~ 500 kHz	66 ~ 56*	56 ~ 46*
500 kHz ~ 5 MHz	56	46
5 MHz ~ 30 MHz	60	50

Notes: 1. * Decreasing linearly with logarithm of frequency.

2. The lower limit shall apply at the transition frequencies.

3.4. Test procedure

The EUT and Support equipment, if needed, were put placed on a non-metallic table, 0.8m (table-top device)/0.1m (floor stand device) above the ground plane.

All I/O cables were positioned to simulate typical actual usage as per ANSI C63.4.

All support equipment power received from a second LISN.

Emissions were measured on each current carrying line of the EUT using an EMI Test Receiver connected to the LISN powering the EUT.

The Receiver scanned from 150 kHz to 30MHz for emissions in each of the test modes.

During the above scans, the emissions were maximized by cable manipulation.

The test mode(s) described in clause 2.4 were scanned during the preliminary test.

After the preliminary scan, we found the test mode producing the highest emission level.

The EUT configuration and worse cable configuration of the above highest emission levels were recorded for reference of the final test.

EUT and support equipment were set up on the test bench as per the configuration with highest emission level in the preliminary test.

A scan was taken on both power lines, Neutral and Line, recording at least the six highest emissions. Emission frequency and amplitude were recorded into a computer in which correction factors were used to calculate the emission level and compare reading to the applicable limit.

The test data of the worst-case condition(s) was recorded.

The bandwidth of test receiver is set at 9 kHz.

3.5. Test result

PASS. (See below detailed test result)

Note 1: All emissions not reported below are too low against the prescribed limits.

Note 2: "-----" means Peak detection; "-----" means Average detection.

TR-4-E-010 Conducted Emission Test Result

Test Site : DDT 5# Shield Room D:\2021 report data\Q21070824-1E\CE.EM6
Test Date : 2021-12-27 **Tested By** : Vic Xie
EUT : Fixed Use Equipment **Model Number** : E5-ST18 / 06000
Power Supply : AC 120V/60Hz **Test Mode** : EUT ON
Condition : Temp:23.1 °C,Humi:53.3%,Press:101.4kPa **LISN** : 2021 2# ENV216/LINE
Memo :

Data: 2

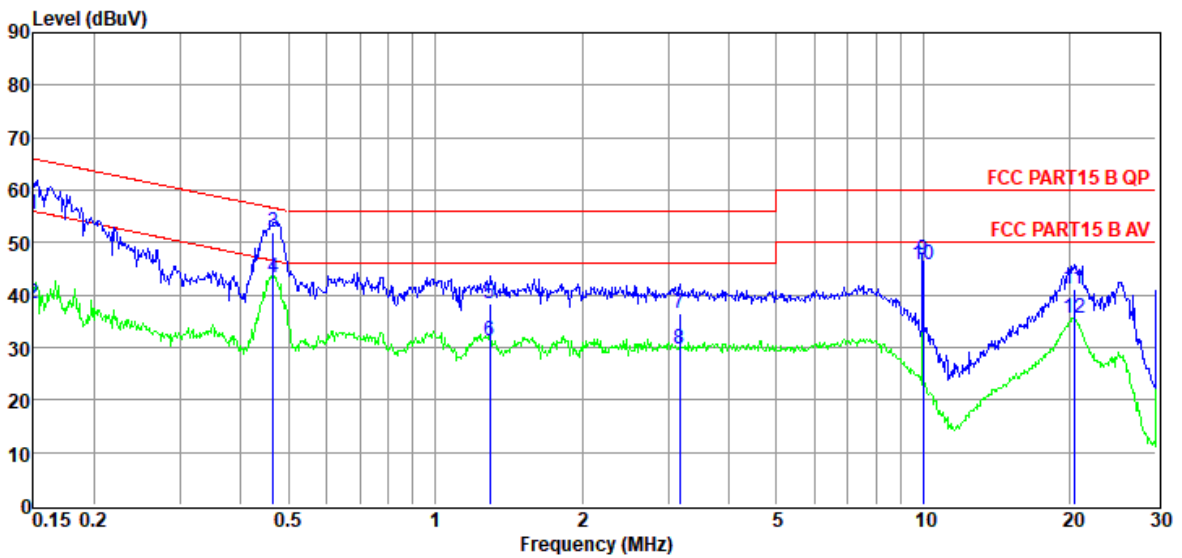

Item (Mark)	Freq. (MHz)	Read Level (dBuV)	LISN Factor (dB)	Cable Loss (dB)	Pulse Limiter Factor (dB)	Result Level (dBuV)	Limit Line (dBuV)	Over Limit (dB)	Detector	Phase
1	0.15	35.97	9.40	0.03	10.01	55.41	66.00	-10.59	QP	LINE
2	0.15	18.94	9.40	0.03	10.01	38.38	56.00	-17.62	Average	LINE
3	0.47	32.48	9.32	0.05	10.01	51.86	56.58	-4.72	QP	LINE
4	0.47	24.01	9.32	0.05	10.01	43.39	46.58	-3.19	Average	LINE
5	1.30	19.00	9.30	0.08	10.01	38.39	56.00	-17.61	QP	LINE
6	1.30	11.90	9.30	0.08	10.01	31.29	46.00	-14.71	Average	LINE
7	3.17	16.95	9.37	0.09	10.01	36.42	56.00	-19.58	QP	LINE
8	3.17	10.34	9.37	0.09	10.01	29.81	46.00	-16.19	Average	LINE
9	10.00	27.34	9.20	0.11	10.01	46.66	60.00	-13.34	QP	LINE
10	10.00	26.52	9.20	0.11	10.01	45.84	50.00	-4.16	Average	LINE
11	20.38	21.64	9.40	0.13	10.02	41.19	60.00	-18.81	QP	LINE
12	20.38	15.87	9.40	0.13	10.02	35.42	50.00	-14.58	Average	LINE

- Note: 1. Result Level = Read Level + LISN Factor + Pulse Limiter Factor + Cable loss.
 2. If QP Result complies with AV limit, AV Result is deemed to comply with AV limit.
 3. Test setup: RBW: 200 Hz (9 kHz—150 kHz), 9 kHz (150 kHz—30 MHz).
 4. Step size: 80Hz (0.009MHz-0.15MHz), 4 kHz (0.15MHz-30MHz), Scan time: auto.

TR-4-E-010 Conducted Emission Test Result

Test Site : DDT 5# Shield Room D:\2021 report data\Q21070824-1E\CE.EM6
Test Date : 2021-12-27 **Tested By** : Vic Xie
EUT : Fixed Use Equipment **Model Number** : E5-ST18 / 06000
Power Supply : AC 120V/60Hz **Test Mode** : EUT ON
Condition : Temp:23.1 °C,Humi:53.3%,Press:101.4kPa **LISN** : 2021 2# ENV216/NEUTRAL
Memo :

Data: 4

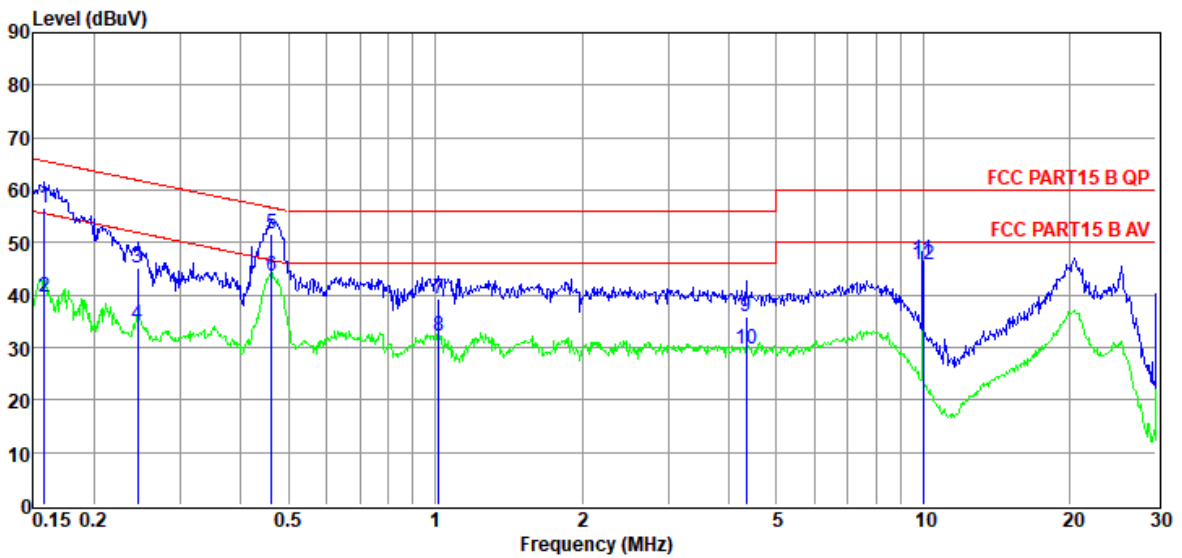

Item (Mark)	Freq. (MHz)	Read Level (dBuV)	LISN Factor (dB)	Cable Loss (dB)	Pulse Limiter Factor (dB)	Result Level (dBuV)	Limit Line (dBuV)	Over Limit (dB)	Detector	Phase
1	0.16	36.84	9.58	0.03	10.01	56.46	65.56	-9.10	QP	NEUTRAL
2	0.16	19.95	9.58	0.03	10.01	39.57	55.56	-15.99	Average	NEUTRAL
3	0.25	25.66	9.46	0.04	10.01	45.17	61.91	-16.74	QP	NEUTRAL
4	0.25	14.72	9.46	0.04	10.01	34.23	51.91	-17.68	Average	NEUTRAL
5	0.46	32.37	9.32	0.05	10.01	51.75	56.67	-4.92	QP	NEUTRAL
6	0.46	24.10	9.32	0.05	10.01	43.48	46.67	-3.19	Average	NEUTRAL
7	1.02	19.79	9.40	0.08	10.01	39.28	56.00	-16.72	QP	NEUTRAL
8	1.02	12.63	9.40	0.08	10.01	32.12	46.00	-13.88	Average	NEUTRAL
9	4.34	16.42	9.47	0.09	10.01	35.99	56.00	-20.01	QP	NEUTRAL
10	4.34	10.14	9.47	0.09	10.01	29.71	46.00	-16.29	Average	NEUTRAL
11	10.00	27.13	9.50	0.11	10.01	46.75	60.00	-13.25	QP	NEUTRAL
12	10.00	26.28	9.50	0.11	10.01	45.90	50.00	-4.10	Average	NEUTRAL

- Note: 1. Result Level = Read Level + LISN Factor + Pulse Limiter Factor + Cable loss.
 2. If QP Result complies with AV limit, AV Result is deemed to comply with AV limit.
 3. Test setup: RBW: 200 Hz (9 kHz—150 kHz), 9 kHz (150 kHz—30 MHz).
 4. Step size: 80Hz (0.009MHz-0.15MHz), 4 kHz (0.15MHz-30MHz), Scan time: auto.

3.6. Test photo



4. Radiated Emissions Test

4.1. Test equipment

Equipment	Manufacturer	Model No.	Serial No.	Last Cal.	Cal. Interval
<input checked="" type="checkbox"/> 1# Radiation chamber					
EMI Test Receiver	R&S	ESU8	100316	Sep. 02, 2021	1 Year
Spectrum analyzer	Agilent	E4447A	MY50180031	Jun. 01, 2021	1 Year
Trilog Broadband Antenna	Schwarzbeck	VULB9163	9163-462	Nov. 29, 2021	1 Year
Active Loop antenna	Schwarzbeck	FMZB-1519	1519-038	Sep. 19, 2021	1 Year
Double Ridged Horn Antenna	R&S	HF907	100276	Sep. 19, 2021	1 Year
Broad Band Horn Antenna	Schwarzbeck	BBHA 9170	790	May 08, 2021	1 Year
Pre-amplifier	COM-POWER	PAM-118A	18040119	Sep. 09, 2021	1 Year
Pre-amplifier	TRLA-MW	TRLA-0040G35	101303	Sep. 02,2021	1 Year
RF Cable	HUBSER	CP-X2+ CP-X1	W11.03+ W12.02	Sep. 02,2021	1 Year
RF Cable	N/A	5m+6m+1m	06270619	Sep. 02, 2021	1 Year
MI Cable	HUBSER	C10-01-01-1M	1091629	Sep. 02, 2021	1 Year
Test software	Audix	E3	V 6.11111b	N/A	N/A
<input checked="" type="checkbox"/> 2# Radiation chamber					
EMI Test Receiver	R&S	ESCI	101028	Sep. 02, 2021	1 Year
Spectrum analyzer	Agilent	E4440A	MY46185770	Jun. 01, 2021	1 Year
Trilog Broadband Antenna	Schwarzbeck	VULB 9163	9163-994	Sep. 27, 2021	1 Year
Trilog Broadband Antenna	Schwarzbeck	VULB 9161	9161-4034	Sep. 19, 2021	1 Year
Active Loop antenna	Schwarzbeck	FMZB-1519	1519-038	Sep. 19, 2021	1 Year
Double Ridged Horn Antenna	Schwarzbeck	BBHA9120D	9120D-2108	Jul. 17, 2021	1 Year
Broad Band Horn Antenna	Schwarzbeck	BBHA 9170	790	May 08, 2021	1 Year
Pre-amplifier	A.H.	PAM-0118	18040084	Sep. 02,2021	1 Year
Pre-amplifier	TRLA-MW	TRLA-0040G35	101303	Sep. 02,2021	1 Year
RF Cable	MI Cable	RG214-11	DDT- ZC01497	Jun. 09, 2021	1 Year
Test software	Audix	E3	V 6.11111b	N/A	N/A
<input type="checkbox"/> 3# Radiation chambe					
EMI Test Receiver	R&S	ESU	100472	Jun. 01, 2021	1 Year
Active Loop antenna	Schwarzbeck	FMZB-1519	1519-038	Sep. 19, 2021	1 Year
Trilog Broadband Antenna	Schwarzbeck	VULB 9163	01429	Aug. 07, 2021	1 Year
Double Ridged Horn Antenna	Schwarzbeck	BBHA9120	02108	Jul. 17, 2021	1 Year
Pre-amplifier	COM-POWER	PAM-118A	18040084	Sep. 02,2021	1 Year
RF Cable	N/A	14+1.5m	06270619	Sep. 02,2021	1 Year
Test software	Audix	E3	V 9	N/A	N/A
Notes. N/A means Not applicable.					

4.2. Block diagram of test setup

Below 1 GHz

For table-top equipment

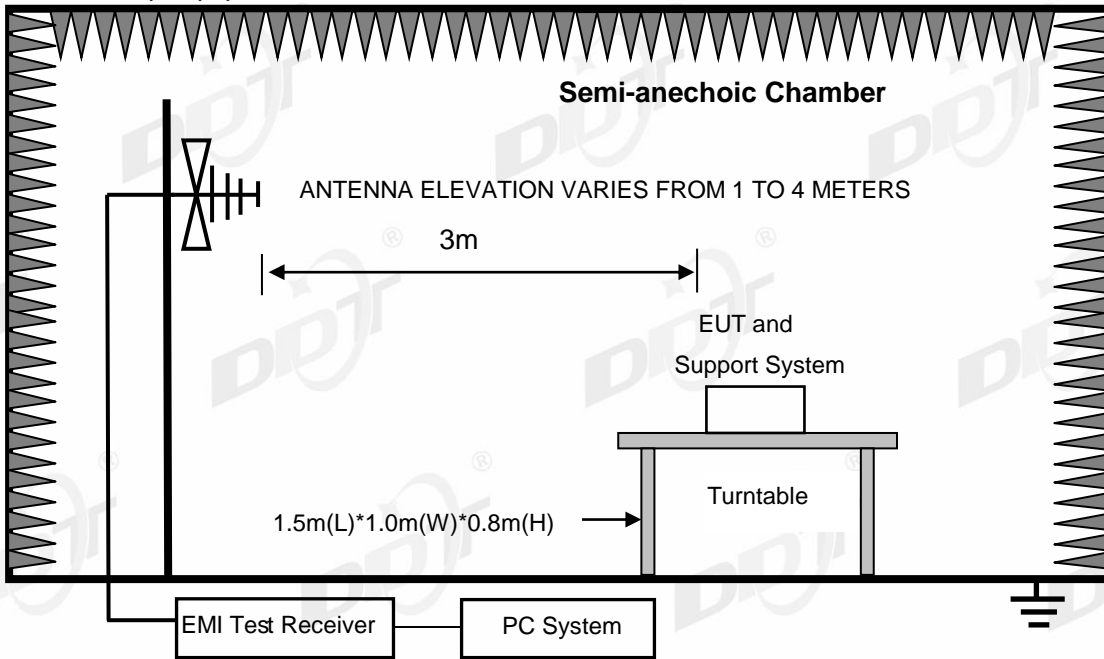

For floor standing equipment

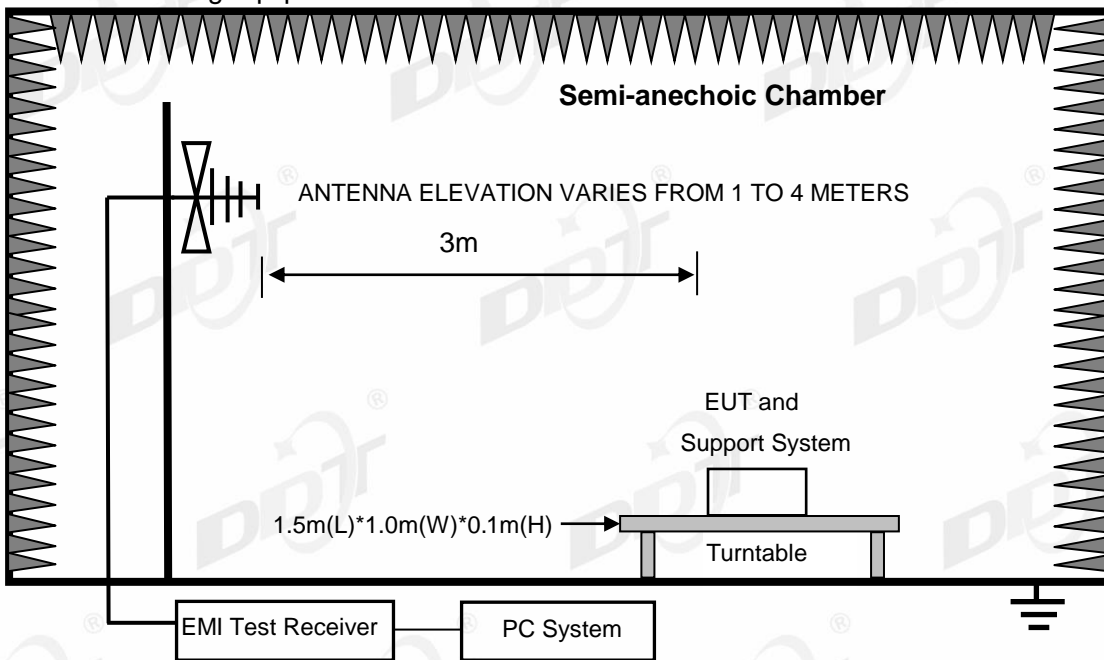

Above 1 GHz
For table-top equipment

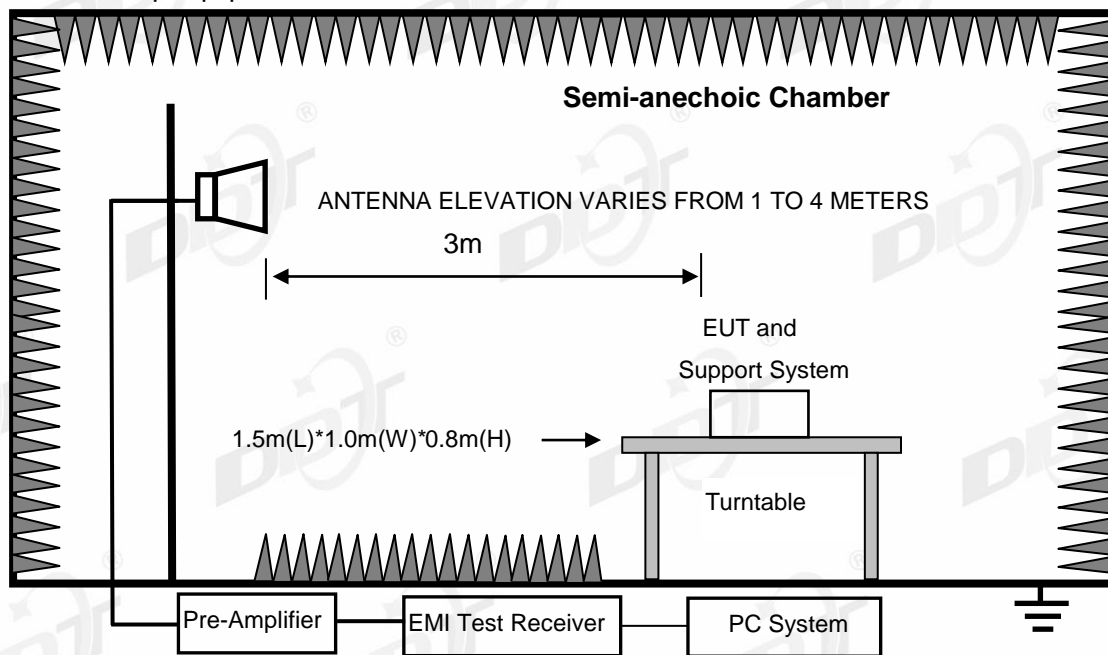

For floor standing equipment

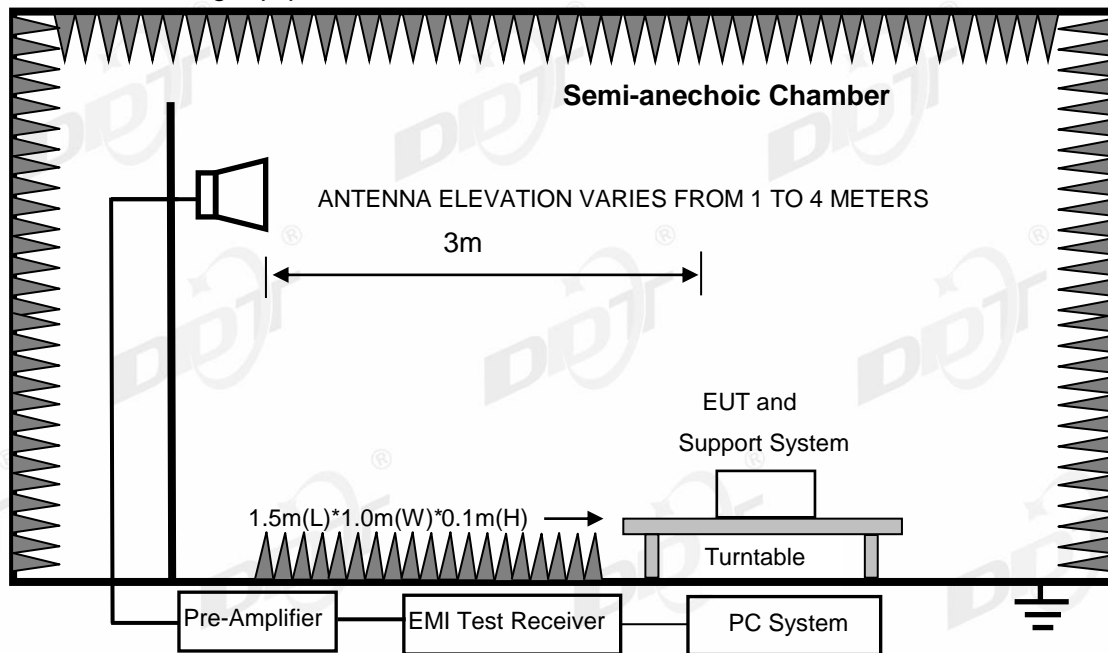

4.3. Limits

For FCC Rules and Regulations Part 15 Subpart B limits:

Frequency (MHz)	Class A Field Strengths Limits at 10m measuring distance dB(μ V)/m	Class A Field Strengths Limits at 3m measuring distance dB(μ V)/m	Class B Field Strengths Limits at 10m measuring distance dB(μ V)/m	Class B Field Strengths Limits at 3m measuring distance dB(μ V)/m
30--88	39.0	49.5	29.5	40.0
88--216	43.5	54.0	33.0	43.5
216--960	46.4	57.0	35.5	46.0
960-1000	49.5	60.0	43.5	54.0
Above 1000	/	80.0 (Peak), 60.0 (Average)	/	74.0 (Peak), 54.0 (Average)

For ICES-003 Issue 7 limits:

Frequency (MHz)	Class A Field Strengths Limits at 10m measuring distance dB(μ V)/m	Class A Field Strengths Limits at 3m measuring distance dB(μ V)/m	Class B Field Strengths Limits at 10m measuring distance dB(μ V)/m	Class B Field Strengths Limits at 3m measuring distance dB(μ V)/m
30--88	40.0	50.0	30.0	40.0
88--216	43.5	54.0	33.1	43.5
216-230	46.4	56.9	35.6	46.0
230--960	47.0	57.0	37.0	47.0
960-1000	49.5	60.0	43.5	54.0
Above 1000	/	80.0 (Peak), 60.0 (Average)	/	74.0 (Peak), 54.0 (Average)

Note: (1) The smaller limit shall apply at the cross point between two frequency bands.

Note: (2) If results comply with the FCC part 15 limits, then they are also complying with the ICES-003 limits.

Note: (3) Test receiver use the Quasi-peak detector for testing in below 1GHz.

4.4. Test Procedure

Procedure of Preliminary Test

The EUT and Support equipment, if needed, were put placed on a non-metallic table, 0.8m (table-top device)/0.1m (floor stand device) above the ground plane.

Configuration EUT to simulate typical usage as described in as shown above block diagram and equipment list of this report.

All I/O cables were positioned to simulate typical actual usage as per ANSI C63.4.

Mains cables, telephone lines or other connections to auxiliary equipment located outside the test are shall drape to the floor, be fitted with ferrite clamps or ferrite tubes placed on the floor at the point where the cable reaches the floor and then routed to the place where they leave the turntable. No extension cords shall be used to mains receptacle.

The antenna was placed at 3 meter away from the EUT as stated in ANSI C63.4. The antenna connected to the Spectrum Analyzer via a cable and at times a pre-amplifier would be used.

The Analyzer / Receiver quickly scanned from 30 MHz to 1 GHz/ 18 GHz. The EUT test program was started. Emissions were scanned and measured rotating the EUT to 360 degrees and positioning the antenna 1 to 4 meters above the ground plane, in both the vertical and the horizontal polarization, to maximize the emission reading level.

The test mode(s) described in clause 2.4 were scanned during the preliminary test:

After the preliminary scan, we found the test mode producing the highest emission level. The EUT and cable configuration, antenna position, polarization and turntable position of the above highest emission level were recorded for the final test.

Procedure of Final Test

EUT and support equipment were set up on the turntable as per the configuration with highest emission level in the preliminary test.

The Analyzer / Receiver scanned from 30 MHz to 1 GHz/ 18 GHz. Emissions were scanned and measured rotating the EUT to 360 degrees, varying cable placement and positioning the antenna 1 to 4 meters above the ground plane, in both the vertical and the horizontal polarization, to maximize the emission reading level.

Recorded at least the six highest emissions. Emission frequency, amplitude, antenna position, polarization and turntable position were recorded into a computer in which correction factors were used to calculate the emission level and compare reading to the applicable limit and only Q.P. reading is presented.

For emissions from 30 MHz to 1 GHz, Quasi-Peak values were measured with EMI Receiver and the bandwidth of Receiver is 120 kHz.

For emissions above 1 GHz, both Peak and Average level were measured with Spectrum Analyzer, and the RBW is set at 1 MHz VBW is set at 3 MHz.

The test data of the worst-case condition(s) was recorded.

4.5. Test result

PASS. (See below detailed test result)

Note 1: All emissions not reported below are too low against the prescribed limits.

Note 2: "----" means Peak detection.

Note 3: According exploratory test, the emission levels are 20 dB below the limit detected from 9 kHz to 30 MHz and 18 GHz to 40 GHz, so the final test was performed with frequency range from 30 MHz to 18 GHz and recorded in below.

Radiated Emission test (30 MHz - 1 GHz)

TR-4-E-009 Radiated Emission Test Result

Test Site : DDT 3m Chamber 2# **D:\2021 RE2# Report Data\Q21070824-1E\RE.EM6**
Test Date : 2021-12-23 **Tested By** : Junchang Du
EUT : Fixed Use Equipment **Model Number** : E5-ST18 / 06000
Power Supply : AC 120V/60Hz **Test Mode** : EUT ON
Condition : Temp:24.5°C,Humi:54.2%,Press:101.4kPa **Antenna/Distance** : 2021 VULB 9163 #2/3m/HORIZONTAL
Memo :

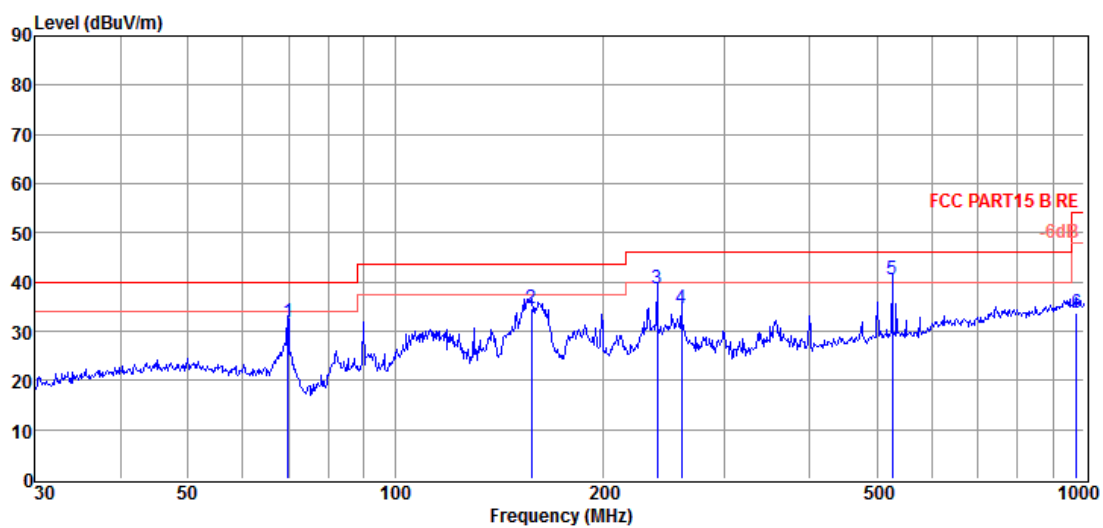

Data: 7

Item (Mark)	Freq. (MHz)	Read Level (dB μ V)	Antenna Factor (dB/m)	Cable Loss dB	Result Level (dB μ V/m)	Limit Line (dB μ V/m)	Over Limit (dB)	Detector	Polarization
1	69.85	17.96	10.05	3.93	31.94	40.00	-8.06	QP	HORIZONTAL
2	157.56	21.16	9.06	4.42	34.64	43.50	-8.86	QP	HORIZONTAL
3	239.99	21.70	12.30	4.81	38.81	46.00	-7.19	QP	HORIZONTAL
4	260.14	17.13	12.70	4.90	34.73	46.00	-11.27	QP	HORIZONTAL
5	526.40	16.49	17.86	6.11	40.46	46.00	-5.54	QP	HORIZONTAL
6	975.75	4.20	21.90	7.65	33.75	54.00	-20.25	QP	HORIZONTAL

Note: 1. Result Level = Read Level + Antenna Factor + Cable loss.

2. If Peak Result complies with QP limit, QP Result is deemed to comply with QP limit.

3. Test setup: RBW: 120 kHz, VBW: 300 kHz, Sweep time: auto.

TR-4-E-009 Radiated Emission Test Result

Test Site : DDT 3m Chamber 2# **D:\2021 RE2# Report Data\Q21070824-1E\RE.EM6**
Test Date : 2021-12-23 **Tested By** : Junchang Du
EUT : Fixed Use Equipment **Model Number** : E5-ST18 / 06000
Power Supply : AC 120V/60Hz **Test Mode** : EUT ON
Condition : Temp:24.5°C,Humi:54.2%,Press:101.4kPa **Antenna/Distance** : 2021 VULB 9163 #2/3m/VERTICAL
Memo :

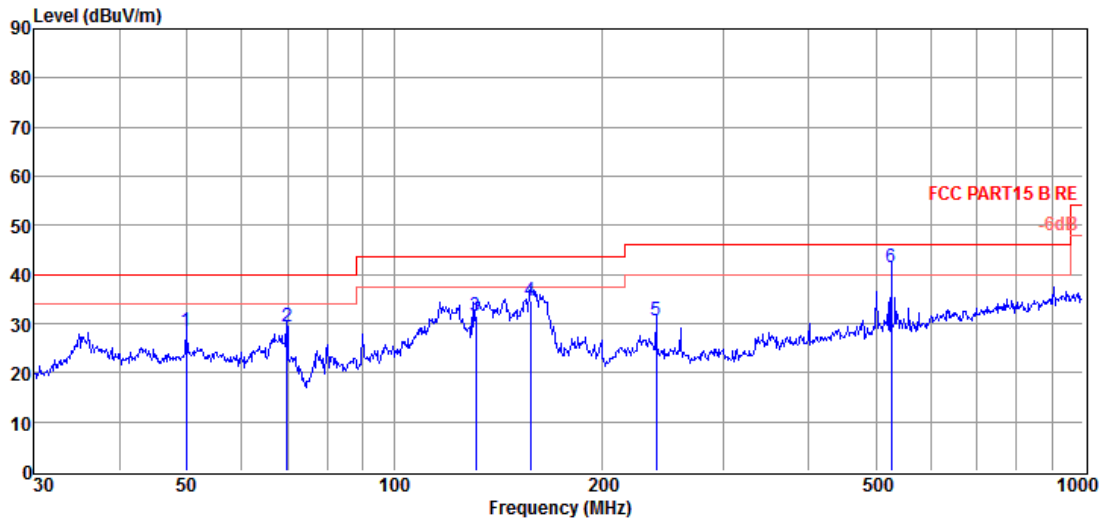

Data: 8

Item (Mark)	Freq. (MHz)	Read Level (dB μ V)	Antenna Factor (dB/m)	Cable Loss (dB)	Result Level (dB μ V/m)	Limit Line (dB μ V/m)	Over Limit (dB)	Detector	Polarization
1	49.88	10.77	13.91	3.78	28.46	40.00	-11.54	QP	VERTICAL
2	69.85	15.50	10.05	3.93	29.48	40.00	-10.52	QP	VERTICAL
3	131.30	17.40	9.77	4.30	31.47	43.50	-12.03	QP	VERTICAL
4	157.56	21.03	9.06	4.42	34.51	43.50	-8.99	QP	VERTICAL
5	239.99	13.40	12.30	4.81	30.51	46.00	-15.49	QP	VERTICAL
6	526.40	17.38	17.86	6.11	41.35	46.00	-4.65	QP	VERTICAL

- Note: 1. Result Level = Read Level + Antenna Factor + Cable loss.
 2. If Peak Result complies with QP limit, QP Result is deemed to comply with QP limit.
 3. Test setup: RBW: 120 kHz, VBW: 300 kHz, Sweep time: auto.

Radiated Emission test (Above 1 GHz) TR-4-E-009 Radiated Emission Test Result

Test Site : DDT 3m Chamber 1# **D:\2021 RE 1# Report data\Q21070824-1E\RE-H.EM6**

Test Date : 2021-12-25 **Tested By** : Chunchieh Huang

EUT : Fixed Use Equipment **Model Number** : E5-ST18 / 06000

Power Supply : AC 120V/60Hz **Test Mode** : EUT ON

Condition : Temp:23.8°C,Humi:50.4%,Press:101.4kPa **Antenna/Distance** : 2021 HF907/3m/VERTICAL

Memo :

Data: 5

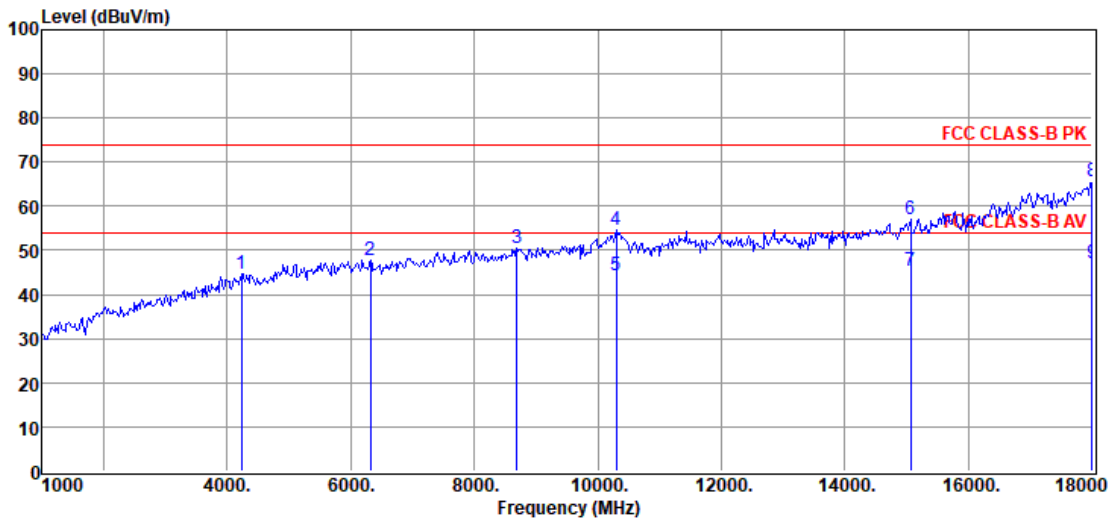

Item (Mark)	Freq. (MHz)	Read Level (dBμV)	Antenna Factor (dB/m)	PRM Factor (dB)	Cable Loss (dB)	Result Level (dBμV/m)	Limit Line (dBμV/m)	Over Limit (dB)	Detector	Polarization
1	4230.00	49.51	33.42	43.50	5.22	44.65	74.00	-29.35	Peak	VERTICAL
2	6321.00	48.71	35.32	42.50	6.20	47.73	74.00	-26.27	Peak	VERTICAL
3	8684.00	47.61	36.94	41.53	7.36	50.38	74.00	-23.62	Peak	VERTICAL
4	10299.00	48.91	40.00	42.51	8.07	54.47	74.00	-19.53	Peak	VERTICAL
5	10299.00	38.80	40.00	42.51	8.07	44.36	54.00	-9.64	Average	VERTICAL
6	15059.00	47.12	40.42	42.00	11.55	57.09	74.00	-16.91	Peak	VERTICAL
7	15059.00	35.39	40.42	42.00	11.55	45.36	54.00	-8.64	Average	VERTICAL
8	18000.00	42.85	45.40	39.00	16.40	65.65	74.00	-8.35	Peak	VERTICAL
9	18000.00	24.40	45.40	39.00	16.40	47.20	54.00	-6.80	Average	VERTICAL

Note: 1. Result Level = Read Level + Antenna Factor + Cable loss - PRM Factor.
 2. If Peak Result complies with AV limit, AV Result is deemed to comply with AV limit.
 3. Test setup: RBW: 1 MHz, VBW: 3 MHz, Sweep time: auto.

TR-4-E-009 Radiated Emission Test Result

Test Site : DDT 3m Chamber 1# **D:\2021 RE 1# Report data\Q21070824-1E\RE-H.EM6**
Test Date : 2021-12-25 **Tested By** : Chunchieh Huang
EUT : Fixed Use Equipment **Model Number** : E5-ST18 / 06000
Power Supply : AC 120V/60Hz **Test Mode** : EUT ON
Condition : Temp:23.8°C,Humi:50.4%,Press:101.4kPa **Antenna/Distance** : 2021 HF907/3m/HORIZONTAL

Memo :

Data: 6

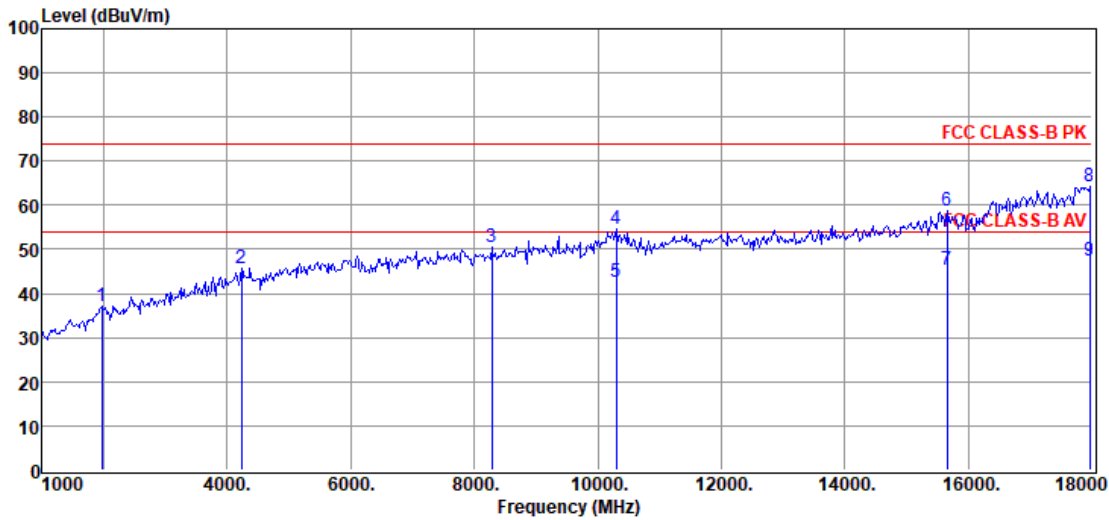

Item (Mark)	Freq. (MHz)	Read Level (dBuV)	Antenna Factor (dB/m)	PRM Factor (dB)	Cable Loss (dB)	Result Level (dBuV/m)	Limit Line (dBuV/m)	Over Limit (dB)	Detector	Polarization
1	1969.00	47.08	28.05	41.67	3.48	36.94	74.00	-37.06	Peak	HORIZONTAL
2	4230.00	50.63	33.42	43.50	5.22	45.77	74.00	-28.23	Peak	HORIZONTAL
3	8276.00	48.24	37.01	41.98	7.21	50.48	74.00	-23.52	Peak	HORIZONTAL
4	10299.00	48.96	40.00	42.51	8.07	54.52	74.00	-19.48	Peak	HORIZONTAL
5	10299.00	36.90	40.00	42.51	8.07	42.46	54.00	-11.54	Average	HORIZONTAL
6	15654.00	47.01	41.69	42.00	12.16	58.86	74.00	-15.14	Peak	HORIZONTAL
7	15654.00	33.60	41.69	42.00	12.16	45.45	54.00	-8.55	Average	HORIZONTAL
8	17966.00	41.69	45.33	39.02	16.34	64.34	74.00	-9.66	Peak	HORIZONTAL
9	17966.00	24.70	45.33	39.02	16.34	47.35	54.00	-6.65	Average	HORIZONTAL

- Note: 1. Result Level = Read Level + Antenna Factor + Cable loss - PRM Factor.
 2. If Peak Result complies with AV limit, AV Result is deemed to comply with AV limit.
 3. Test setup: RBW: 1 MHz, VBW: 3 MHz, Sweep time: auto.

4.6. Test photo

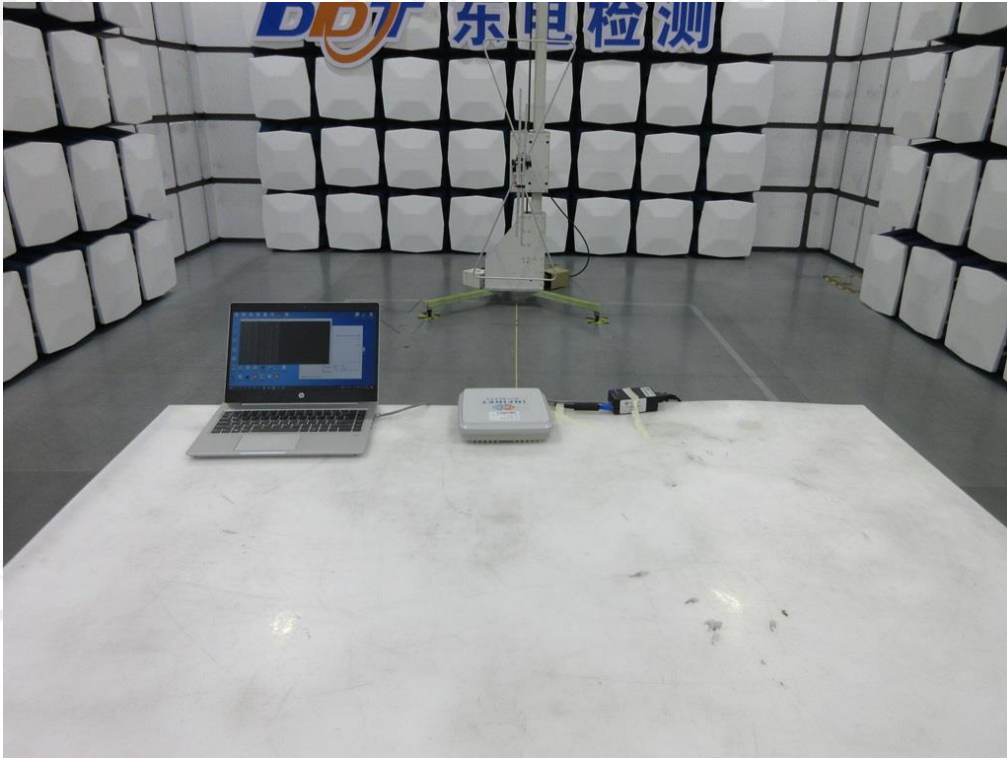

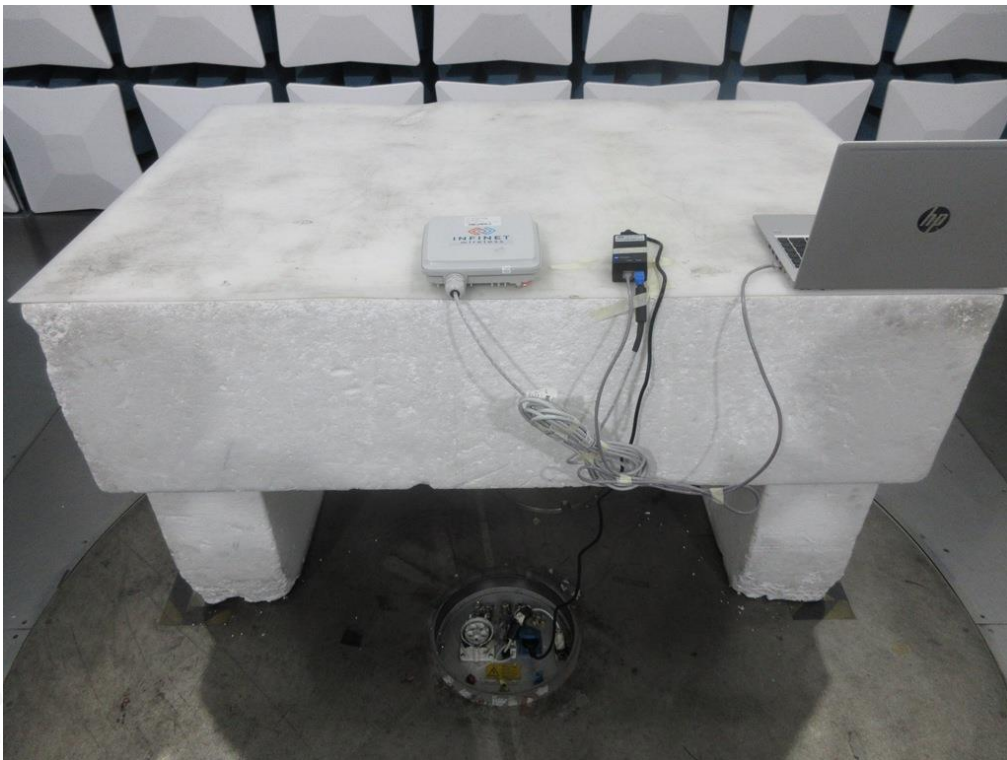
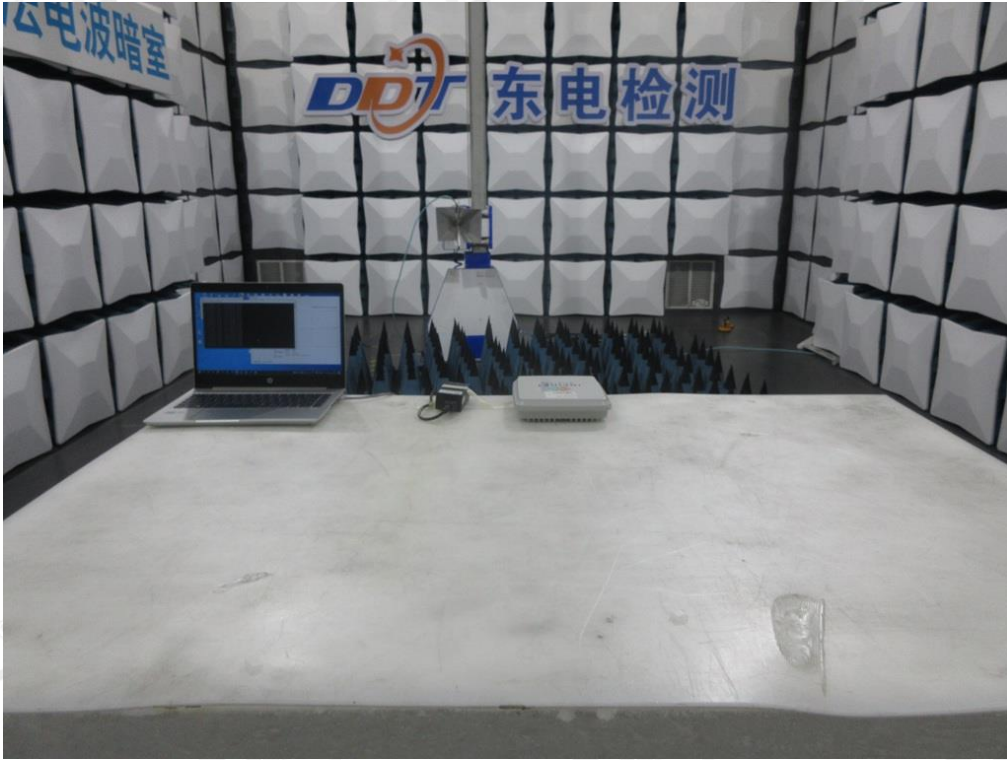

5. Photos of the EUT



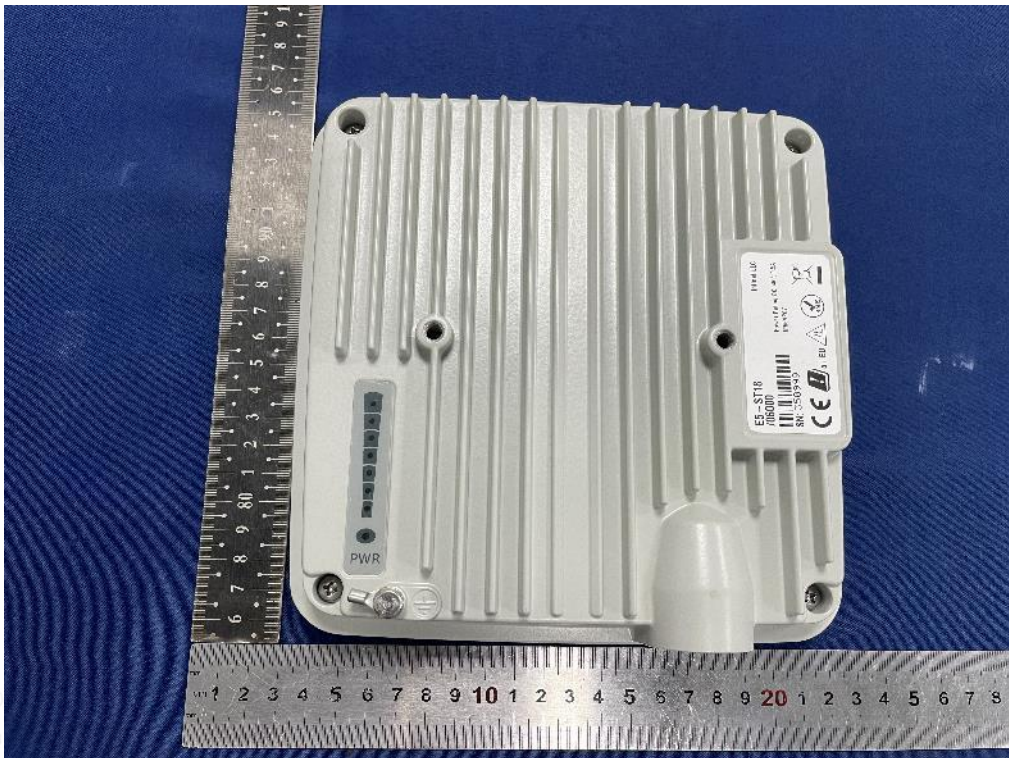
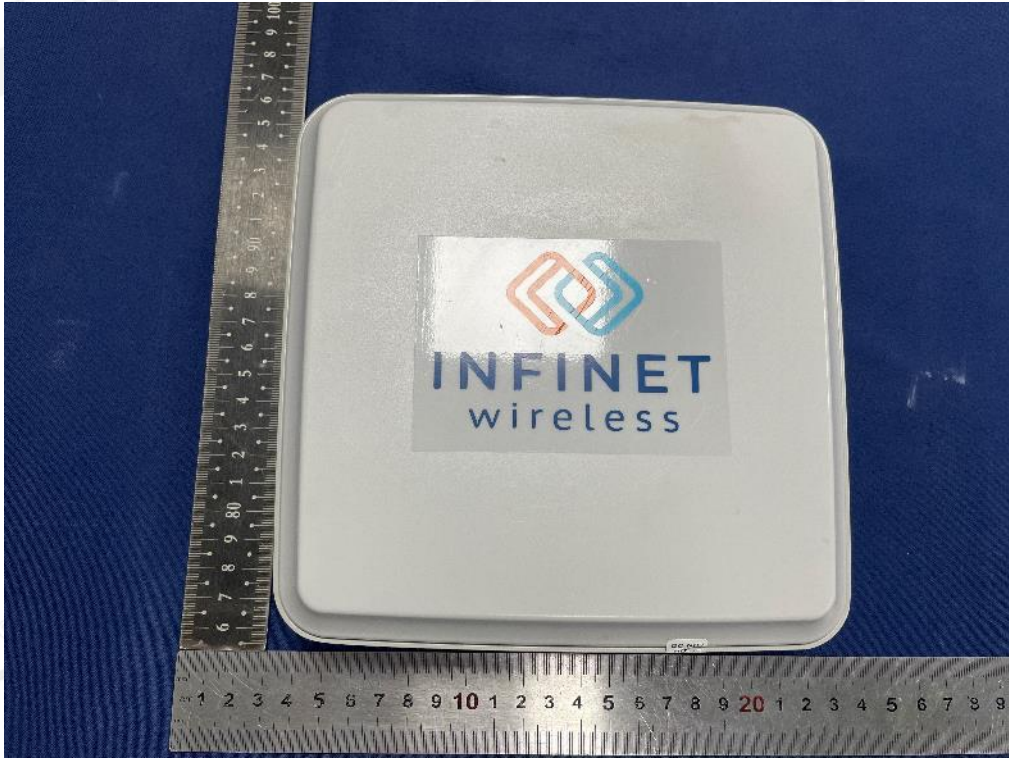

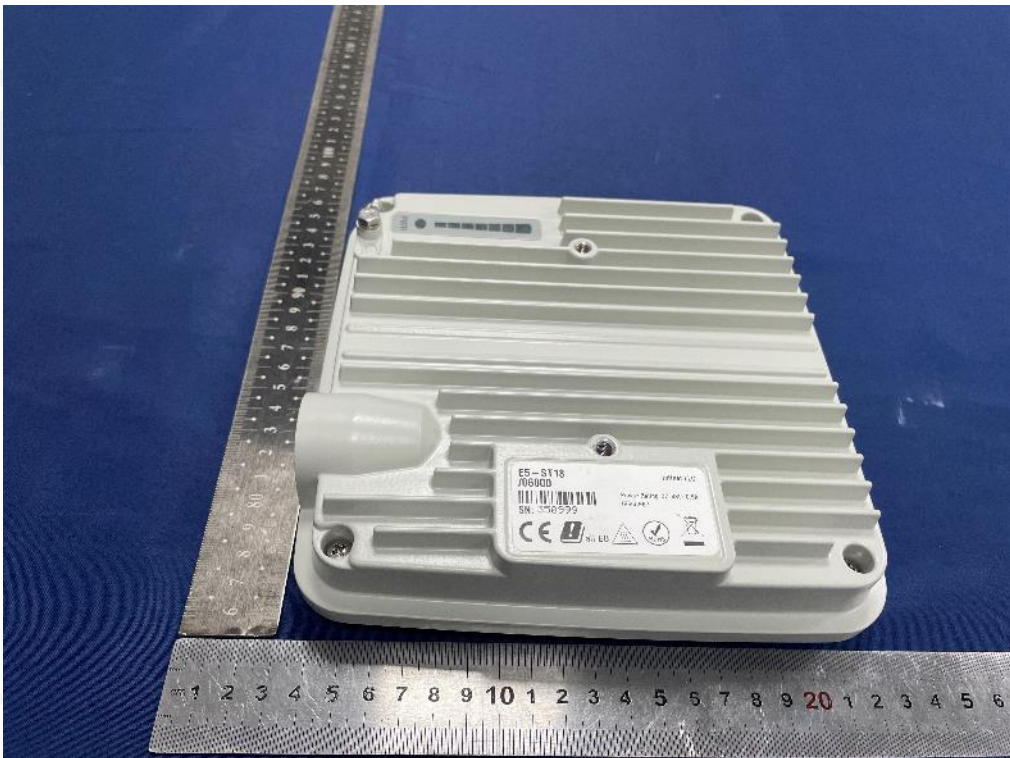

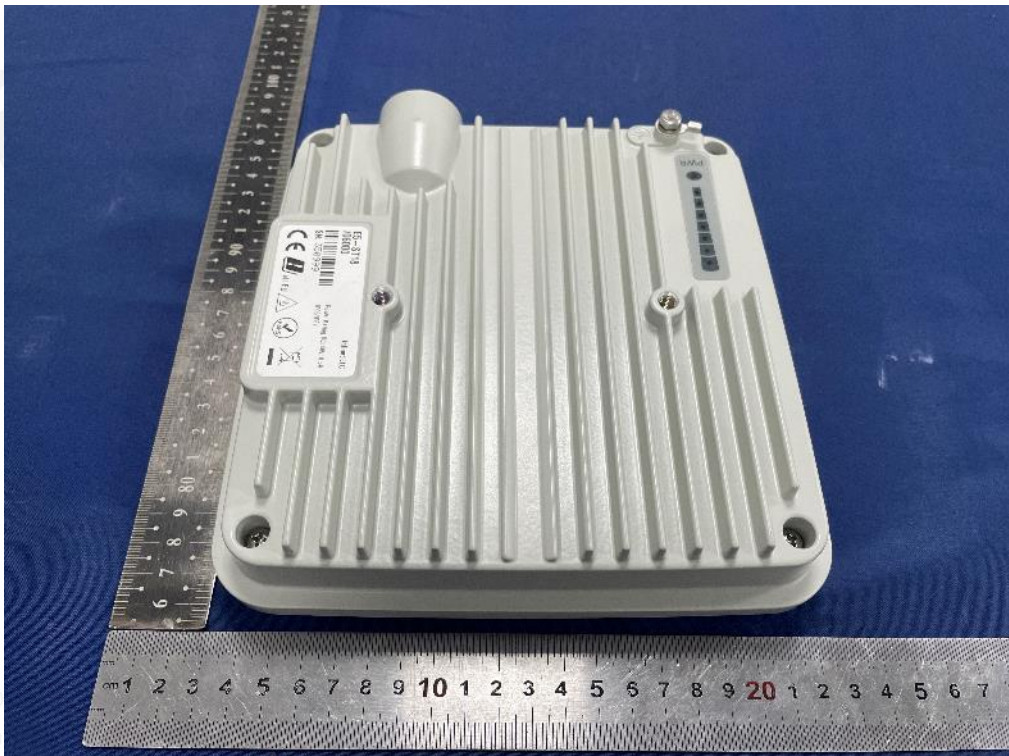
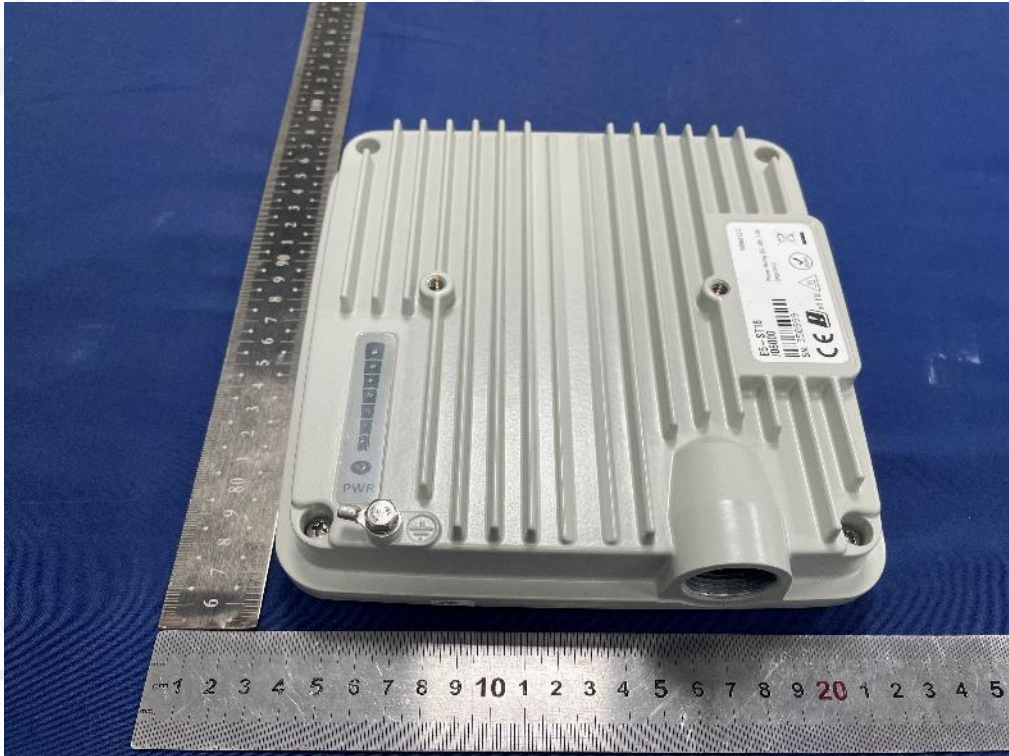



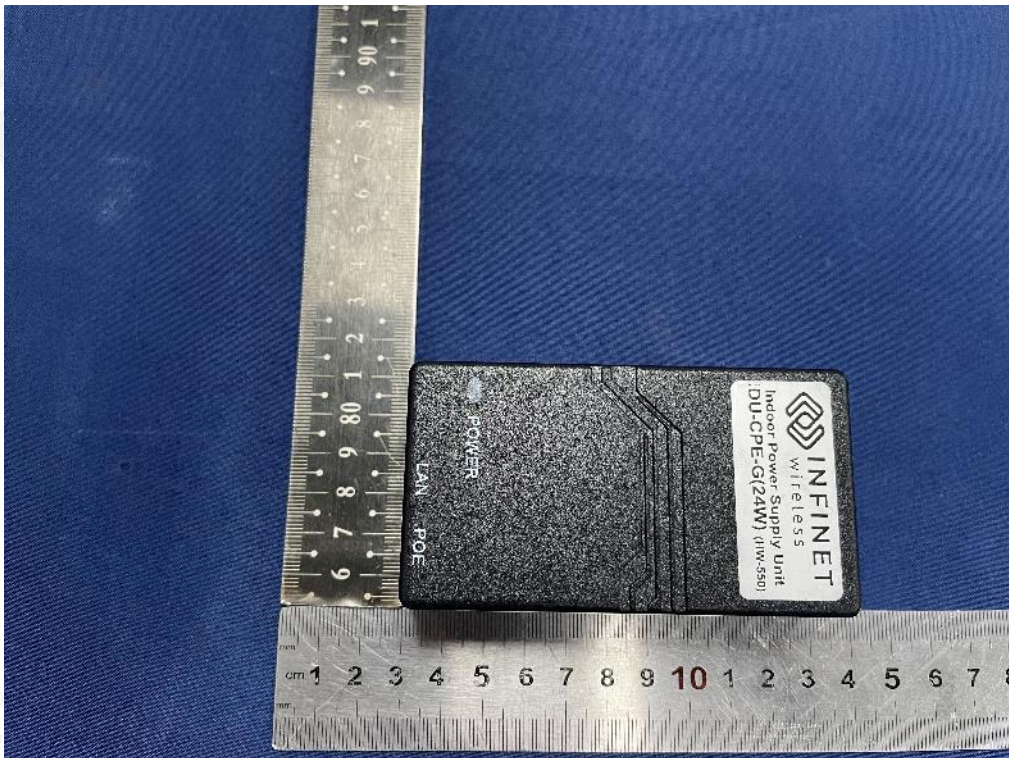

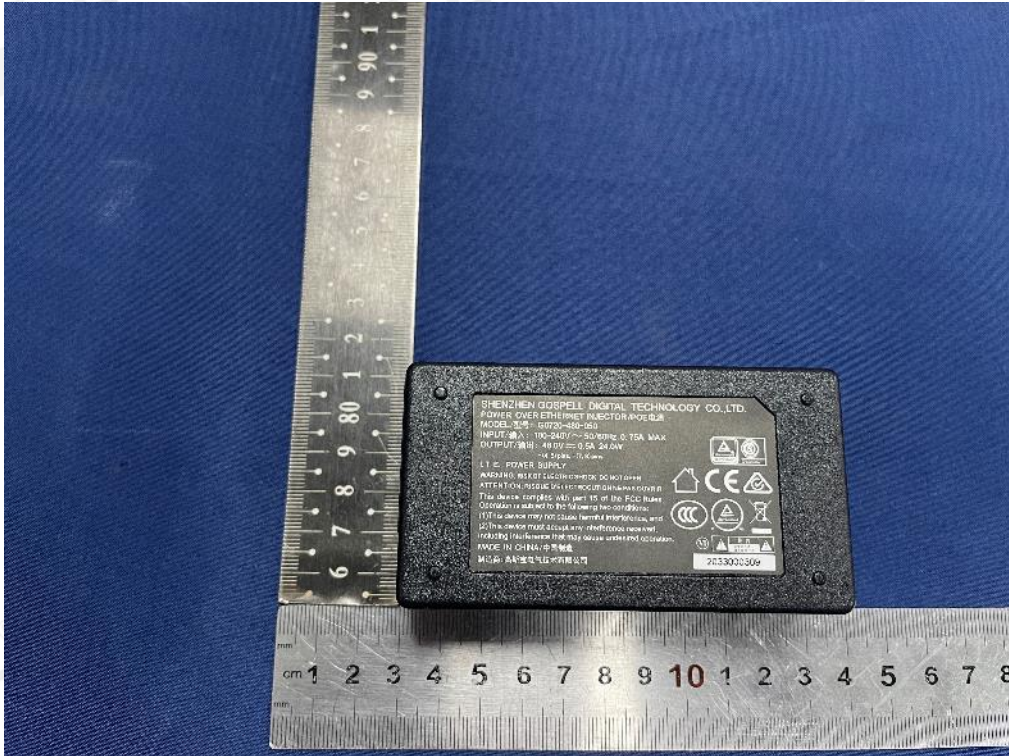

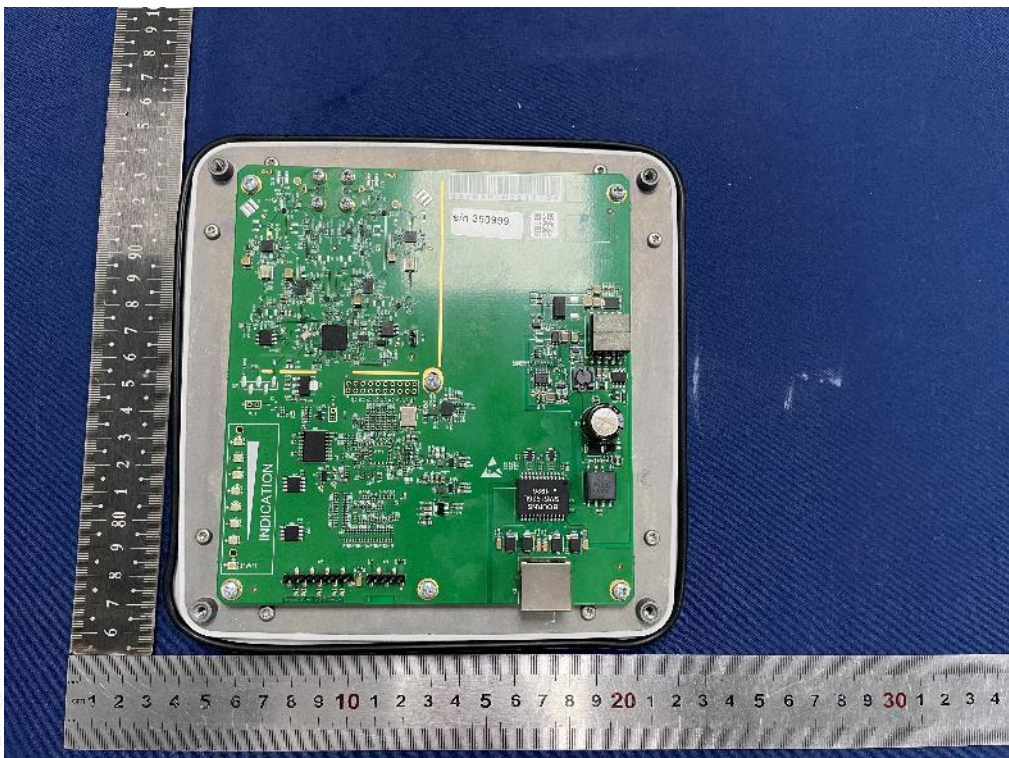
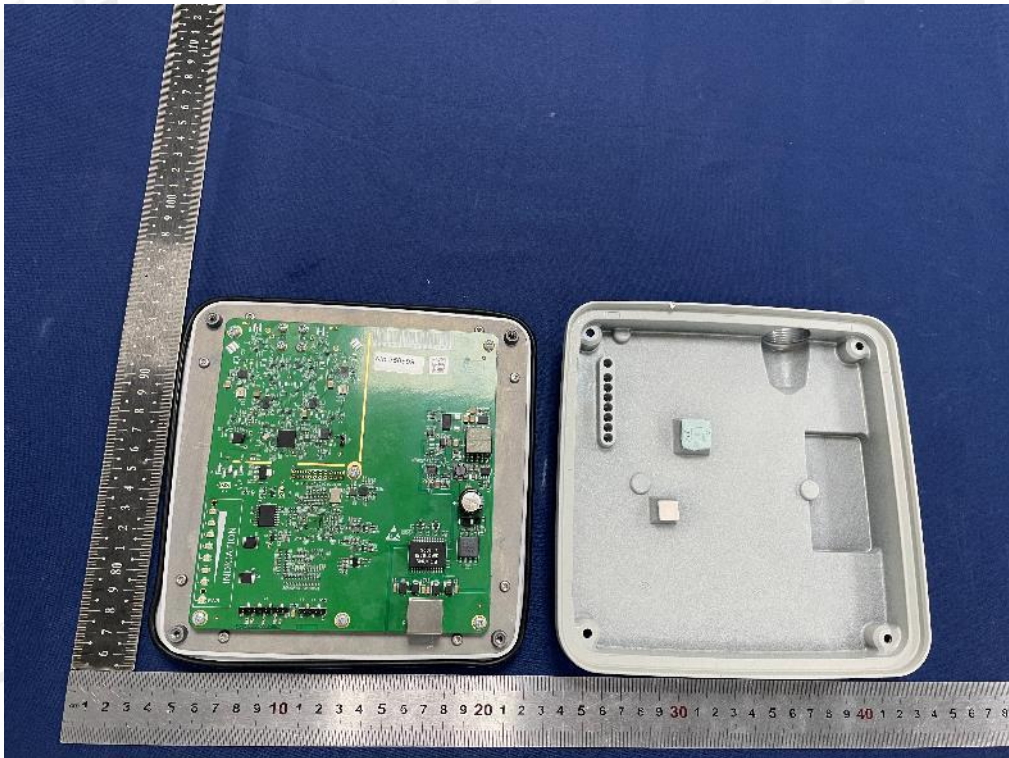

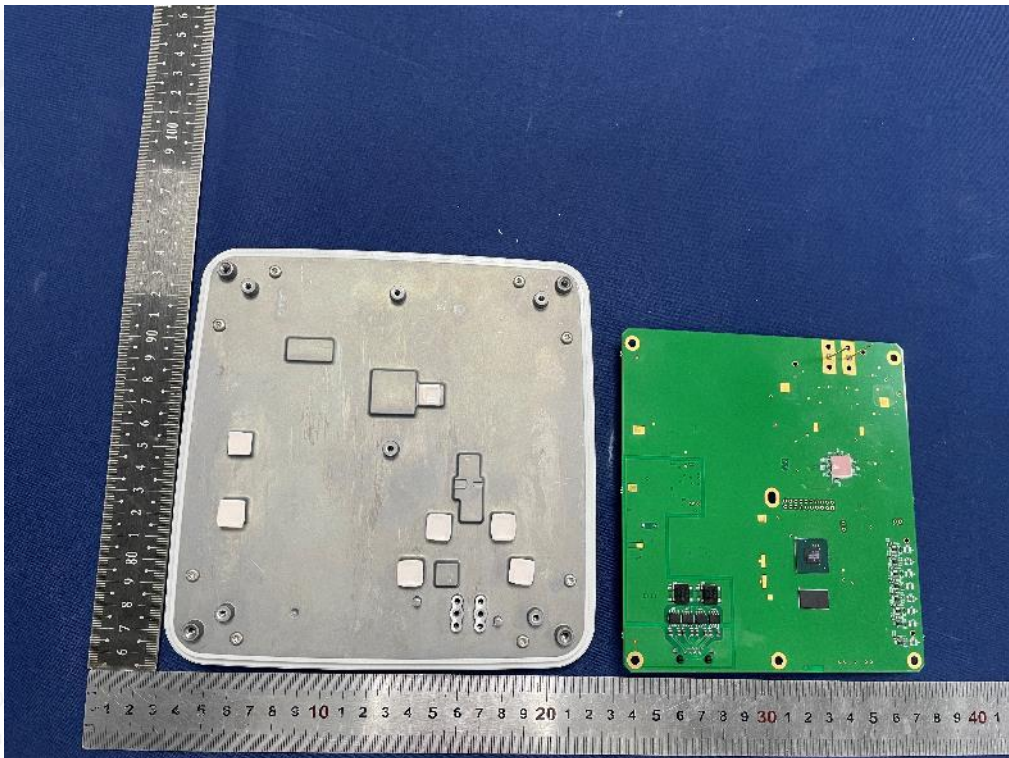
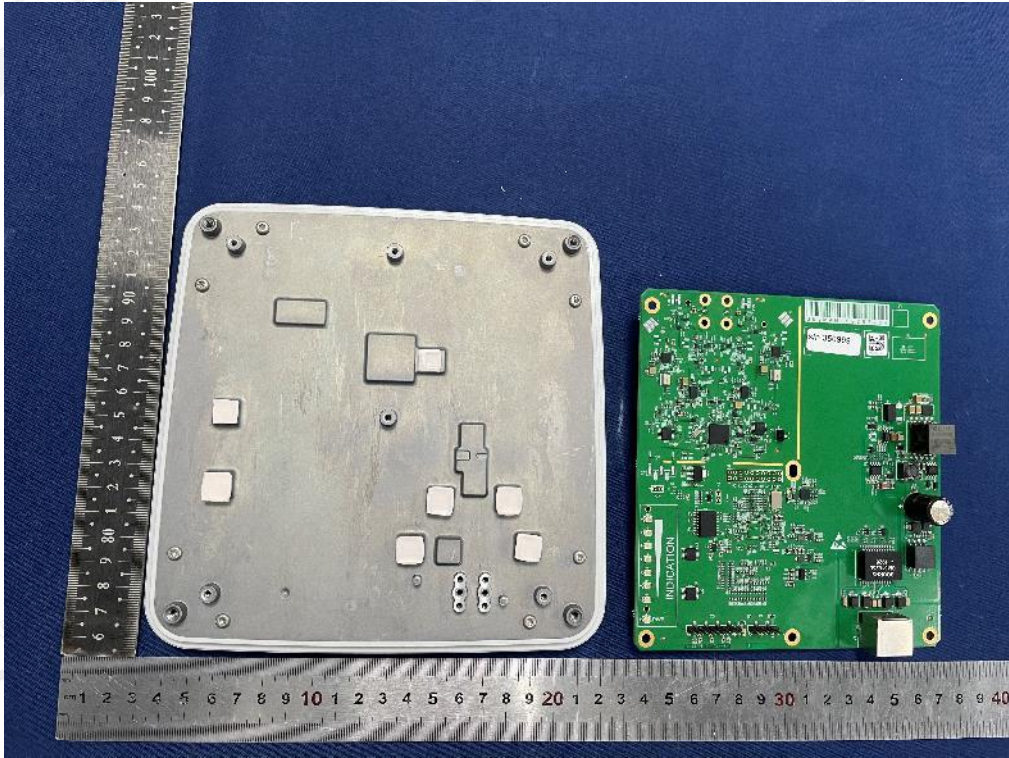

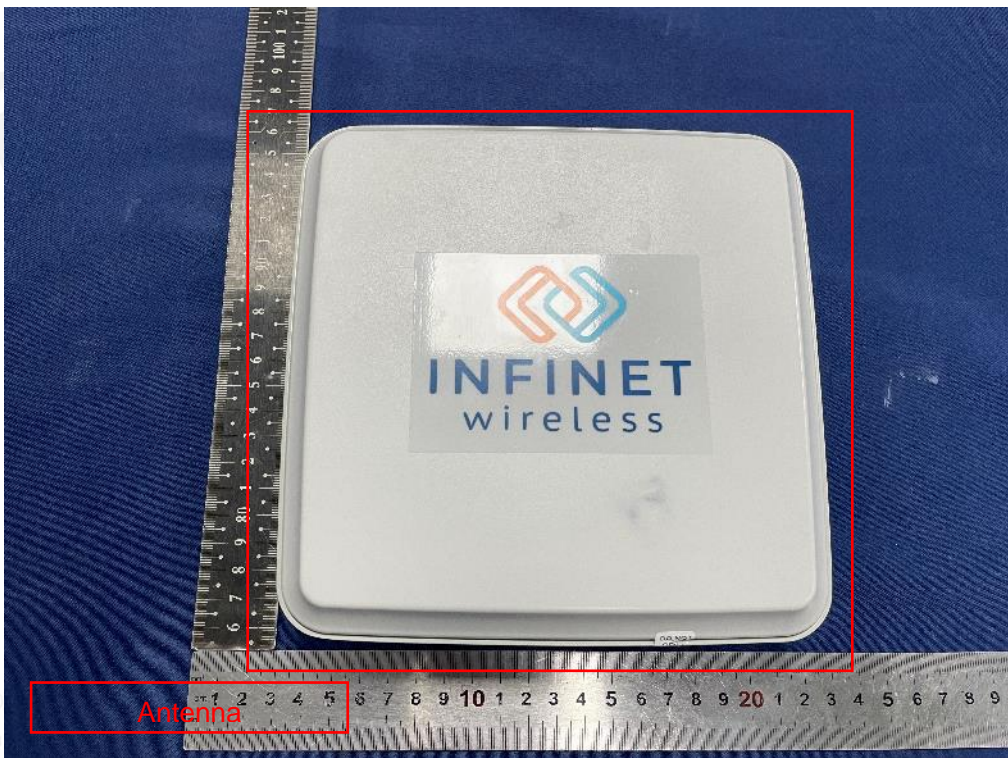
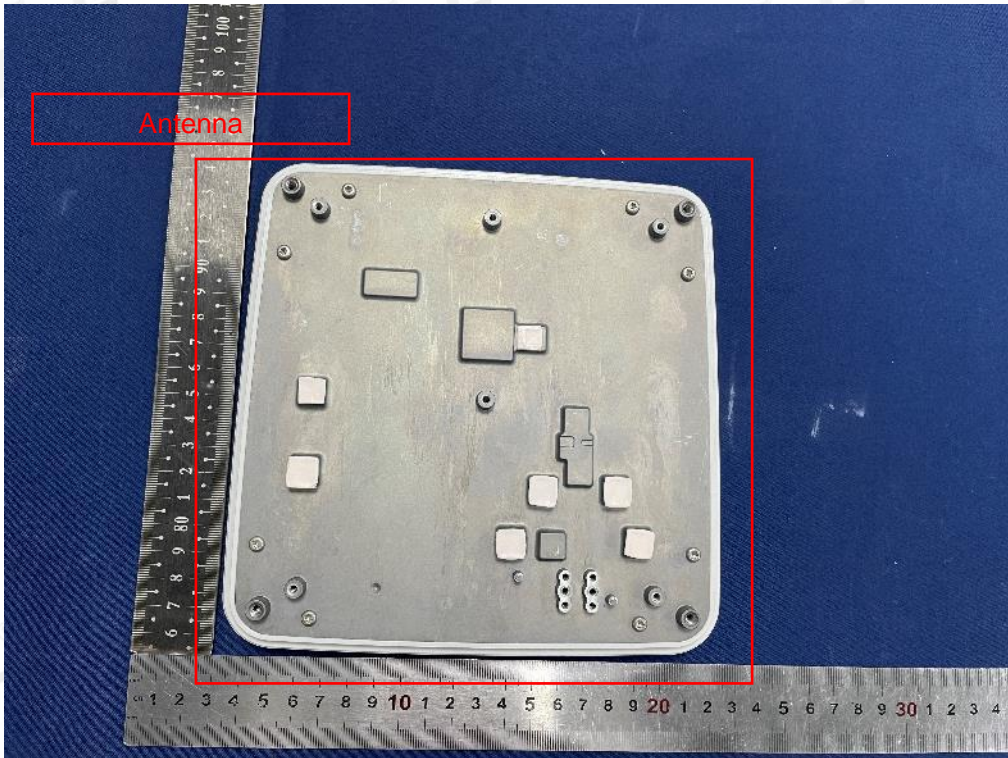

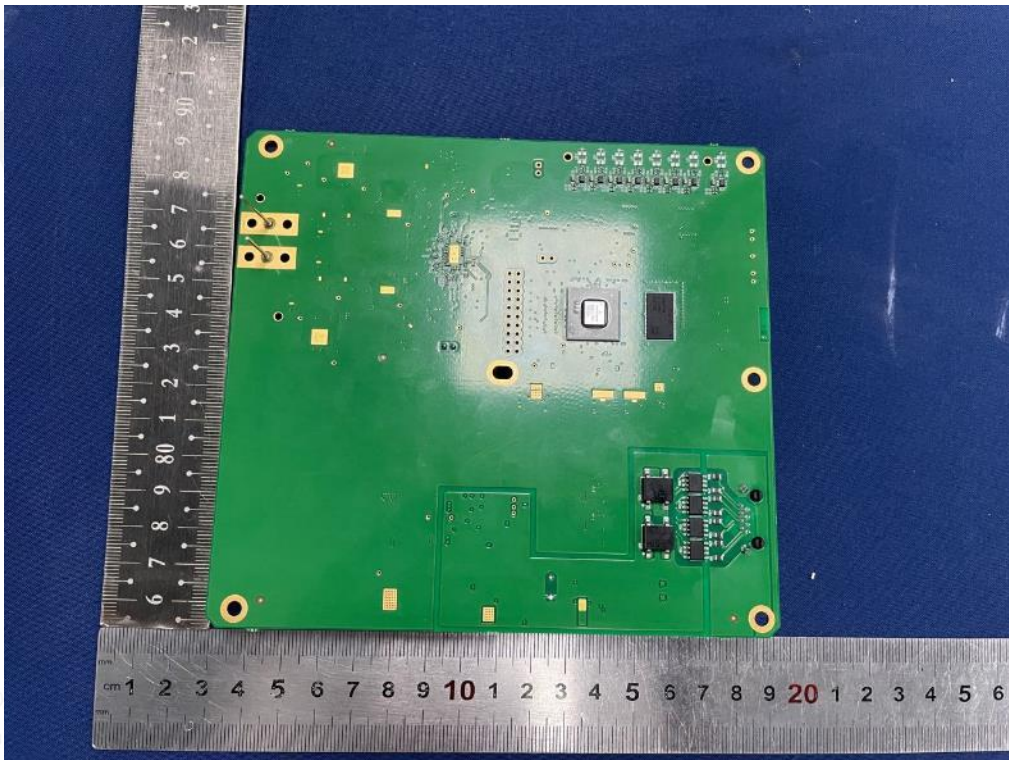
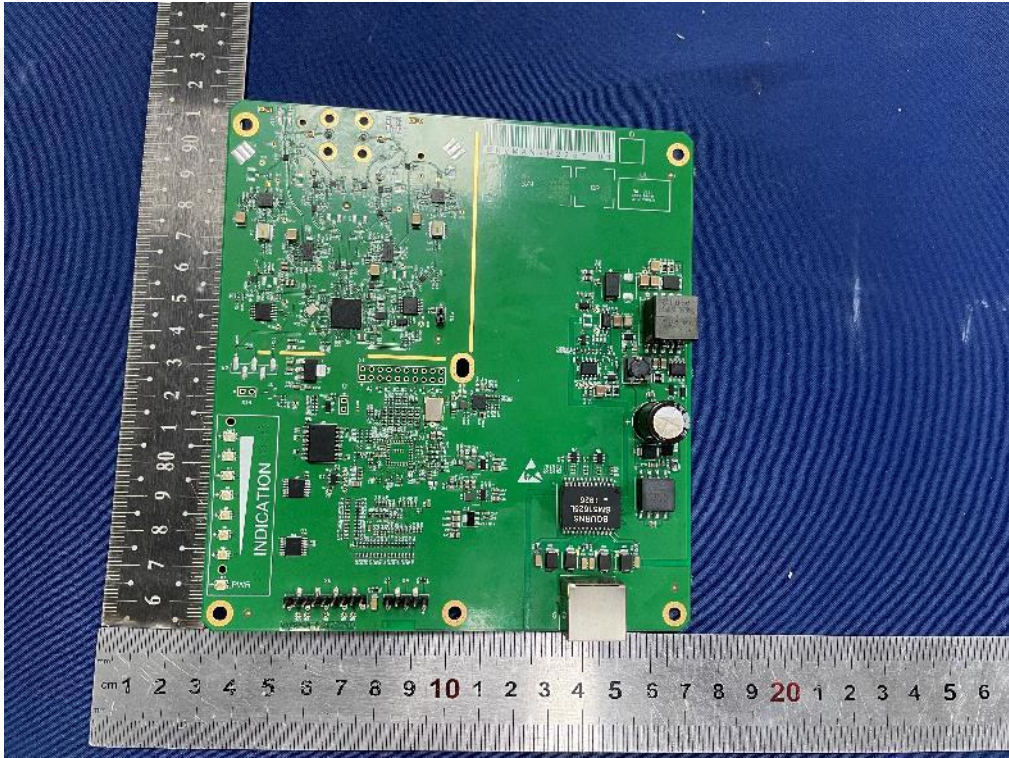

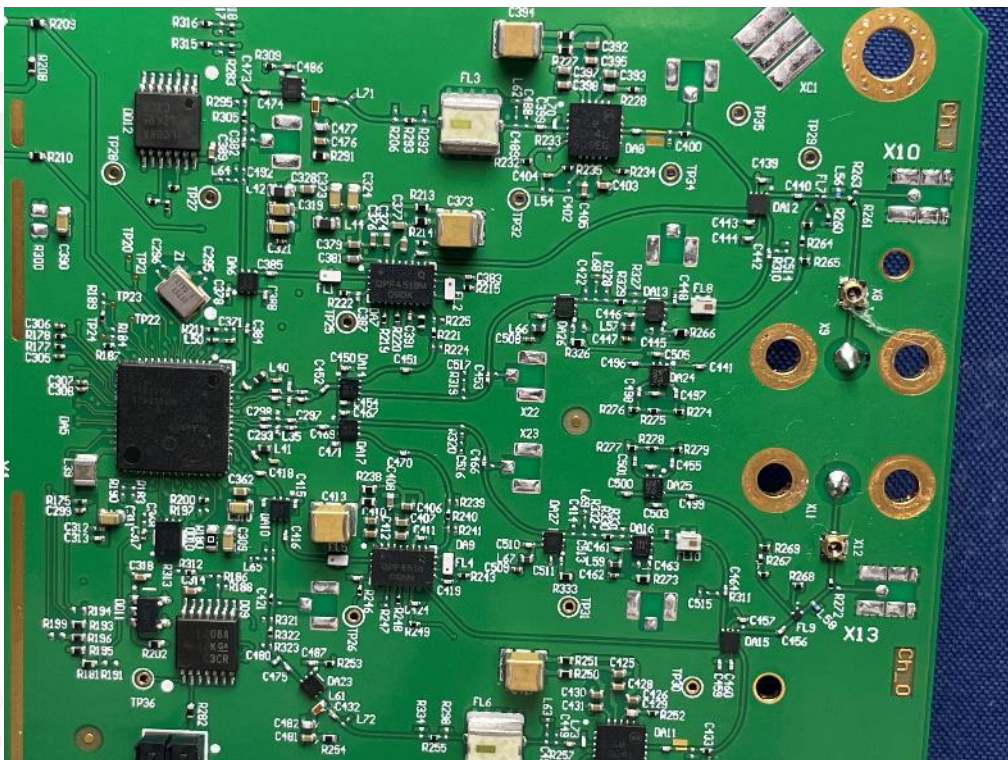
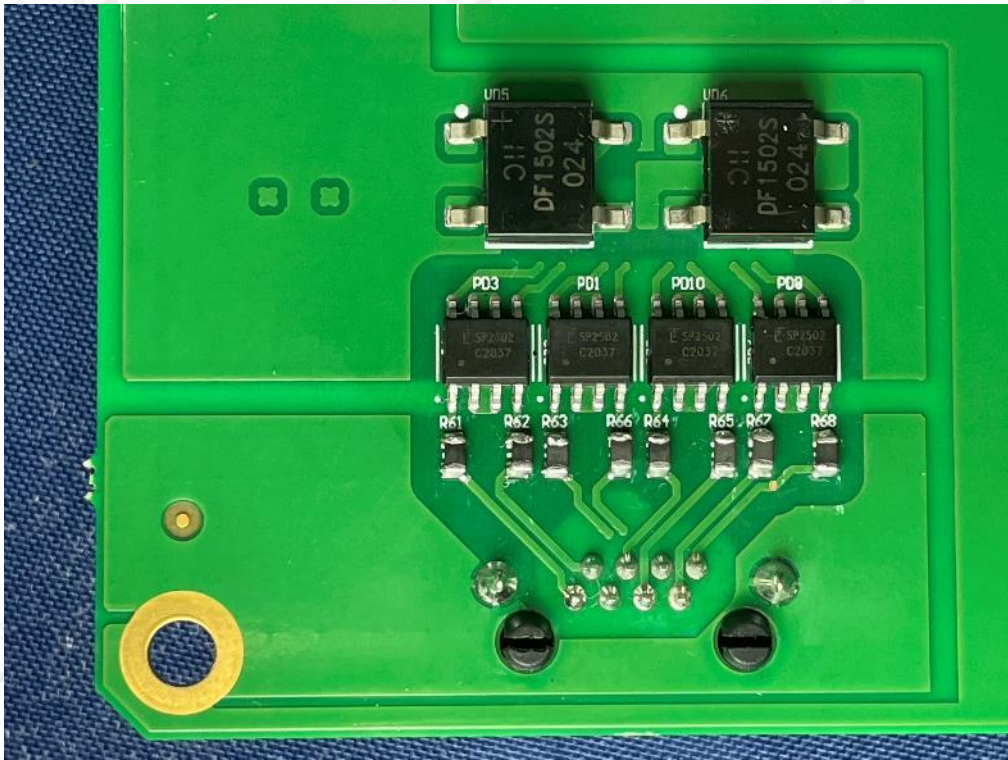

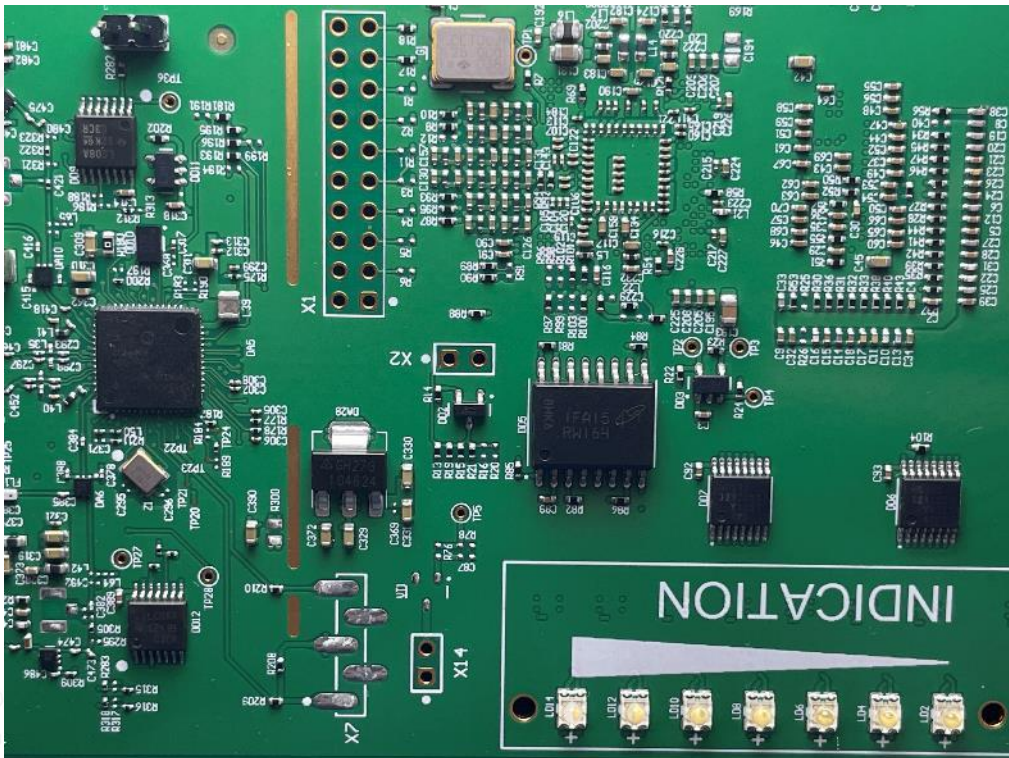
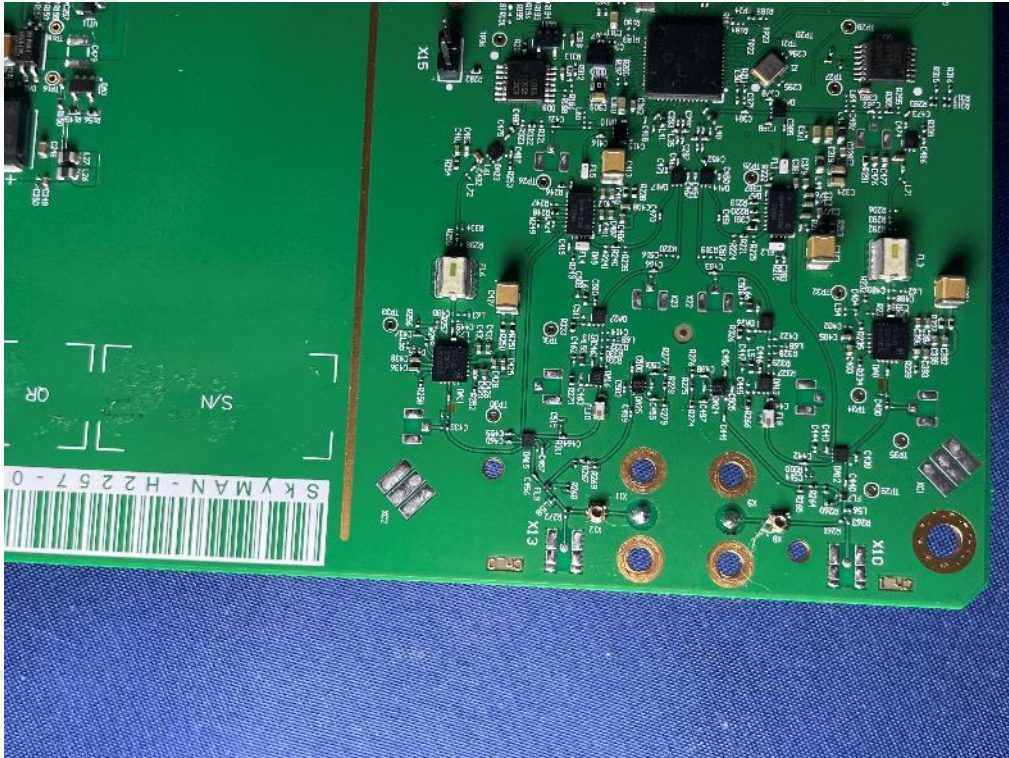

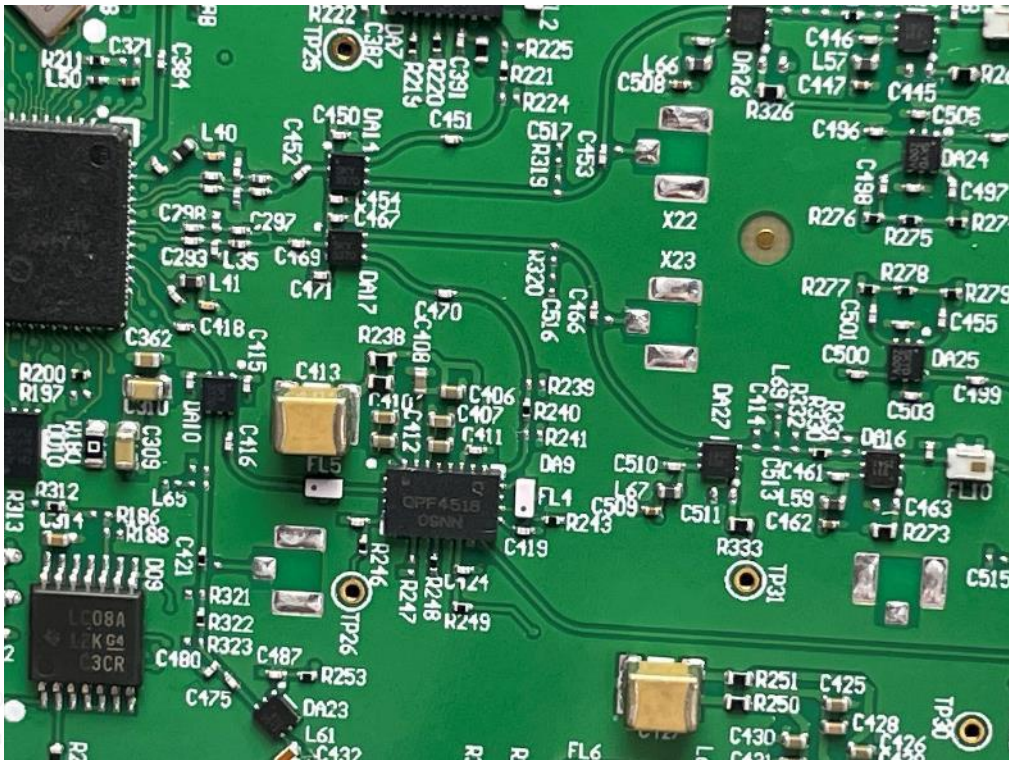
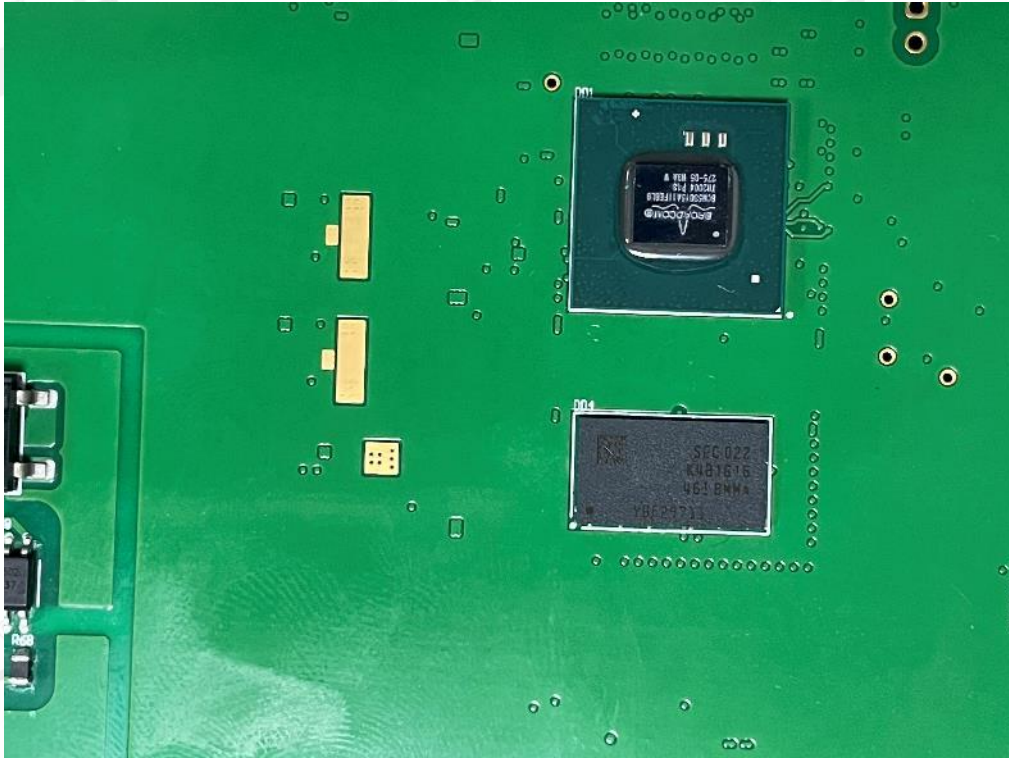

Appendix I

Regulatory Statement and Label Marking Advice for the FCC SDoC

1. Marking Suggested for the label:

Trade Name and model number

This device complies with Part 15 of the FCC Rules. Operation is subject to the following two conditions: (1) this device may not cause harmful interference, and (2) this device must accept any interference received, including interference that may cause undesired operation.

2. Statement suggested for the User Manual:

Warning: Changes or modifications to this unit not expressly approved by the party responsible for compliance could void the user authority to operate the equipment.

Notes: This equipment has been tested and found to comply with the limits for a Class B digital device, pursuant to Part 15 of the FCC Rules. These limits are designed to provide reasonable protection against harmful interference in a residential installation. This equipment generates, uses and can radiate radio frequency energy and, if not installed and used in accordance with the instructions, may cause harmful interference to radio communications.

However, there is no guarantee that interference will not occur in a particular installation. If this equipment does cause harmful interference to radio or television reception, which can be determined by turning the equipment off and on, the user is encouraged to try to correct the interference by one or more of the following measures:

- Reorient or relocate the receiving antenna.
- Increase the separation between the equipment and receiver.
- Connect the equipment into an outlet on a circuit different from that to which the receiver is connected.
- Consult the dealer or an experienced radio/TV technician for help.

Note: If shielded cables or special accessories are required for compliance, a statement must be included which instructs the user to employ them, for example, shielded cables must be used with this unit to ensure compliance with the Class B FCC limits.

Appendix II

Suggested text for the notice indicating compliance with this Standard:

CAN ICES-3 (B)/NMB-3 (B)

END OF REPORT