

器件规格书

coil specification

产品型号 Model	C962	制造商 manufacturer:	Apple inc
---------------	------	----------------------	-----------

一、尺寸 DIMENSION(MM)

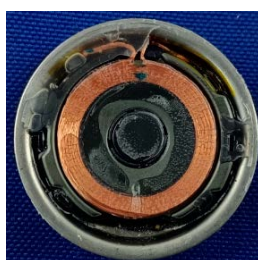
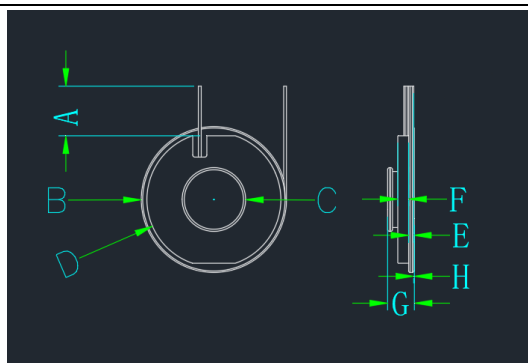

A	7.0±0.3
B	20.6±0.5
C	9±0.5
D	19±0.5
E	0.7±0.1
F	1.5±0.5
G	3.8±0.5
H	0.1±0.05

E	F	G	H
coil	WPC ferrite	magnet	PET gum

二、绕线参数 Winding Specification:

线材 Wire	圈数 Turns	绕线方向 Winding Direction
Size 0.4*0.7 MM	7 TS	anticlockwise

四、电气特性 ELECTRICAL CHARACTERISTICS:

温度 TEMPERATURE:25±10℃,湿度 RELATIVE HUMIDITY :65±20%

项目 TIEM	标准 SPECIFICATION	测试条件 TEST FREQUENCY	测试仪器 TEST EQUIPMENTS
IND	6.4UH±10%	100 KHZ/1.0V	LCZ METER 1062B
DCR	50mΩ Max		LCZ METER 1062B