

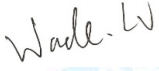

FCC Radio Test Report

FCC ID: 2AZI3-F55

Report No. : TB-FCC179579
Applicant : SHENZHEN KERUI SMART TECHNOLOGY CO., LTD
Equipment Under Test (EUT)
EUT Name : Wireless Doorbell Transmitter
Model No. : F55
Series Model No. : ----
Brand Name : ----
Sample ID : 20210322-23_2-01
Receipt Date : 2021-04-08
Test Date : 2021-04-08 to 2021-04-13
Issue Date : 2021-04-14
Standards : FCC Part 15, Subpart C (15.231(a))
Test Method : ANSI C63.10:2013
Conclusions : **PASS**

In the configuration tested, the EUT complied with the standards specified above,
The EUT technically complies with the FCC requirements

Test/Witness Engineer :  Wade Lv
Engineer Supervisor :  IVAN SU
Engineer Manager :  Ray Lai



This report details the results of the testing carried out on one sample. The results contained in this test report do not relate to other samples of the same product. The manufacturer should ensure that all products in series production are in conformity with the product sample detailed in the report.

Contents

CONTENTS	2
1. GENERAL INFORMATION ABOUT EUT	5
1.1 Client Information.....	5
1.2 General Description of EUT (Equipment Under Test)	5
1.3 Block Diagram Showing the Configuration of System Tested.....	6
1.4 Description of Support Units	6
1.5 Description of Test Mode.....	6
1.6 Description of Test Software Setting.....	7
1.7 Measurement Uncertainty.....	7
1.8 Test Facility	8
2. TEST SUMMARY	8
3. TEST SOFTWARE	8
4. TEST EQUIPMENT	9
5. CONDUCTED EMISSION TEST	10
5.1 Test Standard and Limit.....	10
5.2 Test Setup.....	10
5.3 Test Procedure.....	11
5.4 Deviation From Test Standard.....	11
5.5 Test Data.....	11
6. RADIATED EMISSION TEST	12
6.1 Test Standard and Limit.....	12
6.2 Test Setup.....	13
6.3 Test Procedure.....	15
6.4 Deviation From Test Standard.....	15
6.5 EUT Operating Condition	15
6.6 Test Data.....	15
7. BANDWIDTH	16
7.1 Test Standard and Limit.....	16
7.2 Test Setup.....	16
7.3 Test Procedure.....	16
7.4 Deviation From Test Standard.....	16
7.5 EUT Operating Condition	16
7.6 Test Data.....	16
8. RELEASE TIME MEASUREMENT	17
8.1 Test Standard and Limit.....	17
8.2 Test Setup.....	17
8.3 Test Procedure.....	17
8.4 Deviation From Test Standard.....	17
8.5 EUT Operating Condition	17
8.6 Test Data.....	17

9.	DUTY CYCLE	18
	9.1 Test Standard and Limit.....	18
	9.2 Test Setup.....	18
	9.3 Test Procedure.....	18
	9.4 Deviation From Test Standard.....	18
	9.5 EUT Operating Condition	18
	9.6 Test Data.....	18
10.	ANTENNA REQUIREMENT	19
	10.1 Standard Requirement.....	19
	10.1 Deviation From Test Standard.....	19
	10.2 Antenna Connected Construction.....	19
	ATTACHMENT A-- RADIATED EMISSION TEST DATA	20
	ATTACHMENT B--BANDWIDTH DATA	25
	ATTACHMENT C-- RELEASE TIME MEASUREMENT DATA	26
	ATTACHMENT D--DUTY CYCLE DATA	27

1. General Information about EUT

1.1 Client Information

Applicant	:	SHENZHEN KERUI SMART TECHNOLOGY CO., LTD
Address	:	Room 1501, T2, Jinlitong Building, No. 1100, Xingye Road, Xin'an Street, Bao'an District, Shenzhen, Guangdong, China
Manufacturer	:	SHENZHEN KERUI SMART TECHNOLOGY CO., LTD
Address	:	Room 1501, T2, Jinlitong Building, No. 1100, Xingye Road, Xin'an Street, Bao'an District, Shenzhen, Guangdong, China

1.2 General Description of EUT (Equipment Under Test)

EUT Name	:	Wireless Doorbell Transmitter	
Models No.	:	F55	
Model Difference	:	----	
Product Description	:	Operation Frequency:	433.92 MHz
	:	Output Power:	72.53 dBuV/m (PK Max.) 61.33 dBuV/m (AV Max.)
	:	Antenna Gain:	Internal Antenna (-3.0 dBi)
	:	Modulation Type:	OOK
Power Rating	:	DC 3.0V by button Battery (CR2032).	
Software Version	:	N/A	
Hardware Version	:	KR-F55-CE-A	
Remark	:	The antenna gain provided by the applicant, the verified for the RF conduction test provided by TOBY test lab.	

Note:

- (1) For a more detailed features description, please refer to the manufacturer's specifications or the User's Manual.
- (2) Antenna description

Brand	Model Name	Type	Antenna Gain(dBi)
N/A	N/A	Internal Ant.	-3.0

1.3 Block Diagram Showing the Configuration of System Tested

TX Mode

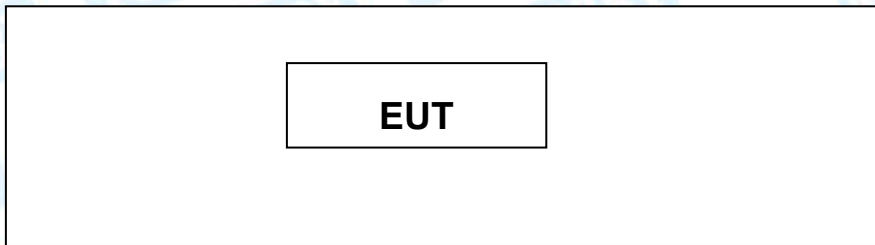

1.4 Description of Support Units

The EUT has been test as an independent unit.

1.5 Description of Test Mode

To investigate the maximum EMI emission characteristics generates from EUT, the test system was pre-scanning tested base on the consideration of following EUT operation mode or test configuration mode which possible have effect on EMI emission level. Each of these EUT operation mode(s) or test configuration mode(s) mentioned follow was evaluated respectively.

Test Items	Note
Conducted Emission	N/A
Radiated Emission	Continuously transmitting
Bandwidth	Continuously transmitting
Duty Cycle	Continuously transmitting
Release Time	Normal Mode

Note:

- (1) During the testing procedure, the continuously transmitting mode was programmed by the customer.
- (2) The EUT is considered a Mobile unit, and it was pre-tested on the positioned of each 3 axis: X axis, Y axis and Z axis. The worst case was found positioned on Z-plane. There for only the test data of this Z-plane were used for radiated emission measurement test.

1.6 Description of Test Software Setting

During testing channel & Power controlling software provided by the customer was used to control the operating channel as well as the output power level. The RF output power selection is for the setting of RF output power expected by the customer and is going to be fixed on the firmware of the final end product power parameters of transmitting mode.

RF Power Setting in Test SW:	DEF
-------------------------------------	-----

1.7 Measurement Uncertainty

The reported uncertainty of measurement $y \pm U$, where expanded uncertainty U is based on a standard uncertainty multiplied by a coverage factor of $k=2$, providing a level of confidence of approximately 95 %.

Test Item	Parameters	Expanded Uncertainty (U_{Lab})
Conducted Emission	Level Accuracy: 9kHz~150kHz 150kHz to 30MHz	± 3.50 dB ± 3.10 dB
Radiated Emission	Level Accuracy: 9kHz to 30 MHz	± 4.60 dB
Radiated Emission	Level Accuracy: 30MHz to 1000 MHz	± 4.20 dB
Radiated Emission	Level Accuracy: Above 1000MHz	± 4.20 dB

1.8 Test Facility

The testing was performed by the Shenzhen Toby Technology Co., Ltd., in their facilities located at: 1/F., Building 6, Rundongsheng Industrial Zone, Longzhu, Xixiang, Bao'an District, Shenzhen, Guangdong, China. At the time of testing, the following bodies accredited the Laboratory:

CNAS (L5813)

The Laboratory has been accredited by CNAS to ISO/IEC 17025: 2017 General Requirements for the Competence of Testing and Calibration Laboratories for the competence in the field of testing. And the Registration No.: CNAS L5813.

A2LA Certificate No.: 4750.01

The laboratory has been accredited by American Association for Laboratory Accreditation(A2LA) to ISO/IEC 17025: 2017 General Requirements for the Competence of Testing and Calibration Laboratories for the technical competence in the field of Electrical Testing. And the A2LA Certificate No.: 4750.01.FCC Accredited Test Site Number: 854351.

IC Registration No.: (11950A)

The Laboratory has been registered by Certification and Engineering Bureau of Industry Canada for radio equipment testing. The site registration: Site# 11950A.

2. Test Summary

FCC Part 15 Subpart (15.231(a))			
Standard Section	Test Item	Judgment	Remark
FCC			
15.203	Antenna Requirement	PASS	N/A
15.207	Conducted Emission	N/A	N/A
15.231	Release Time	PASS	N/A
	Radiation Emission	PASS	N/A
	20 dB Bandwidth	PASS	N/A
	Duty Cycle	PASS	N/A

Note: N/A is an abbreviation for Not Applicable.

3. Test Software

Test Item	Test Software	Manufacturer	Version No.
Conducted Emission	EZ-EMC	EZ	CDI-03A2
Radiation Emission	EZ-EMC	EZ	FA-03A2RE

4. Test Equipment

Conducted Emission Test					
Equipment	Manufacturer	Model No.	Serial No.	Last Cal.	Cal. Due Date
EMI Test Receiver	Rohde & Schwarz	ESCI	100321	Jul. 06, 2020	Jul. 05, 2021
RF Switching Unit	Compliance Direction Systems Inc	RSU-A4	34403	Jul. 06, 2020	Jul. 05, 2021
AMN	SCHWARZBECK	NNBL 8226-2	8226-2/164	Jul. 06, 2020	Jul. 05, 2021
LISN	Rohde & Schwarz	ENV216	101131	Jul. 06, 2020	Jul. 05, 2021
Radiation Emission Test					
Equipment	Manufacturer	Model No.	Serial No.	Last Cal.	Cal. Due Date
Spectrum Analyzer	Agilent	E4407B	MY45106456	Jul. 06, 2020	Jul. 05, 2021
EMI Test Receiver	Rohde & Schwarz	ESPI	100010/007	Jul. 06, 2020	Jul. 05, 2021
Bilog Antenna	ETS-LINDGREN	3142E	00117537	Mar.01, 2020	Feb. 28, 2022
Horn Antenna	ETS-LINDGREN	3117	00143207	Mar.01, 2020	Feb. 28, 2022
Loop Antenna	SCHWARZBECK	FMZB 1519 B	1519B-059	Jul. 07, 2020	Jul. 06, 2021
Pre-amplifier	Sonoma	310N	185903	Feb. 25, 2021	Feb. 24, 2022
Pre-amplifier	HP	8449B	3008A00849	Feb. 25, 2021	Feb. 24, 2022
Cable	HUBER+SUHNER	100	SUCOFLEX	Feb. 25, 2021	Feb. 24, 2022
Positioning Controller	ETS-LINDGREN	2090	N/A	N/A	N/A
Antenna Conducted Emission					
Equipment	Manufacturer	Model No.	Serial No.	Last Cal.	Cal. Due Date
Spectrum Analyzer	Agilent	E4407B	MY45106456	Jul. 06, 2020	Jul. 05, 2021
Spectrum Analyzer	Rohde & Schwarz	ESPI	100010/007	Jul. 06, 2020	Jul. 05, 2021
MXA Signal Analyzer	Agilent	N9020A	MY49100060	Sep. 11, 2020	Sep. 10, 2021
Vector Signal Generator	Agilent	N5182A	MY50141294	Sep. 11, 2020	Sep. 10, 2021
Analog Signal Generator	Agilent	N5181A	MY50141953	Sep. 11, 2020	Sep. 10, 2021
RF Power Sensor	DARE!! Instruments	RadiPowerRPR3006W	17100015SNO26	Sep. 11, 2020	Sep. 10, 2021
	DARE!! Instruments	RadiPowerRPR3006W	17100015SNO29	Sep. 11, 2020	Sep. 10, 2021
	DARE!! Instruments	RadiPowerRPR3006W	17100015SNO31	Sep. 11, 2020	Sep. 10, 2021
	DARE!! Instruments	RadiPowerRPR3006W	17100015SNO33	Sep. 11, 2020	Sep. 10, 2021

5. Conducted Emission Test

5.1 Test Standard and Limit

5.1.1 Test Standard
FCC 15.207

5.1.2 Test Limit

Conducted Emission Test Limit

Frequency	Maximum RF Line Voltage (dB μ V)	
	Quasi-peak Level	Average Level
150kHz~500kHz	66 ~ 56 *	56 ~ 46 *
500kHz~5MHz	56	46
5MHz~30MHz	60	50

Notes:

- (1) *Decreasing linearly with logarithm of the frequency.
- (2) The lower limit shall apply at the transition frequencies.
- (3) The limit decrease in line with the logarithm of the frequency in the range of 0.15 to 0.50MHz.

5.2 Test Setup

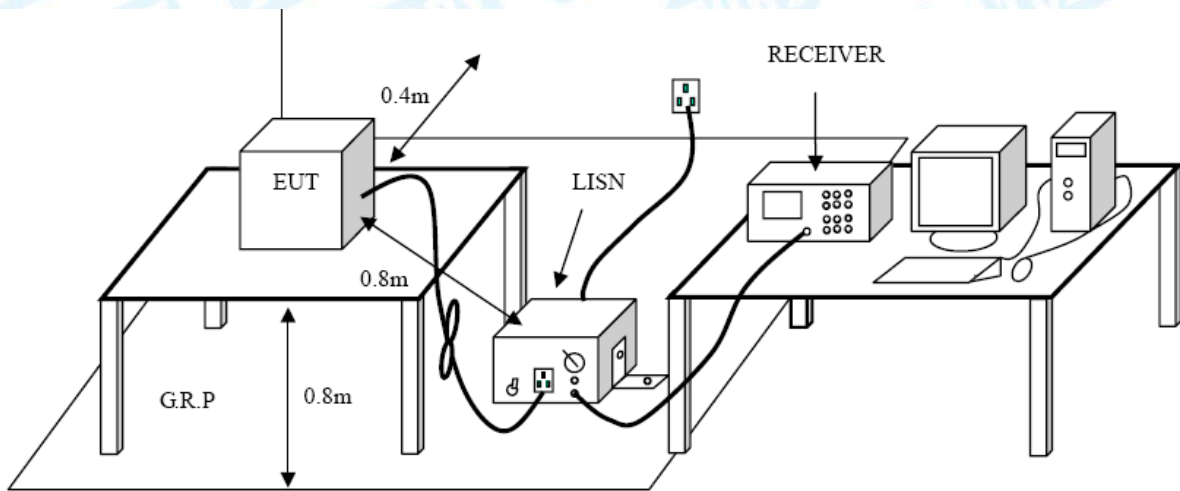

5.3 Test Procedure

The EUT was placed 0.8 meters from the horizontal ground plane with EUT being connected to the power mains through a line impedance stabilization network (LISN). All other support equipments powered from additional LISN(s). The LISN provide 50 Ohm/50uH of coupling impedance for the measuring instrument.

The EUT must be tested for all available U.S. voltages and frequencies (such as a nominal 120 VAC, 50/60 Hz and 240 VAC, 50/60 Hz) for which the device is capable of operation.

Interconnecting cables that hang closer than 40 cm to the ground plane shall be folded back and forth in the center forming a bundle 30 to 40 cm long.

I/O cables that are not connected to a peripheral shall be bundled in the center. The end of the cable may be terminated, if required, using the correct terminating impedance. The overall length shall not exceed 1 m.

LISN at least 80 cm from nearest part of EUT chassis.

The bandwidth of EMI test receiver is set at 9kHz, and the test frequency band is from 0.15MHz to 30MHz.

5.4 Deviation From Test Standard

No deviation

5.5 Test Data

The EUT is powered by DC battery, no requirement for this test item.

6. Radiated Emission Test

6.1 Test Standard and Limit

6.1.1 Test Standard

FCC 15.231

6.1.2 Test Limit

According to FCC 15.231(a) requirement:

In addition to the provisions of Section 15.205, the field strength of emissions from intentional radiators operated under this Section shall not exceed the following:

Fundamental Frequency (MHz)	Field Strength of Fundamental (microvolt/meter) at 3m	Field Strength of Spurious Emissions (microvolt/meter) at 3m
40.66~40.70	2250	225
70~130	1250	125
130~174	1250 to 3750(**)	125 to 375(**)
174~260	3750	375
260~470	3750 to 12500(**)	375 to 1250(**)
Above 470	12500	1250

** Linear interpolations, the formulas for calculating the maximum permitted fundamental field strengths are as follows:

- (1) for the band 130~174 MHz, $\mu\text{V/m}$ at 3 meters = $56.81818(F) - 6136.3636$;
- (2) for the band 260~470 MHz, $\mu\text{V/m}$ at 3 meter = $41.6667(F) - 7083.3333$.
- (3) The maximum permitted unwanted emissions level is 20 dB below the maximum permitted fundamental level. In addition field strength of any emissions which appear inside of the restriction band shall not exceed the general radiated emissions limits in FCC Part 15.209.

Frequency (MHz)	Field Strength (microvolt/meter)	Measurement Distance (meters)
0.009~0.490	$2400/F(\text{KHz})$	300
0.490~1.705	$24000/F(\text{KHz})$	30
1.705~30.0	30	30
30~88	100	3
88~216	150	3
216~960	200	3
Above 960	500	3

Note:

(1) The tighter limit applies at the band edges.

(2) For above 30MHz:

$$\text{Emission Level(dBuV/m)} = 20 \log \text{Emission Level(uV/m)}$$

For 0.009~0.490MHz:

$$\text{Emission Level(dBuV/m)} = 20 \log \text{Emission Level(uV/m)} + 40 \log(300/3)$$

For 0.049~30MHz:

$$\text{Emission Level(dBuV/m)} = 20 \log \text{Emission Level(uV/m)} + 40 \log(30/3)$$

So the field strength of emission limits have been calculated in below table.

Fundamental Frequency (MHz)	Field Strength of Fundamental (microvolt/meter) at 3m
433.92 MHz	80.82 (Average)
433.92 MHz	100.82 (Peak)

6.2 Test Setup

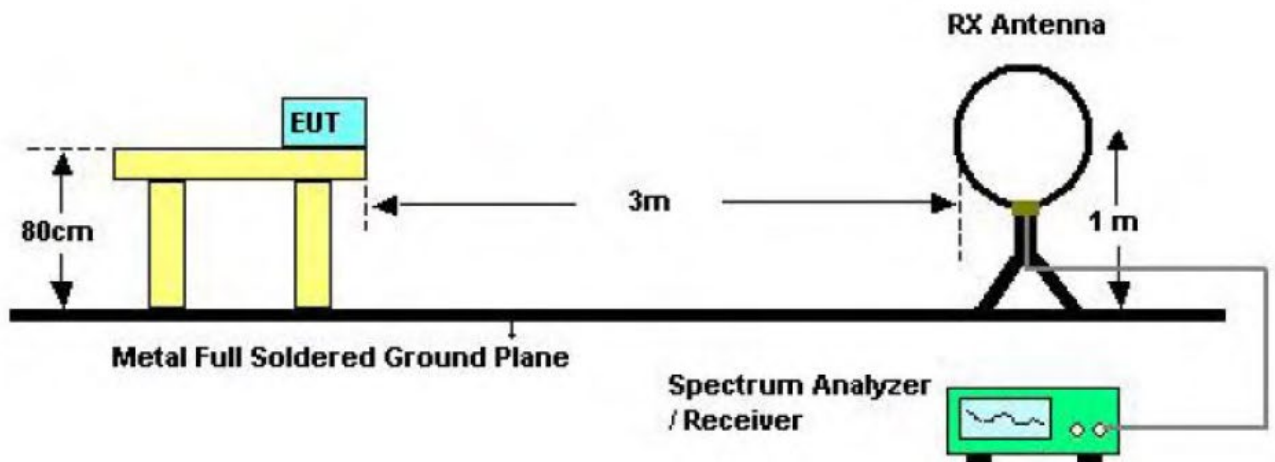

Below 30MHz Test Setup

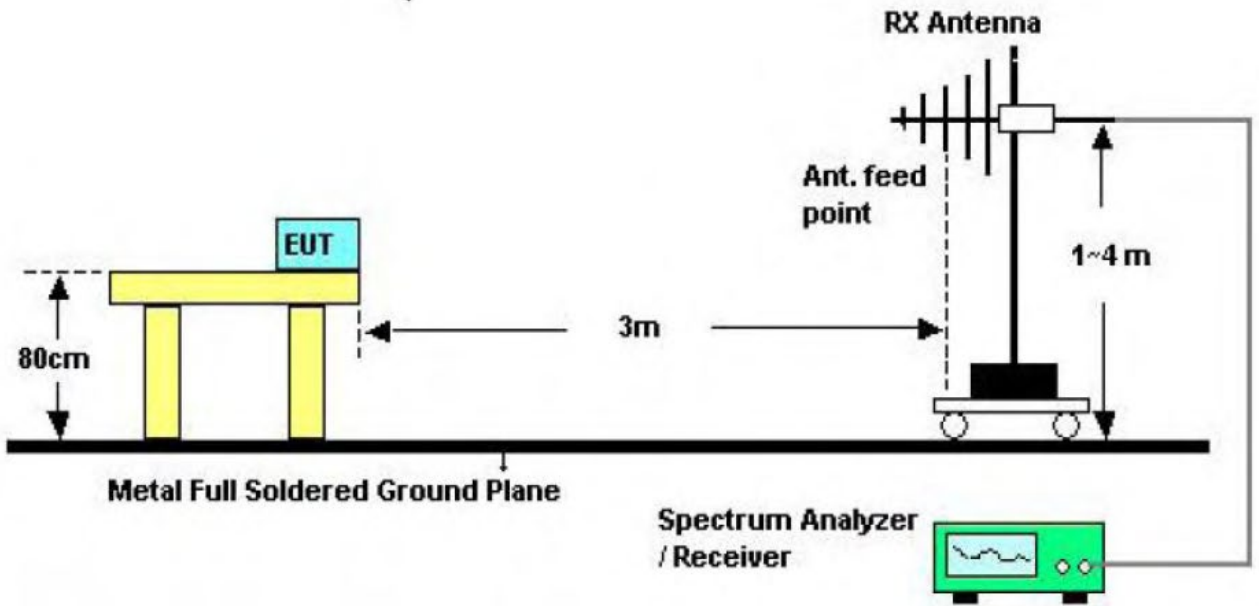

Bellow 1000MHz Test Setup

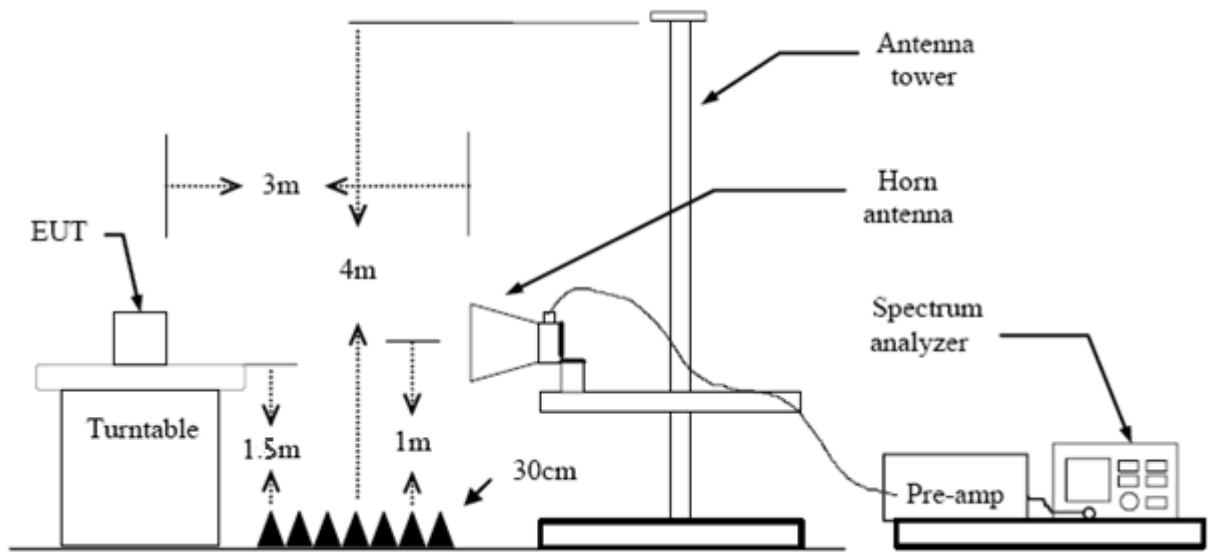

Above 1GHz Test Setup

6.3 Test Procedure

- (1) The measuring distance of 3m shall be used for measurements at frequency up to 1GHz. The EUT was placed on a rotating 0.8m high above the ground, the table was rotated 360 degrees to determine the position of the highest radiation.
- (2) Measurements at frequency above 1GHz. The EUT was placed on a rotating 1.5m high above the ground. RF absorbers covered the ground plane with a minimum area of 3.0m by 3.0m between the EUT and measurement receiver antenna. The RF absorber shall not exceed 30cm in high above the conducting floor. The table was rotated 360 degrees to determine the position of the highest radiation.
- (3) The Test antenna shall vary between 1m and 4m, Both Horizontal and Vertical antenna are set to make measurement.
- (4) The initial step in collecting conducted emission data is a spectrum analyzer peak detector mode pre-scanning the measurement frequency range. Significant peaks are then marked and then Quasi Peak detector mode re-measured.
- (5) If the Peak Mode measured value compliance with and lower than Quasi Peak Mode Limit Bellow 1 GHz, the EUT shall be deemed to meet QP Limits and then no additional QP Mode measurement performed. But the Peak Value and average value both need to comply with applicable limit above 1 GHz.
- (6) Testing frequency range below 1GHz the measuring instrument use VBW=120 kHz with Quasi-peak detection.
- (7) Testing frequency range above 1GHz the measuring instrument use RBW=1 MHz and VBW=3 MHz with Peak Detector for Peak Values, and use RBW=1 MHz and VBW=10 Hz with Peak Detector for Average Values.
- (8) For the actual test configuration, please see the test setup photo.

6.4 Deviation From Test Standard

No deviation

6.5 EUT Operating Condition

The Equipment Under Test was set to Continual Transmitting in maximum power.

6.6 Test Data

Please refer to the Attachment A.

7. Bandwidth

7.1 Test Standard and Limit

7.1.1 Test Standard

FCC 15.231

7.1.2 Test Limit

The 99% bandwidth of the emissions shall be no wider than 0.25% of the center frequency for devices operating above 70 MHz and below 900 MHz. So the emission bandwidth limits have been calculated in below table.

Fundamental Frequency	20 dB Bandwidth Limits (MHz)
433.92MHz	1.0848

7.2 Test Setup

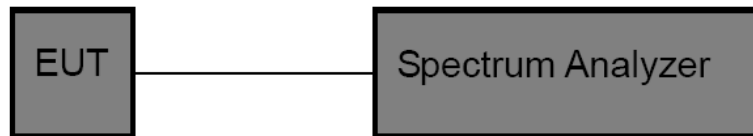

7.3 Test Procedure

- (1) Set Spectrum Analyzer Center Frequency= Fundamental Frequency, RBW=10 kHz, VBW=30 kHz, Span= 1 MHz.
- (2) Measured the spectrum width with power higher than 20 dB below carrier.

7.4 Deviation From Test Standard

No deviation

7.5 EUT Operating Condition

The Equipment Under Test was Programmed to be in continuously transmitting mode.

7.6 Test Data

Please refer to the Attachment B.

8. Release Time Measurement

8.1 Test Standard and Limit

8.1.1 Test Standard

FCC 15.231

8.1.2 Test Limit

According to FCC 15.231a, A manually operated transmitter shall employ a switch that will automatically deactivate the transmitter within not more than 5 seconds of being released.

8.2 Test Setup

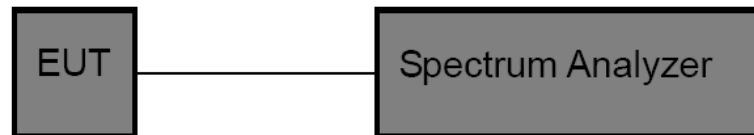

8.3 Test Procedure

- (1) Setup the EUT as show in the block diagram above.
- (2) Set Spectrum Analyzer Centre Frequency= Fundamental Frequency, RBW=100 kHz, VBW= 300 kHz, Span= 0 Hz. Sweep Time= 5 Seconds.
- (3) Setup the EUT as normal operation and press Transmitter button.
- (4) Set Spectrum Analyzer View, Delta Mark time.

8.4 Deviation From Test Standard

No deviation

8.5 EUT Operating Condition

The EUT was set to work in transmitting mode.

8.6 Test Data

Please refer to the Attachment C.

9. Duty Cycle

9.1 Test Standard and Limit

9.1.1 Test Standard
FCC 15.231

9.2 Test Setup

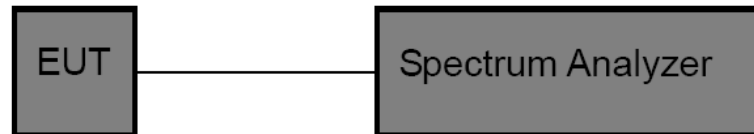

9.3 Test Procedure

- (1) The EUT was placed on a turntable which is 0.8m above ground plane.
- (2) Set EUT operating in continuous transmitting mode.
- (3) Set the Spectrum Analyzer to the transmitter carrier frequency, and set the spectrum analyzer resolution bandwidth (RBW) to 100 kHz and video bandwidth (VBW) to 300 kHz, Span was set to 0 Hz.
- (4) The Duty Cycle was measured and recorded.

9.4 Deviation From Test Standard

No deviation

9.5 EUT Operating Condition

The EUT was programmed to be in transmitting mode.

9.6 Test Data

Please refer to the Attachment D.

10. Antenna Requirement

10.1 Standard Requirement

10.1.1 Standard

FCC Part 15.203

10.1.2 Requirement

An intentional radiator shall be designed to ensure that no antenna other than that furnished by the responsible party shall be used with the device. The use of a permanently attached antenna or of an antenna that uses a unique coupling to the intentional radiator shall be considered sufficient to comply with the provisions of this Section. The manufacturer may design the unit so that a broken antenna can be replaced by the user, but the use of a standard antenna jack or electrical connector is prohibited.

10.1 Deviation From Test Standard

No deviation

10.2 Antenna Connected Construction

The gains of the antenna used for transmitting is 0 dBi, and the antenna connector is de-signed with permanent attachment and no consideration of replacement. Please see the EUT photo for details.

The EUT antenna is an Internal Antenna. It complies with the standard requirement.

Antenna Type
<input type="checkbox"/> Permanent attached antenna
<input checked="" type="checkbox"/> Unique connector antenna
<input type="checkbox"/> Professional installation antenna

Attachment A-- Radiated Emission Test Data

9 KHz to 30 MHz

From 9 KHz to 30 MHz: Conclusion: PASS

Note: The amplitude of spurious emissions which are attenuated by more than 20dB below the permissible value has no need to be reported.

30MHz-1GHz

Temperature:	23.6°C	Relative Humidity:	42%
Test Voltage:	DC 3.0V		
Ant. Pol.	Horizontal		
Test Mode:	TX Mode		
Remark:	No report for the emission which more than 10 dB below the prescribed limit.		

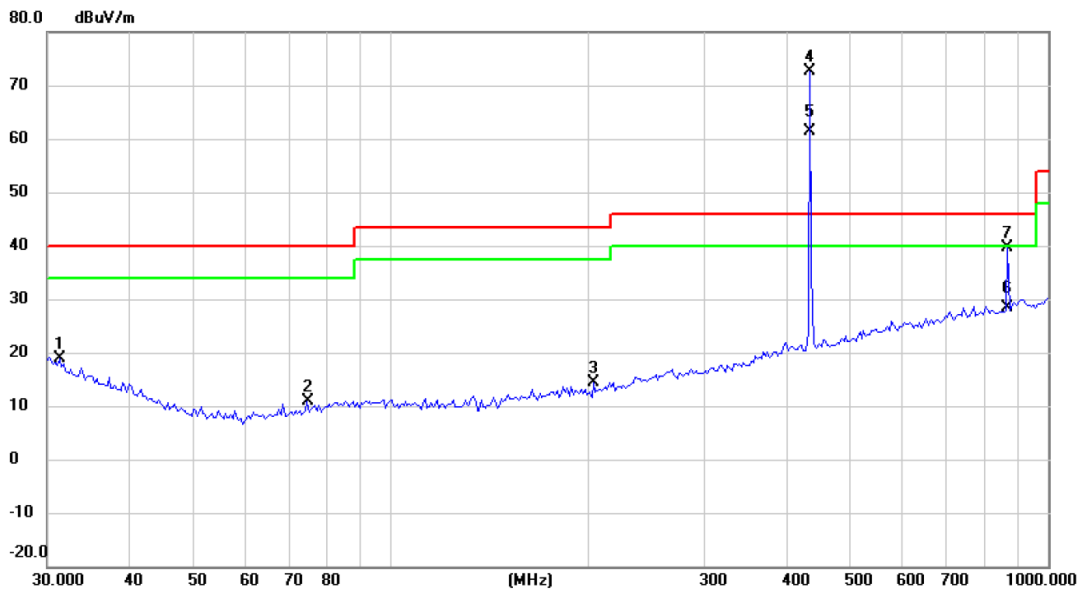

No.	Mk.	Freq. MHz	Reading Level dBuV	Correct Factor dB	Measure- ment dBuV/m	Limit dBuV/m	Over dB	Detector
1		31.2893	32.68	-13.91	18.77	40.00	-21.23	peak
2		74.6570	33.85	-22.96	10.89	40.00	-29.11	peak
3		203.5228	34.03	-19.76	14.27	43.50	-29.23	peak
4	*	434.0650	84.57	-12.04	72.53	100.82	-28.29	peak
5	X	434.0651	73.37	-12.04	61.33	80.82	-19.49	AVG
6		869.1300	33.63	-5.26	28.37	60.82	-32.45	AVG
7		869.1302	44.83	-5.26	39.57	80.82	-41.25	peak

Emission Level= Read Level+ Correct Factor

Average Value=Peak Value-11.2

Temperature:	23.6°C	Relative Humidity:	42%
Test Voltage:	DC 3.0V		
Ant. Pol.	Vertical		
Test Mode:	TX Mode		
Remark:	No report for the emission which more than 10 dB below the prescribed limit.		

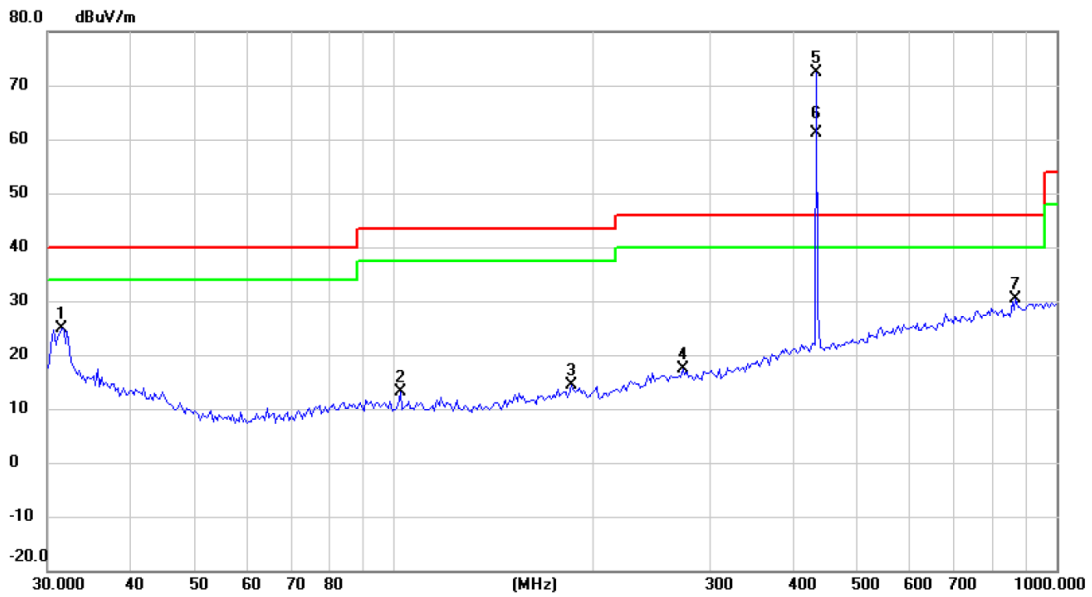

No.	Mk.	Freq. MHz	Reading Level dBuV	Correct Factor dB	Measure- ment dBuV/m	Limit dBuV/m	Over dB	Detector
1		31.5095	38.97	-14.08	24.89	40.00	-15.11	peak
2		102.3597	35.15	-22.02	13.13	43.50	-30.37	peak
3		185.7882	34.25	-19.94	14.31	43.50	-29.19	peak
4		273.2341	34.07	-16.79	17.28	46.00	-28.72	peak
5	*	434.0650	84.41	-12.04	72.37	100.82	-28.45	peak
6	X	434.0651	73.21	-12.04	61.17	80.82	-19.65	AVG
7		869.1302	35.75	-5.26	30.49	80.82	-50.33	peak

Emission Level= Read Level+ Correct Factor

Average Value=Peak Value-11.2

Above 1G

Temperature:	23.6°C	Relative Humidity:	42%
Test Voltage:	DC 3.0V		
Ant. Pol.	Horizontal		
Test Mode:	TX Mode		
Remark:	The peak value < average limit, So only show the peak value.		

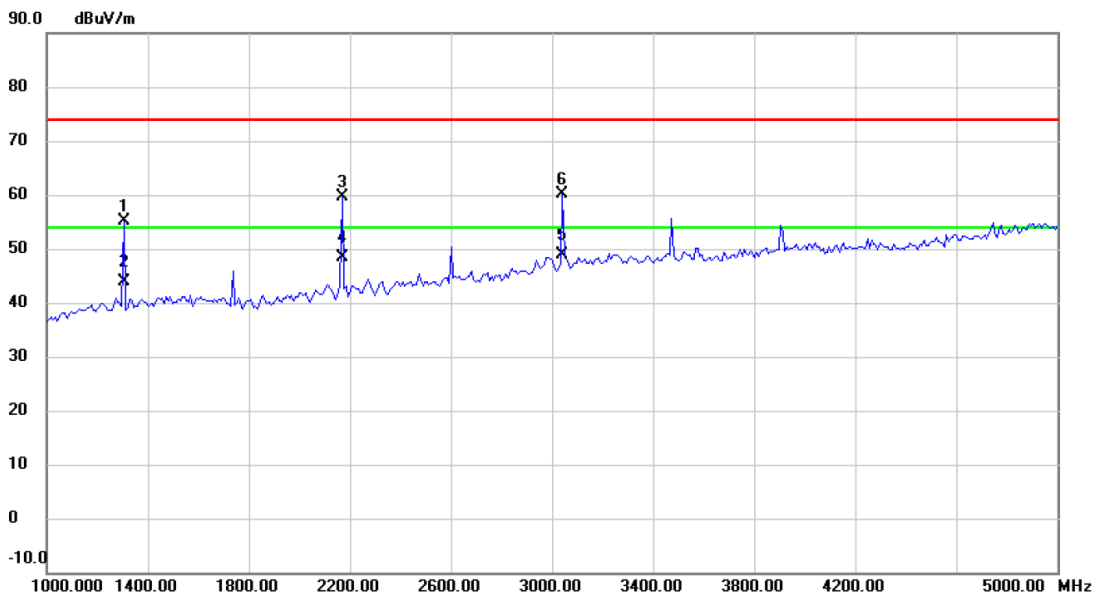

No.	Mk.	Freq. MHz	Reading Level dBuV	Correct Factor dB	Measure- ment dBuV/m	Limit dBuV/m	Over dB	Detector
1		1304.012	58.68	-3.55	55.13	74.00	-18.87	peak
2		1304.023	47.48	-3.55	43.93	54.00	-10.07	AVG
3		2168.212	59.33	0.32	59.65	74.00	-14.35	peak
4		2168.251	48.13	0.32	48.45	54.00	-5.55	AVG
5	*	3040.135	43.16	5.81	48.97	54.00	-5.03	AVG
6		3040.231	54.36	5.81	60.17	74.00	-13.83	peak

Emission Level= Read Level+ Correct Factor

Average Value=Peak Value-11.2

Temperature:	23.6°C	Relative Humidity:	42%
Test Voltage:	DC 3.0V		
Ant. Pol.	Vertical		
Test Mode:	TX Mode		
Remark:	The peak value < average limit, So only show the peak value.		

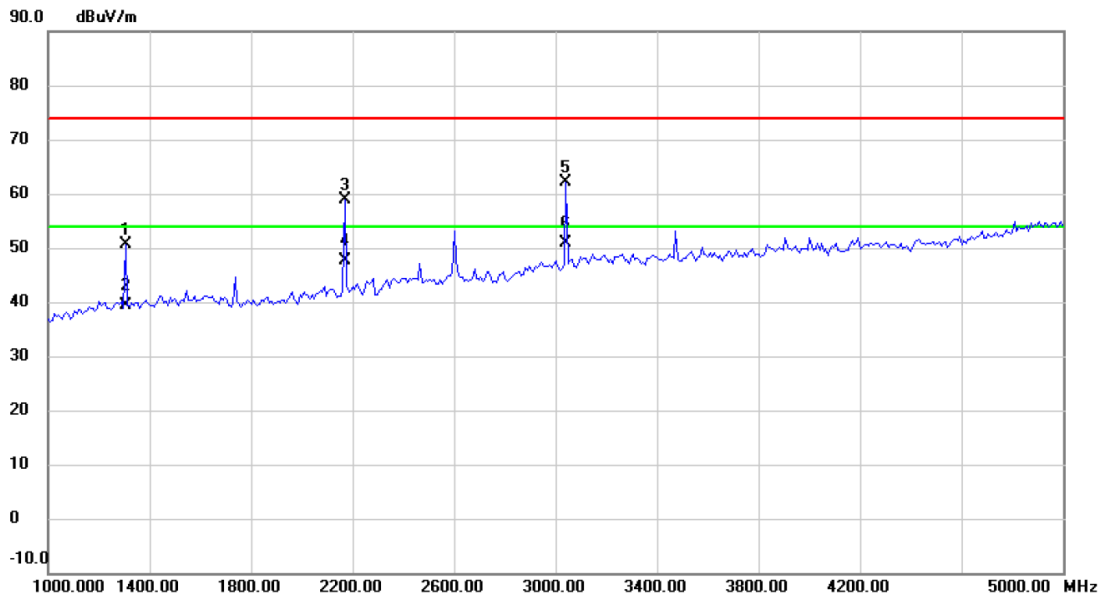

No.	Mk.	Freq. MHz	Reading Level dBuV	Correct Factor dB	Measure- ment dBuV/m	Limit dBuV/m	Over dB	Detector
1		1304.000	54.08	-3.55	50.53	74.00	-23.47	peak
2		1304.000	42.88	-3.55	39.33	54.00	-14.67	AVG
3		2168.000	58.60	0.32	58.92	74.00	-15.08	peak
4		2168.000	47.40	0.32	47.72	54.00	-6.28	AVG
5		3040.000	56.21	5.81	62.02	74.00	-11.98	peak
6	*	3040.000	45.01	5.81	50.82	54.00	-3.18	AVG

Emission Level= Read Level+ Correct Factor

Average Value=Peak Value-11.2

Other harmonics emissions are lower than 20dB below the allowable limit.

Note: (1) All Readings are Peak Value and AV. And AV is calculated by the following:

Testing frequency range below 1GHz the measuring instrument use VBW=120 kHz with Quasi-peak detection.

Testing frequency range above 1GHz the measuring instrument use RBW=1 MHz and VBW=3 MHz with Peak Detector for Peak Values.

Average Values=Peak Values+20log (Duty Cycle)

(2) Emission Level= Reading Level + Probe Factor +Cable Loss

(3) Data of measurement within this frequency range shown “ -- ” in the table above means the reading of emissions are attenuated more than 20dB below the permissible limits or the field strength is too small to be measured.

Pulse Desensitization Correction Factor

Note:

1)The Smallest Pulse Width (PW)= 0.400ms

(2) $2/PW=2/0.400(\text{ms})= 5\text{kHz}<100\text{ kHz}$

Because $2/PW<RBW$, so the PDCF is not needed.

Attachment B--Bandwidth Data

Temperature	:	25°C
Relative Humidity	:	65 %
Pressure	:	1010 hPa
Test Power	:	DC 3.0V

Frequency (MHz)	20 dBc Bandwidth (kHz)	99% OBW (kHz)	Limit (kHz)	Result
433.92	45.789	47.3941	1084.8	PASS

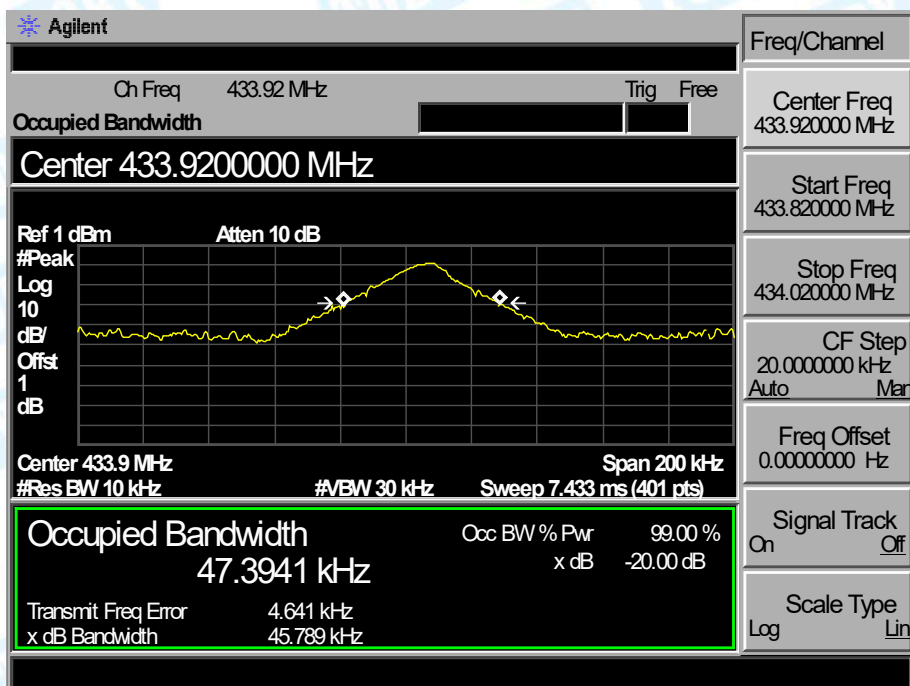

Attachment C-- Release Time Measurement Data

Temperature	:	25 °C
Relative Humidity	:	65 %
Pressure	:	1010 hPa
Test Power	:	DC 3.0V

Release Time(s)	Limit (s)	Result
1.587	5	PASS

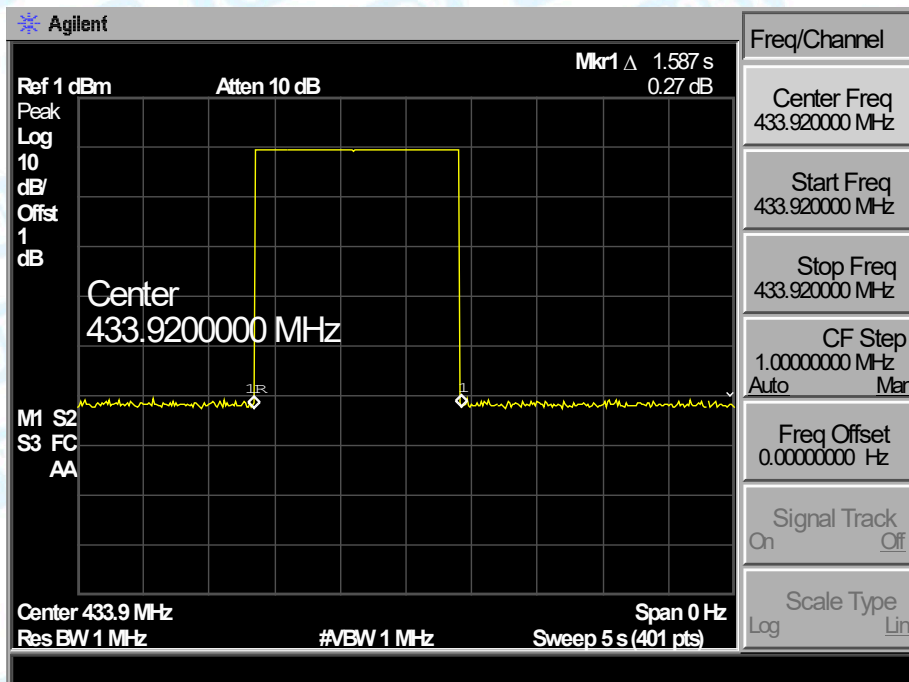

Attachment D--Duty Cycle Data

Please refer the following pages:

Plot 1/Plot 2: transmit once in 100ms, and each cycle is 38.25 ms there are two kinds of pulse in each cycle, the large pulses total 1, the small pulses total 24.

Plot 3: one large pulse in a time period of 1.0 ms

Plot 4: one middle pulse in a time period of 0.4 ms

$$\text{Duty Cycle} = \text{ON} / \text{Total} = (1 * 1 + 0.4 * 24) / 38.25 = 10.6 / 38.25 = 27.71\%$$

$$20 \log (\text{Duty Cycle}) = -11.2$$

$$\text{Average} = \text{Peak Value} + 20 \log (\text{Duty Cycle}), \text{AV} = \text{PK} - 11.2$$

Plot 1

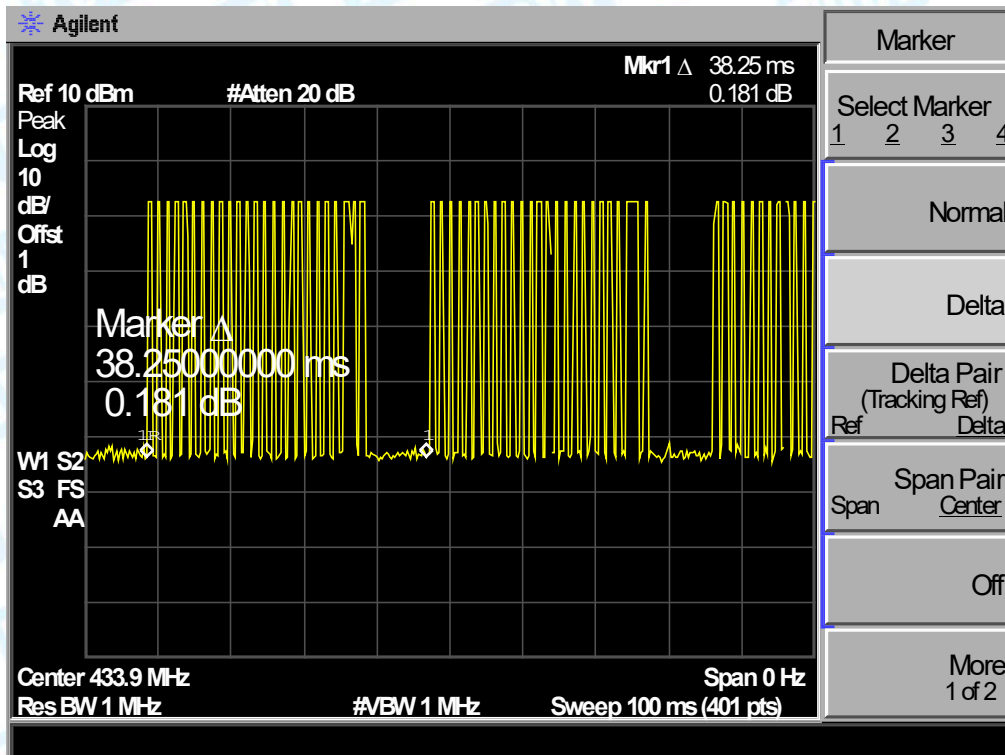

Plot 2

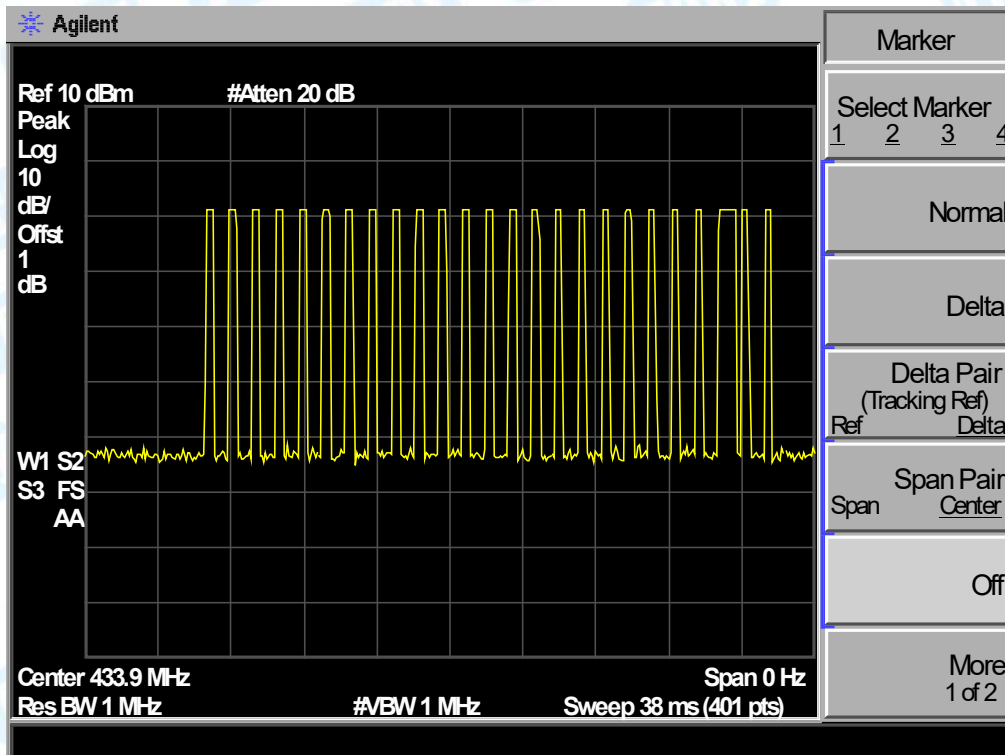

Plot 3

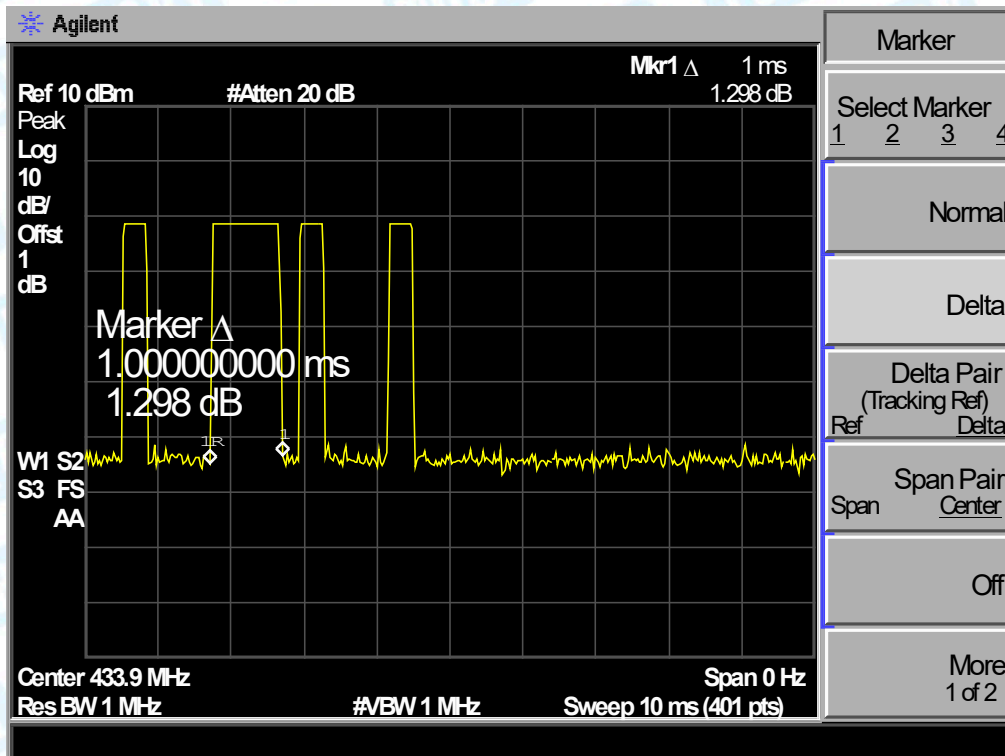

Plot 4

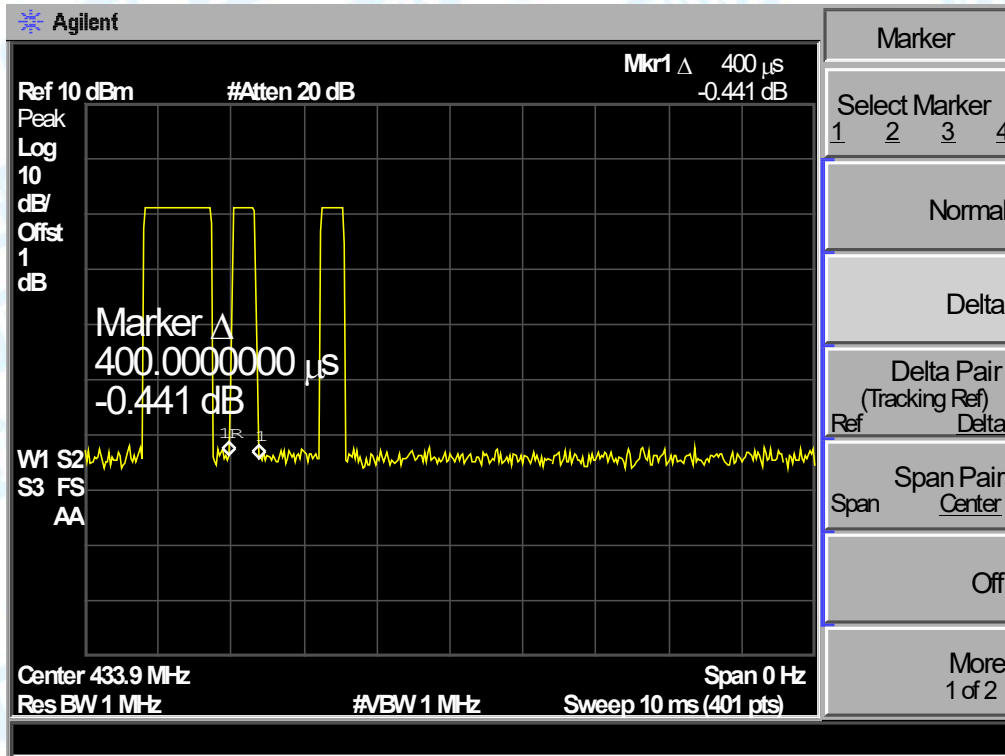

-----END OF REPORT-----