

**DISCLAIMER:** The exact components of your system, images, and quantities may vary depending on your model number. While these may vary, this QSG addresses the setup of your DVR and cameras. While we make every effort to provide accurate information and to the products, at any time without notice.

### What's in the Box

**Camera / Accessories**

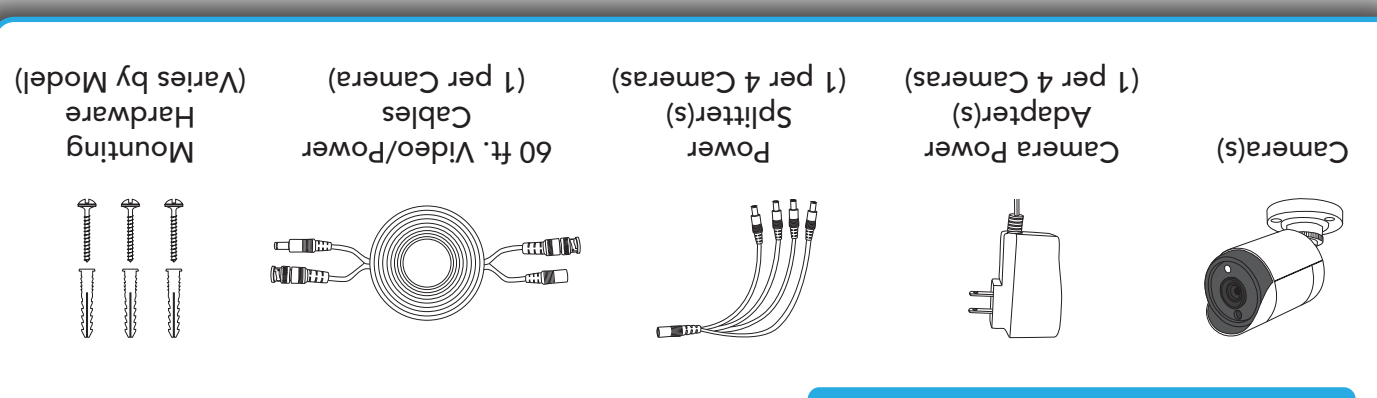

Camera(s)  
Camera Power Adapter(s) (1 per 4 Cameras)  
Splitter(s) (1 per 4 Cameras)  
60 ft. Video/Power Cables (1 per Camera)  
Mounting Hardware (Varies by Model)

**Items Not Included**

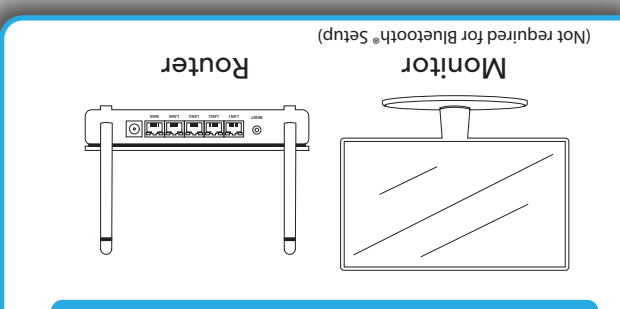

(Not required for Bluetooth® Setup)

**DVR / Accessories**

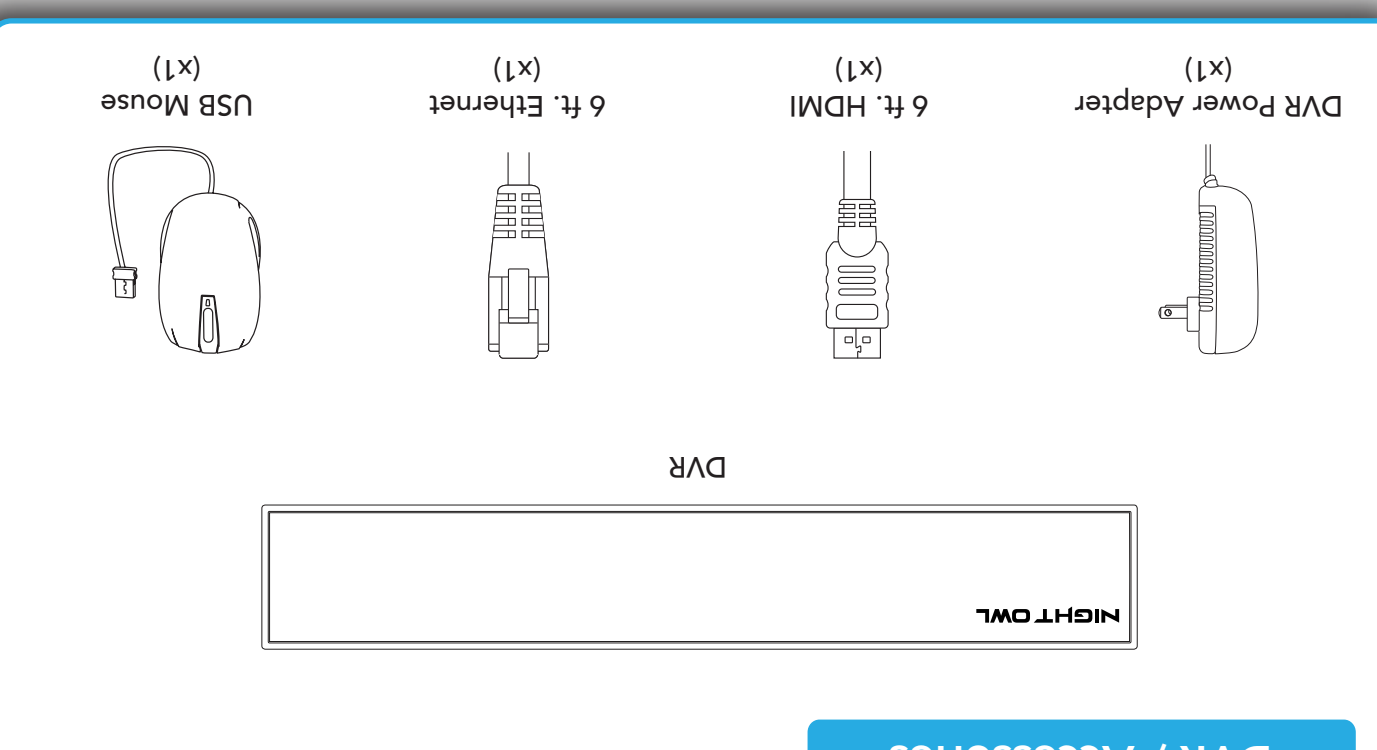

DVR Power Adapter (x1)  
6 ft. HDMI (x1)  
6 ft. Ethernet (x1)  
USB Mouse (x1)

### NOTE: If connecting to a TV or Monitor (Not Required), it must have a minimum resolution of 1080p HD. Use all of the included Night Owl accessories. Third-party accessories may not work correctly.

Night Owl Technical Support

DVR Hardware Setup Video

Follow along as we guide you through the DVR's hardware setup. Step-by-step instructions make it even easier to connect your system!

Use the QR Code for easy access to the DVR Hardware Setup Video on Night Owl's YouTube Channel.



For more Support Videos, go to Night Owl's YouTube page by typing [www.youtube.com/nightowlsp](http://www.youtube.com/nightowlsp) into your web browser.

Still need more support? Before calling Night Owl Technical Support, keep in mind we can only provide phone support if:

- 1 Your device is running the latest firmware version.
- 2 Your device is registered. To register your device:
  - a Download Night Owl Protect from your Smart Device's App Store.
  - b Click "Sign Up" to create an account.
  - c Go to [www.no-protect.com](http://www.no-protect.com) and manually register your device.
- 3 You are in front of the device with it powered on.

Thank you for being a Night Owl Customer! Secure, Protect, Connect your world!

## NIGHT OWL

### Not Connecting to the Internet?

**Night Owl strongly recommends connecting the DVR to the Internet. If you have decided not to connect, follow the onscreen prompts within the Startup Wizard. Please note that not connecting your DVR means:**

- You must manually update the device's firmware to the latest version to receive Technical Phone Support. The latest firmware version is available on the device's support page on the Night Owl Support Site.
- The DVR must be registered to receive Technical Phone Support.
- You cannot view your system remotely.
- Resetting your password is a much longer process to ensure security.

### Need More Help?



Search Model / Series [Show me](#)

Search

For system manuals, troubleshooting guides, FAQs, video tutorials and more:

- 1 Please visit **Support.NightOwlSP.com**
- 2 Enter the Series listed on the Product Support Sticker (on top of the DVR) into the Search bar.
- 3 Access the support material needed.

## NIGHT OWL

### Quick Setup Guide

Digital Video Recorder (DVR) Product Setup

# Wired DVR Security System





## Need Help?

Why call? Our 24/7 online support site has it all!

For system manuals, troubleshooting guides, FAQs, video tutorials and more:

- 1 Visit **Support.NightOwlSP.com**
- 2 Enter the **Series** listed on the product support sticker into the search bar
- 3 Access the support material needed



Product support information can be found on the top of your Recorder

# Step 1: Connecting Your System

**NOTE:** Watch our Recorder Setup Video on YouTube.

## Option 1: Easy Bluetooth® Wireless Setup

With our easy Bluetooth® wireless setup, no TV / Monitor is required. Once your system is connected using the steps below, you can quickly finish the setup right from the app on your Smart Device. This is the preferred setup method for your system. Please proceed to step 1.

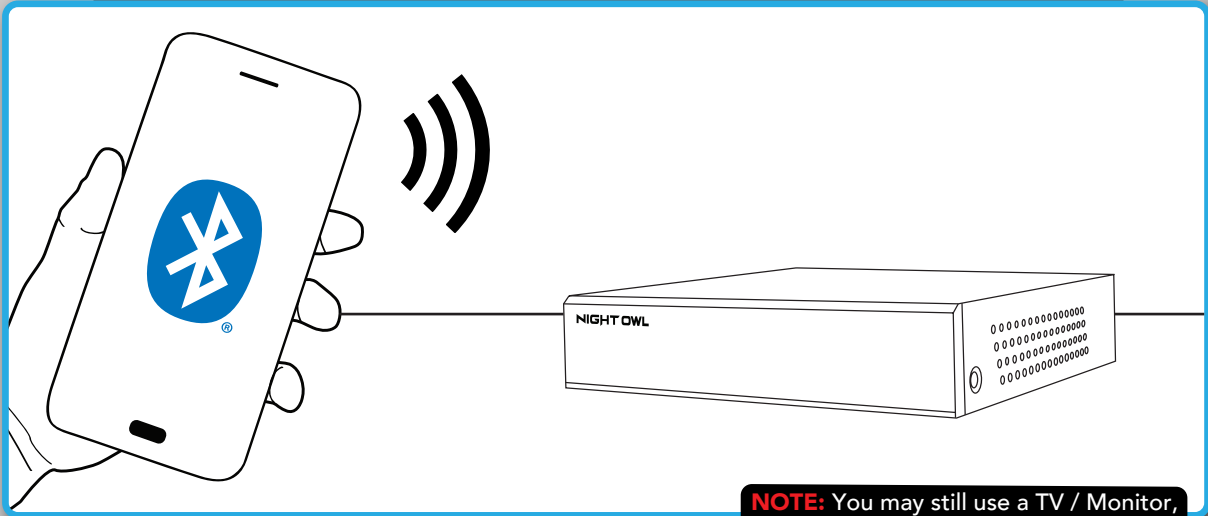

**NOTE:** You may still use a TV / Monitor, it is just not required for initial setup.

## Option 2: Manual Setup (TV / Monitor)

While our easy Bluetooth® wireless setup is preferred, you may still want to locally view your system from a TV / Monitor. The choice is yours based on your setup needs. If you want to connect a TV / Monitor, complete the two steps below then continue to finish connecting your system.

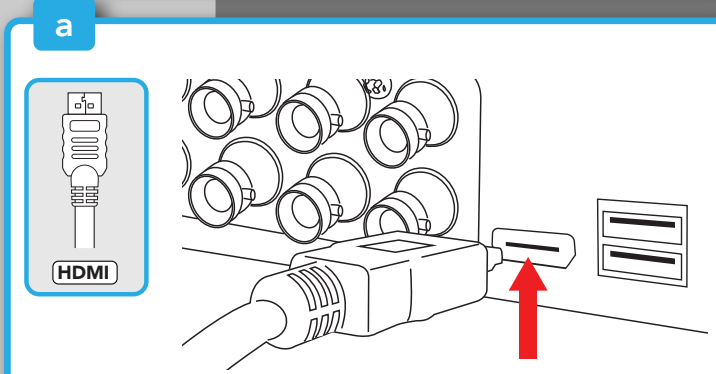

Plug one end of the included HDMI cable into the HDMI port on the back of the DVR. Plug the other end of the cable into your TV or Monitor.

**NOTE:** To view cameras, TV or Monitor must be tuned to the same input the HDMI is plugged into.

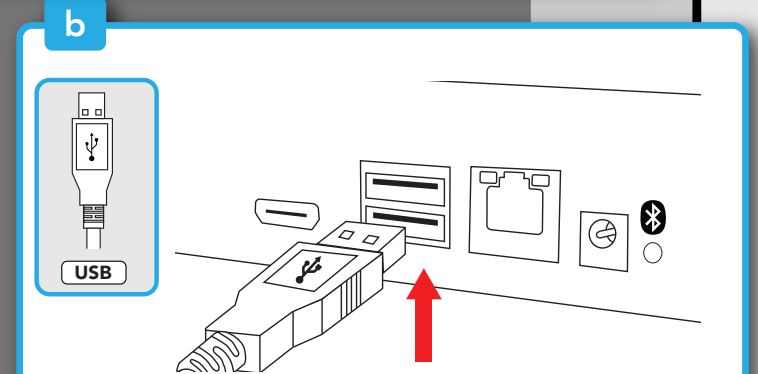

Plug the USB mouse into the USB port on the back of the DVR.

### Follow The Steps Below to Continue Setting up your System For Both Options

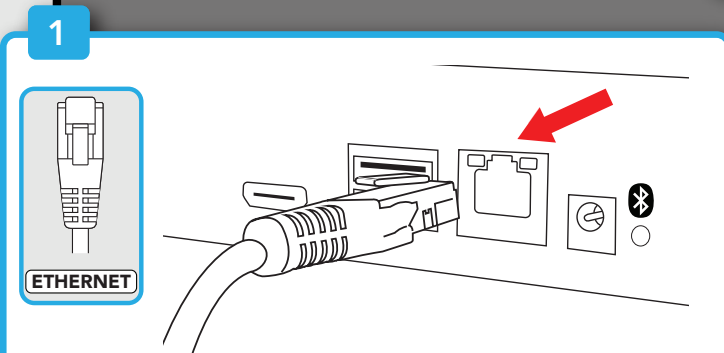

Plug one end of the included Ethernet cable into the LAN port on the back of the DVR.

**NOTE:** Night Owl recommends connecting to the Internet for the best user experience.

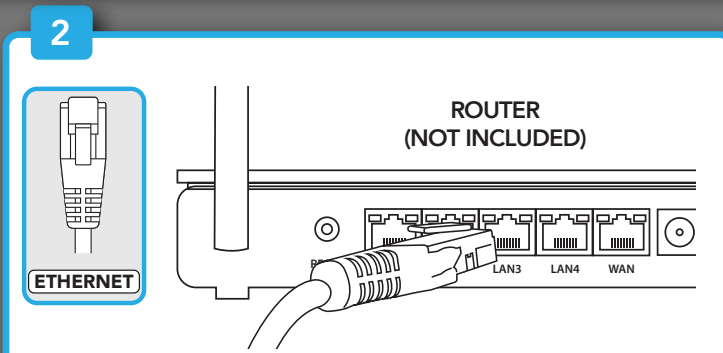

Plug the other end of the Ethernet cable into a port on the back of your router or modem.

**NOTE:** As long as your DVR is hardwired using Ethernet cabling, you can connect to any working network access point. See your product manual for more details.

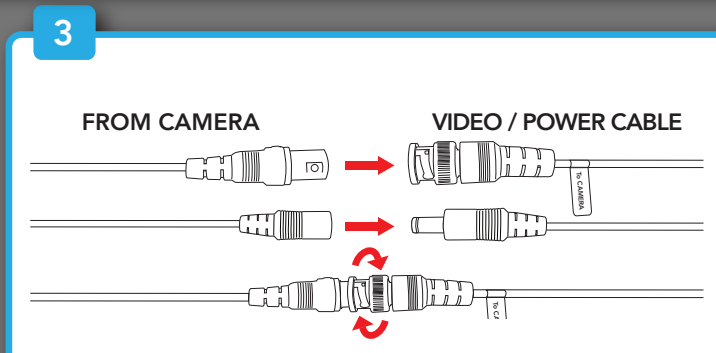

Connect the end of the camera's cable to the end of a video / power cable labeled TO CAMERA ONLY.

**BEFORE** installing, connect and test each camera locally to confirm they function properly.

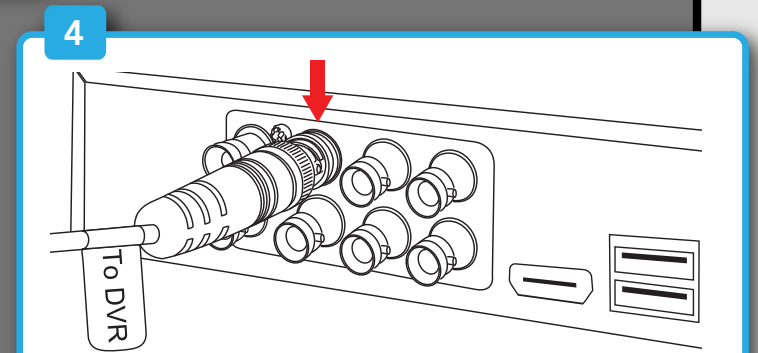

Connect the video / power cable labeled TO DVR ONLY to an open video input on the DVR.

**NOTE:** Make sure you twist and lock BNC connectors.

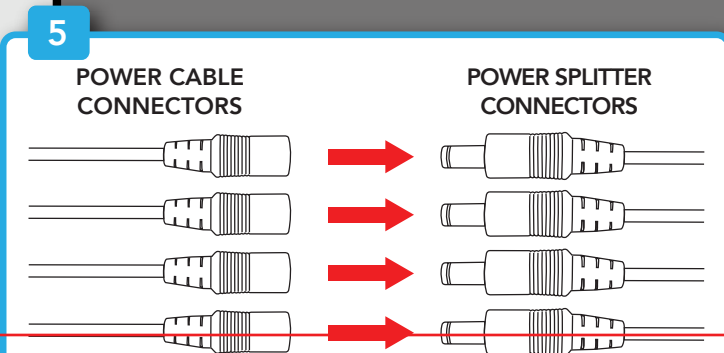

Connect the red female power leads of the video / power cables to the male power splitter ends.

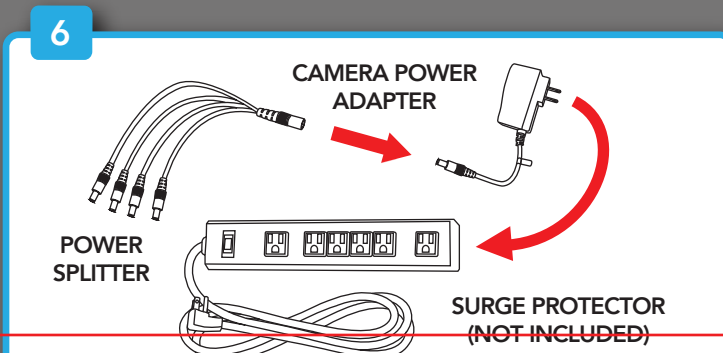

Connect the power splitter to the camera power adapter and plug the adapter into a surge protector or Uninterruptible Power Supply (UPS).

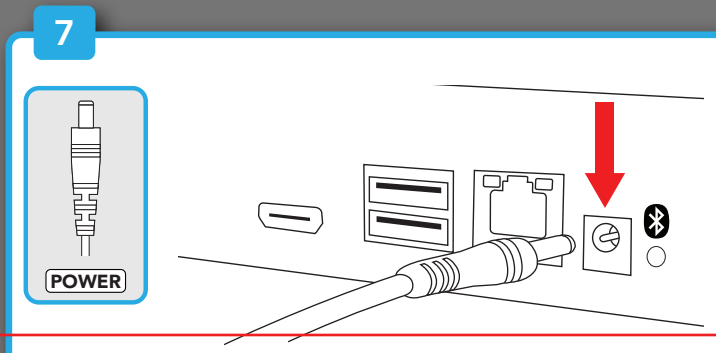

Connect the DVR power adapter to the Power Input on the rear of the DVR.

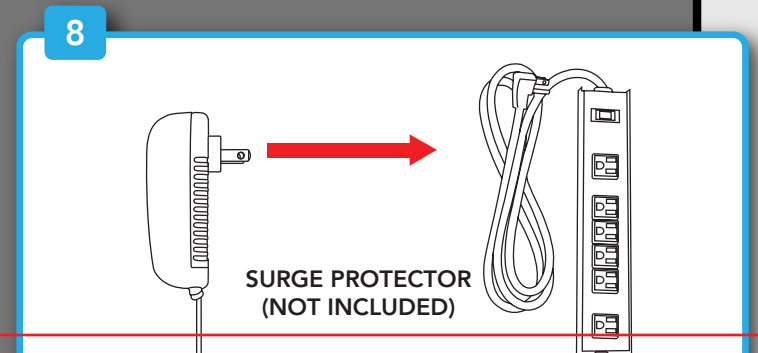

Plug the DVR power adapter into a surge protector or Uninterruptible Power Supply (UPS). Some systems beep upon booting up.

**NOTE:** Make sure the UPS or surge protector is switched ON.

# Step 2: Download Night Owl Protect

**2a** If you're a First Time User, download Night Owl Protect from the App Store or Google Play Store onto your Smart Device. If you already have an account skip to Step 3.

**NOTE:** Setup is the same for Smartphone and Tablet.

**2b** Create and verify your Night Owl Protect account. Proceed to Step 3.



# Step 3: System Configuration

Now that your system's hardware is connected and you have the app setup on your Smart Device, it is time to configure your system. Based on whether you chose Option 1: Easy Bluetooth® Wireless Setup or Option 2: Manual Setup (TV / Monitor), follow the steps below.

## Option 1: Easy Bluetooth® Wireless Setup

**NOTE:** If you have a TV / Monitor connected, you will see setup information appear on the screen as you complete the Bluetooth® setup. A TV / Monitor is not required for this setup, but can be used for viewing.

**1** Log in to the app. If your device's Bluetooth® is not enabled, you will be asked to allow access.

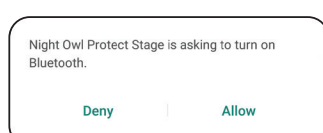

**2** The app will now use Bluetooth® to find the DVR. Tap "Continue" to add the DVR to your Night Owl Protect account.

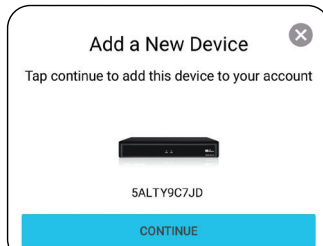

**3** Take a moment to name your recorder.

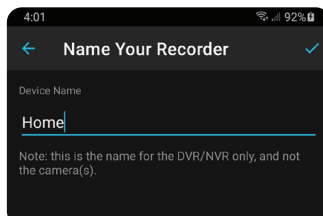

**4** The app will now pair to the DVR. Once finished, complete the remainder of the Startup Wizard right from the app and begin viewing your cameras.

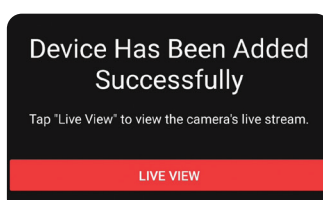

**NOTE:** If the DVR is not connected to the Internet, you will not be able to live view the cameras from the app.

## Option 2: Manual Setup (TV / Monitor)

**NOTE:** Connecting your system and using the Night Owl Protect App is preferred and offers added security benefits and convenience to your mobile lifestyle.



We strongly recommend you connect your DVR to the Internet to search for the latest firmware. Keeping your firmware updated is vital for the overall health of your system. If you are NOT connecting your DVR to the Internet, please manually upgrade the firmware and register your device.

**1** If you have not already done so, connect your DVR to a TV / Monitor using the provided HDMI cable. Follow the steps in Connecting Your System.

**2** You will now begin the Startup Wizard. When you get to the following screen, click "Manual Setup (not recommended)."

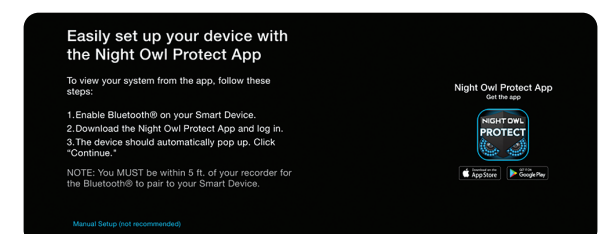

**3** Proceed through the rest of the Startup Wizard to finish setup. Once complete, click on "Go to Live View" to begin viewing your cameras.

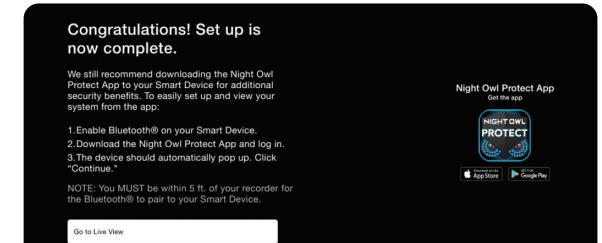

## **FCC Statement**

This equipment has been tested and found to comply with the limits for a Class B digital device, pursuant to part 15 of the FCC rules. These limits are designed to provide reasonable protection against harmful interference in a residential installation. This equipment generates, uses and can radiate radio frequency energy and, if not installed and used in accordance with the instructions, may cause harmful interference to radio communications. However, there is no guarantee that interference will not occur in a particular installation. If this equipment does cause harmful interference to radio or television reception, which can be determined by turning the equipment off and on, the user is encouraged to try to correct the interference by one or more of the following measures:

- Reorient or relocate the receiving antenna.
- Increase the separation between the equipment and receiver.
- Connect the equipment into an outlet on a circuit different from that to which the receiver is connected.
- Consult the dealer or an experienced radio/TV technician for help.

To assure continued compliance, any changes or modifications not expressly approved by the party.

Responsible for compliance could void the user's authority to operate this equipment. (Example- use only shielded interface cables when connecting to computer or peripheral devices).

This equipment complies with Part 15 of the FCC Rules. Operation is subject to the following two conditions:

- (1) This device may not cause harmful interference, and
- (2) This device must accept any interference received, including interference that may cause undesired operation.

## **FCC Radiation Exposure Statement:**

The equipment complies with FCC Radiation exposure limits set forth for uncontrolled environment. This equipment should be installed and operated with minimum distance 20cm between the radiator and your body.