

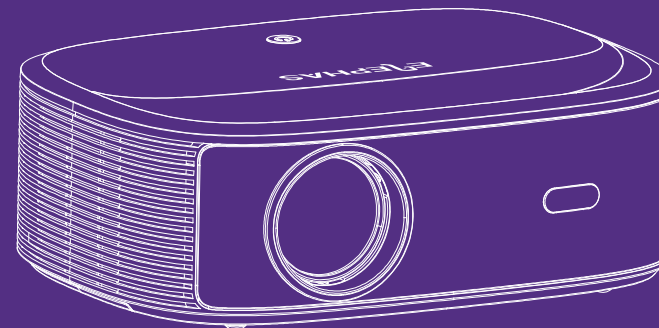

USER MANUAL



 <https://www.top-elephas.com/>

 service@elephas.com.hk
support@elephas.com.hk

 001-844-610-2995

 Mon. – Fri. 9:00 AM-5:00 PM (PT)



SCAN ME

MODEL NO.

YG691 Movin

   **RoHS**  **HDMI**

24/7 LIVE CHAT SUPPORT

ACTIVATE YOUR 12-MONTH WARRANTY & CUSTOMER SERVICE

by choosing one of the following two options:

Option 1

Please visit our website and register:

 <https://www.top-elephas.com/>

Option 2

Please scan the below code and contact us:



SCAN ME

Also, you can scan the above code for more operation videos.

 service@elephas.com.hk
support@elephas.com.hk

CATALOG (English)

Safety Instructions.....	1
Disposal	4
Package List.....	5
Overview.....	6
Remote Control	7
Getting Started	8
Connections	10
• Projector Interface Connection	10
• USB Connection	11
• HDMI Connection	13
• 3.5mm Audio Connection	15
BT Connection.....	16
Supported APPs	17
WiFi Connection	18
Projector Installation.....	23
Menu Settings	24
Unload The Dust Net And Clear	25
Technology Features.....	26
Questions & Answers	27

Safety Instructions

Read all instructions before you use this device. Do not make any changes or create settings that are not described in this manual. If physical injury, loss of data or damage is caused by failure to follow instructions, the warranty does not apply.

Setup

1. To reduce the risk of fire or electric shock, do not expose the device to rain or moisture. Objects filled with liquids, such as vases, should not be placed on this device.
2. Do not place this device on soft surfaces such as tablecloths or carpets, otherwise the device could be a fire hazard.
3. Do not place this device in areas susceptible to excessive dust and dirt or near any appliance generating a strong magnetic field.
4. To prevent overheating, do not block or clog the ventilation openings.
5. Never place this device in a confined space. Always leave enough space around this device for ventilation.
6. Protect this device from overexposure to direct sunlight, heat, large temperature fluctuations and moisture. Avoid extreme temperatures. The suitable operations and storage temperature for this device and its accessories is (0°F to 95°F).
7. When this device is running for a long period of time, the surface may become hot. Shut it down immediately and unplug the charger. Resume operation after this device has cooled down.
8. Always handle this device with care. Avoid touching the lens. Do not allow children to handle the device without supervision.
9. Never place heavy or sharp objects on this device.
10. To avoid electric shock, do not disassemble.
11. Use attachments or accessories specified by the manufacturer only.
12. Avoid extreme vibrations as they may damage the internal components.

The following safety instructions ensure the long service life of the projector to avoid fire or electric shock. Please read carefully and pay attention to the following warnings.

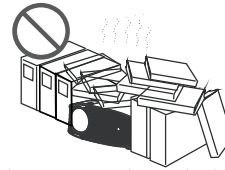

Don't install the projector in sites with improper ventilation.

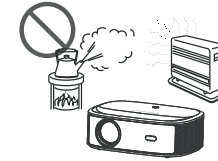

Don't install the projector in hot or humid sites.

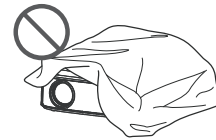

Don't cover the projector ventilation holes with any material.

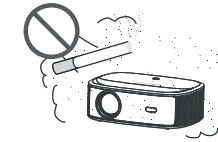

Don't install the projector in dust or smoke sites.



Don't install the projector near the temperature or smoke transducer. It may cause a sensor failure.

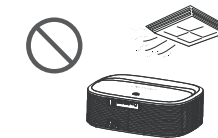

Don't install the projector in sites with direct blowing of warm or cool air-condition wind.



Please do not look into the lens when the projector is working, otherwise it may hurt your eyes.



Please keep the projector away from water or any other liquid as it is not waterproof.

● FCC Statement

Radiation Exposure Statement.

This device complies with part 15 of the FCC rules. Operation is subject to the following two conditions:

(1) This device may not cause harmful interference; and (2) this device must accept any interference received, including interference that may cause undesired operation.

Changes or modifications not expressly approved by the party responsible for compliance could void the user's authority to operate the equipment.

This equipment complies with FCC radiation exposure limits set forth for an uncontrolled environment.

This equipment should be installed and operated with minimum distance of 20cm between the radiator and your body.

This transmitter must not be co-located or operating in conjunction with any other antenna or transmitter.

NOTE: This equipment has been tested and found to comply with the limits for a Class B digital device, pursuant to part 15 of the FCC Rules.

These limits are designed to provide reasonable protection against harmful interference in a residential installation. This equipment generates uses and can radiate radio frequency energy and, if not installed and used in accordance with the instructions, may cause harmful interference to radio communications. However, there is no guarantee that interference will not occur in a particular installation.

If this equipment does cause harmful interference to radio or television reception, which can be determined by turning the equipment off and on, the user is encouraged to try to correct the interference by one or more of the following measures:

- Reorient or relocate the receiving antenna.
- Increase the separation between equipment and receiver.
- Connect the equipment into an outlet on a circuit different from that to which the receiver is connected.
- Consult the dealer or an experienced radio/TV technician for help important announcement Important.

● Radiation Exposure Statement

This equipment complies with FCC radiation exposure limits set forth for an uncontrolled environment. This equipment should be installed and operated with a minimum distance of 20cm between the radiator and your body.

This transmitter must not be co-located or operating in conjunction with any other antenna or transmitter.

● Notice

(1) Please use the power cord with caution to avoid unduly bending. A damaged power cord may cause electric shock.

(2) Please use the projector with caution to avoid dropping or shocking, which may damage the internal components.

(3) Please use the same power voltage as marked on the projector.

(4) Please use the projector in a dark room for the best results.

(5) Please do not disassemble the projector by yourself, otherwise the warranty will be void.

(6) Please do not look into the lens when the projector is working, otherwise it may hurt your eyes.

(7) Please turn off and unplug from the power supply if not using the projector for a long time.





Disposal

E-waste recycling instructions

All electronic waste is made up of deadly chemicals such as lead, cadmium, beryllium, mercury and brominated flame retardants. Disposing of gadgets and devices improperly increases the chances of these dangerous chemicals contaminating the soil, polluting the air and leaching into water bodies.

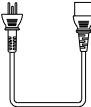
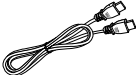
Please find an e-waste recycler who is officially certified by the Basel Action Network (BAN)

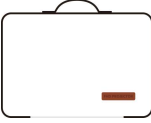
Package List

 Projector × 1	 Power Cable × 1	 HDMI Cable×1
 Remote Control ×1 (Batteries are not included)	 Portable Bag x 1	 Lens Cover x1
 Projector User Manual & Quick Start Guide		

Tips:

1. Blurry Image

- * Firstly, if the auto keystone does not meet the requirements, please correct the keystone to be rectangular.
- * Second, Press the focus button on the remote control to obtain the best clarity.
- * If there is any part missing, please contact our customer service email address in the Quick Start Guide or contact the seller you bought this device.

2. Mounting Hole

Adopting a single mounting hole dual-use design, the projector is compatible with the standard camera tripod and 1/2 inch screw projector tripod stand. Meanwhile, you can rotate the screw 360° to meet different angle needs.

Overview

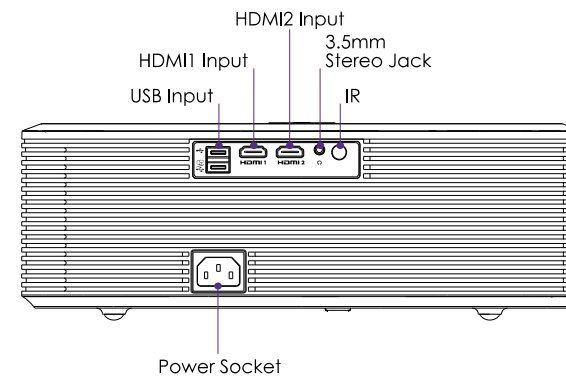
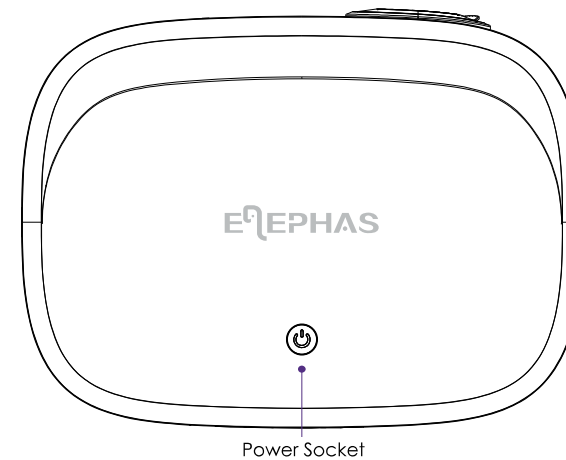

Remote Control

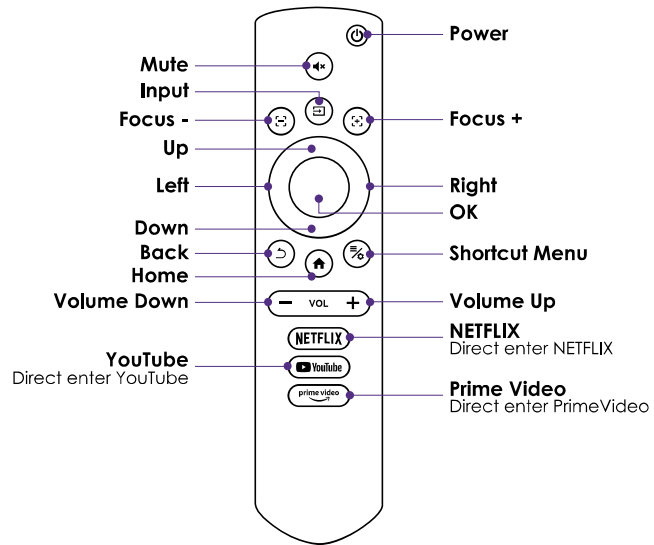

Attention:

1. Do not submerge the remote control in the water.
2. Do not put the remote control near fire or in wet or hot places.
3. Do not use old and new batteries together in the remote control.
4. Please take the batteries out if not using the remote control for a long time to avoid battery leakage.
5. Please point the remote control towards the IR receiver.
6. After connecting the remote control to Bluetooth, it can be used in an open area of 8 meters regardless of angle or please use the remote control within 20ft distance in 30 degree angle.
7. If this part is missing, please contact our customer service email address in the Quick Start Guide or contact the seller you bought this device.

Getting Started

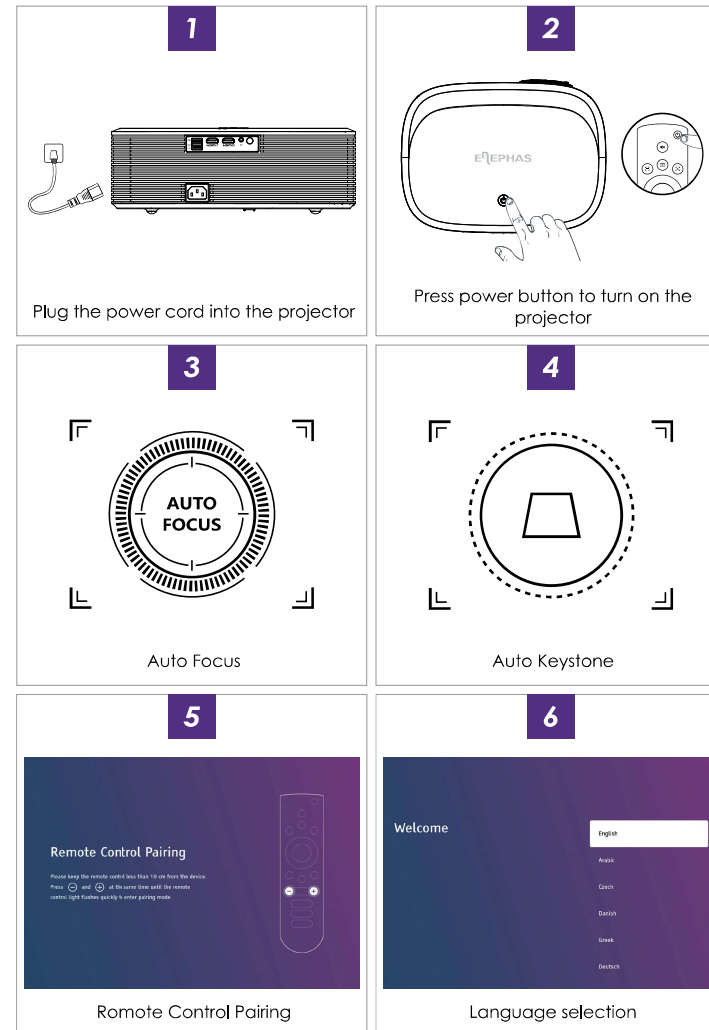

Connection

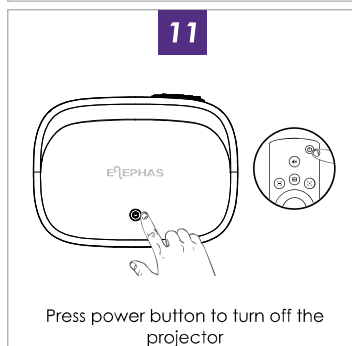
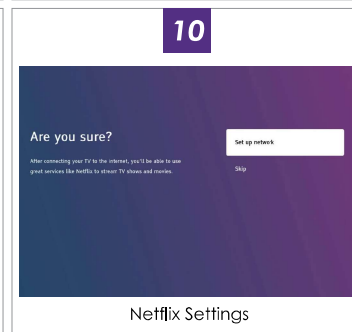
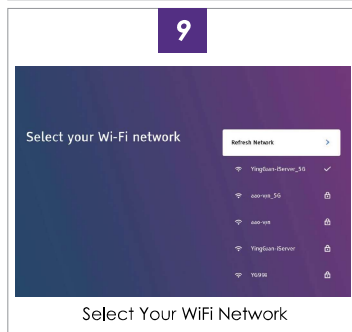
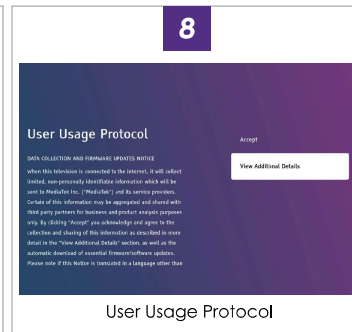
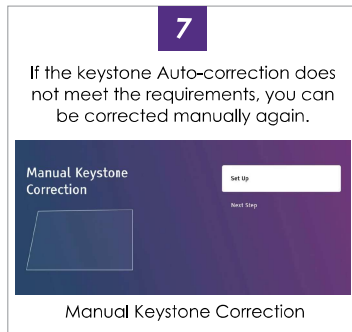

• Projector interface connection



Connect multiple devices and applications.

• **USB connection**

a. Insert the USB flash/storage hard drive into the USB port, and then select USB as the source from the menu (Resource Manager) or the USB icon in the upper right corner of the homepage.

(If the USB icon on the main screen shows success, it indicates a successful connection. If the USB icon on the interface is not displayed, you need to reinsert or check if the USB drive is faulty.)

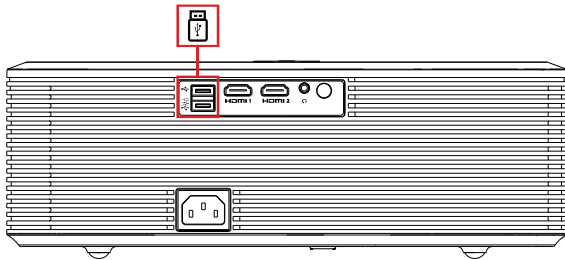

Support local decoding 4K [3840*2160] (H.265)

***USB-2 port is a 5V power supply port for charging.**

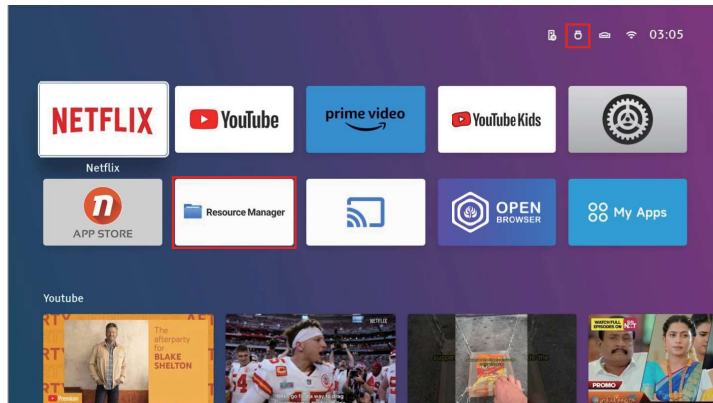

Supported multimedia formats

b. Choose the content which you need to play.

File	Format	Suffix	Decoding
Video Play	MPEG1	.DAT / .MPG / .MPEG	\
	MPEG2	.MPG	\
	MPEG4	.AVI / .MP4	DIVX,XVID
	RM\RMVB	.RM / .RMVB	RV8, RV9, RV10
	H264	.MKV / .MOV	H.264
	HEVC / H.265	.MKV / .MP4	✓
	MJPEG	.AVI	\
	DIVX	.DIVX / .AVI	MPEG, DIVX, H264
Picture Play	FLV	.FLV	H264
	JPEG	.JPG	✓
	BMP	.BMP	✓
Audio Play	PNG	.PNG	✓
	MP3	.MP3	✓
	M4A	.MP4	✓

• HDMI connection

- Insert the HD port to connect computer and HD-compatible devices.
- Press the () button on the remote control and select the corresponding HD signal source (1/2) from the menu.

Note: After connecting to HDMI, the system will automatically recognize HD access for playback, and you can also cancel automatic playback in HD settings.

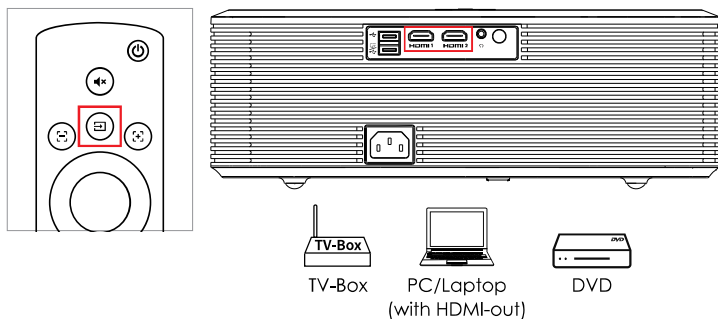

HDMI

The terms HDMI and HDMI High-Definition Multimedia Interface, and the HDMI Logo are trademarks or registered trademarks of HDMI Licensing Administrator, Inc. in the United States and other countries.

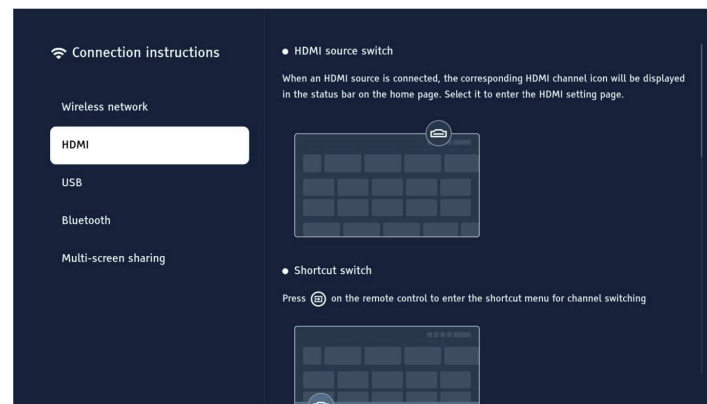
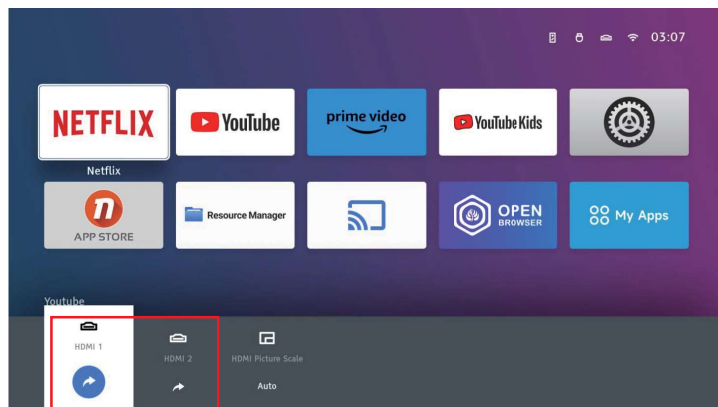

Tips:

- Mini Display Port to HDMI Cable, Thunderbolt to HDMI Adapter are needed to be compatible with Apple iMac, MacBook, Surface, and ThinkPad.
- Supported resolution:
576P, 480P, 720P, 1080P, 640x480, 800x600, 1024x768, 1280x1024, 1280x720, 1440x900, 1366x768, 1920x1080, 1280x800, 1440x960, 680x1050

• 3.5mm audio connection

a. Use a 3.5mm audio jack to connect headphones and speaker equipment.

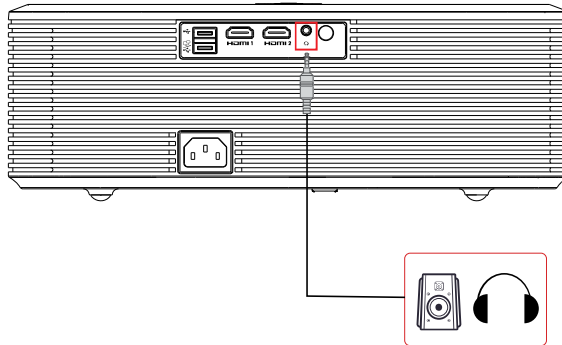

* This projector supports Dolby sound.

BT Connection

Step1. Enter homepage and select "Settings".

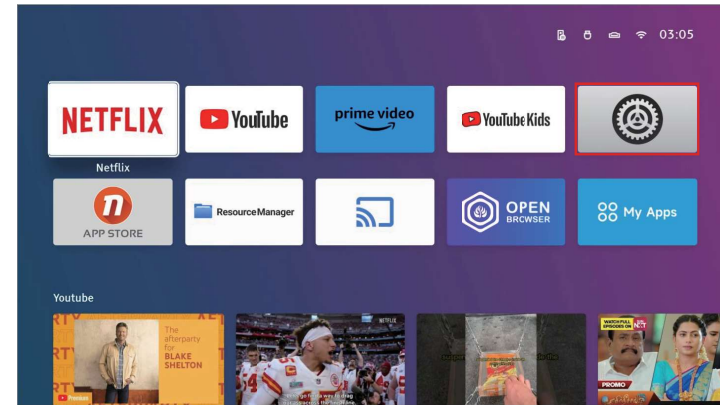

Step2. Choose the corresponding BT device.

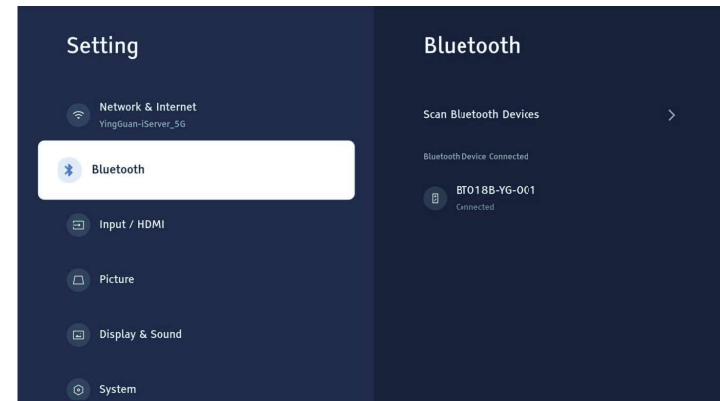

* The displayed BT device is a remote control, please do not delete it. It can be used normally after connecting to your own BT device.

Supported Apps

Only supports downloading existing applications within the app, not currently supported for others, and the app location can be adjusted according to your needs after downloading.

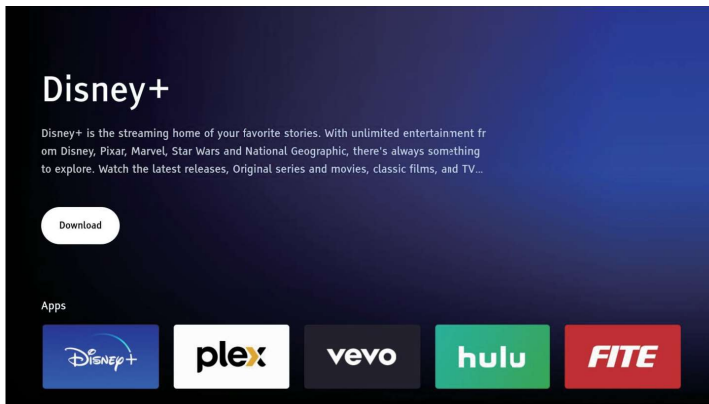
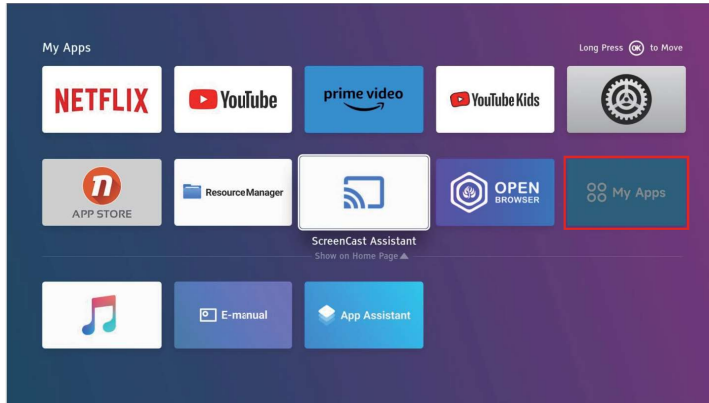

WiFi Wireless Screen Mirroring

• For iPhone/iPad/iPod touch (iOS system)

Streaming with your WiFi (wireless connection)

Step 1. Turn on the projector and select the projection assistant.

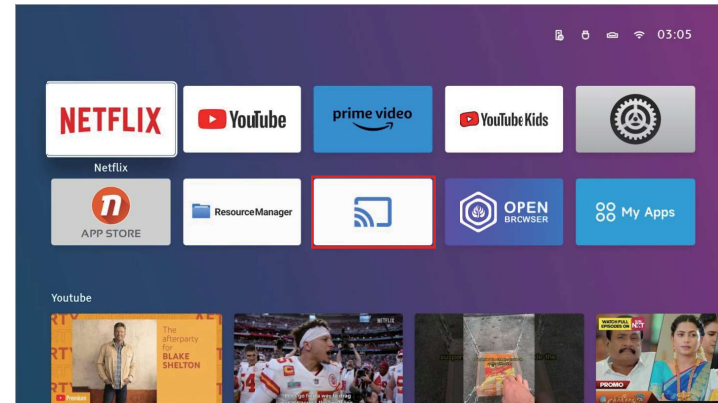

Step 2. Go to the  MagicCast and Select "Go to Download"

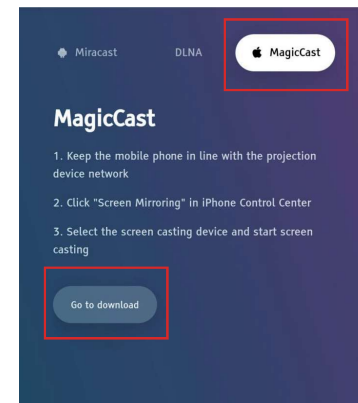

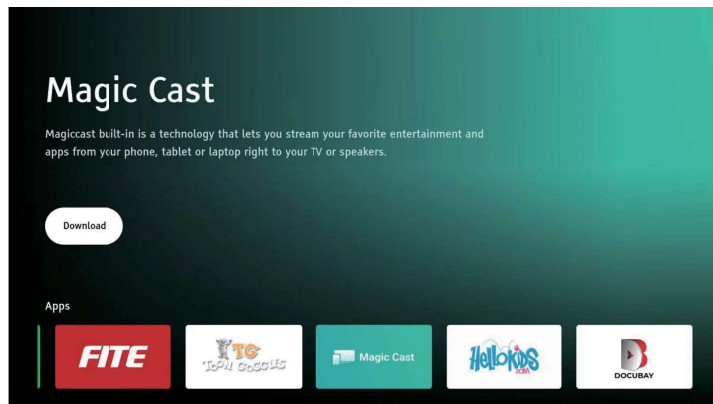

Step 3. After successful download. Connect your iPhone/iPad to the same WiFi. Open "Screen Mirroring" on your device and click "AAO-PRJ" to connect.



• Wireless connection to Android system

To use this function, your Android device must support the Multi-screen/ Wireless display.

Step 1. Turn on the projector and select the projection assistant.

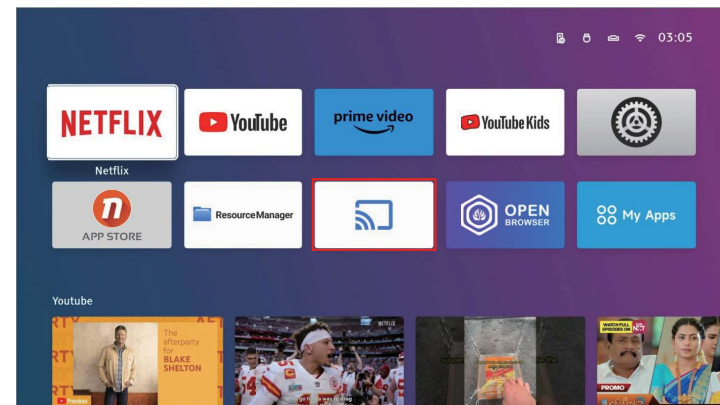

Step 2. Select "Miracast".

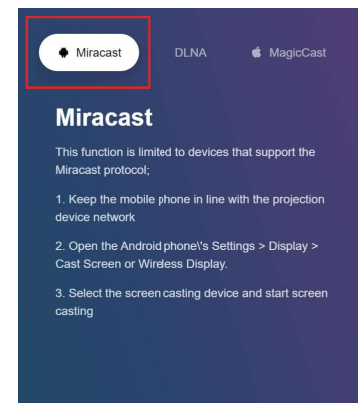

Step 3. Go to the Android device "Settings" and select your WLAN.

Step 4. Activate Multi-screen function in your Android device and search for the projector, select "AAO-PRJ" and click to connect. Your Android device display will be projected to the wall / screen after a successful connection.

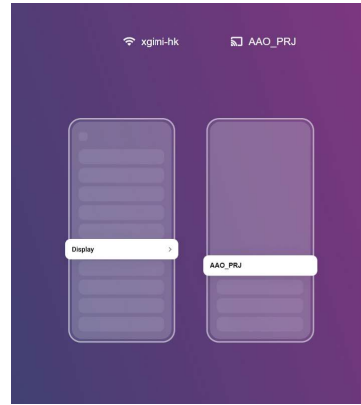

Please note:

1. Make sure your mobile device is within 3 ft distance from the projector when using wireless connection.
2. Some mobile devices do not support screen mirroring.

• Wireless Projection for DLNA

Step 1. Turn on the projector and select the projection assistant.

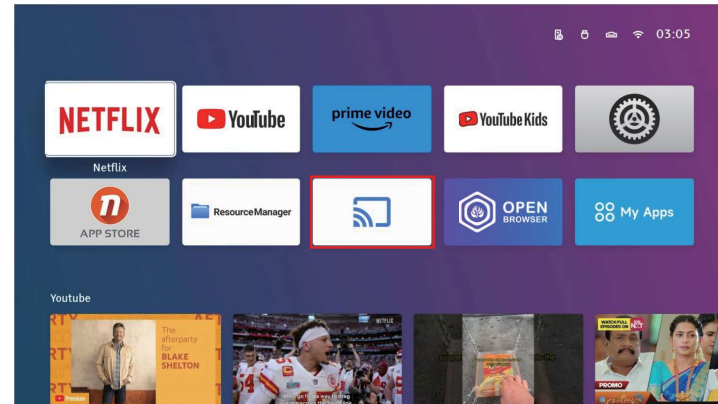

Step 2. Select "DLNA"

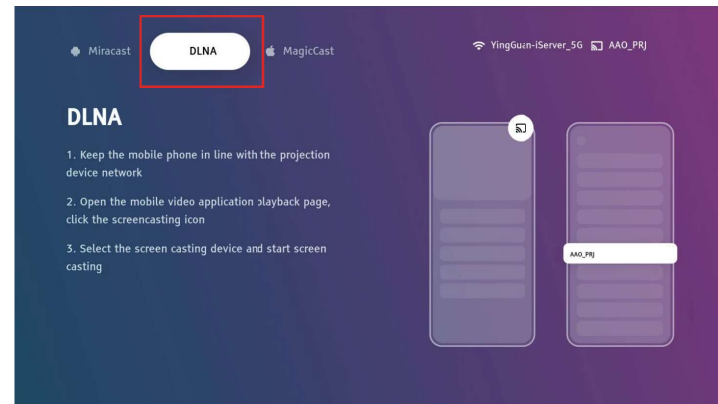

Step 3. Open the mobile video application playback page, click the screencasting icon.

Step 4. Select the screen casting device and start screen casting.

Note: The screen projection function is determined by the mobile player, and some videos cannot be played due to copyright issues.

Projector Installation

• Place your projector on the ceiling

1. When installing the projector on the ceiling, please purchase a projector bracket recommended by an installation professional and follow the instructions supplied with the bracket.

2. Before installing the projector on the ceiling, please check if the mounting structure can support the weight of the projector and the bracket. If in doubt, please consult the advice of an installation.

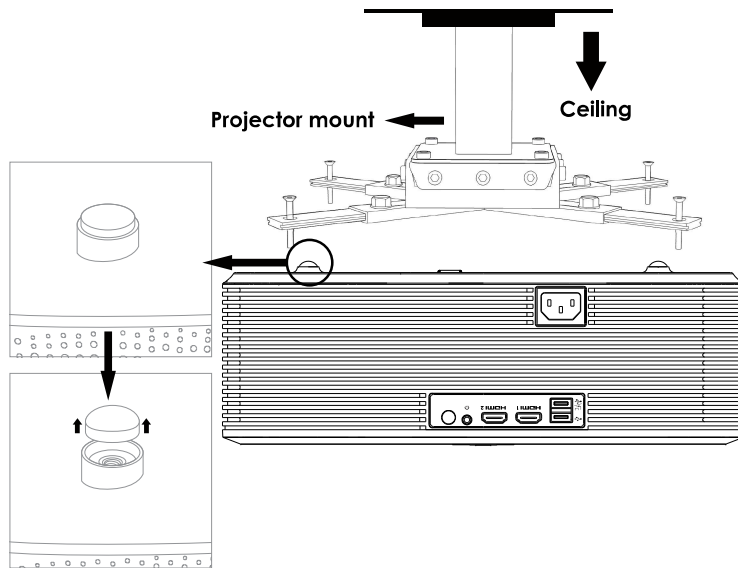

Fixed Hanger Screw Hole Type: 1/4 inch (M4*4).

NOTE: Projector bracket and screw (s) are not included.

Menu Settings

• Projection Settings

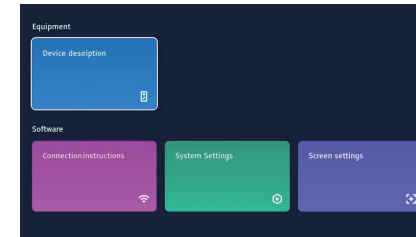

WiFi Setting	Option
WiFi	ON / OFF

BT Setting	Option
BT	ON / OFF

Projection Image Setting	Option
Projection Mode	Front-Desktop / Rear-Ceiling / Rear-Desktop / Front-Ceiling
Digital Zoom	50%-100%
Motor Focusing	Auto Focus & Auto Keystone

Note:

If the image is distorted, it can be adjusted (autofocus) by moving the projector or adjusting the placement distance to make the image rectangular.

System Update	Option
Online Update	/
Local Update	/
Restore Factory	Restore the factory default setting

Projection Image Setting	Option
Boot Source Option	Off / HDMI1 / HDMI 2
Power On Option	Standby / Direct
Language Setting	Multilingual Settings
Scheduled Shutdown	Off / 10min / 20min / 30min / 60min / 120min

Unload The Dust Net And Clear

Step1. Take out dust net from the projector bottom.

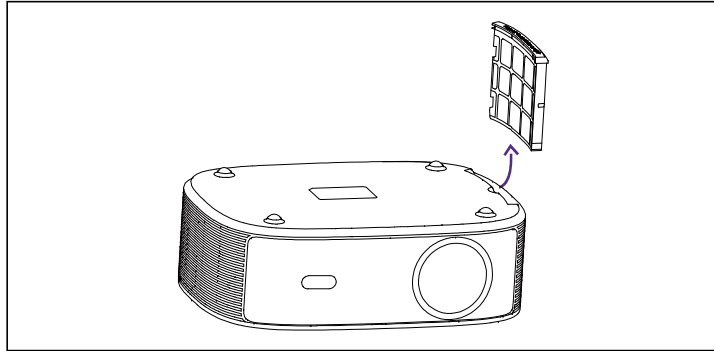

Step2. Clean the dust net.

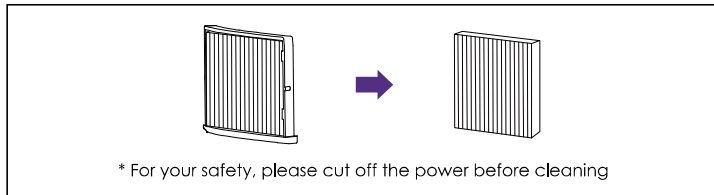

Step3. Align the bottom bayonet and install the dust net.

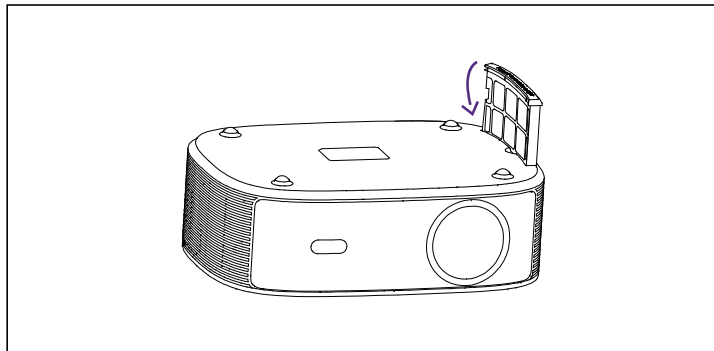

Technology Features

Parameters

Model NO.	YG691 Movin	Native Resolution	1920 * 1080 Pixels
Light Source	LED Projector	Focus Mode	Auto Focus & Auto Keystone
Projection Distance	1.3 - 5.3 Meters	Projection Screen Size	45 - 200 Inches
Aspect Ratio	16 : 9, 4 : 3 & Auto - Fit	Power Input	100 ~ 240V / 50 - 60Hz
Input Modes	USB 2.0 * 2 / HDMI * 2	Audio Output	3.5mm Stereo Jack
Built-in Speaker	7W * 2	Unit Size	328 * 239 * 108 MM
WiFi Frequency Band	2.4G / 5G	\	\

Projection Distance and Screen Size

Recommended Projection Distance: 45 — 200 inches

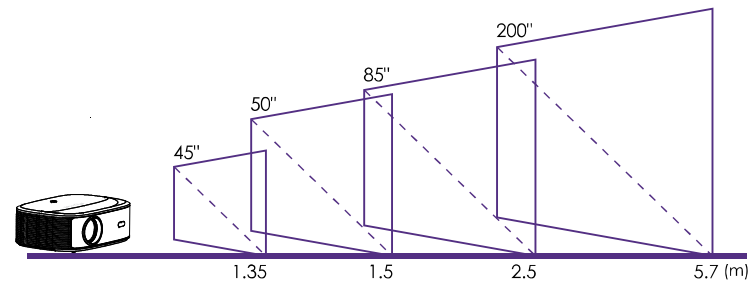

NOTE: Because the optical device has about 3% error, the above data is for reference only, please install the projector according to the actual measurement.

Questions & Answers

*Problems listed below might occur during the operation of your projector. Please refer to the possible factors which might cause the issue to do troubleshooting. Any questions during use, please feel free to contact our customer service team.

[Audio]Q: Why is the display of the projector available but without audio?

- A1:** The projector or the connected device (PC, TV, etc.) is muted.
A2: The video format is not supported by the projector.

[Audio]Q: Why is the audio of the projector available but without display?

- A1:** The video format is not supported by the projector.
A2: Encryption applied to the videos or media player which holds the video.
A3: If the lamp of the projector is off with only audio playing, the lamp is defective. Please contact our customer service team for a replacement.
A4: Try another HDMI cable if you select the HDMI Input Source.
A5: Try YouTube if your screen mirroring player is Netflix, Amazon Prime, Hulu or Disney+. The problem will happen when playing these applications because of copyright.

[Audio]Q: Video playback is out of sync with sound and picture?

- A1:** The fluency of playing is related to the network; If you are connected to a BT device, it generally has a delay display.

[Signal]Q: Why does the projection screen show "No Signal"?

- A1:** Make sure all cables are plugged correctly and firmly.
A2: Make sure you select the right input source. For example, if you connect with phone. Please follow the "Connections" section in the manual.

[Image]Q: How can I do if the image is blurry or out of shape?

- A1:** Adjust the focus by pressing the "⏏ / 🔍" button till it shows the correct image.
A2: Place the projector on a flat surface horizontally or vertically. An inclination at any angle may result in blurry displays or uneven colors.
A3: Darker environment suggested achieving the best pro cine performance.
A4: The best distance of 1.3 - 2.5m / 42.5 inch - 63.5 inch between the projector and projecting screen / wall.
A5: Projecting wall or screen is clean white if possible.

[Image]Q: How can I do if the image is upside down?

- A1:** Press the "Menu" on the remote to enter Settings. Then, select "Picture". Then, select "Projection Mode" and choose "Front".

[Image]Q: How can I do if the projection screen is not square or allied horizontally?

- A1:** Make sure the projector is placed on a flat surface with a projector light in the middle of the screen.
A2: Make sure the projector screen is placed horizontally.

[Image]Q: How can I do if there is color distortion?

- A1:** Make sure the video source has a fine resolution.
A2: Adjust the colors: enter Setting — Display and sound — Display — Video screen mode — Temperature. Then select different modes and adjust the value accordingly.
A3: Reset the projector to manufacturer setting: enter Setting — System — Restore Factory Default to reset.

[Image]Q: How can I do if there is a line / blurry screen in the projection picture?

- A1:** Please restart it to see if it can be solved. The line / blurry screen is caused by the motherboard or screen.
A2: If you can't solve it, please contact our customer service team for help.

[Image]Q: Can this project directly onto a wall? How's the projection performance?

- A1:** Yes, it can, but it should be a flat wall (preferably white). Otherwise, you may experience poor projection quality.

[Setting]Q: How can I change the language?

- A1:** For projector: enter Setting — System Setting — Language.

[Shut Off]Q: Why does the projector is shut off during playing?

- A1:** Make sure the power plug is working and firmly fitted into the outlet.
A2: If the fan doesn't work when using it, please contact our customer service team for assistance.
A3: Overheat on the projector will activate the built-in power-off protection panel. Restart the projector when it gets cooler.

[USB]Q: Why doesn't anything work in the main interface, especially with external storage connected?

A1: The USB larger than 64GB is not supported by the projector.

A2: The video format is not supported by the projector.

[3D]Q: Can this projector support 3D effect?

A1: The projector does not support 3D video sources.

[Remote Control] Q: How can I do if the remote is unresponsive?

A1: Make sure the batteries are installed correctly and the power is enough.

A2: Please make sure the IR receiver is not covered.

A3: Contact our customer service team for a replacement.

[Remote Control] Q: How to pair the BT remote control with the projector?

A1:

1. Please ensure that the remote control is within 10 cm from the device.
2. Press the "Volume -" and "Volume +" buttons on the remote control at the same time until the remote control icon appears on the home page.
3. For details, please refer to the picture of the remote control pairing steps in the manual.

[Remote Control] Q: Is the remote control slow to respond to commands?

A1: This remote control has two modes.

Mode A: When the icon on the remote control appears on the homepage, it indicates that Bluetooth is connected and can be used freely in an open area within 8 meters.

Mode B: When the icon on the remote control disappears, it indicates that Bluetooth has exited, please use the remote control within 20ft distance in 30 degree angle.

[Connection]Q: The projector port is insensitive?

A1: Try to replace the cable. If it can't be solved, contact our customer service team for help.

[Wifi Connection]Q: Can not connect with the WIFI?

A1: Please ensure you are in the projector user interface.

A2: Check your password, is it correct?

A3: Contact our customer service team for help.

[BT Connection]Q: Is it compatible with external BT speakers?

A1: Yes, the projector is compatible with external BT devices. Before connecting the projector to an external BT device, please enter the projector user interface.

(Please follow the "BT Connections" section in the manual.)

[Auto Focus]Q: How to trigger autofocus on the ELEPHAS W1K home theater projector?

A1: Please slightly move the device or press the "⏪ / ⏩" button on the remote

to trigger autofocus. When the autofocus box occurs on the screen, you can also press the "⏪ / ⏩" button to manually adjust the focus.

A2: If the problem is still not solved, please feel free to ask the seller for help.

[Screen Mirroring]Q: How to screen mirror iOS devices to the projector?

A1:

1. Please select the projection assistant on the homepage.
2. Go to the iOS  MagicCast and Select "Go to Download".
3. After successful download, use the Airplay feature to mirror any iPhone / iPad / Macbook using the same WiFi connection.

[Screen Mirroring]Q: How to mirror screen Android devices to the projector?

A1:

1. Please select the projection assistant on the homepage.
2. Select  "Miracast".
3. Go to the Android device "Settings" and select your WLAN.
4. Activate Multi-screen function in your Android device and search for the projector, select "AAO-PRJ3456" and click to connect.

[Screen Mirroring]Q: The video cannot be mirrored to the projector. There is sound but no picture when is screen mirroring. Or there is no picture and no sound?

A1:

1. Please note that copyrighted videos, such as those "Amazon Prime", "YouTube", "Hulu", "Netflix", "Disney+" or other popular streaming services, cannot be mirrored on the same screen.

PS: (Prime, Hulu, Netflix, Disney +) streaming media with a copyright can try to play the same screen on the web page.

2. Is the source resolution too high? (For example 4k, 8k); And the video refresh rate exceeds 60hz?

Please note that the projector only supports 60Hz and the video source cannot exceed 1080P.

[Screen Mirroring]Q: Screen mirror jam, frame drop, delay, automatic disconnection?

A1: The smoothness of the screen image is related to the quality of the network.

[Mounting]Q: What kind of Screws do I need for mounting this projector?

A1: M4, 1/ 4inch (ca. 4mm).

[Cable]Q: What kind of cable do I need when connecting TV BOX, TV, Firestick, and DVD player to the projector?

A1: HDMI cable for all devices mentioned above. Certain DVD players require an AV cable connection.

[Lamp]Q: Why doesn't the projector's lamp light up or power on?

A1: Please contact our customer service team for help.

[HDMI Connection]Q: Why does the projector show "No Signal" when HDMI connects with the device?

A1: Please read the instructions for the HDMI adapter carefully before connecting.

A2: Please make sure to use the original cable, check the correct HDMI ports, or any damage to the cable.

A3: Contact our customer service team for help.

[MAC]Q: No sound from the MAC-connected projector?

A1: Select apple menu > system preferences, and then click sound. In the output panel, make sure your input is correctly selected.

A2: If you use the mini DisplayPort converter to connect, make sure your Mac can connect via mini DisplayPort and sends audio.

A3: If you are connecting from the Mac mini, unplug any audio device that is connected to the computer audio output port.



ACTIVATE YOUR 12-MONTH WARRANTY & CUSTOMER SERVICE

by choosing one of the following two options:

Option 1

Please visit our website and register:

 <https://www.top-elephas.com/>

Option 2

Please scan the below code and contact us:



SCAN ME

Also, you can scan the above code for more operation videos.

FCC warning statements:

This equipment has been tested and found to comply with the limits for a Class B digital device, pursuant to part 15 of the FCC Rules. These limits are designed to provide reasonable protection against harmful interference in a residential installation. This equipment generates, uses and can radiate radio frequency energy and, if not installed and used in accordance with the instructions, may cause harmful interference to radio communications. However, there is no guarantee that interference will not occur in a particular installation. If this equipment does cause harmful interference to radio or television reception, which can be determined by turning the equipment off and on, the user is encouraged to try to correct the interference by one or more of the following measures:

- Reorient or relocate the receiving antenna.
- Increase the separation between the equipment and receiver.
- Connect the equipment into an outlet on a circuit different from that to which the receiver is connected.
- Consult the dealer or an experienced radio/TV technician for help.

Caution: Any changes or modifications to this device not explicitly approved by manufacturer could void your authority to operate this equipment.

This device complies with part 15 of the FCC Rules. Operation is subject to the following two conditions: (1) This device may not cause harmful interference, and (2) this device must accept any interference received, including interference that may cause undesired operation.

The device has been evaluated to meet general RF exposure requirement This equipment complies with FCC radiation exposure limits set forth for an uncontrolled environment.

This equipment should be installed and operated with minimum distance 20cm between the radiator & your body.