

## FCC/IC - TEST REPORT

Report Number : **68.950.21.0338.01** Date of Issue: **2021-05-25**

Model : **B181**

FCC ID : **2AZEQ-B181**

IC : **27102-B181**

Product Type : **Earphone**

Product name : **ear(1)**

Applicant : **NOTHING TECHNOLOGY LIMITED**

Address : **11 Staple Inn, London, WC1V 7QH, United Kingdom**

Manufacturer : **NOTHING TECHNOLOGY LIMITED**

Address : **11 Staple Inn, London, WC1V 7QH, United Kingdom**

Test Result :  **Positive**  **Negative**

Total pages including Appendices : **34**

*Any use for advertising purposes must be granted in writing. This technical report may only be quoted in full. This report is the result of a single examination of the object in question and is not generally applicable evaluation of the quality of other products in regular production. For further details please see testing and certification regulation, chapter A-3.4.*



# 1 Table of Contents

1	Table of Contents .....	2
2	Details about the Test Laboratory.....	3
3	Description of the Equipment under Test .....	4
4	Summary of Test Standards.....	5
5	Summary of Test Results.....	6
6	General Remarks .....	7
7	Test Setups .....	8
8	Systems test configuration.....	9
9	Technical Requirement .....	10
9.1	Conducted peak output power.....	10
9.2	6dB bandwidth .....	12
9.3	99% bandwidth .....	14
9.4	Power spectral density.....	16
9.5	Spurious RF conducted emissions .....	18
9.6	Band edge .....	23
9.7	Spurious radiated emissions for transmitter .....	25
10	Test Equipment List.....	33
11	System Measurement Uncertainty .....	34

## 2 Details about the Test Laboratory

### Details about the Test Laboratory

#### Test Site 1

Company name: TÜV SÜD Certification and Testing (China) Co., Ltd. Shenzhen Branch  
 Building 12&13, Zhiheng Wisdomland Business Park,  
 Nantou Checkpoint Road 2, Nanshan District,  
 Shenzhen City, 518052,  
 P. R. China

FCC Designation Number: CN5009

FCC Registration No.: 514049

IC Registration Number: 10320A

Telephone: 86 755 8828 6998  
 Fax: 86 755 8828 5299

#### Report Version:

Revision	Release Date	History/Memo.
N/A	2021-05-25	Initial Release

### 3 Description of the Equipment under Test

Product:	ear(1)
Model no.:	B181
FCC ID:	2AZEQ-B181
IC:	27102-B181
PMN:	ear(1)
HVIN:	B181R
Rating:	3.7V
RF Transmission Frequency:	2402MHz-2480MHz
No. of Operated Channel:	40
Modulation:	GFSK
Antenna Type:	Internal antenna
Antenna Gain:	-3dBi max for 2.4GHz
Description of the EUT:	The Equipment Under Test (EUT) is Earphone with Bluetooth Low Energy/Bluetooth BDR+EDR functions.

## 4 Summary of Test Standards

Test Standards	
FCC Part 15 Subpart C 10-1-2020 Edition	PART 15 - RADIO FREQUENCY DEVICES Subpart C - Intentional Radiators
RSS-Gen Issue 5, Amendment 2, February 2021	General Requirements and Information for the Certification of Radio Apparatus
RSS-247 Issue 2 February 2017	Digital Transmission Systems (DTSS), Frequency Hopping Systems (FHSS) and License-Exempt Local Area Network (LE-LAN) Devices

All the test methods were according to KDB558074 D01 v05r02 DTS Measurement Guidance and ANSI C63.10 (2013).

## 5 Summary of Test Results

Technical Requirements				
FCC Part 15 Subpart C/ RSS-247 Issue 2/RSS-Gen Issue 5				
Test Condition			Test Site	Test Result
§15.207	RSS-GEN 8.8	Conducted emission AC power port	--	N/A
§15.247 (b) (1)	RSS-247 Clause 5.4(d)	Conducted peak output power	Site 1	PASS
§15.247(a)(1)	RSS-247 Clause 5.1 (b)	20dB bandwidth	---	N/A
§15.247(a)(1)	RSS-247 Clause 5.1(b)	Carrier frequency separation	---	N/A
§15.247(a)(1)(iii)	RSS-247 Clause 5.1(d)	Number of hopping frequencies	---	N/A
§15.247(a)(1)(iii)	RSS-247 Clause 5.1(d)	Dwell Time	---	N/A
§15.247(a)(2)	RSS-247 Clause 5.2(a) & RSS-GEN 6.7	6dB bandwidth and 99% Occupied Bandwidth	Site 1	PASS
§15.247(e)	RSS-247 Clause 5.2(b)	Power spectral density	Site 1	PASS
§15.247(d)	RSS-247 Clause 5.5	Spurious RF conducted emissions	Site 1	PASS
§15.247(d)	RSS-247 Clause 5.5	Band edge	Site 1	PASS
§15.247(d) & §15.209 & §15.205	RSS-247 Clause 5.5 & RSS-GEN 6.13	Spurious radiated emissions for transmitter	Site 1	PASS
§15.203	RSS-GEN 6.8	Antenna requirement	See note 2	PASS

**Remark:**

Note 1: N/A=Not Applicable.

Note 2: The EUT uses a monopole antenna, which gain is -3dBi. In accordance to §15.203 and RSS-GEN 6.8, it is considered sufficiently to comply with the provisions of this section.

## 6 General Remarks

### Remarks

This submittal(s) (test report) is intended for FCC ID: 2AZEQ-B181, IC: 27102-B181, complies with Section 15.205, 15.209, 15.247 of the FCC Part 15, Subpart C and RSS-247 issue 2 and RSS-Gen issue 5 rules.

The Equipment Under Test (EUT) is Earphone with Bluetooth Low Energy/Bluetooth BDR+EDR functions.

This report is for the Bluetooth Low Energy part.

### SUMMARY:

All tests according to the regulations cited on page 5 were

- Performed

- **Not** Performed

The Equipment under Test

- **Fulfills** the general approval requirements.

- **Does not** fulfill the general approval requirements.

Sample Received Date: 2021-04-30

Testing Start Date: 2021-04-30

Testing End Date: 2021-05-14

- TÜV SÜD Certification and Testing (China) Co., Ltd. Shenzhen Branch –

Reviewed by:

Prepared by:

Tested by:

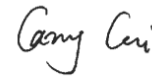

John Zhi  
Project Manager

Joe Gu  
Project Engineer

Carry Cai  
Test Engineer

## 7 Test Setups

### 7.1 Radiated test setups

Below 1GHz

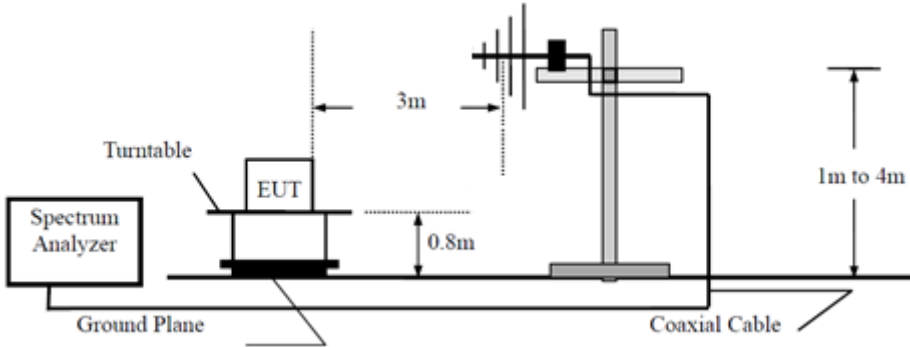

Above 1GHz

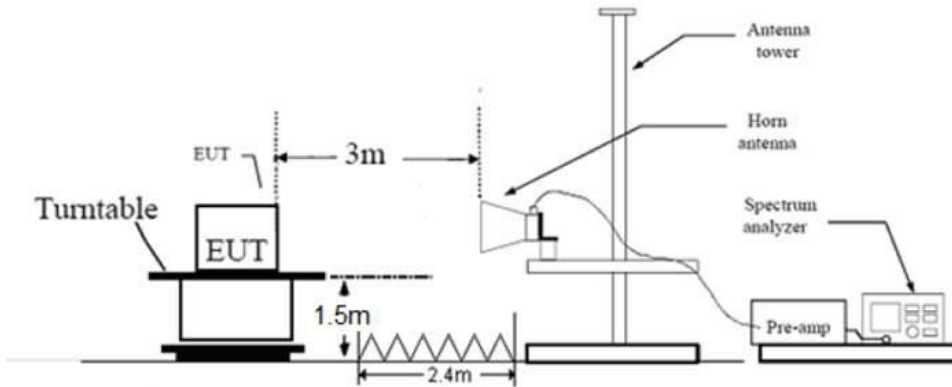

### 7.2 Conducted RF test setups

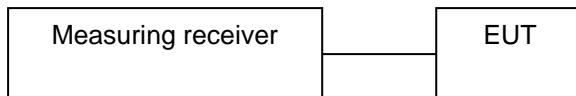



## 8 Systems test configuration

Auxiliary Equipment Used during Test:

Name	Model	Manufacturer	S/N	Cal Due Date
Notebook	X220	Lenovo	--	--

The system was configured to channel 0, 19, and 39 for the test.

## 9 Technical Requirement

### 9.1 Conducted peak output power

#### Test Method

1. The EUT was placed on 0.8m height table, the RF output of EUT was connected to the test receiver by RF cable. The path loss was compensated to the results for each measurement.
2. Use the following spectrum analyzer settings:  
RBW > the 6dB bandwidth of the emission being measured, VBW≥3RBW, Span≥3RBW  
Sweep = auto, Detector function = peak, Trace = max hold.
3. Allow the trace to stabilize. Use the marker-to-peak function to set the marker to the peak of the emission. The indicated level is the peak output power.

#### Limits:

Conducted peak output power:

Frequency Range MHz	Limit W	Limit dBm
2400-2483.5	≤1	≤30

For e.i.r.p:

Frequency Range MHz	Limit W	Limit dBm
2400-2483.5	≤4	≤36

Test result as below table

Frequency (MHz)	Conducted Peak Output Power (dBm)	Antenna Gain (dBi)	EIRP (dBm)	Result
Low channel 2402MHz	8.48	-3	5.48	Pass
Middle channel 2440MHz	8.05	-3	5.05	Pass
High channel 2480MHz	7.40	-3	4.40	Pass

### 2402MHz

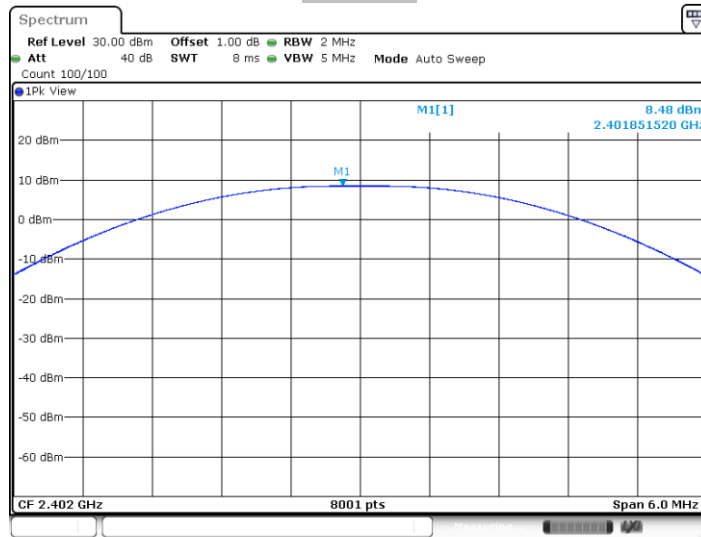

### 2440MHz

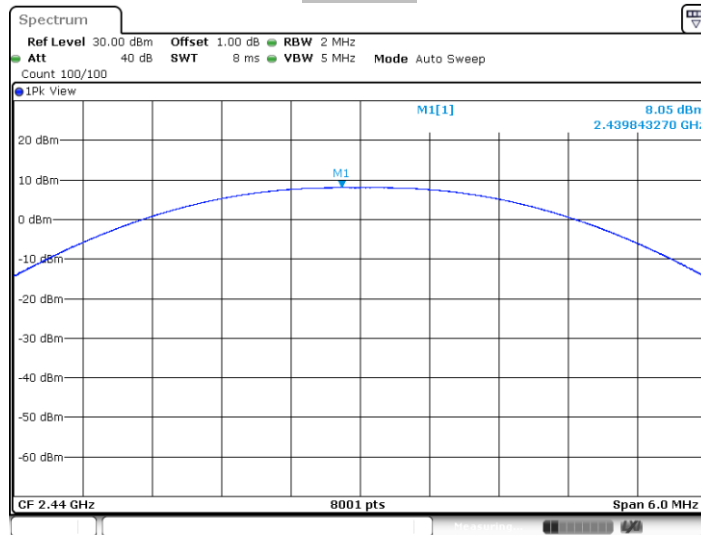

### 2480MHz

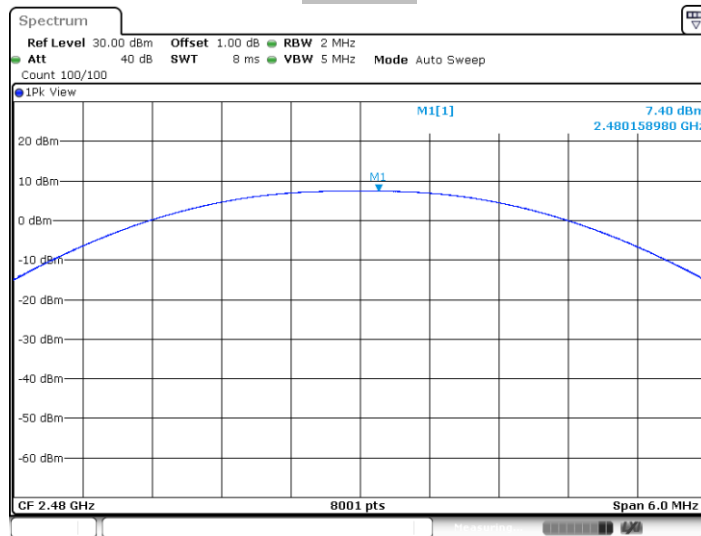

## 9.2 6dB bandwidth

### Test Method

1. Connect EUT test port to spectrum analyzer.
2. Use the following spectrum analyzer settings:  
RBW=100K, VBW≥3RBW, Sweep = auto, Detector function = peak, Trace = max hold
3. Use the automatic bandwidth measurement capability of an instrument, may be employed using the X dB bandwidth mode with X set to 6 dB, care shall be taken so that the bandwidth measurement is not influenced by any intermediate power nulls in the fundamental emission that might be ≥ 6 dB.
4. Allow the trace to stabilize, record the X dB Bandwidth value.

### Limit

Limit [kHz]

≥500

### Test result

Channel (MHz)	Result (MHz)	Limit (kHz)	Verdict
2402	0.660	≥500	PASS
2440	0.664	≥500	PASS
2480	0.664	≥500	PASS

### Test Graphs

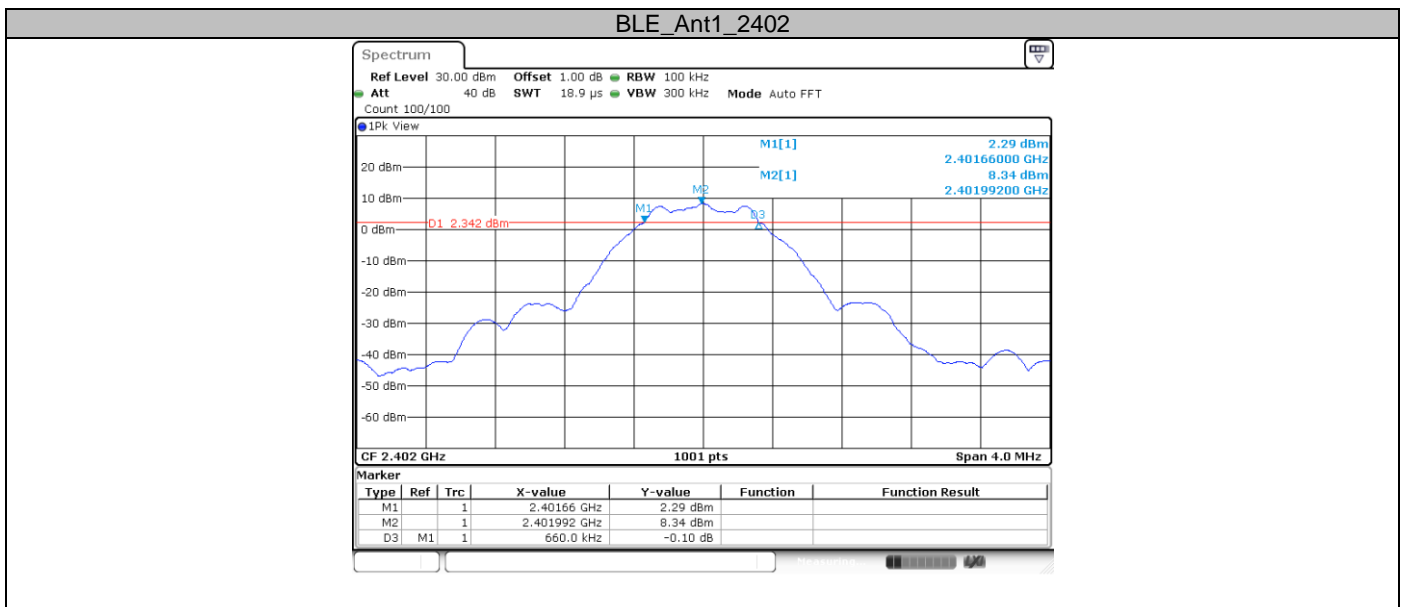

BLE\_Ant1\_2440

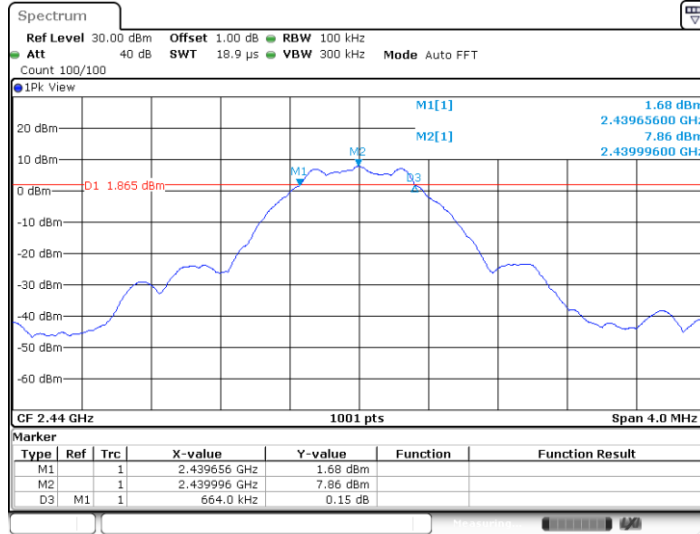

BLE\_Ant1\_2480

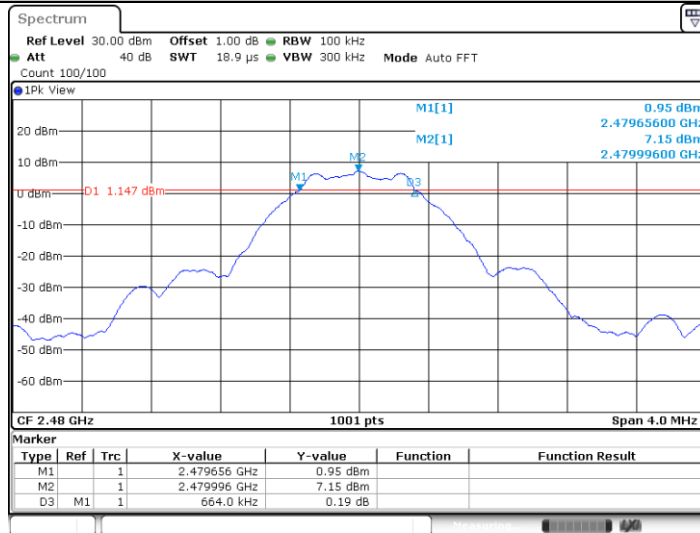

### 9.3 99% bandwidth

#### Test Method

1. Connect EUT test port to spectrum analyzer.
2. Use the following spectrum analyzer settings:  
 RBW=1% to 5% of the actual occupied, VBW $\geq$ 3RBW, Sweep = auto,  
 Detector function = peak, Trace = max hold
3. Use the automatic bandwidth measurement capability of an instrument, care shall be taken so that the bandwidth measurement is not influenced by any intermediate power nulls in the fundamental emission that might be  $\geq 6$  dB.
4. Allow the trace to stabilize, record the X dB Bandwidth value.

#### Limit

Limit [kHz]

---

--

#### Test result

Channel (MHz)	Result (MHz)	Limit	Verdict
2402	1.015	---	PASS
2440	1.015	---	PASS
2480	1.015	---	PASS

#### Test Graphs

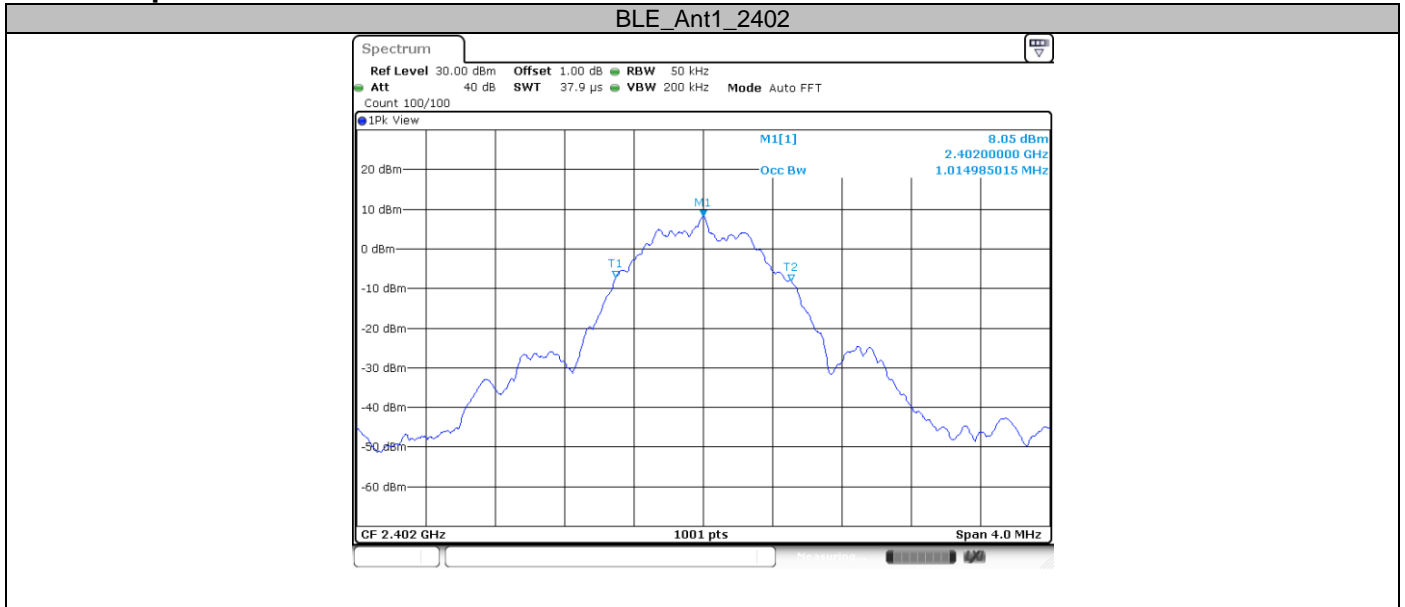

BLE\_Ant1\_2440

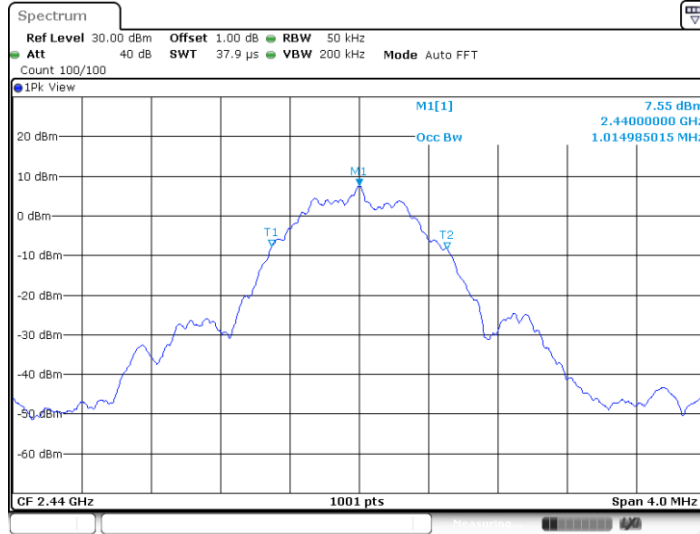

BLE\_Ant1\_2480



## 9.4 Power spectral density

### Test Method

This procedure shall be used if maximum peak conducted output power was used to demonstrate compliance:

1. The RF output of EUT was connected to the test receiver by RF cable. The path loss was compensated to the results for each measurement.
2. Set analyzer center frequency to DTS channel center frequency. RBW=3kHz, VBW≥3RBW, Span=1.5 times DTS bandwidth, Detector=Peak, Sweep=auto, Trace= max hold.
3. Allow trace to fully stabilize, use the peak marker function to determine the maximum amplitude level within the RBW.
4. Repeat above procedures until other frequencies measured were completed.

### Limit

Limit [dBm/3KHz]

≤8

### Test result

Channel (MHz)	Result (dBm/3KHz)	Limit(dBm/3KHz)	Verdict
2402	-6.73	8	PASS
2440	-7.44	8	PASS
2480	-8.12	8	PASS

### Test Graphs

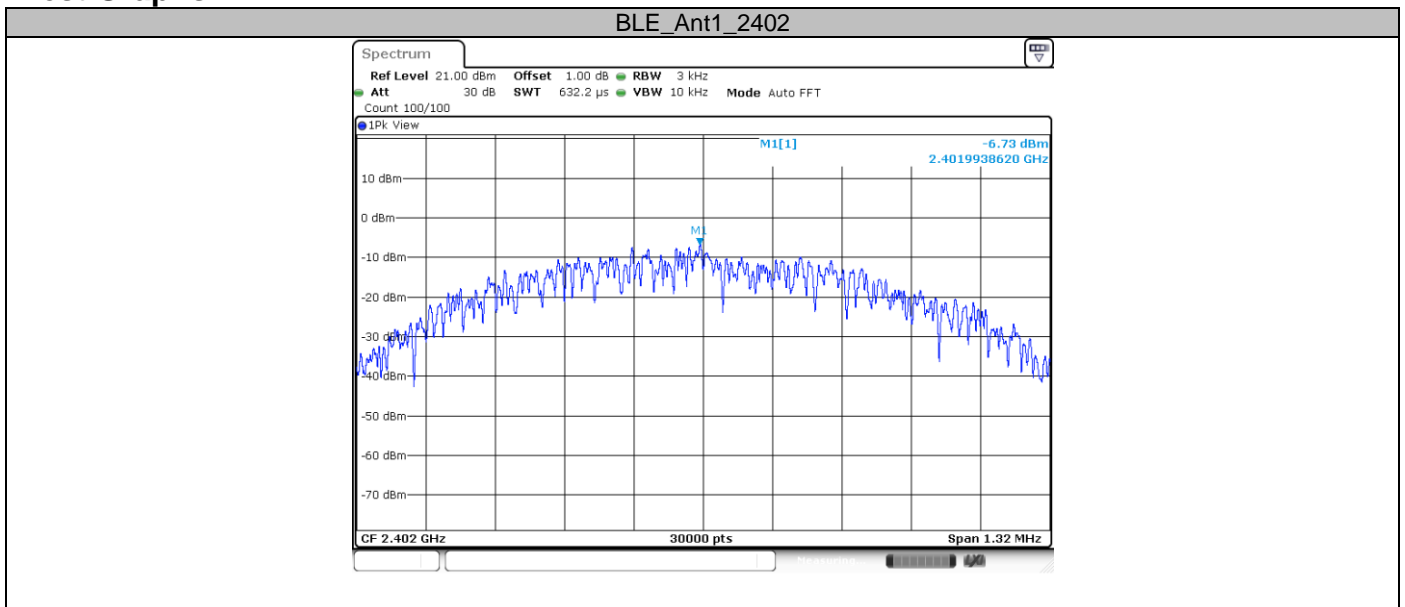



BLE\_Ant1\_2440

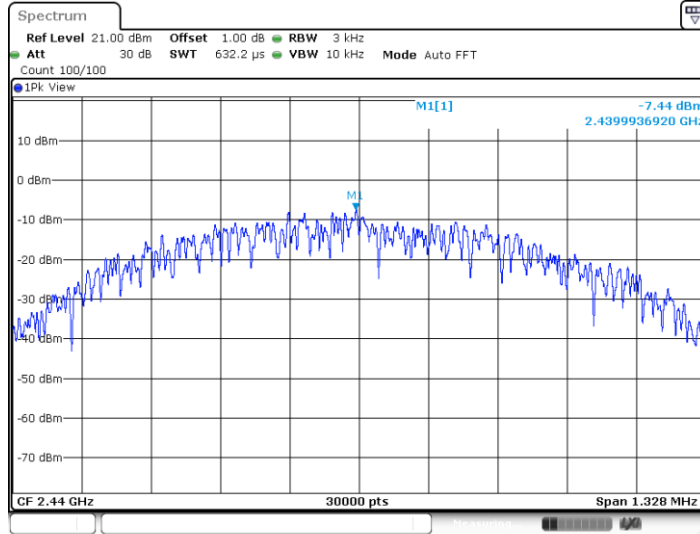

BLE\_Ant1\_2480

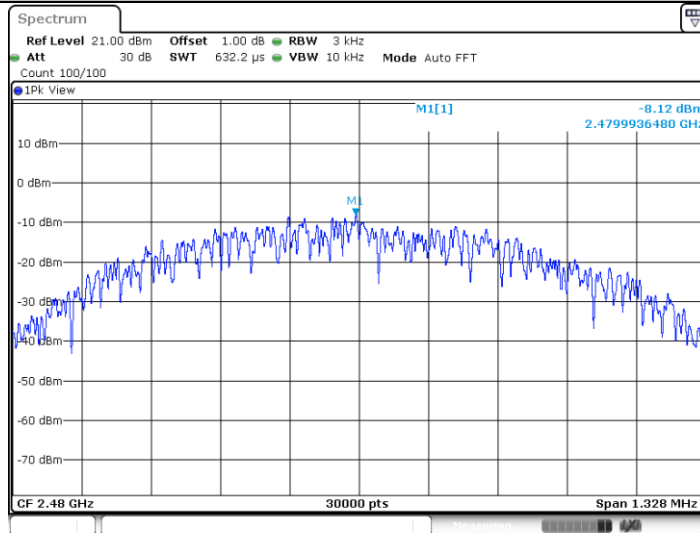

## 9.5 Spurious RF conducted emissions

### Test Method

1. The RF output of EUT was connected to the spectrum analyzer by RF cable. The path loss was compensated to the results for each measurement.
2. Use the following spectrum analyzer settings:  
Span = wide enough to capture the peak level of the in-band emission and all spurious emissions (e.g., harmonics) from the lowest frequency generated in the EUT up through the 10<sup>th</sup> harmonic. Typically, several plots are required to cover this entire span.  
RBW = 100 kHz, VBW ≥ RBW, Sweep = auto, Detector function = peak, Trace = max hold
3. Allow the trace to stabilize. Set the marker on the peak of any spurious emission recorded.
4. The level displayed must comply with the limit specified in this Section. Submit these plots.
5. Repeat above procedures until all frequencies measured were complete.

### Limit

Frequency Range MHz	Limit (dBc)
30-25000	-20

### Test Result

#### BLE\_BT4.0\_Ant1\_2402\_0~Reference

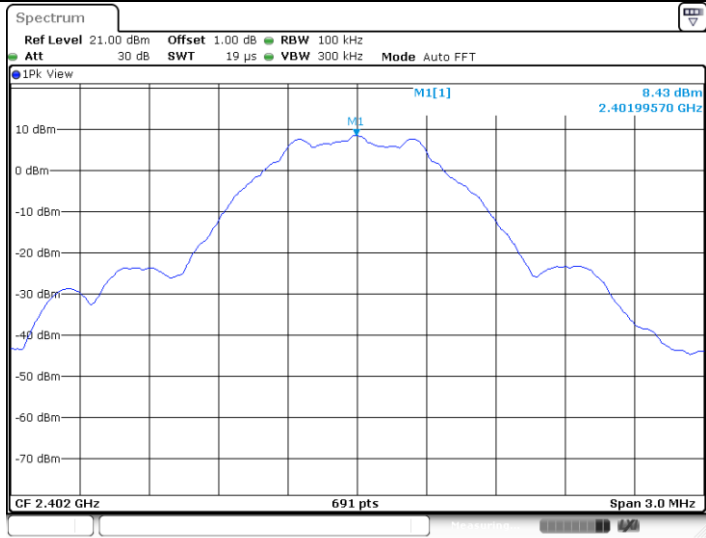

Date: 11.MAY.2021 18:59:38

#### BLE\_BT4.0\_Ant1\_2402\_30~1000

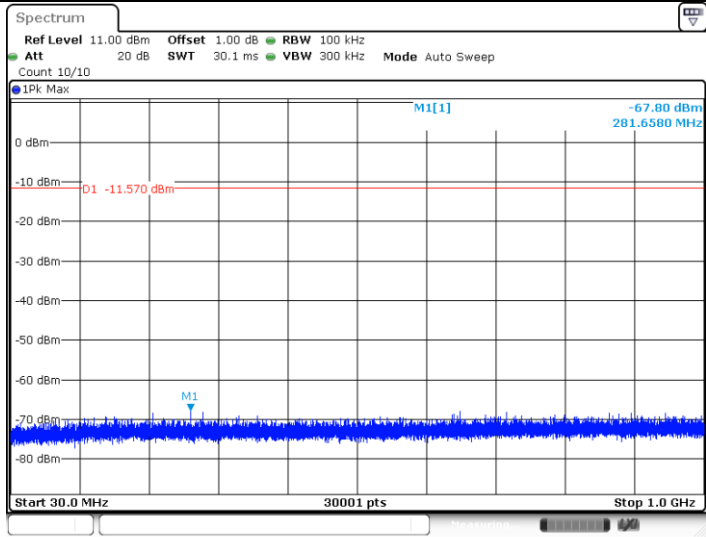

Date: 11.MAY.2021 18:59:44

BLE\_BT4.0\_Ant1\_2402\_1000~26500

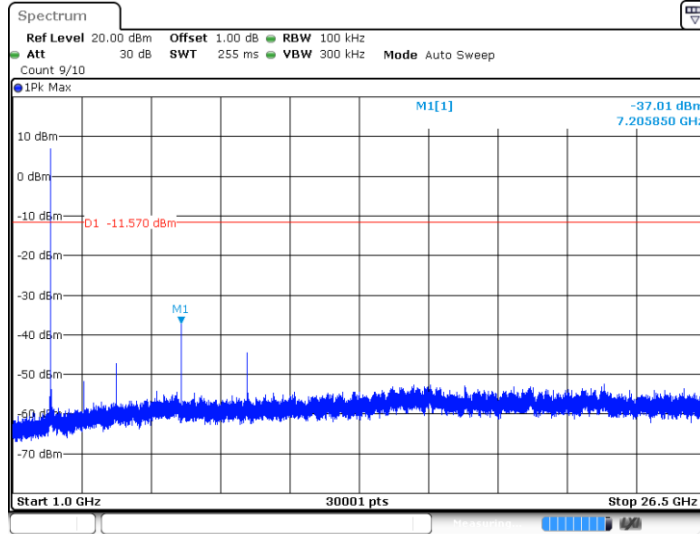

Date: 11.MAY.2021 18:59:52

BLE\_BT4.0\_Ant1\_2440\_0~Reference

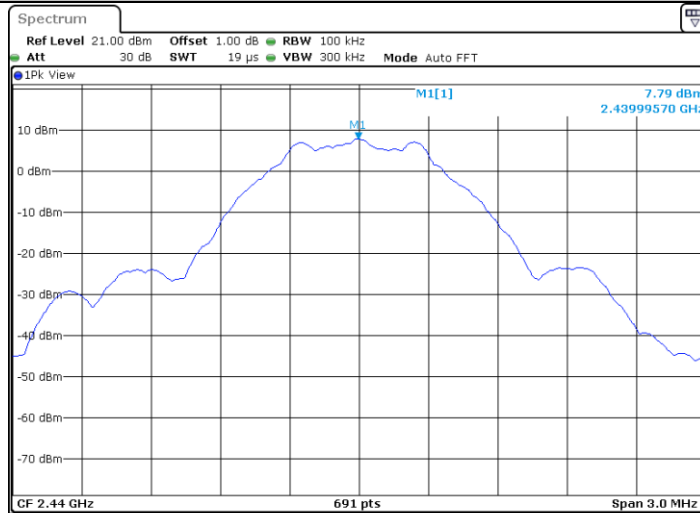

Date: 11.MAY.2021 19:01:20

BLE\_BT4.0\_Ant1\_2440\_30~1000

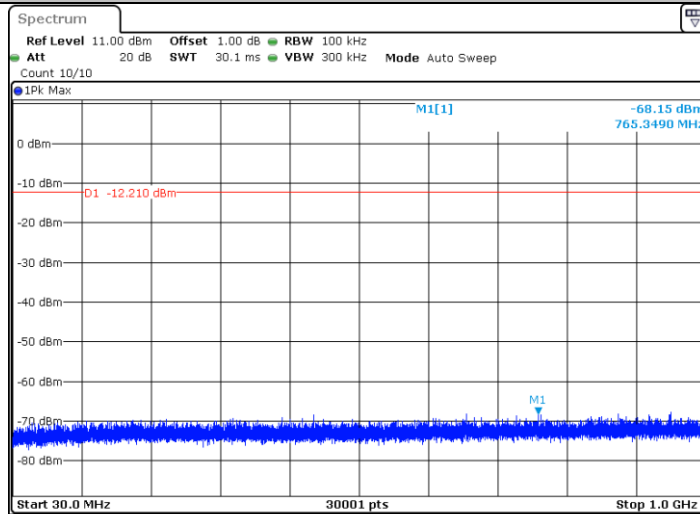

Date: 11.MAY.2021 19:01:26

BLE\_BT4.0\_Ant1\_2440\_1000~26500

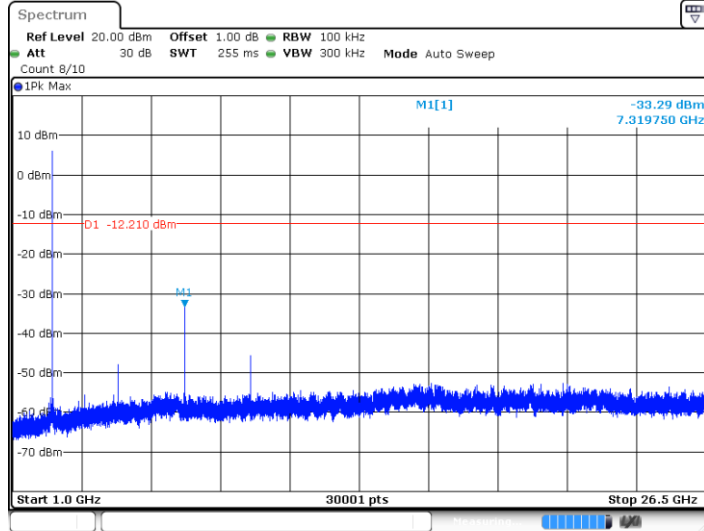

Date: 11.MAY.2021 19:01:34

BLE\_BT4.0\_Ant1\_2480\_0~Reference



Date: 11.MAY.2021 19:03:20

BLE\_BT4.0\_Ant1\_2480\_30~1000

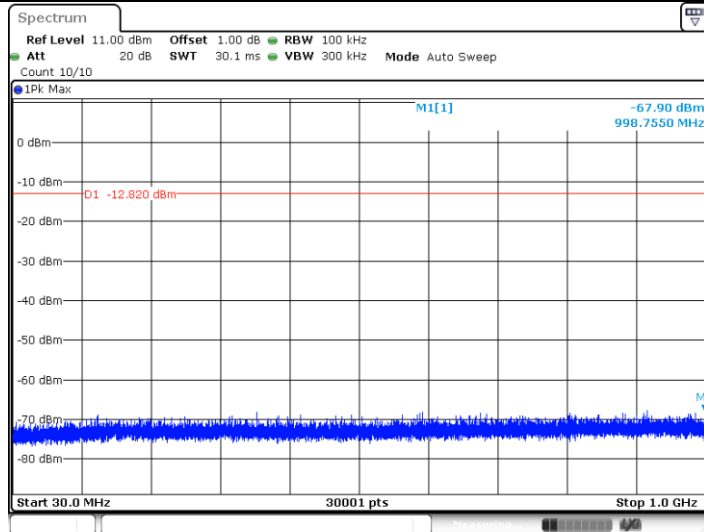

Date: 11.MAY.2021 19:03:26

BLE\_BT4.0\_Ant1\_2480\_1000~26500

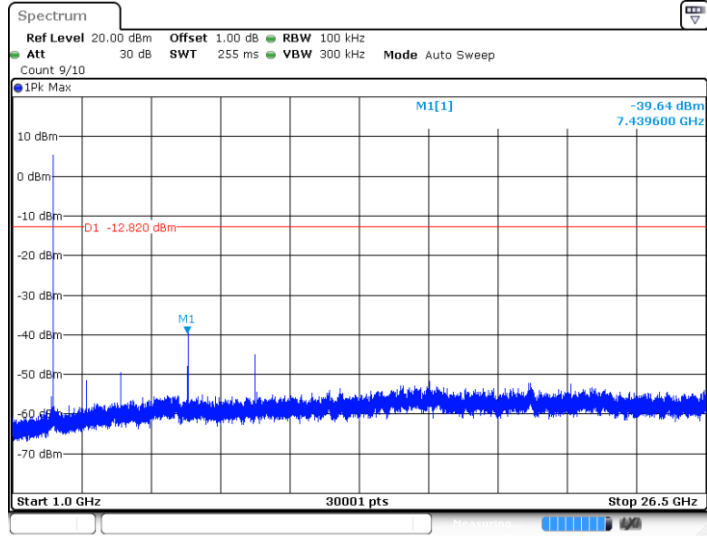

Date: 11.MAY.2021 19:03:34

## 9.6 Band edge

### Test Method

1. The RF output of EUT was connected to the spectrum analyzer by RF cable. The path loss was compensated to the results for each measurement.
2. Use the following spectrum analyzer settings:  
Span = wide enough to capture the peak level of the in-band emission and all spurious  
RBW = 100 kHz, VBW ≥ RBW, Sweep = auto, Detector function = peak, Trace = max hold
3. Allow the trace to stabilize, use the peak and delta measurement to record the result.
4. The level displayed must comply with the limit specified in this Section.
5. Repeat the test at the hopping off and hopping on mode, submit all the plots.

### Limit:

Frequency Range MHz	Limit (dBc)
30-25000	-20

Test result

BLE\_BT4.0\_Ant1\_Low\_2402

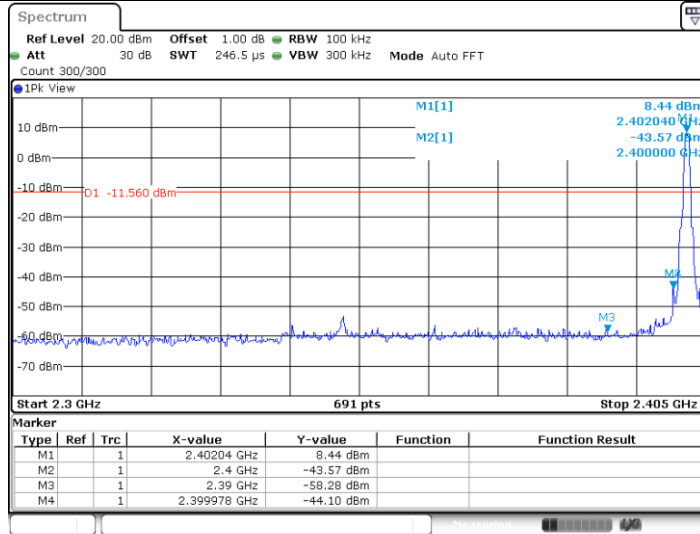

BLE\_BT4.0\_Ant1\_High\_2480

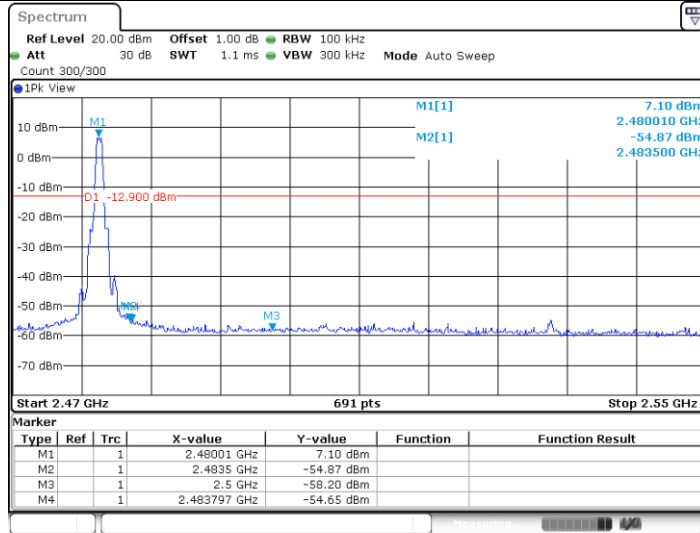



## 9.7 Spurious radiated emissions for transmitter

### Test Method

- 1: The EUT was placed on a turn table which is 1.5m above ground plane for above 1GHz and 0.8m above ground for below 1GHz at 3 meter chamber room for test. The table was rotated 360 degrees to determine the position of the highest radiation.
- 2: The EUT was set 3 meters away from the interference – receiving antenna, which was mounted on the top of a variable – height antenna tower.
- 3: The height of antenna is varied from one meter to four meters above the ground to determine the maximum value of the field strength. Both horizontal and vertical polarizations of the antenna are set to make the measurement.
- 4: For each suspected emission, the EUT was arranged to its worst case and then the antenna was tuned to heights from 1 meter to 4 meters and the rotatable table was turned from 0 degrees to 360 degrees to find the maximum reading.
- 5: Use the following spectrum analyzer settings According to C63.10:

For Below 1GHz

Use the following spectrum analyzer settings:

Span = wide enough to capture the peak level of the in-band emission and all spurious  
 RBW = 100 KHz to 120KHz, VBW ≥ RBW for peak measurement, Sweep = auto, Detector function = peak, Trace = max hold.

For Peak unwanted emissions Above 1GHz:

Span = wide enough to capture the peak level of the in-band emission and all spurious  
 RBW = 1MHz, VBW ≥ RBW for peak measurement, Sweep = auto, Detector function = peak, Trace = max hold.

Procedures for average unwanted emissions measurements above 1000 MHz

a) RBW = 1MHz.

b) VBW \ [3 × RBW].

c) Detector = RMS (power averaging), if [span / (# of points in sweep)] \ RBW / 2.

Satisfying this condition can require increasing the number of points in the sweep or reducing the span. If the condition is not satisfied, then the detector mode shall be set to peak.

d) Averaging type = power (i.e., rms) (As an alternative, the detector and averaging type may be set for linear voltage averaging. Some instruments require linear display mode to use linear voltage averaging. Log or dB averaging shall not be used.)

e) Sweep time = auto.

f) Perform a trace average of at least 100 traces if the transmission is continuous. If the transmission is not continuous, then the number of traces shall be increased by a factor of 1 / D, where D is the duty cycle. For example, with 50% duty cycle, at least 200 traces shall be averaged. (If a specific emission is demonstrated to be continuous—i.e., 100% duty cycle—then rather than turning ON and OFF with the transmit cycle, at least 100 traces shall be averaged.)

g) If tests are performed with the EUT transmitting at a duty cycle less than 98%, then a correction factor shall be added to the measurement results prior to comparing with the emission limit, to compute the emission level that would have been measured had the test been performed at 100% duty cycle. The correction factor is computed as follows:

1) If power averaging (rms) mode was used in the preceding step e), then the correction factor is  $[10 \log (1 / D)]$ , where D is the duty cycle. For example, if the transmit duty

cycle was 50%, then 3 dB shall be added to the measured emission levels.

2) If linear voltage averaging mode was used in the preceding step e), then the correction factor is  $[20 \log (1 / D)]$ , where D is the duty cycle. For example, if the transmit duty cycle was 50%, then 6 dB shall be added to the measured emission levels.

3) If a specific emission is demonstrated to be continuous (100% duty cycle) rather than turning ON and OFF with the transmit cycle, then no duty cycle correction is required for that emission (AV) at frequency above 1GHz.

## Limit

The radio emission outside the operating frequency band shall be at least 20 dB below that in the 100 kHz bandwidth within the band that contains the highest level of the desired power. Radiated emissions which fall in the restricted bands, as defined in section 15.205, RSS-GEN 8.10, must comply with the radiated emission limits specified in section 15.209, section RSS-247.

Frequency MHz	Field Strength $\mu\text{V/m}$	Field Strength $\text{dB}\mu\text{V/m}$	Detector
30-88	100	40	QP
88-216	150	43.5	QP
216-960	200	46	QP
960-1000	500	54	QP
Above 1000	500	54	AV
Above 1000	5000	74	PK

### Spurious radiated emissions for transmitter

According to C63.10, if the peak (or quasi-peak) measured value complies with the average limit, it is unnecessary to perform an average measurement, so AV emission value did not show in below table if the peak value complies with average limit.

### Transmitting spurious emission test result as below:

Below 1G:

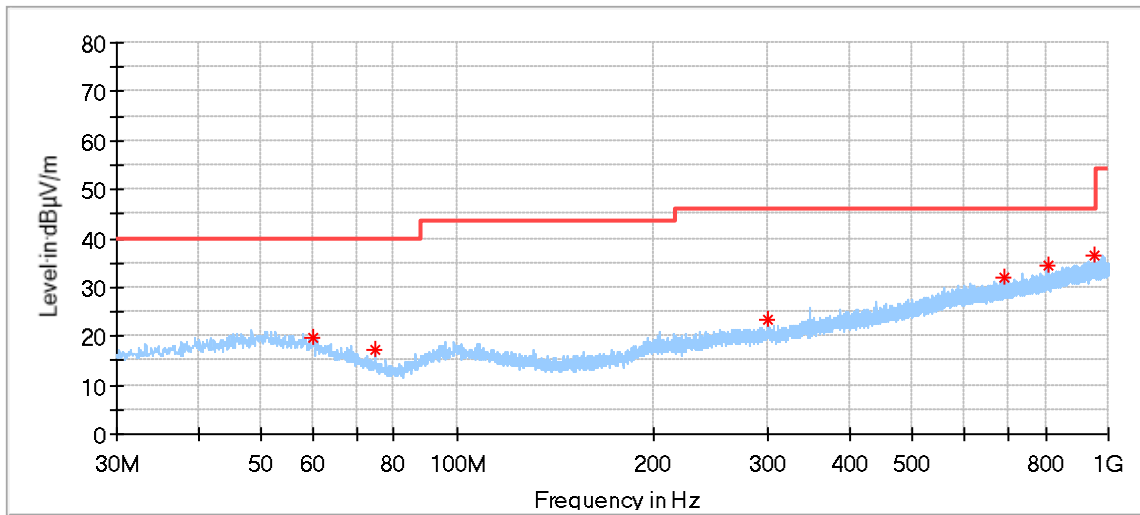

Frequency (MHz)	MaxPeak (dBµV/m)	Limit (dBµV/m)	Margin (dB)	Height (cm)	Pol	Azimuth (deg)	Corr. (dB/m)
60.231667	19.49	40.00	20.51	100.0	H	61.0	13.91
74.889444	17.37	40.00	22.63	100.0	H	0.0	9.46
300.899444	23.38	46.00	22.62	200.0	H	232.0	14.96
690.893333	31.81	46.00	14.19	200.0	H	356.0	22.74
810.903889	34.57	46.00	11.43	100.0	H	326.0	24.34
954.733333	36.38	46.00	9.62	100.0	H	131.0	26.19

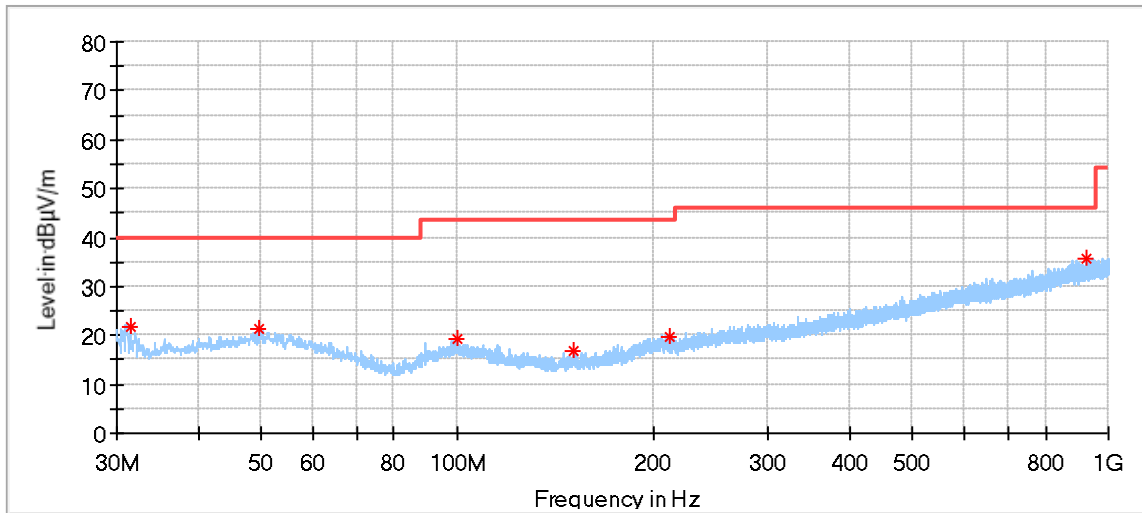

Frequency (MHz)	MaxPeak (dBµV/m)	Limit (dBµV/m)	Margin (dB)	Height (cm)	Pol	Azimuth (deg)	Corr. (dB/m)
31.455000	21.65	40.00	18.35	100.0	V	340.0	11.36
49.453889	21.51	40.00	18.49	100.0	V	325.0	15.13
99.893889	19.18	43.50	24.32	100.0	V	111.0	12.80
150.711111	16.96	43.50	26.54	200.0	V	0.0	9.55
211.659444	19.78	43.50	23.72	100.0	V	309.0	12.79
926.118333	35.61	46.00	10.39	200.0	V	193.0	25.94

Low channel 2402MHz

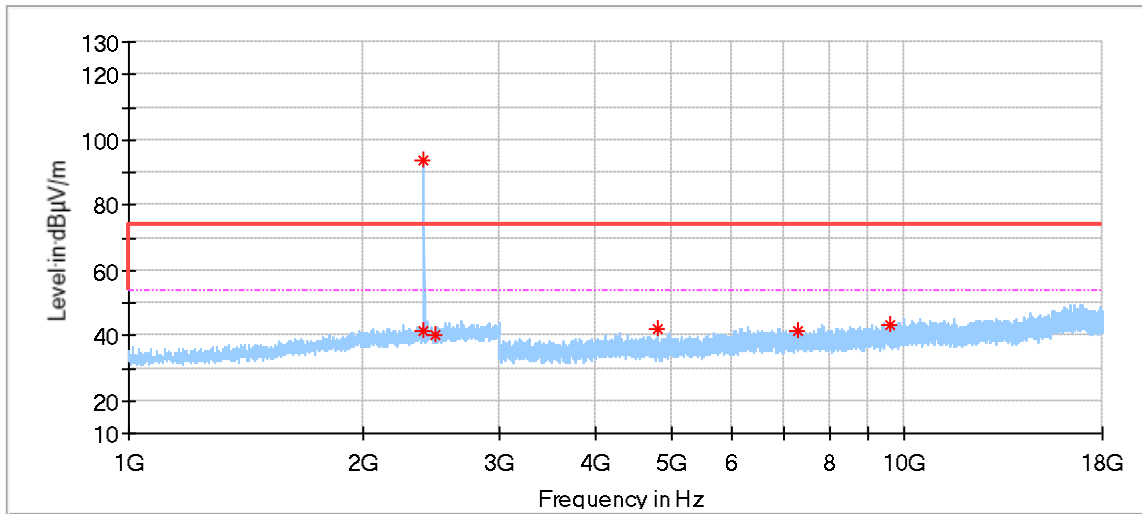

Frequency (MHz)	MaxPeak (dBµV/m)	Limit (dBµV/m)	Margin (dB)	Height (cm)	Pol	Azimuth (deg)	Corr. (dB/m)
2390.000000	41.27	74.00	32.73	150.0	H	149.0	-2.99
2402.380952	93.40	74.00	-19.40	150.0	H	106.0	-2.99
2483.333333	40.41	74.00	33.59	150.0	H	298.0	-2.69
4804.000000	41.85	74.00	32.15	150.0	H	184.0	2.18
7268.000000	41.14	74.00	32.86	150.0	H	56.0	6.97
9607.500000	43.02	74.00	30.98	150.0	H	306.0	9.23

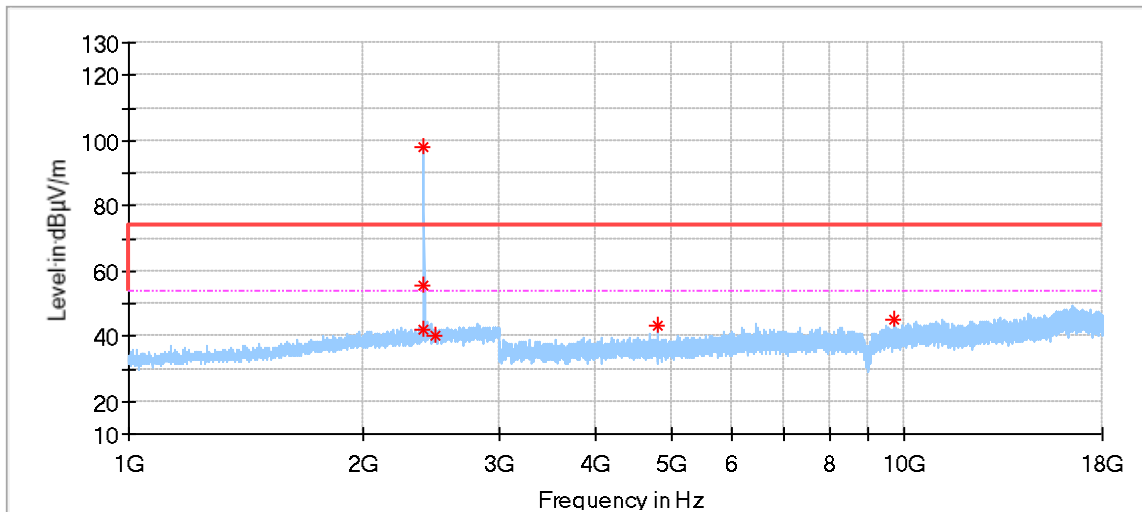

Frequency (MHz)	MaxPeak (dBµV/m)	Limit (dBµV/m)	Margin (dB)	Height (cm)	Pol	Azimuth (deg)	Corr. (dB/m)
2390.571429	41.95	74.00	32.05	150.0	V	0.0	-2.99
2400.476191	55.56	74.00	18.44	150.0	V	0.0	-2.99
2402.380952	98.15	74.00	-24.15	150.0	V	335.0	-2.99
2483.809524	40.18	74.00	33.82	150.0	V	3.0	-2.69
4804.500000	43.17	74.00	30.83	150.0	V	332.0	2.18
9722.000000	44.82	74.00	29.18	150.0	V	185.0	9.53

Middle channel 2440MHz

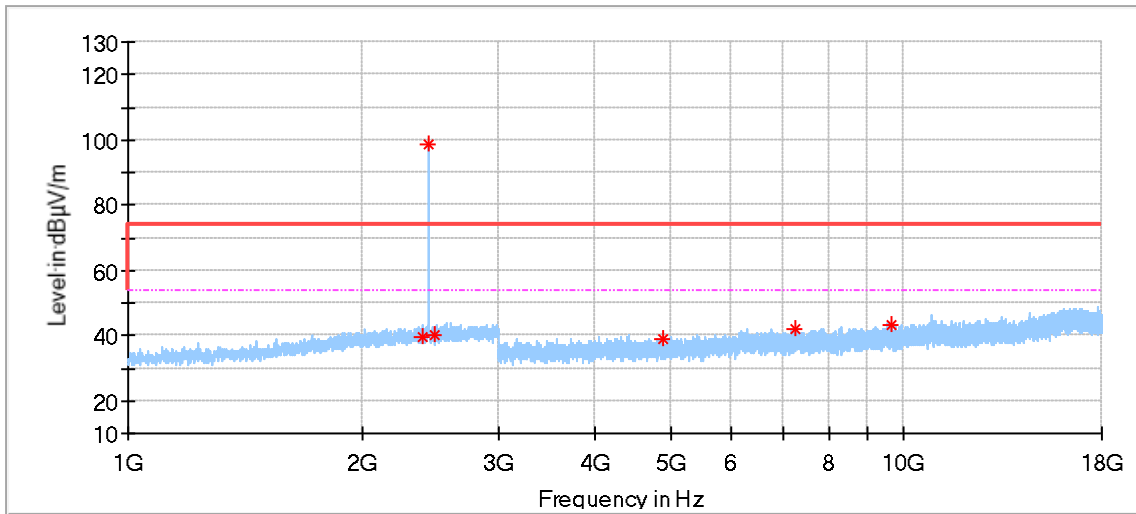

Frequency (MHz)	MaxPeak (dBµV/m)	Limit (dBµV/m)	Margin (dB)	Height (cm)	Pol	Azimuth (deg)	Corr. (dB/m)
2390.952381	39.83	74.00	34.17	150.0	H	140.0	-2.99
2440.000000	98.42	74.00	-24.42	150.0	H	229.0	-2.90
2483.333333	39.90	74.00	34.10	150.0	H	46.0	-2.69
4880.500000	39.02	74.00	34.98	150.0	H	104.0	2.38
7262.500000	42.16	74.00	31.84	150.0	H	28.0	6.96
9635.500000	42.96	74.00	31.04	150.0	H	329.0	9.26

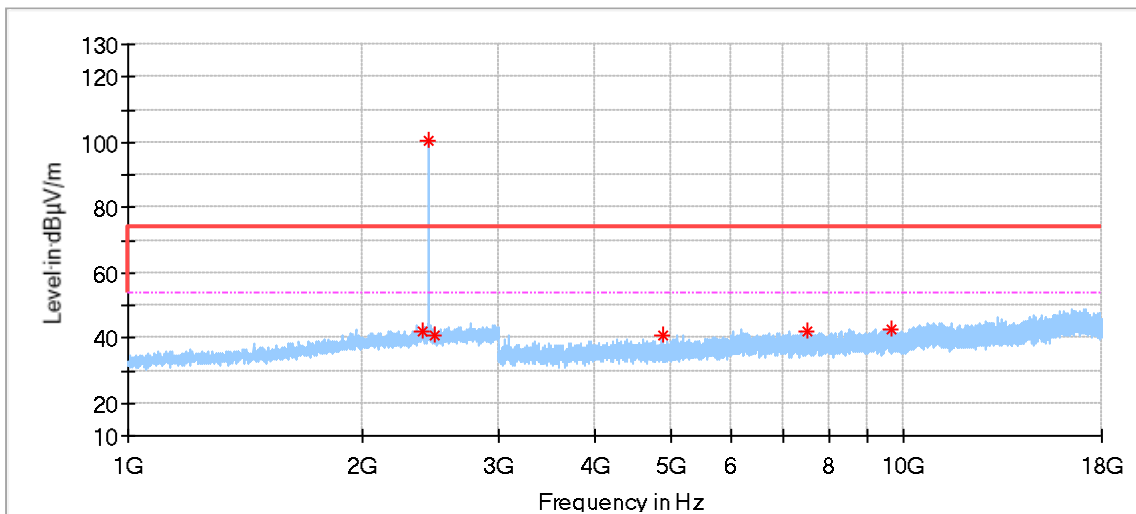

Frequency (MHz)	MaxPeak (dBµV/m)	Limit (dBµV/m)	Margin (dB)	Height (cm)	Pol	Azimuth (deg)	Corr. (dB/m)
2390.523810	41.82	74.00	32.18	150.0	V	352.0	-2.99
2440.476191	100.68	74.00	-26.68	150.0	V	170.0	-2.90
2483.809524	40.81	74.00	33.19	150.0	V	348.0	-2.69
4879.500000	40.86	74.00	33.14	150.0	V	28.0	2.38
7522.500000	41.83	74.00	32.17	150.0	V	7.0	7.61
9626.500000	42.77	74.00	31.23	150.0	V	52.0	9.25

### High channel 2480MHz

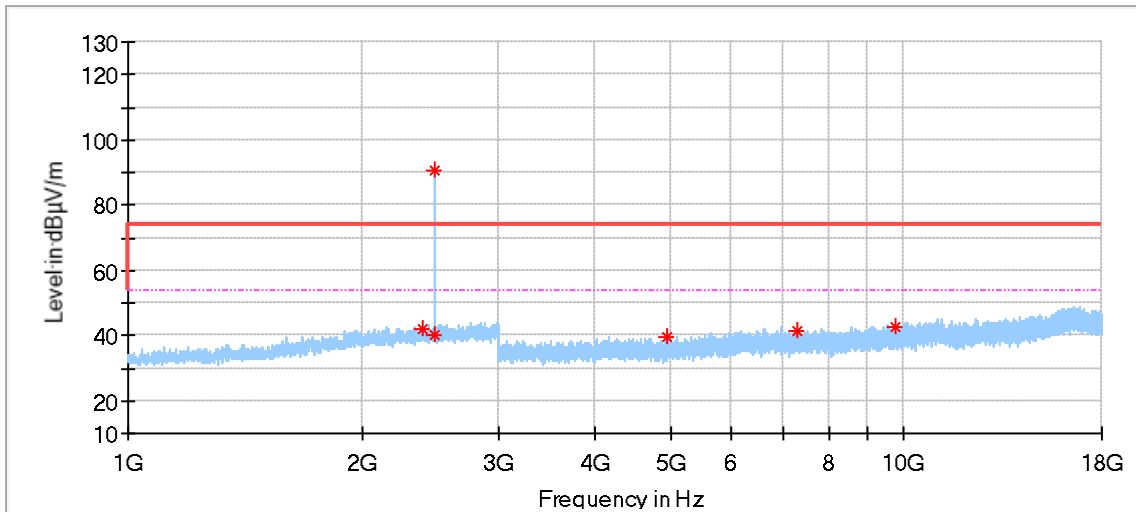

Frequency (MHz)	MaxPeak (dBµV/m)	Limit (dBµV/m)	Margin (dB)	Height (cm)	Pol	Azimuth (deg)	Corr. (dB/m)
2390.000000	41.74	74.00	32.26	150.0	H	0.0	-2.99
2480.476191	90.55	74.00	-16.55	150.0	H	234.0	-2.69
2483.333333	40.43	74.00	33.57	150.0	H	114.0	-2.69
4938.500000	39.60	74.00	34.40	150.0	H	256.0	2.40
7282.500000	41.10	74.00	32.90	150.0	H	232.0	6.99
9752.500000	42.33	74.00	31.67	150.0	H	207.0	9.66

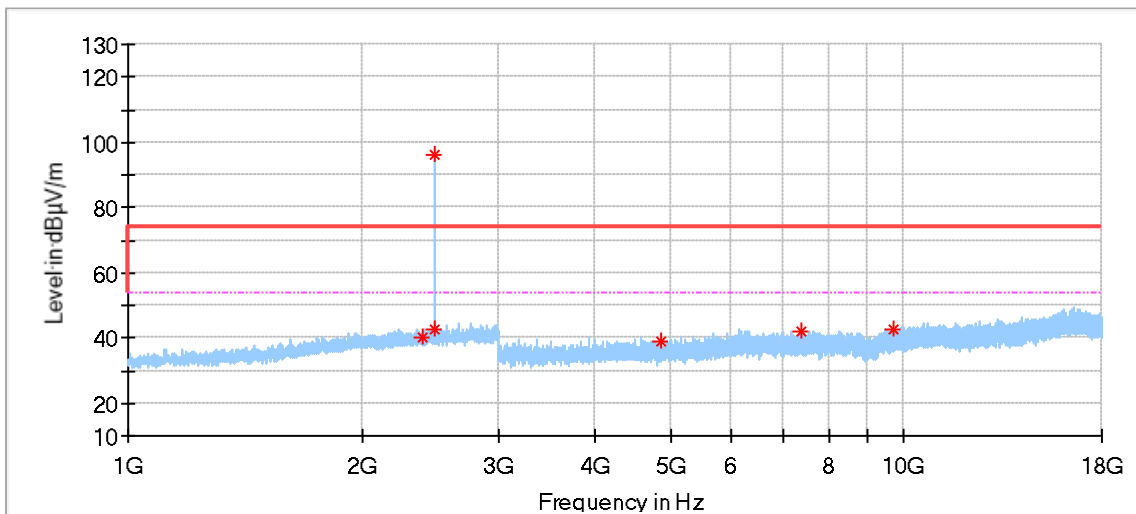

Frequency (MHz)	MaxPeak (dBµV/m)	Limit (dBµV/m)	Margin (dB)	Height (cm)	Pol	Azimuth (deg)	Corr. (dB/m)
2390.476191	40.13	74.00	33.87	150.0	V	198.0	-2.99
2480.476191	96.34	74.00	-22.34	150.0	V	165.0	-2.69
2483.809524	42.89	74.00	31.11	150.0	V	198.0	-2.69
4878.500000	38.90	74.00	35.10	150.0	V	352.0	2.39
7376.500000	42.04	74.00	31.96	150.0	V	158.0	7.16
9723.000000	42.39	74.00	31.61	150.0	V	207.0	9.53

Remark:

- (1) Data of measurement within frequency range 18-26GHz are the noise floor or attenuated more than 20dB below the permissible limits or the field strength is too small to be measured, so test data does not present in this report

- (2) Frequencies which exceed the limit are carrier frequency.
- (3) Level= Reading Level + Correction Factor
- (4) Above 1GHz: Corrector factor = Antenna Factor + Cable Loss- Amplifier Gain  
Below 1GHz: Corrector factor = Antenna Factor + Cable Loss  
(The Reading Level is recorded by software which is not shown in the sheet)



## 10 Test Equipment List

### Radiated Emission Test

Description	Manufacturer	Model no.	Equipment ID	Serial no.	cal interval (year)	cal. due date
EMI Test Receiver	Rohde & Schwarz	ESR 26	68-4-74-14-002	101269	1	2021-6-29
Trilog Super Broadband Test Antenna	Schwarzbeck	VULB 9162	68-4-80-19-003	284	1	2021-2-24
Wave Guide Antenna	ETS	3117	68-4-80-19-001	00218954	1	2021-6-15
Pre-amplifier	Rohde & Schwarz	SCU 18F	68-4-29-19-001	100745	1	2021-12-14
Pre-amplifier	Rohde & Schwarz	SCU 08F2	68-4-29-19-004	08400018	1	2021-12-14
Sideband Horn Antenna	Q-PAR	QWH-SL-18-40-K-SG	68-4-80-14-008	12827	1	2021-8-5
Pre-amplifier	Rohde & Schwarz	SCU 40A	68-4-29-14-002	100432	1	2021-7-30
3m Semi-anechoic chamber	TDK	9X6X6	68-4-90-19-006	----	3	2022-12-29
Test software	Rohde & Schwarz	EMC32	68-4-90-19-006-A01	Version10.35.02	N/A	N/A

### RF Conducted Test

Description	Manufacturer	Model no.	Equipment ID	Serial no.	cal interval (year)	cal. due date
Signal Analyzer	Rohde & Schwarz	FSV40	68-4-74-14-004	101030	1	2021-6-21

## 11 System Measurement Uncertainty

For a 95% confidence level, the measurement expanded uncertainties for defined systems, in accordance with the recommendations of ISO 17025 were:

System Measurement Uncertainty	
Test Items	Extended Uncertainty
Uncertainty for Conducted Emission 150kHz-30MHz (for test using AMN ENV432 or ENV4200)	3.62dB
Uncertainty for Radiated Emission 25MHz-3000MHz	Horizontal: 4.63dB; Vertical: 4.61dB;
Uncertainty for Radiated Emission 3000MHz- 18000MHz	Horizontal: 4.65dB; Vertical: 4.64dB;
Uncertainty for Radiated Emission 18000MHz- 40000MHz	Horizontal: 4.89dB; Vertical: 4.87dB;
Uncertainty for Conducted RF test	RF Power Conducted: 1.16dB Frequency test involved: $0.6 \times 10^{-7}$ or 1%

---THE END OF REPORT---