



FCC RF Test Report

APPLICANT : NOTHING TECHNOLOGY LIMITED
EQUIPMENT : Smart Phone
BRAND NAME : NOTHING
MODEL NAME : A065
FCC ID : 2AZEQ-A065
STANDARD : 47 CFR Part 2, 22, 24, 27
CLASSIFICATION : PCS Licensed Transmitter Held to Ear (PCE)
TEST DATE(S) : Mar. 25, 2023 ~ Apr. 11, 2023

We, Sporton International Inc. (ShenZhen), would like to declare that the tested sample has been evaluated in accordance with the procedures given in ANSI C63.26-2015 and shown compliance with the applicable technical standards.

The test results in this report apply exclusively to the tested model / sample. Without written approval of Sporton International Inc. (ShenZhen), the test report shall not be reproduced except in full.

Jason Jia



Approved by: Jason Jia

Sporton International Inc. (ShenZhen)

1/F, 2/F, Bldg 5, Shiling Industrial Zone, Xinwei Village, Xili, Nanshan, Shenzhen, 518055

People's Republic of China



TABLE OF CONTENTS

REVISION HISTORY... 3
SUMMARY OF TEST RESULT ... 4
1 GENERAL DESCRIPTION ... 5
1.1 Applicant ... 5
1.2 Manufacturer ... 5
1.3 Product Feature of Equipment Under Test ... 5
1.4 Product Specification of Equipment Under Test ... 5
1.5 Modification of EUT ... 6
1.6 Maximum ERP/EIRP Power and Emission Designator ... 6
1.7 Testing Location ... 8
1.8 Test Software ... 8
1.9 Applicable Standards ... 8
2 TEST CONFIGURATION OF EQUIPMENT UNDER TEST ... 9
2.1 Test Mode ... 9
2.2 Connection Diagram of Test System ... 11
2.3 Support Unit used in test configuration and system ... 11
2.4 Measurement Results Explanation Example ... 11
2.5 Frequency List of Low/Middle/High Channels ... 12
3 CONDUCTED TEST ITEMS ... 14
3.1 Measuring Instruments ... 14
3.2 Test Setup ... 14
3.3 Test Result of Conducted Test ... 14
3.4 Conducted Output Power and ERP/EIRP ... 15
3.5 Peak-to-Average Ratio ... 16
3.6 Occupied Bandwidth ... 17
3.7 Conducted Band Edge ... 18
3.8 Conducted Spurious Emission ... 20
3.9 Frequency Stability ... 21
4 RADIATED TEST ITEMS ... 22
4.1 Measuring Instruments ... 22
4.2 Test Setup ... 22
4.3 Test Result of Radiated Test ... 23
4.4 Radiated Spurious Emission ... 24
5 LIST OF MEASURING EQUIPMENT ... 25
6 UNCERTAINTY OF EVALUATION ... 26
APPENDIX A. TEST RESULTS OF CONDUCTED TEST
APPENDIX B. TEST RESULTS OF RADIATED TEST
APPENDIX C. TEST SETUP PHOTOGRAPHS



REVISION HISTORY

| REPORT NO. | VERSION | DESCRIPTION | ISSUED DATE |
|------------|---------|-------------------------|--------------|
| FG330214G | Rev. 01 | Initial issue of report | May 11, 2023 |
| | | | |
| | | | |
| | | | |
| | | | |
| | | | |
| | | | |
| | | | |
| | | | |
| | | | |
| | | | |
| | | | |
| | | | |
| | | | |
| | | | |
| | | | |
| | | | |
| | | | |
| | | | |
| | | | |



SUMMARY OF TEST RESULT

| Report Section | FCC Rule | Description | Limit | Result | Remark |
|----------------|--|---|-------------------------------------|--------|--------------------------------------|
| 3.4 | §2.1046 | Conducted Output Power | Reporting Only | PASS | - |
| | §22.913(a)(5) | Effective Radiated Power (5G NR n5) | ERP < 7 Watt | | |
| | §27.50(b)(10) §27.50(c)(10) | Effective Radiated Power (5G NR n12, n71) | ERP < 3 Watt | | |
| | §24.232(c) | Equivalent Isotropic Radiated Power (5G NR n2, n25) | EIRP < 2Watt | | |
| 3.5 | §24.232(d) | Peak-to-Average Ratio | <13 dB | PASS | - |
| 3.6 | §2.1049 | Occupied Bandwidth | Reporting Only | PASS | - |
| 3.7 | §2.1051 §22.917(a) §24.238(a) §27.53(g) | Conducted Band Edge Measurement (5G NR n5) (5G NR n2, n25) (5G NR n12, n71) | < 43+10log ₁₀ (P[Watts]) | PASS | - |
| 3.8 | §2.1051 §22.917(a) §24.238(a) §27.53(g) | Conducted Spurious Emission (5G NR n5) (5G NR n2, n25) (5G NR n12, n71) | < 43+10log ₁₀ (P[Watts]) | PASS | - |
| 3.9 | §2.1055 §22.355 | Frequency Stability Temperature & Voltage | < 2.5 ppm for Part 22 | PASS | - |
| | §24.235 §27.54 | | Within Authorized Band | | |
| 4.4 | §2.1053 §22.917(a) §24.238(a) §27.53(g) | Radiated Spurious Emission (5G NR n5) (5G NR n2, n25) (5G NR n12, n71) | < 43+10log ₁₀ (P[Watts]) | PASS | Under limit 9.83 dB at 14482.000 MHz |

Declaration of Conformity:
 The test results with all measurement uncertainty excluded are presented in accordance with the regulation limits or requirements declared by manufacturers.

Comments and Explanations:
 The declared of product specification for EUT presented in the report are provided by the manufacturer, and the manufacturer takes all the responsibilities for the accuracy of product specification.



1 General Description

1.1 Applicant

NOTHING TECHNOLOGY LIMITED
80 Cheapside, London, England EC2V 6EE

1.2 Manufacturer

NOTHING TECHNOLOGY LIMITED
80 Cheapside, London, England EC2V 6EE

1.3 Product Feature of Equipment Under Test

| Product Feature | |
|-----------------|--|
| Equipment | Smart Phone |
| Brand Name | NOTHING |
| Model Name | A065 |
| FCC ID | 2AZEQ-A065 |
| IMEI Code | Conducted : 352134980027149/352134980027156 Radiation : 352134980041884/352134980041892 |
| HW Version | 22111 |
| SW Version | Nothing OS 2.0.0 |
| EUT Stage | Identical Prototype |

1.4 Product Specification of Equipment Under Test

| Standards-related Product Specification | |
|---|--|
| Tx Frequency | 5G NR n2 : 1850 MHz ~ 1910 MHz 5G NR n5 : 824 MHz ~ 849 MHz 5G NR n12 : 699 MHz ~ 716 MHz 5G NR n25 : 1850 MHz ~ 1915 MHz 5G NR n71: 663 MHz ~ 698 MHz |
| Rx Frequency | 5G NR n2 : 1930 MHz ~ 1990 MHz 5G NR n5 : 869 MHz ~ 894 MHz 5G NR n12: 729 MHz ~ 746 MHz 5G NR n25 : 1930 MHz ~ 1995 MHz 5G NR n71: 617 MHz ~ 652 MHz |
| Bandwidth | n2, n5, n25, n71: 5MHz / 10MHz / 15MHz / 20MHz n12: 5MHz / 10MHz / 15MHz |
| SCS | 15kHz |
| Antenna Gain | <Ant. 0> n5: -5.25 dBi n12: -4.40 dBi n71: -2.55 dBi <Ant. 1> n5: -3.19 dBi n12: -3.20 dBi |



| | |
|--------------------|--|
| | n71: -1.98 dBi <Ant. 2> n2: -0.98 dBi n25: -1.01 dBi <Ant. 3> n2: -0.48 dBi n25: -0.48 dBi |
| Type of Modulation | CP-OFDM: QPSK / 16QAM / 64QAM / 256QAM DFT-s-OFDM: QPSK / 16QAM / 64QAM / 256QAM |

Remark:

1. The maximum ERP/EIRP is calculated from max output power and max antenna gain, only the maximum ERP/EIRP are shown in the report, 5G NR n5 for Ant. 1 and n2/n25 for Ant. 2 and n12/n71 for Ant. 0.
2. All the supported ENDC combinations are verified conducted power, only the ENDC combination with highest power are shown in the report.
3. 5G NR support SA (n2/n5/n25/n71/n12) mode and NSA(n2/n5/n25/n71) mode. According to the maximum power between SA and NSA mode, SA covers NSA mode.
4. The EN-DC mode combination could be referred to the product spec.

1.5 Modification of EUT

No modifications are made to the EUT during all test items.

1.6 Maximum ERP/EIRP Power and Emission Designator

| 5G NR n2 | | QPSK | | 16QAM / 64QAM / 256QAM | |
|----------|-----------------------|-----------------|------------------------------|------------------------|------------------------------|
| BW (MHz) | Frequency Range (MHz) | Maximum EIRP(W) | Emission Designator (99%OBW) | Maximum EIRP(W) | Emission Designator (99%OBW) |
| 5 | 1852.5 ~ 1907.5 | 0.2009 | 4M48G7D | 0.1614 | 4M48W7D |
| 10 | 1855.0 ~ 1905.0 | 0.2009 | 9M30G7D | 0.1656 | 9M30W7D |
| 15 | 1857.5 ~ 1902.5 | 0.1995 | 14M1G7D | 0.1641 | 14M1W7D |
| 20 | 1860.0 ~ 1900.0 | 0.2018 | 18M9G7D | 0.1726 | 18M9W7D |

| 5G NR n25 | | QPSK | | 16QAM / 64QAM / 256QAM | |
|-----------|-----------------------|-----------------|------------------------------|------------------------|------------------------------|
| BW (MHz) | Frequency Range (MHz) | Maximum EIRP(W) | Emission Designator (99%OBW) | Maximum EIRP(W) | Emission Designator (99%OBW) |
| 5 | 1852.5 ~ 1912.5 | 0.2000 | 4M48G7D | 0.1556 | 4M48W7D |
| 10 | 1855.0 ~ 1910.0 | 0.1928 | 9M30G7D | 0.1524 | 9M30W7D |
| 15 | 1857.5 ~ 1907.5 | 0.2014 | 14M1G7D | 0.1592 | 14M1W7D |
| 20 | 1860.0 ~ 1905.0 | 0.2023 | 18M9G7D | 0.1683 | 18M9W7D |



| 5G NR n5 | | QPSK | | 16QAM / 64QAM / 256QAM | |
|----------|-----------------------|----------------|------------------------------|------------------------|------------------------------|
| BW (MHz) | Frequency Range (MHz) | Maximum ERP(W) | Emission Designator (99%OBW) | Maximum ERP(W) | Emission Designator (99%OBW) |
| 5 | 826.5 ~ 846.5 | 0.0798 | 4M47G7D | 0.0618 | 4M50W7D |
| 10 | 829.0 ~ 844.0 | 0.0780 | 9M28G7D | 0.0608 | 9M30W7D |
| 15 | 831.5 ~ 841.5 | 0.0809 | 14M1G7D | 0.0632 | 14M1W7D |
| 20 | 834.0 ~ 839.0 | 0.0811 | 18M9G7D | 0.0631 | 18M9W7D |

| 5G NR n12 | | QPSK | | 16QAM / 64QAM / 256QAM | |
|-----------|-----------------------|----------------|------------------------------|------------------------|------------------------------|
| BW (MHz) | Frequency Range (MHz) | Maximum ERP(W) | Emission Designator (99%OBW) | Maximum ERP(W) | Emission Designator (99%OBW) |
| 5 | 701.5 ~ 713.5 | 0.0543 | 4M47G7D | 0.0433 | 4M48W7D |
| 10 | 704.0 ~ 711.0 | 0.0551 | 9M29G7D | 0.0434 | 9M30W7D |
| 15 | 706.5 ~ 708.5 | 0.0560 | 14M1G7D | 0.0443 | 14M1W7D |

| 5G NR n71 | | QPSK | | 16QAM / 64QAM / 256QAM | |
|-----------|-----------------------|----------------|------------------------------|------------------------|------------------------------|
| BW (MHz) | Frequency Range (MHz) | Maximum ERP(W) | Emission Designator (99%OBW) | Maximum ERP(W) | Emission Designator (99%OBW) |
| 5 | 665.5 ~ 695.5 | 0.0927 | 4M47G7D | 0.0736 | 4M48W7D |
| 10 | 668.0 ~ 693.0 | 0.0920 | 9M28G7D | 0.0731 | 9M28W7D |
| 15 | 670.5 ~ 690.5 | 0.0895 | 14M1G7D | 0.0703 | 14M1W7D |
| 20 | 673.0 ~ 688.0 | 0.0931 | 18M9G7D | 0.0748 | 18M9W7D |

Note:

1. 5G NR n25 overlaps the entire frequency range of 5G NR n2. Therefore, the test results provided in this report covers 5G NR n25 as well as 5G NR n2.
2. All modulations have been tested, only the worst test results of PSK & QAM are shown in the report.



1.7 Testing Location

Sporton International Inc. (ShenZhen) is accredited to ISO/IEC 17025:2017 by American Association for Laboratory Accreditation with Certificate Number 5145.01.

| | | | |
|---------------------------|---|----------------------------|---------------------------------------|
| Test Firm | Sporton International Inc. (ShenZhen) | | |
| Test Site Location | 1/F, 2/F, Bldg 5, Shiling Industrial Zone, Xinwei Village, Xili, Nanshan, Shenzhen, 518055 People's Republic of China TEL: +86-755-86379589 FAX: +86-755-86379595 | | |
| Test Site No. | Sporton Site No. | FCC Designation No. | FCC Test Firm Registration No. |
| | TH01-SZ | CN1256 | 421272 |

| | | | |
|---------------------------|---|----------------------------|---------------------------------------|
| Test Firm | Sporton International Inc. (ShenZhen) | | |
| Test Site Location | 101, 1st Floor, Block B, Building 1, No. 2, Tengfeng 4th Road, Fenghuang Community, Fuyong Street, Baoan District, Shenzhen City Guangdong Province China 518103 TEL: +86-755-33202398 | | |
| Test Site No. | Sporton Site No. | FCC Designation No. | FCC Test Firm Registration No. |
| | 03CH04-SZ | CN1256 | 421272 |

1.8 Test Software

| Item | Site | Manufacturer | Name | Version |
|------|-----------|--------------|------|-------------|
| 1. | 03CH04-SZ | AUDIX | E3 | 6.2009-8-24 |

1.9 Applicable Standards

According to the specifications of the manufacturer, the EUT must comply with the requirements of the following standards:

- ♦ 47 CFR Part 2, 22, 24, 27
- ♦ ANSI C63.26-2015
- ♦ FCC KDB 971168 D01 Power Meas License Digital Systems v03r01
- ♦ FCC KDB 412172 D01 Determining ERP and EIRP v01r01

Remark: All test items were verified and recorded according to the standards and without any deviation during the test.



2 Test Configuration of Equipment Under Test

2.1 Test Mode

Antenna port conducted and radiated test items are performed according to KDB 971168 D01 Power Meas License Digital Systems v03r01 with maximum output power.

For radiated measurement, pre-scanned in three orthogonal panels, X, Y, Z. The worst cases (X, Y plane) were recorded in this report.

The device is investigated from 30MHz to 10 times of fundamental signal for radiated spurious emission test under different RB size/offset and modulations in exploratory test. Subsequently, only the worst case emissions are reported.

| Orthogonal Planes of EUT | X Plane | Y Plane | Z Plane |
|--------------------------|---|---|---|
| |  |  |  |

| Test Items | 5G NR | Bandwidth (MHz) | | | | | Modulation | | | | | RB # | | Test Channel | | | |
|------------------------|-------|-----------------|----|----|----|----|------------|------|-------|-------|--------|------|------|--------------|---|---|---|
| | | 5 | 10 | 15 | 20 | 25 | PI/2 BPSK | QPSK | 16QAM | 64QAM | 256QAM | 1 | Full | L | M | H | |
| Max. Output Power | n2 | v | v | v | v | - | - | v | v | v | v | v | v | v | v | v | v |
| | n5 | v | v | v | v | - | - | v | v | v | v | v | v | v | v | v | v |
| | n12 | v | v | v | - | - | - | v | v | v | v | v | v | v | v | v | v |
| | n25 | v | v | v | v | - | - | v | v | v | v | v | v | v | v | v | v |
| | n71 | v | v | v | v | - | - | v | v | v | v | v | v | v | v | v | v |
| Peak-to-Average Ratio | n5 | | | | v | | - | v | | | | v | v | v | v | v | v |
| | n12 | | v | | - | - | - | v | | | | v | v | v | v | v | v |
| | n25 | | | | v | - | - | v | | | | v | v | v | v | v | v |
| | n71 | | | | v | - | - | v | | | | v | v | v | v | v | v |
| 26dB and 99% Bandwidth | n5 | v | v | v | v | | - | v | v | v | v | | v | | | v | |
| | n12 | v | v | v | - | - | - | v | v | v | v | | v | | | v | |
| | n25 | v | v | v | v | - | - | v | v | v | v | | v | | | v | |
| | n71 | v | v | v | v | - | - | v | v | v | v | | v | | | v | |
| Conducted Band Edge | n5 | v | v | | v | | - | v | | | | v | v | v | | | v |
| | n12 | v | v | v | - | - | - | v | | | | v | v | v | | | v |
| | n25 | v | v | | v | - | - | v | | | | v | v | v | | | v |
| | n71 | v | v | | v | - | - | v | | | | v | v | v | | | v |



| Test Items | 5G NR | Bandwidth (MHz) | | | | | Modulation | | | | | RB # | | Test Channel | | |
|-----------------------------|---|-----------------|----|----|----|----|------------|------|-------|-------|--------|------|------|--------------|---|---|
| | | 5 | 10 | 15 | 20 | 25 | PI/2 BPSK | QPSK | 16QAM | 64QAM | 256QAM | 1 | Full | L | M | H |
| Conducted Spurious Emission | n5 | v | v | | v | | - | v | | | | v | | v | v | v |
| | n12 | v | v | v | - | - | - | v | | | | v | | v | v | v |
| | n25 | v | v | | v | - | - | v | | | | v | | v | v | v |
| | n71 | v | v | | v | - | - | v | | | | v | | v | v | v |
| Frequency Stability | n5 | | | | v | | - | v | | | | | v | | v | |
| | n12 | | v | | - | - | - | v | | | | | v | | v | |
| | n25 | | | | v | - | - | v | | | | | v | | v | |
| | n71 | | | | v | - | - | v | | | | | v | | v | |
| E.R.P / E.I.R.P | n2 | v | v | v | v | - | - | v | v | v | v | v | v | v | v | v |
| | n5 | v | v | v | v | - | - | v | v | v | v | v | v | v | v | v |
| | n12 | v | v | v | - | - | - | v | v | v | v | v | v | v | v | v |
| | n25 | v | v | v | v | - | - | v | v | v | v | v | v | v | v | v |
| | n71 | v | v | v | v | - | - | v | v | v | v | v | v | v | v | v |
| Radiated Spurious Emission | n5 | Worst Case | | | | | | | | | | | v | v | v | |
| | n12 | Worst Case | | | | | | | | | | | v | v | v | |
| | n25 | Worst Case | | | | | | | | | | | v | v | v | |
| | n71 | Worst Case | | | | | | | | | | | v | v | v | |
| Note | 1. The mark "v" means that this configuration is chosen for testing 2. The mark "-" means that this bandwidth is not supported. 3. The device is investigated from 30MHz to 10 times of fundamental signal for radiated spurious emission test under different RB size/offset and modulations in exploratory test. Subsequently, only the worst case emissions are reported. 4. Frequency Stability : Normal Voltage = 3.89V ; Low Voltage =3.60V. ; High Voltage =4.48V | | | | | | | | | | | | | | | |

2.2 Connection Diagram of Test System

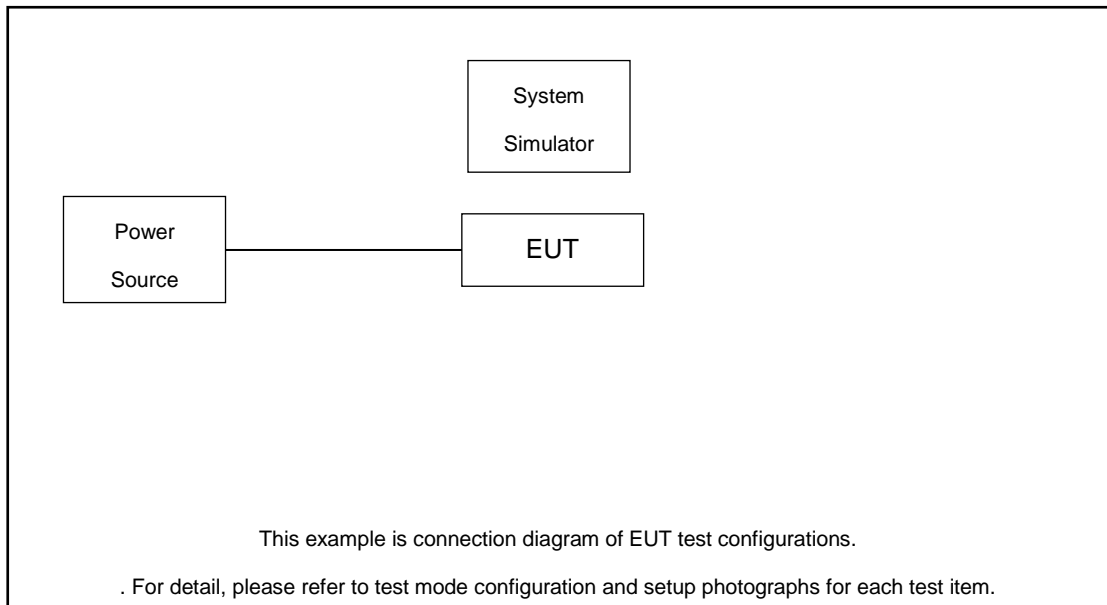

The EUT has been configuration operated in a manner tended to maximize its emission characteristics in a typical application.

2.3 Support Unit used in test configuration and system

| Item | Equipment | Trade Name | Model No. | FCC ID | Data Cable | Power Cord |
|------|------------------|------------|-----------|--------|------------|-------------------|
| 1. | Power Supply | GWINSTEK | GPD-3030D | N/A | N/A | Unshielded, 1.8 m |
| 2. | LTE Base Station | Anritsu | MT8821C | N/A | N/A | Unshielded, 1.8 m |
| 3. | NR Base Station | Anritsu | MT8000A | N/A | N/A | Unshielded, 1.8 m |

2.4 Measurement Results Explanation Example

For all conducted test items:

The offset level is set in the spectrum analyzer to compensate the RF cable loss and attenuator factor between EUT conducted output port and spectrum analyzer. With the offset compensation, the spectrum analyzer reading level is exactly the EUT RF output level.

The spectrum analyzer offset is derived from RF cable loss and attenuator factor.

Offset = RF cable loss.

Following shows an offset computation example with cable loss 7.6 dB.

Example :

$$\begin{aligned} \text{Offset(dB)} &= \text{RF cable loss(dB)} \\ &= 7.6 \text{ (dB)} \end{aligned}$$



2.5 Frequency List of Low/Middle/High Channels

| 5G NR n2 Channel and Frequency List | | | | |
|-------------------------------------|------------------------|--------|--------|---------|
| BW [MHz] | Channel/Frequency(MHz) | Lowest | Middle | Highest |
| 20 | Channel | 372000 | 376000 | 380000 |
| | Frequency | 1860 | 1880 | 1900 |
| 15 | Channel | 371500 | 376000 | 380500 |
| | Frequency | 1857.5 | 1880 | 1902.5 |
| 10 | Channel | 371000 | 376000 | 381000 |
| | Frequency | 1855 | 1880 | 1905 |
| 5 | Channel | 370500 | 376000 | 381500 |
| | Frequency | 1852.5 | 1880 | 1907.5 |

| 5G NR n5 Channel and Frequency List | | | | |
|-------------------------------------|------------------------|--------|--------|---------|
| BW [MHz] | Channel/Frequency(MHz) | Lowest | Middle | Highest |
| 20 | Channel | 166800 | 167300 | 167800 |
| | Frequency | 834 | 836.5 | 839 |
| 15 | Channel | 166300 | 167300 | 168300 |
| | Frequency | 831.5 | 836.5 | 841.5 |
| 10 | Channel | 165800 | 167300 | 168800 |
| | Frequency | 829 | 836.5 | 844 |
| 5 | Channel | 165300 | 167300 | 169300 |
| | Frequency | 826.5 | 836.5 | 846.5 |

| 5G NR n12 Channel and Frequency List | | | | |
|--------------------------------------|------------------------|--------|--------|---------|
| BW [MHz] | Channel/Frequency(MHz) | Lowest | Middle | Highest |
| 15 | Channel | 141300 | 141500 | 141700 |
| | Frequency | 706.5 | 707.5 | 708.5 |
| 10 | Channel | 140800 | 141500 | 142200 |
| | Frequency | 704 | 707.5 | 711 |
| 5 | Channel | 140300 | 141500 | 142700 |
| | Frequency | 701.5 | 707.5 | 713.5 |



| 5G NR n25 Channel and Frequency List | | | | |
|--------------------------------------|------------------------|--------|--------|---------|
| BW [MHz] | Channel/Frequency(MHz) | Lowest | Middle | Highest |
| 20 | Channel | 372000 | 376500 | 381000 |
| | Frequency | 1860 | 1882.5 | 1905 |
| 15 | Channel | 371500 | 376500 | 381500 |
| | Frequency | 1857.5 | 1882.5 | 1907.5 |
| 10 | Channel | 371000 | 376500 | 382000 |
| | Frequency | 1855 | 1882.5 | 1910 |
| 5 | Channel | 370500 | 376500 | 382500 |
| | Frequency | 1852.5 | 1882.5 | 1912.5 |

| 5G NR n71 Channel and Frequency List | | | | |
|--------------------------------------|------------------------|--------|--------|---------|
| BW [MHz] | Channel/Frequency(MHz) | Lowest | Middle | Highest |
| 20 | Channel | 134600 | 136100 | 137600 |
| | Frequency | 673 | 680.5 | 688 |
| 15 | Channel | 134100 | 136100 | 138100 |
| | Frequency | 670.5 | 680.5 | 690.5 |
| 10 | Channel | 133600 | 136100 | 138600 |
| | Frequency | 668 | 680.5 | 693 |
| 5 | Channel | 133100 | 136100 | 139100 |
| | Frequency | 665.5 | 680.5 | 695.5 |

3 Conducted Test Items

3.1 Measuring Instruments

See list of measuring instruments of this test report.

3.2 Test Setup

3.2.1 Conducted Output Power



3.2.2 Peak-to-Average Ratio, Occupied Bandwidth, Conducted Band-Edge and Conducted Spurious Emission



3.2.3 Frequency Stability

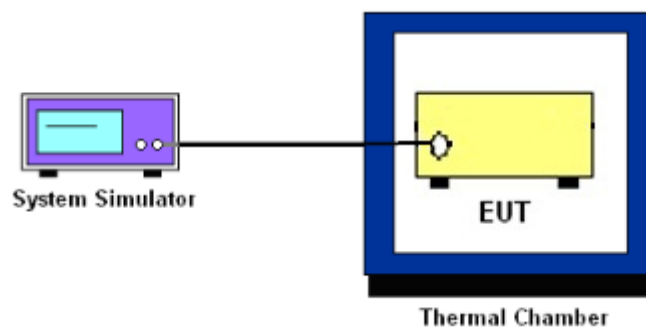

3.3 Test Result of Conducted Test

Please refer to Appendix A.



3.4 Conducted Output Power and ERP/EIRP

3.4.1 Description of the Conducted Output Power Measurement and ERP/EIRP Measurement

A system simulator was used to establish communication with the EUT. Its parameters were set to force the EUT transmitting at maximum output power. The measured power in the radio frequency on the transmitter output terminals shall be reported.

The ERP of mobile transmitters must not exceed 7 Watts for 5G NR n5.

The ERP of mobile transmitters must not exceed 3 Watts for 5G NR n12, n71.

The EIRP of mobile transmitters must not exceed 2 Watts for 5G NR n2, n25.

According to KDB 412172 D01 Power Approach,

$EIRP = P_T + G_T - L_C$, $ERP = EIRP - 2.15$, where

P_T = transmitter output power in dBm

G_T = gain of the transmitting antenna in dBi

L_C = signal attenuation in the connecting cable between the transmitter and antenna in dB

3.4.2 Test Procedures

1. The testing follows ANSI C63.26 Section 5.2
2. The transmitter output port was connected to the system simulator.
3. Set EUT at maximum power through the system simulator.
4. Select lowest, middle, and highest channels for each band and different modulation.
5. Measure and record the power level from the system simulator.



3.5 Peak-to-Average Ratio

3.5.1 Description of the PAR Measurement

Power Complementary Cumulative Distribution Function (CCDF) curves provide a means for characterizing the power peaks of a digitally modulated signal on a statistical basis. A CCDF curve depicts the probability of the peak signal amplitude exceeding the average power level. Most contemporary measurement instrumentation include the capability to produce CCDF curves for an input signal provided that the instrument's resolution bandwidth can be set wide enough to accommodate the entire input signal bandwidth. In measuring transmissions in this band using an average power technique, the peak-to-average ratio (PAR) of the transmission may not exceed 13 dB.

3.5.2 Test Procedures

1. The testing follows ANSI C63.26 Section 5.2.3.4 (CCDF).
2. The EUT was connected to spectrum and system simulator via a power divider.
3. Set the CCDF (Complementary Cumulative Distribution Function) option in spectrum analyzer.
4. The highest RF powers were measured and recorded the maximum PAPR level associated with a probability of 0.1 %.
5. Record the deviation as Peak to Average Ratio.



3.6 Occupied Bandwidth

3.6.1 Description of Occupied Bandwidth Measurement

The occupied bandwidth is the width of a frequency band such that, below the lower and above the upper frequency limits, the mean powers emitted are each equal to a specified percentage 0.5% of the total mean transmitted power.

The 26 dB emission bandwidth is defined as the frequency range between two points, one above and one below the carrier frequency, at which the spectral density of the emission is attenuated 26 dB below the maximum in-band spectral density of the modulated signal. Spectral density (power per unit bandwidth) is to be measured with a detector of resolution bandwidth equal to approximately 1.0% of the emission bandwidth.

3.6.2 Test Procedures

1. The testing follows ANSI C63.26 Section 5.4
2. The EUT was connected to spectrum analyzer and system simulator via a power divider.
3. The spectrum analyzer center frequency is set to the nominal EUT channel center frequency. The span range for the spectrum analyzer shall be between two and five times the anticipated OBW.
4. The nominal resolution bandwidth (RBW) shall be in the range of 1 to 5 % of the anticipated OBW, and the VBW shall be at least 3 times the RBW.
5. Set the detection mode to peak, and the trace mode to max hold.
6. Determine the reference value: Set the EUT to transmit a modulated signal. Allow the trace to stabilize. Set the spectrum analyzer marker to the highest level of the displayed trace.
(this is the reference value)
7. Determine the “-26 dB down amplitude” as equal to (Reference Value – X).
8. Place two markers, one at the lowest and the other at the highest frequency of the envelope of the spectral display such that each marker is at or slightly below the “-X dB down amplitude” determined in step 6. If a marker is below this “-X dB down amplitude” value it shall be placed as close as possible to this value. The OBW is the positive frequency difference between the two markers.
9. Use the 99 % power bandwidth function of the spectrum analyzer and report the measured bandwidth.



3.7 Conducted Band Edge

3.7.1 Description of Conducted Band Edge Measurement

22.917(a)

For operations in the 824 – 849 MHz band, the FCC limit is $43 + 10\log_{10}(P[\text{Watts}])$ dB below the transmitter power $P(\text{Watts})$ in a 100kHz bandwidth. However, in the 1MHz bands immediately outside and adjacent to the licensee's frequency block, a resolution bandwidth of at least one percent of the emission bandwidth of the fundamental emission of the transmitter may be employed.

24.238 (a)

For operations in the 1850-1910 and 1930-1990 MHz band, the FCC limit is $43 + 10\log_{10}(P[\text{Watts}])$ dB below the transmitter power $P(\text{Watts})$ in a 1MHz bandwidth. However, in the 1 MHz bands immediately outside and adjacent to the frequency block a resolution bandwidth of at least one percent of the emission bandwidth of the fundamental emission of the transmitter may be employed.

27.53 (g)

For operations in the 600MHz band and 698 -746 MHz band, the FCC limit is $43 + 10\log_{10}(P[\text{Watts}])$ dB below the transmitter power $P(\text{Watts})$ in a 100 kHz bandwidth. However, in the 100 kilohertz bands immediately outside and adjacent to a licensee's frequency block, a resolution bandwidth of at least 30 kHz may be employed.



3.7.2 Test Procedures

1. The testing follows ANSI C63.26 section 5.7
2. The EUT was connected to spectrum analyzer and system simulator via a power divider.
3. The band edges of low and high channels for the highest RF powers were measured.
4. Set RBW \geq 1% EBW in the 1MHz band immediately outside and adjacent to the band edge.
5. Beyond the 1 MHz band from the band edge, RBW=1MHz was used or a narrower RBW was used (generally limited to no less than 1% of the OBW) and the measured power was integrated over the full required measurement bandwidth.
6. Set spectrum analyzer with RMS detector.
7. The RF fundamental frequency should be excluded against the limit line in the operating frequency band.
8. Checked that all the results comply with the emission limit line.

Example:

The limit line is derived from $43 + 10\log(P)$ dB below the transmitter power P(Watts)

$$= P(W) - [43 + 10\log(P)] \text{ (dB)}$$

$$= [30 + 10\log(P)] \text{ (dBm)} - [43 + 10\log(P)] \text{ (dB)} = -13\text{dBm}.$$

9. When using the integration method, the starting frequency of the integration shall be centered at one-half of the RBW away from the band edge.



3.8 Conducted Spurious Emission

3.8.1 Description of Conducted Spurious Emission Measurement

The power of any emission outside of the authorized operating frequency ranges must be lower than the transmitter power (P) by a factor of at least $43 + 10 \log (P)$ dB.

It is measured by means of a calibrated spectrum analyzer and scanned from 30 MHz up to a frequency including its 10th harmonic.

3.8.2 Test Procedures

1. The testing follows ANSI C63.26 section 5.7
2. The EUT was connected to spectrum analyzer and system simulator via a power divider.
3. The RF output of EUT was connected to the spectrum analyzer by RF cable and attenuator. The path loss was compensated to the results for each measurement.
4. The middle channel for the highest RF power within the transmitting frequency was measured.
5. The conducted spurious emission for the whole frequency range was taken.
6. Make the measurement with the spectrum analyzer's RBW = 1MHz, VBW = 3MHz.
7. Set spectrum analyzer with RMS detector.
8. Taking the record of maximum spurious emission.
9. The RF fundamental frequency should be excluded against the limit line in the operating frequency band.
10. The limit line is derived from $43 + 10\log(P)$ dB below the transmitter power P(Watts)
= P(W)- [43 + 10log(P)] (dB)
= [30 + 10log(P)] (dBm) - [43 + 10log(P)] (dB)
= -13dBm.



3.9 Frequency Stability

3.9.1 Description of Frequency Stability Measurement

The frequency stability shall be measured by variation of ambient temperature and variation of primary supply voltage to ensure that the fundamental emission stays within the authorized frequency block. The frequency stability of the transmitter shall be maintained within $\pm 0.00025\%$ ($\pm 2.5\text{ppm}$) of the center frequency.

3.9.2 Test Procedures for Temperature Variation

1. The testing follows ANSI C63.26 section 5.6.4
2. The EUT was set up in the thermal chamber and connected with the system simulator.
3. With power OFF, the temperature was decreased to -30°C and the EUT was stabilized before testing. Power was applied and the maximum change in frequency was recorded within one minute.
4. With power OFF, the temperature was raised in 10°C step up to 50°C . The EUT was stabilized at each step for at least half an hour. Power was applied and the maximum frequency change was recorded within one minute.

3.9.3 Test Procedures for Voltage Variation

1. The testing follows ANSI C63.26 section 5.6.5
2. The EUT was placed in a temperature chamber at $20\pm 5^{\circ}\text{C}$ and connected with the system simulator.
3. The power supply voltage to the EUT was varied from 85% to 115% of the nominal value for other than hand carried battery equipment.
4. For hand carried, battery powered equipment, reduce the primary ac or dc supply voltage to the battery operating end point, which shall be specified by the manufacturer.
5. The variation in frequency was measured for the worst case.

4 Radiated Test Items

4.1 Measuring Instruments

See list of measuring instruments of this test report.

4.2 Test Setup

4.2.1 For radiated test below 30MHz

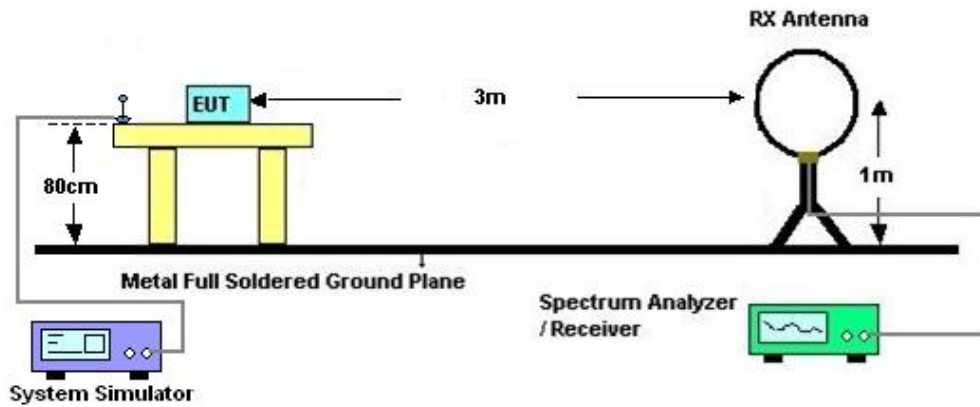

4.2.2 For radiated test from 30MHz to 1GHz

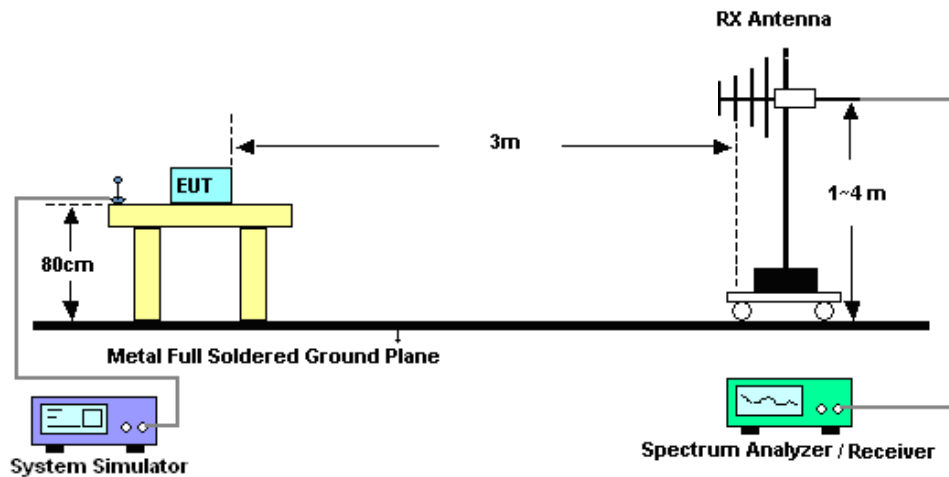

4.2.3 For radiated test above 1GHz

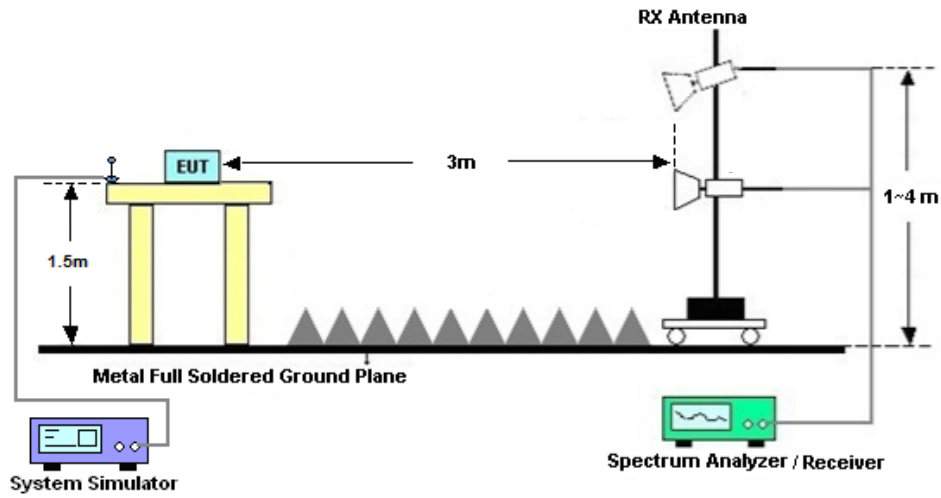

4.3 Test Result of Radiated Test

The low frequency, which started from 9 kHz to 30MHz, was pre-scanned and the result which was 20dB lower than the limit line was not reported.

Please refer to Appendix B.



4.4 Radiated Spurious Emission

4.4.1 Description of Radiated Spurious Emission

The radiated spurious emission was measured by substitution method according to ANSI C63.26. The power of any emission outside of the authorized operating frequency ranges must be attenuated below the transmitter power (P) by a factor of at least $43 + 10 \log (P)$ dB.

The spectrum is scanned from 30 MHz up to a frequency including its 10th harmonic.

4.4.2 Test Procedures

1. The testing follows ANSI C63.26 Section 5.5
2. The EUT was placed on a turntable with 0.8 meter height for frequency below 1GHz and 1.5 meter height for frequency above 1GHz respectively above ground.
3. The EUT was set 3 meters from the receiving antenna mounted on the antenna tower.
4. The table was rotated 360 degrees to determine the position of the highest spurious emission.
5. The height of the receiving antenna is varied between 1m to 4m to search the maximum spurious emission for both horizontal and vertical polarizations.
6. During the measurement, the system simulator parameters were set to force the EUT transmitting at maximum output power.
7. Make the measurement with the spectrum analyzer's RBW = 1MHz, VBW = 3MHz, taking the record of maximum spurious emission.
8. A horn antenna was substituted in place of the EUT and was driven by a signal generator.
9. Tune the output power of signal generator to the same emission level with EUT maximum spurious emission.
10. $EIRP (dBm) = S.G. Power - Tx Cable Loss + Tx Antenna Gain$
11. $ERP (dBm) = EIRP - 2.15$
12. The RF fundamental frequency should be excluded against the limit line in the operating frequency band.

The limit line is derived from $43 + 10\log(P)$ dB below the transmitter power P(Watts)
 $= P(W) - [43 + 10\log(P)] (dB)$
 $= [30 + 10\log(P)] (dBm) - [43 + 10\log(P)] (dB)$
 $= -13dBm.$



5 List of Measuring Equipment

| Instrument | Manufacturer | Model No. | Serial No. | Characteristics | Calibration Date | Test Date | Due Date | Remark |
|---------------------------|------------------------------|----------------------------------|--------------------|-----------------|------------------|---------------------------------|---------------|-----------------------|
| Spectrum Analyzer | R&S | FSV40 | 101078 | 10Hz~40GHz | Apr. 07, 2022 | Mar. 25, 2023~ Apr. 11, 2023 | Apr. 06, 2023 | Conducted (TH01-SZ) |
| Spectrum Analyzer | R&S | FSV40 | 101078 | 10Hz~40GHz | Apr. 06, 2023 | | Apr. 05, 2024 | Conducted (TH01-SZ) |
| Power Divider | TOJOIN | PS-2SM-04 265 | 60.06.020.007 7 | 0.4GHz~26.5GHz | Dec. 25, 2022 | Mar. 25, 2023~ Apr. 11, 2023 | Dec. 24, 2023 | Conducted (TH01-SZ) |
| Thermal Chamber | Ten Billion Hongzhangroup | LP-150U | H2014081803 | -40~+150°C | Jul. 07, 2022 | Mar. 25, 2023~ Apr. 11, 2023 | Jul. 06, 2023 | Conducted (TH01-SZ) |
| EMI Test Receiver | R&S | ESR7 | 101404 | 9kHz~7GHz | Oct. 19, 2022 | Mar. 28, 2023 | Oct. 18, 2023 | Radiation (03CH04-SZ) |
| EXA Spectrum Analyzer | KEYSIGHT | N9010A | MY55150213 | 10Hz~44GHz | Jul. 07, 2022 | Mar. 28, 2023 | Jul. 06, 2023 | Radiation (03CH04-SZ) |
| Loop Antenna | R&S | HFH2-Z2 | 100354 | 9kHz~30MHz | Jun. 28, 2022 | Mar. 28, 2023 | Jun. 27, 2024 | Radiation (03CH04-SZ) |
| Bilog Antenna | TeseQ | CBL6111D | 41909 | 30MHz~1GHz | Apr. 27, 2022 | Mar. 28, 2023 | Apr. 27, 2023 | Radiation (03CH04-SZ) |
| Double Ridge Horn Antenna | SCHWARZBECK | BBHA9120D | 9120D-1474 | 1GHz~18GHz | Jul. 07, 2022 | Mar. 28, 2023 | Jul. 06, 2023 | Radiation (03CH04-SZ) |
| Horn Antenna | SCHWARZBECK | BBHA9170 | 9170#679 | 15GHz~40GHz | Jul. 07, 2022 | Mar. 28, 2023 | Jul. 06, 2023 | Radiation (03CH04-SZ) |
| Amplifier | Burgeon | BPA-530 | 102211 | 0.01Hz ~3000MHz | Oct. 19, 2022 | Mar. 28, 2023 | Oct. 18, 2023 | Radiation (03CH04-SZ) |
| HF Amplifier | MITEQ | AMF-7D-00 101800-30-1 0P-R | 1943528 | 1GHz~18GHz | Oct. 19, 2022 | Mar. 28, 2023 | Oct. 18, 2023 | Radiation (03CH04-SZ) |
| HF Amplifier | MITEQ | TTA1840-35 -HG | 1871923 | 18GHz~40GHz | Jul. 06, 2022 | Mar. 28, 2023 | Jul. 05, 2023 | Radiation (03CH04-SZ) |
| Amplifier | Agilent Technologies | 83017A | MY57280136 | 500MHz~26.5GHz | Sep. 30, 2022 | Mar. 28, 2023 | Sep. 29, 2023 | Radiation (03CH04-SZ) |
| AC Power Source | APC | AFV-S-600B | F119050019 | N/A | Nov. 10, 2022 | Mar. 28, 2023 | Nov. 10, 2023 | Radiation (03CH04-SZ) |
| Turn Table | EM | EM1000 | N/A | 0~360 degree | NCR | Mar. 28, 2023 | NCR | Radiation (03CH04-SZ) |
| Antenna Mast | EM | EM1000 | N/A | 1 m~4 m | NCR | Mar. 28, 2023 | NCR | Radiation (03CH04-SZ) |

NCR: No Calibration Required



6 Uncertainty of Evaluation

The measurement uncertainties shown below were calculated in accordance with the requirements of ANSI 63.26-2015. All the measurement uncertainty value were shown with a coverage K=2 to indicate 95% level of confidence. The measurement data show herein meets or exceeds the CISPR measurement uncertainty values specified in CISPR 16-4-2 and can be compared directly to specified limit to determine compliance.

Uncertainty of Conducted Measurement

| Test Item | Uncertainty |
|----------------------------|-------------|
| Conducted Power | ±1.34 dB |
| Conducted Emissions | ±1.34 dB |
| Occupied Channel Bandwidth | ±0.13 % |

Uncertainty of Radiated Emission Measurement (30 MHz ~ 1000 MHz)

| | |
|---|-------|
| Measuring Uncertainty for a Level of Confidence of 95% (U = 2Uc(y)) | 2.8dB |
|---|-------|

Uncertainty of Radiated Emission Measurement (1000 MHz ~ 18000 MHz)

| | |
|---|-------|
| Measuring Uncertainty for a Level of Confidence of 95% (U = 2Uc(y)) | 3.1dB |
|---|-------|

Uncertainty of Radiated Emission Measurement (18000 MHz ~ 40000 MHz)

| | |
|---|-------|
| Measuring Uncertainty for a Level of Confidence of 95% (U = 2Uc(y)) | 3.9dB |
|---|-------|

----- THE END -----



Appendix A. Test Results of Conducted Test

| | | | |
|-----------------|-----------|---------------------|---------|
| Test Engineer : | Khan Zhen | Temperature : | 24~26°C |
| | | Relative Humidity : | 50~53% |

FR1 N2 (ANT2)

Transmitter Conducted Output Power And EIRP, (GT - LC)=-0.98dB

| NR Band | SCS (kHz) | Bandwidth (MHz) | Arfcn | Freq (MHz) | Modulation | RB | Conducted Power(dBm) | EIRP(dBm) | EIRP(W) |
|---------|-----------|-----------------|--------|------------|--------------------|-------|----------------------|-----------|---------|
| 2 | 15 | 5 | 370500 | 1852.5 | DFT-s-OFDM QPSK | 1@1 | 24.01 | 23.03 | 0.2009 |
| 2 | 15 | 5 | 370500 | 1852.5 | DFT-s-OFDM 16 QAM | 1@1 | 23.06 | 22.08 | 0.1614 |
| 2 | 15 | 5 | 376000 | 1880 | DFT-s-OFDM QPSK | 1@1 | 23.93 | 22.95 | 0.1972 |
| 2 | 15 | 5 | 376000 | 1880 | DFT-s-OFDM 16 QAM | 1@1 | 22.96 | 21.98 | 0.1578 |
| 2 | 15 | 5 | 381500 | 1907.5 | DFT-s-OFDM QPSK | 1@1 | 23.69 | 22.71 | 0.1866 |
| 2 | 15 | 5 | 381500 | 1907.5 | DFT-s-OFDM 16 QAM | 1@1 | 22.66 | 21.68 | 0.1472 |
| 2 | 15 | 10 | 371000 | 1855 | DFT-s-OFDM QPSK | 1@1 | 24.01 | 23.03 | 0.2009 |
| 2 | 15 | 10 | 371000 | 1855 | DFT-s-OFDM 16 QAM | 1@1 | 23.05 | 22.07 | 0.1611 |
| 2 | 15 | 10 | 376000 | 1880 | DFT-s-OFDM QPSK | 1@1 | 23.93 | 22.95 | 0.1972 |
| 2 | 15 | 10 | 376000 | 1880 | DFT-s-OFDM 16 QAM | 1@1 | 23.17 | 22.19 | 0.1656 |
| 2 | 15 | 10 | 381000 | 1905 | DFT-s-OFDM QPSK | 1@1 | 23.44 | 22.46 | 0.1762 |
| 2 | 15 | 10 | 381000 | 1905 | DFT-s-OFDM 16 QAM | 1@1 | 22.45 | 21.47 | 0.1403 |
| 2 | 15 | 15 | 371500 | 1857.5 | DFT-s-OFDM QPSK | 1@1 | 23.98 | 23 | 0.1995 |
| 2 | 15 | 15 | 371500 | 1857.5 | DFT-s-OFDM 16 QAM | 1@1 | 23.13 | 22.15 | 0.1641 |
| 2 | 15 | 15 | 376000 | 1880 | DFT-s-OFDM QPSK | 1@1 | 23.97 | 22.99 | 0.1991 |
| 2 | 15 | 15 | 376000 | 1880 | DFT-s-OFDM 16 QAM | 1@1 | 23.13 | 22.15 | 0.1641 |
| 2 | 15 | 15 | 380500 | 1902.5 | DFT-s-OFDM QPSK | 1@1 | 23.69 | 22.71 | 0.1866 |
| 2 | 15 | 15 | 380500 | 1902.5 | DFT-s-OFDM 16 QAM | 1@1 | 22.62 | 21.64 | 0.1459 |
| 2 | 15 | 20 | 372000 | 1860 | DFT-s-OFDM QPSK | 50@25 | 24.03 | 23.05 | 0.2018 |
| 2 | 15 | 20 | 372000 | 1860 | DFT-s-OFDM QPSK | 1@1 | 23.99 | 23.01 | 0.2000 |
| 2 | 15 | 20 | 372000 | 1860 | DFT-s-OFDM QPSK | 1@104 | 24.01 | 23.03 | 0.2009 |
| 2 | 15 | 20 | 372000 | 1860 | DFT-s-OFDM 16 QAM | 50@25 | 23.12 | 22.14 | 0.1637 |
| 2 | 15 | 20 | 372000 | 1860 | DFT-s-OFDM 16 QAM | 1@1 | 23.17 | 22.19 | 0.1656 |
| 2 | 15 | 20 | 372000 | 1860 | DFT-s-OFDM 16 QAM | 1@104 | 23.35 | 22.37 | 0.1726 |
| 2 | 15 | 20 | 372000 | 1860 | DFT-s-OFDM 64 QAM | 50@25 | 21.79 | 20.81 | 0.1205 |
| 2 | 15 | 20 | 372000 | 1860 | DFT-s-OFDM 64 QAM | 1@1 | 21.77 | 20.79 | 0.1199 |
| 2 | 15 | 20 | 372000 | 1860 | DFT-s-OFDM 64 QAM | 1@104 | 21.96 | 20.98 | 0.1253 |
| 2 | 15 | 20 | 372000 | 1860 | DFT-s-OFDM 256 QAM | 50@25 | 19.69 | 18.71 | 0.0743 |

| | | | | | | | | | |
|---|----|----|--------|------|--------------------|-------|-------|-------|--------|
| 2 | 15 | 20 | 372000 | 1860 | DFT-s-OFDM 256 QAM | 1@1 | 19.23 | 18.25 | 0.0668 |
| 2 | 15 | 20 | 372000 | 1860 | DFT-s-OFDM 256 QAM | 1@104 | 19.45 | 18.47 | 0.0703 |
| 2 | 15 | 20 | 372000 | 1860 | CP-OFDM QPSK | 53@26 | 22.78 | 21.8 | 0.1514 |
| 2 | 15 | 20 | 372000 | 1860 | CP-OFDM QPSK | 1@1 | 22.57 | 21.59 | 0.1442 |
| 2 | 15 | 20 | 372000 | 1860 | CP-OFDM QPSK | 1@104 | 22.79 | 21.81 | 0.1517 |
| 2 | 15 | 20 | 376000 | 1880 | DFT-s-OFDM QPSK | 50@25 | 24.01 | 23.03 | 0.2009 |
| 2 | 15 | 20 | 376000 | 1880 | DFT-s-OFDM QPSK | 1@1 | 23.99 | 23.01 | 0.2000 |
| 2 | 15 | 20 | 376000 | 1880 | DFT-s-OFDM QPSK | 1@104 | 23.62 | 22.64 | 0.1837 |
| 2 | 15 | 20 | 376000 | 1880 | DFT-s-OFDM 16 QAM | 50@25 | 23.04 | 22.06 | 0.1607 |
| 2 | 15 | 20 | 376000 | 1880 | DFT-s-OFDM 16 QAM | 1@1 | 23.28 | 22.3 | 0.1698 |
| 2 | 15 | 20 | 376000 | 1880 | DFT-s-OFDM 16 QAM | 1@104 | 22.71 | 21.73 | 0.1489 |
| 2 | 15 | 20 | 376000 | 1880 | DFT-s-OFDM 64 QAM | 50@25 | 21.59 | 20.61 | 0.1151 |
| 2 | 15 | 20 | 376000 | 1880 | DFT-s-OFDM 64 QAM | 1@1 | 22.02 | 21.04 | 0.1271 |
| 2 | 15 | 20 | 376000 | 1880 | DFT-s-OFDM 64 QAM | 1@104 | 21.39 | 20.41 | 0.1099 |
| 2 | 15 | 20 | 376000 | 1880 | DFT-s-OFDM 256 QAM | 50@25 | 18.92 | 17.94 | 0.0622 |
| 2 | 15 | 20 | 376000 | 1880 | DFT-s-OFDM 256 QAM | 1@1 | 19.53 | 18.55 | 0.0716 |
| 2 | 15 | 20 | 376000 | 1880 | DFT-s-OFDM 256 QAM | 1@104 | 18.84 | 17.86 | 0.0611 |
| 2 | 15 | 20 | 376000 | 1880 | CP-OFDM QPSK | 53@26 | 22.51 | 21.53 | 0.1422 |
| 2 | 15 | 20 | 376000 | 1880 | CP-OFDM QPSK | 1@1 | 22.83 | 21.85 | 0.1531 |
| 2 | 15 | 20 | 376000 | 1880 | CP-OFDM QPSK | 1@104 | 21.88 | 20.9 | 0.1230 |
| 2 | 15 | 20 | 380000 | 1900 | DFT-s-OFDM QPSK | 50@25 | 23.54 | 22.56 | 0.1803 |
| 2 | 15 | 20 | 380000 | 1900 | DFT-s-OFDM QPSK | 1@1 | 23.7 | 22.72 | 0.1871 |
| 2 | 15 | 20 | 380000 | 1900 | DFT-s-OFDM QPSK | 1@104 | 23.74 | 22.76 | 0.1888 |
| 2 | 15 | 20 | 380000 | 1900 | DFT-s-OFDM 16 QAM | 50@25 | 22.54 | 21.56 | 0.1432 |
| 2 | 15 | 20 | 380000 | 1900 | DFT-s-OFDM 16 QAM | 1@1 | 22.58 | 21.6 | 0.1445 |
| 2 | 15 | 20 | 380000 | 1900 | DFT-s-OFDM 16 QAM | 1@104 | 22.8 | 21.82 | 0.1521 |
| 2 | 15 | 20 | 380000 | 1900 | DFT-s-OFDM 64 QAM | 50@25 | 21.08 | 20.1 | 0.1023 |
| 2 | 15 | 20 | 380000 | 1900 | DFT-s-OFDM 64 QAM | 1@1 | 21.23 | 20.25 | 0.1059 |
| 2 | 15 | 20 | 380000 | 1900 | DFT-s-OFDM 64 QAM | 1@104 | 21.49 | 20.51 | 0.1125 |
| 2 | 15 | 20 | 380000 | 1900 | DFT-s-OFDM 256 QAM | 50@25 | 18.97 | 17.99 | 0.0630 |
| 2 | 15 | 20 | 380000 | 1900 | DFT-s-OFDM 256 QAM | 1@1 | 18.88 | 17.9 | 0.0617 |
| 2 | 15 | 20 | 380000 | 1900 | DFT-s-OFDM 256 QAM | 1@104 | 18.91 | 17.93 | 0.0621 |
| 2 | 15 | 20 | 380000 | 1900 | CP-OFDM QPSK | 53@26 | 22.05 | 21.07 | 0.1279 |
| 2 | 15 | 20 | 380000 | 1900 | CP-OFDM QPSK | 1@1 | 22.13 | 21.15 | 0.1303 |
| 2 | 15 | 20 | 380000 | 1900 | CP-OFDM QPSK | 1@104 | 22.27 | 21.29 | 0.1346 |

FR1 N5 (ANT1)

Transmitter Conducted Output Power and ERP, ($G_T - L_C$)=-3.19dB

| NR Band | SCS (kHz) | Bandwidth (MHz) | Arfcn | Freq (MHz) | Modulation | RB | Conducted Power(dBm) | ERP (dBm) | ERP (W) |
|---------|-----------|-----------------|--------|------------|--------------------|-------|----------------------|-----------|---------|
| 5 | 15 | 5 | 165300 | 826.5 | DFT-s-OFDM QPSK | 1@1 | 24.36 | 19.02 | 0.0798 |
| 5 | 15 | 5 | 165300 | 826.5 | DFT-s-OFDM 16 QAM | 1@1 | 23.25 | 17.91 | 0.0618 |
| 5 | 15 | 5 | 167300 | 836.5 | DFT-s-OFDM QPSK | 1@1 | 24.31 | 18.97 | 0.0789 |
| 5 | 15 | 5 | 167300 | 836.5 | DFT-s-OFDM 16 QAM | 1@1 | 23.08 | 17.74 | 0.0594 |
| 5 | 15 | 5 | 169300 | 846.5 | DFT-s-OFDM QPSK | 1@1 | 23.98 | 18.64 | 0.0731 |
| 5 | 15 | 5 | 169300 | 846.5 | DFT-s-OFDM 16 QAM | 1@1 | 22.88 | 17.54 | 0.0568 |
| 5 | 15 | 10 | 165800 | 829 | DFT-s-OFDM QPSK | 1@1 | 24.26 | 18.92 | 0.0780 |
| 5 | 15 | 10 | 165800 | 829 | DFT-s-OFDM 16 QAM | 1@1 | 23.18 | 17.84 | 0.0608 |
| 5 | 15 | 10 | 167300 | 836.5 | DFT-s-OFDM QPSK | 1@1 | 24.1 | 18.76 | 0.0752 |
| 5 | 15 | 10 | 167300 | 836.5 | DFT-s-OFDM 16 QAM | 1@1 | 23.05 | 17.71 | 0.0590 |
| 5 | 15 | 10 | 168800 | 844 | DFT-s-OFDM QPSK | 1@1 | 24.07 | 18.73 | 0.0746 |
| 5 | 15 | 10 | 168800 | 844 | DFT-s-OFDM 16 QAM | 1@1 | 22.95 | 17.61 | 0.0577 |
| 5 | 15 | 15 | 166300 | 831.5 | DFT-s-OFDM QPSK | 1@1 | 24.42 | 19.08 | 0.0809 |
| 5 | 15 | 15 | 166300 | 831.5 | DFT-s-OFDM 16 QAM | 1@1 | 23.35 | 18.01 | 0.0632 |
| 5 | 15 | 15 | 167300 | 836.5 | DFT-s-OFDM QPSK | 1@1 | 24.41 | 19.07 | 0.0807 |
| 5 | 15 | 15 | 167300 | 836.5 | DFT-s-OFDM 16 QAM | 1@1 | 23.23 | 17.89 | 0.0615 |
| 5 | 15 | 15 | 168300 | 841.5 | DFT-s-OFDM QPSK | 1@1 | 24.36 | 19.02 | 0.0798 |
| 5 | 15 | 15 | 168300 | 841.5 | DFT-s-OFDM 16 QAM | 1@1 | 23.14 | 17.8 | 0.0603 |
| 5 | 15 | 20 | 166800 | 834 | DFT-s-OFDM QPSK | 50@25 | 24.14 | 18.8 | 0.0759 |
| 5 | 15 | 20 | 166800 | 834 | DFT-s-OFDM QPSK | 1@1 | 24.43 | 19.09 | 0.0811 |
| 5 | 15 | 20 | 166800 | 834 | DFT-s-OFDM QPSK | 1@104 | 23.91 | 18.57 | 0.0719 |
| 5 | 15 | 20 | 166800 | 834 | DFT-s-OFDM 16 QAM | 50@25 | 23.1 | 17.76 | 0.0597 |
| 5 | 15 | 20 | 166800 | 834 | DFT-s-OFDM 16 QAM | 1@1 | 23.34 | 18 | 0.0631 |
| 5 | 15 | 20 | 166800 | 834 | DFT-s-OFDM 16 QAM | 1@104 | 22.97 | 17.63 | 0.0579 |
| 5 | 15 | 20 | 166800 | 834 | DFT-s-OFDM 64 QAM | 50@25 | 21.72 | 16.38 | 0.0435 |
| 5 | 15 | 20 | 166800 | 834 | DFT-s-OFDM 64 QAM | 1@1 | 22.01 | 16.67 | 0.0465 |
| 5 | 15 | 20 | 166800 | 834 | DFT-s-OFDM 64 QAM | 1@104 | 21.61 | 16.27 | 0.0424 |
| 5 | 15 | 20 | 166800 | 834 | DFT-s-OFDM 256 QAM | 50@25 | 19.31 | 13.97 | 0.0249 |
| 5 | 15 | 20 | 166800 | 834 | DFT-s-OFDM 256 QAM | 1@1 | 19.56 | 14.22 | 0.0264 |

| | | | | | | | | | |
|---|----|----|--------|-------|-----------------------|-------|-------|-------|--------|
| 5 | 15 | 20 | 166800 | 834 | DFT-s-OFDM 256 QAM | 1@104 | 19.21 | 13.87 | 0.0244 |
| 5 | 15 | 20 | 166800 | 834 | CP-OFDM QPSK | 53@26 | 22.71 | 17.37 | 0.0546 |
| 5 | 15 | 20 | 166800 | 834 | CP-OFDM QPSK | 1@1 | 22.86 | 17.52 | 0.0565 |
| 5 | 15 | 20 | 166800 | 834 | CP-OFDM QPSK | 1@104 | 22.07 | 16.73 | 0.0471 |
| 5 | 15 | 20 | 167300 | 836.5 | DFT-s-OFDM QPSK | 50@25 | 24.22 | 18.88 | 0.0773 |
| 5 | 15 | 20 | 167300 | 836.5 | DFT-s-OFDM QPSK | 1@1 | 24.41 | 19.07 | 0.0807 |
| 5 | 15 | 20 | 167300 | 836.5 | DFT-s-OFDM QPSK | 1@104 | 23.83 | 18.49 | 0.0706 |
| 5 | 15 | 20 | 167300 | 836.5 | DFT-s-OFDM 16 QAM | 50@25 | 23.22 | 17.88 | 0.0614 |
| 5 | 15 | 20 | 167300 | 836.5 | DFT-s-OFDM 16 QAM | 1@1 | 23.3 | 17.96 | 0.0625 |
| 5 | 15 | 20 | 167300 | 836.5 | DFT-s-OFDM 16 QAM | 1@104 | 22.9 | 17.56 | 0.0570 |
| 5 | 15 | 20 | 167300 | 836.5 | DFT-s-OFDM 64 QAM | 50@25 | 21.75 | 16.41 | 0.0438 |
| 5 | 15 | 20 | 167300 | 836.5 | DFT-s-OFDM 64 QAM | 1@1 | 21.95 | 16.61 | 0.0458 |
| 5 | 15 | 20 | 167300 | 836.5 | DFT-s-OFDM 64 QAM | 1@104 | 21.59 | 16.25 | 0.0422 |
| 5 | 15 | 20 | 167300 | 836.5 | DFT-s-OFDM 256 QAM | 50@25 | 19.42 | 14.08 | 0.0256 |
| 5 | 15 | 20 | 167300 | 836.5 | DFT-s-OFDM 256 QAM | 1@1 | 19.52 | 14.18 | 0.0262 |
| 5 | 15 | 20 | 167300 | 836.5 | DFT-s-OFDM 256 QAM | 1@104 | 19.21 | 13.87 | 0.0244 |
| 5 | 15 | 20 | 167300 | 836.5 | CP-OFDM QPSK | 53@26 | 22.67 | 17.33 | 0.0541 |
| 5 | 15 | 20 | 167300 | 836.5 | CP-OFDM QPSK | 1@1 | 22.8 | 17.46 | 0.0557 |
| 5 | 15 | 20 | 167300 | 836.5 | CP-OFDM QPSK | 1@104 | 22.02 | 16.68 | 0.0466 |
| 5 | 15 | 20 | 167800 | 839 | DFT-s-OFDM QPSK | 50@25 | 24.14 | 18.8 | 0.0759 |
| 5 | 15 | 20 | 167800 | 839 | DFT-s-OFDM QPSK | 1@1 | 24.36 | 19.02 | 0.0798 |
| 5 | 15 | 20 | 167800 | 839 | DFT-s-OFDM QPSK | 1@104 | 23.83 | 18.49 | 0.0706 |
| 5 | 15 | 20 | 167800 | 839 | DFT-s-OFDM 16 QAM | 50@25 | 23.12 | 17.78 | 0.0600 |
| 5 | 15 | 20 | 167800 | 839 | DFT-s-OFDM 16 QAM | 1@1 | 23.24 | 17.9 | 0.0617 |
| 5 | 15 | 20 | 167800 | 839 | DFT-s-OFDM 16 QAM | 1@104 | 22.86 | 17.52 | 0.0565 |
| 5 | 15 | 20 | 167800 | 839 | DFT-s-OFDM 64 QAM | 50@25 | 21.7 | 16.36 | 0.0433 |
| 5 | 15 | 20 | 167800 | 839 | DFT-s-OFDM 64 QAM | 1@1 | 21.95 | 16.61 | 0.0458 |
| 5 | 15 | 20 | 167800 | 839 | DFT-s-OFDM 64 QAM | 1@104 | 21.56 | 16.22 | 0.0419 |
| 5 | 15 | 20 | 167800 | 839 | DFT-s-OFDM 256 QAM | 50@25 | 19.62 | 14.28 | 0.0268 |
| 5 | 15 | 20 | 167800 | 839 | DFT-s-OFDM 256 QAM | 1@1 | 19.51 | 14.17 | 0.0261 |
| 5 | 15 | 20 | 167800 | 839 | DFT-s-OFDM 256 QAM | 1@104 | 19.12 | 13.78 | 0.0239 |
| 5 | 15 | 20 | 167800 | 839 | CP-OFDM QPSK | 53@26 | 22.6 | 17.26 | 0.0532 |
| 5 | 15 | 20 | 167800 | 839 | CP-OFDM QPSK | 1@1 | 22.74 | 17.4 | 0.0550 |
| 5 | 15 | 20 | 167800 | 839 | CP-OFDM QPSK | 1@104 | 22.38 | 17.04 | 0.0506 |

Frequency Stability

| NR Band | SCS (kHz) | Bandwidth (MHz) | Arfcn | Freq (MHz) | Modulation | RB | Deviation (ppm) | Verdict | Environment |
|---------|-----------|-----------------|--------|------------|-----------------|-------|-----------------|---------|-------------|
| 5 | 15 | 20 | 167300 | 836.5 | DFT-s-OFDM QPSK | 100@0 | 0.0053 | PASS | NV |
| 5 | 15 | 20 | 167300 | 836.5 | DFT-s-OFDM QPSK | 100@0 | 0.0043 | PASS | LV |
| 5 | 15 | 20 | 167300 | 836.5 | DFT-s-OFDM QPSK | 100@0 | 0.0034 | PASS | HV |
| 5 | 15 | 20 | 167300 | 836.5 | DFT-s-OFDM QPSK | 100@0 | 0.0039 | PASS | -30°C |
| 5 | 15 | 20 | 167300 | 836.5 | DFT-s-OFDM QPSK | 100@0 | 0.0062 | PASS | -20°C |
| 5 | 15 | 20 | 167300 | 836.5 | DFT-s-OFDM QPSK | 100@0 | 0.0046 | PASS | -10°C |
| 5 | 15 | 20 | 167300 | 836.5 | DFT-s-OFDM QPSK | 100@0 | 0.0045 | PASS | 0°C |
| 5 | 15 | 20 | 167300 | 836.5 | DFT-s-OFDM QPSK | 100@0 | 0.0031 | PASS | 10°C |
| 5 | 15 | 20 | 167300 | 836.5 | DFT-s-OFDM QPSK | 100@0 | 0.0053 | PASS | 20°C |
| 5 | 15 | 20 | 167300 | 836.5 | DFT-s-OFDM QPSK | 100@0 | 0.0037 | PASS | 30°C |
| 5 | 15 | 20 | 167300 | 836.5 | DFT-s-OFDM QPSK | 100@0 | 0.0063 | PASS | 40°C |
| 5 | 15 | 20 | 167300 | 836.5 | DFT-s-OFDM QPSK | 100@0 | 0.0020 | PASS | 50°C |

Peak to Average Ratio

| NR Band | SCS (kHz) | Bandwidth (MHz) | Arfcn | Freq (MHz) | Modulation | RB | Result (dB) | Limit (dB) | Verdict |
|---------|-----------|-----------------|--------|------------|-----------------|-------|-------------|------------|---------|
| 5 | 15 | 20 | 166800 | 834.0 | DFT-s-OFDM QPSK | 100@0 | 4.59 | 13 | PASS |
| 5 | 15 | 20 | 166800 | 834.0 | DFT-s-OFDM QPSK | 1@0 | 3.78 | 13 | PASS |
| 5 | 15 | 20 | 167300 | 836.5 | DFT-s-OFDM QPSK | 100@0 | 4.64 | 13 | PASS |
| 5 | 15 | 20 | 167300 | 836.5 | DFT-s-OFDM QPSK | 1@0 | 3.75 | 13 | PASS |
| 5 | 15 | 20 | 167800 | 839.0 | DFT-s-OFDM QPSK | 100@0 | 4.67 | 13 | PASS |
| 5 | 15 | 20 | 167800 | 839.0 | DFT-s-OFDM QPSK | 1@0 | 3.78 | 13 | PASS |

N5(20M)_DFT-s-OFDM_QPSK_Outer_Full_Low_CH



N5(20M)_DFT-s-OFDM_QPSK_Edge_1RB_Left_Low_CH



N5(20M)_DFT-s-OFDM_QPSK_Outer_Full_Mid_CH



N5(20M)_DFT-s-OFDM_QPSK_Edge_1RB_Left_Mid_CH

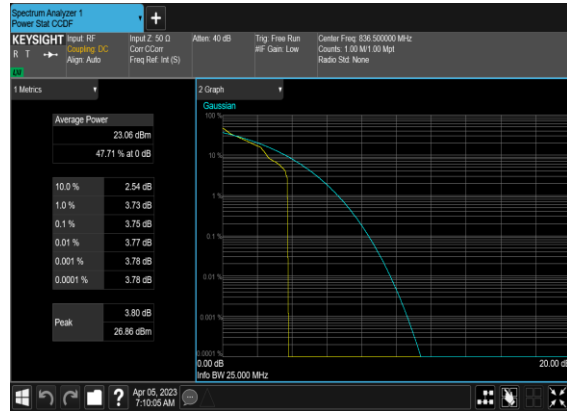

N5(20M)_DFT-s-OFDM_QPSK_Outer_Full_High_CH



N5(20M)_DFT-s-OFDM_QPSK_Edge_1RB_Left_High_CH

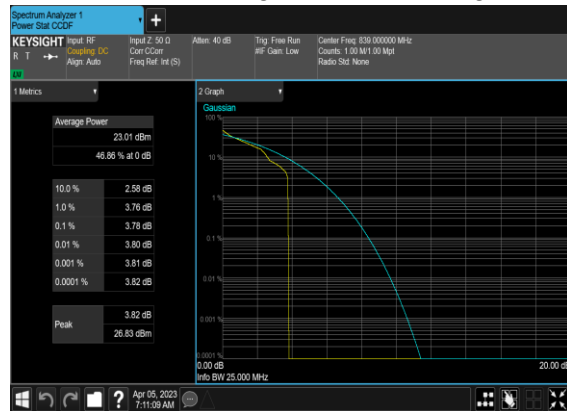

Occupied Bandwidth

| NR Band | SCS (kHz) | Bandwidth (MHz) | Arfcn | Freq (MHz) | Modulation | RB | OBW (MHz) | 26dB BW (MHz) |
|---------|-----------|-----------------|--------|------------|-----------------|-------|-----------|---------------|
| 5 | 15 | 5 | 167300 | 836.5 | DFT-s-OFDM QPSK | 25@0 | 4.4736 | 5.057 |
| 5 | 15 | 5 | 167300 | 836.5 | CP-OFDM QPSK | 25@0 | 4.4612 | 5.009 |
| 5 | 15 | 5 | 167300 | 836.5 | CP-OFDM 16 QAM | 25@0 | 4.5002 | 5.075 |
| 5 | 15 | 5 | 167300 | 836.5 | CP-OFDM 64 QAM | 25@0 | 4.461 | 4.92 |
| 5 | 15 | 5 | 167300 | 836.5 | CP-OFDM 256 QAM | 25@0 | 4.4802 | 5.044 |
| 5 | 15 | 10 | 167300 | 836.5 | DFT-s-OFDM QPSK | 50@0 | 8.9145 | 9.567 |
| 5 | 15 | 10 | 167300 | 836.5 | CP-OFDM QPSK | 52@0 | 9.2785 | 9.997 |
| 5 | 15 | 10 | 167300 | 836.5 | CP-OFDM 16 QAM | 52@0 | 9.2984 | 9.924 |
| 5 | 15 | 10 | 167300 | 836.5 | CP-OFDM 64 QAM | 52@0 | 9.2755 | 9.959 |
| 5 | 15 | 10 | 167300 | 836.5 | CP-OFDM 256 QAM | 52@0 | 9.2855 | 9.919 |
| 5 | 15 | 15 | 167300 | 836.5 | DFT-s-OFDM QPSK | 75@0 | 13.396 | 14.05 |
| 5 | 15 | 15 | 167300 | 836.5 | CP-OFDM QPSK | 79@0 | 14.087 | 14.84 |
| 5 | 15 | 15 | 167300 | 836.5 | CP-OFDM 16 QAM | 79@0 | 14.079 | 14.89 |
| 5 | 15 | 15 | 167300 | 836.5 | CP-OFDM 64 QAM | 79@0 | 14.078 | 14.77 |
| 5 | 15 | 15 | 167300 | 836.5 | CP-OFDM 256 QAM | 79@0 | 14.074 | 14.93 |
| 5 | 15 | 20 | 167300 | 836.5 | DFT-s-OFDM QPSK | 100@0 | 17.853 | 18.8 |
| 5 | 15 | 20 | 167300 | 836.5 | CP-OFDM QPSK | 106@0 | 18.895 | 19.78 |
| 5 | 15 | 20 | 167300 | 836.5 | CP-OFDM 16 QAM | 106@0 | 18.881 | 19.78 |
| 5 | 15 | 20 | 167300 | 836.5 | CP-OFDM 64 QAM | 106@0 | 18.868 | 19.66 |
| 5 | 15 | 20 | 167300 | 836.5 | CP-OFDM 256 QAM | 106@0 | 18.849 | 19.78 |

N5(5M)_DFT-s-OFDM_QPSK_Outer_Full_Mid_CH

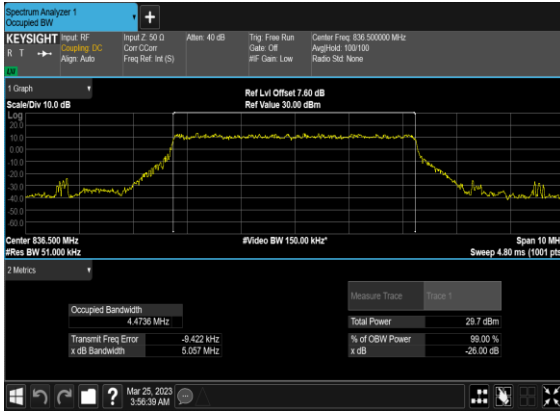

N5(5M)_CP-OFDM_QPSK_Outer_Full_Mid_CH



N5(5M)_CP-OFDM_16QAM_Outer_Full_Mid_CH



N5(5M)_CP-OFDM_64QAM_Outer_Full_Mid_CH

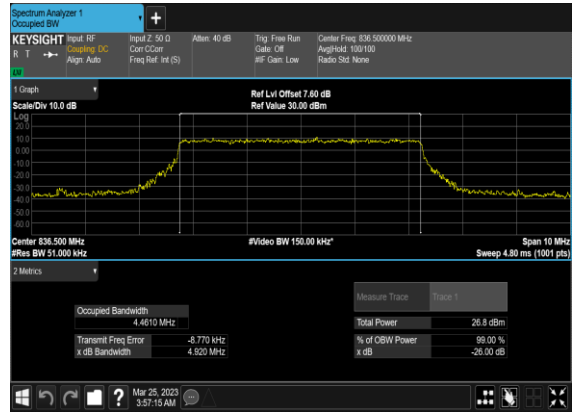

N5(5M)_CP-OFDM_256QAM_Outer_Full_Mid_CH

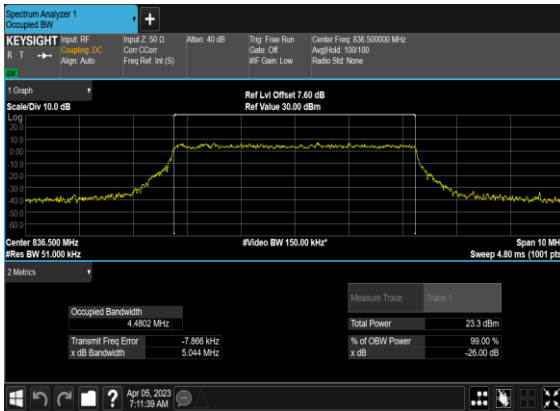

N5(10M)_DFT-s-OFDM_QPSK_Outer_Full_Mid_CH

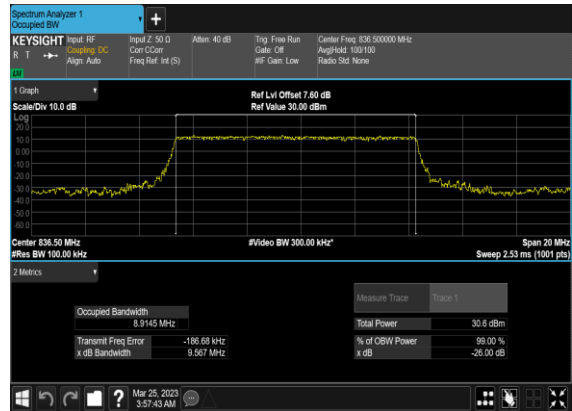

N5(10M)_CP-OFDM_QPSK_Outer_Full_Mid_CH

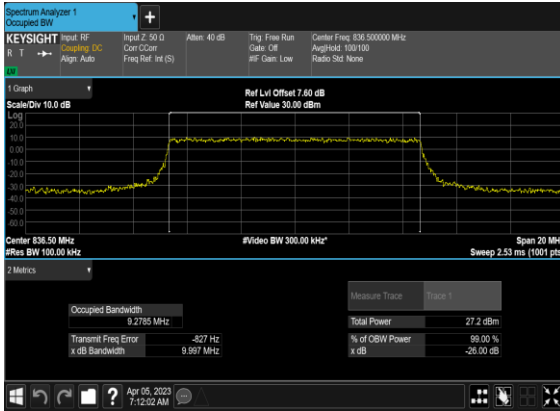

N5(10M)_CP-OFDM_16_QAM_Outer_Full_Mid_CH

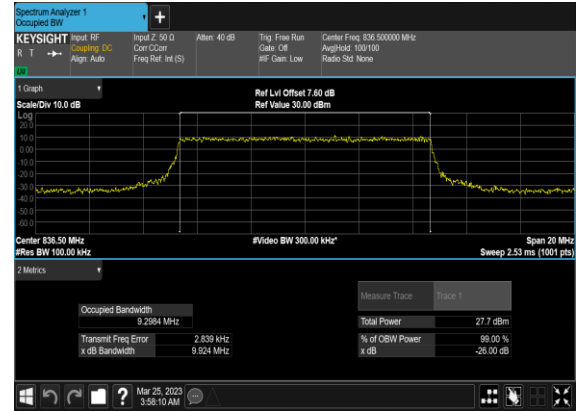

N5(10M)_CP-OFDM_64_QAM_Outer_Full_Mid_CH



N5(10M)_CP-OFDM_256_QAM_Outer_Full_Mid_CH



N5(15M)_DFT-s-OFDM_QPSK_Outer_Full_Mid_CH

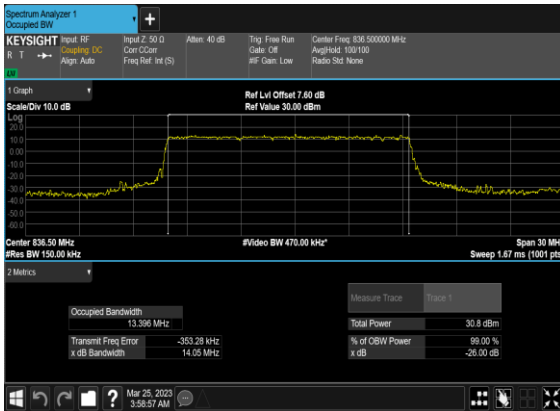

N5(15M)_CP-OFDM_QPSK_Outer_Full_Mid_CH

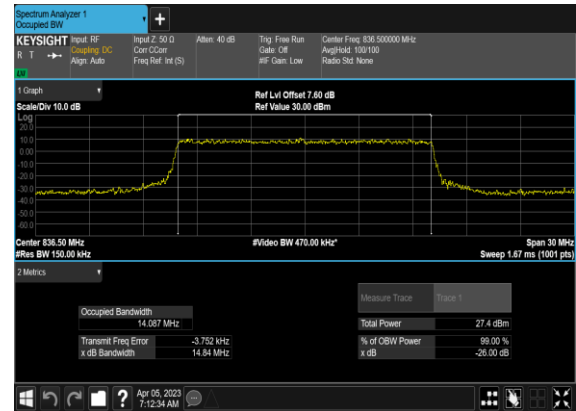

N5(15M)_CP-OFDM_16 QAM_Outer_Full_Mid_CH

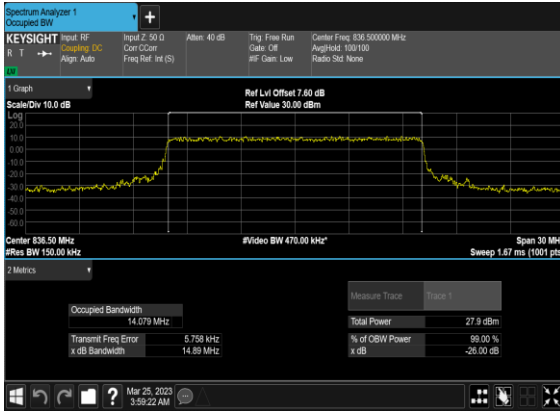

N5(15M)_CP-OFDM_64 QAM_Outer_Full_Mid_CH



N5(15M)_CP-OFDM_256 QAM_Outer_Full_Mid_CH

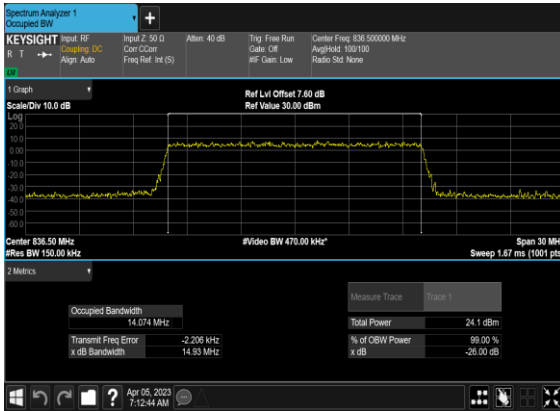

N5(20M)_DFT-s- OFDM_QPSK_Outer_Full_Mid_CH



N5(20M)_CP- OFDM_QPSK_Outer_Full_Mid_CH



N5(20M)_CP-OFDM_16 QAM_Outer_Full_Mid_CH

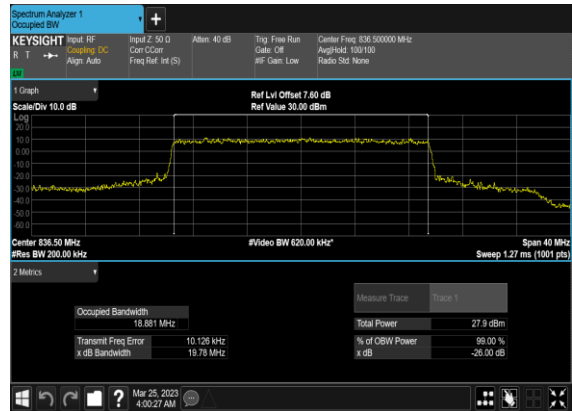

N5(20M)_CP-OFDM_64 QAM_Outer_Full_Mid_CH

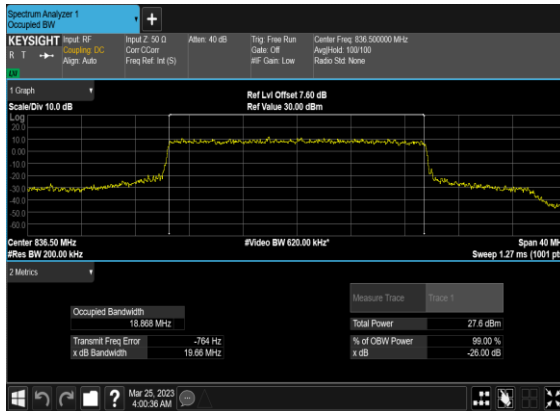

N5(20M)_CP-OFDM_256 QAM_Outer_Full_Mid_CH

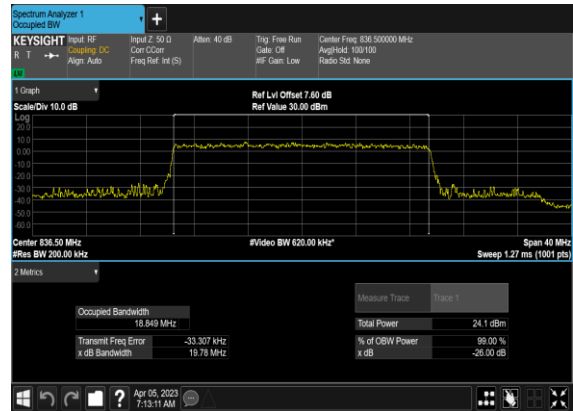

Conducted Spurious Emissions

| NR Band | SCS (kHz) | Bandwidth (MHz) | Arfcn | Freq (MHz) | Modulation | RB | Result | Verdict |
|---------|-----------|-----------------|--------|------------|-----------------|-----|-----------|-------------|
| 5 | 15 | 5 | 165300 | 826.5 | DFT-s-OFDM QPSK | 1@0 | see graph | --- |
| 5 | 15 | 5 | 165300 | 826.5 | DFT-s-OFDM QPSK | 1@0 | see graph | PASS |
| 5 | 15 | 5 | 167300 | 836.5 | DFT-s-OFDM QPSK | 1@0 | see graph | --- |
| 5 | 15 | 5 | 167300 | 836.5 | DFT-s-OFDM QPSK | 1@0 | see graph | PASS |
| 5 | 15 | 5 | 169300 | 846.5 | DFT-s-OFDM QPSK | 1@0 | see graph | --- |
| 5 | 15 | 5 | 169300 | 846.5 | DFT-s-OFDM QPSK | 1@0 | see graph | PASS |
| 5 | 15 | 10 | 165800 | 829.0 | DFT-s-OFDM QPSK | 1@0 | see graph | --- |
| 5 | 15 | 10 | 165800 | 829.0 | DFT-s-OFDM QPSK | 1@0 | see graph | PASS |
| 5 | 15 | 10 | 167300 | 836.5 | DFT-s-OFDM QPSK | 1@0 | see graph | --- |
| 5 | 15 | 10 | 167300 | 836.5 | DFT-s-OFDM QPSK | 1@0 | see graph | PASS |
| 5 | 15 | 10 | 168800 | 844.0 | DFT-s-OFDM QPSK | 1@0 | see graph | --- |
| 5 | 15 | 10 | 168800 | 844.0 | DFT-s-OFDM QPSK | 1@0 | see graph | PASS |
| 5 | 15 | 20 | 166800 | 834.0 | DFT-s-OFDM QPSK | 1@0 | see graph | --- |
| 5 | 15 | 20 | 166800 | 834.0 | DFT-s-OFDM QPSK | 1@0 | see graph | PASS |
| 5 | 15 | 20 | 167300 | 836.5 | DFT-s-OFDM QPSK | 1@0 | see graph | --- |
| 5 | 15 | 20 | 167300 | 836.5 | DFT-s-OFDM QPSK | 1@0 | see graph | PASS |
| 5 | 15 | 20 | 167800 | 839.0 | DFT-s-OFDM QPSK | 1@0 | see graph | --- |
| 5 | 15 | 20 | 167800 | 839.0 | DFT-s-OFDM QPSK | 1@0 | see graph | PASS |

N5(5M)_DFT-s-OFDM_QPSK_Edge_1RB_Left_Low_CH



N5(5M)_DFT-s-OFDM_QPSK_Edge_1RB_Left_Mid_CH

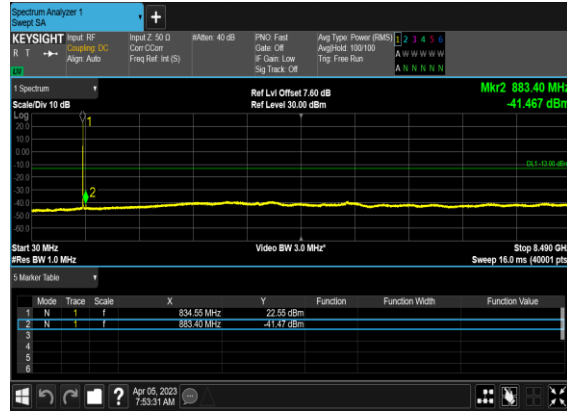

N5(5M)_DFT-s-OFDM_QPSK_Edge_1RB_Left_High_CH

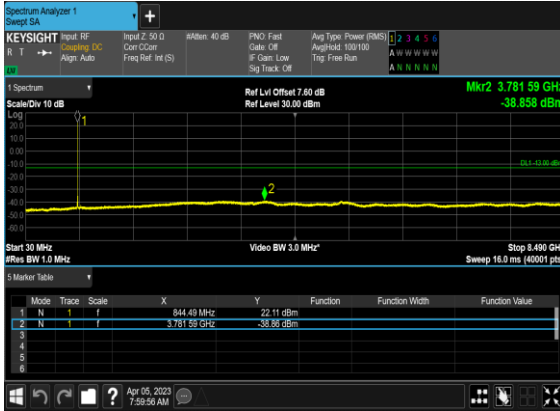

N5(10M)_DFT-s-OFDM_QPSK_Edge_1RB_Left_Low_CH

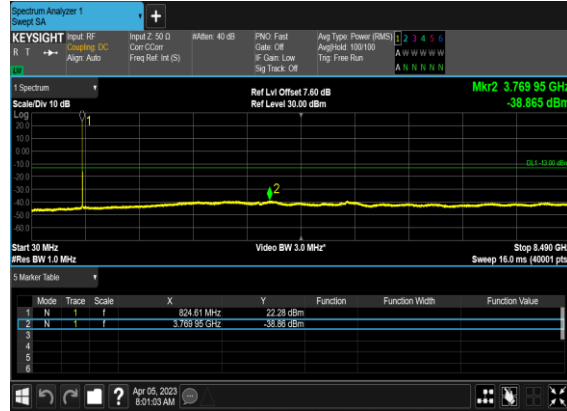

N5(10M)_DFT-s-OFDM_QPSK_Edge_1RB_Left_Mid_CH

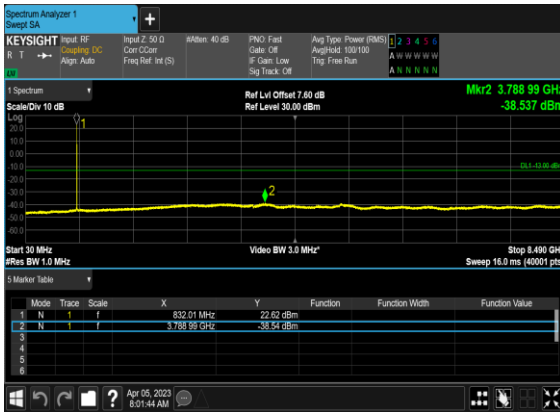

N5(10M)_DFT-s-OFDM_QPSK_Edge_1RB_Left_High_CH



N5(20M)_DFT-s-OFDM_QPSK_Edge_1RB_Left_Low_CH

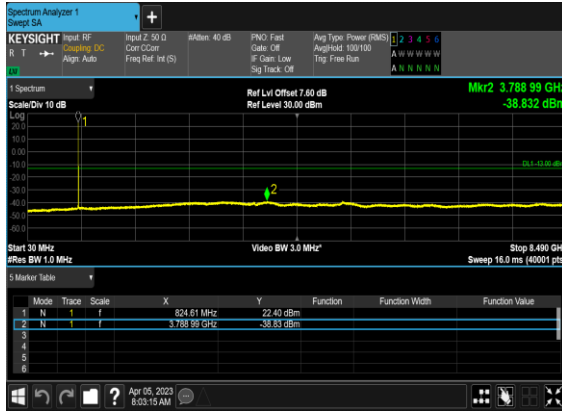

N5(20M)_DFT-s-OFDM_QPSK_Edge_1RB_Left_Mid_CH

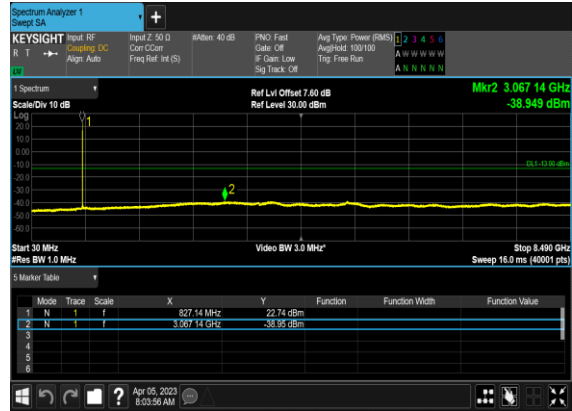

N5(20M)_DFT-s-OFDM_QPSK_Edge_1RB_Left_High_CH

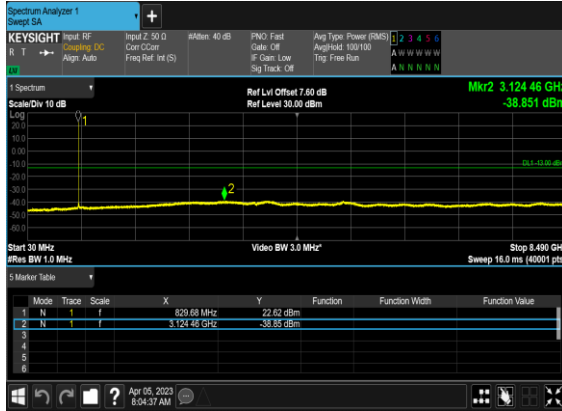

Conducted Band Edge

| NR Band | SCS (kHz) | Bandwidth (MHz) | Arfcn | Freq (MHz) | Modulation | RB | Result | Verdict |
|---------|-----------|-----------------|--------|------------|-----------------|-------|-----------|---------|
| 5 | 15 | 5 | 165300 | 826.5 | DFT-s-OFDM QPSK | 1@0 | see graph | PASS |
| 5 | 15 | 5 | 165300 | 826.5 | DFT-s-OFDM QPSK | 25@0 | see graph | PASS |
| 5 | 15 | 5 | 169300 | 846.5 | DFT-s-OFDM QPSK | 1@24 | see graph | PASS |
| 5 | 15 | 5 | 169300 | 846.5 | DFT-s-OFDM QPSK | 25@0 | see graph | PASS |
| 5 | 15 | 10 | 165800 | 829.0 | DFT-s-OFDM QPSK | 1@0 | see graph | PASS |
| 5 | 15 | 10 | 165800 | 829.0 | DFT-s-OFDM QPSK | 50@0 | see graph | PASS |
| 5 | 15 | 10 | 168800 | 844.0 | DFT-s-OFDM QPSK | 1@51 | see graph | PASS |
| 5 | 15 | 10 | 168800 | 844.0 | DFT-s-OFDM QPSK | 50@0 | see graph | PASS |
| 5 | 15 | 20 | 166800 | 834.0 | DFT-s-OFDM QPSK | 1@0 | see graph | PASS |
| 5 | 15 | 20 | 166800 | 834.0 | DFT-s-OFDM QPSK | 100@0 | see graph | PASS |
| 5 | 15 | 20 | 167800 | 839.0 | DFT-s-OFDM QPSK | 1@105 | see graph | PASS |
| 5 | 15 | 20 | 167800 | 839.0 | DFT-s-OFDM QPSK | 100@0 | see graph | PASS |

N5(5M)_DFT-s-OFDM_QPSK_Edge_1RB_Left_Low_CH

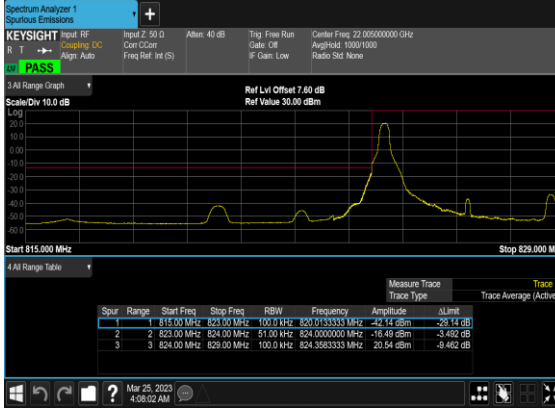

N5(5M)_DFT-s-OFDM_QPSK_Outer_Full_Low_CH

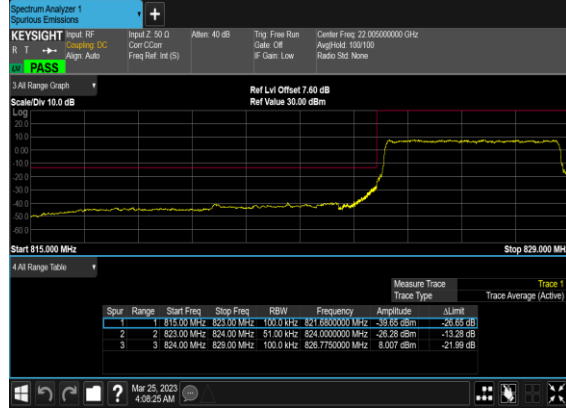

N5(5M)_DFT-s-OFDM_QPSK_Edge_1RB_Right_High_CH

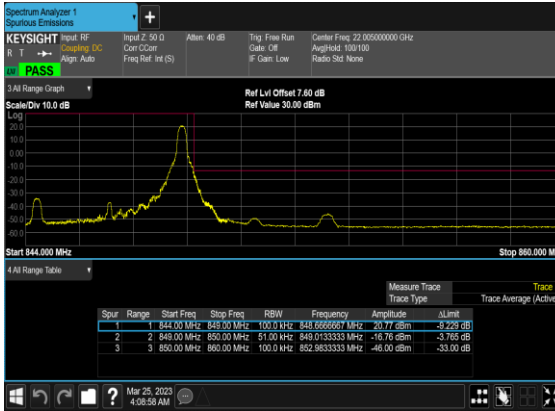

N5(5M)_DFT-s-OFDM_QPSK_Outer_Full_High_CH



N5(10M)_DFT-s-OFDM_QPSK_Edge_1RB_Left_Low_CH

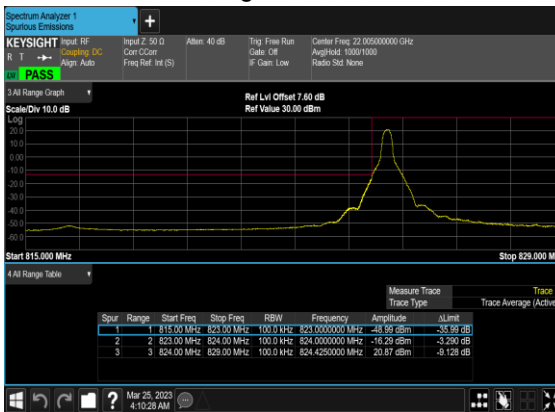

N5(10M)_DFT-s-OFDM_QPSK_Outer_Full_Low_CH

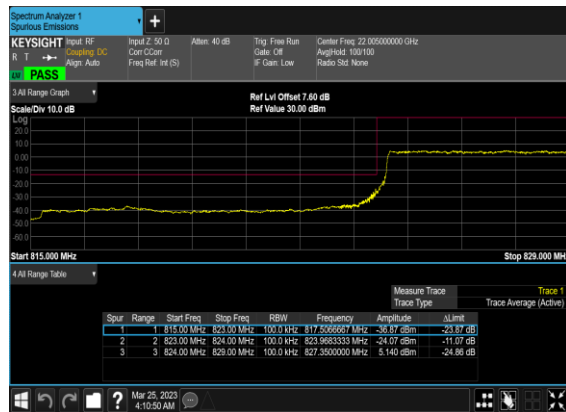

N5(10M)_DFT-s-OFDM_QPSK_Edge_1RB_Right_High_CH

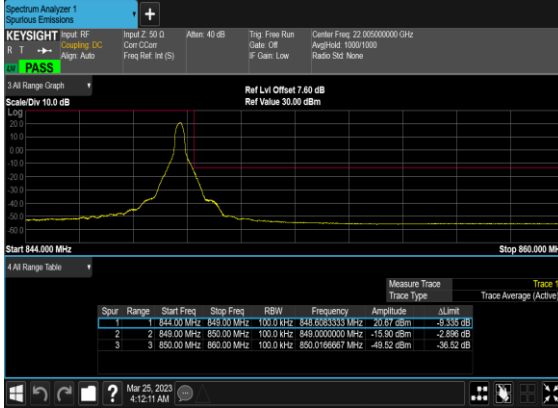

N5(10M)_DFT-s-OFDM_QPSK_Edge_1RB_Right_High_CH_CHP_ASS

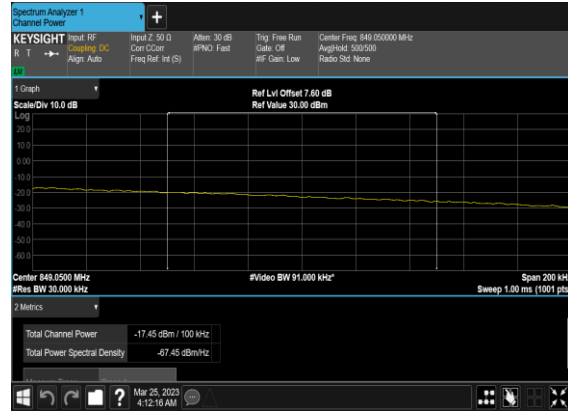

N5(10M)_DFT-s-OFDM_QPSK_Outer_Full_High_CH



N5(20M)_DFT-s-OFDM_QPSK_Edge_1RB_Left_Low_CH

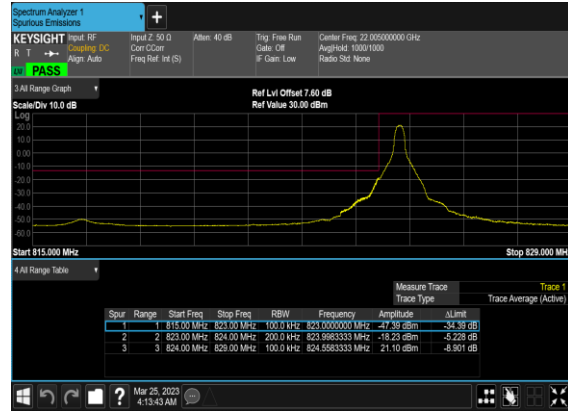

N5(20M)_DFT-s-OFDM_QPSK_Outer_Full_Low_CH

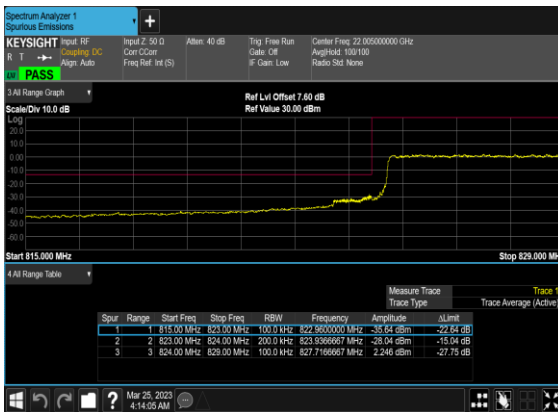

N5(20M)_DFT-s-OFDM_QPSK_Edge_1RB_Right_High_CH

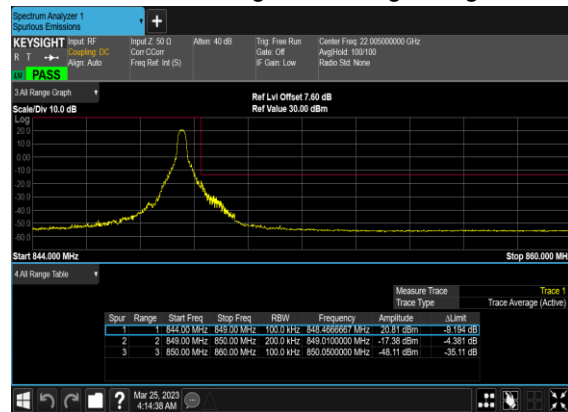

N5(20M)_DFT-s-OFDM_QPSK_Outer_Full_High_CH

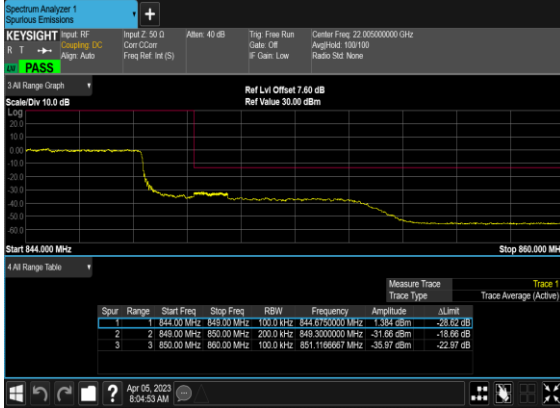

FR1 N12 (ANT0)

Transmitter Conducted Output Power And ERP, (G_T - L_C)=-4.4dB

| NR Band | SCS (kHz) | Bandwidth (MHz) | Arfcn | Freq (MHz) | Modulation | RB | Conducted Power(dBm) | ERP (dBm) | ERP (W) |
|---------|-----------|-----------------|--------|------------|--------------------|-------|----------------------|-----------|---------|
| 12 | 15 | 5 | 140300 | 701.5 | DFT-s-OFDM QPSK | 1@1 | 23.9 | 17.35 | 0.0543 |
| 12 | 15 | 5 | 140300 | 701.5 | DFT-s-OFDM 16 QAM | 1@1 | 22.91 | 16.36 | 0.0433 |
| 12 | 15 | 5 | 141500 | 707.5 | DFT-s-OFDM QPSK | 1@1 | 23.79 | 17.24 | 0.0530 |
| 12 | 15 | 5 | 141500 | 707.5 | DFT-s-OFDM 16 QAM | 1@1 | 22.71 | 16.16 | 0.0413 |
| 12 | 15 | 5 | 142700 | 713.5 | DFT-s-OFDM QPSK | 1@1 | 23.77 | 17.22 | 0.0527 |
| 12 | 15 | 5 | 142700 | 713.5 | DFT-s-OFDM 16 QAM | 1@1 | 22.73 | 16.18 | 0.0415 |
| 12 | 15 | 10 | 140800 | 704 | DFT-s-OFDM QPSK | 1@1 | 23.96 | 17.41 | 0.0551 |
| 12 | 15 | 10 | 140800 | 704 | DFT-s-OFDM 16 QAM | 1@1 | 22.92 | 16.37 | 0.0434 |
| 12 | 15 | 10 | 141500 | 707.5 | DFT-s-OFDM QPSK | 1@1 | 23.88 | 17.33 | 0.0541 |
| 12 | 15 | 10 | 141500 | 707.5 | DFT-s-OFDM 16 QAM | 1@1 | 22.85 | 16.3 | 0.0427 |
| 12 | 15 | 10 | 142200 | 711 | DFT-s-OFDM QPSK | 1@1 | 23.8 | 17.25 | 0.0531 |
| 12 | 15 | 10 | 142200 | 711 | DFT-s-OFDM 16 QAM | 1@1 | 22.67 | 16.12 | 0.0409 |
| 12 | 15 | 15 | 141300 | 706.5 | DFT-s-OFDM QPSK | 36@18 | 24.01 | 17.46 | 0.0557 |
| 12 | 15 | 15 | 141300 | 706.5 | DFT-s-OFDM QPSK | 1@1 | 24.03 | 17.48 | 0.0560 |
| 12 | 15 | 15 | 141300 | 706.5 | DFT-s-OFDM QPSK | 1@77 | 23.79 | 17.24 | 0.0530 |
| 12 | 15 | 15 | 141300 | 706.5 | DFT-s-OFDM 16 QAM | 36@18 | 23.01 | 16.46 | 0.0443 |
| 12 | 15 | 15 | 141300 | 706.5 | DFT-s-OFDM 16 QAM | 1@1 | 22.97 | 16.42 | 0.0439 |
| 12 | 15 | 15 | 141300 | 706.5 | DFT-s-OFDM 16 QAM | 1@77 | 22.74 | 16.19 | 0.0416 |
| 12 | 15 | 15 | 141300 | 706.5 | DFT-s-OFDM 64 QAM | 36@18 | 21.52 | 14.97 | 0.0314 |
| 12 | 15 | 15 | 141300 | 706.5 | DFT-s-OFDM 64 QAM | 1@1 | 21.65 | 15.1 | 0.0324 |
| 12 | 15 | 15 | 141300 | 706.5 | DFT-s-OFDM 64 QAM | 1@77 | 21.44 | 14.89 | 0.0308 |
| 12 | 15 | 15 | 141300 | 706.5 | DFT-s-OFDM 256 QAM | 36@18 | 19.38 | 12.83 | 0.0192 |
| 12 | 15 | 15 | 141300 | 706.5 | DFT-s-OFDM 256 QAM | 1@1 | 19.05 | 12.5 | 0.0178 |
| 12 | 15 | 15 | 141300 | 706.5 | DFT-s-OFDM 256 QAM | 1@77 | 18.79 | 12.24 | 0.0167 |
| 12 | 15 | 15 | 141300 | 706.5 | CP-OFDM QPSK | 39@19 | 22.47 | 15.92 | 0.0391 |
| 12 | 15 | 15 | 141300 | 706.5 | CP-OFDM QPSK | 1@1 | 22.54 | 15.99 | 0.0397 |
| 12 | 15 | 15 | 141300 | 706.5 | CP-OFDM QPSK | 1@77 | 22.21 | 15.66 | 0.0368 |
| 12 | 15 | 15 | 141500 | 707.5 | DFT-s-OFDM QPSK | 36@18 | 23.98 | 17.43 | 0.0553 |
| 12 | 15 | 15 | 141500 | 707.5 | DFT-s-OFDM QPSK | 1@1 | 23.86 | 17.31 | 0.0538 |

| | | | | | | | | | |
|----|----|----|--------|-------|-----------------------|-------|-------|-------|--------|
| 12 | 15 | 15 | 141500 | 707.5 | DFT-s-OFDM QPSK | 1@77 | 23.8 | 17.25 | 0.0531 |
| 12 | 15 | 15 | 141500 | 707.5 | DFT-s-OFDM 16 QAM | 36@18 | 23.01 | 16.46 | 0.0443 |
| 12 | 15 | 15 | 141500 | 707.5 | DFT-s-OFDM 16 QAM | 1@1 | 22.83 | 16.28 | 0.0425 |
| 12 | 15 | 15 | 141500 | 707.5 | DFT-s-OFDM 16 QAM | 1@77 | 22.6 | 16.05 | 0.0403 |
| 12 | 15 | 15 | 141500 | 707.5 | DFT-s-OFDM 64 QAM | 36@18 | 21.49 | 14.94 | 0.0312 |
| 12 | 15 | 15 | 141500 | 707.5 | DFT-s-OFDM 64 QAM | 1@1 | 21.42 | 14.87 | 0.0307 |
| 12 | 15 | 15 | 141500 | 707.5 | DFT-s-OFDM 64 QAM | 1@77 | 21.52 | 14.97 | 0.0314 |
| 12 | 15 | 15 | 141500 | 707.5 | DFT-s-OFDM 256 QAM | 36@18 | 18.93 | 12.38 | 0.0173 |
| 12 | 15 | 15 | 141500 | 707.5 | DFT-s-OFDM 256 QAM | 1@1 | 18.95 | 12.4 | 0.0174 |
| 12 | 15 | 15 | 141500 | 707.5 | DFT-s-OFDM 256 QAM | 1@77 | 18.72 | 12.17 | 0.0165 |
| 12 | 15 | 15 | 141500 | 707.5 | CP-OFDM QPSK | 39@19 | 22.42 | 15.87 | 0.0386 |
| 12 | 15 | 15 | 141500 | 707.5 | CP-OFDM QPSK | 1@1 | 22.15 | 15.6 | 0.0363 |
| 12 | 15 | 15 | 141500 | 707.5 | CP-OFDM QPSK | 1@77 | 21.8 | 15.25 | 0.0335 |
| 12 | 15 | 15 | 141700 | 708.5 | DFT-s-OFDM QPSK | 36@18 | 23.96 | 17.41 | 0.0551 |
| 12 | 15 | 15 | 141700 | 708.5 | DFT-s-OFDM QPSK | 1@1 | 24 | 17.45 | 0.0556 |
| 12 | 15 | 15 | 141700 | 708.5 | DFT-s-OFDM QPSK | 1@77 | 23.71 | 17.16 | 0.0520 |
| 12 | 15 | 15 | 141700 | 708.5 | DFT-s-OFDM 16 QAM | 36@18 | 22.98 | 16.43 | 0.0440 |
| 12 | 15 | 15 | 141700 | 708.5 | DFT-s-OFDM 16 QAM | 1@1 | 22.87 | 16.32 | 0.0429 |
| 12 | 15 | 15 | 141700 | 708.5 | DFT-s-OFDM 16 QAM | 1@77 | 22.62 | 16.07 | 0.0405 |
| 12 | 15 | 15 | 141700 | 708.5 | DFT-s-OFDM 64 QAM | 36@18 | 21.46 | 14.91 | 0.0310 |
| 12 | 15 | 15 | 141700 | 708.5 | DFT-s-OFDM 64 QAM | 1@1 | 21.52 | 14.97 | 0.0314 |
| 12 | 15 | 15 | 141700 | 708.5 | DFT-s-OFDM 64 QAM | 1@77 | 21.34 | 14.79 | 0.0301 |
| 12 | 15 | 15 | 141700 | 708.5 | DFT-s-OFDM 256 QAM | 36@18 | 18.91 | 12.36 | 0.0172 |
| 12 | 15 | 15 | 141700 | 708.5 | DFT-s-OFDM 256 QAM | 1@1 | 18.98 | 12.43 | 0.0175 |
| 12 | 15 | 15 | 141700 | 708.5 | DFT-s-OFDM 256 QAM | 1@77 | 18.67 | 12.12 | 0.0163 |
| 12 | 15 | 15 | 141700 | 708.5 | CP-OFDM QPSK | 39@19 | 22.38 | 15.83 | 0.0383 |
| 12 | 15 | 15 | 141700 | 708.5 | CP-OFDM QPSK | 1@1 | 22.46 | 15.91 | 0.0390 |
| 12 | 15 | 15 | 141700 | 708.5 | CP-OFDM QPSK | 1@77 | 22.03 | 15.48 | 0.0353 |

Frequency Stability

| NR Band | SCS (kHz) | Bandwidth (MHz) | Arfcn | Freq (MHz) | Modulation | RB | Deviation (ppm) | Verdict | Environment |
|---------|-----------|-----------------|--------|------------|-----------------|------|-----------------|---------|-------------|
| 12 | 15 | 10 | 141500 | 707.5 | DFT-s-OFDM QPSK | 50@0 | 0.0069 | PASS | NV |
| 12 | 15 | 10 | 141500 | 707.5 | DFT-s-OFDM QPSK | 50@0 | 0.0043 | PASS | LV |
| 12 | 15 | 10 | 141500 | 707.5 | DFT-s-OFDM QPSK | 50@0 | 0.0050 | PASS | HV |
| 12 | 15 | 10 | 141500 | 707.5 | DFT-s-OFDM QPSK | 50@0 | 0.0033 | PASS | -30°C |
| 12 | 15 | 10 | 141500 | 707.5 | DFT-s-OFDM QPSK | 50@0 | 0.0065 | PASS | -20°C |
| 12 | 15 | 10 | 141500 | 707.5 | DFT-s-OFDM QPSK | 50@0 | 0.0068 | PASS | -10°C |
| 12 | 15 | 10 | 141500 | 707.5 | DFT-s-OFDM QPSK | 50@0 | 0.0046 | PASS | 0°C |
| 12 | 15 | 10 | 141500 | 707.5 | DFT-s-OFDM QPSK | 50@0 | 0.0022 | PASS | 10°C |
| 12 | 15 | 10 | 141500 | 707.5 | DFT-s-OFDM QPSK | 50@0 | 0.0069 | PASS | 20°C |
| 12 | 15 | 10 | 141500 | 707.5 | DFT-s-OFDM QPSK | 50@0 | 0.0058 | PASS | 30°C |
| 12 | 15 | 10 | 141500 | 707.5 | DFT-s-OFDM QPSK | 50@0 | 0.0042 | PASS | 40°C |
| 12 | 15 | 10 | 141500 | 707.5 | DFT-s-OFDM QPSK | 50@0 | 0.0029 | PASS | 50°C |

Peak to Average Ratio

| NR Band | SCS (kHz) | Bandwidth (MHz) | Arfcn | Freq (MHz) | Modulation | RB | Result (dB) | Limit (dB) | Verdict |
|---------|-----------|-----------------|--------|------------|-----------------|------|-------------|------------|---------|
| 12 | 15 | 10 | 140800 | 704.0 | DFT-s-OFDM QPSK | 50@0 | 4.51 | 13 | PASS |
| 12 | 15 | 10 | 140800 | 704.0 | DFT-s-OFDM QPSK | 1@0 | 4.14 | 13 | PASS |
| 12 | 15 | 10 | 141500 | 707.5 | DFT-s-OFDM QPSK | 50@0 | 4.59 | 13 | PASS |
| 12 | 15 | 10 | 141500 | 707.5 | DFT-s-OFDM QPSK | 1@0 | 4.13 | 13 | PASS |
| 12 | 15 | 10 | 142200 | 711.0 | DFT-s-OFDM QPSK | 50@0 | 4.56 | 13 | PASS |
| 12 | 15 | 10 | 142200 | 711.0 | DFT-s-OFDM QPSK | 1@0 | 3.97 | 13 | PASS |

N12(10M)_DFT-s-OFDM_QPSK_Outer_Full_Low_CH



N12(10M)_DFT-s-OFDM_QPSK_Edge_1RB_Left_Low_CH

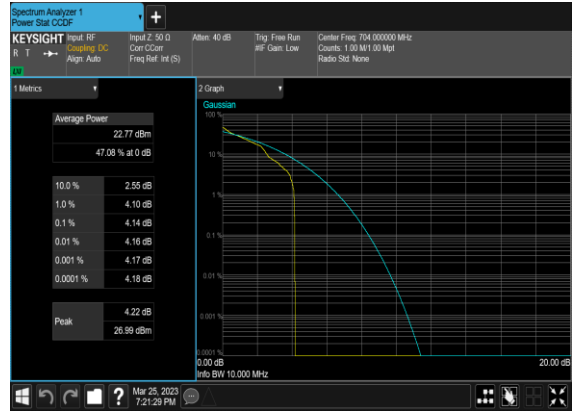

N12(10M)_DFT-s-OFDM_QPSK_Outer_Full_Mid_CH



N12(10M)_DFT-s-OFDM_QPSK_Edge_1RB_Left_Mid_CH



N12(10M)_DFT-s-OFDM_QPSK_Outer_Full_High_CH



N12(10M)_DFT-s-OFDM_QPSK_Edge_1RB_Left_High_CH

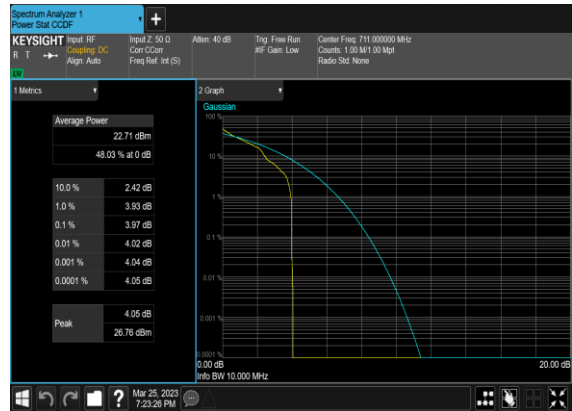

Occupied Bandwidth

| NR Band | SCS (kHz) | Bandwidth (MHz) | Arfcn | Freq (MHz) | Modulation | RB | OBW (MHz) | 26dB BW (MHz) |
|---------|-----------|-----------------|--------|------------|-----------------|------|-----------|---------------|
| 12 | 15 | 5 | 141500 | 707.5 | DFT-s-OFDM QPSK | 25@0 | 4.4719 | 4.942 |
| 12 | 15 | 5 | 141500 | 707.5 | CP-OFDM QPSK | 25@0 | 4.4654 | 5.025 |
| 12 | 15 | 5 | 141500 | 707.5 | CP-OFDM 16 QAM | 25@0 | 4.4832 | 5.124 |
| 12 | 15 | 5 | 141500 | 707.5 | CP-OFDM 64 QAM | 25@0 | 4.4653 | 5.055 |
| 12 | 15 | 5 | 141500 | 707.5 | CP-OFDM 256 QAM | 25@0 | 4.4803 | 5.053 |
| 12 | 15 | 10 | 141500 | 707.5 | DFT-s-OFDM QPSK | 50@0 | 8.9024 | 9.617 |
| 12 | 15 | 10 | 141500 | 707.5 | CP-OFDM QPSK | 52@0 | 9.2884 | 10.08 |
| 12 | 15 | 10 | 141500 | 707.5 | CP-OFDM 16 QAM | 52@0 | 9.2959 | 10.02 |
| 12 | 15 | 10 | 141500 | 707.5 | CP-OFDM 64 QAM | 52@0 | 9.2857 | 9.816 |
| 12 | 15 | 10 | 141500 | 707.5 | CP-OFDM 256 QAM | 52@0 | 9.2842 | 9.944 |
| 12 | 15 | 15 | 141500 | 707.5 | DFT-s-OFDM QPSK | 75@0 | 13.404 | 14.13 |
| 12 | 15 | 15 | 141500 | 707.5 | CP-OFDM QPSK | 79@0 | 14.091 | 14.93 |
| 12 | 15 | 15 | 141500 | 707.5 | CP-OFDM 16 QAM | 79@0 | 14.095 | 15.02 |
| 12 | 15 | 15 | 141500 | 707.5 | CP-OFDM 64 QAM | 79@0 | 14.107 | 14.78 |
| 12 | 15 | 15 | 141500 | 707.5 | CP-OFDM 256 QAM | 79@0 | 14.102 | 14.71 |

N12(5M)_DFT-s-OFDM_QPSK_Outer_Full_Mid_CH

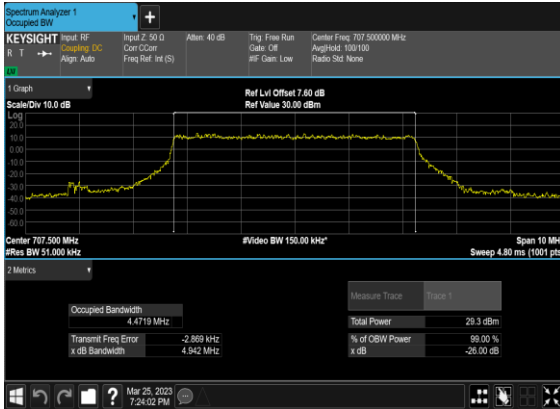

N12(5M)_CP-OFDM_QPSK_Outer_Full_Mid_CH

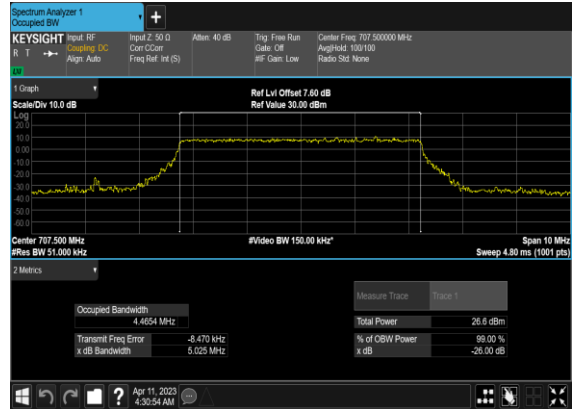

N12(5M)_CP-OFDM_16QAM_Outer_Full_Mid_CH



N12(5M)_CP-OFDM_64QAM_Outer_Full_Mid_CH

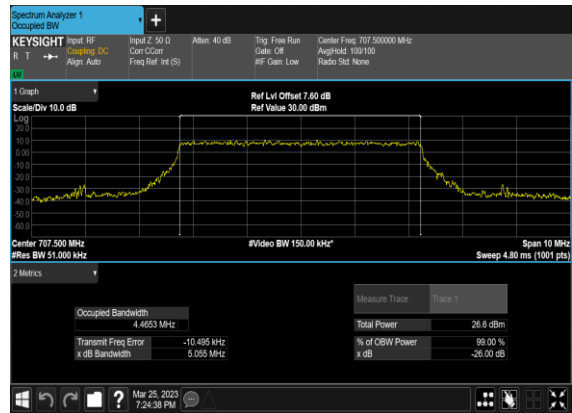

N12(5M)_CP-OFDM_256QAM_Outer_Full_Mid_CH

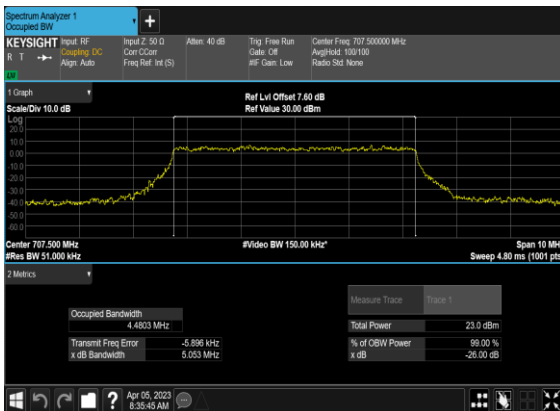

N12(10M)_DFT-s-OFDM_QPSK_Outer_Full_Mid_CH

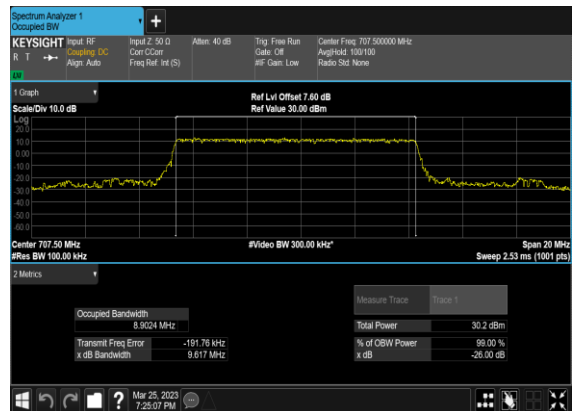

N12(10M)_CP-OFDM_QPSK_Outer_Full_Mid_CH

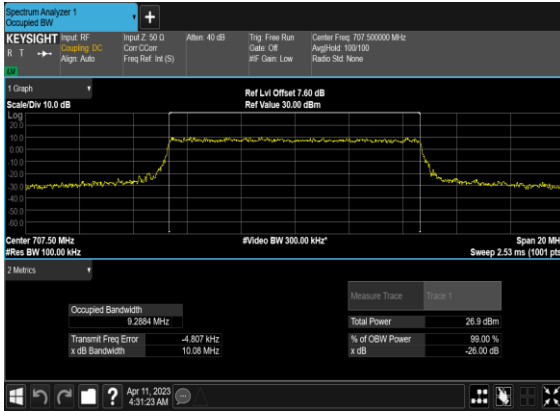

N12(10M)_CP-OFDM_16QAM_Outer_Full_Mid_CH

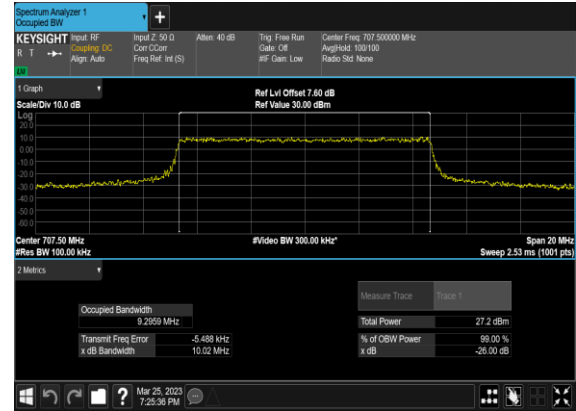

N12(10M)_CP-OFDM_64QAM_Outer_Full_Mid_CH



N12(10M)_CP-OFDM_256QAM_Outer_Full_Mid_CH

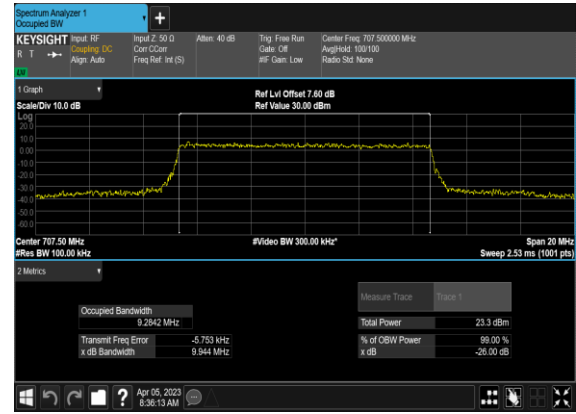

N12(15M)_DFT-s-OFDM_QPSK_Outer_Full_Mid_CH

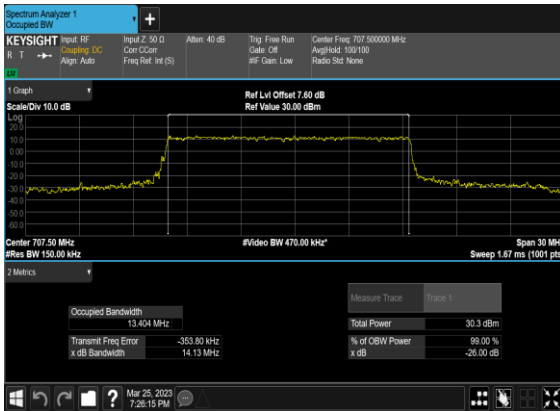

N12(15M)_CP-OFDM_QPSK_Outer_Full_Mid_CH

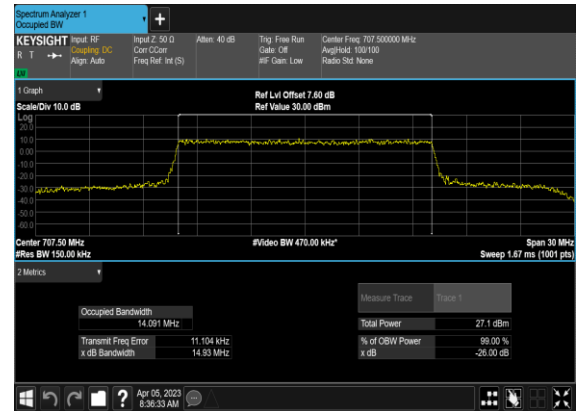

N12(15M)_CP-OFDM_16 QAM_Outer_Full_Mid_CH

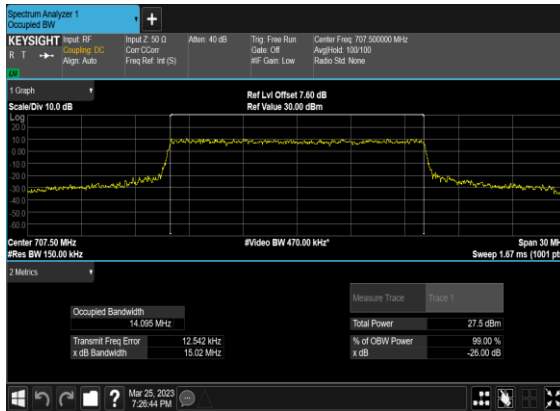

N12(15M)_CP-OFDM_64 QAM_Outer_Full_Mid_CH

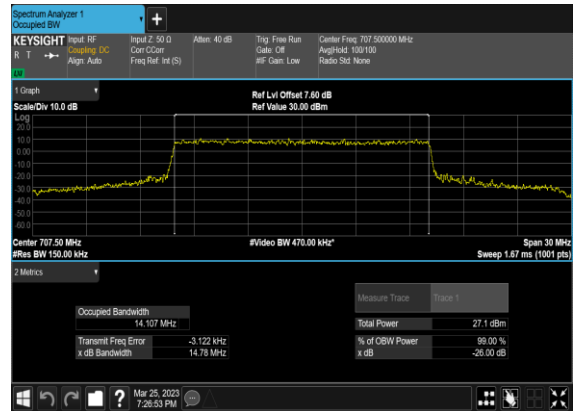

N12(15M)_CP-OFDM_256 QAM_Outer_Full_Mid_CH

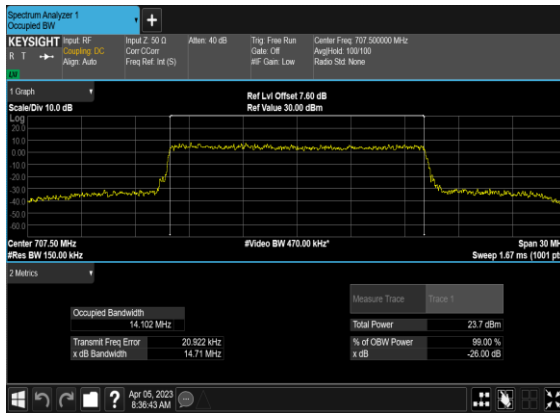

Conducted Spurious Emissions

| NR Band | SCS (kHz) | Bandwidth (MHz) | Arfcn | Freq (MHz) | Modulation | RB | Result | Verdict |
|---------|-----------|-----------------|--------|------------|-----------------|-----|-----------|-------------|
| 12 | 15 | 5 | 140300 | 701.5 | DFT-s-OFDM QPSK | 1@0 | see graph | --- |
| 12 | 15 | 5 | 140300 | 701.5 | DFT-s-OFDM QPSK | 1@0 | see graph | PASS |
| 12 | 15 | 5 | 141500 | 707.5 | DFT-s-OFDM QPSK | 1@0 | see graph | --- |
| 12 | 15 | 5 | 141500 | 707.5 | DFT-s-OFDM QPSK | 1@0 | see graph | PASS |
| 12 | 15 | 5 | 142700 | 713.5 | DFT-s-OFDM QPSK | 1@0 | see graph | --- |
| 12 | 15 | 5 | 142700 | 713.5 | DFT-s-OFDM QPSK | 1@0 | see graph | PASS |
| 12 | 15 | 10 | 140800 | 704.0 | DFT-s-OFDM QPSK | 1@0 | see graph | --- |
| 12 | 15 | 10 | 140800 | 704.0 | DFT-s-OFDM QPSK | 1@0 | see graph | PASS |
| 12 | 15 | 10 | 141500 | 707.5 | DFT-s-OFDM QPSK | 1@0 | see graph | --- |
| 12 | 15 | 10 | 141500 | 707.5 | DFT-s-OFDM QPSK | 1@0 | see graph | PASS |
| 12 | 15 | 10 | 142200 | 711.0 | DFT-s-OFDM QPSK | 1@0 | see graph | --- |
| 12 | 15 | 10 | 142200 | 711.0 | DFT-s-OFDM QPSK | 1@0 | see graph | PASS |
| 12 | 15 | 15 | 141300 | 706.5 | DFT-s-OFDM QPSK | 1@0 | see graph | --- |
| 12 | 15 | 15 | 141300 | 706.5 | DFT-s-OFDM QPSK | 1@0 | see graph | PASS |
| 12 | 15 | 15 | 141500 | 707.5 | DFT-s-OFDM QPSK | 1@0 | see graph | --- |
| 12 | 15 | 15 | 141500 | 707.5 | DFT-s-OFDM QPSK | 1@0 | see graph | PASS |
| 12 | 15 | 15 | 141700 | 708.5 | DFT-s-OFDM QPSK | 1@0 | see graph | --- |
| 12 | 15 | 15 | 141700 | 708.5 | DFT-s-OFDM QPSK | 1@0 | see graph | PASS |

N12(5M)_DFT-s-OFDM_QPSK_Edge_1RB_Left_Low_CH



N12(5M)_DFT-s-OFDM_QPSK_Edge_1RB_Left_Mid_CH

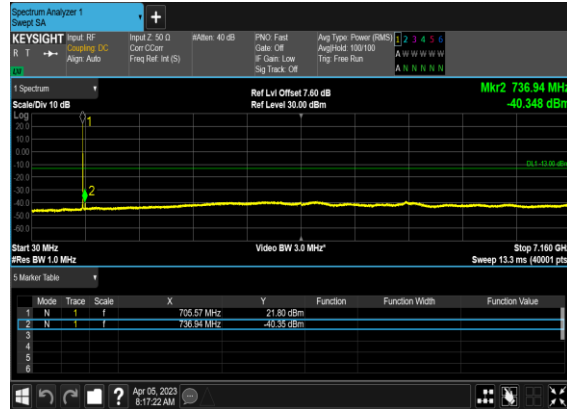

N12(5M)_DFT-s-OFDM_QPSK_Edge_1RB_Left_High_CH



N12(10M)_DFT-s-OFDM_QPSK_Edge_1RB_Left_Low_CH

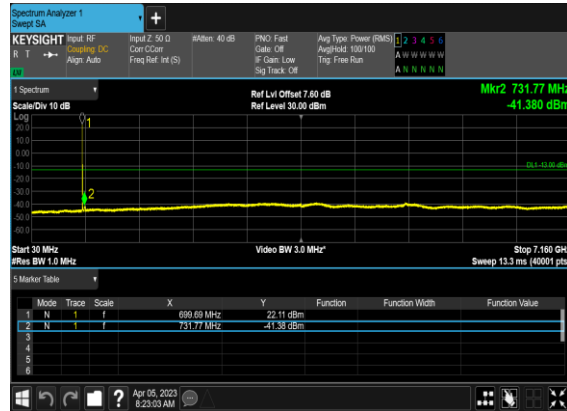

N12(10M)_DFT-s-OFDM_QPSK_Edge_1RB_Left_Mid_CH

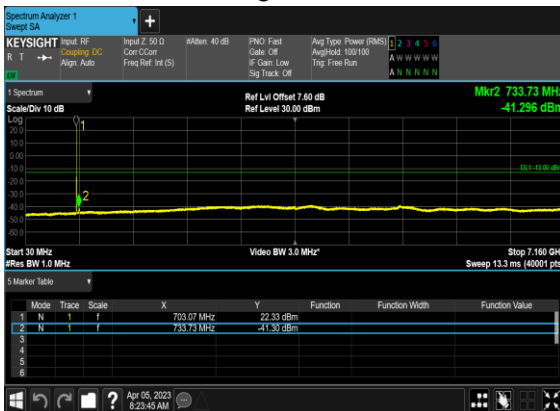

N12(10M)_DFT-s-OFDM_QPSK_Edge_1RB_Left_High_CH

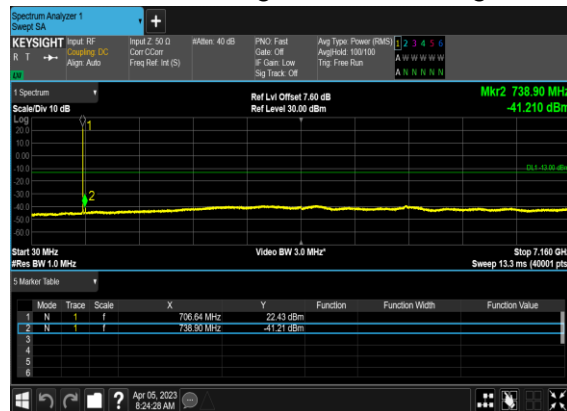

N12(15M)_DFT-s-OFDM_QPSK_Edge_1RB_Left_Low_CH

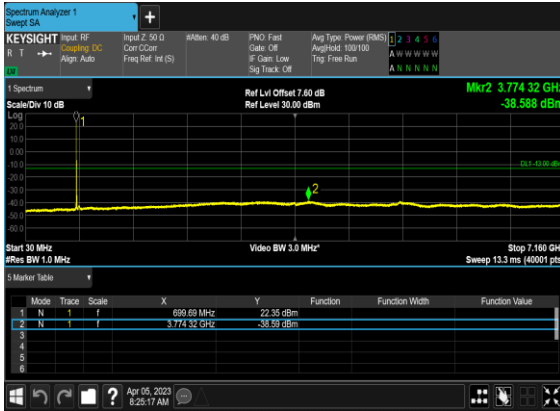

N12(15M)_DFT-s-OFDM_QPSK_Edge_1RB_Left_Mid_CH

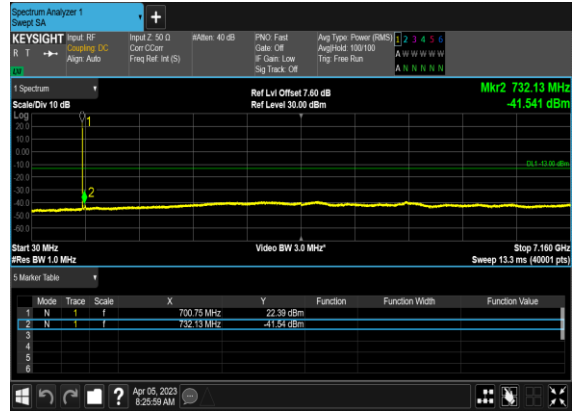

N12(15M)_DFT-s-OFDM_QPSK_Edge_1RB_Left_High_CH

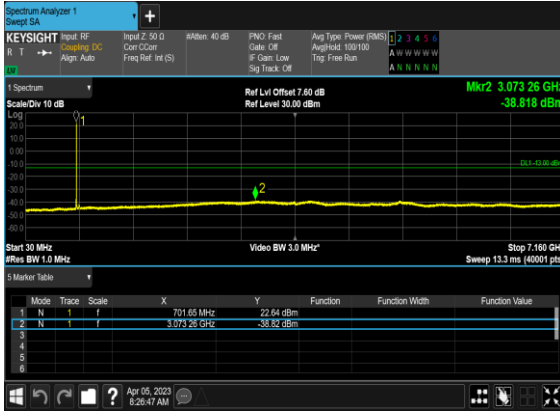

Conducted Band Edge

| NR Band | SCS (kHz) | Bandwidth (MHz) | Arfcn | Freq (MHz) | Modulation | RB | Result | Verdict |
|---------|-----------|-----------------|--------|------------|-----------------|------|-----------|---------|
| 12 | 15 | 5 | 140300 | 701.5 | DFT-s-OFDM QPSK | 1@0 | see graph | PASS |
| 12 | 15 | 5 | 140300 | 701.5 | DFT-s-OFDM QPSK | 25@0 | see graph | PASS |
| 12 | 15 | 5 | 142700 | 713.5 | DFT-s-OFDM QPSK | 1@24 | see graph | PASS |
| 12 | 15 | 5 | 142700 | 713.5 | DFT-s-OFDM QPSK | 25@0 | see graph | PASS |
| 12 | 15 | 10 | 140800 | 704.0 | DFT-s-OFDM QPSK | 1@0 | see graph | PASS |
| 12 | 15 | 10 | 140800 | 704.0 | DFT-s-OFDM QPSK | 50@0 | see graph | PASS |
| 12 | 15 | 10 | 142200 | 711.0 | DFT-s-OFDM QPSK | 1@51 | see graph | PASS |
| 12 | 15 | 10 | 142200 | 711.0 | DFT-s-OFDM QPSK | 50@0 | see graph | PASS |
| 12 | 15 | 15 | 141300 | 706.5 | DFT-s-OFDM QPSK | 1@0 | see graph | PASS |
| 12 | 15 | 15 | 141300 | 706.5 | DFT-s-OFDM QPSK | 75@0 | see graph | PASS |
| 12 | 15 | 15 | 141700 | 708.5 | DFT-s-OFDM QPSK | 1@78 | see graph | PASS |
| 12 | 15 | 15 | 141700 | 708.5 | DFT-s-OFDM QPSK | 75@0 | see graph | PASS |

N12(5M)_DFT-s-OFDM_QPSK_Edge_1RB_Left_Low_CH

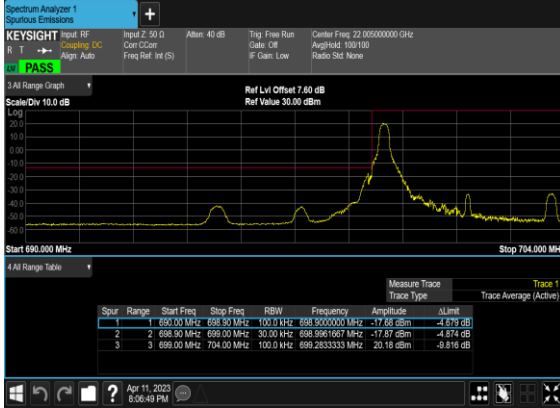

N12(5M)_DFT-s-OFDM_QPSK_Outer_Full_Low_CH



N12(5M)_DFT-s-OFDM_QPSK_Edge_1RB_Right_High_CH

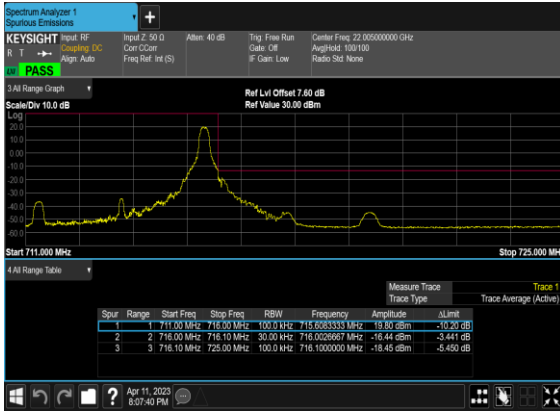

N12(5M)_DFT-s-OFDM_QPSK_Outer_Full_High_CH



N12(10M)_DFT-s-OFDM_QPSK_Edge_1RB_Left_Low_CH

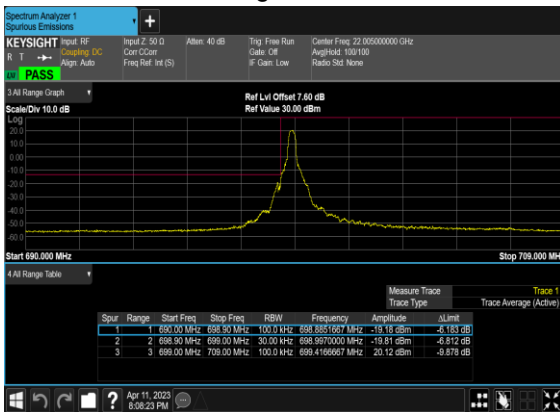

N12(10M)_DFT-s-OFDM_QPSK_Outer_Full_Low_CH

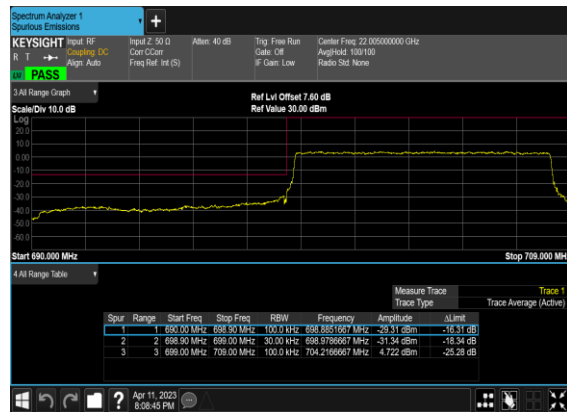

N12(10M)_DFT-s-
OFDM_QPSK_Edge_1RB_Right_High_CH

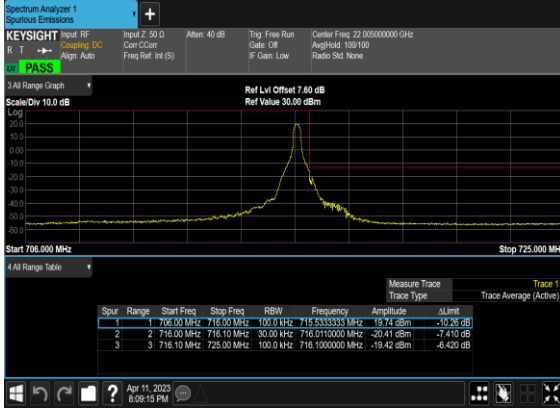

N12(10M)_DFT-s-
OFDM_QPSK_Outer_Full_High_CH



N12(15M)_DFT-s-
OFDM_QPSK_Edge_1RB_Left_Low_CH

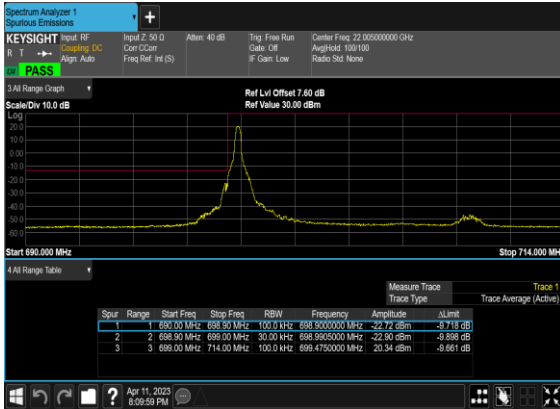

N12(15M)_DFT-s-
OFDM_QPSK_Outer_Full_Low_CH



N12(15M)_DFT-s-
OFDM_QPSK_Edge_1RB_Right_High_CH

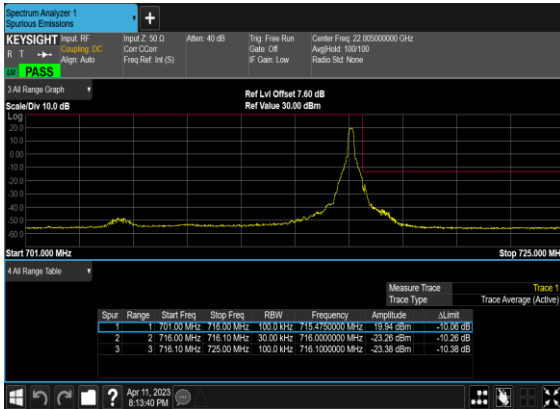

N12(15M)_DFT-s-
OFDM_QPSK_Outer_Full_High_CH

