



# FCC RF Test Report

**APPLICANT** : NOTHING TECHNOLOGY LIMITED  
**EQUIPMENT** : Smart Phone  
**BRAND NAME** : NOTHING  
**MODEL NAME** : A065  
**FCC ID** : 2AZEQ-A065  
**STANDARD** : 47 CFR Part 2, 27 Subpart O (3700-3980MHz)  
**CLASSIFICATION** : PCS Licensed Transmitter Held to Ear (PCE)  
**TEST DATE(S)** : Mar. 24, 2023 ~ Apr. 05, 2023

We, Sporton International Inc. (ShenZhen), would like to declare that the tested sample has been evaluated in accordance with the procedures given in ANSI C63.26-2015 and shown compliance with the applicable technical standards.

The test results in this report apply exclusively to the tested model / sample. Without written approval of Sporton International Inc. (ShenZhen), the test report shall not be reproduced except in full.

Jason Jia

Approved by: Jason Jia



**Sporton International Inc. (ShenZhen)**

**1/F, 2/F, Bldg 5, Shiling Industrial Zone, Xinwei Village, Xili, Nanshan, Shenzhen, 518055**

**People's Republic of China**



TABLE OF CONTENTS

REVISION HISTORY...3
SUMMARY OF TEST RESULT...4
1 GENERAL DESCRIPTION...5
1.1 Applicant...5
1.2 Manufacturer...5
1.3 Product Feature of Equipment Under Test...5
1.4 Product Specification of Equipment Under Test...5
1.5 Modification of EUT...6
1.6 Maximum EIRP and Emission Designator...6
1.7 Testing Location...7
1.8 Test Software...7
1.9 Applicable Standards...7
2 TEST CONFIGURATION OF EQUIPMENT UNDER TEST...8
2.1 Test Mode...8
2.2 Connection Diagram of Test System...9
2.3 Support Unit used in test configuration and system...9
2.4 Measurement Results Explanation Example...9
2.5 Frequency List of Low/Middle/High Channels...10
3 CONDUCTED TEST ITEMS...11
3.1 Measuring Instruments...11
3.2 Test Setup...11
3.3 Test Result of Conducted Test...11
3.4 Conducted Output Power and EIRP...12
3.5 Peak-to-Average Ratio...13
3.6 Occupied Bandwidth...14
3.7 Conducted Band Edge...15
3.8 Conducted Spurious Emission...16
3.9 Frequency Stability...17
4 RADIATED TEST ITEMS...18
4.1 Measuring Instruments...18
4.2 Test Setup...18
4.3 Test Result of Radiated Test...19
4.4 Radiated Spurious Emission...20
5 LIST OF MEASURING EQUIPMENT...21
6 UNCERTAINTY OF EVALUATION...22
APPENDIX A. TEST RESULTS OF CONDUCTED TEST
APPENDIX B. TEST RESULTS OF RADIATED TEST
APPENDIX C. TEST SETUP PHOTOGRAPHS





### SUMMARY OF TEST RESULT

Report Section	FCC Rule	Description	Limit	Result	Remark
3.4	§2.1046	Conducted Output Power	Reporting Only	PASS	-
	§27.50(j)(3)	Equivalent Isotropic Radiated Power	EIRP < 1Watt		
3.5	§27.50(j)(4)	Peak-to-Average Ratio	<13 dB	PASS	-
3.6	§2.1049	Occupied Bandwidth	Reporting Only	PASS	-
3.7	§2.1051 §27.53(l)(2)	Conducted Band Edge Measurement	< 43+10log10(P[Watts])	PASS	-
3.8	§2.1051 §27.53(l)(2)	Conducted Spurious Emission	< 43+10log10(P[Watts])	PASS	-
3.9	§27.54	Frequency Stability Temperature & Voltage	Within Authorized Band	PASS	-
4.4	§2.1053 §27.53(l)(2)	Radiated Spurious Emission	< 43+10log <sub>10</sub> (P[Watts])	PASS	Under limit 15.65 dB at 7765.770 MHz

<b>Declaration of Conformity:</b>
The test results with all measurement uncertainty excluded are presented in accordance with the regulation limits or requirements declared by manufacturers.
<b>Comments and Explanations:</b>
The declared of product specification for EUT presented in the report are provided by the manufacturer, and the manufacturer takes all the responsibilities for the accuracy of product specification.



# 1 General Description

## 1.1 Applicant

NOTHING TECHNOLOGY LIMITED  
80 Cheapside, London, England EC2V 6EE

## 1.2 Manufacturer

NOTHING TECHNOLOGY LIMITED  
80 Cheapside, London, England EC2V 6EE

## 1.3 Product Feature of Equipment Under Test

Product Feature	
Equipment	Smart Phone
Brand Name	NOTHING
Model Name	A065
FCC ID	2AZEQ-A065
IMEI Code	Conducted : 352134980027149/352134980027156 Radiation : 352134980041884/352134980041892
HW Version	22111
SW Version	Nothing OS 2.0.0
EUT Stage	Identical Prototype

## 1.4 Product Specification of Equipment Under Test

Standards-related Product Specification	
Tx/Rx Frequency	5G NR n77: 3700 MHz ~ 3980 MHz
SCS	30kHz
Bandwidth	20 / 30 / 40 / 60 / 80 / 100MHz
Antenna Gain	<Ant. 3>: -2.04 dBi <Ant. 4>: -2.23 dBi <Ant. 6>: -0.28 dBi <Ant. 8>: -1.46 dBi
Type of Modulation	CP-OFDM: QPSK / 16QAM / 64QAM / 256QAM DFT-s-OFDM: QPSK / 16QAM / 64QAM / 256QAM

**Remark:**

1. The maximum EIRP is calculated from max output power and max antenna gain, only the maximum EIRP is shown in the report, 5G NR n77 for Antenna 4.
2. The device supports n77(1T4R) SRS resources on Antenna 3/4/6/8, only the test data of worst Antenna 4 is showed in the report according to the maximum power.
3. 5G NR n77 support SA and NSA mode. The whole testing has assessed SA mode by referring to the higher conducted power for conducted test items.
4. The device supports HPUE mode for 5G NR n77.



- 5. All the supported EN-DC combinations are verified conducted power, only the EN-DC combination with highest power are shown in the report.
- 6. The EN-DC mode combination could be referred to the product spec.

### 1.5 Modification of EUT

No modifications are made to the EUT during all test items.

### 1.6 Maximum EIRP and Emission Designator

5G NR n77 SA		QPSK		16QAM / 64QAM / 256QAM	
BW (MHz)	Frequency Range (MHz)	Maximum EIRP(W)	Emission Designator (99%OBW)	Maximum EIRP(W)	Emission Designator (99%OBW)
20	3710.01 ~ 3969.99	0.2046	18M2G7D	0.1629	18M2W7D
30	3715.02 ~ 3964.98	0.2094	27M8G7D	0.1706	27M9W7D
40	3720.00 ~ 3960.00	0.2148	37M9G7D	0.1722	37M9W7D
60	3730.02 ~ 3949.98	0.2143	57M9G7D	0.1746	57M9W7D
80	3740.01 ~ 3939.99	0.2089	77M7G7D	0.1714	77M6W7D
100	3750.00 ~ 3930.00	0.2208	97M7G7D	0.1811	97M8W7D

Note: All modulations have been tested, and only the worst test results of PSK & QAM are shown in the report.



### 1.7 Testing Location

Sporton International Inc. (ShenZhen) is accredited to ISO/IEC 17025:2017 by American Association for Laboratory Accreditation with Certificate Number 5145.01.

<b>Test Firm</b>	Sporton International Inc. (ShenZhen)		
<b>Test Site Location</b>	1/F, 2/F, Bldg 5, Shiling Industrial Zone, Xinwei Village, Xili, Nanshan, Shenzhen, 518055 People's Republic of China TEL: +86-755-86379589 FAX: +86-755-86379595		
<b>Test Site No.</b>	<b>Sporton Site No.</b>	<b>FCC Designation No.</b>	<b>FCC Test Firm Registration No.</b>
	TH01-SZ	CN1256	421272

<b>Test Firm</b>	Sporton International Inc. (ShenZhen)		
<b>Test Site Location</b>	101, 1st Floor, Block B, Building 1, No. 2, Tengfeng 4th Road, Fenghuang Community, Fuyong Street, Baoan District, Shenzhen City Guangdong Province China 518103 TEL: +86-755-33202398		
<b>Test Site No.</b>	<b>Sporton Site No.</b>	<b>FCC Designation No.</b>	<b>FCC Test Firm Registration No.</b>
	03CH04-SZ	CN1256	421272

### 1.8 Test Software

Item	Site	Manufacturer	Name	Version
1.	03CH04-SZ	AUDIX	E3	6.2009-8-24

### 1.9 Applicable Standards

According to the specifications of the manufacturer, the EUT must comply with the requirements of the following standards:

- ♦ 47 CFR Part 2, 27
- ♦ ANSI C63.26-2015
- ♦ FCC KDB 971168 D01 Power Meas License Digital Systems v03r01
- ♦ FCC KDB 412172 D01 Determining ERP and EIRP v01r01

**Remark:** All test items were verified and recorded according to the standards and without any deviation during the test.



## 2 Test Configuration of Equipment Under Test

### 2.1 Test Mode

Antenna port conducted and radiated test items are performed according to KDB 971168 D01 Power Meas License Digital Systems v03r01 with maximum output power.

For radiated measurement, pre-scanned in three orthogonal panels, X, Y, Z. The worst cases (X plane) were recorded in this report.

The device is investigated from 30MHz to 10 times of fundamental signal for radiated spurious emission test under different RB size/offset and modulations in exploratory test. Subsequently, only the worst case emissions are reported.

Orthogonal Planes of EUT	X Plane	Y Plane	Z Plane
			

Test Items	5G NR	Bandwidth (MHz)										Modulation					RB #			Test Channel		
		10	15	20	25	30	40	50	60	80	100	PI/2 BPSK	QPSK	16QAM	64QAM	256 QAM	1	Partial	Full	L	M	H
Max. Output Power	n77	-	-	v	-	v	v	-	v	v	v	-	v	v	v	v	v		v	v	v	v
Peak-to-Average Ratio	n77	-	-	v	-			-				-	v				v		v	v	v	v
26dB and 99% Bandwidth	n77	-	-	v	-	v	v	-	v	v	v	-	v	v	v	v			v		v	
Conducted Band Edge	n77	-	-	v	-			-	v		v	-	v				v		v	v		v
Conducted Spurious Emission	n77	-	-	v	-			-	v		v	-	v				v			v	v	v
Frequency Stability	n77	-	-	v	-			-				-	v						v		v	
E.I.R.P	n77	-	-	v	-	v	v	-	v	v	v	-	v	v	v	v	v		v	v	v	v
Radiated Spurious Emission	n77	Worst Case																		v	v	v
Note	<ol style="list-style-type: none"> <li>The mark "v" means that this configuration is chosen for testing</li> <li>The mark "-" means that this bandwidth is not supported.</li> <li>The device is investigated from 30MHz to 10 times of fundamental signal for radiated spurious emission test under different RB size/offset and modulations in exploratory test. Subsequently, only the worst case emissions are reported.</li> <li>Frequency Stability : Normal Voltage = 3.89V; Low Voltage =3.6V; High Voltage =4.48V.</li> </ol>																					



## 2.2 Connection Diagram of Test System

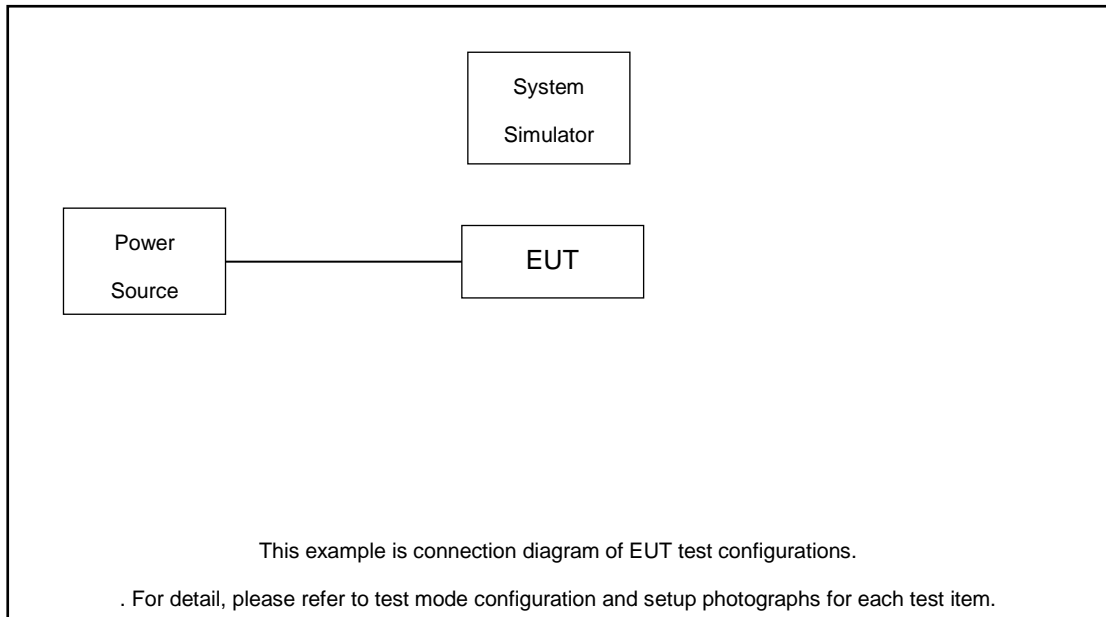

## 2.3 Support Unit used in test configuration and system

Item	Equipment	Trade Name	Model No.	FCC ID	Data Cable	Power Cord
1.	DC Power Supply	GW	GPS-3030D	N/A	N/A	Unshielded, 1.8 m
2.	LTE Base Station	Anritsu	MT8821C	N/A	N/A	Unshielded, 1.8 m
3.	NR Base Station	Anritsu	MT8000A	N/A	N/A	Unshielded, 1.8 m

## 2.4 Measurement Results Explanation Example

### For all conducted test items:

The offset level is set in the spectrum analyzer to compensate the RF cable loss and attenuator factor between EUT conducted output port and spectrum analyzer. With the offset compensation, the spectrum analyzer reading level is exactly the EUT RF output level.

The spectrum analyzer offset is derived from RF cable loss and attenuator factor.

*Offset = RF cable loss + attenuator factor.*

Following shows an offset computation example with cable loss 5.68 dB and 10dB attenuator.

Example :

$$\begin{aligned} \text{Offset(dB)} &= \text{RF cable loss(dB)} + \text{attenuator factor(dB)}. \\ &= 5.68 + 10 = 15.68 \text{ (dB)} \end{aligned}$$



### 2.5 Frequency List of Low/Middle/High Channels

5G n77 (30kHz) Channel and Frequency List				
BW [MHz]	Channel/Frequency(MHz)	Lowest	Middle	Highest
100	Channel	650000	656000	662000
	Frequency	3750	3840	3930
80	Channel	649334	656000	662666
	Frequency	3740.01	3840	3939.99
60	Channel	648668	656000	663332
	Frequency	3730.02	3840	3949.98
40	Channel	648000	656000	664000
	Frequency	3720	3840	3960
30	Channel	647668	656000	664332
	Frequency	3715.02	3840	3964.98
20	Channel	647334	656000	664666
	Frequency	3710.01	3840	3969.99

### 3 Conducted Test Items

#### 3.1 Measuring Instruments

See list of measuring instruments of this test report.

#### 3.2 Test Setup

##### 3.2.1 Conducted Output Power



##### 3.2.2 Peak-to-Average Ratio, Occupied Bandwidth, Conducted Band-Edge and Conducted Spurious Emission



##### 3.2.3 Frequency Stability

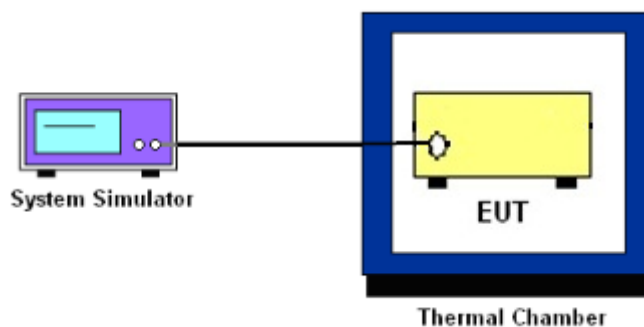

### 3.3 Test Result of Conducted Test

Please refer to Appendix A.



### 3.4 Conducted Output Power and EIRP

#### 3.4.1 Description of the Conducted Output Power Measurement and EIRP Measurement

A system simulator was used to establish communication with the EUT. Its parameters were set to force the EUT transmitting at maximum output power. The measured power in the radio frequency on the transmitter output terminals shall be reported.

The EIRP of mobile transmitters must not exceed 1 Watts for 5G NR n77.

According to KDB 412172 D01 Power Approach,

$EIRP = P_T + G_T - L_C$ ,  $ERP = EIRP - 2.15$ , where

$P_T$  = transmitter output power in dBm

$G_T$  = gain of the transmitting antenna in dBi

$L_C$  = signal attenuation in the connecting cable between the transmitter and antenna in dB

#### 3.4.2 Test Procedures

1. The testing follows ANSI C63.26 Section 5.2
2. The transmitter output port was connected to the system simulator.
3. Set EUT at maximum power through the system simulator.
4. Select lowest, middle, and highest channels for each band and different modulation.
5. Measure and record the power level from the system simulator.



## **3.5 Peak-to-Average Ratio**

### **3.5.1 Description of the PAR Measurement**

Power Complementary Cumulative Distribution Function (CCDF) curves provide a means for characterizing the power peaks of a digitally modulated signal on a statistical basis. A CCDF curve depicts the probability of the peak signal amplitude exceeding the average power level. Most contemporary measurement instrumentation include the capability to produce CCDF curves for an input signal provided that the instrument's resolution bandwidth can be set wide enough to accommodate the entire input signal bandwidth. In measuring transmissions in this band using an average power technique, the peak-to-average ratio (PAR) of the transmission may not exceed 13 dB.

### **3.5.2 Test Procedures**

1. The testing follows ANSI C63.26 Section 5.2.3.4 (CCDF).
2. The EUT was connected to spectrum and system simulator via a power divider.
3. Set the CCDF (Complementary Cumulative Distribution Function) option in spectrum analyzer.
4. The highest RF powers were measured and recorded the maximum PAPR level associated with a probability of 0.1 %.
5. Record the deviation as Peak to Average Ratio.



## 3.6 Occupied Bandwidth

### 3.6.1 Description of Occupied Bandwidth Measurement

The occupied bandwidth is the width of a frequency band such that, below the lower and above the upper frequency limits, the mean powers emitted are each equal to a specified percentage 0.5% of the total mean transmitted power.

The 26 dB emission bandwidth is defined as the frequency range between two points, one above and one below the carrier frequency, at which the spectral density of the emission is attenuated 26 dB below the maximum in-band spectral density of the modulated signal. Spectral density (power per unit bandwidth) is to be measured with a detector of resolution bandwidth equal to approximately 1.0% of the emission bandwidth.

### 3.6.2 Test Procedures

1. The testing follows ANSI C63.26 Section 5.4
2. The EUT was connected to spectrum analyzer and system simulator via a power divider.
3. The spectrum analyzer center frequency is set to the nominal EUT channel center frequency. The span range for the spectrum analyzer shall be between two and five times the anticipated OBW.
4. The nominal resolution bandwidth (RBW) shall be in the range of 1 to 5 % of the anticipated OBW, and the VBW shall be at least 3 times the RBW.
5. Set the detection mode to peak, and the trace mode to max hold.
6. Determine the reference value: Set the EUT to transmit a modulated signal. Allow the trace to stabilize. Set the spectrum analyzer marker to the highest level of the displayed trace.  
(this is the reference value)
7. Determine the “-26 dB down amplitude” as equal to (Reference Value – X).
8. Place two markers, one at the lowest and the other at the highest frequency of the envelope of the spectral display such that each marker is at or slightly below the “-X dB down amplitude” determined in step 6. If a marker is below this “-X dB down amplitude” value it shall be placed as close as possible to this value. The OBW is the positive frequency difference between the two markers.
9. Use the 99 % power bandwidth function of the spectrum analyzer and report the measured bandwidth.



### 3.7 Conducted Band Edge

#### 3.7.1 Description of Conducted Band Edge Measurement

27.53(l)(2)

For mobile operations in the 3700-3980 MHz band, the conducted power of any emission outside the licensee's authorized bandwidth shall not exceed -13 dBm/MHz. Compliance with this paragraph is based on the use of measurement instrumentation employing a resolution bandwidth of 1 megahertz or greater. However, in the 1 megahertz bands immediately outside and adjacent to the licensee's frequency block, the minimum resolution bandwidth for the measurement shall be either one percent of the emission bandwidth of the fundamental emission of the transmitter or 350 kHz. In the bands between 1 and 5 MHz removed from the licensee's frequency block, the minimum resolution bandwidth for the measurement shall be 500 kHz.

#### 3.7.2 Test Procedures

1. The testing follows ANSI C63.26 section 5.7
2. The EUT was connected to spectrum analyzer and system simulator via a power divider.
3. The band edges of low and high channels for the highest RF powers were measured.
4. Set RBW  $\geq$  1% EBW in the 1MHz band immediately outside and adjacent to the band edge.
5. Beyond the 1 MHz band from the band edge, RBW=1MHz was used or a narrower RBW was used (generally limited to no less than 1% of the OBW) and the measured power was integrated over the full required measurement bandwidth.
6. Set spectrum analyzer with RMS detector.
7. The RF fundamental frequency should be excluded against the limit line in the operating frequency band.
8. Checked that all the results comply with the emission limit line.

Example:

$$\begin{aligned} & \text{The limit line is derived from } 43 + 10\log(P)\text{dB below the transmitter power } P(\text{Watts}) \\ & = P(\text{W}) - [43 + 10\log(P)] \text{ (dB)} \\ & = [30 + 10\log(P)] \text{ (dBm)} - [43 + 10\log(P)] \text{ (dB)} = -13\text{dBm.} \end{aligned}$$

9. When using the integration method, the starting frequency of the integration shall be centered at one-half of the RBW away from the band edge.



### 3.8 Conducted Spurious Emission

#### 3.8.1 Description of Conducted Spurious Emission Measurement

The power of any emission outside of the authorized operating frequency ranges must be lower than the transmitter power (P) by a factor of at least  $43 + 10 \log (P)$  dB.

It is measured by means of a calibrated spectrum analyzer and scanned from 30 MHz up to a frequency including its 10<sup>th</sup> harmonic.

#### 3.8.2 Test Procedures

1. The testing follows ANSI C63.26 section 5.7
2. The EUT was connected to spectrum analyzer and system simulator via a power divider.
3. The RF output of EUT was connected to the spectrum analyzer by RF cable and attenuator. The path loss was compensated to the results for each measurement.
4. The middle channel for the highest RF power within the transmitting frequency was measured.
5. The conducted spurious emission for the whole frequency range was taken.
6. Make the measurement with the spectrum analyzer's RBW = 1MHz, VBW = 3MHz.
7. Set spectrum analyzer with RMS detector.
8. Taking the record of maximum spurious emission.
9. The RF fundamental frequency should be excluded against the limit line in the operating frequency band.
10. The limit line is derived from  $43 + 10\log(P)$ dB below the transmitter power P(Watts)  
= P(W)- [43 + 10log(P)] (dB)  
= [30 + 10log(P)] (dBm) - [43 + 10log(P)] (dB)  
= -13dBm.





## 3.9 Frequency Stability

### 3.9.1 Description of Frequency Stability Measurement

The frequency stability shall be measured by variation of ambient temperature and variation of primary supply voltage to ensure that the fundamental emission stays within the authorized frequency block. The frequency stability of the transmitter shall be maintained within  $\pm 0.00025\%$  ( $\pm 2.5\text{ppm}$ ) of the center frequency.

### 3.9.2 Test Procedures for Temperature Variation

1. The testing follows ANSI C63.26 section 5.6.4
2. The EUT was set up in the thermal chamber and connected with the system simulator.
3. With power OFF, the temperature was decreased to  $-30^{\circ}\text{C}$  and the EUT was stabilized before testing. Power was applied and the maximum change in frequency was recorded within one minute.
4. With power OFF, the temperature was raised in  $10^{\circ}\text{C}$  step up to  $50^{\circ}\text{C}$ . The EUT was stabilized at each step for at least half an hour. Power was applied and the maximum frequency change was recorded within one minute.

### 3.9.3 Test Procedures for Voltage Variation

1. The testing follows ANSI C63.26 section 5.6.5
2. The EUT was placed in a temperature chamber at  $20\pm 5^{\circ}\text{C}$  and connected with the system simulator.
3. The power supply voltage to the EUT was varied from 85% to 115% of the nominal value for other than hand carried battery equipment.
4. For hand carried, battery powered equipment, reduce the primary ac or dc supply voltage to the battery operating end point, which shall be specified by the manufacturer.
5. The variation in frequency was measured for the worst case.

## 4 Radiated Test Items

### 4.1 Measuring Instruments

See list of measuring instruments of this test report.

### 4.2 Test Setup

#### 4.2.1 For radiated test below 30MHz

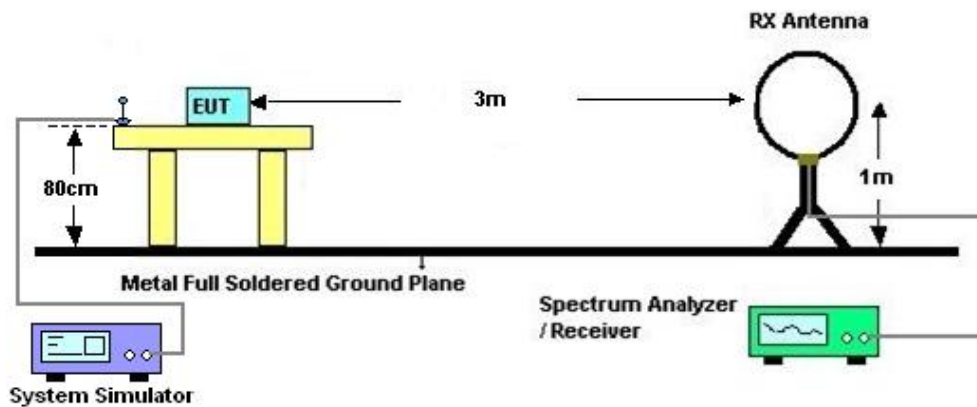

#### 4.2.2 For radiated test from 30MHz to 1GHz

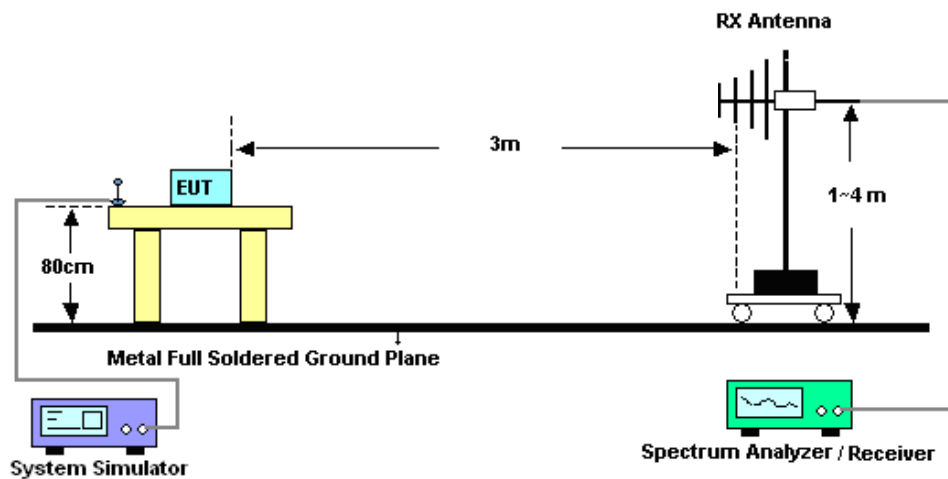

#### 4.2.3 For radiated test above 1GHz

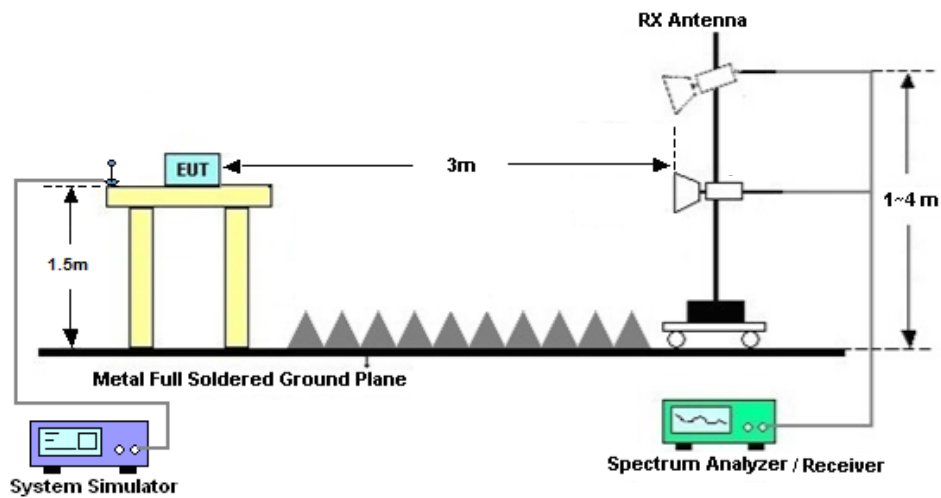

### 4.3 Test Result of Radiated Test

The low frequency, which started from 9 kHz to 30MHz, was pre-scanned and the result which was 20dB lower than the limit line was not reported.

Please refer to Appendix B.



## 4.4 Radiated Spurious Emission

### 4.4.1 Description of Radiated Spurious Emission

The radiated spurious emission was measured by substitution method according to ANSI C63.26. The power of any emission outside of the authorized operating frequency ranges must be attenuated below the transmitter power (P) by a factor of at least  $43 + 10 \log (P)$  dB. The spectrum is scanned from 30 MHz up to a frequency including its 10th harmonic.

### 4.4.2 Test Procedures

1. The testing follows ANSI C63.26 Section 5.5
2. The EUT was placed on a turntable with 0.8 meter height for frequency below 1GHz and 1.5 meter height for frequency above 1GHz respectively above ground.
3. The EUT was set 3 meters from the receiving antenna mounted on the antenna tower.
4. The table was rotated 360 degrees to determine the position of the highest spurious emission.
5. The height of the receiving antenna is varied between 1m to 4m to search the maximum spurious emission for both horizontal and vertical polarizations.
6. During the measurement, the system simulator parameters were set to force the EUT transmitting at maximum output power.
7. Make the measurement with the spectrum analyzer's RBW = 1MHz, VBW = 3MHz, taking the record of maximum spurious emission.
8. A horn antenna was substituted in place of the EUT and was driven by a signal generator.
9. Tune the output power of signal generator to the same emission level with EUT maximum spurious emission.
10.  $EIRP (dBm) = S.G. Power - Tx Cable Loss + Tx Antenna Gain$
11.  $ERP (dBm) = EIRP - 2.15$
12. The RF fundamental frequency should be excluded against the limit line in the operating frequency band.

The limit line is derived from  $43 + 10\log(P)$ dB below the transmitter power P(Watts)  
=  $P(W) - [43 + 10\log(P)] (dB)$   
=  $[30 + 10\log(P)] (dBm) - [43 + 10\log(P)] (dB)$   
= -13dBm.



## 5 List of Measuring Equipment

Instrument	Manufacturer	Model No.	Serial No.	Characteristics	Calibration Date	Test Date	Due Date	Remark
Spectrum Analyzer	R&S	FSV40	101078	10Hz~40GHz	Apr. 07, 2022	Mar. 24, 2023~Apr. 05, 2023	Apr. 06, 2023	Conducted (TH01-SZ)
Power Divider	TOJOIN	PS-2SM-04 265	60.06.020.007 7	0.4GHz~26.5GHz	Dec. 25, 2022	Mar. 24, 2023~Apr. 05, 2023	Dec. 24, 2023	Conducted (TH01-SZ)
Thermal Chamber	Ten Billion Hongzhangroup	LP-150U	H2014081803	-40~+150°C	Jul. 07, 2022	Mar. 24, 2023~Apr. 05, 2023	Jul. 06, 2023	Conducted (TH01-SZ)
EMI Test Receiver	R&S	ESR7	101404	9kHz~7GHz	Oct. 19, 2022	Mar. 28, 2023	Oct. 18, 2023	Radiation (03CH04-SZ)
EXA Spectrum Analyzer	KEYSIGHT	N9010A	MY55150213	10Hz~44GHz	Jul. 07, 2022	Mar. 28, 2023	Jul. 06, 2023	Radiation (03CH04-SZ)
Loop Antenna	R&S	HFH2-Z2	100354	9kHz~30MHz	Jun. 28, 2022	Mar. 28, 2023	Jun. 27, 2024	Radiation (03CH04-SZ)
Bilog Antenna	TeseQ	CBL6111D	41909	30MHz~1GHz	Apr. 27, 2022	Mar. 28, 2023	Apr. 27, 2023	Radiation (03CH04-SZ)
Double Ridge Horn Antenna	SCHWARZBECK	BBHA9120D	9120D-1474	1GHz~18GHz	Jul. 07, 2022	Mar. 28, 2023	Jul. 06, 2023	Radiation (03CH04-SZ)
Horn Antenna	SCHWARZBECK	BBHA9170	9170#679	15GHz~40GHz	Jul. 07, 2022	Mar. 28, 2023	Jul. 06, 2023	Radiation (03CH04-SZ)
Amplifier	Burgeon	BPA-530	102211	0.01Hz ~3000MHz	Oct. 19, 2022	Mar. 28, 2023	Oct. 18, 2023	Radiation (03CH04-SZ)
HF Amplifier	MITEQ	AMF-7D-00 101800-30-1 0P-R	1943528	1GHz~18GHz	Oct. 19, 2022	Mar. 28, 2023	Oct. 18, 2023	Radiation (03CH04-SZ)
HF Amplifier	MITEQ	TTA1840-35 -HG	1871923	18GHz~40GHz	Jul. 06, 2022	Mar. 28, 2023	Jul. 05, 2023	Radiation (03CH04-SZ)
Amplifier	Agilent Technologies	83017A	MY57280136	500MHz~26.5GHz	Sep. 30, 2022	Mar. 28, 2023	Sep. 29, 2023	Radiation (03CH04-SZ)
AC Power Source	APC	AFV-S-600B	F119050019	N/A	Nov. 10, 2022	Mar. 28, 2023	Nov. 10, 2023	Radiation (03CH04-SZ)
Turn Table	EM	EM1000	N/A	0~360 degree	NCR	Mar. 28, 2023	NCR	Radiation (03CH04-SZ)
Antenna Mast	EM	EM1000	N/A	1 m~4 m	NCR	Mar. 28, 2023	NCR	Radiation (03CH04-SZ)

NCR: No Calibration Required



## 6 Uncertainty of Evaluation

The measurement uncertainties shown below were calculated in accordance with the requirements of ANSI 63.26-2015. All the measurement uncertainty value were shown with a coverage K=2 to indicate 95% level of confidence. The measurement data show herein meets or exceeds the CISPR measurement uncertainty values specified in CISPR 16-4-2 and can be compared directly to specified limit to determine compliance.

### Uncertainty of Conducted Measurement

Test Item	Uncertainty
Conducted Power	±1.34 dB
Conducted Emissions	±1.34 dB
Occupied Channel Bandwidth	±0.13 %

### Uncertainty of Radiated Emission Measurement (30 MHz ~ 1000 MHz)

Measuring Uncertainty for a Level of Confidence of 95% (U = 2Uc(y))	2.8dB
---	-------

### Uncertainty of Radiated Emission Measurement (1000 MHz ~ 18000 MHz)

Measuring Uncertainty for a Level of Confidence of 95% (U = 2Uc(y))	3.1dB
---	-------

### Uncertainty of Radiated Emission Measurement (18000 MHz ~ 40000 MHz)

Measuring Uncertainty for a Level of Confidence of 95% (U = 2Uc(y))	3.9dB
---	-------

----- THE END -----



## Appendix A. Test Results of Conducted Test

Test Engineer :	Khan Zhen	Temperature :	24~26°C
		Relative Humidity :	50~53%

## FR1 N77 (ANT4)

### Transmitter Conducted Output Power And EIRP, (G<sub>T</sub> - L<sub>C</sub>)=-2.23dB

NR Band	SCS (kHz)	Bandwidth (MHz)	Arfcn	Freq (MHz)	Modulation	RB	Conducted Power(dBm)	EIRP (dBm)	EIRP (W)
77	30	20	647334	3710.01	DFT-s-OFDM QPSK	1@1	25.19	22.96	0.1977
77	30	20	647334	3710.01	DFT-s-OFDM 16 QAM	1@1	24.23	22	0.1585
77	30	20	656000	3840	DFT-s-OFDM QPSK	1@1	25.34	23.11	0.2046
77	30	20	656000	3840	DFT-s-OFDM 16 QAM	1@1	24.35	22.12	0.1629
77	30	20	664666	3969.99	DFT-s-OFDM QPSK	1@1	25.14	22.91	0.1954
77	30	20	664666	3969.99	DFT-s-OFDM 16 QAM	1@1	24.12	21.89	0.1545
77	30	30	647668	3715.02	DFT-s-OFDM QPSK	1@1	25.15	22.92	0.1959
77	30	30	647668	3715.02	DFT-s-OFDM 16 QAM	1@1	24.34	22.11	0.1626
77	30	30	656000	3840	DFT-s-OFDM QPSK	1@1	25.41	23.18	0.2080
77	30	30	656000	3840	DFT-s-OFDM 16 QAM	1@1	24.55	22.32	0.1706
77	30	30	664332	3964.98	DFT-s-OFDM QPSK	1@1	25.44	23.21	0.2094
77	30	30	664332	3964.98	DFT-s-OFDM 16 QAM	1@1	24.5	22.27	0.1687
77	30	40	648000	3720	DFT-s-OFDM QPSK	1@1	25.4	23.17	0.2075
77	30	40	648000	3720	DFT-s-OFDM 16 QAM	1@1	24.37	22.14	0.1637
77	30	40	656000	3840	DFT-s-OFDM QPSK	1@1	25.54	23.31	0.2143
77	30	40	656000	3840	DFT-s-OFDM 16 QAM	1@1	24.59	22.36	0.1722
77	30	40	664000	3960	DFT-s-OFDM QPSK	1@1	25.55	23.32	0.2148
77	30	40	664000	3960	DFT-s-OFDM 16 QAM	1@1	24.56	22.33	0.1710
77	30	60	648668	3730.02	DFT-s-OFDM QPSK	1@1	24.97	22.74	0.1879
77	30	60	648668	3730.02	DFT-s-OFDM 16 QAM	1@1	24.05	21.82	0.1521
77	30	60	656000	3840	DFT-s-OFDM QPSK	1@1	25.09	22.86	0.1932
77	30	60	656000	3840	DFT-s-OFDM 16 QAM	1@1	24.24	22.01	0.1589
77	30	60	663332	3949.98	DFT-s-OFDM QPSK	1@1	25.54	23.31	0.2143
77	30	60	663332	3949.98	DFT-s-OFDM 16 QAM	1@1	24.65	22.42	0.1746
77	30	80	649334	3740.01	DFT-s-OFDM QPSK	1@1	24.78	22.55	0.1799
77	30	80	649334	3740.01	DFT-s-OFDM 16 QAM	1@1	23.92	21.69	0.1476
77	30	80	656000	3840	DFT-s-OFDM QPSK	1@1	24.91	22.68	0.1854
77	30	80	656000	3840	DFT-s-OFDM 16 QAM	1@1	23.89	21.66	0.1466
77	30	80	662666	3939.99	DFT-s-OFDM QPSK	1@1	25.43	23.2	0.2089



77	30	80	662666	3939.99	DFT-s-OFDM 16 QAM	1@1	24.57	22.34	0.1714
77	30	100	650000	3750	DFT-s-OFDM QPSK	135@67	25.23	23	0.1995
77	30	100	650000	3750	DFT-s-OFDM QPSK	1@1	25.41	23.18	0.2080
77	30	100	650000	3750	DFT-s-OFDM QPSK	1@271	25.49	23.26	0.2118
77	30	100	650000	3750	DFT-s-OFDM 16 QAM	135@67	24.63	22.4	0.1738
77	30	100	650000	3750	DFT-s-OFDM 16 QAM	1@1	24.67	22.44	0.1754
77	30	100	650000	3750	DFT-s-OFDM 16 QAM	1@271	24.45	22.22	0.1667
77	30	100	650000	3750	DFT-s-OFDM 64 QAM	135@67	22.66	20.43	0.1104
77	30	100	650000	3750	DFT-s-OFDM 64 QAM	1@1	22.59	20.36	0.1086
77	30	100	650000	3750	DFT-s-OFDM 64 QAM	1@271	22.95	20.72	0.1180
77	30	100	650000	3750	DFT-s-OFDM 256 QAM	135@67	20.73	18.5	0.0708
77	30	100	650000	3750	DFT-s-OFDM 256 QAM	1@1	20.45	18.22	0.0664
77	30	100	650000	3750	DFT-s-OFDM 256 QAM	1@271	20.79	18.56	0.0718
77	30	100	650000	3750	CP-OFDM QPSK	137@68	23.65	21.42	0.1387
77	30	100	650000	3750	CP-OFDM QPSK	1@1	23.55	21.32	0.1355
77	30	100	650000	3750	CP-OFDM QPSK	1@271	23.92	21.69	0.1476
77	30	100	656000	3840	DFT-s-OFDM QPSK	135@67	25.39	23.16	0.2070
77	30	100	656000	3840	DFT-s-OFDM QPSK	1@1	25.19	22.96	0.1977
77	30	100	656000	3840	DFT-s-OFDM QPSK	1@271	25.38	23.15	0.2065
77	30	100	656000	3840	DFT-s-OFDM 16 QAM	135@67	24.32	22.09	0.1618
77	30	100	656000	3840	DFT-s-OFDM 16 QAM	1@1	24.35	22.12	0.1629
77	30	100	656000	3840	DFT-s-OFDM 16 QAM	1@271	24.61	22.38	0.1730
77	30	100	656000	3840	DFT-s-OFDM 64 QAM	135@67	22.82	20.59	0.1146
77	30	100	656000	3840	DFT-s-OFDM 64 QAM	1@1	22.73	20.5	0.1122
77	30	100	656000	3840	DFT-s-OFDM 64 QAM	1@271	22.99	20.76	0.1191
77	30	100	656000	3840	DFT-s-OFDM 256 QAM	135@67	20.86	18.63	0.0729
77	30	100	656000	3840	DFT-s-OFDM 256 QAM	1@1	20.56	18.33	0.0681
77	30	100	656000	3840	DFT-s-OFDM 256 QAM	1@271	20.88	18.65	0.0733
77	30	100	656000	3840	CP-OFDM QPSK	137@68	23.86	21.63	0.1455
77	30	100	656000	3840	CP-OFDM QPSK	1@1	23.64	21.41	0.1384
77	30	100	656000	3840	CP-OFDM QPSK	1@271	23.94	21.71	0.1483
77	30	100	662000	3930	DFT-s-OFDM QPSK	135@67	25.67	23.44	0.2208
77	30	100	662000	3930	DFT-s-OFDM QPSK	1@1	25.65	23.42	0.2198
77	30	100	662000	3930	DFT-s-OFDM QPSK	1@271	25.42	23.19	0.2084
77	30	100	662000	3930	DFT-s-OFDM 16 QAM	135@67	24.62	22.39	0.1734

77	30	100	662000	3930	DFT-s-OFDM 16 QAM	1@1	24.81	22.58	0.1811
77	30	100	662000	3930	DFT-s-OFDM 16 QAM	1@271	24.43	22.2	0.1660
77	30	100	662000	3930	DFT-s-OFDM 64 QAM	135@67	23.12	20.89	0.1227
77	30	100	662000	3930	DFT-s-OFDM 64 QAM	1@1	23.09	20.86	0.1219
77	30	100	662000	3930	DFT-s-OFDM 64 QAM	1@271	22.5	20.27	0.1064
77	30	100	662000	3930	DFT-s-OFDM 256 QAM	135@67	21.15	18.92	0.0780
77	30	100	662000	3930	DFT-s-OFDM 256 QAM	1@1	21.03	18.8	0.0759
77	30	100	662000	3930	DFT-s-OFDM 256 QAM	1@271	20.39	18.16	0.0655
77	30	100	662000	3930	CP-OFDM QPSK	137@68	24.07	21.84	0.1528
77	30	100	662000	3930	CP-OFDM QPSK	1@1	24.15	21.92	0.1556
77	30	100	662000	3930	CP-OFDM QPSK	1@271	23.44	21.21	0.1321

## Frequency Stability

NR Band	SCS (kHz)	Bandwidth (MHz)	Arfcn	Freq (MHz)	Modulation	RB	Deviation (ppm)	Verdict	Environment
77	30	20	656000	3840.0	DFT-s-OFDM QPSK	50@0	0.0050	PASS	NV
77	30	20	656000	3840.0	DFT-s-OFDM QPSK	50@0	0.0034	PASS	LV
77	30	20	656000	3840.0	DFT-s-OFDM QPSK	50@0	0.0025	PASS	HV
77	30	20	656000	3840.0	DFT-s-OFDM QPSK	50@0	0.0054	PASS	-30°C
77	30	20	656000	3840.0	DFT-s-OFDM QPSK	50@0	0.0026	PASS	-20°C
77	30	20	656000	3840.0	DFT-s-OFDM QPSK	50@0	0.0027	PASS	-10°C
77	30	20	656000	3840.0	DFT-s-OFDM QPSK	50@0	0.0067	PASS	0°C
77	30	20	656000	3840.0	DFT-s-OFDM QPSK	50@0	0.0036	PASS	10°C
77	30	20	656000	3840.0	DFT-s-OFDM QPSK	50@0	0.0050	PASS	20°C
77	30	20	656000	3840.0	DFT-s-OFDM QPSK	50@0	0.0054	PASS	30°C
77	30	20	656000	3840.0	DFT-s-OFDM QPSK	50@0	0.0049	PASS	40°C
77	30	20	656000	3840.0	DFT-s-OFDM QPSK	50@0	0.0049	PASS	50°C

## Peak to Average Ratio

NR Band	SCS (kHz)	Bandwidth (MHz)	Arfcn	Freq (MHz)	Modulation	RB	Result (dB)	Limit (dB)	Verdict
77	30	20	647334	3710.01	DFT-s-OFDM QPSK	50@0	7.6	13	PASS
77	30	20	647334	3710.01	DFT-s-OFDM QPSK	1@0	4.79	13	PASS
77	30	20	656000	3840.0	DFT-s-OFDM QPSK	50@0	7.47	13	PASS
77	30	20	656000	3840.0	DFT-s-OFDM QPSK	1@0	4.61	13	PASS
77	30	20	664666	3969.99	DFT-s-OFDM QPSK	50@0	7.45	13	PASS
77	30	20	664666	3969.99	DFT-s-OFDM QPSK	1@0	6.16	13	PASS

N77(20M)\_DFT-s-OFDM\_QPSK\_Outer\_Full\_Low\_CH



N77(20M)\_DFT-s-OFDM\_QPSK\_Edge\_1RB\_Left\_Low\_CH



N77(20M)\_DFT-s-OFDM\_QPSK\_Outer\_Full\_Mid\_CH

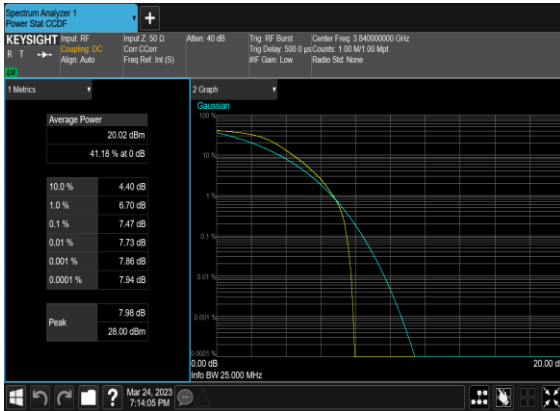

N77(20M)\_DFT-s-OFDM\_QPSK\_Edge\_1RB\_Left\_Mid\_CH

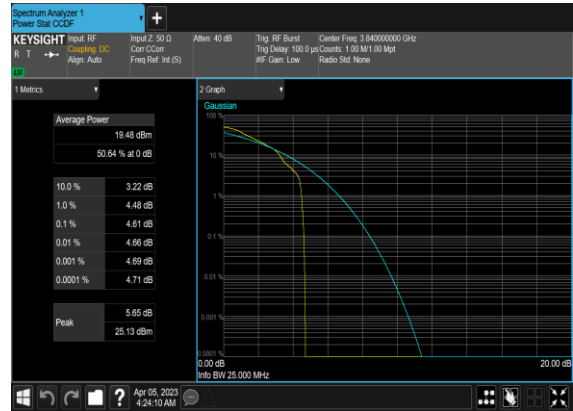

N77(20M)\_DFT-s-OFDM\_QPSK\_Outer\_Full\_High\_CH



N77(20M)\_DFT-s-OFDM\_QPSK\_Edge\_1RB\_Left\_High\_CH

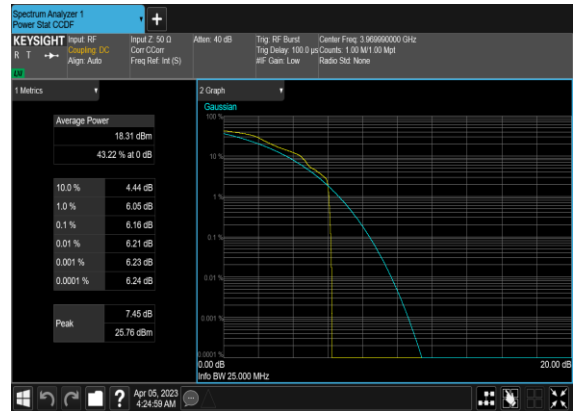

## Occupied Bandwidth

NR Band	SCS (kHz)	Bandwidth (MHz)	Arfcn	Freq (MHz)	Modulation	RB	OBW (MHz)	26dB BW (MHz)
77	30	20	656000	3840.0	DFT-s-OFDM QPSK	50@0	17.836	18.77
77	30	20	656000	3840.0	CP-OFDM QPSK	51@0	18.227	19.47
77	30	20	656000	3840.0	CP-OFDM 16 QAM	51@0	18.178	19.08
77	30	20	656000	3840.0	CP-OFDM 64 QAM	51@0	18.215	19.36
77	30	20	656000	3840.0	CP-OFDM 256 QAM	51@0	18.154	19.4
77	30	30	656000	3840.0	DFT-s-OFDM QPSK	75@0	26.723	28.33
77	30	30	656000	3840.0	CP-OFDM QPSK	78@0	27.802	29.3
77	30	30	656000	3840.0	CP-OFDM 16 QAM	78@0	27.872	29.28
77	30	30	656000	3840.0	CP-OFDM 64 QAM	78@0	27.829	28.91
77	30	30	656000	3840.0	CP-OFDM 256 QAM	78@0	27.886	29.13
77	30	40	656000	3840.0	DFT-s-OFDM QPSK	100@0	35.735	37.07
77	30	40	656000	3840.0	CP-OFDM QPSK	106@0	37.86	39.27
77	30	40	656000	3840.0	CP-OFDM 16 QAM	106@0	37.746	39.16
77	30	40	656000	3840.0	CP-OFDM 64 QAM	106@0	37.914	39.25
77	30	40	656000	3840.0	CP-OFDM 256 QAM	106@0	37.83	39.08
77	30	60	656000	3840.0	DFT-s-OFDM QPSK	162@0	57.914	60.09
77	30	60	656000	3840.0	CP-OFDM QPSK	162@0	57.843	59.54
77	30	60	656000	3840.0	CP-OFDM 16 QAM	162@0	57.728	59.7
77	30	60	656000	3840.0	CP-OFDM 64 QAM	162@0	57.867	60.12
77	30	60	656000	3840.0	CP-OFDM 256 QAM	162@0	57.834	59.69
77	30	80	656000	3840.0	DFT-s-OFDM QPSK	216@0	77.078	79.59
77	30	80	656000	3840.0	CP-OFDM QPSK	217@0	77.672	80.07
77	30	80	656000	3840.0	CP-OFDM 16 QAM	217@0	77.473	80.07
77	30	80	656000	3840.0	CP-OFDM 64 QAM	217@0	77.637	79.93

77	30	80	656000	3840.0	CP-OFDM 256 QAM	217@0	77.503	79.86
77	30	100	656000	3840.0	DFT-s- OFDM QPSK	270@0	96.328	99.37
77	30	100	656000	3840.0	CP-OFDM QPSK	273@0	97.66	100.5
77	30	100	656000	3840.0	CP-OFDM 16 QAM	273@0	97.472	100.5
77	30	100	656000	3840.0	CP-OFDM 64 QAM	273@0	97.761	100.5
77	30	100	656000	3840.0	CP-OFDM 256 QAM	273@0	97.467	100.5

### N77(20M)\_DFT-s-OFDM\_QPSK\_Outer\_Full\_Mid\_CH

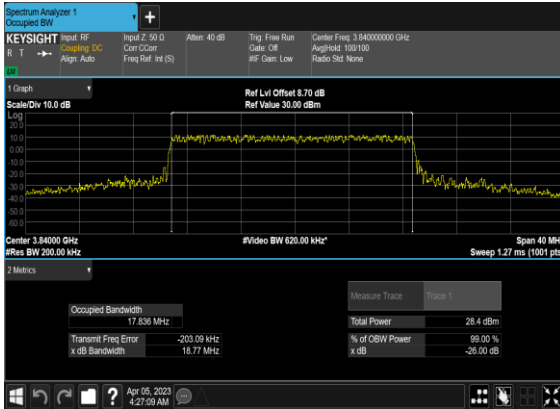

### N77(20M)\_CP-OFDM\_QPSK\_Outer\_Full\_Mid\_CH

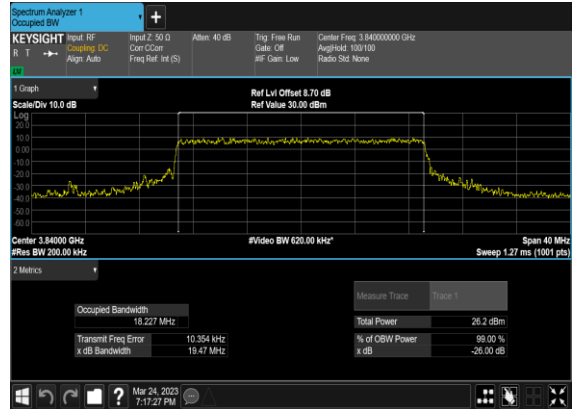

### N77(20M)\_CP-OFDM\_16QAM\_Outer\_Full\_Mid\_CH



### N77(20M)\_CP-OFDM\_64QAM\_Outer\_Full\_Mid\_CH

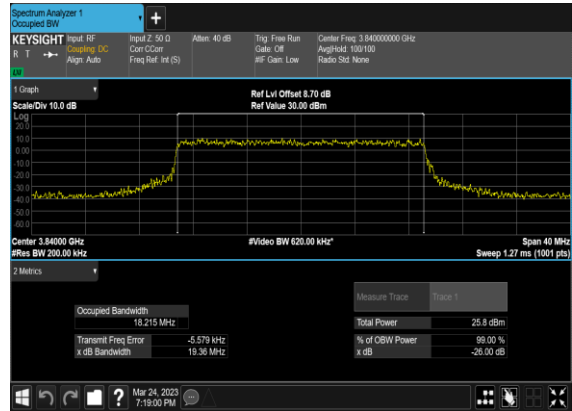

### N77(20M)\_CP-OFDM\_256QAM\_Outer\_Full\_Mid\_CH

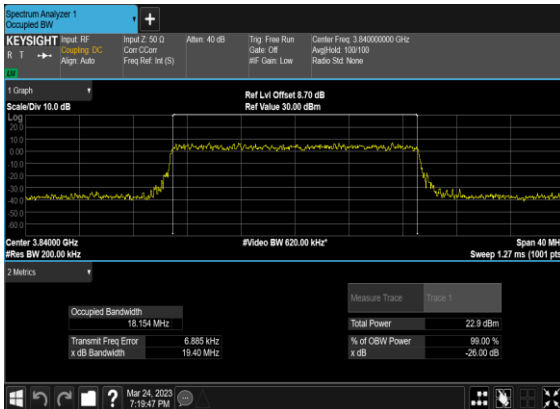

### N77(30M)\_DFT-s-OFDM\_QPSK\_Outer\_Full\_Mid\_CH

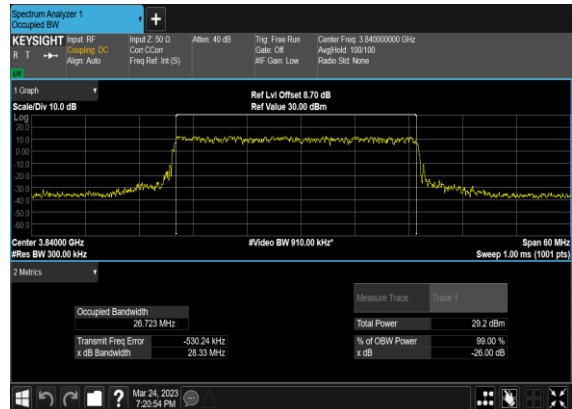



### N77(30M)\_CP-OFDM\_QPSK\_Outer\_Full\_Mid\_CH

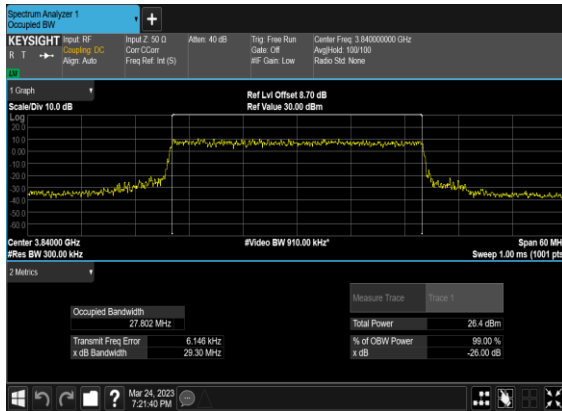

### N77(30M)\_CP-OFDM\_16QAM\_Outer\_Full\_Mid\_CH

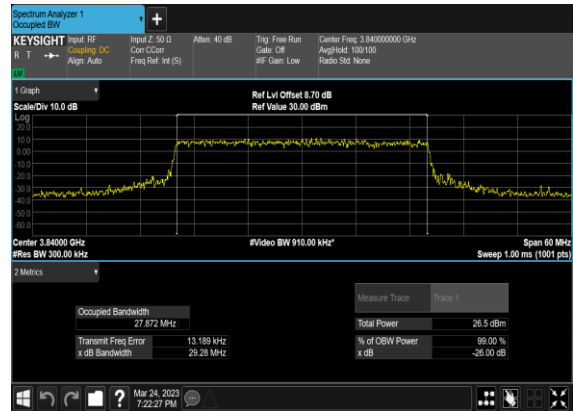

### N77(30M)\_CP-OFDM\_64QAM\_Outer\_Full\_Mid\_CH

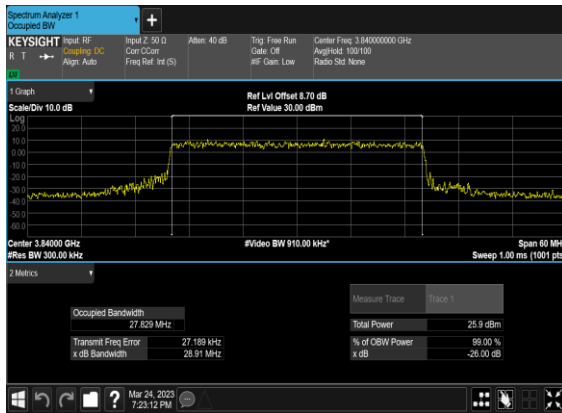

### N77(30M)\_CP-OFDM\_256QAM\_Outer\_Full\_Mid\_CH

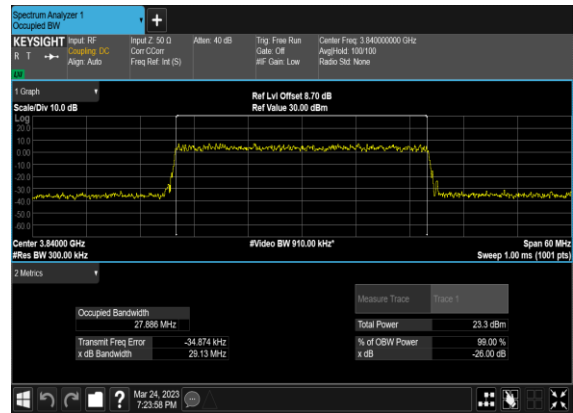

### N77(40M)\_DFT-s-OFDM\_QPSK\_Outer\_Full\_Mid\_CH

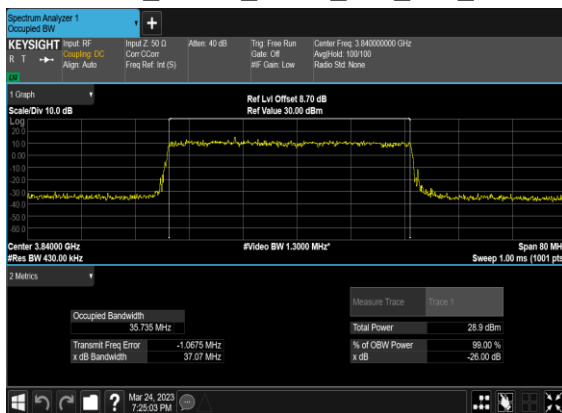

### N77(40M)\_CP-OFDM\_QPSK\_Outer\_Full\_Mid\_CH

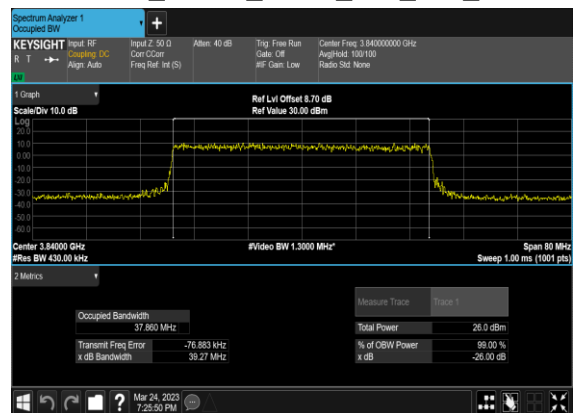

### N77(40M)\_CP-OFDM\_16 QAM\_Outer\_Full\_Mid\_CH

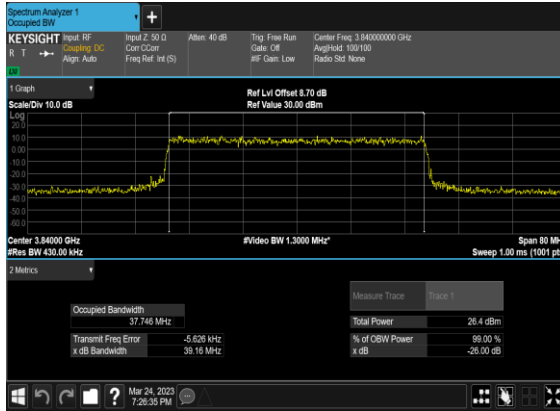

### N77(40M)\_CP-OFDM\_64 QAM\_Outer\_Full\_Mid\_CH

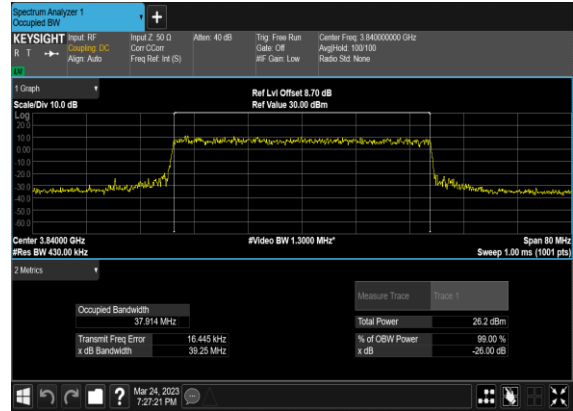

### N77(40M)\_CP-OFDM\_256 QAM\_Outer\_Full\_Mid\_CH

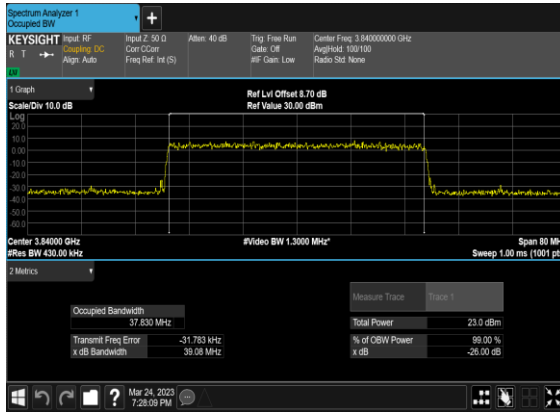

### N77(60M)\_DFT-s- OFDM\_QPSK\_Outer\_Full\_Mid\_CH



### N77(60M)\_CP- OFDM\_QPSK\_Outer\_Full\_Mid\_CH

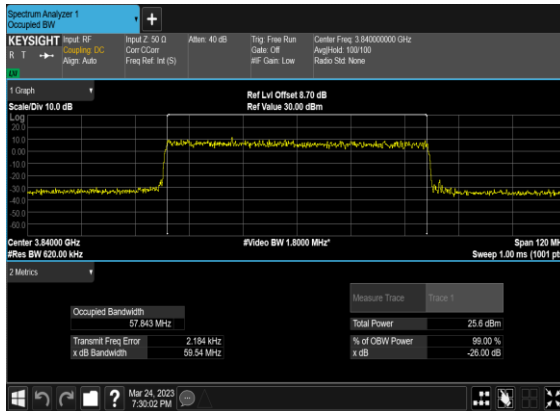

### N77(60M)\_CP-OFDM\_16 QAM\_Outer\_Full\_Mid\_CH

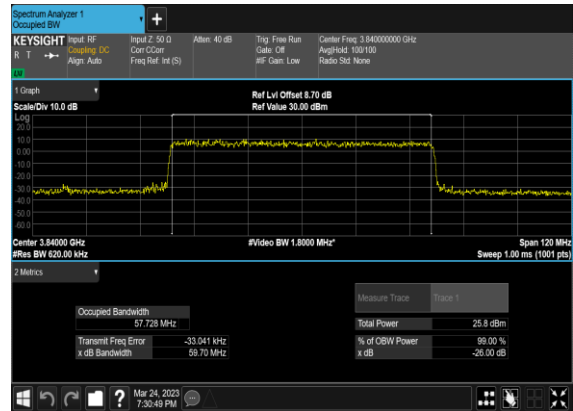

### N77(60M)\_CP-OFDM\_64 QAM\_Outer\_Full\_Mid\_CH

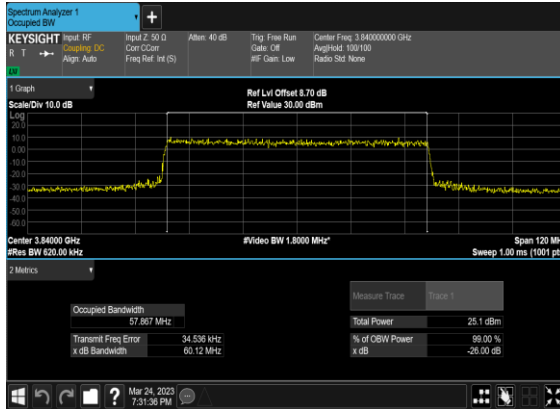

### N77(60M)\_CP-OFDM\_256 QAM\_Outer\_Full\_Mid\_CH

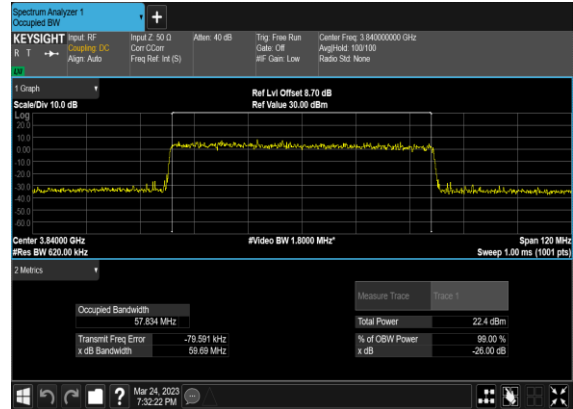

### N77(80M)\_DFT-s- OFDM\_QPSK\_Outer\_Full\_Mid\_CH

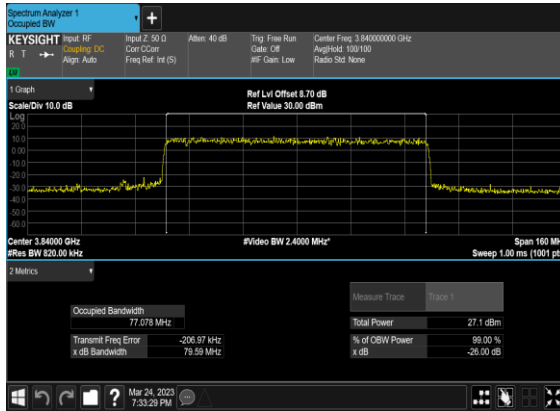

### N77(80M)\_CP- OFDM\_QPSK\_Outer\_Full\_Mid\_CH

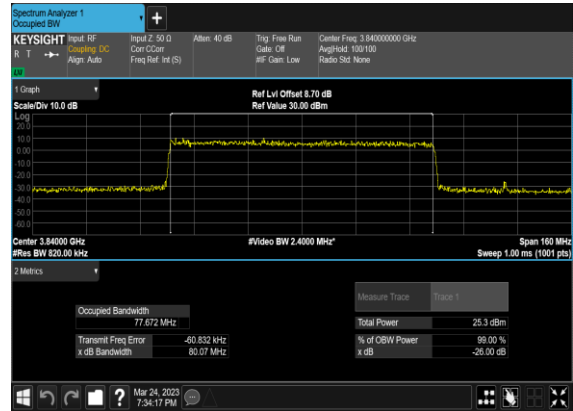

### N77(80M)\_CP-OFDM\_16 QAM\_Outer\_Full\_Mid\_CH

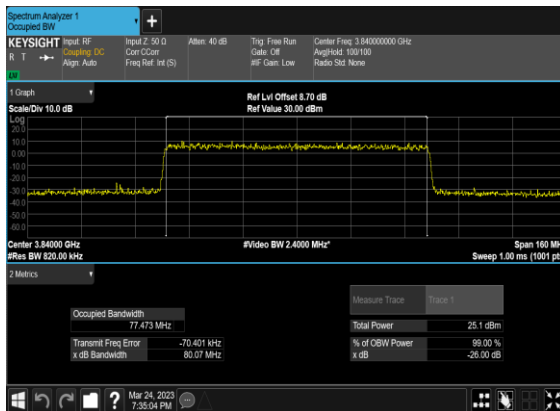

### N77(80M)\_CP-OFDM\_64 QAM\_Outer\_Full\_Mid\_CH

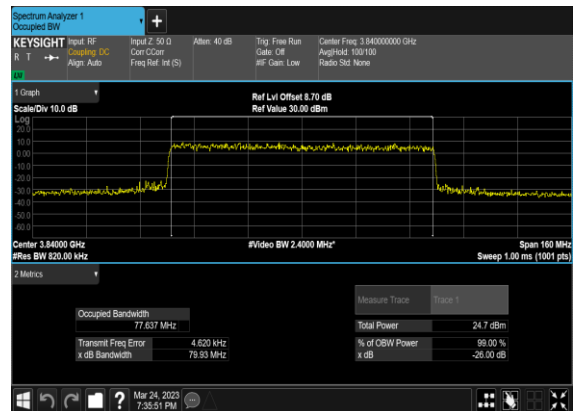

N77(80M)\_CP-OFDM\_256  
QAM\_Outer\_Full\_Mid\_CH

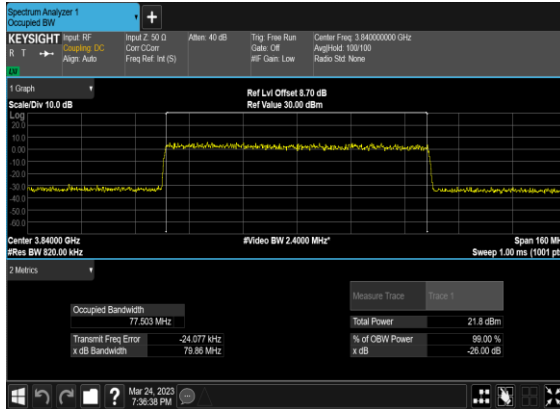

N77(100M)\_DFT-s-  
OFDM\_QPSK\_Outer\_Full\_Mid\_CH

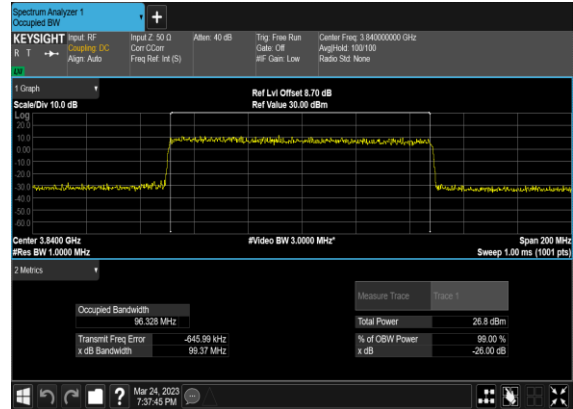

N77(100M)\_CP-  
OFDM\_QPSK\_Outer\_Full\_Mid\_CH

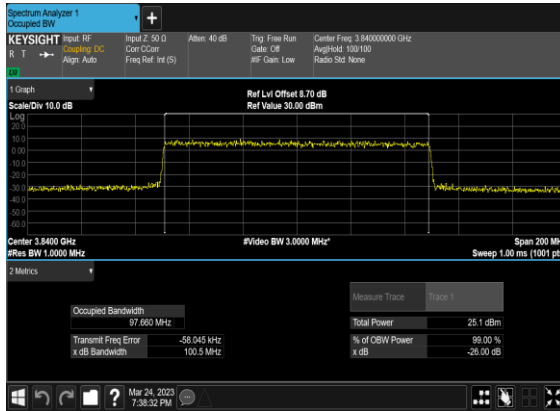

N77(100M)\_CP-OFDM\_16  
QAM\_Outer\_Full\_Mid\_CH

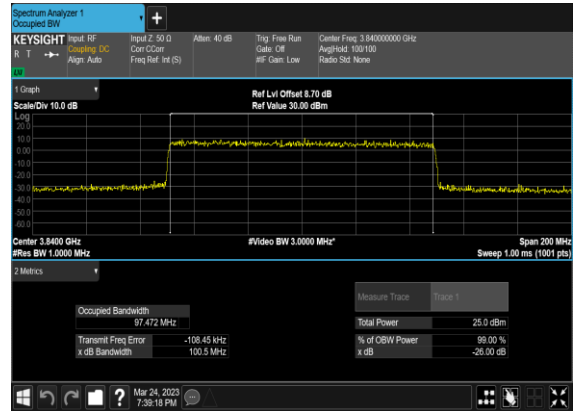

N77(100M)\_CP-OFDM\_64  
QAM\_Outer\_Full\_Mid\_CH

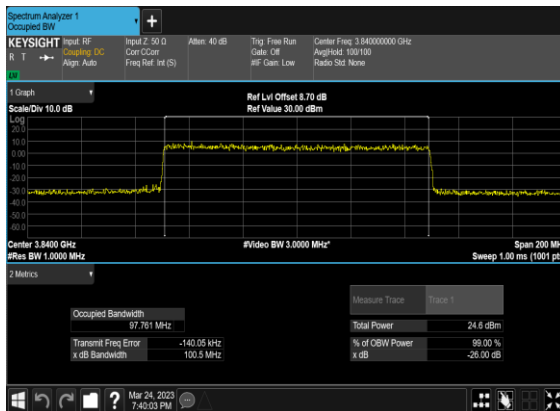

N77(100M)\_CP-OFDM\_256  
QAM\_Outer\_Full\_Mid\_CH

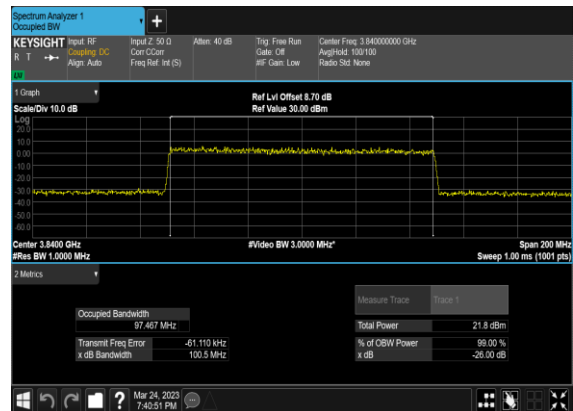

## Conducted Spurious Emissions

NR Band	SCS (kHz)	Bandwidth (MHz)	Arfcn	Freq (MHz)	Modulation	RB	Result	Verdict
77	30	20	647334	3710.01	DFT-s-OFDM QPSK	1@0	see graph	---
77	30	20	647334	3710.01	DFT-s-OFDM QPSK	1@0	see graph	PASS
77	30	20	647334	3710.01	DFT-s-OFDM QPSK	1@0	see graph	PASS
77	30	20	656000	3840.0	DFT-s-OFDM QPSK	1@0	see graph	---
77	30	20	656000	3840.0	DFT-s-OFDM QPSK	1@0	see graph	PASS
77	30	20	656000	3840.0	DFT-s-OFDM QPSK	1@0	see graph	PASS
77	30	20	664666	3969.99	DFT-s-OFDM QPSK	1@0	see graph	---
77	30	20	664666	3969.99	DFT-s-OFDM QPSK	1@0	see graph	PASS
77	30	20	664666	3969.99	DFT-s-OFDM QPSK	1@0	see graph	PASS
77	30	60	648668	3730.02	DFT-s-OFDM QPSK	1@0	see graph	---
77	30	60	648668	3730.02	DFT-s-OFDM QPSK	1@0	see graph	PASS
77	30	60	648668	3730.02	DFT-s-OFDM QPSK	1@0	see graph	PASS
77	30	60	656000	3840.0	DFT-s-OFDM QPSK	1@0	see graph	---
77	30	60	656000	3840.0	DFT-s-OFDM QPSK	1@0	see graph	PASS
77	30	60	656000	3840.0	DFT-s-OFDM QPSK	1@0	see graph	PASS
77	30	60	663332	3949.98	DFT-s-OFDM QPSK	1@0	see graph	---
77	30	60	663332	3949.98	DFT-s-OFDM QPSK	1@0	see graph	PASS
77	30	60	663332	3949.98	DFT-s-OFDM QPSK	1@0	see graph	PASS
77	30	100	650000	3750.0	DFT-s-OFDM QPSK	1@0	see graph	---
77	30	100	650000	3750.0	DFT-s-OFDM QPSK	1@0	see graph	PASS
77	30	100	650000	3750.0	DFT-s-OFDM QPSK	1@0	see graph	PASS
77	30	100	656000	3840.0	DFT-s-OFDM QPSK	1@0	see graph	---

77	30	100	656000	3840.0	DFT-s-OFDM QPSK	1@0	see graph	PASS
77	30	100	656000	3840.0	DFT-s-OFDM QPSK	1@0	see graph	PASS
77	30	100	662000	3930.0	DFT-s-OFDM QPSK	1@0	see graph	---
77	30	100	662000	3930.0	DFT-s-OFDM QPSK	1@0	see graph	PASS
77	30	100	662000	3930.0	DFT-s-OFDM QPSK	1@0	see graph	PASS

N77(20M)\_DFT-s-OFDM\_QPSK\_Edge\_1RB\_Left\_Low\_CH

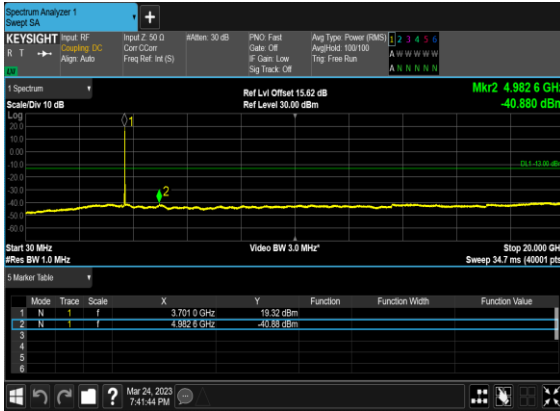

N77(20M)\_DFT-s-OFDM\_QPSK\_Edge\_1RB\_Left\_Low\_CH

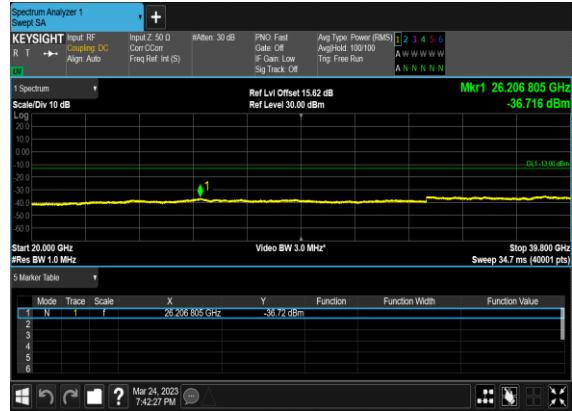

N77(20M)\_DFT-s-OFDM\_QPSK\_Edge\_1RB\_Left\_Mid\_CH

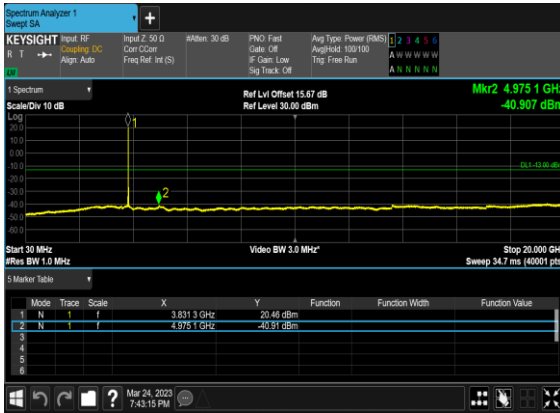

N77(20M)\_DFT-s-OFDM\_QPSK\_Edge\_1RB\_Left\_Mid\_CH

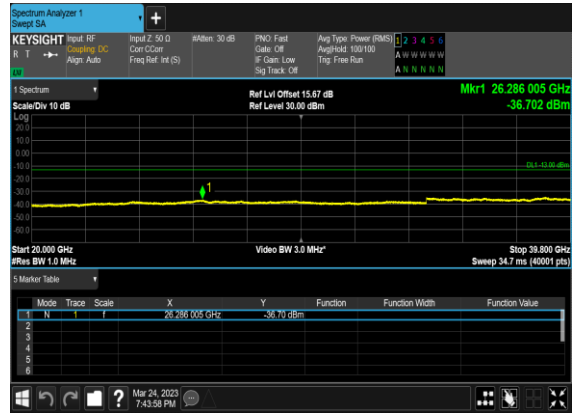

N77(20M)\_DFT-s-OFDM\_QPSK\_Edge\_1RB\_Left\_High\_CH



N77(20M)\_DFT-s-OFDM\_QPSK\_Edge\_1RB\_Left\_High\_CH

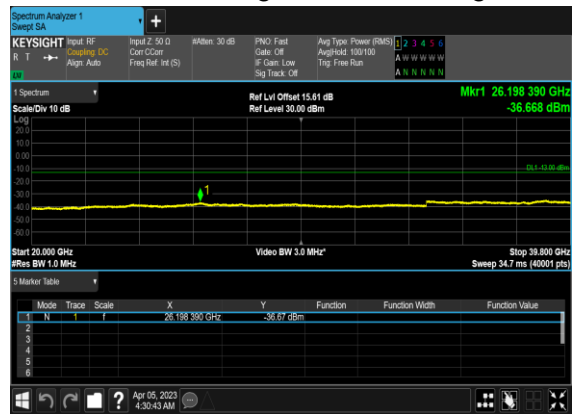

N77(60M)\_DFT-s-OFDM\_QPSK\_Edge\_1RB\_Left\_Low\_CH



N77(60M)\_DFT-s-OFDM\_QPSK\_Edge\_1RB\_Left\_Low\_CH

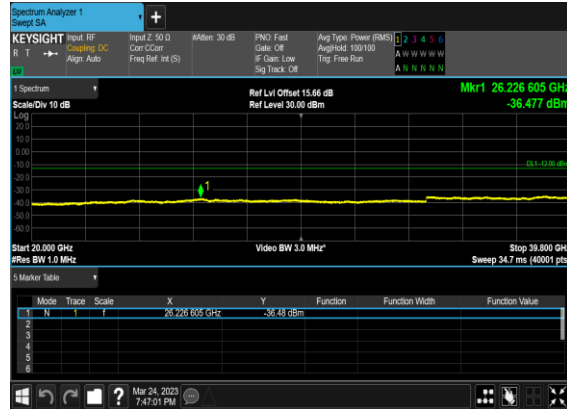

N77(60M)\_DFT-s-OFDM\_QPSK\_Edge\_1RB\_Left\_Mid\_CH



N77(60M)\_DFT-s-OFDM\_QPSK\_Edge\_1RB\_Left\_Mid\_CH

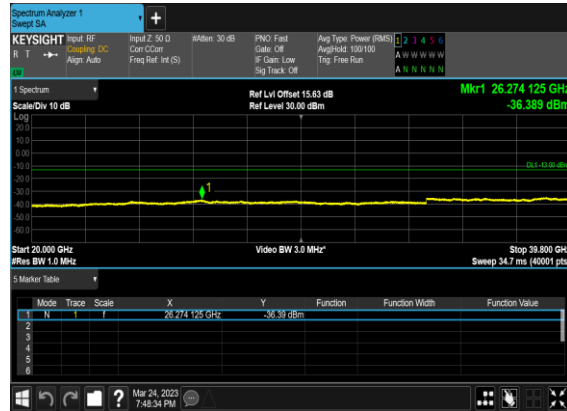

N77(60M)\_DFT-s-OFDM\_QPSK\_Edge\_1RB\_Left\_High\_CH

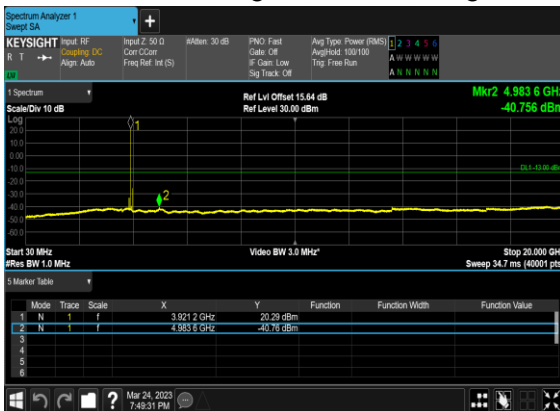

N77(60M)\_DFT-s-OFDM\_QPSK\_Edge\_1RB\_Left\_High\_CH

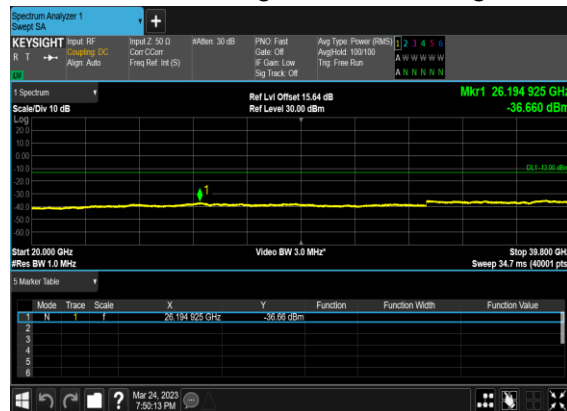



N77(100M)\_DFT-s-OFDM\_QPSK\_Edge\_1RB\_Left\_Low\_CH

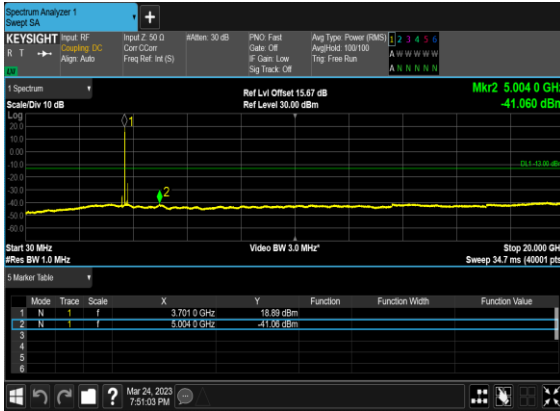

N77(100M)\_DFT-s-OFDM\_QPSK\_Edge\_1RB\_Left\_Low\_CH

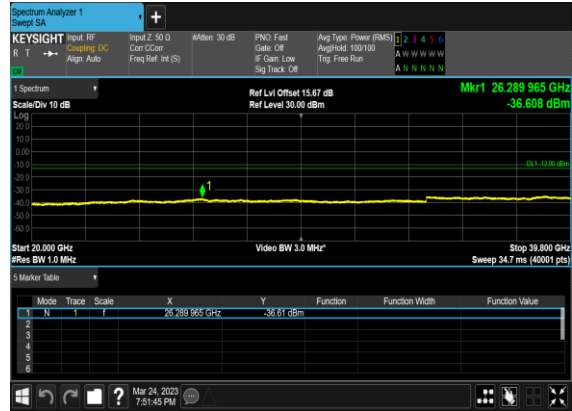

N77(100M)\_DFT-s-OFDM\_QPSK\_Edge\_1RB\_Left\_Mid\_CH

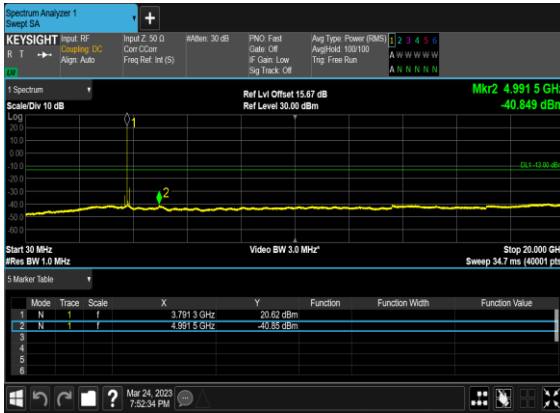

N77(100M)\_DFT-s-OFDM\_QPSK\_Edge\_1RB\_Left\_Mid\_CH

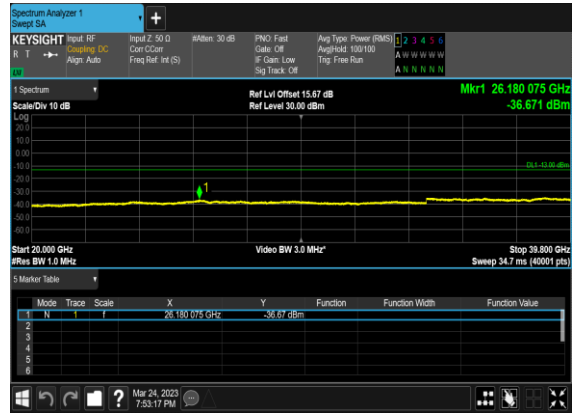

N77(100M)\_DFT-s-OFDM\_QPSK\_Edge\_1RB\_Left\_High\_CH



N77(100M)\_DFT-s-OFDM\_QPSK\_Edge\_1RB\_Left\_High\_CH

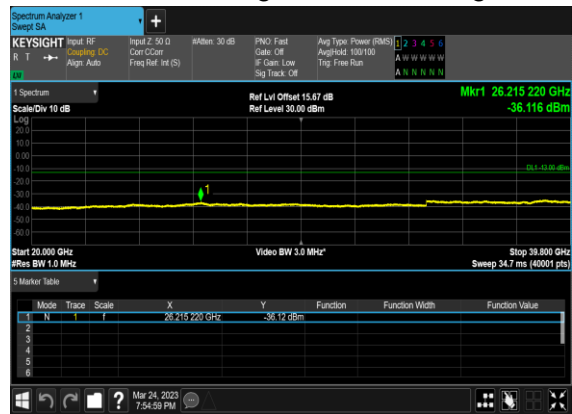

## Conducted Band Edge

NR Band	SCS (kHz)	Bandwidth (MHz)	Arfcn	Freq (MHz)	Modulation	RB	Result	Verdict
77	30	20	647334	3710.01	DFT-s-OFDM QPSK	1@0	see graph	PASS
77	30	20	647334	3710.01	DFT-s-OFDM QPSK	50@0	see graph	PASS
77	30	20	664666	3969.99	DFT-s-OFDM QPSK	1@50	see graph	PASS
77	30	20	664666	3969.99	DFT-s-OFDM QPSK	50@0	see graph	PASS
77	30	60	648668	3730.02	DFT-s-OFDM QPSK	1@0	see graph	PASS
77	30	60	648668	3730.02	DFT-s-OFDM QPSK	162@0	see graph	PASS
77	30	60	663332	3949.98	DFT-s-OFDM QPSK	1@161	see graph	PASS
77	30	60	663332	3949.98	DFT-s-OFDM QPSK	162@0	see graph	PASS
77	30	100	650000	3750.0	DFT-s-OFDM QPSK	1@0	see graph	PASS
77	30	100	650000	3750.0	DFT-s-OFDM QPSK	270@0	see graph	PASS
77	30	100	662000	3930.0	DFT-s-OFDM QPSK	1@272	see graph	PASS
77	30	100	662000	3930.0	DFT-s-OFDM QPSK	270@0	see graph	PASS

N77(20M)\_DFT-s-OFDM\_QPSK\_Edge\_1RB\_Left\_Low\_CH

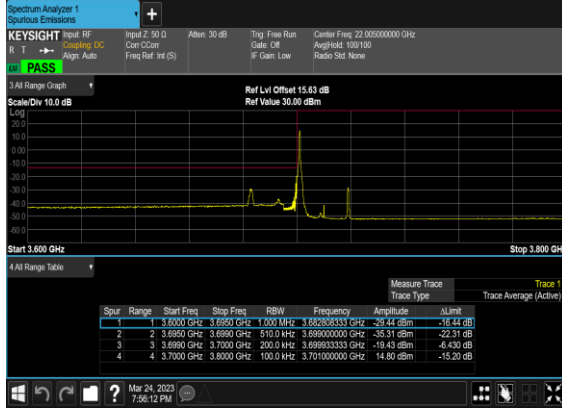

N77(20M)\_DFT-s-OFDM\_QPSK\_Outer\_Full\_Low\_CH

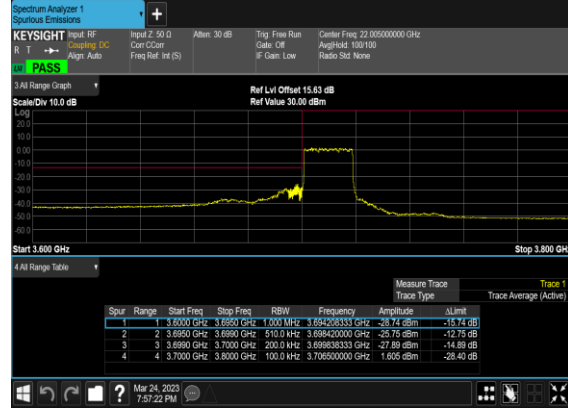

N77(20M)\_DFT-s-OFDM\_QPSK\_Edge\_1RB\_Right\_High\_CH

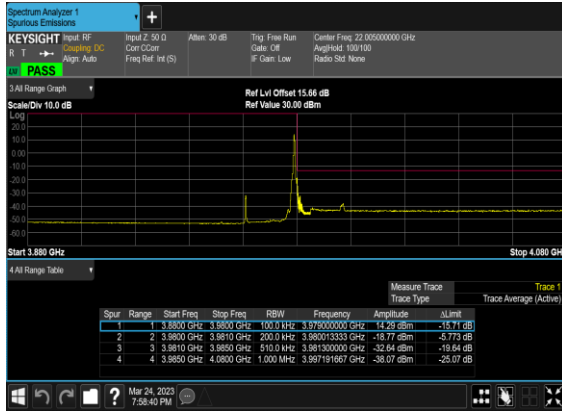

N77(20M)\_DFT-s-OFDM\_QPSK\_Outer\_Full\_High\_CH

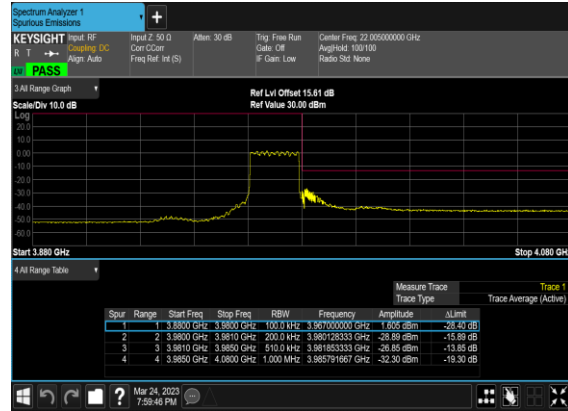

N77(60M)\_DFT-s-OFDM\_QPSK\_Edge\_1RB\_Left\_Low\_CH

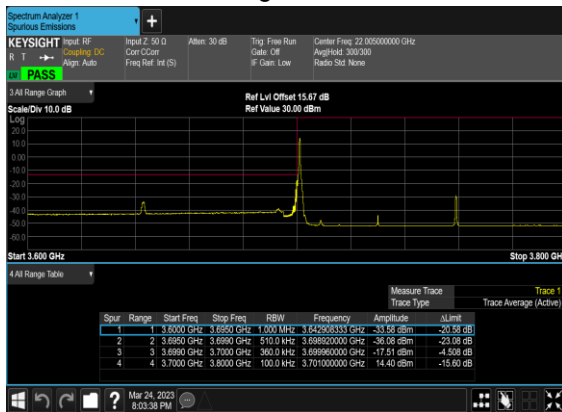

N77(60M)\_DFT-s-OFDM\_QPSK\_Outer\_Full\_Low\_CH

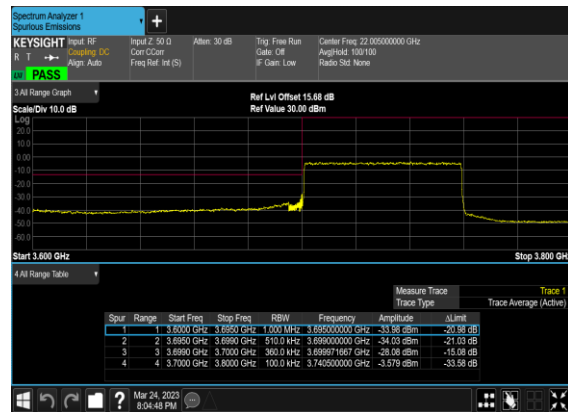

N77(60M)\_DFT-s-OFDM\_QPSK\_Edge\_1RB\_Right\_High\_CH

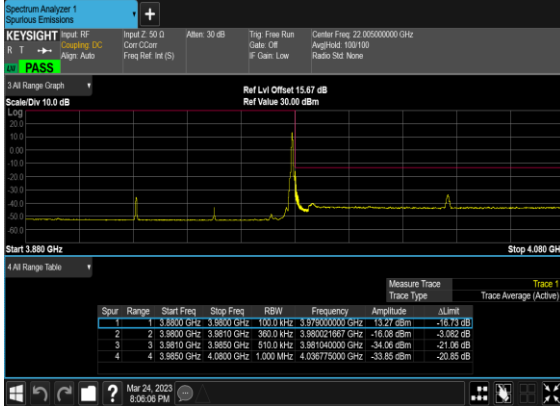

N77(60M)\_DFT-s-OFDM\_QPSK\_Outer\_Full\_High\_CH

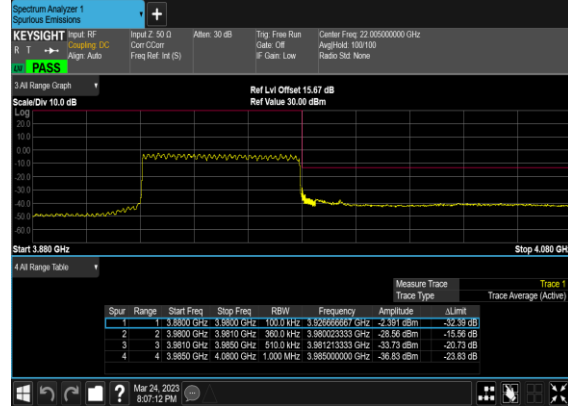

N77(100M)\_DFT-s-OFDM\_QPSK\_Edge\_1RB\_Left\_Low\_CH

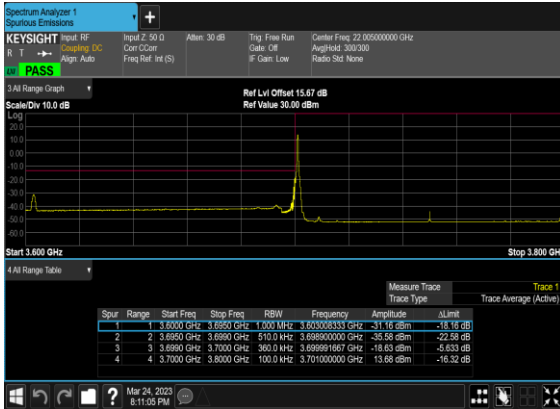

N77(100M)\_DFT-s-OFDM\_QPSK\_Outer\_Full\_Low\_CH

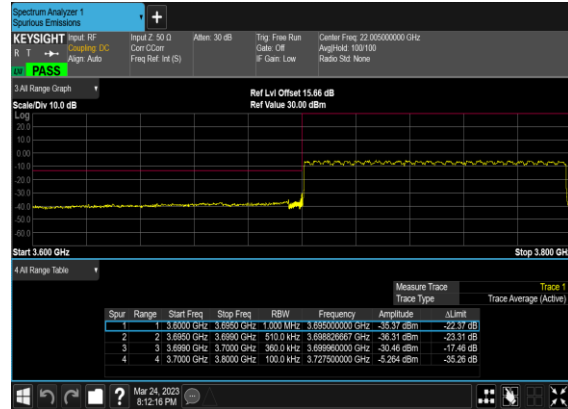

N77(100M)\_DFT-s-OFDM\_QPSK\_Edge\_1RB\_Right\_High\_CH

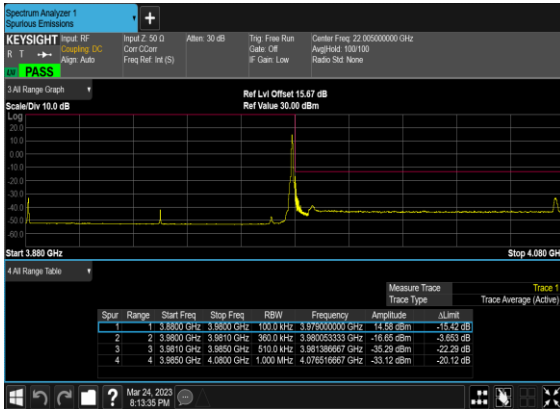

N77(100M)\_DFT-s-OFDM\_QPSK\_Outer\_Full\_High\_CH

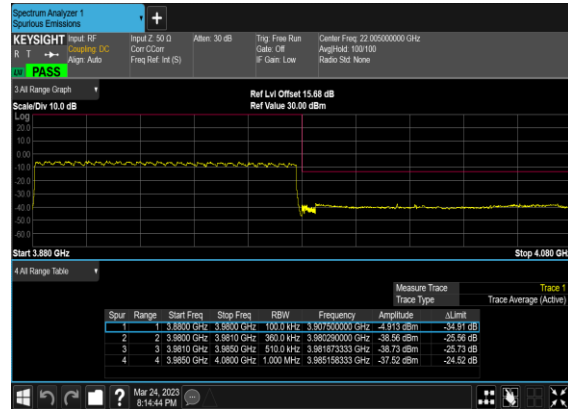



## Appendix B. Test Results of Radiated Test

### Radiated Spurious Emission

Test Engineer :	Zhang Xu	Temperature :	22~25°C
		Relative Humidity :	48~52%

Note: Pre-scanned harmonic for the different antenna combinations, we choose the worst antenna mode to perform final test.

SA n77 / NR 100MHz / QPSK / ANT4									
Channel	Frequency ( MHz )	EIRP ( dBm )	Limit ( dBm )	Over Limit ( dB )	SPA Reading (dBm)	S.G. Power ( dBm )	TX Cable loss ( dB )	TX Antenna Gain (dBi)	Polarization (H/V)
Lowest	7402.20	-56.02	-13	-43.02	-79.94	-59.35	8.25	11.58	H
	11103.60	-52.95	-13	-39.95	-81.47	-54.50	10.45	12.00	H
	14804.80	-48.05	-13	-35.05	-80.50	-49.76	11.74	13.45	H
	7402.20	-55.54	-13	-42.54	-79.77	-58.87	8.25	11.58	V
	11103.60	-53.39	-13	-40.39	-81.64	-54.94	10.45	12.00	V
	14804.80	-45.88	-13	-32.88	-80.51	-47.59	11.74	13.45	V
Middle	7582.00	-56.08	-13	-43.08	-79.67	-59.38	8.30	11.60	H
	11373.00	-51.80	-13	-38.80	-81.63	-53.32	10.48	12.00	H
	15164.00	-47.91	-13	-34.91	-81.56	-49.61	11.80	13.50	H
	7582.00	-55.61	-13	-42.61	-79.68	-58.91	8.30	11.60	V
	11373.00	-51.94	-13	-38.94	-81.72	-53.46	10.48	12.00	V
	15164.00	-46.24	-13	-33.24	-81.47	-47.94	11.80	13.50	V
Highest	7762.40	-56.72	-13	-43.72	-79.99	-60.02	8.32	11.62	H
	11643.60	-51.24	-13	-38.24	-81.59	-52.92	10.52	12.20	H
	15524.80	-46.80	-13	-33.80	-81.09	-48.50	11.85	13.55	H
	7762.40	-55.98	-13	-42.98	-79.9	-59.28	8.32	11.62	V
	11643.60	-51.08	-13	-38.08	-81.39	-52.76	10.52	12.20	V
	15524.80	-46.62	-13	-33.62	-80.74	-48.32	11.85	13.55	V

Remark: Spurious emissions within 30-1000MHz were found more than 20dB below limit line.



EN-DC 41A_n77A / LTE 20MHz + NR 100MHz / QPSK / ANT2(LTE)&ANT4(NR)									
Channel	Frequency ( MHz )	EIRP ( dBm )	Limit ( dBm )	Over Limit ( dB )	SPA Reading (dBm)	S.G. Power ( dBm )	TX Cable loss ( dB )	TX Antenna Gain (dBi)	Polarization (H/V)
NR n77 Lowest	7402.20	-54.97	-13	-41.97	-79.98	-58.30	8.25	11.58	H
	11103.60	-51.27	-13	-38.27	-81.41	-52.82	10.45	12.00	H
	14804.80	-49.29	-13	-36.29	-80.29	-51.00	11.74	13.45	H
	7402.20	-54.56	-13	-41.56	-79.88	-57.89	8.25	11.58	V
	11103.60	-51.80	-13	-38.80	-81.67	-53.35	10.45	12.00	V
	14804.80	-47.43	-13	-34.43	-80.61	-49.14	11.74	13.45	V
LTE Band41 Lowest	5177.18	-61.41	-25	-36.41	-80.65	-66.97	7.14	12.70	H
	7765.77	-50.49	-25	-25.49	-74.89	-53.79	8.30	11.60	H
	10354.36	-52.42	-25	-27.42	-80.93	-53.94	10.48	12.00	H
	5177.18	-61.76	-25	-36.76	-80.66	-67.32	7.14	12.70	V
	7765.77	-42.26	-25	-17.26	-67.31	-45.56	8.30	11.60	V
	10354.36	-53.49	-25	-28.49	-81.03	-55.01	10.48	12.00	V
NR n77 Middle	7582.00	-54.98	-13	-41.98	-79.73	-58.28	8.30	11.60	H
	11373.00	-50.33	-13	-37.33	-81.61	-51.85	10.48	12.00	H
	15164.00	-49.32	-13	-36.32	-81.25	-51.02	11.80	13.50	H
	7582.00	-54.44	-13	-41.44	-79.67	-57.74	8.30	11.60	V
	11373.00	-50.29	-13	-37.29	-81.52	-51.81	10.48	12.00	V
	15164.00	-47.73	-13	-34.73	-81.24	-49.43	11.80	13.50	V
LTE Band41 Middle	5177.18	-61.04	-25	-36.04	-80.28	-66.60	7.14	12.70	H
	7765.77	-49.67	-25	-24.67	-74.07	-52.97	8.30	11.60	H
	10354.36	-52.52	-25	-27.52	-81.03	-54.04	10.48	12.00	H
	5177.18	-61.88	-25	-36.88	-80.78	-67.44	7.14	12.70	V
	7765.77	-40.93	-25	-15.93	-65.98	-44.23	8.30	11.60	V
	10354.36	-53.54	-25	-28.54	-81.08	-55.06	10.48	12.00	V
NR n77 Highest	7762.40	-50.34	-13	-37.34	-74.75	-53.64	8.32	11.62	H
	11643.60	-50.04	-13	-37.04	-81.68	-51.72	10.52	12.20	H
	15524.80	-48.00	-13	-35.00	-80.77	-49.70	11.85	13.55	H
	7762.40	-40.65	-13	-27.65	-65.71	-43.95	8.32	11.62	V
	11643.60	-49.73	-13	-36.73	-81.33	-51.41	10.52	12.20	V
	15524.80	-48.17	-13	-35.17	-80.77	-49.87	11.85	13.55	V
LTE Band41 Highest	5177.18	-61.11	-25	-36.11	-80.35	-80.35	7.14	12.70	H
	7765.77	-50.34	-25	-25.34	-74.75	-74.74	8.30	11.60	H
	10354.36	-52.44	-25	-27.44	-80.95	-80.95	10.48	12.00	H
	5177.18	-61.76	-25	-36.76	-80.66	-80.66	7.14	12.70	V
	7765.77	-40.65	-25	-15.65	-65.71	-65.70	8.30	11.60	V
	10354.36	-53.42	-25	-28.42	-80.96	-80.96	10.48	12.00	V

Remark: Spurious emissions within 30-1000MHz were found more than 20dB below limit line.