

1 Cover Page

TEST REPORT

Applicant: Xiamen Lenz Communication Co.,Ltd

Address of Applicant: Unit 2001, NO. 365 Chengyi Street, Software Park 3, Jimei District, Xiamen, China

Manufacturer/Factory: Xiamen Lenz Communication Co.,Ltd

Address of Manufacturer/Factory: Unit 2001, NO. 365 Chengyi Street, Software Park 3, Jimei District, Xiamen, China

Equipment Under Test (EUT)

Product Name: Mobile DVR

Model No.: LZE500

FCC ID: 2AZ97-LZE500

Applicable standards: FCC CFR Title 47 Part 2
FCC CFR Title 47 Part 24
FCC CFR Title 47 Part 27

Date of sample receipt: April 15, 2021

Date of Test: April 16, 2021-May 18, 2021

Date of report issued: May 19, 2021

Test Result : PASS *

* In the configuration tested, the EUT complied with the standards specified above.

Authorized Signature:

Robinson Lo

Laboratory Manager

This results shown in this test report refer only to the sample(s) tested, this test report cannot be reproduced, except in full, without prior written permission of the company. The report would be invalid without specific stamp of test institute and the signatures of compiler and approver.

2 Version

Version No.	Date	Description
00	May 19, 2021	Original

Prepared By:

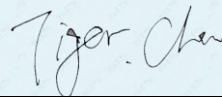

Date:

May 19, 2021

Project Engineer

Check By:

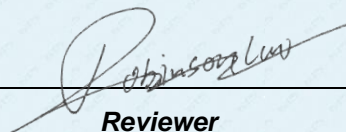

Reviewer

Date:

May 19, 2021

3 Contents

Page

1	COVER PAGE	1
2	VERSION	2
3	CONTENTS	3
4	TEST SUMMARY	4
5	GENERAL INFORMATION	5
5.1	GENERAL DESCRIPTION OF EUT	5
5.2	RELATED SUBMITTAL(S) / GRANT (S)	7
5.3	TEST METHODOLOGY.....	7
5.4	TEST FACILITY	7
5.5	TEST LOCATION.....	7
6	TEST INSTRUMENTS LIST	8
7	SYSTEM TEST CONFIGURATION	10
7.1	TEST MODE	10
7.2	CONFIGURATION OF TESTED SYSTEM	10
7.3	CONDUCTED OUTPUT POWER	11
7.4	PEAK-TO-AVERAGE RATIO	28
7.5	OCCUPY BANDWIDTH.....	46
7.6	MODULATION CHARACTERISTIC.....	83
7.7	OUT OF BAND EMISSION AT ANTENNA TERMINALS.....	83
7.8	FIELD STRENGTH OF SPURIOUS RADIATION MEASUREMENT.....	132
7.9	FREQUENCY STABILITY V.S. TEMPERATURE MEASUREMENT.....	136
7.10	FREQUENCY STABILITY V.S. VOLTAGE MEASUREMENT	139
8	TEST SETUP PHOTO	141
9	EUT CONSTRUCTIONAL DETAILS	141

4 Test Summary

Test Item	Section in CFR 47	Result
RF Exposure (SAR)	Part 1.1307 Part 2.1091	Pass (Please refer to MPE)
Conducted Output Power	Part 2.1046 Part 24.232 (c) Part 27.50(c)(10)/(d)(4)	Pass
Modulation Characteristics	Part 2.1047	N/A
99% & -26 dB Occupied Bandwidth	Part 2.1049 Part 24.238 Part 27.53(h)/(g)	Pass
Spurious Emissions at Antenna Terminal	Part 2.1051 Part 24.238 (a) Part 27.53(h)/(g)	Pass
Field Strength of Spurious Radiation	Part 2.1053 Part 24.238 (a) Part 27.53(h)/(g)	Pass
Out of band emission, Band Edge	Part 24.238 (a) Part 27.53(h)/(g)	Pass
Frequency stability vs. temperature	Part 2.1055(a)(1)(b)	Pass
Frequency stability vs. voltage	Part 2.1055(d)(1)(2)	Pass

Pass: The EUT complies with the essential requirements in the standard.

N/A: Not applicable.

5 General Information

5.1 General Description of EUT

Product Name:	Mobile DVR
Model No.:	LZE500
Tested Sample(s) ID:	GTS202104000126-1
Sample(s) Status:	Engineer sample
S/N:	N/A
Hardware Version:	V1.0
Software Version:	V1.0
Support Networks:	LTE
Support Bands:	LTE Band 2, LTE Band 4, LTE Band 12
Channel Bandwidth:	LTE Band 2: 1.4MHz; 3MHz; 5MHz; 10MHz; 15MHz; 20MHz LTE Band 4: 1.4MHz; 3MHz; 5MHz; 10MHz; 15MHz; 20MHz LTE Band 12: 1.4MHz; 3MHz; 5MHz; 10MHz
TX Frequency:	LTE Band 2: 1850.70MHz-1909.30MHz LTE Band 4: 1710.70MHz-1754.30MHz LTE Band 12: 699.70MHz-715.30MHz
Modulation type:	LTE Band 2/4/12: QPSK, 16QAM
Antenna type:	External antenna
Antenna gain:	LTE Band 2/4/12: 3.5dBi(max)
Power supply:	DC 12-24V

Operation Frequency List:

Band 2					
Bandwidth	Channel	Frequency (MHz)	Bandwidth	Channel	Frequency (MHz)
1.4MHz	18607	1850.7	3MHz	18615	1851.5
	⋮	⋮		⋮	⋮
	18900	1880.0		18900	1880.0
	⋮	⋮		⋮	⋮
	19193	1909.3		19185	1908.5
5MHz	18625	1852.5	10MHz	18650	1855
	⋮	⋮		⋮	⋮
	18900	1880.0		18900	1880.0
	⋮	⋮		⋮	⋮
	19175	1907.5		19150	1905.0
15MHz	18675	1857.5	20MHz	18700	1860.0
	⋮	⋮		⋮	⋮
	18900	1880.0		18900	1880.0
	⋮	⋮		⋮	⋮
	19125	1902.5		19100	1900.0

Band 4					
Bandwidth	Channel	Frequency (MHz)	Bandwidth	Channel	Frequency (MHz)
1.4MHz	19957	1710.7	3MHz	19965	1711.5
	⋮	⋮		⋮	⋮
	20175	1732.5		20175	1732.5
	⋮	⋮		⋮	⋮
	20393	1754.3		20385	1753.5
5MHz	19975	1712.5	10MHz	20000	1715.0
	⋮	⋮		⋮	⋮
	20175	1732.5		20175	1732.5
	⋮	⋮		⋮	⋮
	20375	1752.5		20350	1750.0
15MHz	20025	1717.5	20MHz	20050	1720.0
	⋮	⋮		⋮	⋮
	20175	1732.5		20175	1732.5
	⋮	⋮		⋮	⋮
	20325	1747.5		20300	1745.0

Band 12					
Bandwidth	Channel	Frequency (MHz)	Bandwidth	Channel	Frequency (MHz)
1.4MHz	23017	699.7	3MHz	23025	700.5
	:	:		:	:
	23095	707.5		23095	707.5
	:	:		:	:
	23173	715.3		23165	714.5
5MHz	23035	701.5	10MHz	23060	704.0
	:	:		:	:
	23095	707.5		23095	707.5
	:	:		:	:
	23155	713.5		23130	711.0

5.2 Related Submittal(s) / Grant (s)

This submittal(s) (test report) is filing to comply with Section Part 22/24/27 of the FCC CFR 47 Rules.

5.3 Test Methodology

Both conducted and radiated testing were performed according to the procedures document on ANSI C63.26:2015 and FCC CFR 47.1046, 2.1047, 2.1049, 2.1051, 2.1053, 2.1055 and 2.1057

5.4 Test Facility

The test facility is recognized, certified, or accredited by the following organizations:

- **FCC —Registration No.: 381383**

Global United Technology Services Co., Ltd., Shenzhen EMC Laboratory has been registered and fully described in a report filed with the (FCC) Federal Communications Commission. The acceptance letter from the FCC is maintained in files. Registration 381383.

- **IC —Registration No.: 9079A**

The 3m Semi-anechoic chamber of Global United Technology Services Co., Ltd. has been registered by Certification and Engineering Bureau of Industry Canada for radio equipment testing with Registration No.: 9079A

- **NVLAP (LAB CODE:600179-0)**

Global United Technology Services Co., Ltd., is accredited by the National Voluntary Laboratory Accreditation Program (NVLAP). LAB CODE:600179-0

5.5 Test Location

All tests were performed at:

Global United Technology Services Co., Ltd.

Address: No. 123- 128, Tower A, Jinyuan Business Building, No.2, Laodong Industrial Zone, Xixiang Road, Baoan District, Shenzhen, Guangdong, China 518102

Tel: 0755-27798480

Fax: 0755-27798960

6 Test Instruments list

Radiated Emission:						
Item	Test Equipment	Manufacturer	Model No.	Inventory No.	Cal.Date (mm-dd-yy)	Cal.Due date (mm-dd-yy)
1	3m Semi- Anechoic Chamber	ZhongYu Electron	9.2(L)*6.2(W)* 6.4(H)	GTS250	July. 02 2020	July. 01 2025
2	Control Room	ZhongYu Electron	6.2(L)*2.5(W)* 2.4(H)	GTS251	N/A	N/A
3	EMI Test Receiver	Rohde & Schwarz	ESU26	GTS203	June. 25 2020	June. 24 2021
4	BiConiLog Antenna	SCHWARZBECK MESS-ELEKTRONIK	VULB9163	GTS214	June. 25 2020	June. 24 2021
5	Double -ridged waveguide horn	SCHWARZBECK MESS-ELEKTRONIK	BBHA 9120 D	GTS208	June. 25 2020	June. 24 2021
6	Horn Antenna	ETS-LINDGREN	3160	GTS217	June. 25 2020	June. 24 2021
7	EMI Test Software	AUDIX	E3	N/A	N/A	N/A
8	Coaxial Cable	GTS	N/A	GTS213	June. 25 2020	June. 24 2021
9	Coaxial Cable	GTS	N/A	GTS211	June. 25 2020	June. 24 2021
10	Coaxial cable	GTS	N/A	GTS210	June. 25 2020	June. 24 2021
11	Coaxial Cable	GTS	N/A	GTS212	June. 25 2020	June. 24 2021
12	Amplifier(100kHz-3GHz)	HP	8347A	GTS204	June. 25 2020	June. 24 2021
13	Amplifier(2GHz-20GHz)	HP	84722A	GTS206	June. 25 2020	June. 24 2021
14	Amplifier (18-26GHz)	Rohde & Schwarz	AFS33-18002 650-30-8P-44	GTS218	June. 25 2020	June. 24 2021
15	Band filter	Amindeon	82346	GTS219	June. 25 2020	June. 24 2021
16	Power Meter	Anritsu	ML2495A	GTS540	June. 25 2020	June. 24 2021
17	Power Sensor	Anritsu	MA2411B	GTS541	June. 25 2020	June. 24 2021
18	Wideband Radio Communication Tester	Rohde & Schwarz	CMW500	GTS575	June. 25 2020	June. 24 2021
19	Splitter	Agilent	11636B	GTS237	June. 25 2020	June. 24 2021
20	Loop Antenna	ZHINAN	ZN30900A	GTS534	June. 25 2020	June. 24 2021
21	Breitband hornantenne	SCHWARZBECK	BBHA 9170	GTS579	Oct. 18 2020	Oct. 17 2021
22	Amplifier	TDK	PA-02-02	GTS574	Oct. 18 2020	Oct. 17 2021
23	Amplifier	TDK	PA-02-03	GTS576	Oct. 18 2020	Oct. 17 2021
24	PSA Series Spectrum Analyzer	Rohde & Schwarz	FSP	GTS578	June. 25 2020	June. 24 2021

RF Conducted Test:						
Item	Test Equipment	Manufacturer	Model No.	Serial No.	Cal.Date (mm-dd-yy)	Cal.Due date (mm-dd-yy)
1	MXA Signal Analyzer	Agilent	N9020A	GTS566	June. 25 2020	June. 24 2021
2	EMI Test Receiver	R&S	ESCI 7	GTS552	June. 25 2020	June. 24 2021
3	Spectrum Analyzer	Agilent	E4440A	GTS533	June. 25 2020	June. 24 2021
4	MXG vector Signal Generator	Agilent	N5182A	GTS567	June. 25 2020	June. 24 2021
5	ESG Analog Signal Generator	Agilent	E4428C	GTS568	June. 25 2020	June. 24 2021
6	USB RF Power Sensor	DARE	RPR3006W	GTS569	June. 25 2020	June. 24 2021
7	RF Switch Box	Shongyi	RFSW3003328	GTS571	June. 25 2020	June. 24 2021
8	Programmable Constant Temp & Humi Test Chamber	WEWON	WHTH-150L-40-880	GTS572	June. 25 2020	June. 24 2021

General used equipment:						
Item	Test Equipment	Manufacturer	Model No.	Inventory No.	Cal.Date (mm-dd-yy)	Cal.Due date (mm-dd-yy)
1	Humidity/ Temperature Indicator	KTJ	TA328	GTS243	June. 25 2020	June. 24 2021
2	Barometer	ChangChun	DYM3	GTS255	June. 25 2020	June. 24 2021

7 System test configuration

7.1 Test mode

During all testing, EUT is in link mode with base station emulator at maximum power level. The spurious emission measurements were carried out in semi-anechoic chamber with 3-meter test range, and EUT is rotated on three test planes to find out the worst emission.

Test modes		
Band	Radiated	Conducted
LTE Band 2	■ QPSK and 16QAM link	■ QPSK and 16QAM link
LTE Band 4	■ QPSK and 16QAM link	■ QPSK and 16QAM link
LTE Band 12	■ QPSK and 16QAM link	■ QPSK and 16QAM link

7.2 Configuration of Tested System

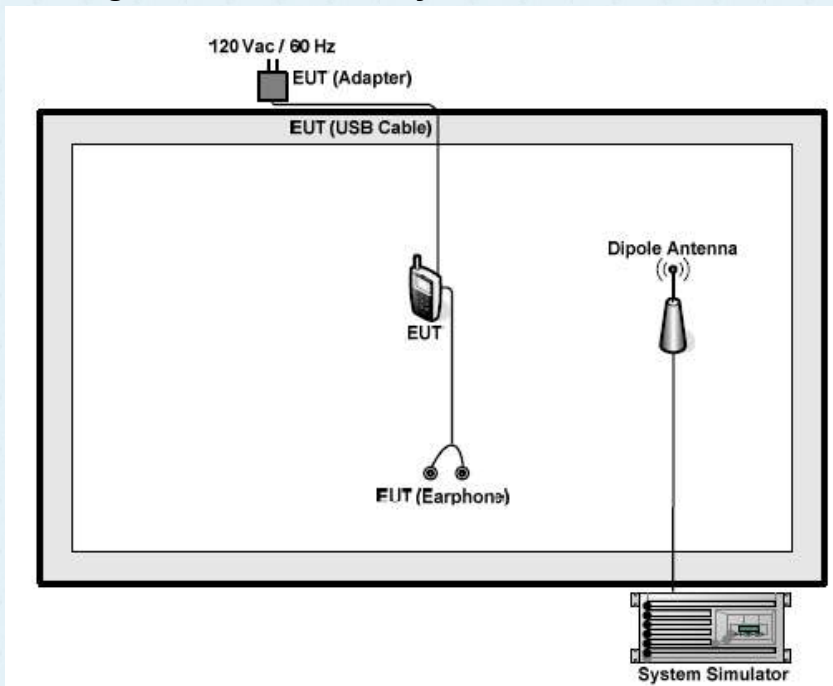

7.3 Conducted Output Power

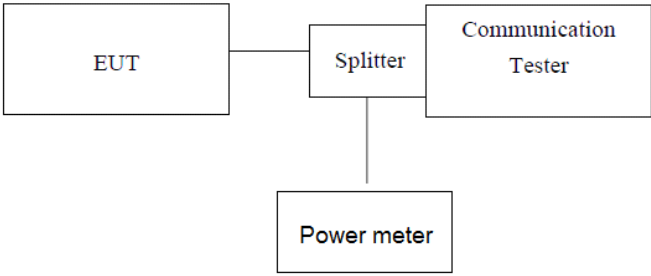
Test Requirement:	Part 24.232 (c); Part 27.50(c)(10)/(d)(4)
Test Method:	FCC part2.1046
Limit:	LTE Band 2: 2W LTE Band 4: 1W LTE Band 12: 3W
Test setup:	 <p><i>Note: Measurement setup for testing on Antenna connector</i></p>
Test Procedure:	<ol style="list-style-type: none"> 1. The transmitter output port was connected to base station. 2. The RF output of EUT was connected to the power meter by RF cable and attenuator, the path loss was compensated to the results for each measurement. 3. Set EUT at maximum power through base station. 4. Select lowest, middle, and highest channels for each band and different modulation. 5. Measure the maximum burst average power.
Test Instruments:	Refer to section 6.0 for details
Test mode:	Refer to section 7.1 for details
Test results:	Pass

Measurement Data

Band 2						
Bandwidth	Mode	RB Size	RB Offset	Actual output power(dBm)		
				Channel 18607 1850.7MHz	Channel 18900 1880.0MHz	Channel 19193 1909.3MHz
1.4MHz	QPSK	1	0	21.17	21.10	21.25
		1	2	21.49	21.34	21.45
		1	5	21.65	21.71	21.86
		3	0	21.44	21.29	21.67
		3	1	21.26	21.15	21.36
		3	2	20.79	20.94	21.23
		6	0	21.54	21.77	21.51
	16QAM	1	0	21.07	20.94	21.13
		1	2	20.72	20.56	20.78
		1	5	21.48	21.40	21.30
		3	0	21.41	21.28	21.33
		3	1	21.24	21.29	21.18
		3	2	21.41	21.48	21.74
		6	0	21.04	21.05	20.88
Bandwidth	Mode	RB Size	RB Offset	Actual output power(dBm)		
				Channel 18615 1851.5MHz	Channel 18900 1880.0MHz	Channel 19185 1908.5MHz
3MHz	QPSK	1	0	22.09	21.70	21.38
		1	8	20.55	20.66	21.20
		1	14	21.38	20.56	20.89
		8	0	20.88	20.68	20.57
		8	4	21.02	21.14	21.24
		8	7	20.79	21.08	20.32
		15	0	20.73	21.03	20.74
	16QAM	1	0	20.97	20.75	21.08
		1	8	21.26	21.02	20.78
		1	14	21.73	21.45	21.46
		8	0	21.28	21.08	20.78
		8	4	20.85	20.38	20.54
		8	7	20.76	20.98	21.14
		15	0	21.48	21.46	21.58

Bandwidth	Mode	RB Size	RB Offset	Actual output power(dBm)		
				Channel 18625 1852.5MHz	Channel 18900 1880.0MHz	Channel 19175 1907.5MHz
5MHz	QPSK	1	0	21.25	21.18	21.06
		1	13	21.19	20.75	21.06
		1	24	21.22	20.87	21.31
		12	0	20.69	21.00	20.97
		12	6	20.87	21.03	20.55
		12	13	21.11	20.96	21.08
		25	0	21.09	20.95	21.19
	16QAM	1	0	20.49	21.13	20.31
		1	13	20.50	21.06	21.17
		1	24	20.85	21.48	21.51
		12	0	20.52	20.46	20.67
		12	6	20.68	20.87	21.15
		12	13	21.05	21.25	20.43
		25	0	21.28	21.29	21.41
Bandwidth	Mode	RB Size	RB Offset	Actual output power(dBm)		
				Channel 18650 1855.0MHz	Channel 18900 1880.0MHz	Channel 19150 1905.0MHz
10MHz	QPSK	1	0	21.47	21.40	21.45
		1	25	21.21	21.11	21.35
		1	49	21.26	21.10	21.22
		25	0	20.61	21.49	20.64
		25	13	21.48	21.35	21.55
		25	25	21.41	21.36	21.57
		50	0	21.61	21.35	21.62
	16QAM	1	0	20.44	20.83	20.85
		1	25	20.92	20.47	20.42
		1	49	20.98	21.40	20.54
		25	0	20.40	21.27	20.46
		25	13	21.17	20.95	21.08
		25	25	21.16	20.93	21.02
		50	0	21.18	21.03	21.05

Bandwidth	Mode	RB Size	RB Offset	Actual output power(dBm)		
				Channel 18675 1857.5MHz	Channel 18900 1880.0MHz	Channel 19125 1902.5MHz
15MHz	QPSK	1	0	21.74	21.69	21.73
		1	38	21.48	21.33	21.55
		1	74	21.19	20.87	21.03
		36	0	20.62	20.47	20.58
		36	18	21.33	21.20	20.45
		36	39	21.24	21.27	20.46
		75	0	20.47	21.34	20.45
	16QAM	1	0	20.78	21.10	20.97
		1	38	21.28	20.67	20.67
		1	74	21.32	20.74	20.61
		36	0	20.48	20.46	20.59
		36	18	20.42	21.18	20.44
		36	39	21.33	21.17	20.75
		75	0	21.26	21.08	20.49
Bandwidth	Mode	RB Size	RB Offset	Actual output power(dBm)		
				Channel 18700 1860.0MHz	Channel 18900 1880.0MHz	Channel 19100 1900.0MHz
20MHz	QPSK	1	0	21.59	21.37	21.63
		1	50	21.28	21.00	21.29
		1	99	20.94	21.14	21.39
		50	0	20.81	21.56	20.79
		50	25	21.52	21.37	21.50
		50	50	20.98	21.11	20.94
		100	0	21.39	21.20	20.47
	16QAM	1	0	21.79	21.43	21.97
		1	50	21.03	21.04	21.31
		1	99	21.08	21.29	21.15
		50	0	20.62	20.61	20.83
		50	25	21.45	21.29	21.38
		50	50	21.18	21.34	21.29
		100	0	20.45	21.23	21.41

Band 4						
Bandwidth	Mode	RB Size	RB Offset	Actual output power(dBm)		
				Channel 19957 1710.7MHz	Channel 20175 1732.5MHz	Channel 20393 1754.3MHz
1.4MHz	QPSK	1	0	21.62	22.13	21.48
		1	2	21.78	21.72	21.62
		1	5	21.99	21.71	21.87
		3	0	21.27	21.29	21.49
		3	1	21.59	21.58	21.53
		3	2	21.57	21.47	21.32
		6	0	21.67	22.02	22.06
	16QAM	1	0	21.69	21.77	21.86
		1	2	21.32	21.45	21.38
		1	5	21.12	21.20	21.27
		3	0	20.86	20.85	20.48
		3	1	20.93	20.94	20.77
		3	2	20.89	20.99	20.60
		6	0	21.13	21.09	20.90
Bandwidth	Mode	RB Size	RB Offset	Actual output power(dBm)		
				Channel 19965 1711.5MHz	Channel 20175 1732.5MHz	Channel 20385 1753.5MHz
3MHz	QPSK	1	0	21.50	21.35	20.97
		1	8	21.19	21.02	21.08
		1	14	21.28	21.10	21.29
		8	0	21.38	21.24	21.12
		8	4	21.23	21.18	21.22
		8	7	21.29	21.02	21.15
		15	0	21.37	21.40	21.39
	16QAM	1	0	21.18	20.93	20.75
		1	8	20.98	20.67	21.18
		1	14	20.84	20.86	21.20
		8	0	20.41	20.99	21.12
		8	4	21.06	20.45	21.03
		8	7	21.11	21.06	20.29
		15	0	20.27	21.02	21.15

Bandwidth	Mode	RB Size	RB Offset	Actual output power(dBm)		
				Channel 19975 1712.5MHz	Channel 20175 1732.5MHz	Channel 20375 1752.5MHz
5MHz	QPSK	1	0	21.47	21.58	21.65
		1	13	21.65	21.51	21.37
		1	24	20.93	20.99	21.37
		12	0	21.29	21.15	21.30
		12	6	21.34	21.19	21.24
		12	13	21.23	21.12	21.11
		25	0	21.33	21.18	21.27
	16QAM	1	0	21.55	21.39	21.28
		1	13	21.13	20.89	21.01
		1	24	20.60	20.55	20.63
		12	0	20.43	21.30	20.45
		12	6	21.16	21.09	21.16
		12	13	21.62	21.56	21.59
		25	0	21.38	21.18	21.36
Bandwidth	Mode	RB Size	RB Offset	Actual output power(dBm)		
				Channel 20000 1715.0MHz	Channel 20175 1732.5MHz	Channel 20350 1750.0MHz
10MHz	QPSK	1	0	21.44	21.39	21.63
		1	25	20.74	20.40	21.10
		1	49	20.59	20.48	20.53
		25	0	20.42	21.29	21.26
		25	13	20.21	21.07	21.05
		25	25	21.33	21.28	21.24
		50	0	21.18	21.06	21.02
	16QAM	1	0	20.75	20.81	21.15
		1	25	21.20	20.66	21.20
		1	49	20.45	21.35	20.51
		25	0	20.24	21.19	21.06
		25	13	21.29	21.05	21.25
		25	25	20.23	20.35	20.54
		50	0	21.05	21.24	20.87

Bandwidth	Mode	RB Size	RB Offset	Actual output power(dBm)		
				Channel 20025 1717.5MHz	Channel 20175 1732.5MHz	Channel 20325 1747.5MHz
15MHz	QPSK	1	0	21.50	21.57	21.59
		1	38	21.19	20.88	21.12
		1	74	21.03	20.84	20.58
		36	0	20.73	20.54	20.68
		36	18	20.59	20.78	21.03
		36	39	21.17	20.57	20.36
		75	0	21.40	21.03	20.52
	16QAM	1	0	21.25	21.34	21.20
		1	38	20.56	20.75	20.86
		1	74	20.85	20.89	21.12
		36	0	21.45	21.57	21.48
		36	18	20.89	20.54	21.01
		36	39	21.08	21.24	21.33
		75	0	21.20	20.33	20.31
Bandwidth	Mode	RB Size	RB Offset	Actual output power(dBm)		
				Channel 20050 1720.0MHz	Channel 20175 1732.5MHz	Channel 20300 1745.0MHz
20MHz	QPSK	1	0	21.07	21.00	21.12
		1	50	21.05	20.78	20.70
		1	99	21.33	21.35	21.30
		50	0	21.52	21.58	21.44
		50	25	20.54	20.36	20.66
		50	50	20.92	20.79	21.01
		100	0	20.90	20.94	20.69
	16QAM	1	0	21.09	21.33	21.20
		1	50	20.94	20.58	21.12
		1	99	21.44	21.55	21.48
		50	0	20.80	20.91	20.83
		50	25	21.05	21.19	21.13
		50	50	21.33	21.48	20.51
		100	0	21.52	21.70	20.82

Band 12						
Bandwidth	Mode	RB Size	RB Offset	Actual output power(dBm)		
				Channel 23017 699.7MHz	Channel 23095 707.5MHz	Channel 23173 715.3MHz
1.4MHz	QPSK	1	0	21.38	21.44	21.86
		1	2	20.83	21.04	20.78
		1	5	20.75	20.99	20.68
		3	0	20.78	20.93	20.50
		3	1	20.77	20.88	20.75
		3	2	20.83	21.05	20.61
		6	0	20.91	21.03	20.49
	16QAM	1	0	20.74	20.97	20.35
		1	2	20.89	21.04	20.78
		1	5	20.82	21.00	20.64
		3	0	20.90	21.19	20.68
		3	1	20.74	21.08	20.65
		3	2	20.89	21.42	21.07
		6	0	20.76	20.89	20.53
Bandwidth	Mode	RB Size	RB Offset	Actual output power(dBm)		
				Channel 23025 700.5MHz	Channel 23095 707.5MHz	Channel 23165 714.5MHz
3MHz	QPSK	1	0	21.08	21.10	20.85
		1	8	21.38	21.73	21.20
		1	14	20.66	20.92	20.30
		8	0	20.97	21.27	20.44
		8	4	20.58	20.86	20.43
		8	7	21.08	21.46	21.10
		15	0	21.02	21.31	21.07
	16QAM	1	0	21.31	21.84	20.99
		1	8	20.80	21.14	20.98
		1	15	20.89	21.13	20.59
		8	0	20.82	21.08	20.84
		8	4	21.25	21.59	21.25
		8	7	20.97	21.02	20.67
		15	0	20.98	21.33	20.80

Bandwidth	Mode	RB Size	RB Offset	Actual output power(dBm)		
				Channel 23035 701.5MHz	Channel 23095 707.5MHz	Channel 23155 713.5MHz
5MHz	QPSK	1	0	21.18	21.30	21.39
		1	13	20.88	21.08	20.45
		1	24	20.79	20.92	20.49
		12	0	20.88	21.12	20.50
		12	6	21.34	21.49	20.95
		12	13	20.83	20.99	20.43
		25	0	20.99	21.22	20.86
	16QAM	1	0	20.80	20.82	20.39
		1	13	21.05	21.08	20.73
		1	24	20.83	20.98	20.63
		12	0	20.75	21.38	21.23
		12	6	20.74	20.79	20.42
		12	13	20.74	21.18	20.95
		25	0	20.85	21.20	20.83
Bandwidth	Mode	RB Size	RB Offset	Actual output power(dBm)		
				Channel 23060 704.0MHz	Channel 23095 707.5MHz	Channel 23130 711.0MHz
10MHz	QPSK	1	0	21.18	21.04	20.96
		1	25	21.28	21.41	21.07
		1	49	20.63	20.65	20.44
		25	0	21.09	21.24	20.92
		25	13	20.78	20.94	20.79
		25	25	21.07	21.20	20.96
		50	0	20.76	20.96	20.61
	16QAM	1	0	21.07	21.23	21.00
		1	25	20.66	20.79	20.47
		1	49	20.98	21.14	20.99
		25	0	20.79	20.94	20.78
		25	13	21.23	21.35	21.03
		25	25	21.00	21.25	21.03
		50	0	20.89	21.11	20.87

EIRP/ERP:

Band 2						
Bandwidth	Mode	RB Size	RB Offset	Actual output power(dBm)		
				Channel 18607 1850.7MHz	Channel 18900 1880.0MHz	Channel 19193 1909.3MHz
1.4MHz	QPSK	1	0	24.67	24.6	24.75
		1	2	24.99	24.84	24.95
		1	5	25.15	25.21	25.36
		3	0	24.94	24.79	25.17
		3	1	24.76	24.65	24.86
		3	2	24.29	24.44	24.73
		6	0	25.04	25.27	25.01
	16QAM	1	0	24.57	24.44	24.63
		1	2	24.22	24.06	24.28
		1	5	24.98	24.9	24.8
		3	0	24.91	24.78	24.83
		3	1	24.74	24.79	24.68
		3	2	24.91	24.98	25.24
		6	0	24.54	24.55	24.38
Bandwidth	Mode	RB Size	RB Offset	Actual output power(dBm)		
				Channel 18615 1851.5MHz	Channel 18900 1880.0MHz	Channel 19185 1908.5MHz
3MHz	QPSK	1	0	25.59	25.2	24.88
		1	8	24.05	24.16	24.7
		1	14	24.88	24.06	24.39
		8	0	24.38	24.18	24.07
		8	4	24.52	24.64	24.74
		8	7	24.29	24.58	23.82
		15	0	24.23	24.53	24.24
	16QAM	1	0	24.47	24.25	24.58
		1	8	24.76	24.52	24.28
		1	14	25.23	24.95	24.96
		8	0	24.78	24.58	24.28
		8	4	24.35	23.88	24.04
		8	7	24.26	24.48	24.64
		15	0	24.98	24.96	25.08

Bandwidth	Mode	RB Size	RB Offset	Actual output power(dBm)		
				Channel 18625 1852.5MHz	Channel 18900 1880.0MHz	Channel 19175 1907.5MHz
5MHz	QPSK	1	0	24.75	24.68	24.56
		1	13	24.69	24.25	24.56
		1	24	24.72	24.37	24.81
		12	0	24.19	24.5	24.47
		12	6	24.37	24.53	24.05
		12	13	24.61	24.46	24.58
		25	0	24.59	24.45	24.69
	16QAM	1	0	23.99	24.63	23.81
		1	13	24	24.56	24.67
		1	24	24.35	24.98	25.01
		12	0	24.02	23.96	24.17
		12	6	24.18	24.37	24.65
		12	13	24.55	24.75	23.93
		25	0	24.78	24.79	24.91
Bandwidth	Mode	RB Size	RB Offset	Actual output power(dBm)		
				Channel 18650 1855.0MHz	Channel 18900 1880.0MHz	Channel 19150 1905.0MHz
10MHz	QPSK	1	0	24.97	24.9	24.95
		1	25	24.71	24.61	24.85
		1	49	24.76	24.6	24.72
		25	0	24.11	24.99	24.14
		25	13	24.98	24.85	25.05
		25	25	24.91	24.86	25.07
		50	0	25.11	24.85	25.12
	16QAM	1	0	23.94	24.33	24.35
		1	25	24.42	23.97	23.92
		1	49	24.48	24.9	24.04
		25	0	23.9	24.77	23.96
		25	13	24.67	24.45	24.58
		25	25	24.66	24.43	24.52
		50	0	24.68	24.53	24.55

Bandwidth	Mode	RB Size	RB Offset	Actual output power(dBm)		
				Channel 18675 1857.5MHz	Channel 18900 1880.0MHz	Channel 19125 1902.5MHz
15MHz	QPSK	1	0	25.24	25.19	25.23
		1	38	24.98	24.83	25.05
		1	74	24.69	24.37	24.53
		36	0	24.12	23.97	24.08
		36	18	24.83	24.7	23.95
		36	39	24.74	24.77	23.96
		75	0	23.97	24.84	23.95
	16QAM	1	0	24.28	24.6	24.47
		1	38	24.78	24.17	24.17
		1	74	24.82	24.24	24.11
		36	0	23.98	23.96	24.09
		36	18	23.92	24.68	23.94
		36	39	24.83	24.67	24.25
		75	0	24.76	24.58	23.99
Bandwidth	Mode	RB Size	RB Offset	Actual output power(dBm)		
				Channel 18700 1860.0MHz	Channel 18900 1880.0MHz	Channel 19100 1900.0MHz
20MHz	QPSK	1	0	25.09	24.87	25.13
		1	50	24.78	24.5	24.79
		1	99	24.44	24.64	24.89
		50	0	24.31	25.06	24.29
		50	25	25.02	24.87	25
		50	50	24.48	24.61	24.44
		100	0	24.89	24.7	23.97
	16QAM	1	0	25.29	24.93	25.47
		1	50	24.53	24.54	24.81
		1	99	24.58	24.79	24.65
		50	0	24.12	24.11	24.33
		50	25	24.95	24.79	24.88
		50	50	24.68	24.84	24.79
		100	0	23.95	24.73	24.91

Band 4						
Bandwidth	Mode	RB Size	RB Offset	Actual output power(dBm)		
				Channel 19957 1710.7MHz	Channel 20175 1732.5MHz	Channel 20393 1754.3MHz
1.4MHz	QPSK	1	0	25.12	25.63	24.98
		1	2	25.28	25.22	25.12
		1	5	25.49	25.21	25.37
		3	0	24.77	24.79	24.99
		3	1	25.09	25.08	25.03
		3	2	25.07	24.97	24.82
		6	0	25.17	25.52	25.56
	16QAM	1	0	25.19	25.27	25.36
		1	2	24.82	24.95	24.88
		1	5	24.62	24.7	24.77
		3	0	24.36	24.35	23.98
		3	1	24.43	24.44	24.27
		3	2	24.39	24.49	24.1
		6	0	24.63	24.59	24.4
Bandwidth	Mode	RB Size	RB Offset	Actual output power(dBm)		
				Channel 19965 1711.5MHz	Channel 20175 1732.5MHz	Channel 20385 1753.5MHz
3MHz	QPSK	1	0	25	24.85	24.47
		1	8	24.69	24.52	24.58
		1	14	24.78	24.6	24.79
		8	0	24.88	24.74	24.62
		8	4	24.73	24.68	24.72
		8	7	24.79	24.52	24.65
		15	0	24.87	24.9	24.89
	16QAM	1	0	24.68	24.43	24.25
		1	8	24.48	24.17	24.68
		1	14	24.34	24.36	24.7
		8	0	23.91	24.49	24.62
		8	4	24.56	23.95	24.53
		8	7	24.61	24.56	23.79
		15	0	23.77	24.52	24.65

Bandwidth	Mode	RB Size	RB Offset	Actual output power(dBm)		
				Channel 19975 1712.5MHz	Channel 20175 1732.5MHz	Channel 20375 1752.5MHz
5MHz	QPSK	1	0	24.97	25.08	25.15
		1	13	25.15	25.01	24.87
		1	24	24.43	24.49	24.87
		12	0	24.79	24.65	24.8
		12	6	24.84	24.69	24.74
		12	13	24.73	24.62	24.61
	16QAM	25	0	24.83	24.68	24.77
		1	0	25.05	24.89	24.78
		1	13	24.63	24.39	24.51
		1	24	24.1	24.05	24.13
		12	0	23.93	24.8	23.95
		12	6	24.66	24.59	24.66
		12	13	25.12	25.06	25.09
		25	0	24.88	24.68	24.86
Bandwidth	Mode	RB Size	RB Offset	Actual output power(dBm)		
				Channel 20000 1715.0MHz	Channel 20175 1732.5MHz	Channel 20350 1750.0MHz
10MHz	QPSK	1	0	24.94	24.89	25.13
		1	25	24.24	23.9	24.6
		1	49	24.09	23.98	24.03
		25	0	23.92	24.79	24.76
		25	13	23.71	24.57	24.55
		25	25	24.83	24.78	24.74
		50	0	24.68	24.56	24.52
	16QAM	1	0	24.25	24.31	24.65
		1	25	24.7	24.16	24.7
		1	49	23.95	24.85	24.01
		25	0	23.74	24.69	24.56
		25	13	24.79	24.55	24.75
		25	25	23.73	23.85	24.04
		50	0	24.55	24.74	24.37

Bandwidth	Mode	RB Size	RB Offset	Actual output power(dBm)		
				Channel 20025 1717.5MHz	Channel 20175 1732.5MHz	Channel 20325 1747.5MHz
15MHz	QPSK	1	0	25	25.07	25.09
		1	38	24.69	24.38	24.62
		1	74	24.53	24.34	24.08
		36	0	24.23	24.04	24.18
		36	18	24.09	24.28	24.53
		36	39	24.67	24.07	23.86
		75	0	24.9	24.53	24.02
	16QAM	1	0	24.75	24.84	24.7
		1	38	24.06	24.25	24.36
		1	74	24.35	24.39	24.62
		36	0	24.95	25.07	24.98
		36	18	24.39	24.04	24.51
		36	39	24.58	24.74	24.83
		75	0	24.7	23.83	23.81
Bandwidth	Mode	RB Size	RB Offset	Actual output power(dBm)		
				Channel 20050 1720.0MHz	Channel 20175 1732.5MHz	Channel 20300 1745.0MHz
20MHz	QPSK	1	0	24.57	24.5	24.62
		1	50	24.55	24.28	24.2
		1	99	24.83	24.85	24.8
		50	0	25.02	25.08	24.94
		50	25	24.04	23.86	24.16
		50	50	24.42	24.29	24.51
		100	0	24.4	24.44	24.19
	16QAM	1	0	24.59	24.83	24.7
		1	50	24.44	24.08	24.62
		1	99	24.94	25.05	24.98
		50	0	24.3	24.41	24.33
		50	25	24.55	24.69	24.63
		50	50	24.83	24.98	24.01
		100	0	25.02	25.2	24.32

Band 12						
Bandwidth	Mode	RB Size	RB Offset	Actual output power(dBm)		
				Channel 23017 699.7MHz	Channel 23095 707.5MHz	Channel 23173 715.3MHz
1.4MHz	QPSK	1	0	22.73	22.79	23.21
		1	2	22.18	22.39	22.13
		1	5	22.1	22.34	22.03
		3	0	22.13	22.28	21.85
		3	1	22.12	22.23	22.1
		3	2	22.18	22.4	21.96
		6	0	22.26	22.38	21.84
	16QAM	1	0	22.09	22.32	21.7
		1	2	22.24	22.39	22.13
		1	5	22.17	22.35	21.99
		3	0	22.25	22.54	22.03
		3	1	22.09	22.43	22
		3	2	22.24	22.77	22.42
		6	0	22.11	22.24	21.88
Bandwidth	Mode	RB Size	RB Offset	Actual output power(dBm)		
				Channel 23025 700.5MHz	Channel 23095 707.5MHz	Channel 23165 714.5MHz
3MHz	QPSK	1	0	22.43	22.45	22.2
		1	8	22.73	23.08	22.55
		1	14	22.01	22.27	21.65
		8	0	22.32	22.62	21.79
		8	4	21.93	22.21	21.78
		8	7	22.43	22.81	22.45
		15	0	22.37	22.66	22.42
	16QAM	1	0	22.66	23.19	22.34
		1	8	22.15	22.49	22.33
		1	15	22.24	22.48	21.94
		8	0	22.17	22.43	22.19
		8	4	22.6	22.94	22.6
		8	7	22.32	22.37	22.02
		15	0	22.33	22.68	22.15

Bandwidth	Mode	RB Size	RB Offset	Actual output power(dBm)		
				Channel 23035 701.5MHz	Channel 23095 707.5MHz	Channel 23155 713.5MHz
5MHz	QPSK	1	0	22.53	22.65	22.74
		1	13	22.23	22.43	21.8
		1	24	22.14	22.27	21.84
		12	0	22.23	22.47	21.85
		12	6	22.69	22.84	22.3
		12	13	22.18	22.34	21.78
		25	0	22.34	22.57	22.21
	16QAM	1	0	22.15	22.17	21.74
		1	13	22.4	22.43	22.08
		1	24	22.18	22.33	21.98
		12	0	22.1	22.73	22.58
		12	6	22.09	22.14	21.77
		12	13	22.09	22.53	22.3
		25	0	22.2	22.55	22.18
Bandwidth	Mode	RB Size	RB Offset	Actual output power(dBm)		
				Channel 23060 704.0MHz	Channel 23095 707.5MHz	Channel 23130 711.0MHz
10MHz	QPSK	1	0	22.53	22.39	22.31
		1	25	22.63	22.76	22.42
		1	49	21.98	22	21.79
		25	0	22.44	22.59	22.27
		25	13	22.13	22.29	22.14
		25	25	22.42	22.55	22.31
		50	0	22.11	22.31	21.96
	16QAM	1	0	22.42	22.58	22.35
		1	25	22.01	22.14	21.82
		1	49	22.33	22.49	22.34
		25	0	22.14	22.29	22.13
		25	13	22.58	22.7	22.38
		25	25	22.35	22.6	22.38
		50	0	22.24	22.46	22.22

7.4 Peak-to-Average Ratio

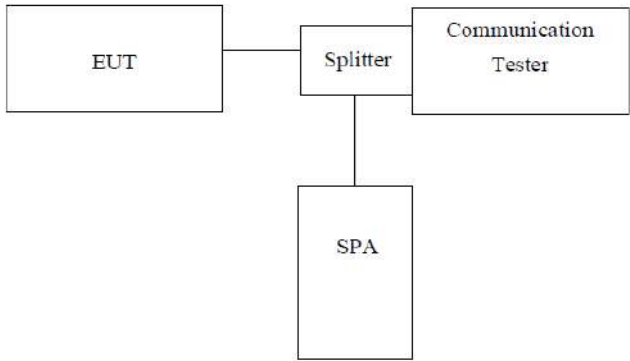
Test Requirement:	Part 27.50(d)(5)
Test Method:	FCC part2.1046
Limit:	13db
Test setup:	 <p><i>Note: Measurement setup for testing on Antenna connector</i></p>
Test Procedure:	<ol style="list-style-type: none"> 1. The transmitter output port was connected to base station. 2. The RF output of EUT was connected to the power meter by RF cable and attenuator, the path loss was compensated to the results for each measurement. 3. Set EUT at maximum power through base station. 4. Select lowest, middle, and highest channels for each band and different modulation. 5. Measure the maximum burst average power. 6. Record the maximum peak-to-average ratio value.
Test Instruments:	Refer to section 6.0 for details
Test mode:	Refer to section 7.1 for details
Test results:	Pass

Remark: Both modulation modes have been tested, showing only the worst QPSK test data.

Measurement Data

Test Band	Bandwidth	RB Configure		Peak to Average Ratio (dB)			Limit (dB)	Result
		RB Size	RB Offset	Low Ch.	Middle Ch.	High Ch.		
LTE Band 2	1.4MHz	6	0	3.59	4.57	4.19	13	PASS
	3MHz	15	0	3.68	4.65	4.85	13	PASS
	5MHz	25	0	3.58	4.47	4.49	13	PASS
	10MHz	50	0	4.61	4.59	4.61	13	PASS
	15MHz	75	0	5.77	5.77	5.78	13	PASS
	20MHz	100	0	6.60	6.58	6.61	13	PASS
LTE Band 4	1.4MHz	6	0	4.38	5.00	4.99	13	PASS
	3MHz	15	0	4.67	5.00	5.13	13	PASS
	5MHz	25	0	4.85	5.07	5.04	13	PASS
	10MHz	50	0	4.62	4.58	4.59	13	PASS
	15MHz	75	0	5.79	5.77	5.75	13	PASS
	20MHz	100	0	6.56	6.53	6.54	13	PASS
LTE Band 12	1.4MHz	6	0	5.18	5.47	5.11	13	PASS
	3MHz	15	0	5.27	5.59	5.32	13	PASS
	5MHz	25	0	5.18	5.41	5.25	13	PASS
	10MHz	50	0	4.58	4.63	4.68	13	PASS

Test band: LTE Band 2 Channel Bandwidth: 1.4MHz

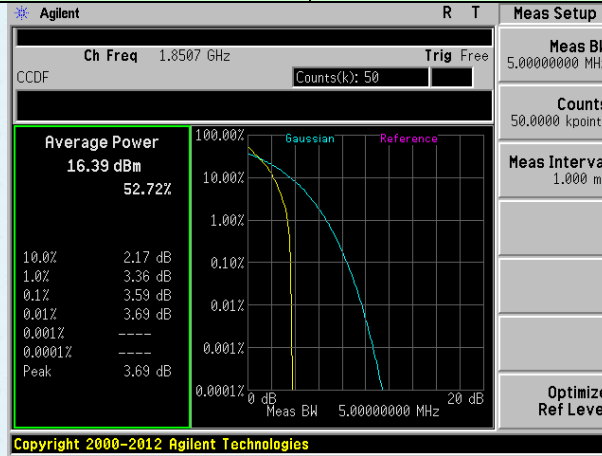

Lowest channel

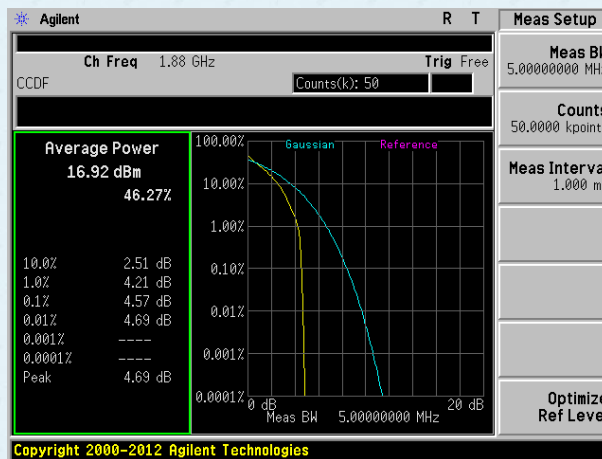

Middle channel

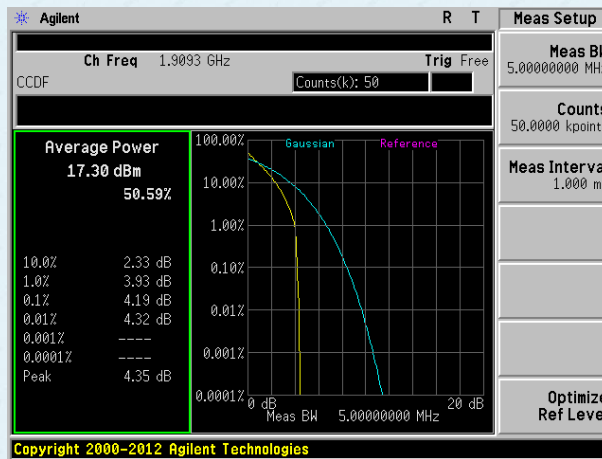

Highest channel

Test band: LTE Band 2 Channel Bandwidth: 3MHz

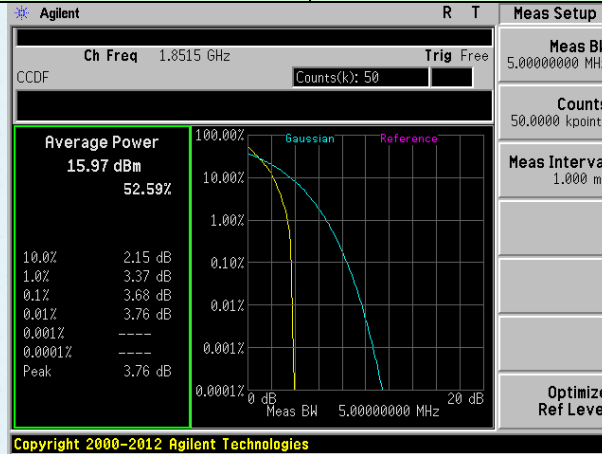

Lowest channel

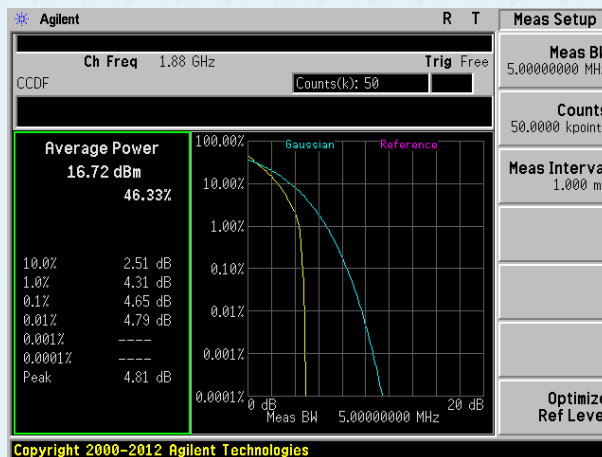

Middle channel

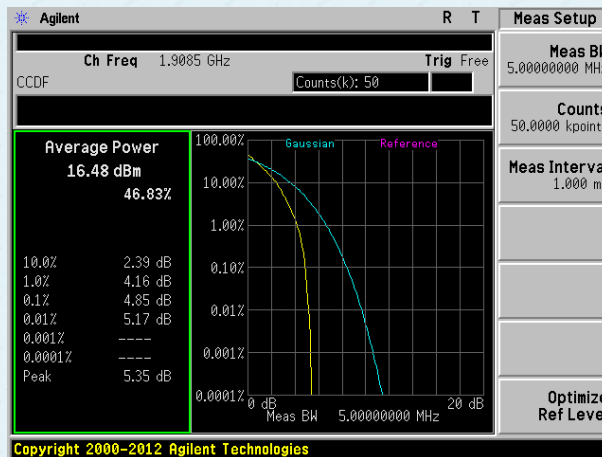

Highest channel

Test band: LTE Band 2 Channel Bandwidth: 5MHz

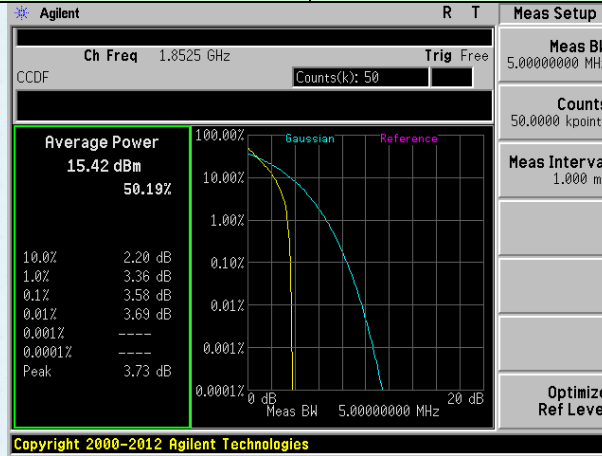

Lowest channel

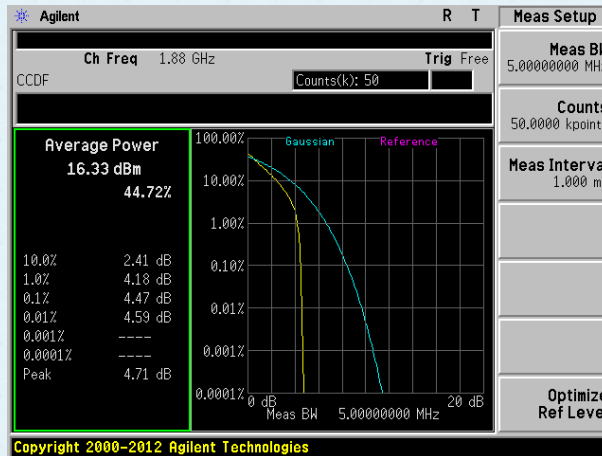

Middle channel

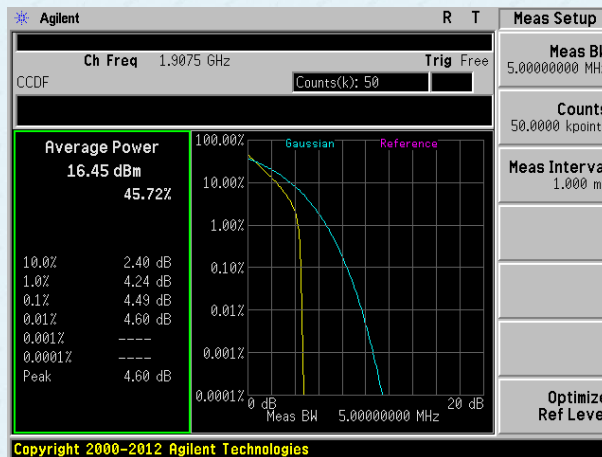

Highest channel

Test band: LTE Band 2 Channel Bandwidth: 10MHz

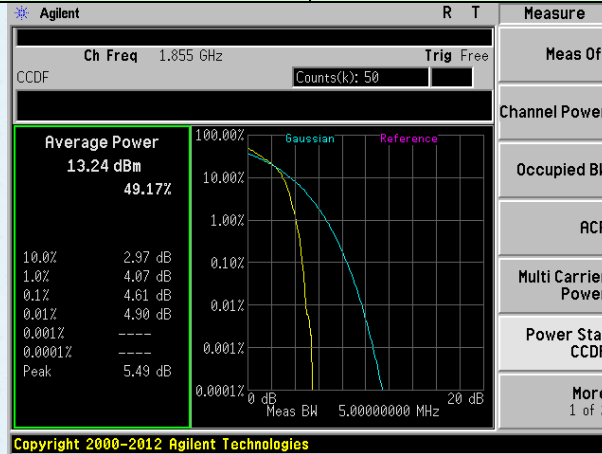

Lowest channel

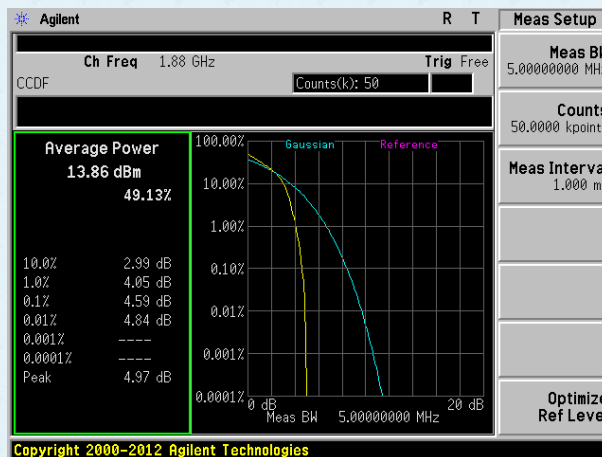

Middle channel

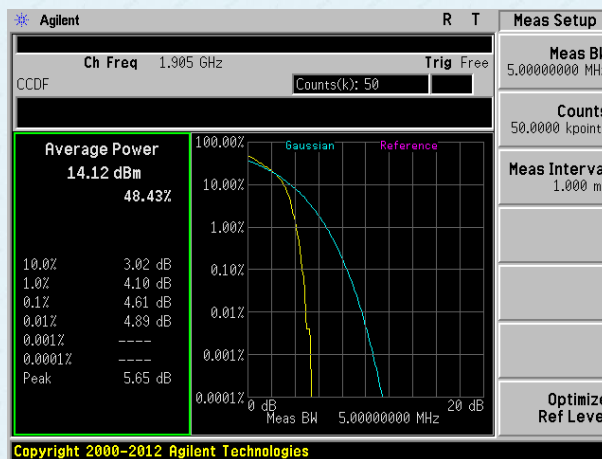

Highest channel

Test band: LTE Band 2 Channel Bandwidth: 15MHz

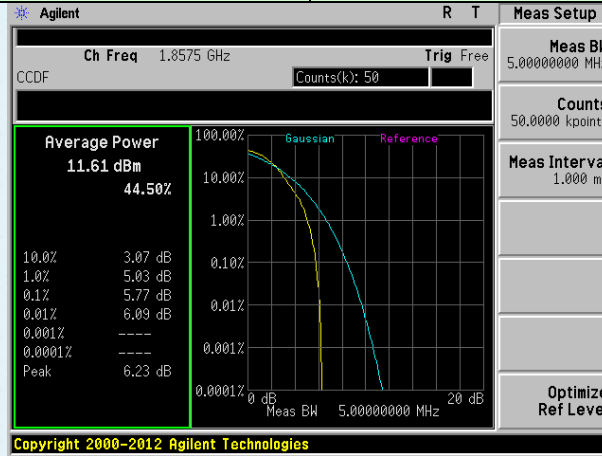

Lowest channel

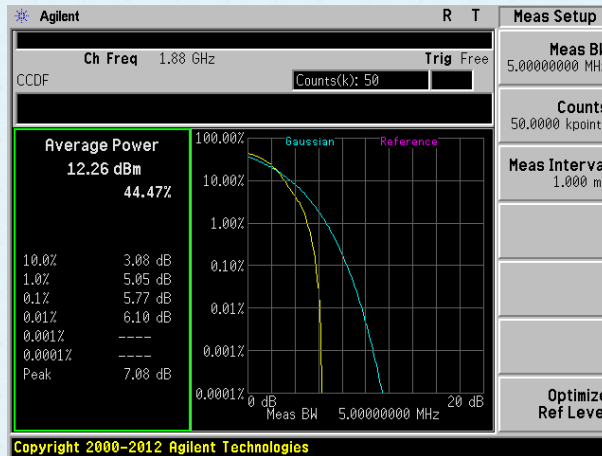

Middle channel



Highest channel

Test band: LTE Band 2 Channel Bandwidth: 20MHz

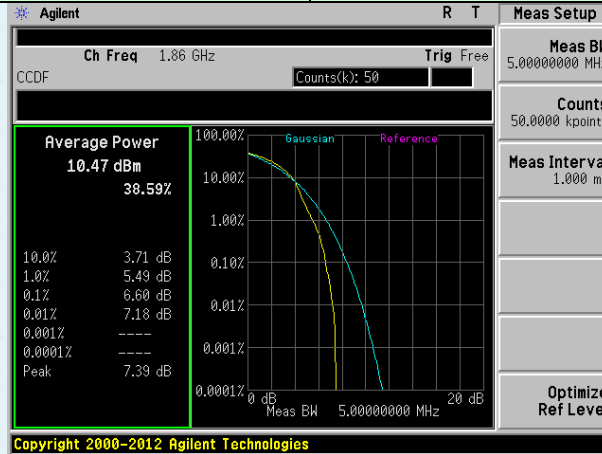

Lowest channel

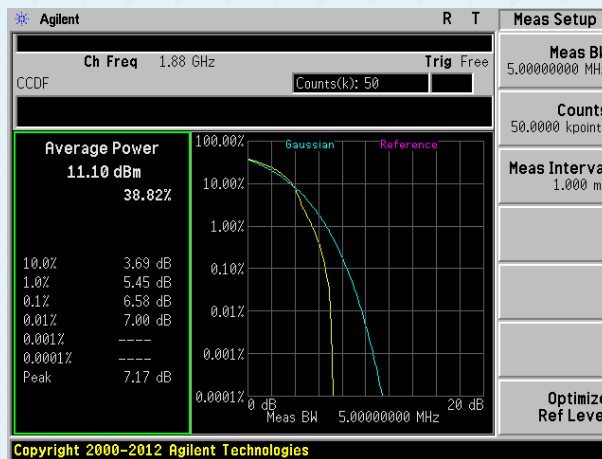

Middle channel

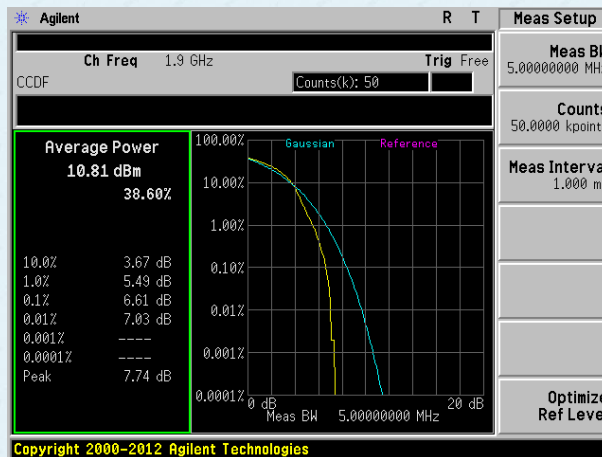

Highest channel

Test band: LTE Band 4 Channel Bandwidth: 1.4MHz

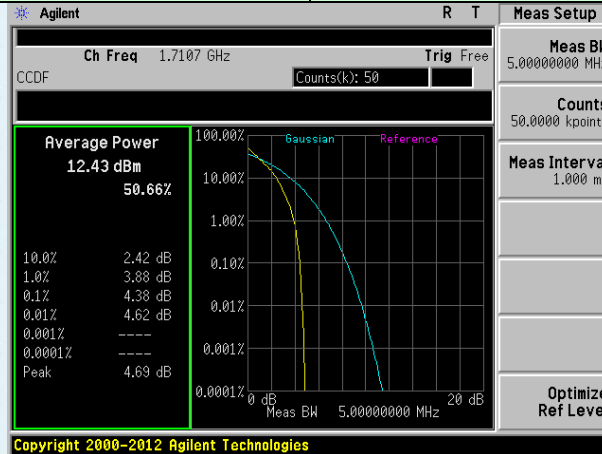

Lowest channel

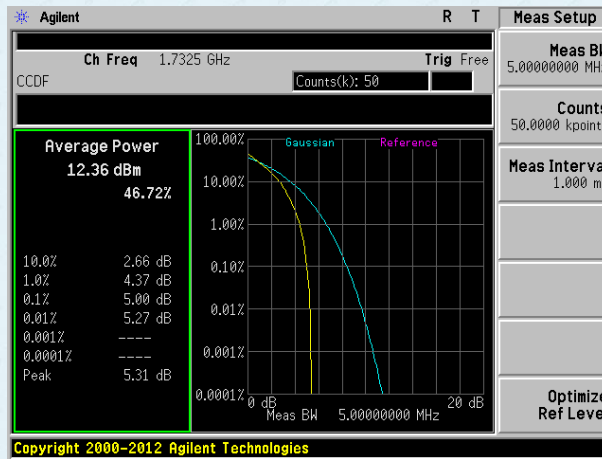

Middle channel

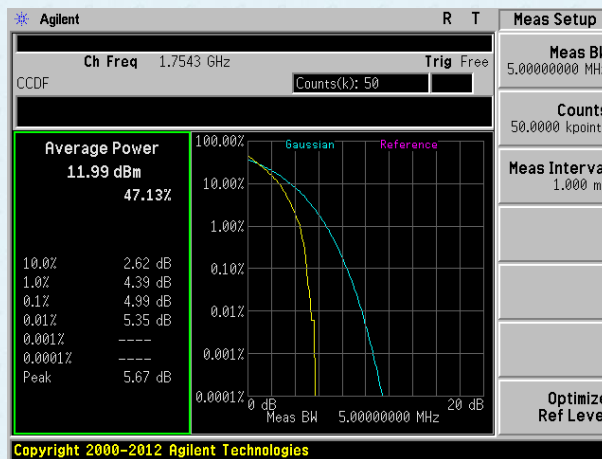

Highest channel

Test band: LTE Band 4 Channel Bandwidth: 3MHz

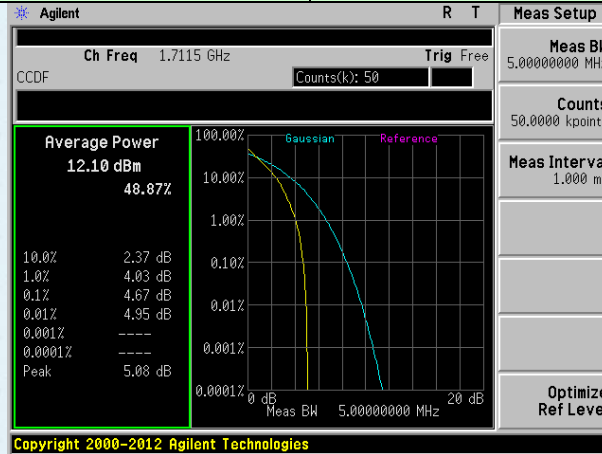

Lowest channel

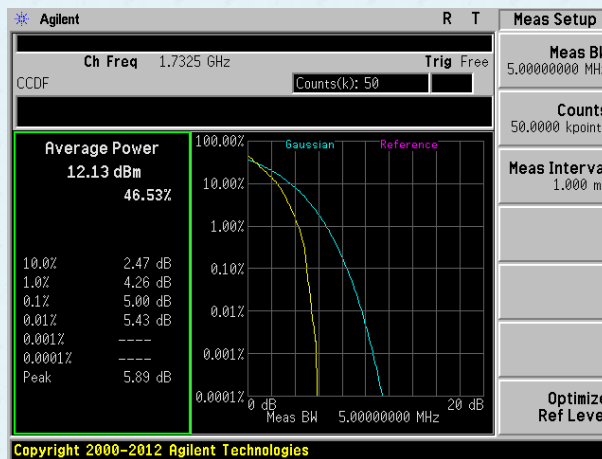

Middle channel



Highest channel

Test band: LTE Band 4 Channel Bandwidth: 5MHz

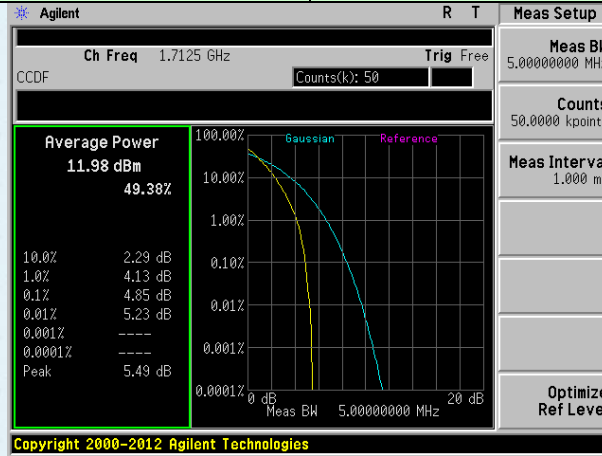

Lowest channel

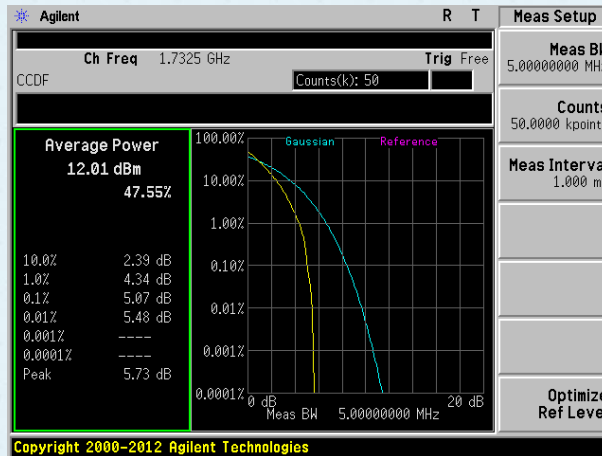

Middle channel



Highest channel

Test band: LTE Band 4 Channel Bandwidth: 10MHz

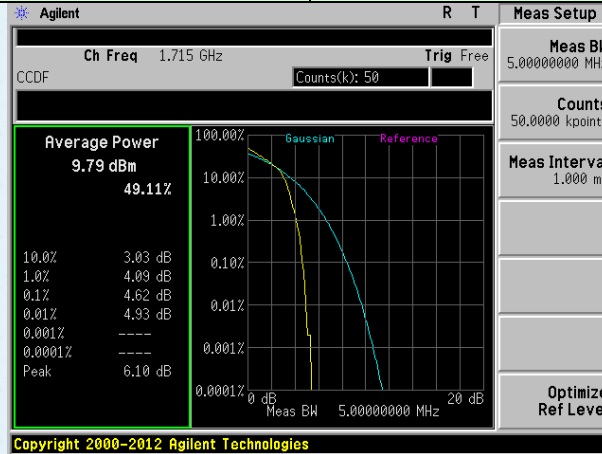

Lowest channel

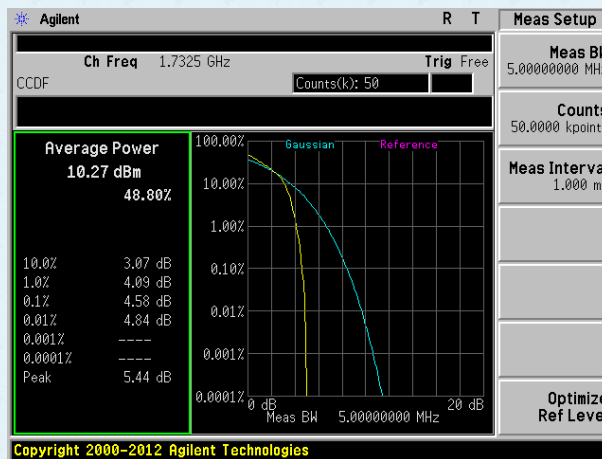

Middle channel

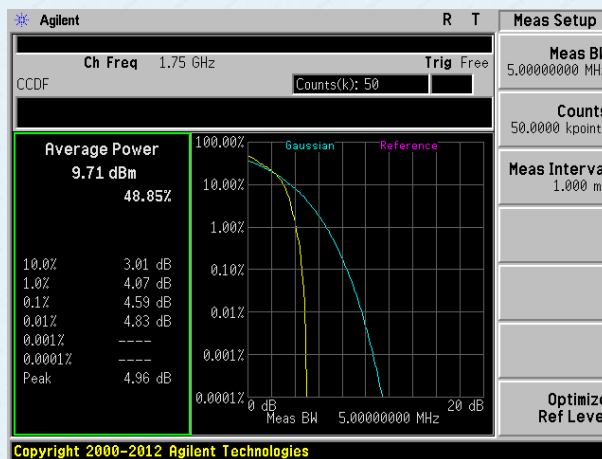

Highest channel

Test band: LTE Band 4 Channel Bandwidth: 15MHz

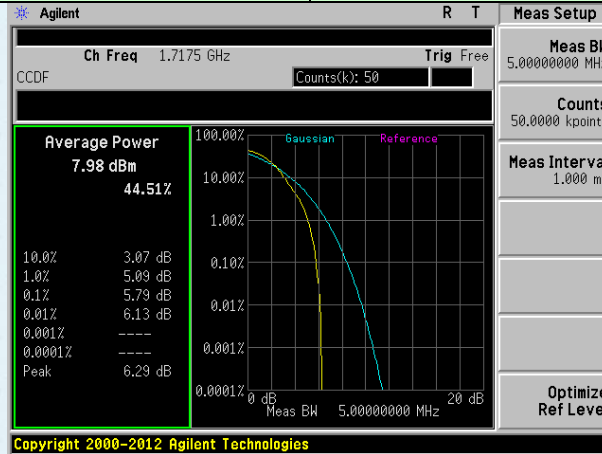

Lowest channel

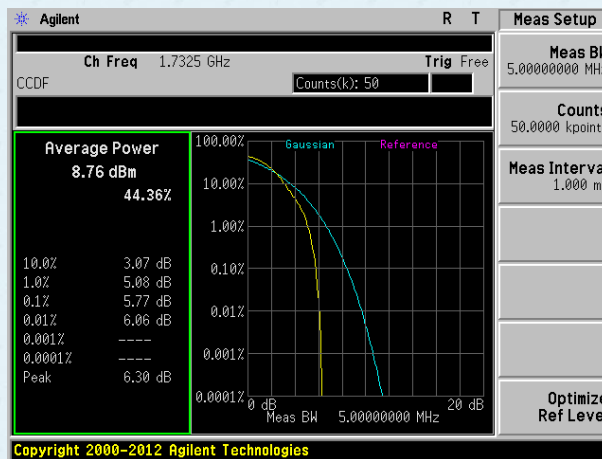

Middle channel



Highest channel

Test band: LTE Band 4 Channel Bandwidth: 20MHz

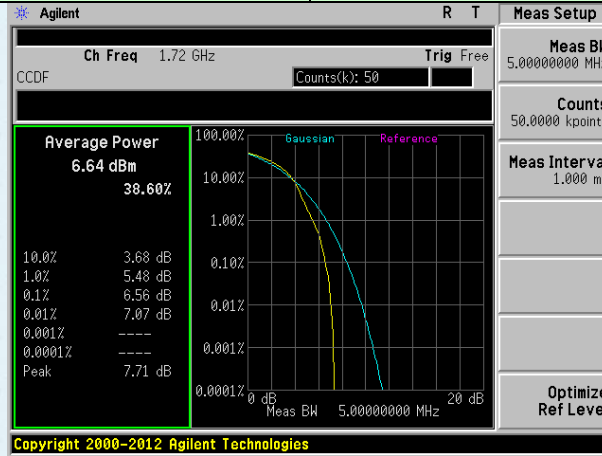

Lowest channel

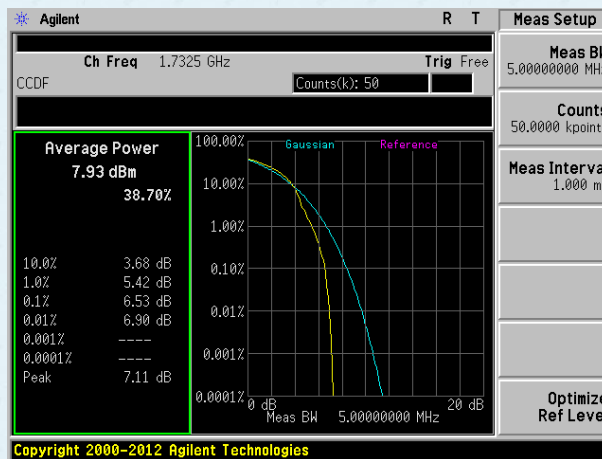

Middle channel

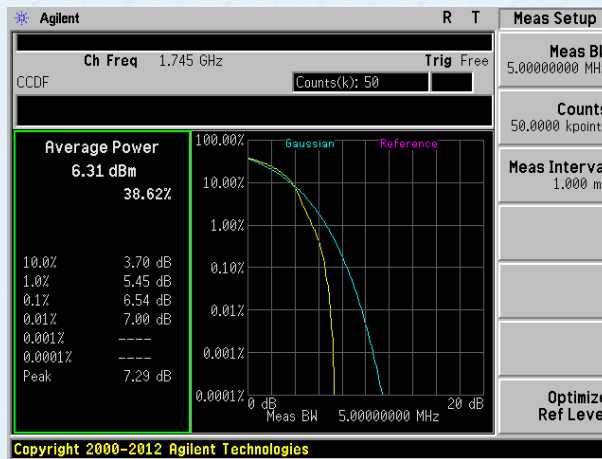

Highest channel

Test band: LTE Band 12 Channel Bandwidth: 1.4MHz

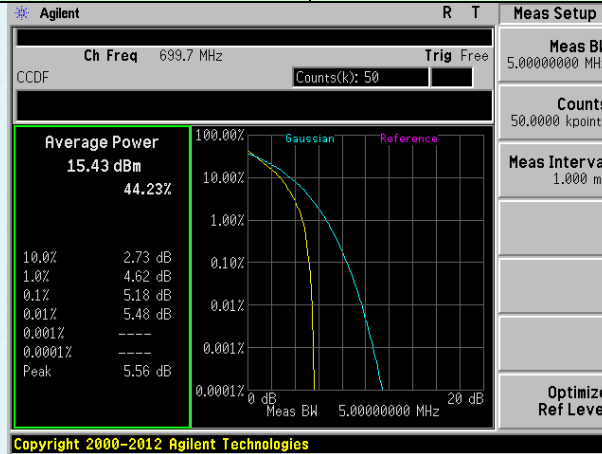

Lowest channel

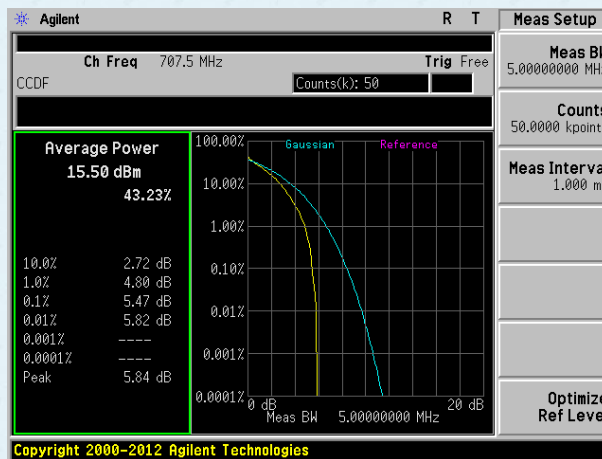

Middle channel

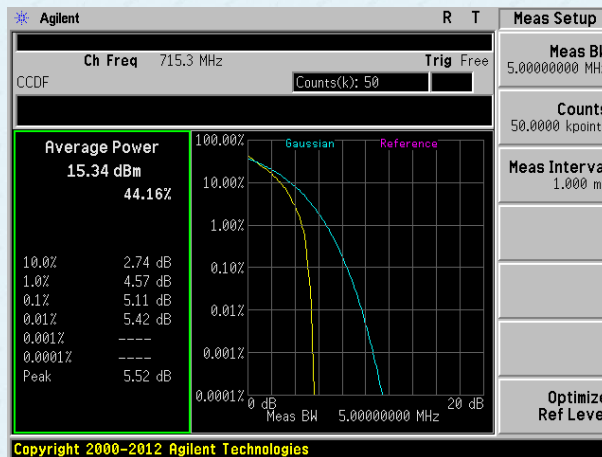

Highest channel

Test band: LTE Band 12 Channel Bandwidth: 3MHz

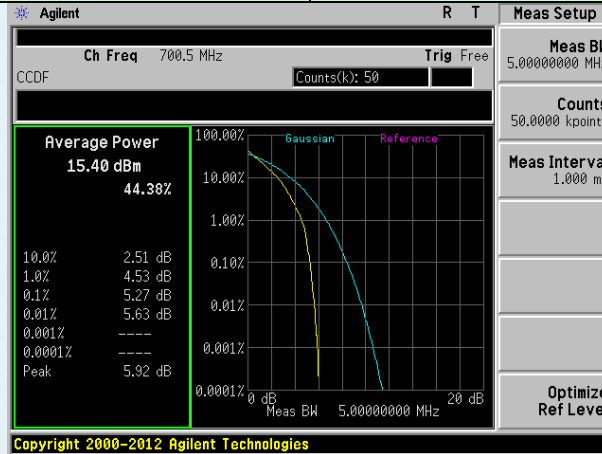

Lowest channel

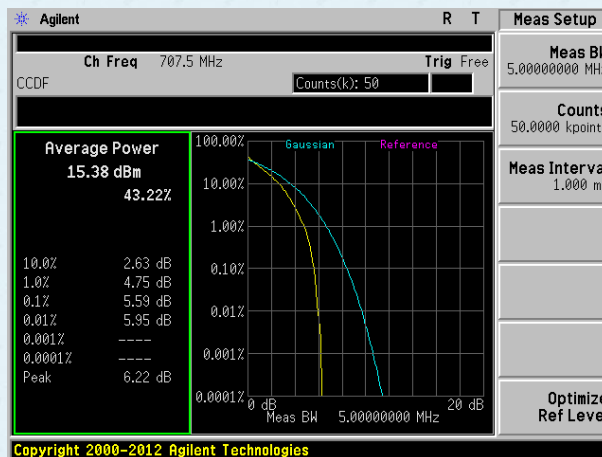

Middle channel



Highest channel

Test band: LTE Band 12 Channel Bandwidth: 5MHz

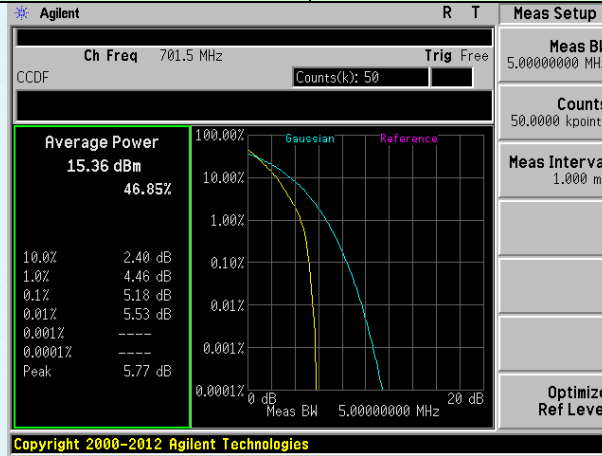

Lowest channel

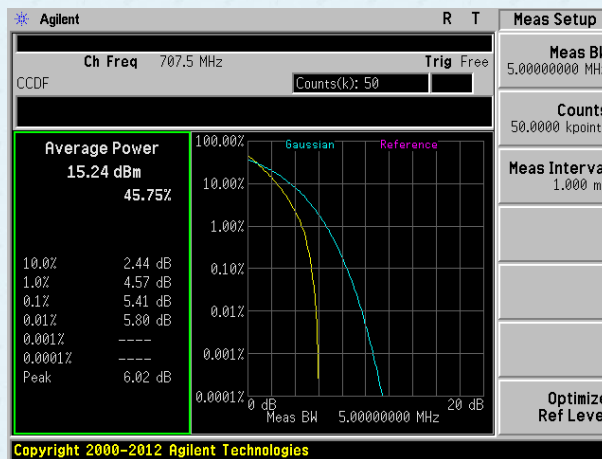

Middle channel

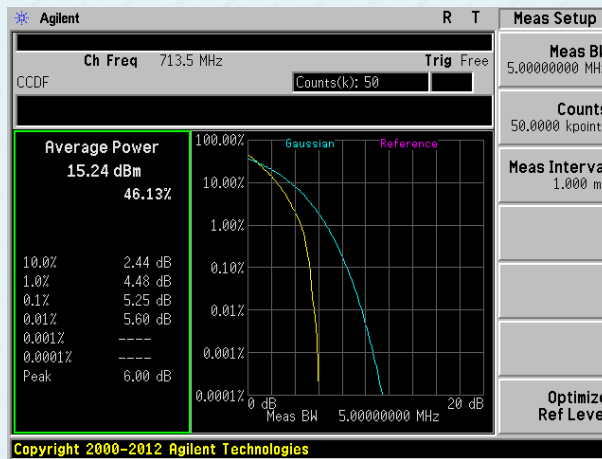

Highest channel

Test band: LTE Band 12 Channel Bandwidth:10MHz

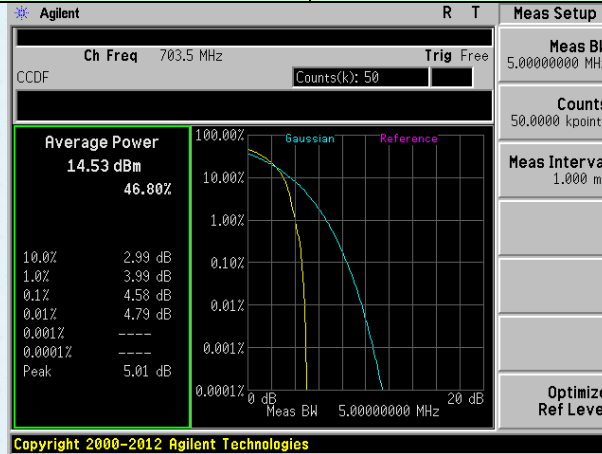

Lowest channel

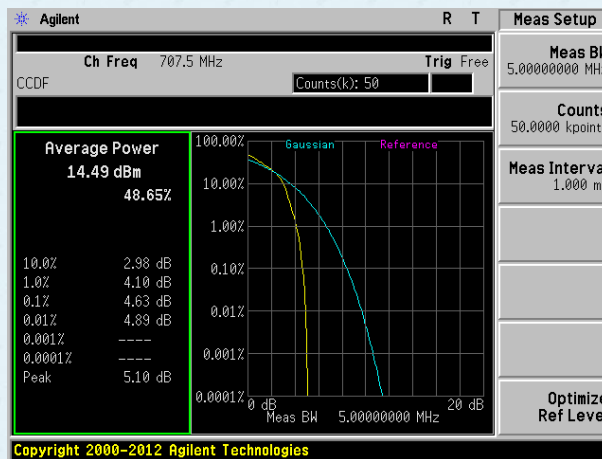

Middle channel



Highest channel

7.5 Occupancy Bandwidth

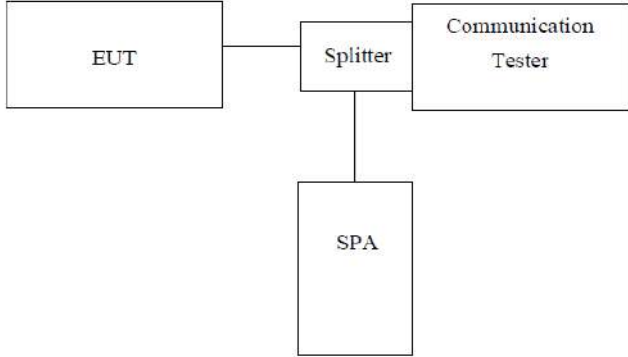
Test Requirement:	Part 24.238; FCC Part 27.53(h)/(g)
Test Method:	FCC part2.1049
Test setup:	 <p><i>Note: Measurement setup for testing on Antenna connector</i></p>
Test Procedure:	<ol style="list-style-type: none"> 1. The EUT's output RF connector was connected with a short cable to the spectrum analyzer 2. RBW was set to about 1% of emission BW, VBW= 3 times RBW. 3. -26dBc display line was placed on the screen (or 99% bandwidth), the occupied bandwidth is the delta frequency between the two points where the display line intersects the signal trace.
Test Instruments:	Refer to section 6.0 for details
Test mode:	Refer to section 7.1 for details
Test results:	Pass

Measurement Data

QPSK mode:

EUT Mode	Channel Bandwidth	Channel	RB Configure		99% Occupy bandwidth (KHz)	-26dB bandwidth (KHz)
			RB Size	RB Offset		
LTE Band 2	1.4MHz	Low range	6	0	1097.70	1281.00
		Mid range	6	0	1095.00	1307.00
		High range	6	0	1101.20	1314.00
	3MHz	Low range	15	0	2686.90	2952.00
		Mid range	15	0	2744.00	3084.00
		High range	15	0	2746.40	3071.00
	5MHz	Low range	25	0	4513.30	4999.00
		Mid range	25	0	4512.80	4993.00
		High range	25	0	4504.90	4966.00
	10MHz	Low range	50	0	8948.80	9819.00
		Mid range	50	0	8967.60	10034.00
		High range	50	0	8982.40	9977.00
	15MHz	Low range	75	0	13382.60	14395.00
		Mid range	75	0	13415.30	14714.00
		High range	75	0	13405.40	14832.00
	20MHz	Low range	100	0	17839.00	19125.00
		Mid range	100	0	17861.70	19343.00
		High range	100	0	17817.30	19566.00

EUT Mode	Channel Bandwidth	Channel	RB Configure		99% Occupy bandwidth (KHz)	-26dB bandwidth (KHz)
			RB Size	RB Offset		
LTE Band 4	1.4MHz	Low range	6	0	1101.50	1329.00
		Mid range	6	0	1090.10	1291.00
		High range	6	0	1097.30	1301.00
	3MHz	Low range	15	0	2681.40	2936.00
		Mid range	15	0	2687.60	2932.00
		High range	15	0	2681.60	2939.00
	5MHz	Low range	25	0	4517.30	4995.00
		Mid range	25	0	4518.70	4959.00
		High range	25	0	4555.10	4974.00
	10MHz	Low range	50	0	8938.80	9849.00
		Mid range	50	0	8965.90	10101.00
		High range	50	0	8949.00	10103.00
	15MHz	Low range	75	0	13377.20	14825.00
		Mid range	75	0	13402.80	14923.00
		High range	75	0	13373.50	14802.00
	20MHz	Low range	100	0	17821.10	19044.00
		Mid range	100	0	17869.70	19259.00
		High range	100	0	17770.50	19100.00

EUT Mode	Channel Bandwidth	Channel	RB Configure		99% Occupy bandwidth (KHz)	-26dB bandwidth (KHz)
			RB Size	RB Offset		
LTE Band 12	1.4MHz	Low range	6	0	1097.80	1262.00
		Mid range	6	0	1103.80	1291.00
		High range	6	0	1095.90	1273.00
	3MHz	Low range	15	0	2684.30	2927.00
		Mid range	15	0	2690.90	2938.00
		High range	15	0	2685.10	2947.00
	5MHz	Low range	25	0	4506.10	5096.00
		Mid range	25	0	4538.00	5055.00
		High range	25	0	4509.60	5079.00
	10MHz	Low range	50	0	8941.90	9949.00
		Mid range	50	0	8957.90	9928.00
		High range	50	0	8953.50	9932.00

16QAM mode:

EUT Mode	Channel Bandwidth	Channel	RB Configure		99% Occupy bandwidth (KHz)	-26dB bandwidth (KHz)
			RB Size	RB Offset		
LTE Band 2	1.4MHz	Low range	6	0	1097.70	1311.00
		Mid range	6	0	1097.60	1287.00
		High range	6	0	1096.80	1288.00
	3MHz	Low range	15	0	2683.60	2962.00
		Mid range	15	0	2742.40	3061.00
		High range	15	0	2746.20	3041.00
	5MHz	Low range	25	0	4516.30	5005.00
		Mid range	25	0	4506.20	4954.00
		High range	25	0	4503.90	5043.00
	10MHz	Low range	50	0	8936.20	9800.00
		Mid range	50	0	8962.70	10089.00
		High range	50	0	8967.80	9742.00
	15MHz	Low range	75	0	13390.40	14260.00
		Mid range	75	0	13393.40	14788.00
		High range	75	0	13399.70	14900.00
	20MHz	Low range	100	0	17824.20	18969.00
		Mid range	100	0	17873.70	18985.00
		High range	100	0	17806.00	19247.00

EUT Mode	Channel Bandwidth	Channel	RB Configure		99% Occupy bandwidth (KHz)	-26dB bandwidth (KHz)
			RB Size	RB Offset		
LTE Band 4	1.4MHz	Low range	6	0	1101.80	1341.00
		Mid range	6	0	1090.90	1293.00
		High range	6	0	1099.60	1308.00
	3MHz	Low range	15	0	2690.00	2947.00
		Mid range	15	0	2679.80	2934.00
		High range	15	0	2678.80	2950.00
	5MHz	Low range	25	0	4510.90	5054.00
		Mid range	25	0	4524.60	4935.00
		High range	25	0	4556.30	4996.00
	10MHz	Low range	50	0	8944.40	9843.00
		Mid range	50	0	8940.80	10017.00
		High range	50	0	8968.20	9942.00
	15MHz	Low range	75	0	13387.80	14789.00
		Mid range	75	0	13410.30	14894.00
		High range	75	0	13357.30	14629.00
	20MHz	Low range	100	0	17815.60	19034.00
		Mid range	100	0	17863.70	19326.00
		High range	100	0	17798.40	19213.00

EUT Mode	Channel Bandwidth	Channel	RB Configure		99% Occupy bandwidth (KHz)	-26dB bandwidth (KHz)
			RB Size	RB Offset		
LTE Band 12	1.4MHz	Low range	6	0	1095.40	1288.00
		Mid range	6	0	1102.40	1311.00
		High range	6	0	1094.70	1282.00
	3MHz	Low range	15	0	2678.20	2923.00
		Mid range	15	0	2692.80	2955.00
		High range	15	0	2682.50	2905.00
	5MHz	Low range	25	0	4508.40	5103.00
		Mid range	25	0	4526.90	5174.00
		High range	25	0	4516.70	5108.00
	10MHz	Low range	50	0	8941.70	9894.00
		Mid range	50	0	8965.20	9952.00
		High range	50	0	8967.50	9948.00

Test plot as follows:

QPSK mode:

Test band: LTE Band 2	Channel Bandwidth: 1.4MHz
-----------------------	---------------------------

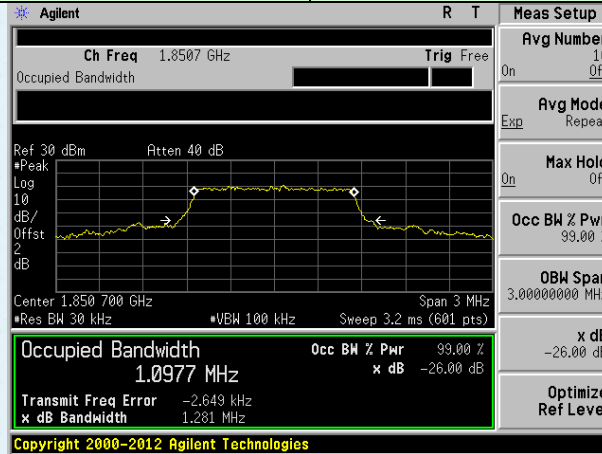

Lowest channel

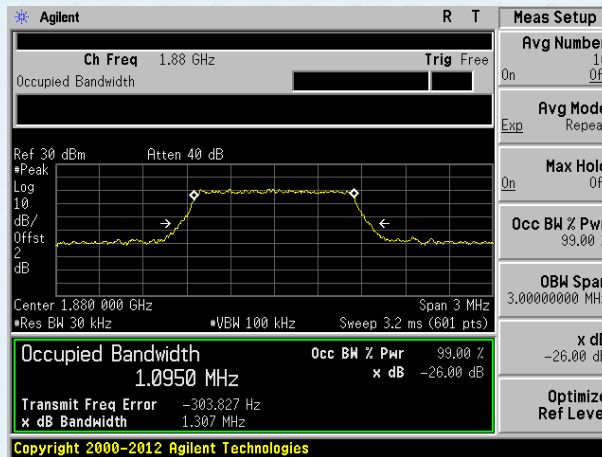

Middle channel

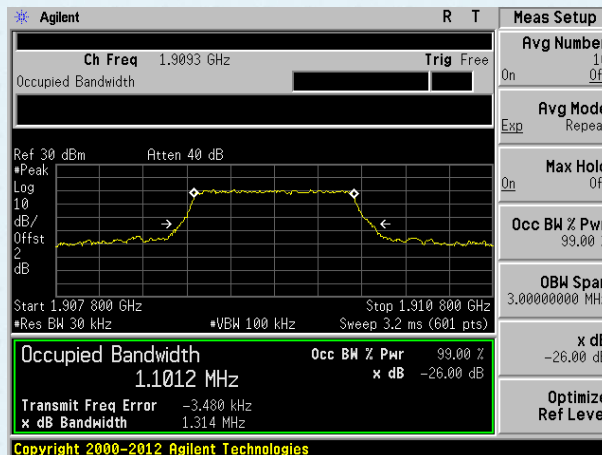

Highest channel

Test band: LTE Band 2 Channel Bandwidth: 3MHz

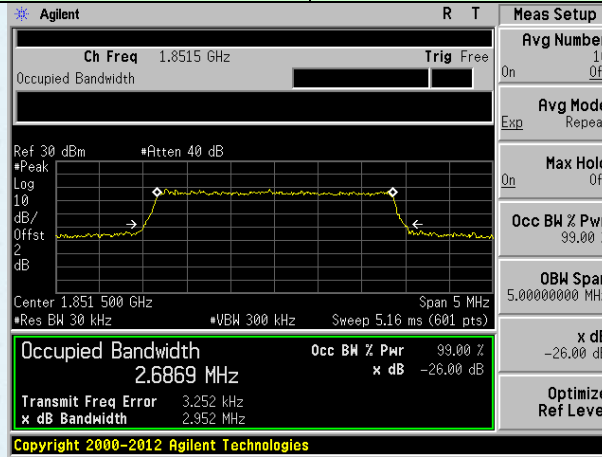

Lowest channel

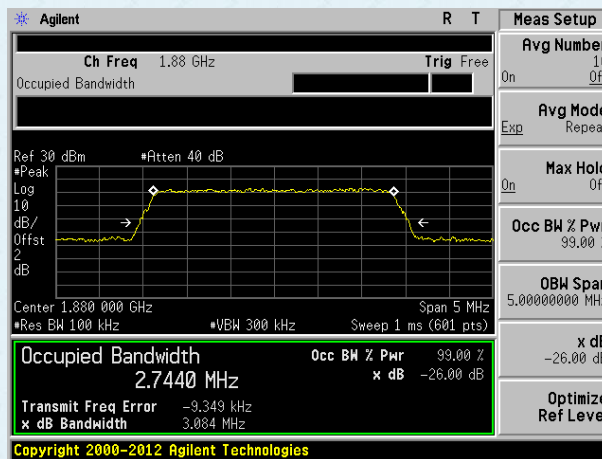

Middle channel

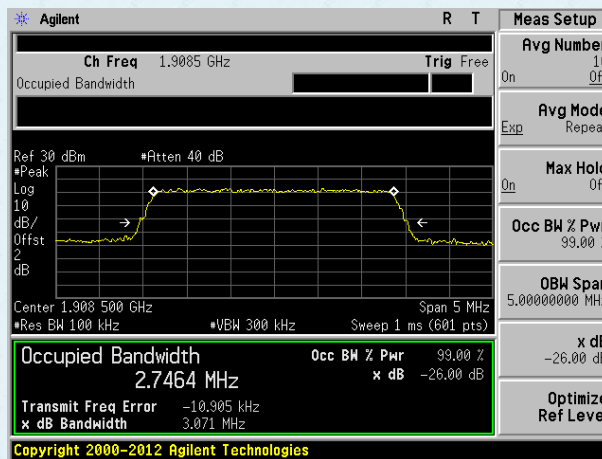

Highest channel

Test band: LTE Band 2 Channel Bandwidth: 5MHz

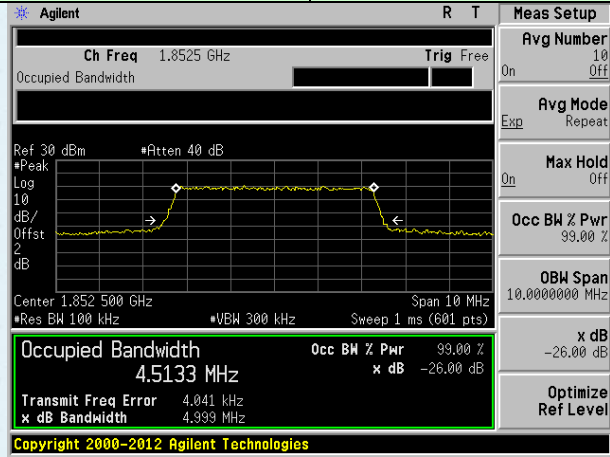

Lowest channel

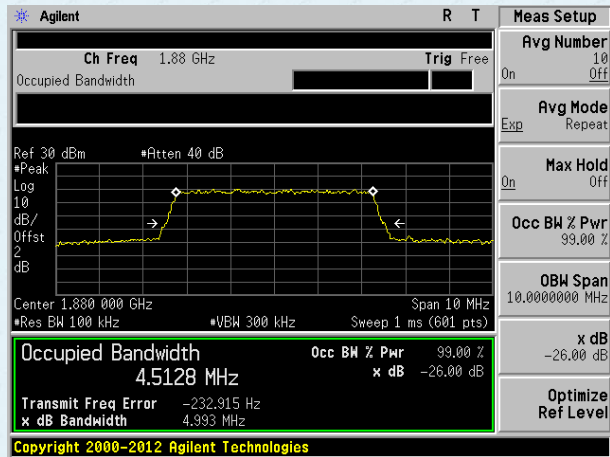

Middle channel

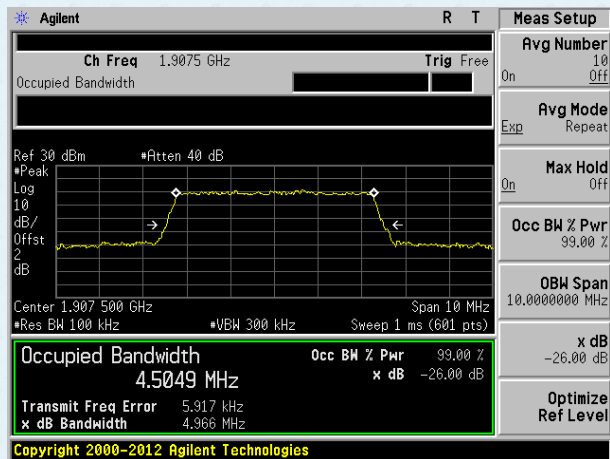

Highest channel

Test band: LTE Band 2 Channel Bandwidth: 10MHz

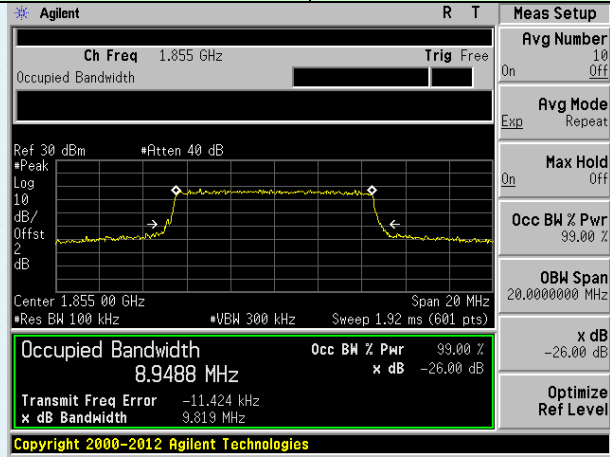

Lowest channel

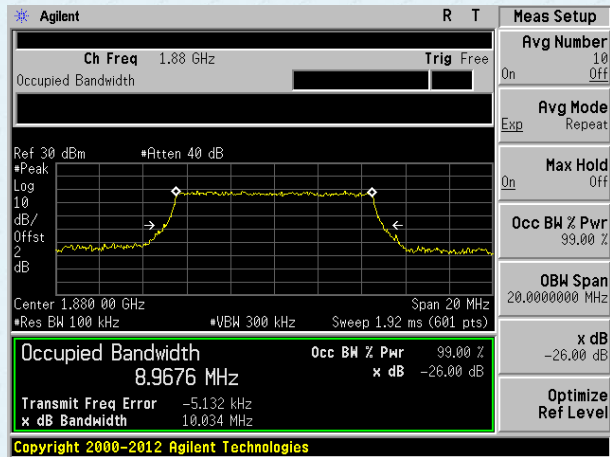

Middle channel

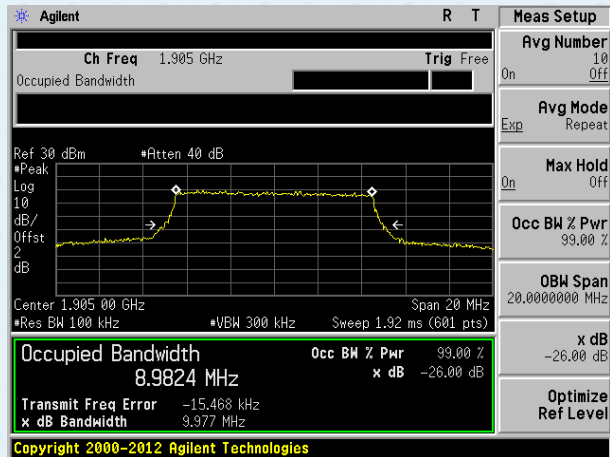

Highest channel

Test band: LTE Band 2 Channel Bandwidth: 15MHz

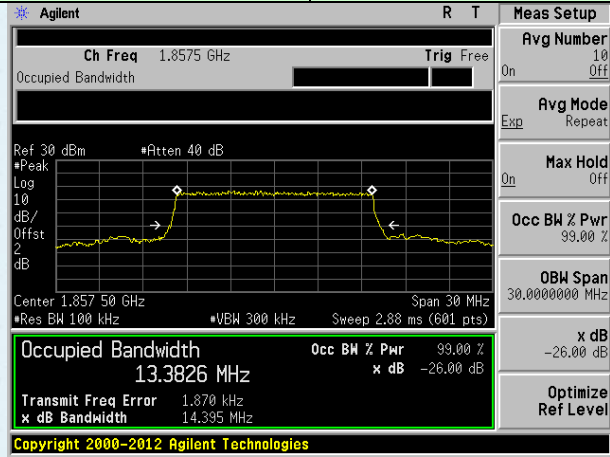

Lowest channel

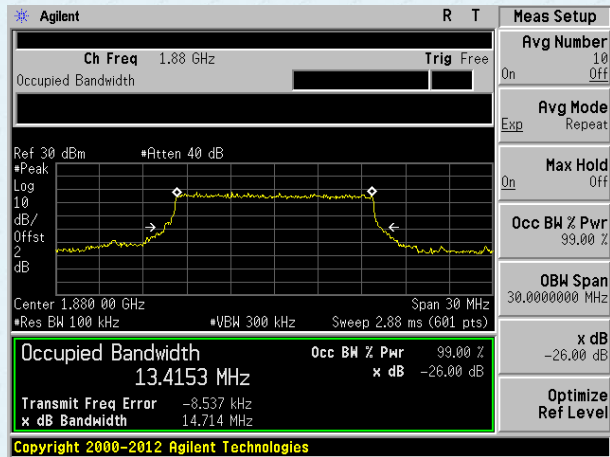

Middle channel

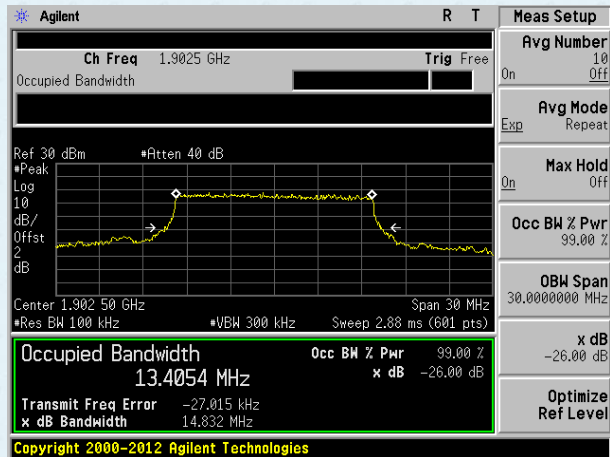

Highest channel

Test band: LTE Band 2 Channel Bandwidth:20MHz

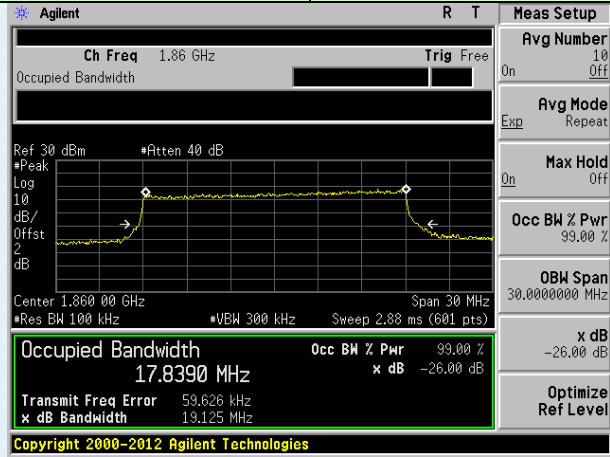

Lowest channel

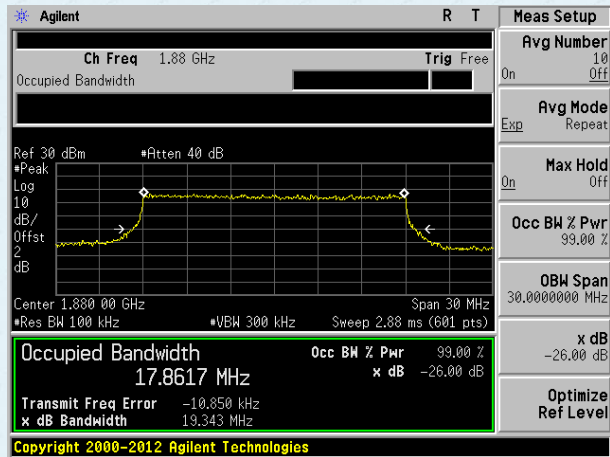

Middle channel

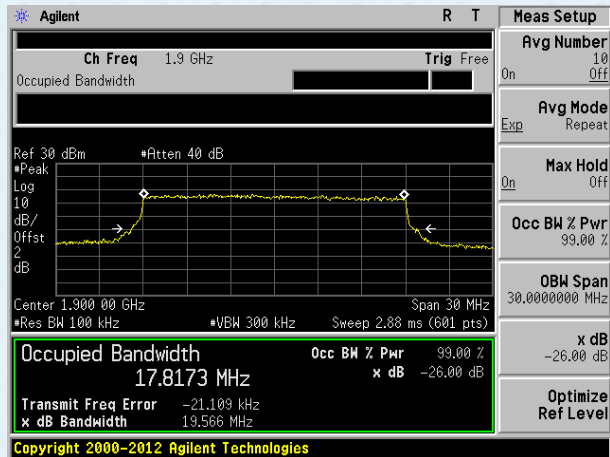

Highest channel

Test band: LTE Band 4 Channel Bandwidth: 1.4MHz

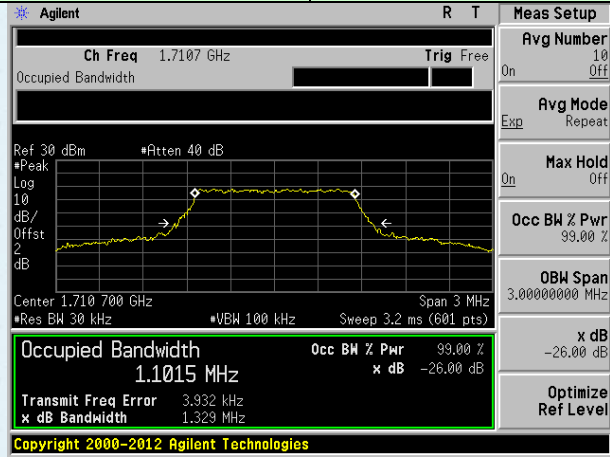

Lowest channel

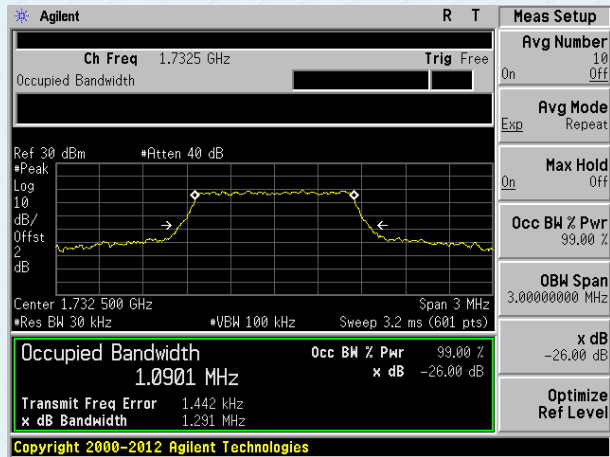

Middle channel

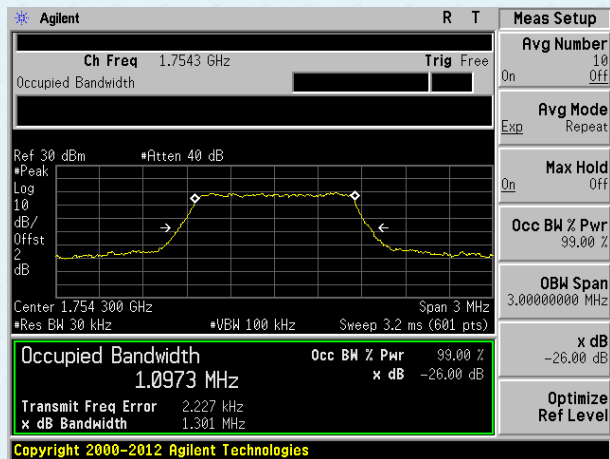

Highest channel

Test band: LTE Band 4 Channel Bandwidth: 3MHz

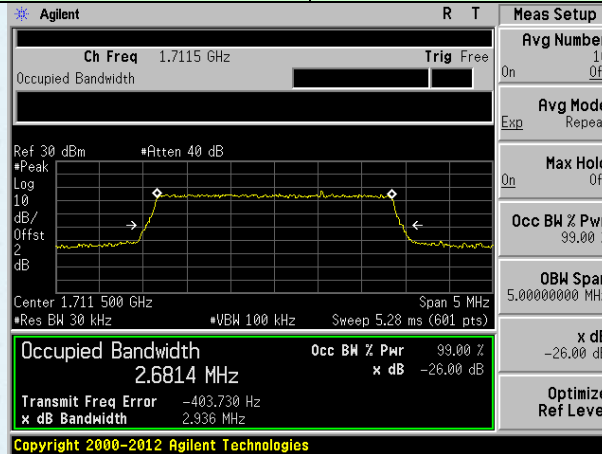

Lowest channel

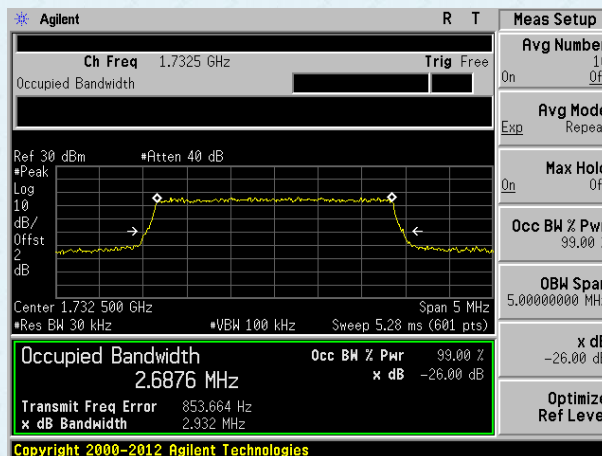

Middle channel

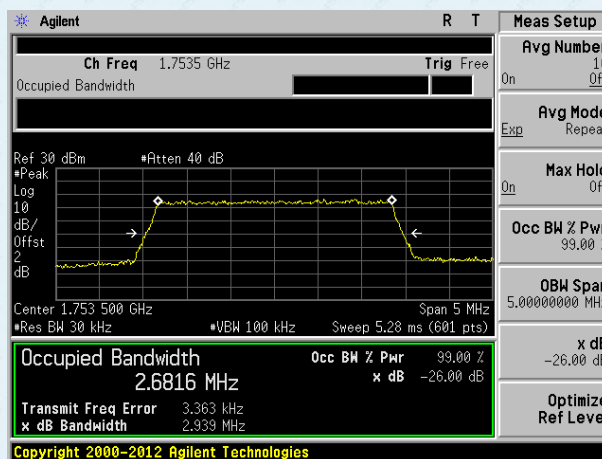

Highest channel

Test band: LTE Band 4 Channel Bandwidth: 5MHz

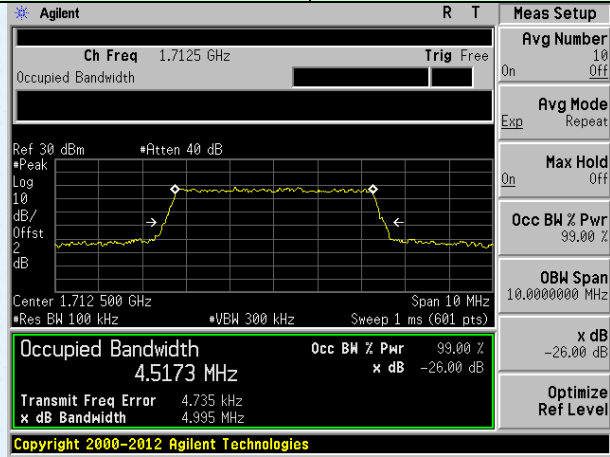

Lowest channel

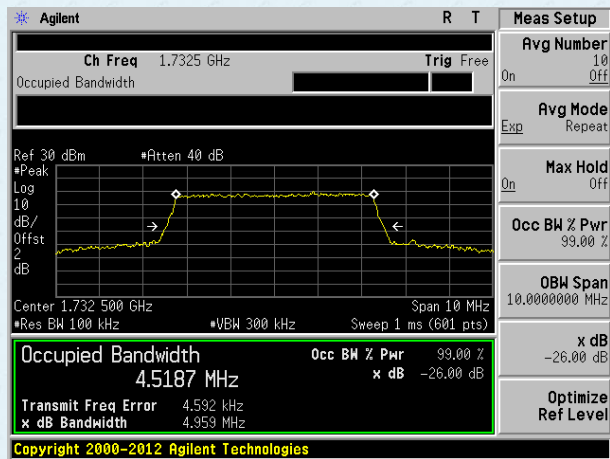

Middle channel

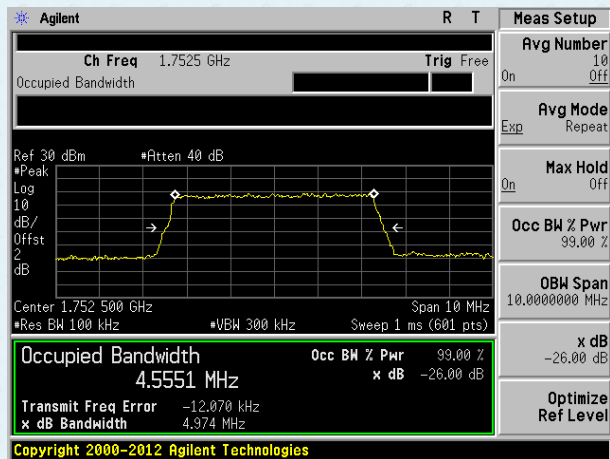

Highest channel

Test band: LTE Band 4 Channel Bandwidth: 10MHz

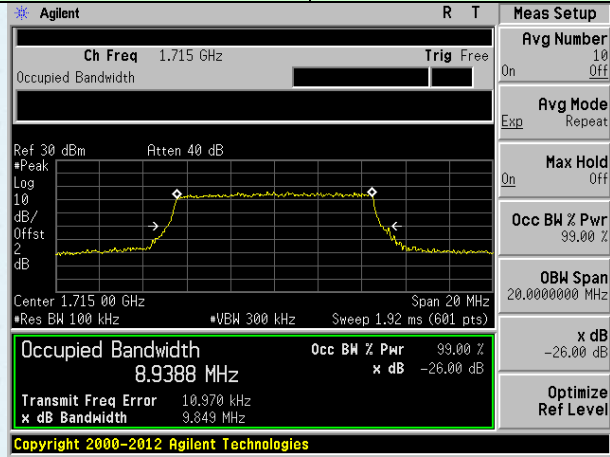

Lowest channel

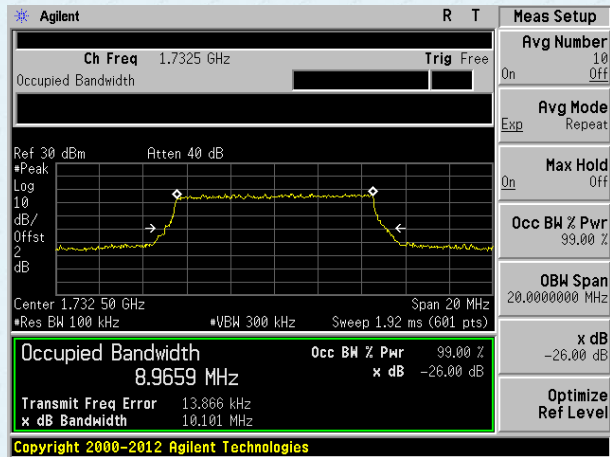

Middle channel

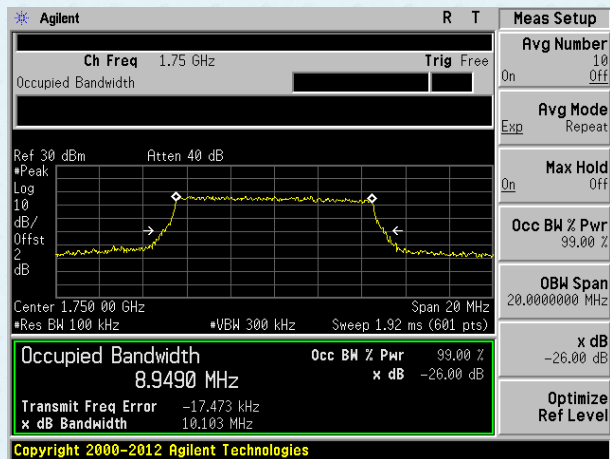

Highest channel

Test band: LTE Band 4 Channel Bandwidth: 15MHz

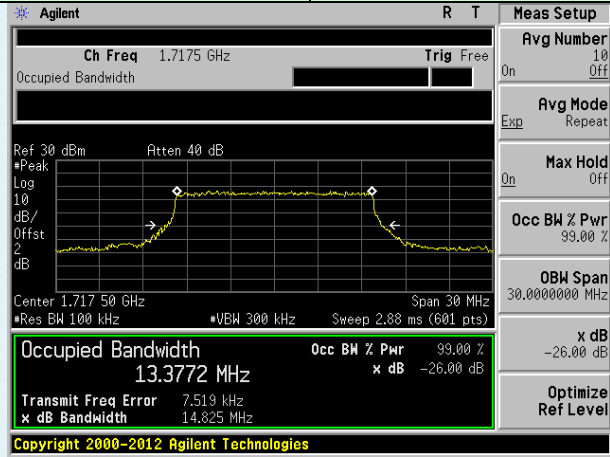

Lowest channel

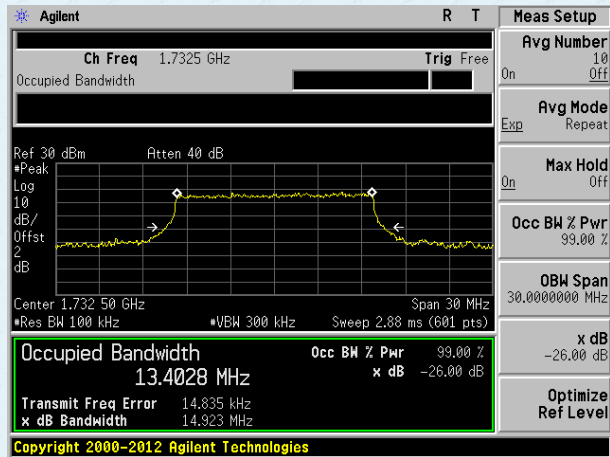

Middle channel

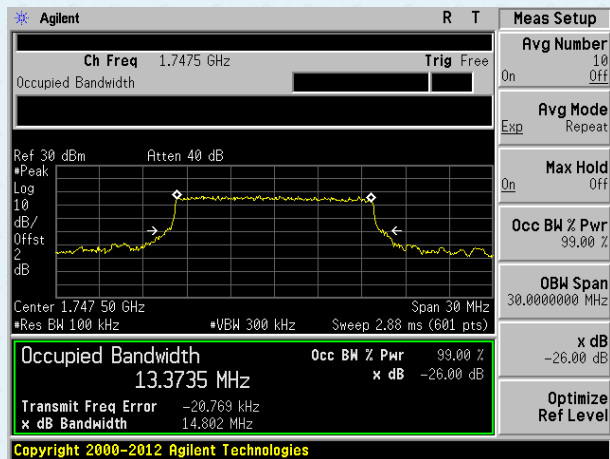

Highest channel

Test band: LTE Band 4 Channel Bandwidth: 20MHz

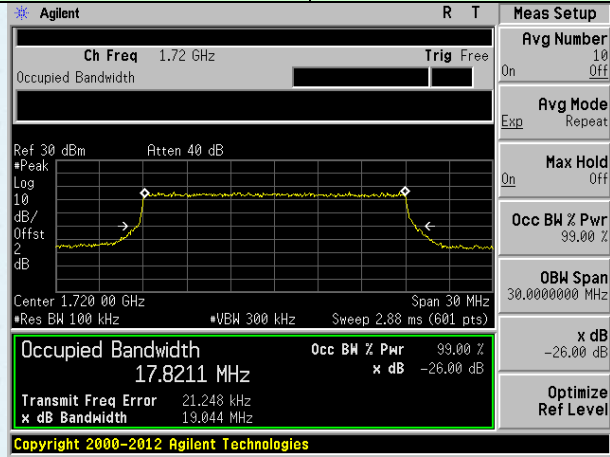

Lowest channel

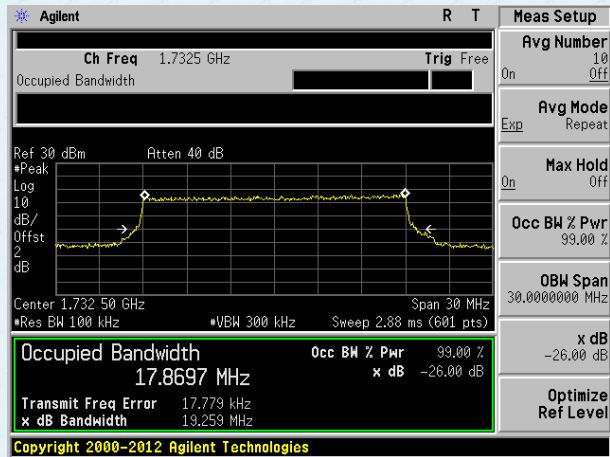

Middle channel

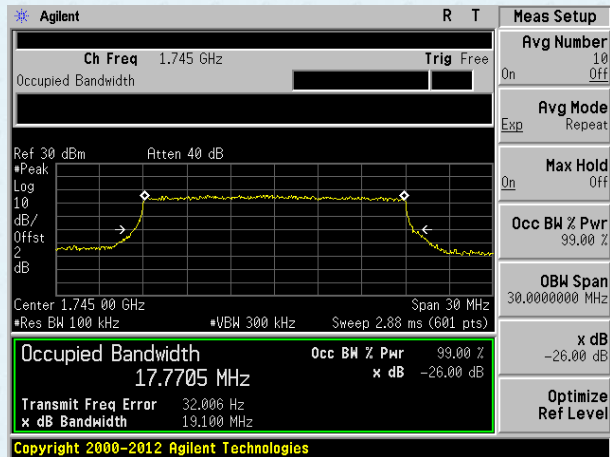

Highest channel

Test band: LTE Band 12 Channel Bandwidth: 1.4MHz

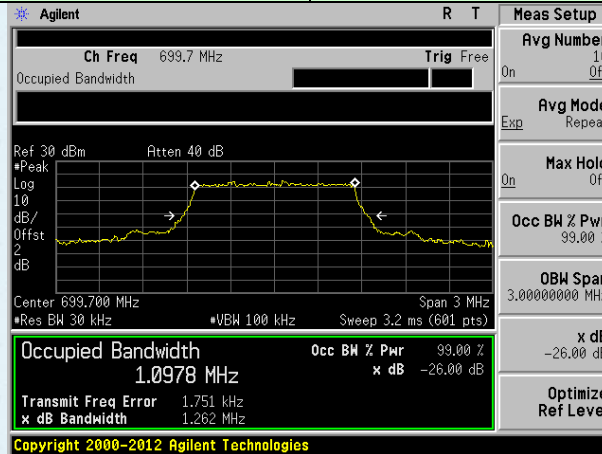

Lowest channel

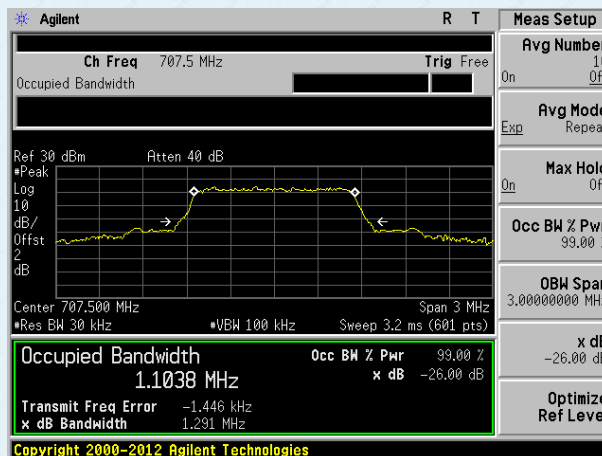

Middle channel

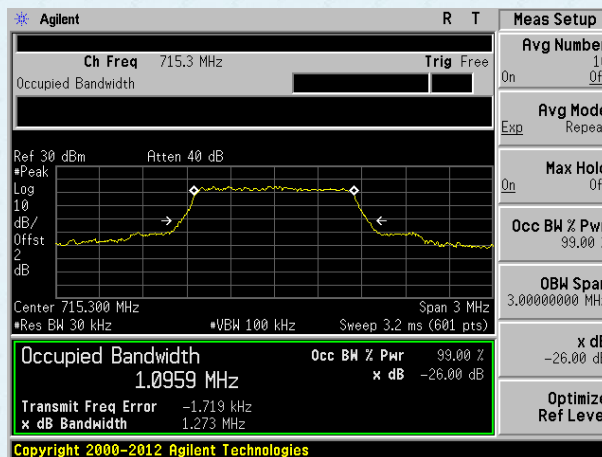

Highest channel

Test band: LTE Band 12 Channel Bandwidth: 3MHz

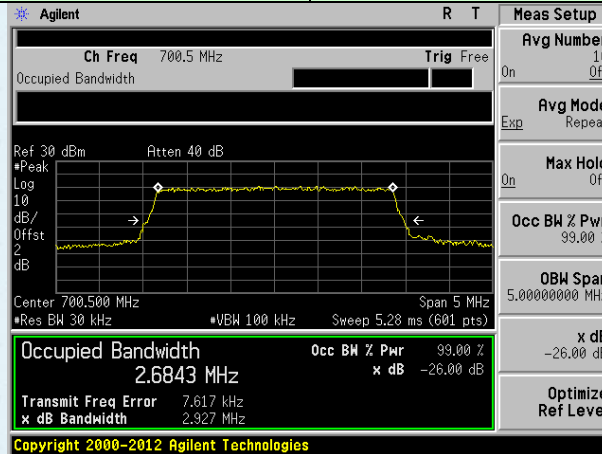

Lowest channel

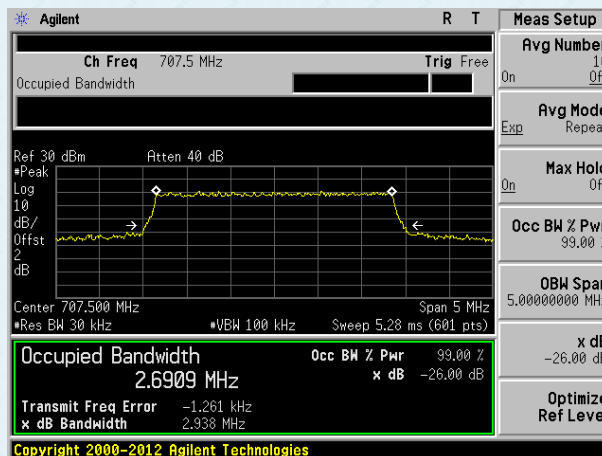

Middle channel

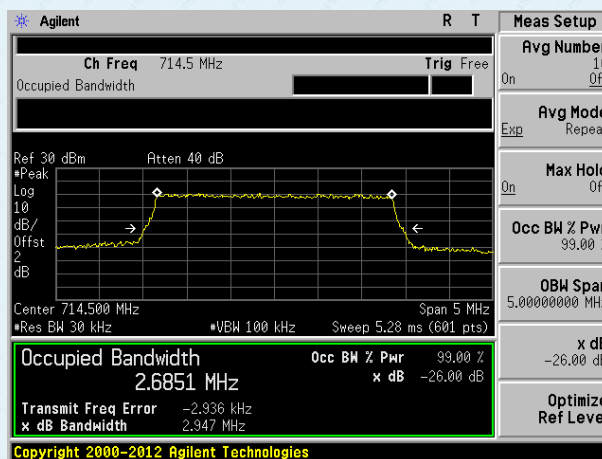

Highest channel

Test band: LTE Band 12 Channel Bandwidth: 5MHz

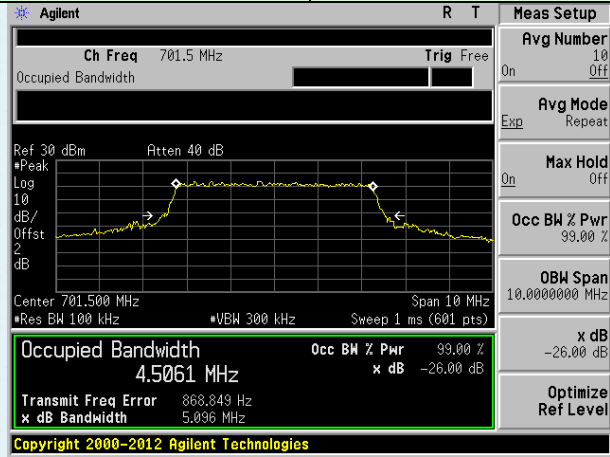

Lowest channel

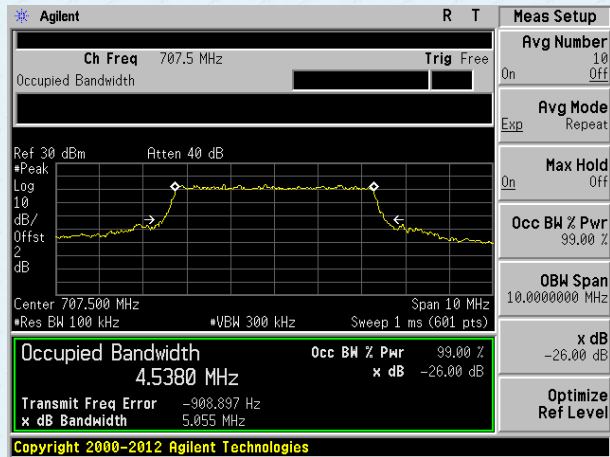

Middle channel

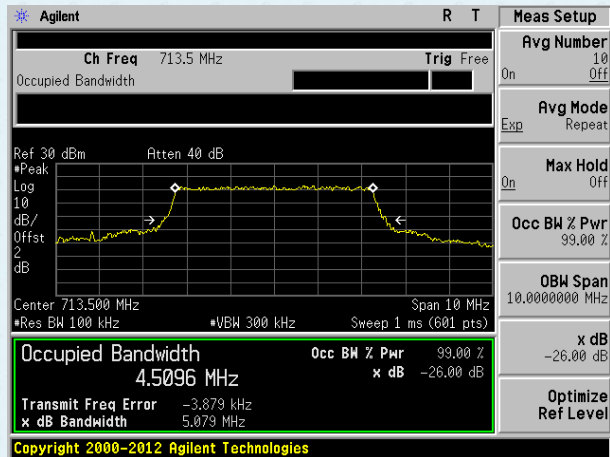

Highest channel

Test band: LTE Band 12 Channel Bandwidth: 10MHz

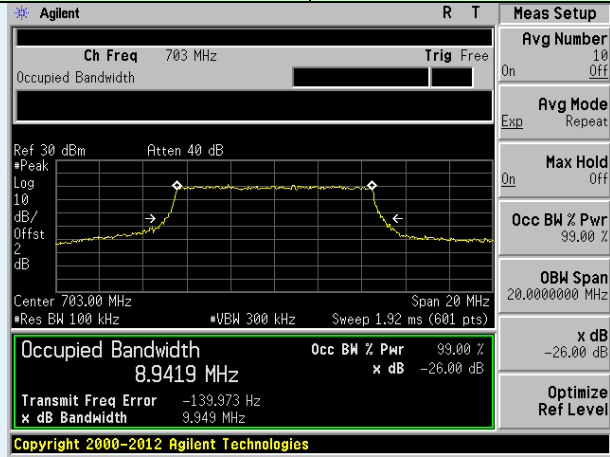

Lowest channel

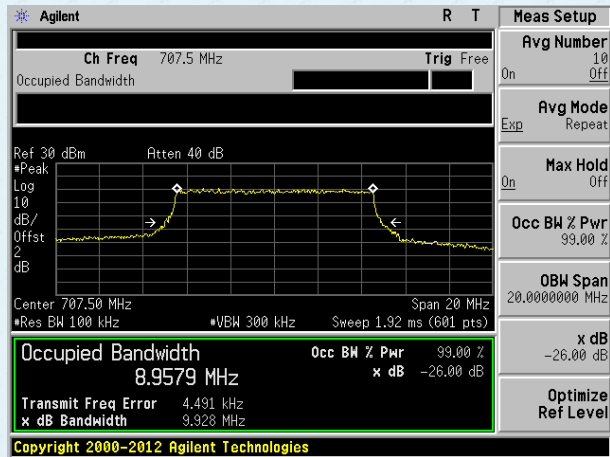

Middle channel

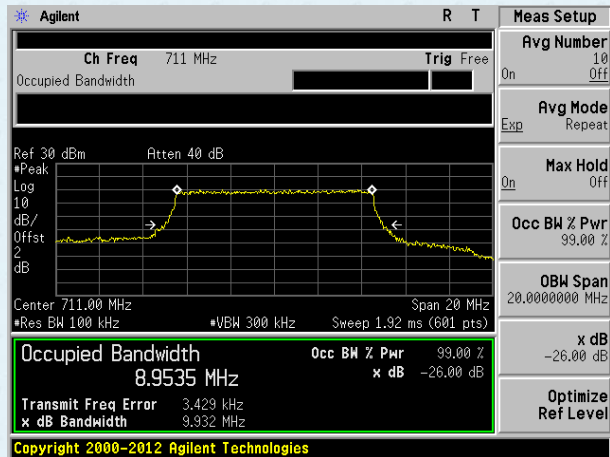

Highest channel

16QAM mode:

Test band: LTE Band 2	Channel Bandwidth: 1.4MHz
-----------------------	---------------------------

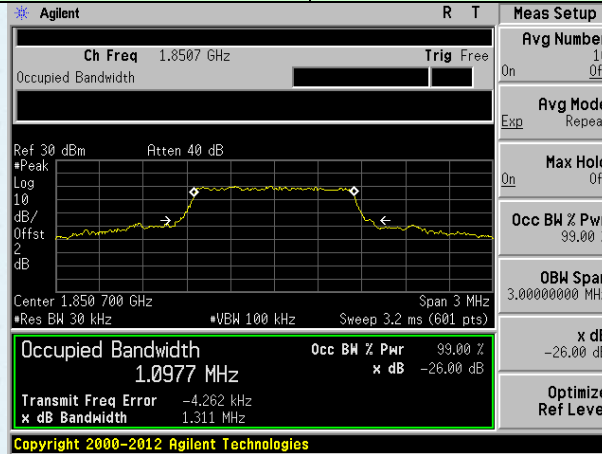

Lowest channel

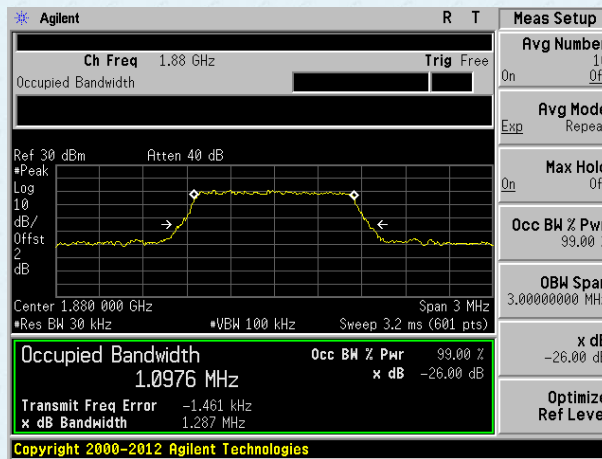

Middle channel

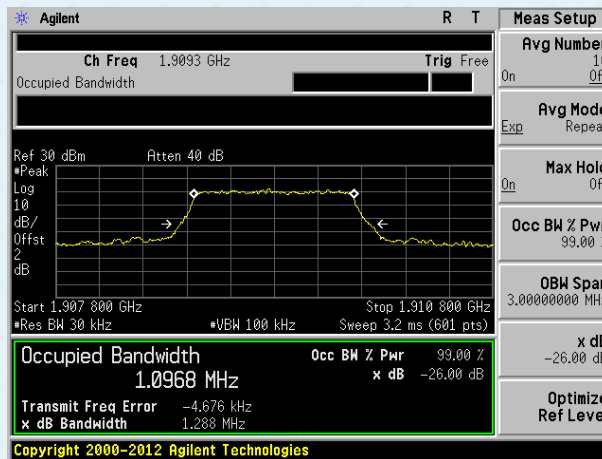

Highest channel

Test band: LTE Band 2 Channel Bandwidth: 3MHz

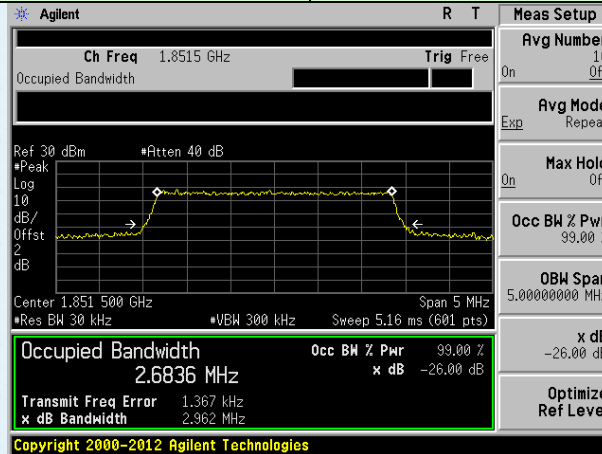

Lowest channel

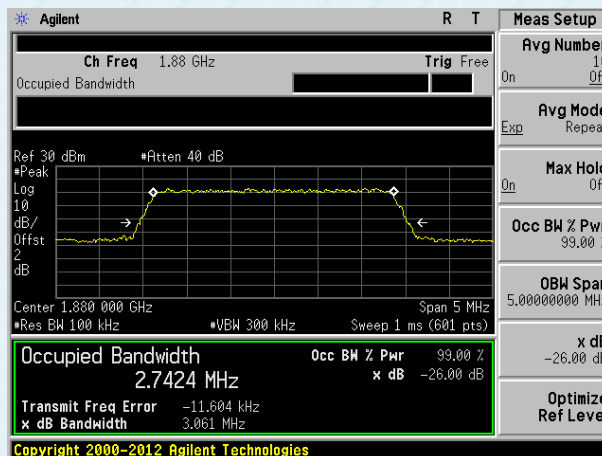

Middle channel

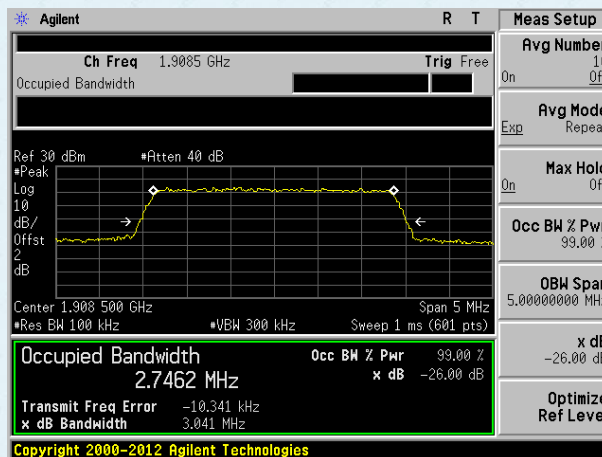

Highest channel

Test band: LTE Band 2 Channel Bandwidth: 5MHz

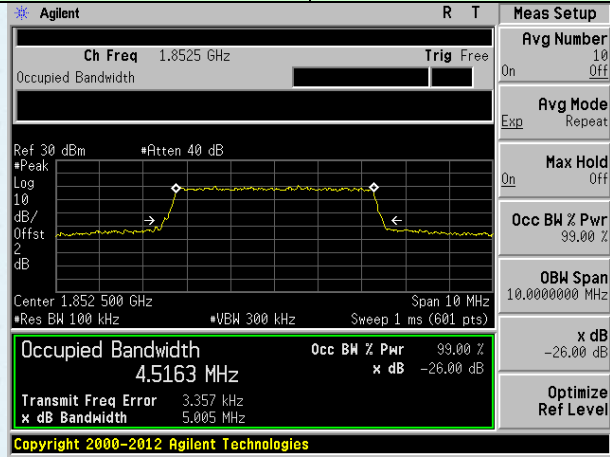

Lowest channel

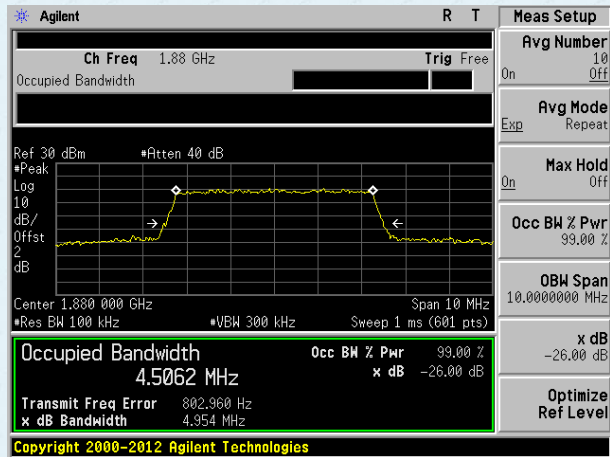

Middle channel

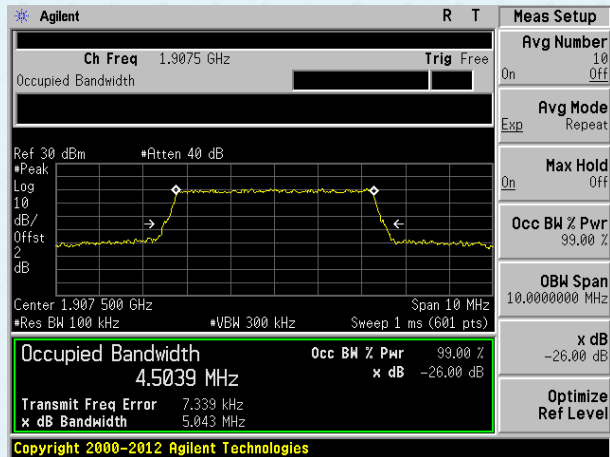

Highest channel

Test band: LTE Band 2 Channel Bandwidth: 10MHz

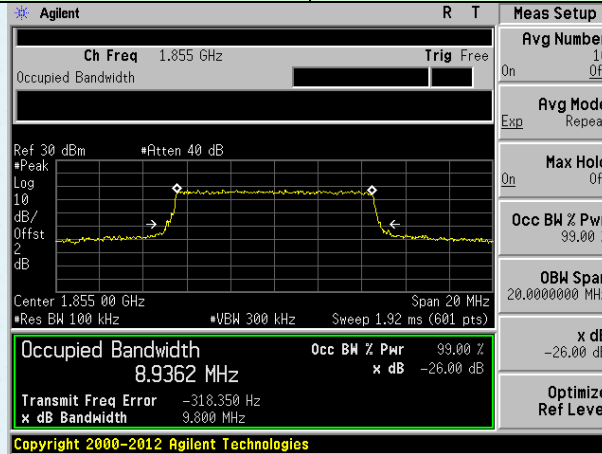

Lowest channel

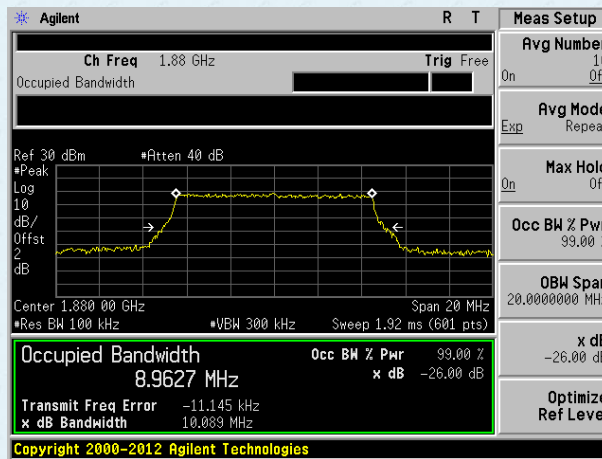

Middle channel

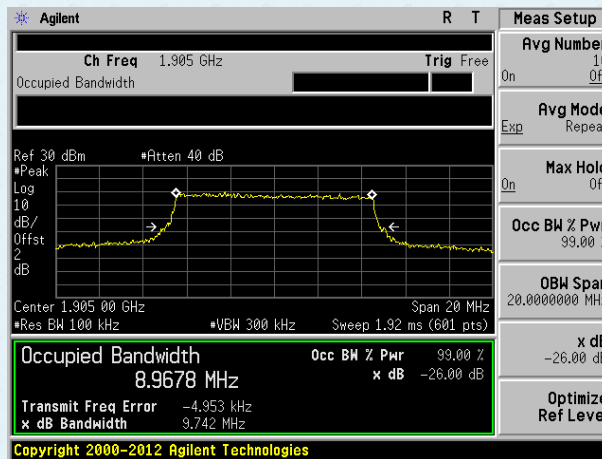

Highest channel

Test band: LTE Band 2 Channel Bandwidth: 15MHz

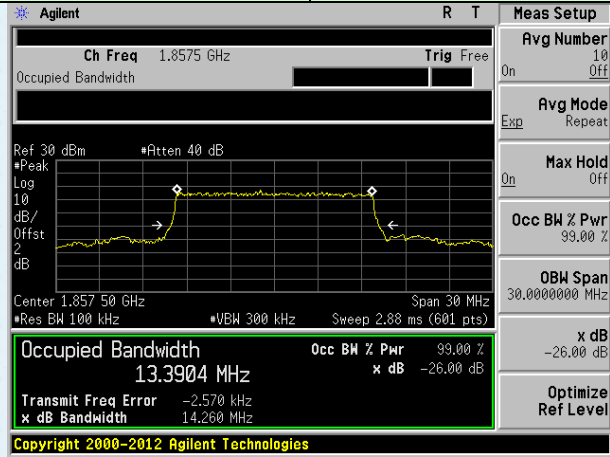

Lowest channel

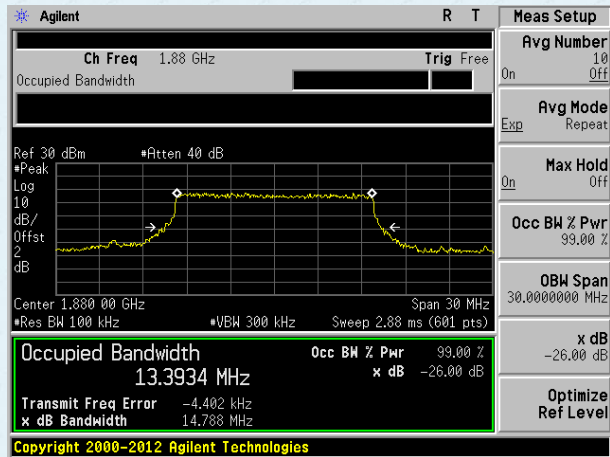

Middle channel

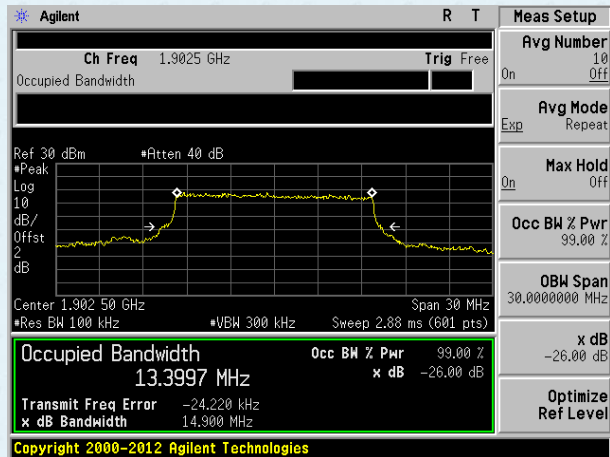

Highest channel

Test band: LTE Band 2 Channel Bandwidth: 20MHz

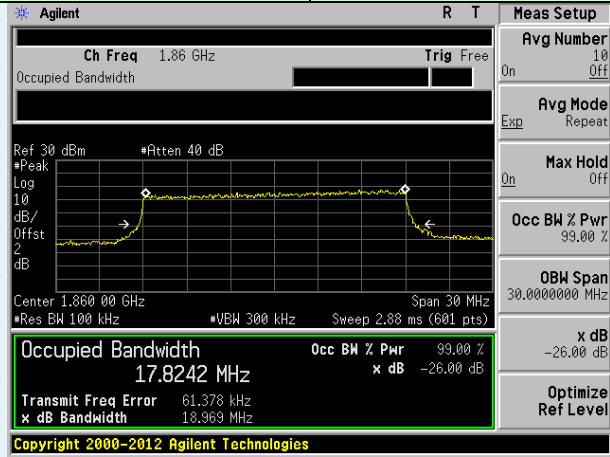

Lowest channel

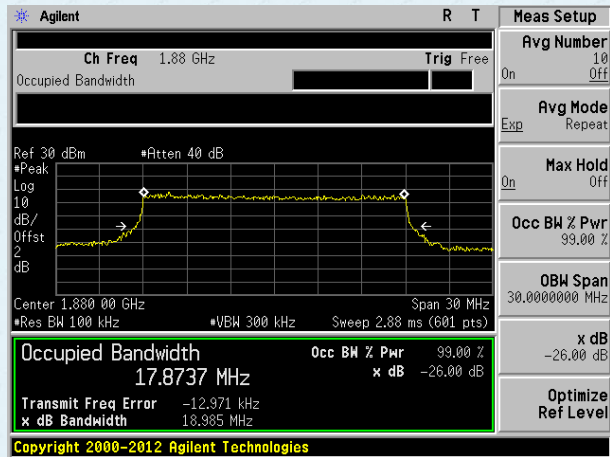

Middle channel

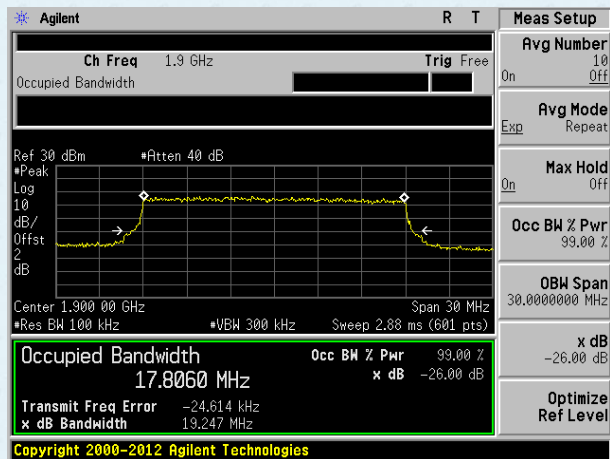

Highest channel

Test band: LTE Band 4 Channel Bandwidth: 1.4MHz

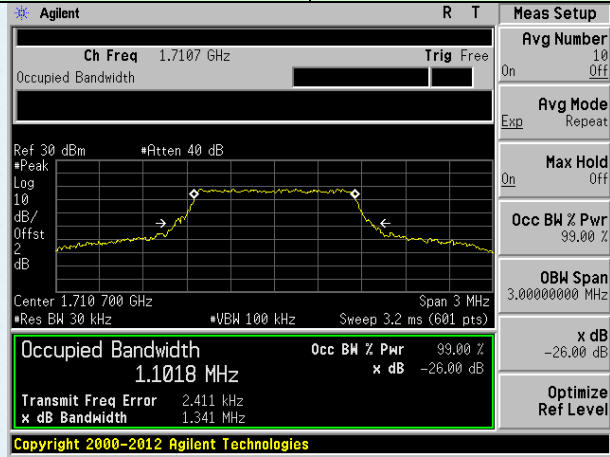

Lowest channel

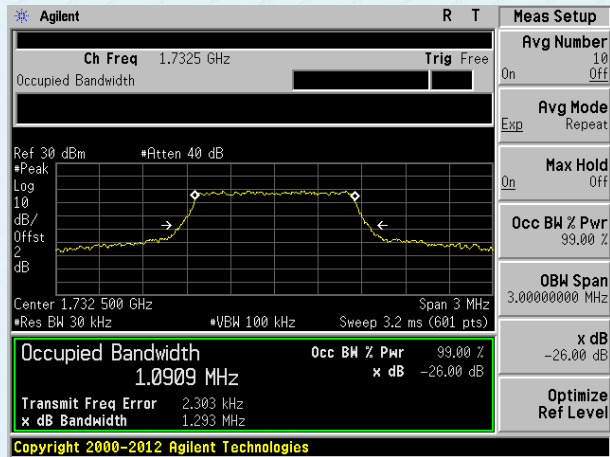

Middle channel

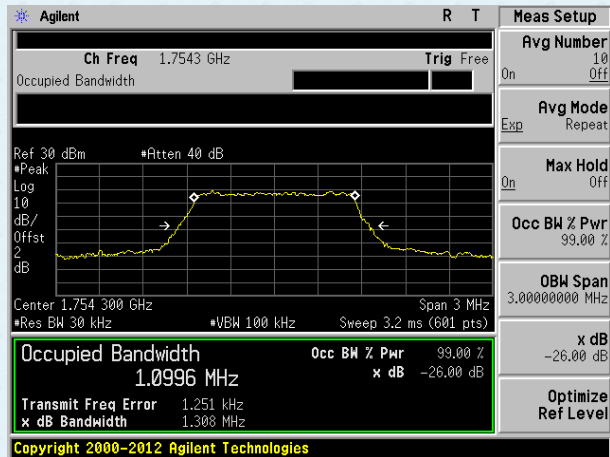

Highest channel

Test band: LTE Band 4 Channel Bandwidth: 3MHz

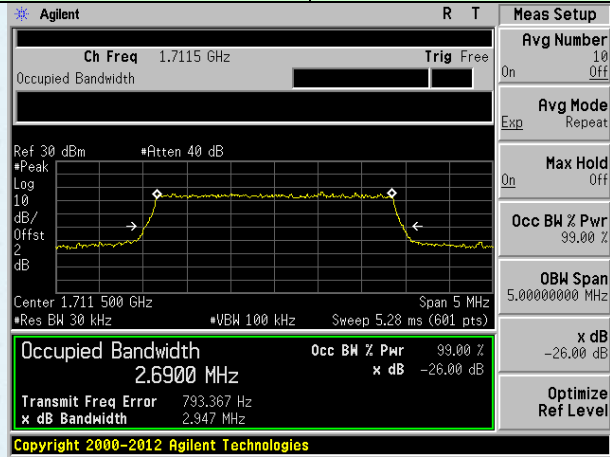

Lowest channel

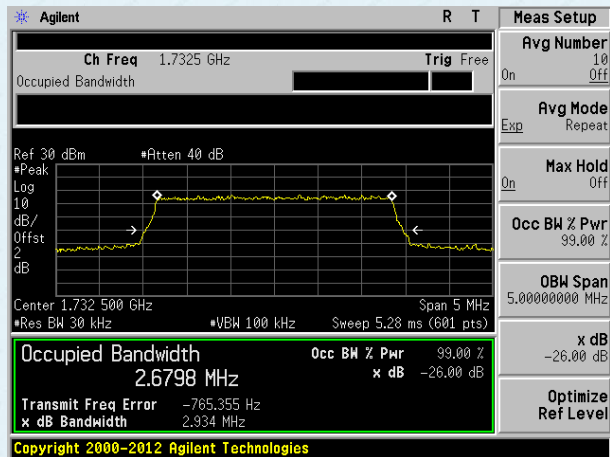

Middle channel

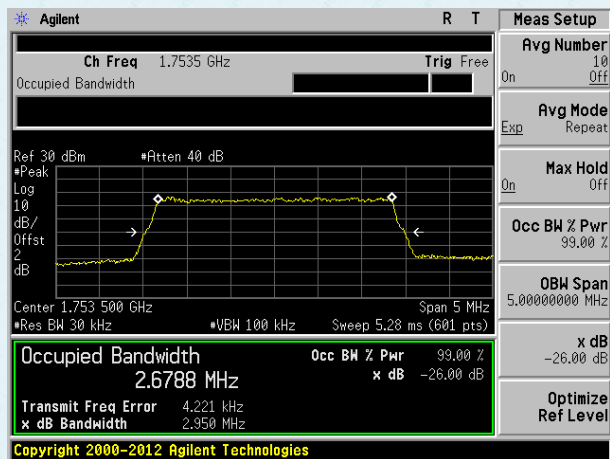

Highest channel

Test band: LTE Band 4 Channel Bandwidth: 5MHz

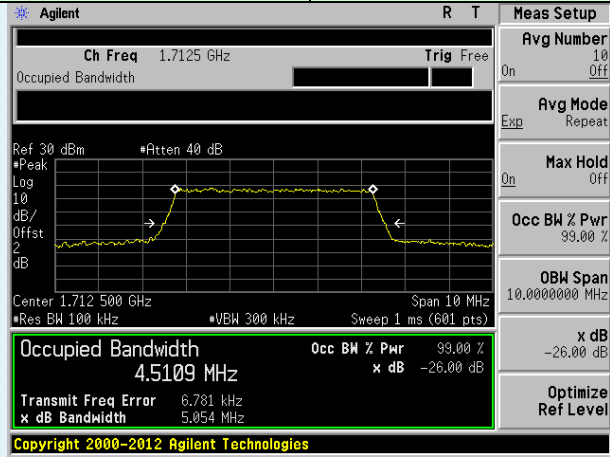

Lowest channel

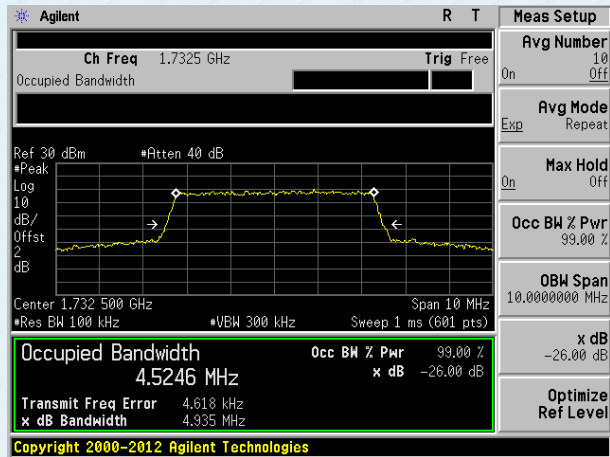

Middle channel

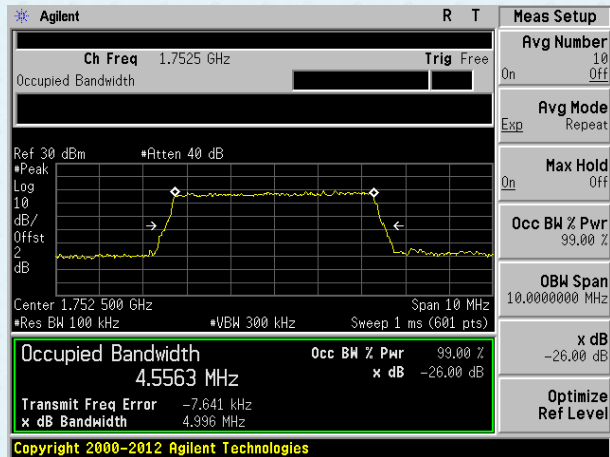

Highest channel

Test band: LTE Band 4 Channel Bandwidth: 10MHz

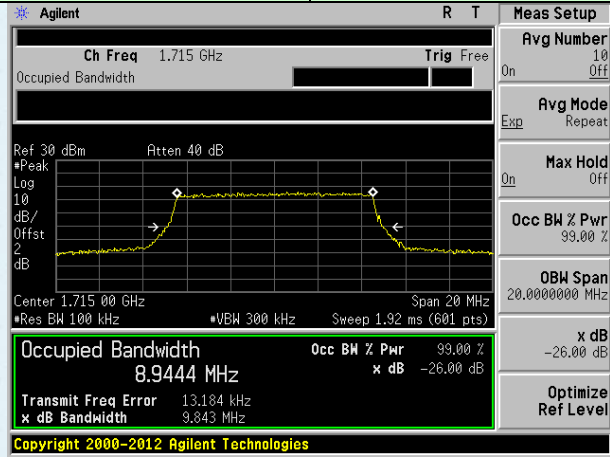

Lowest channel

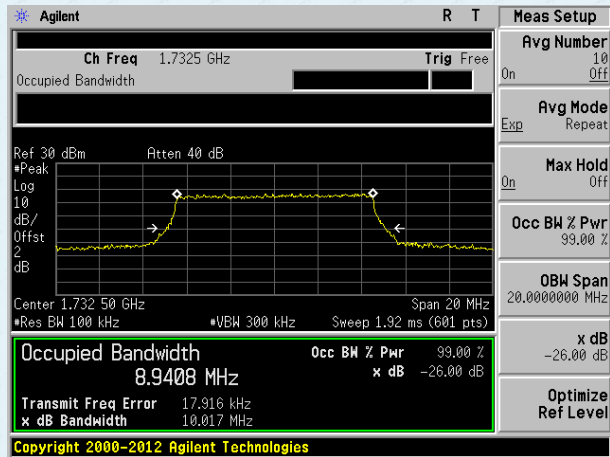

Middle channel

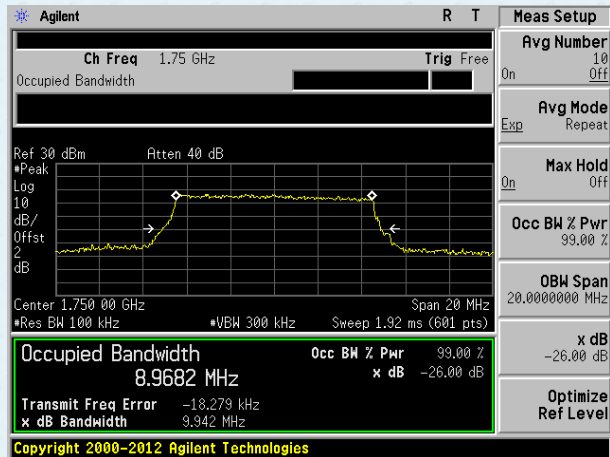

Highest channel

Test band: LTE Band 4 Channel Bandwidth: 15MHz

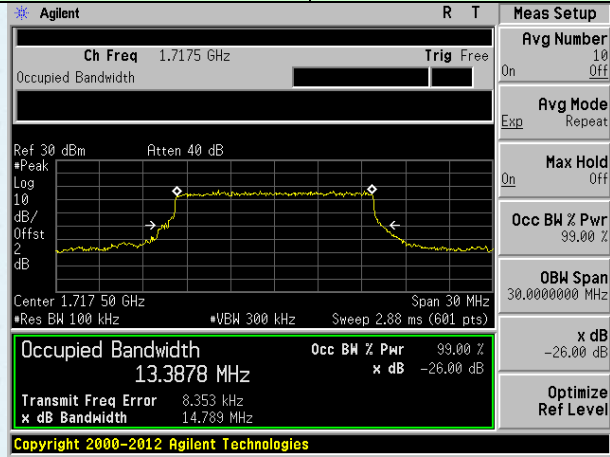

Lowest channel

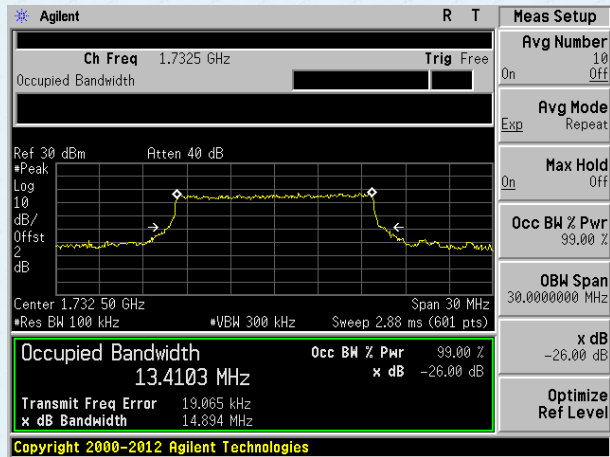

Middle channel

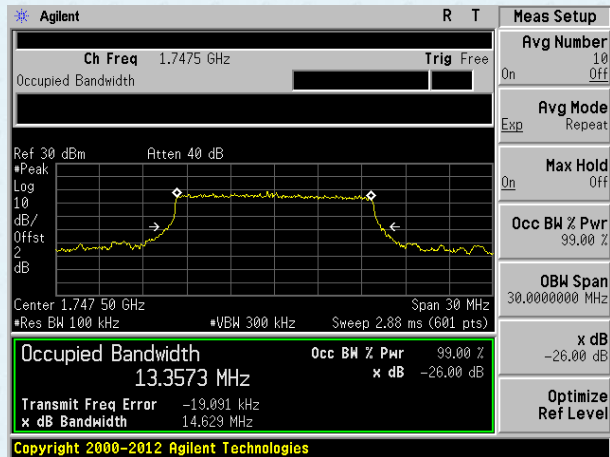

Highest channel

Test band: LTE Band 4 Channel Bandwidth: 20MHz

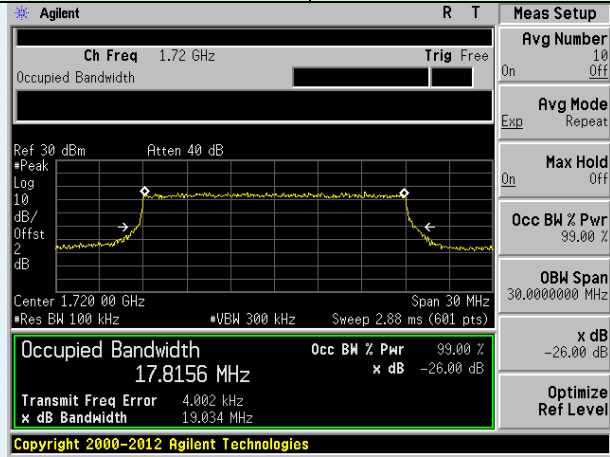

Lowest channel

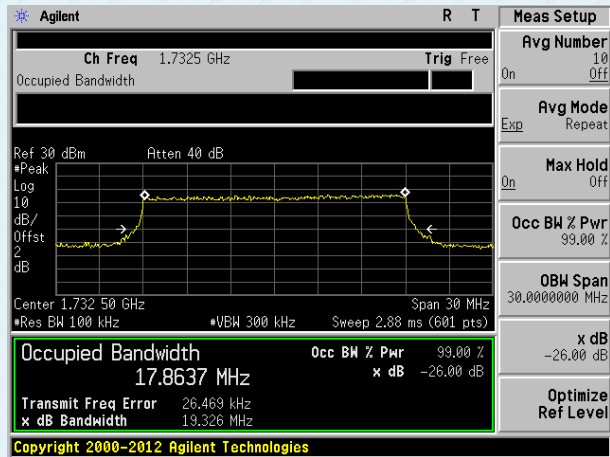

Middle channel

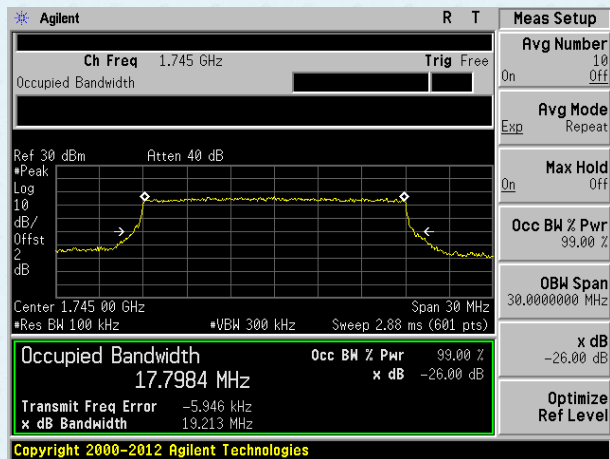

Highest channel

Test band: LTE Band 12 Channel Bandwidth: 1.4MHz

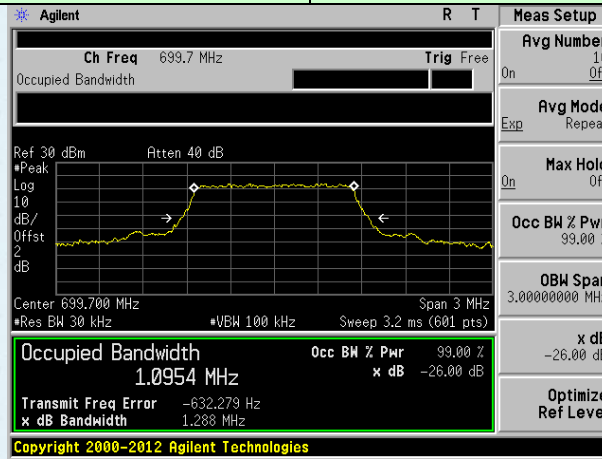

Lowest channel

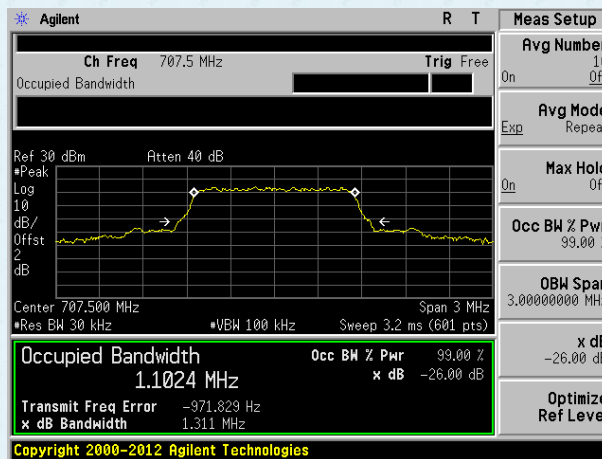

Middle channel

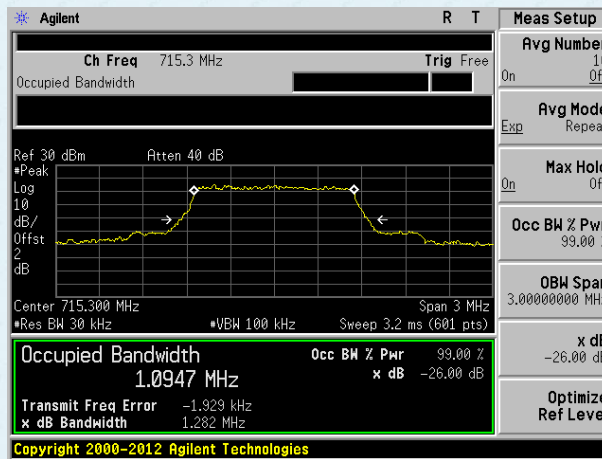

Highest channel

Test band: LTE Band 12 Channel Bandwidth: 3MHz

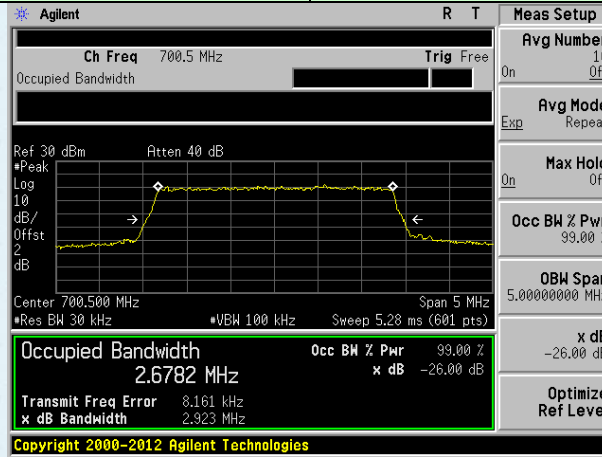

Lowest channel

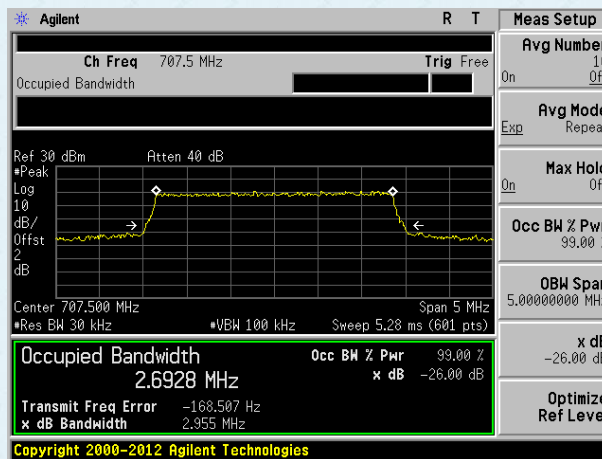

Middle channel

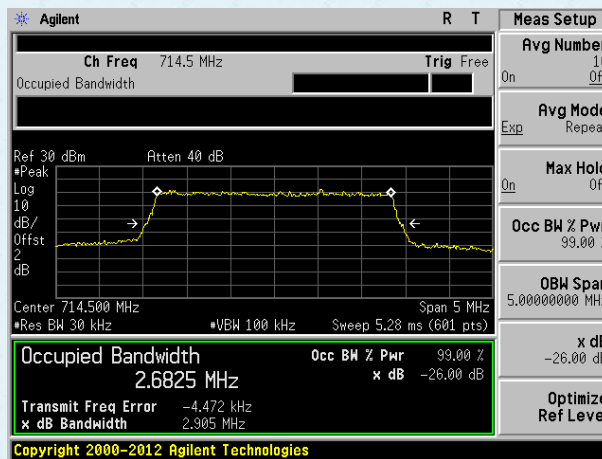

Highest channel

Test band: LTE Band 12 Channel Bandwidth: 5MHz

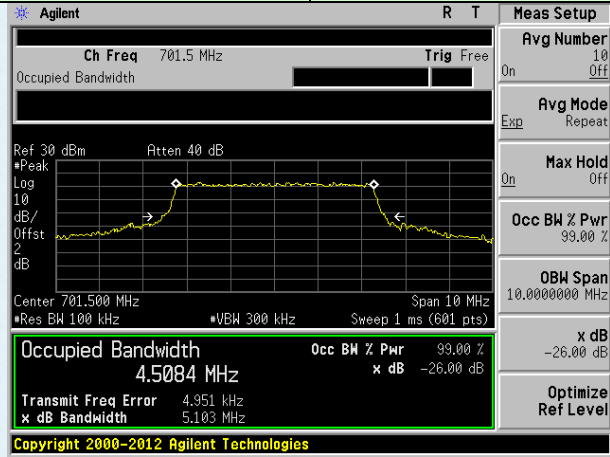

Lowest channel

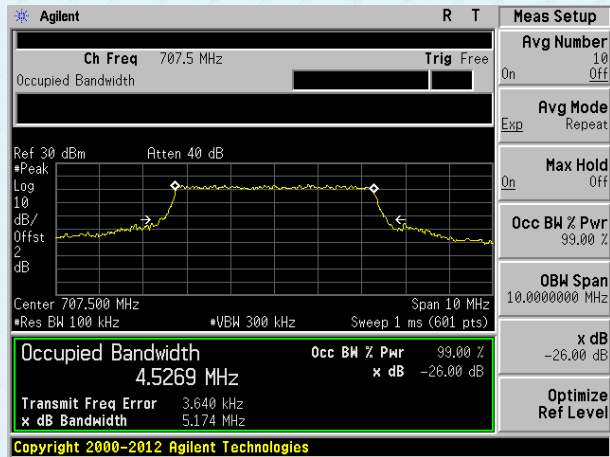

Middle channel

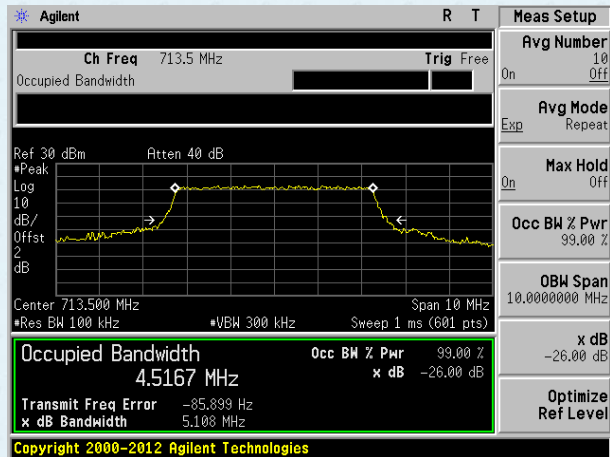

Highest channel

Test band: LTE Band 12 Channel Bandwidth: 10MHz

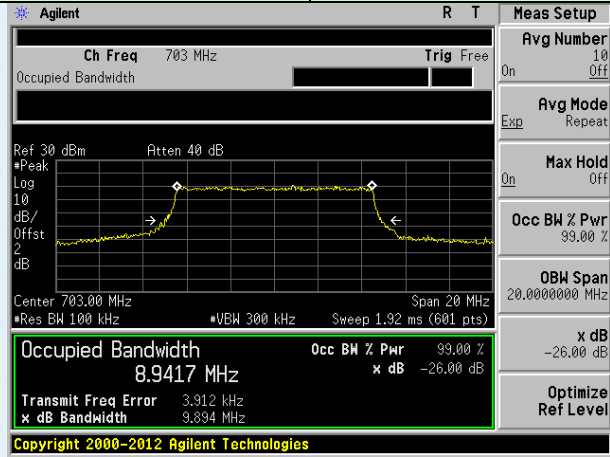

Lowest channel

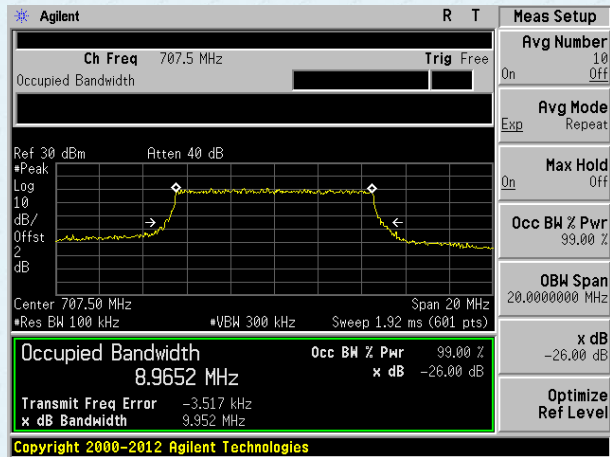

Middle channel

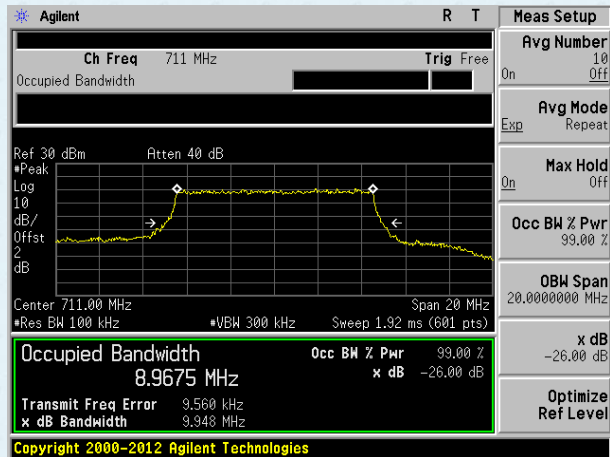

Highest channel

7.6 MODULATION CHARACTERISTIC

According to FCC § 2.1047(d), Part 27 there is no specific requirement for digital modulation, therefore modulation characteristic is not presented.

7.7 Out of band emission at antenna terminals

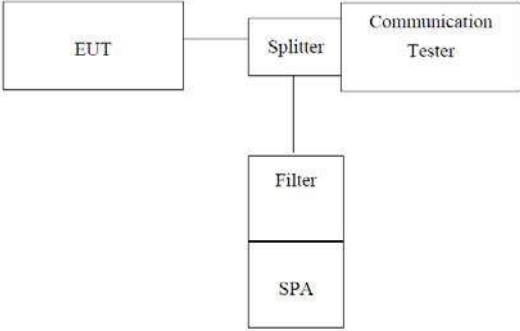
Test Requirement:	Part 24.238 (a); FCC Part 27.53(h)/(g)
Test Method:	FCC part2.1051
Limit:	-13dBm
Test setup:	 <p><i>Note: Measurement setup for testing on Antenna connector</i></p>
Test Procedure:	<ol style="list-style-type: none"> 1 The RF output of the transceiver was connected to a spectrum analyzer through appropriate attenuation. 2 The resolution bandwidth of the spectrum analyzer was set at 1MHz, sufficient scans were taken to show the out of band Emissions if any up to 10th harmonic. 3 For the out of band: Set the RBW, VBW = 1MHz, Start=30MHz, Stop= 10th harmonic. 4 Band Edge Requirements: In the 1 MHz bands immediately outside and adjacent to the frequency block, a resolution bandwidth of at least 1 percent of the emission bandwidth of the fundamental emission of the transmitter may be employed to measure the out of band Emissions.
Test Instruments:	Refer to section 6.0 for details
Test mode:	Refer to section 7.1 for details
Test results:	Pass

Remark: Both modulation modes have been tested, showing only the worst QPSK test data.

Test plot as follows:

Test Mode: LTE Band 2 Channel Bandwidth: 1.4MHz RB size: 6#, RB offset: 0#

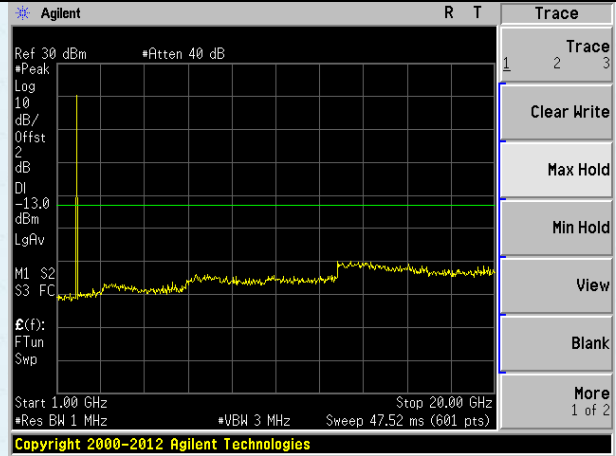
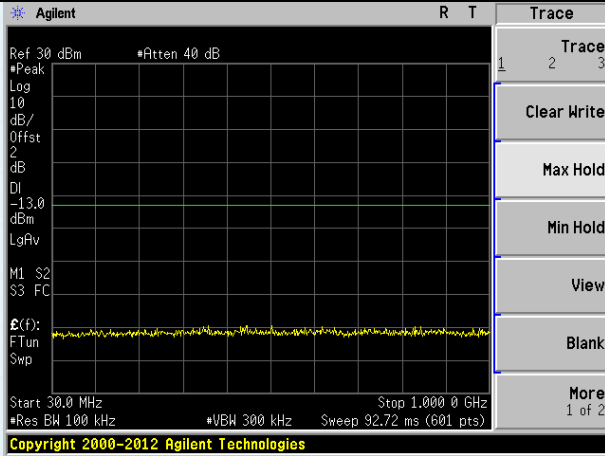

Lowest channel

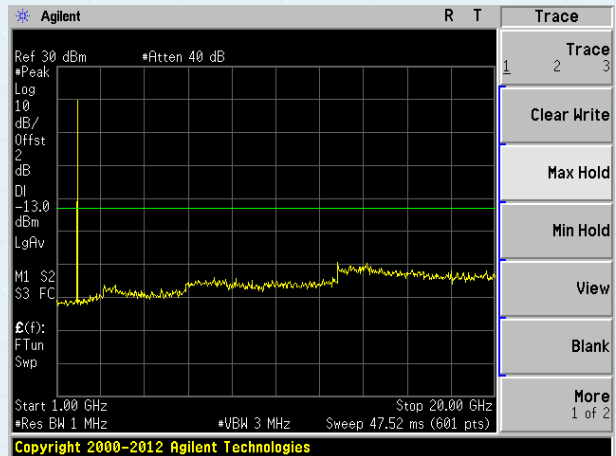
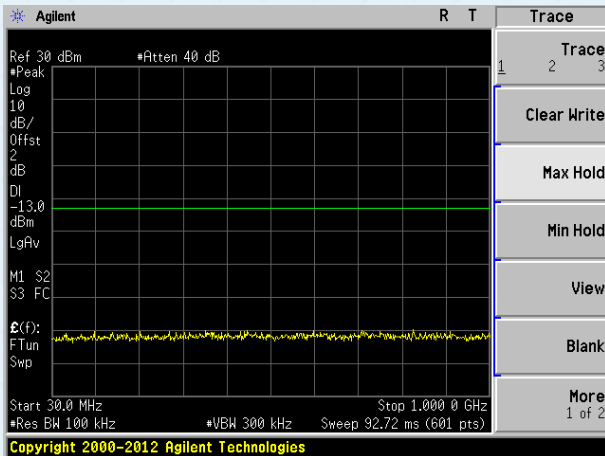

Middle channel

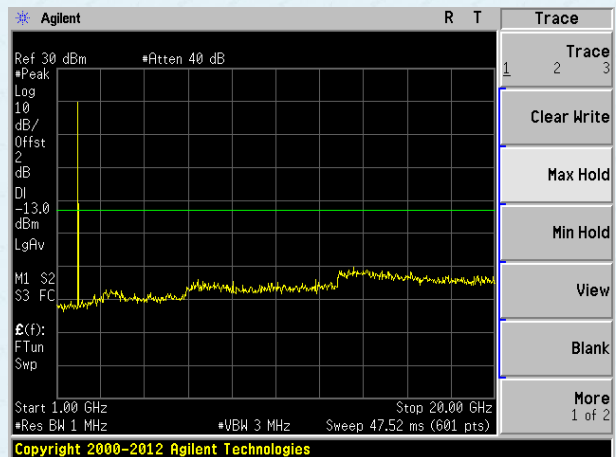
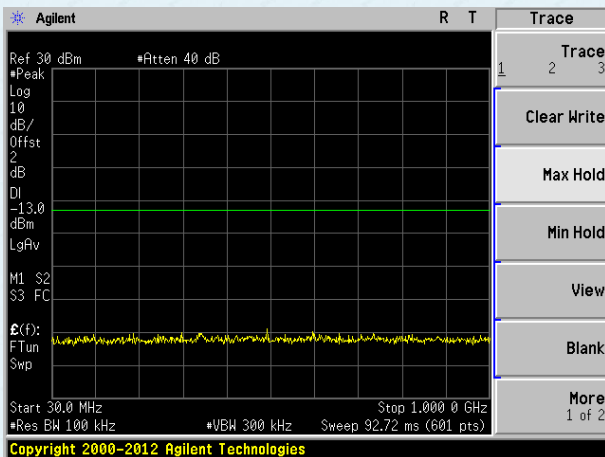

Highest channel

Test Mode: LTE Band 2 Channel Bandwidth: 3MHz RB size: 15#, RB offset: 0#

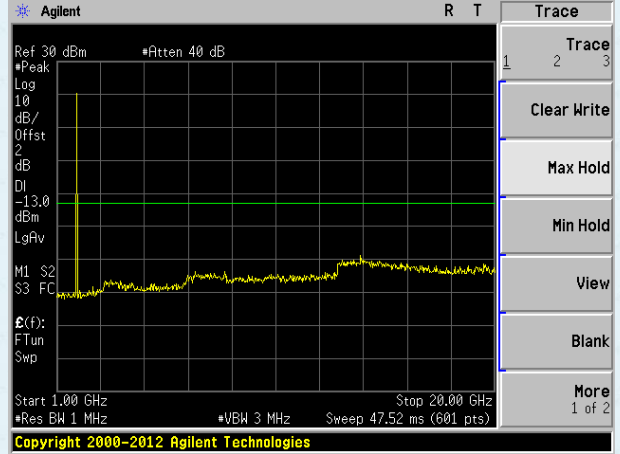
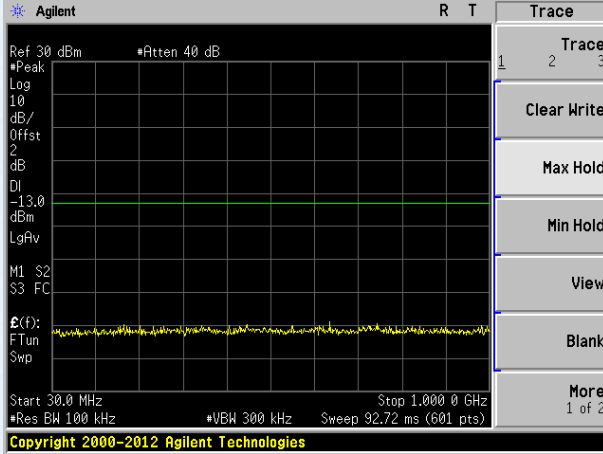

Lowest channel

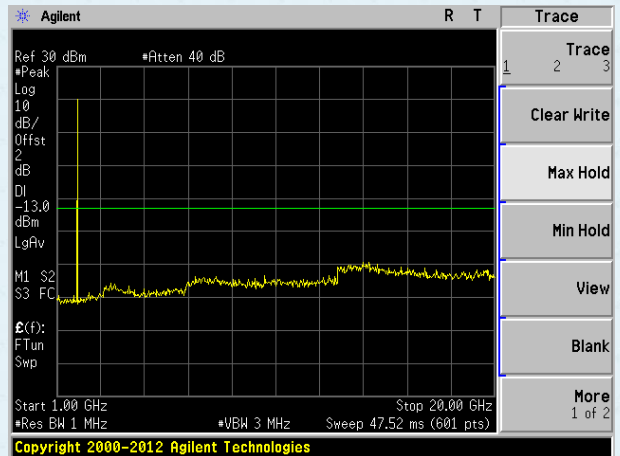
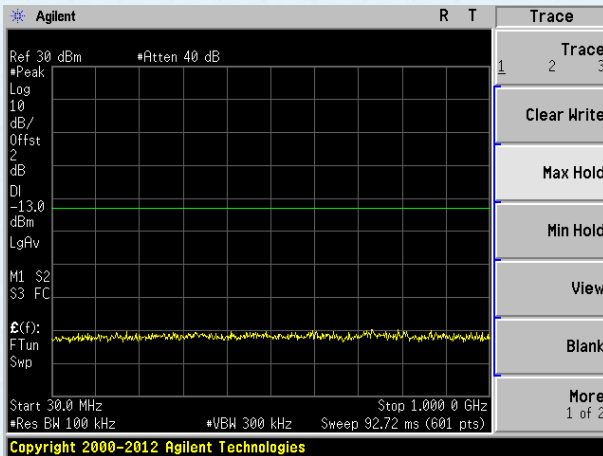

Middle channel

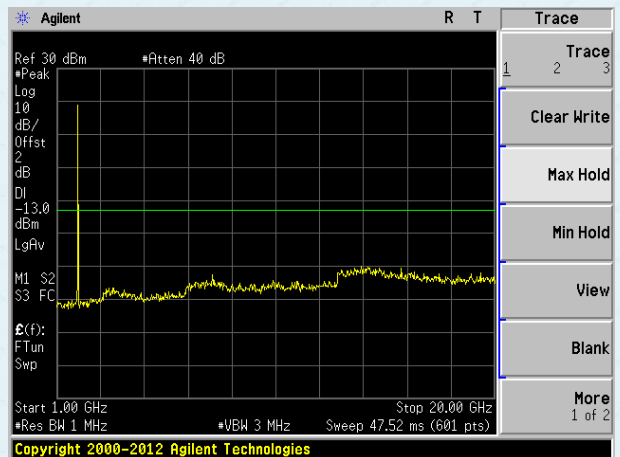
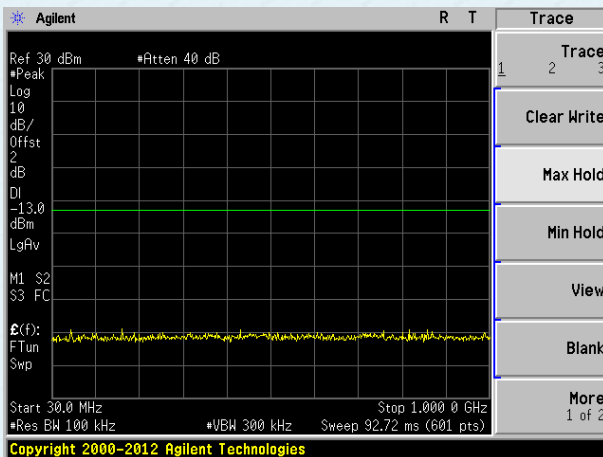

Highest channel

Test Mode: LTE Band 2 Channel Bandwidth: 5MHz RB size: 25#, RB offset: 0#

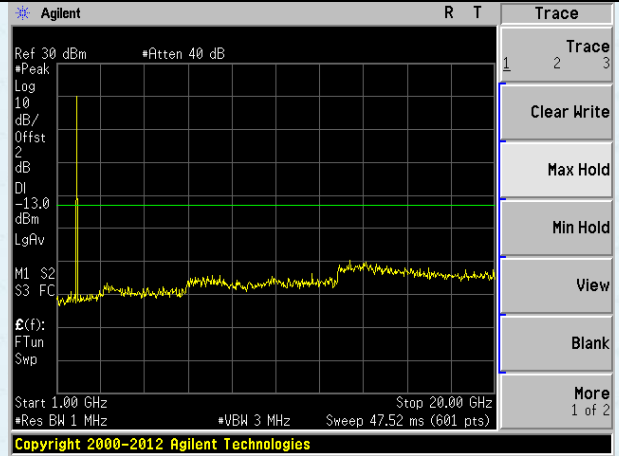
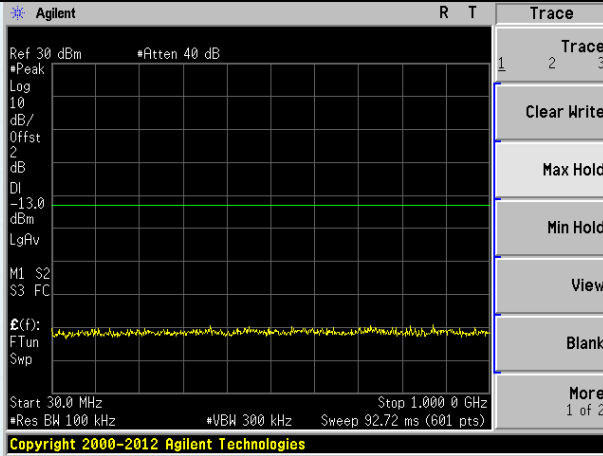

Lowest channel

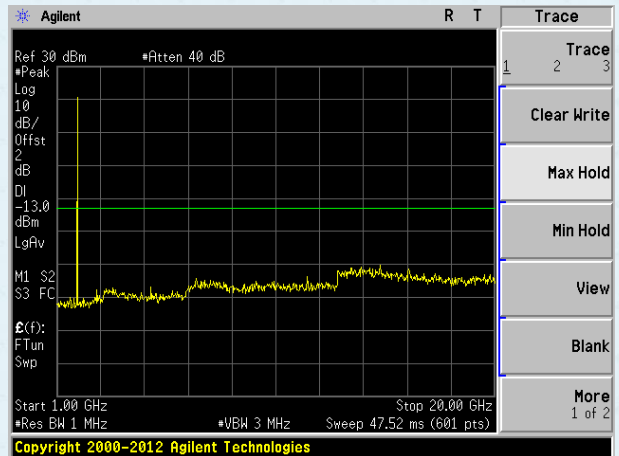
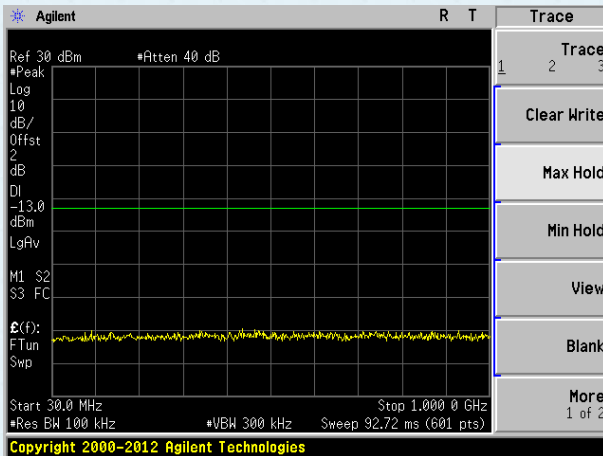

Middle channel

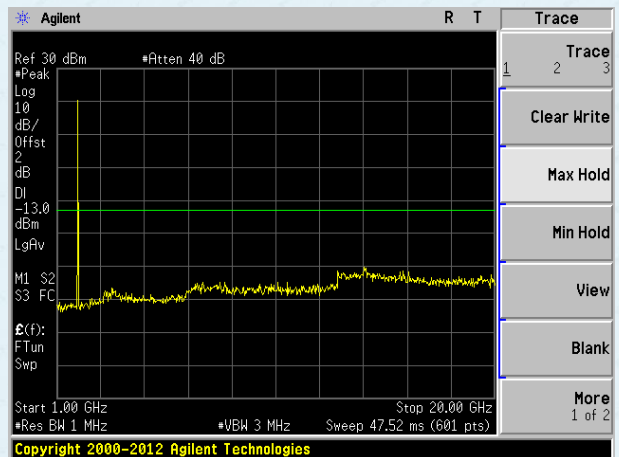
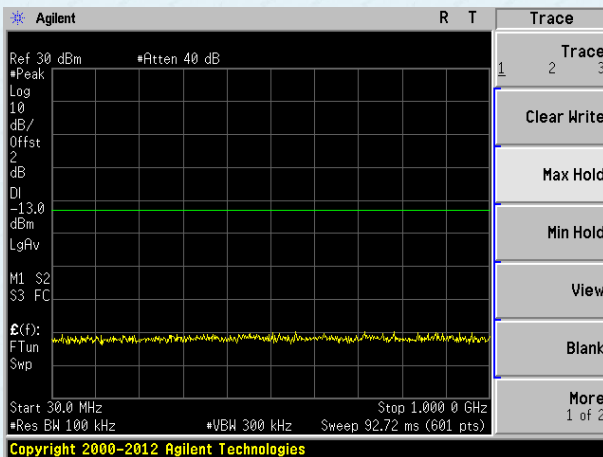

Highest channel

Test Mode: LTE Band 2 Channel Bandwidth: 10MHz RB size: 50#, RB offset: 0#

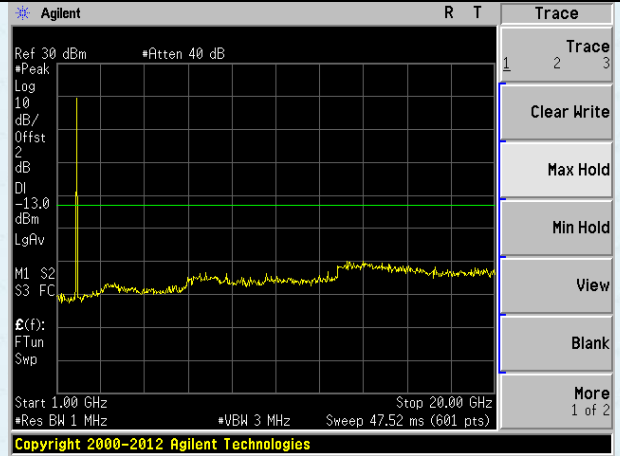
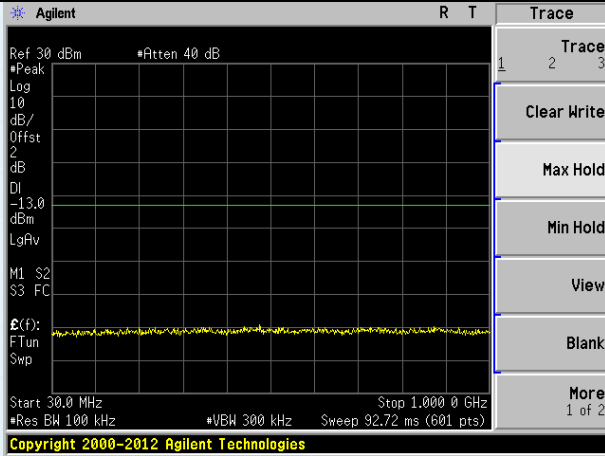

Lowest channel

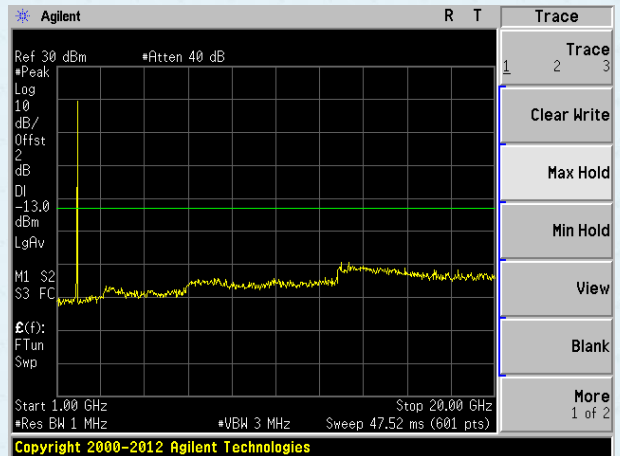
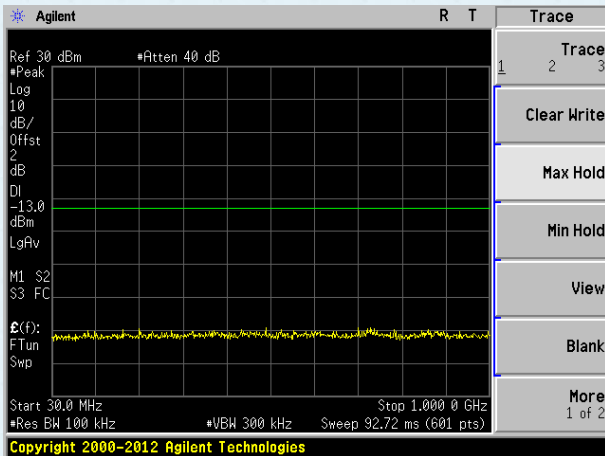

Middle channel

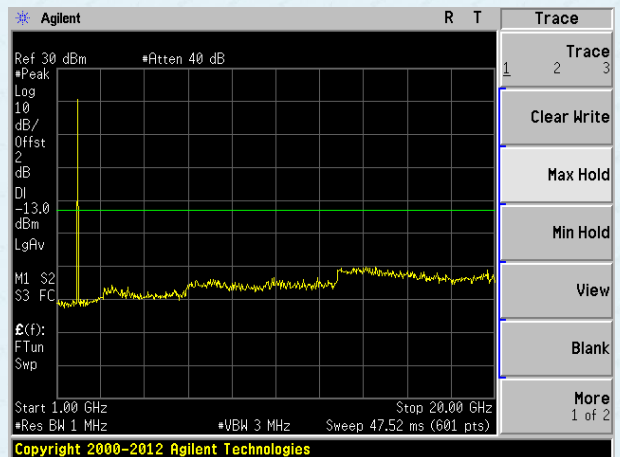
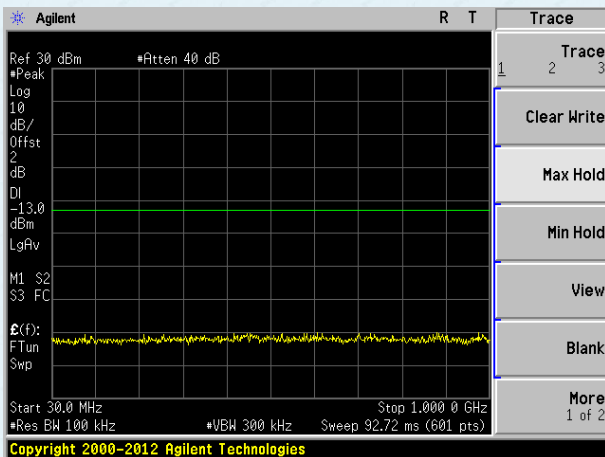

Highest channel

Test Mode: LTE Band 2 Channel Bandwidth: 15MHz RB size: 75#, RB offset: 0#

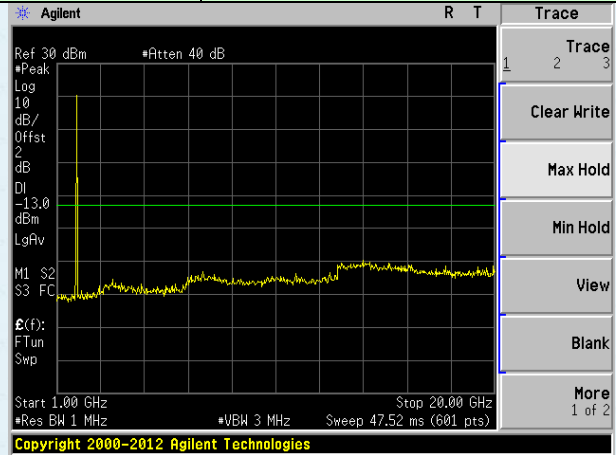
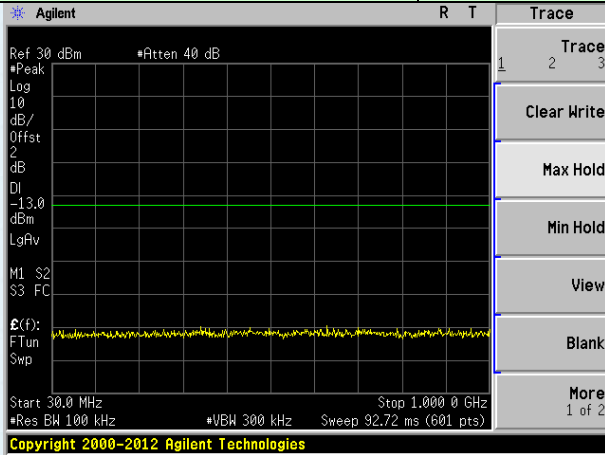

Lowest channel

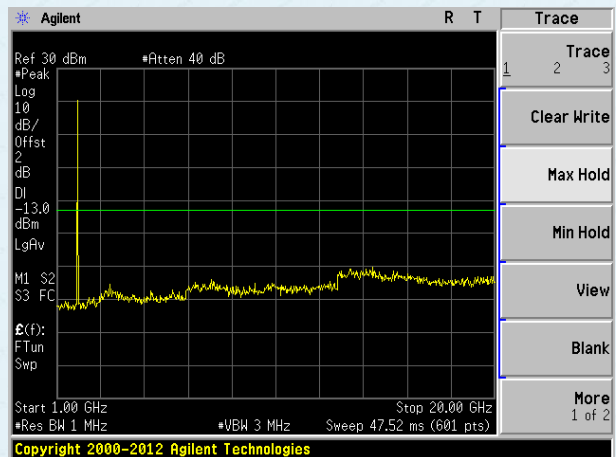
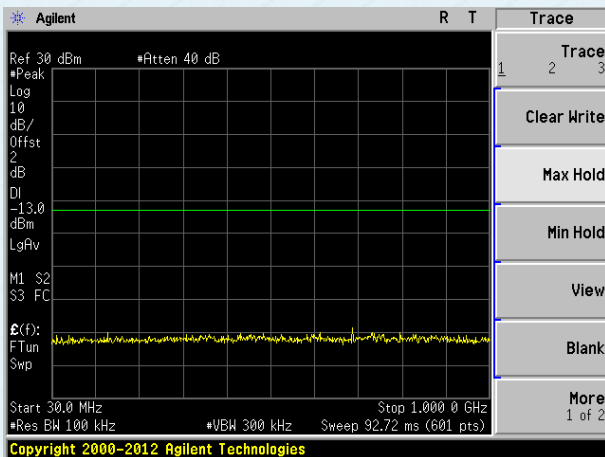

Middle channel

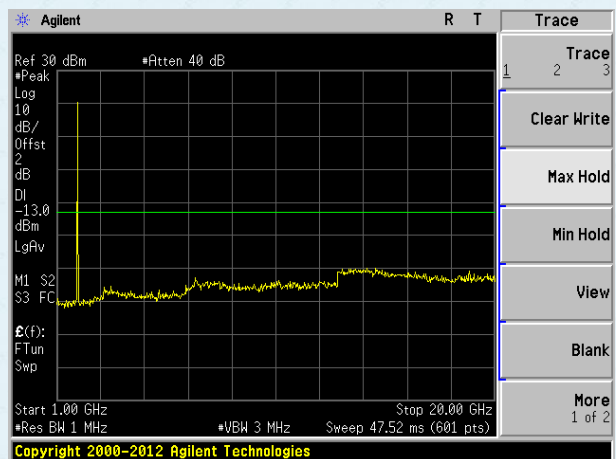
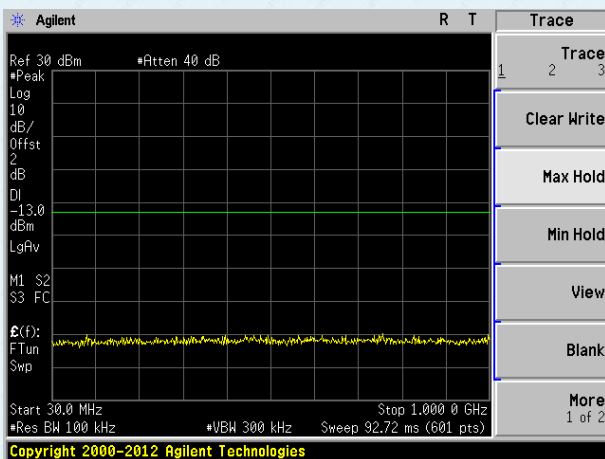

Highest channel

Test Mode: LTE Band 2 Channel Bandwidth: 20MHz RB size: 100#, RB offset: 0#

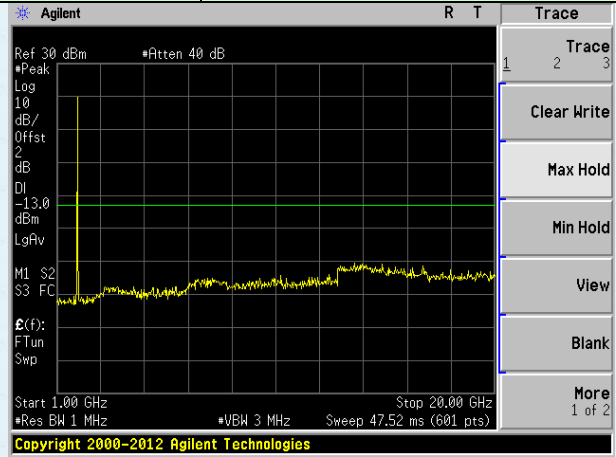
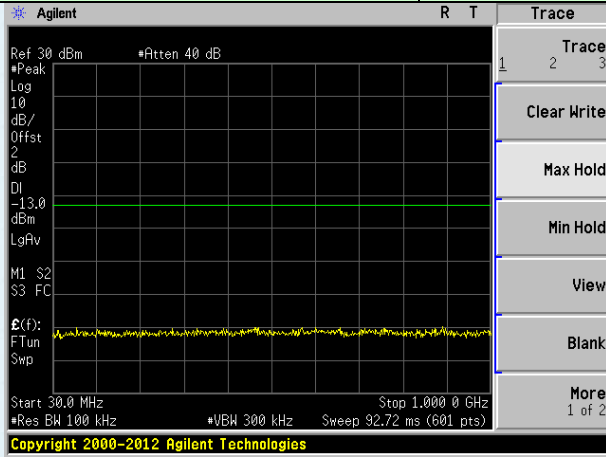

Lowest channel

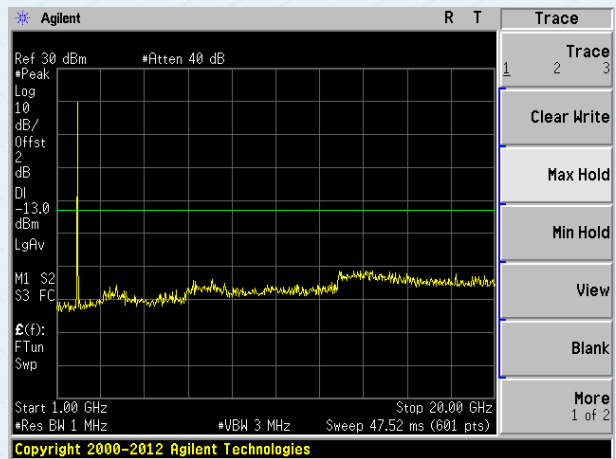
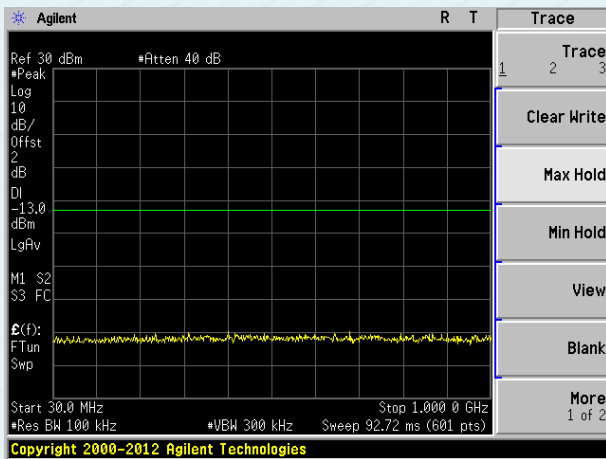

Middle channel

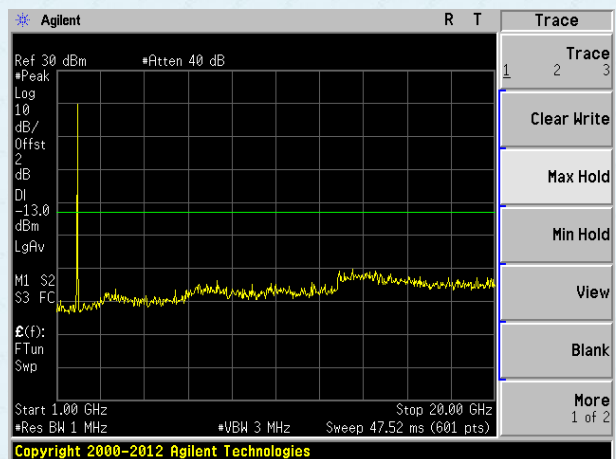
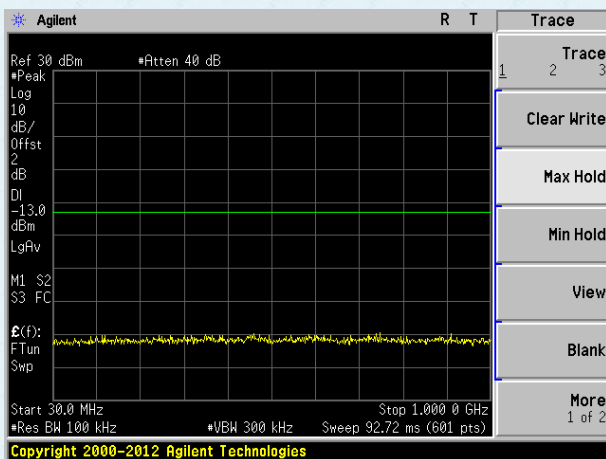

Highest channel

Test Mode: LTE Band 4 Channel Bandwidth: 1.4MHz RB size: 6#, RB offset: 0#

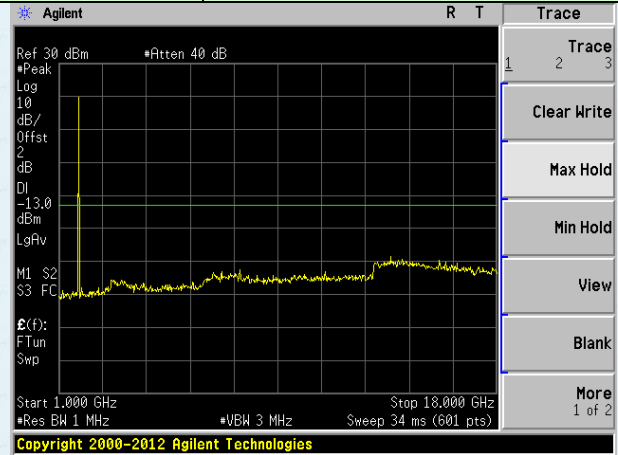
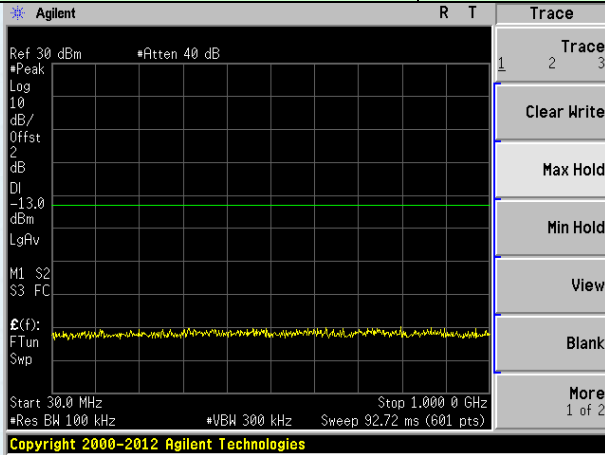

Lowest channel

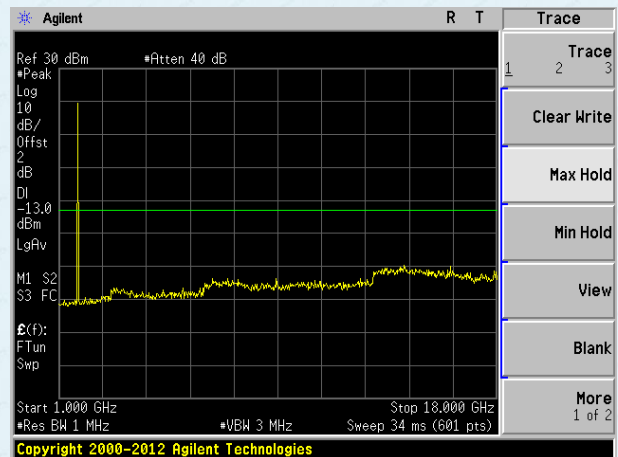
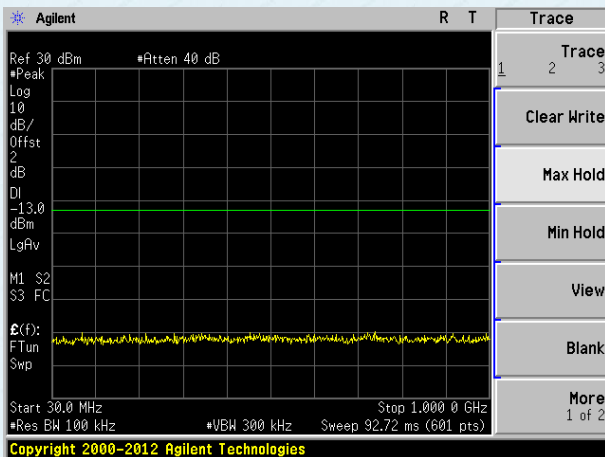

Middle channel

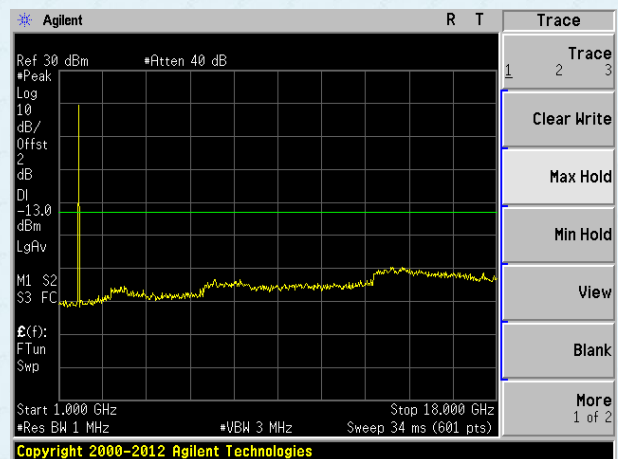
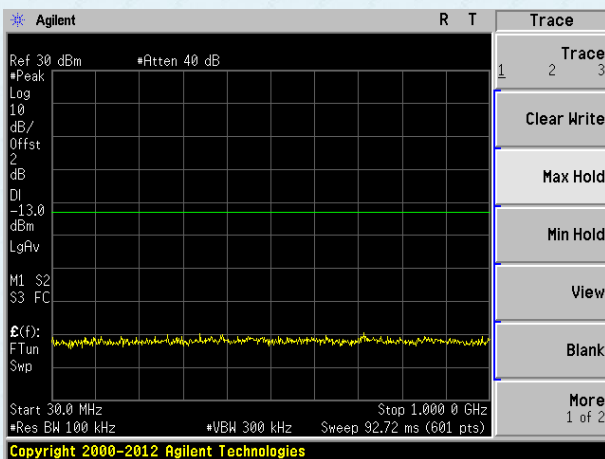

Highest channel

Test Mode: LTE Band 4 Channel Bandwidth: 3MHz RB size: 15#, RB offset: 0#

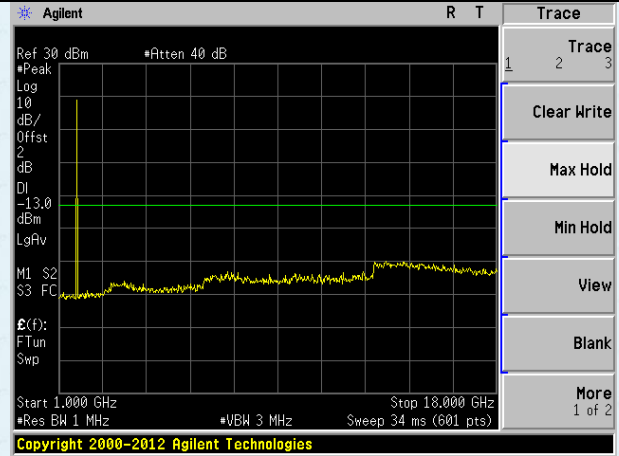
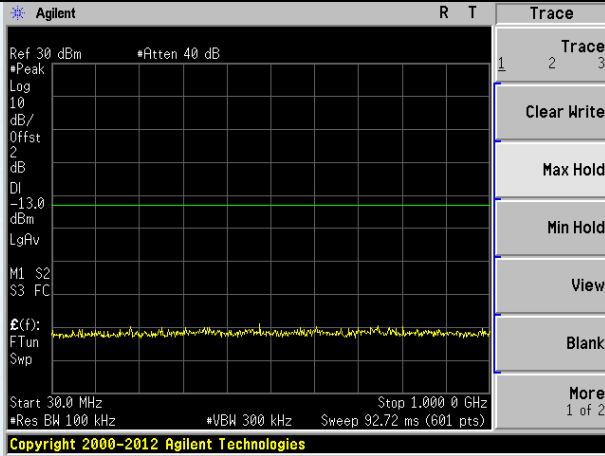

Lowest channel

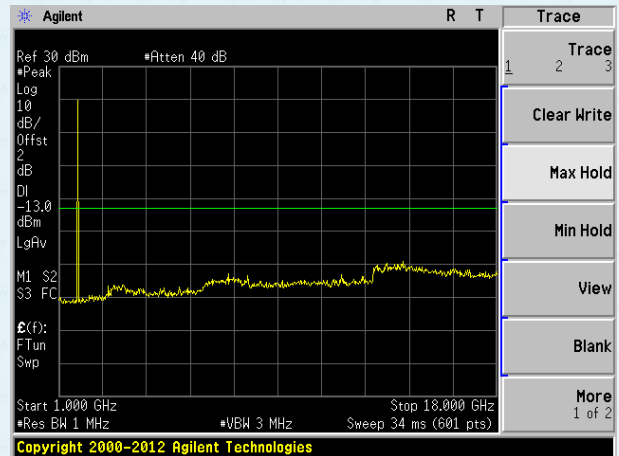
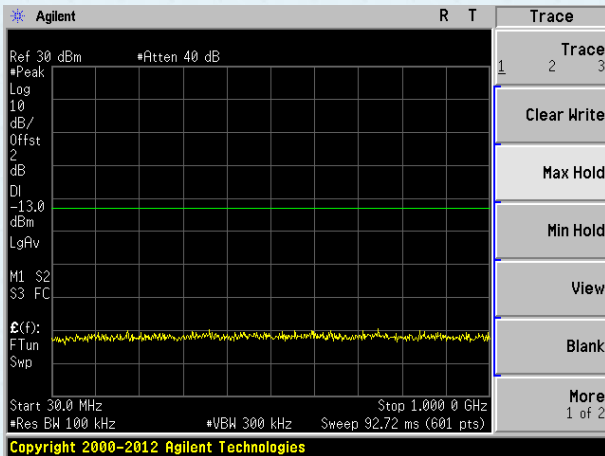

Middle channel

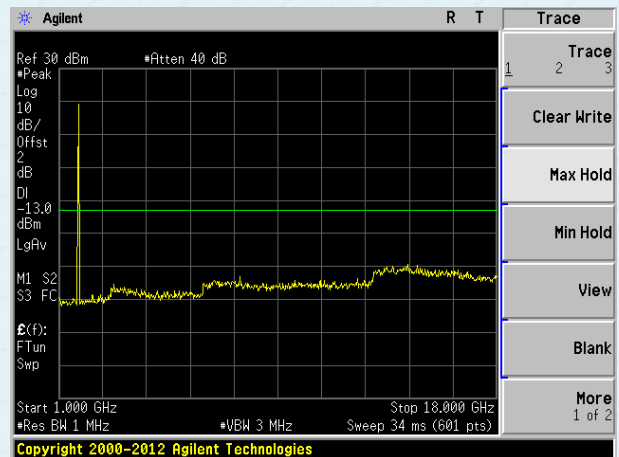
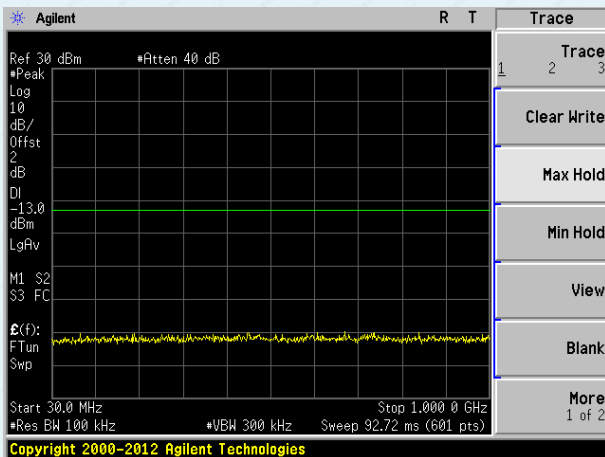

Highest channel

Test Mode: LTE Band 4 Channel Bandwidth: 5MHz RB size: 25#, RB offset: 0#

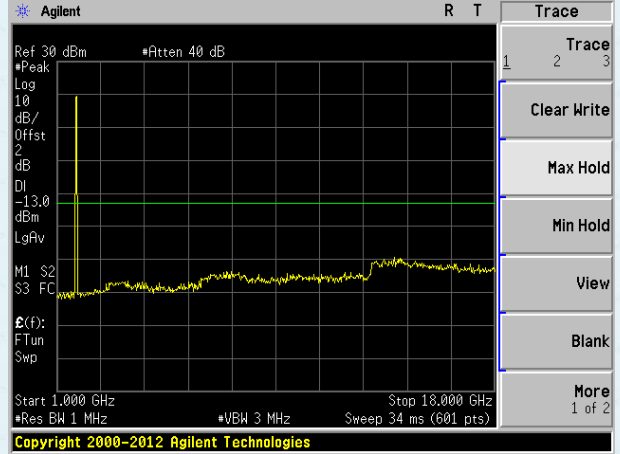
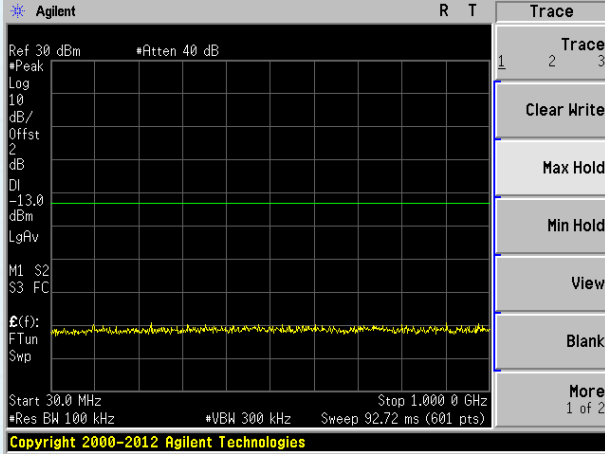

Lowest channel

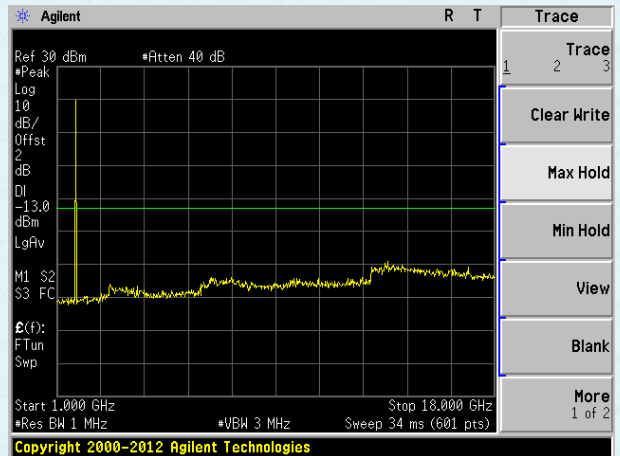
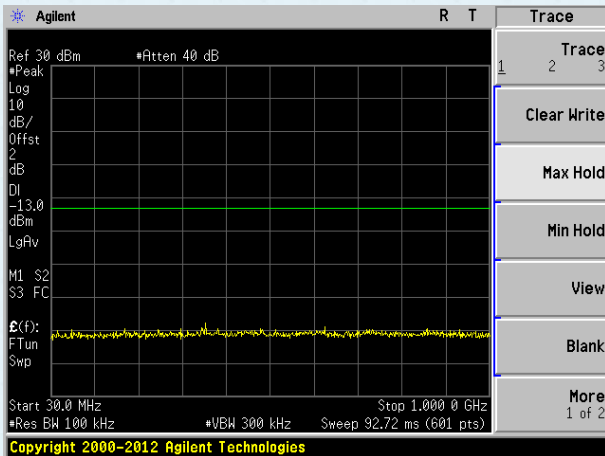

Middle channel

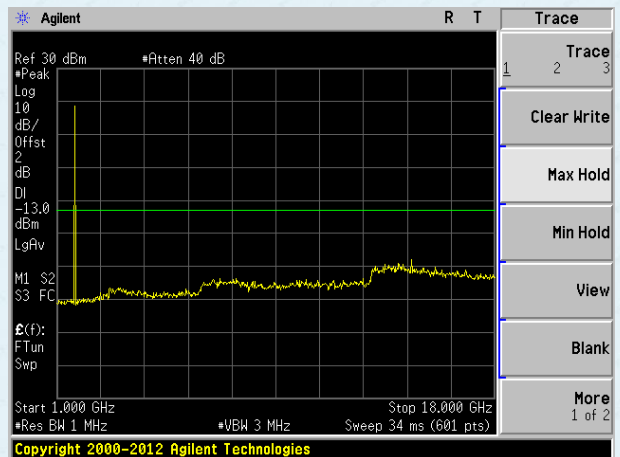
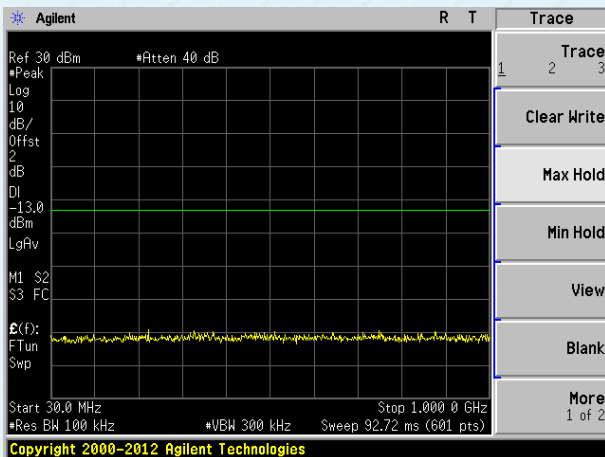

Highest channel

Test Mode: LTE Band 4 Channel Bandwidth: 10MHz RB size: 50#, RB offset: 0#

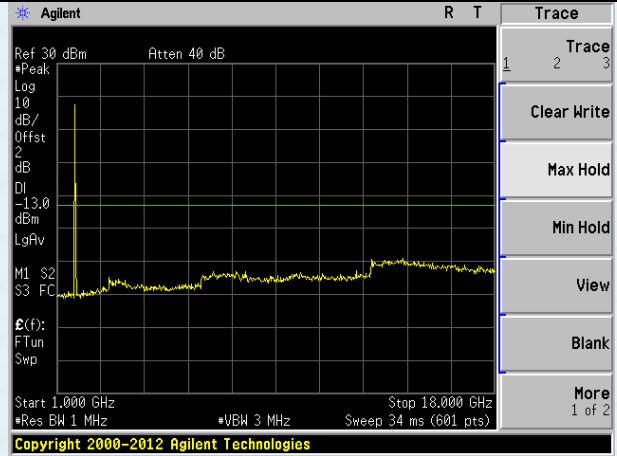
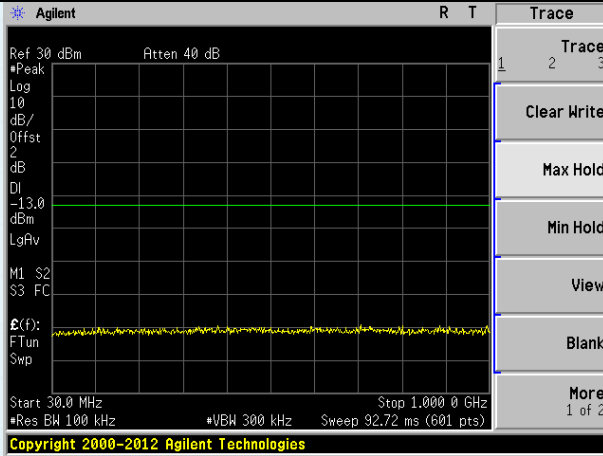

Lowest channel

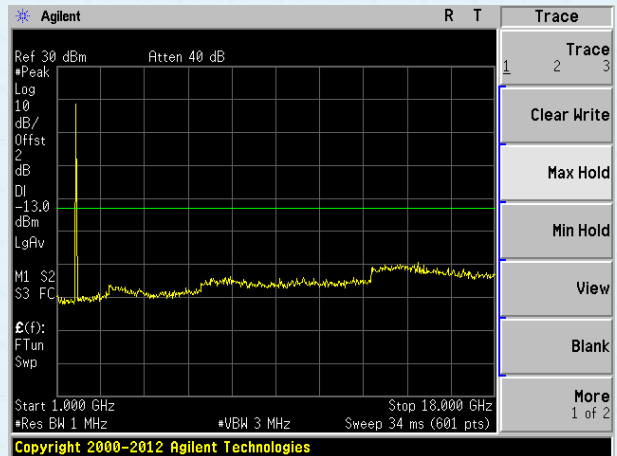
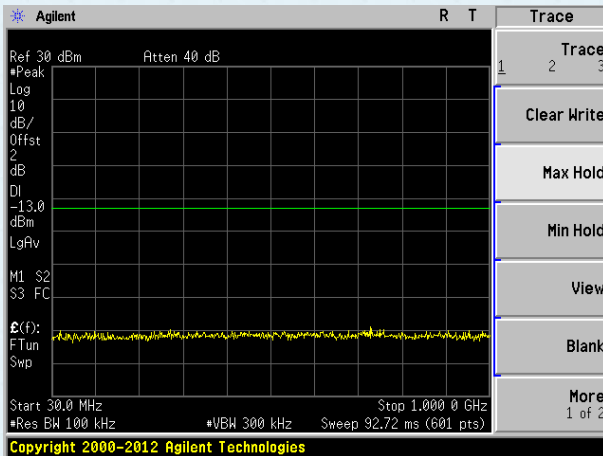

Middle channel

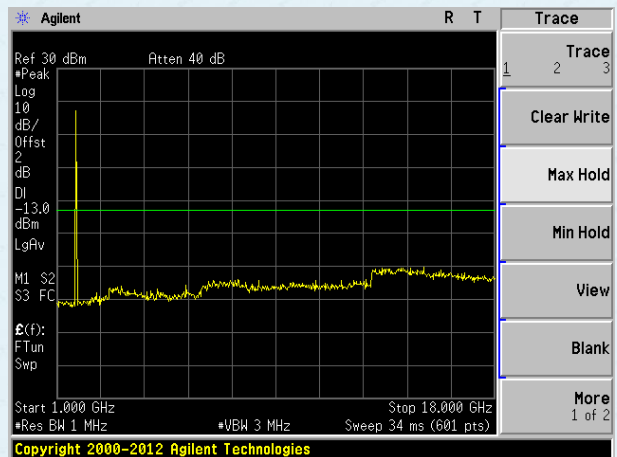
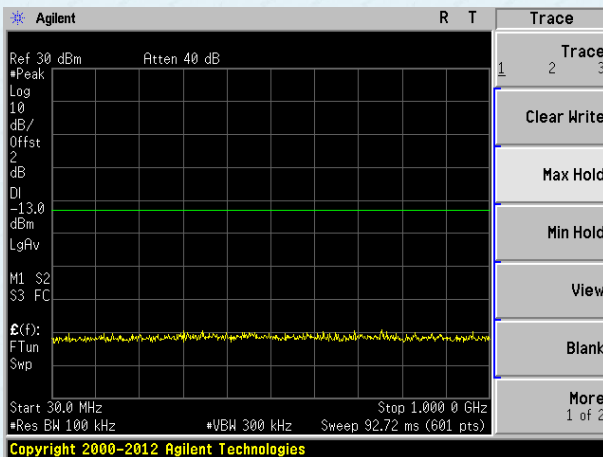

Highest channel

Test Mode: LTE Band 4 Channel Bandwidth: 15MHz RB size: 75#, RB offset: 0#

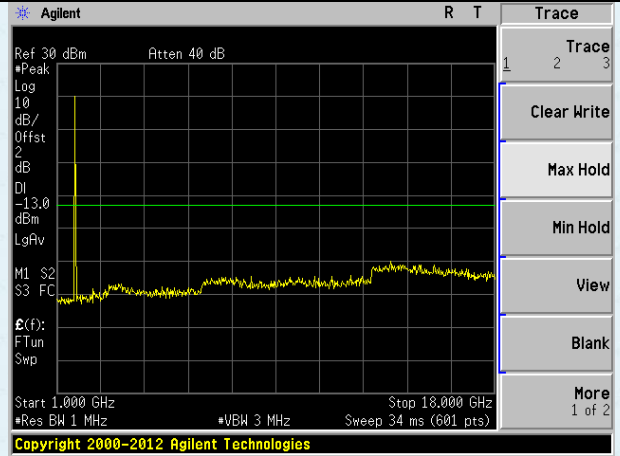
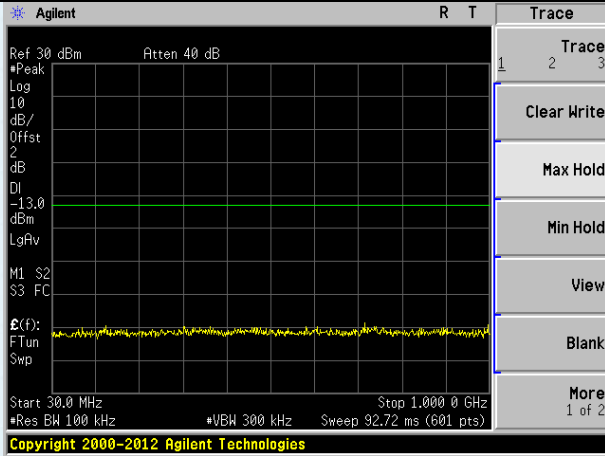

Lowest channel

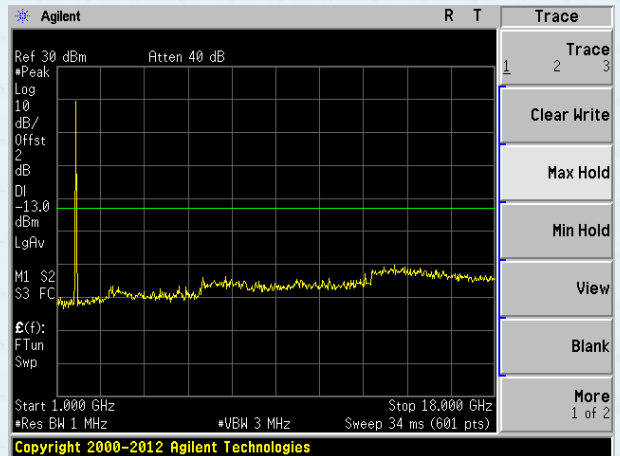
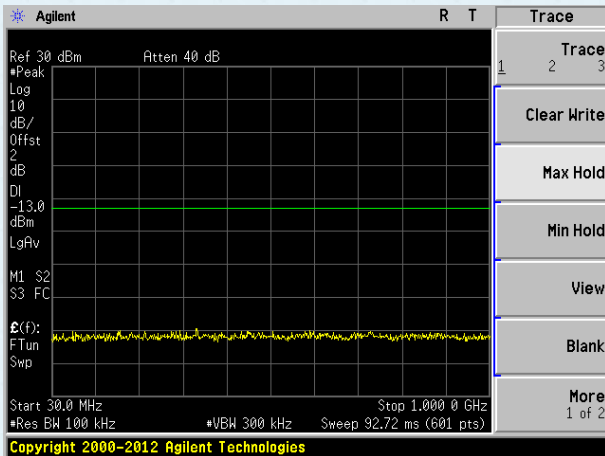

Middle channel

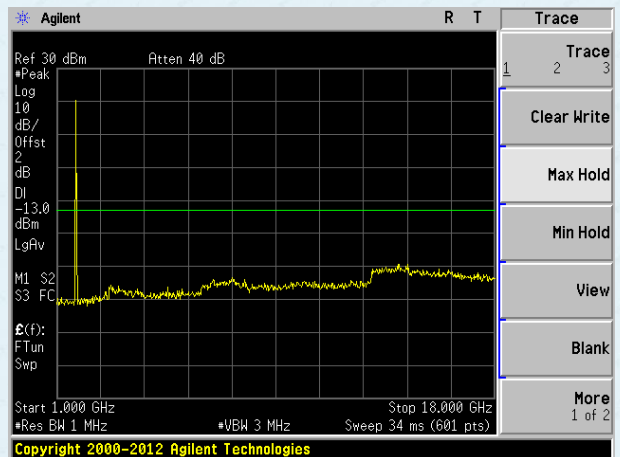
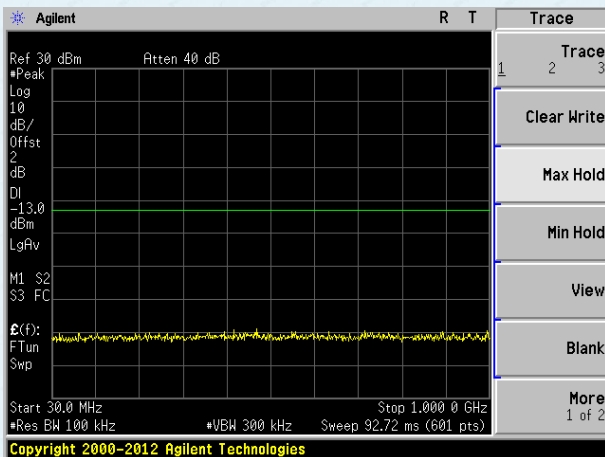

Highest channel

Test Mode: LTE Band 4 Channel Bandwidth: 20MHz RB size: 100#, RB offset: 0#

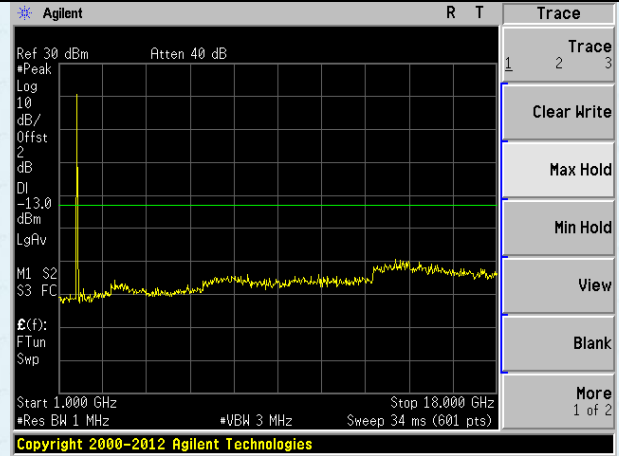
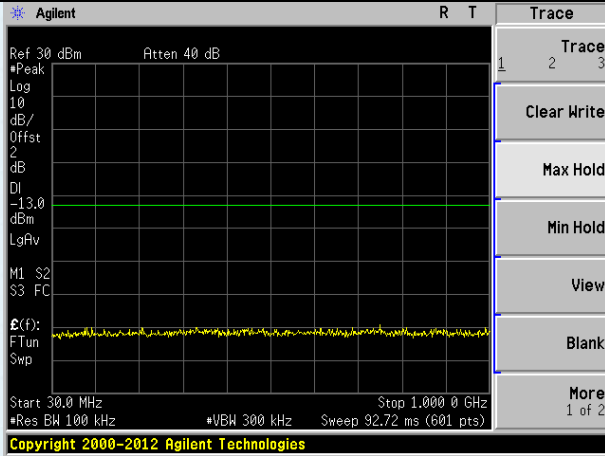

Lowest channel

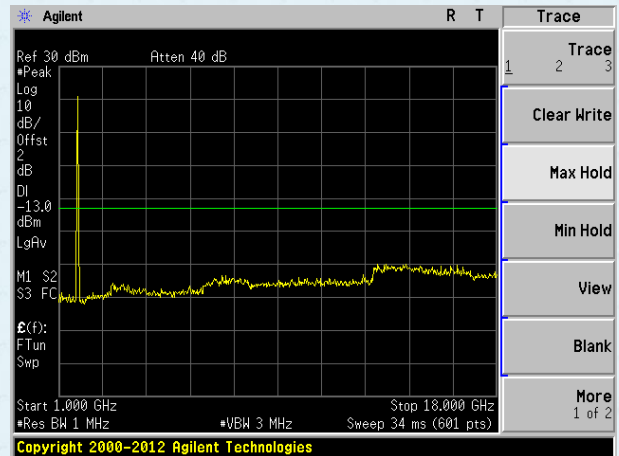
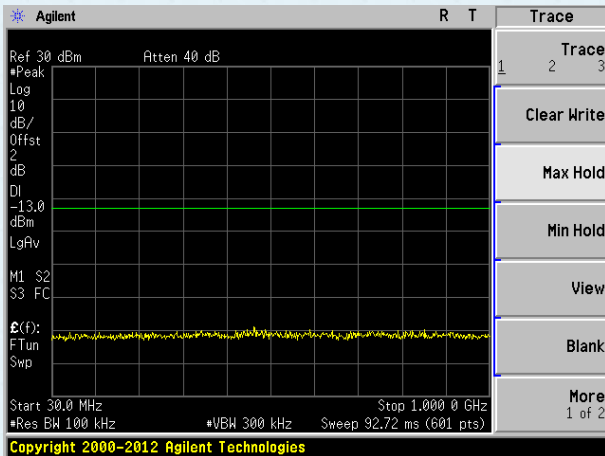

Middle channel

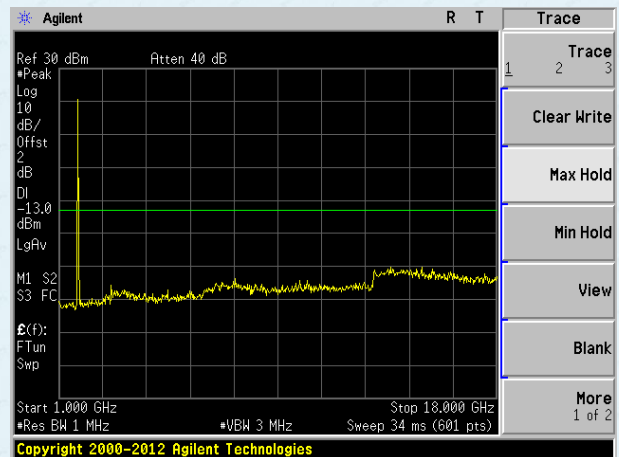
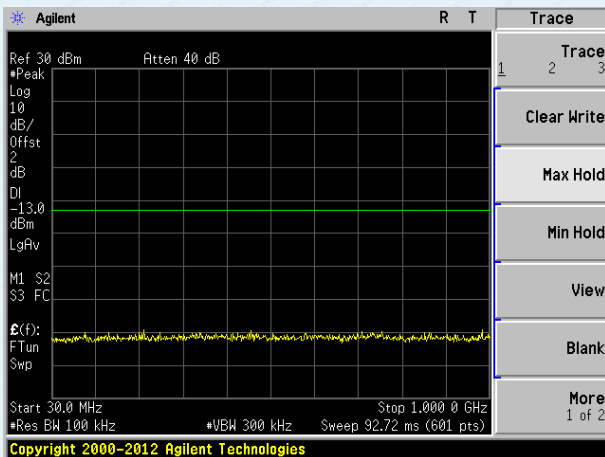

Highest channel

Test Mode: LTE Band 12 Channel Bandwidth: 1.4MHz RB size: 6#, RB offset: 0#

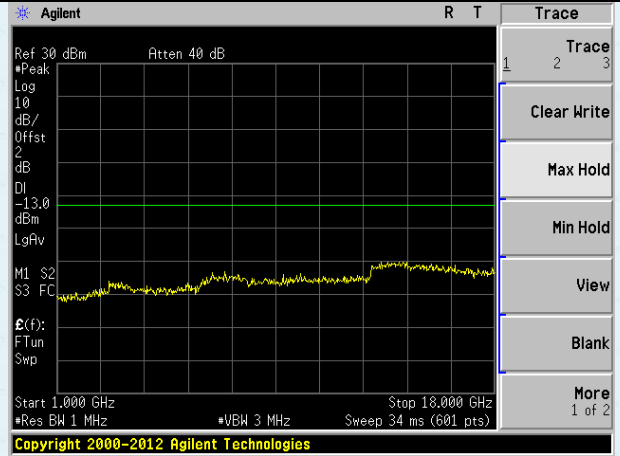
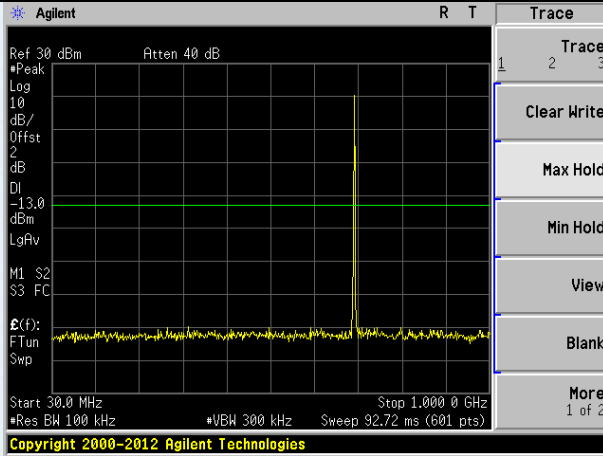

Lowest channel

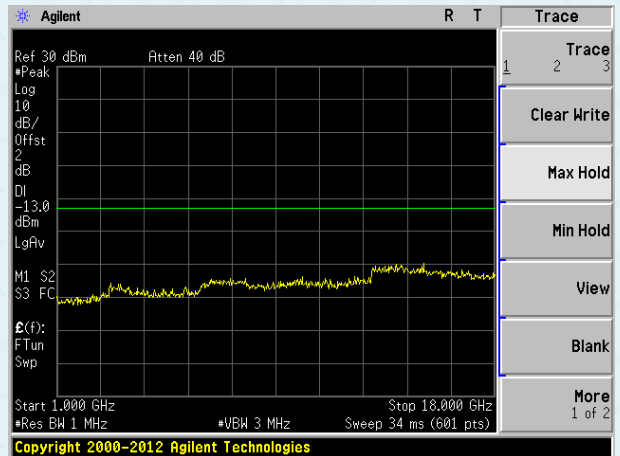
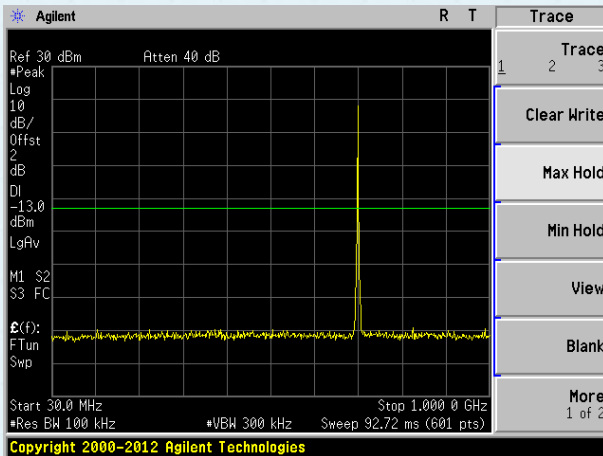

Middle channel

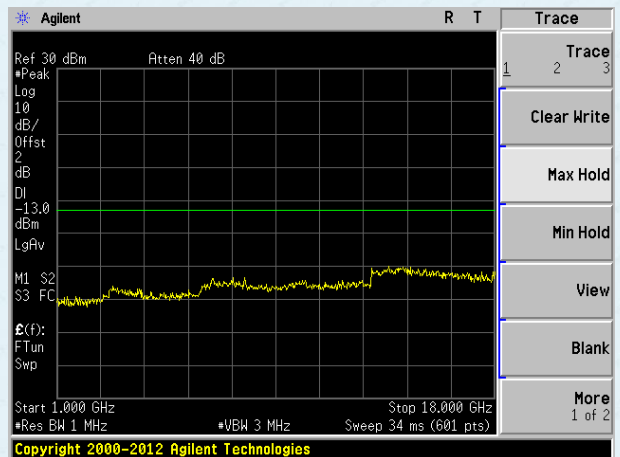
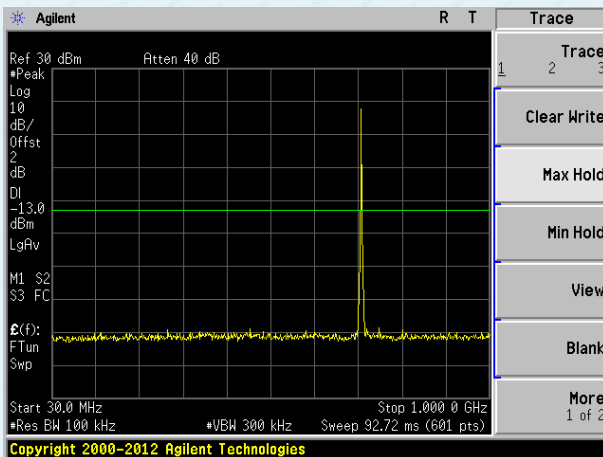

Highest channel

Test Mode: LTE Band 12 Channel Bandwidth: 3MHz RB size: 15#, RB offset: 0#

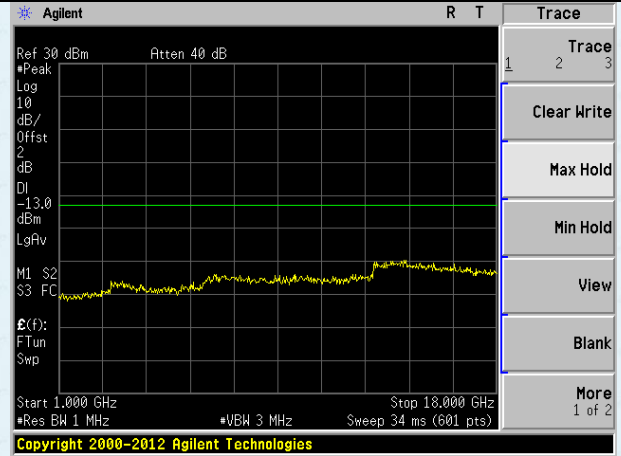
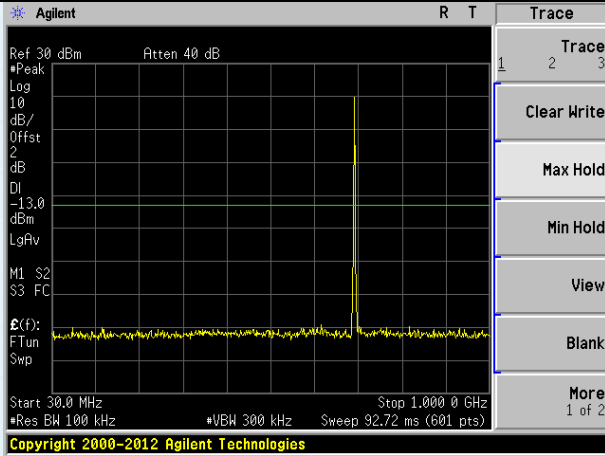

Lowest channel

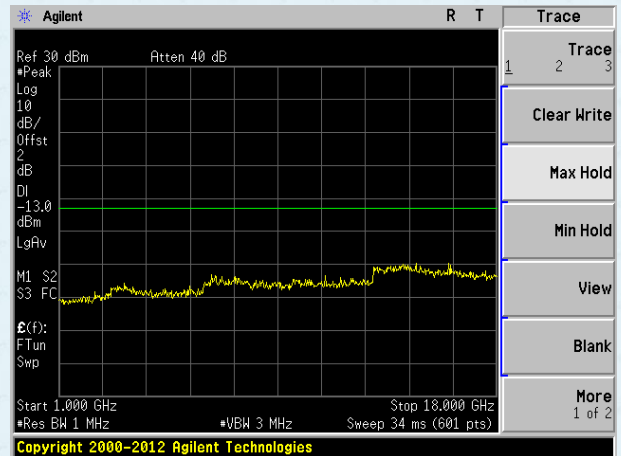
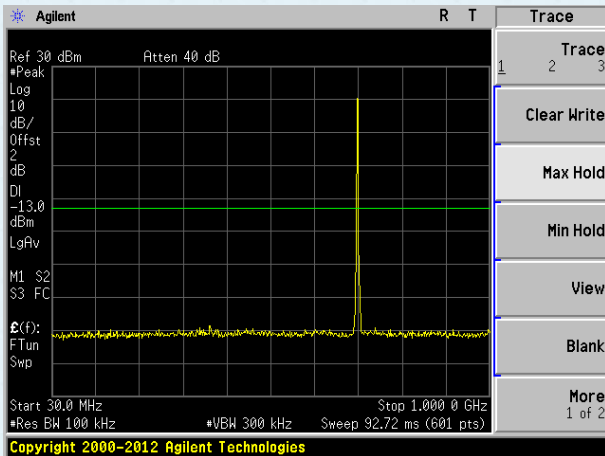

Middle channel

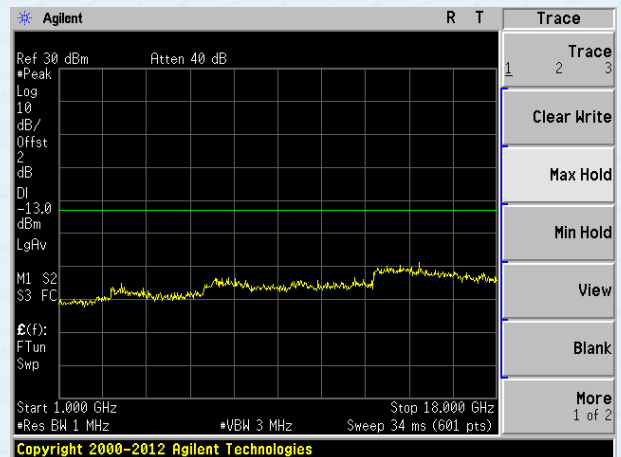
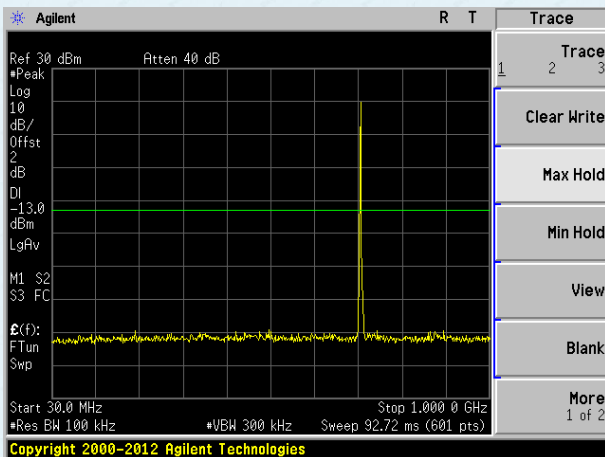

Highest channel

Test Mode: LTE Band 12 Channel Bandwidth: 5MHz RB size: 25#, RB offset: 0#

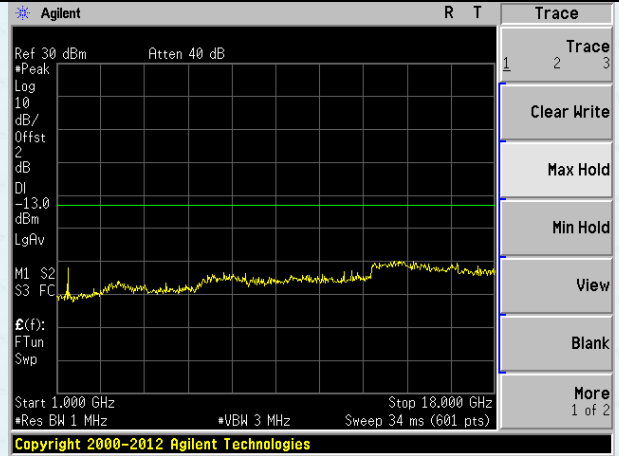
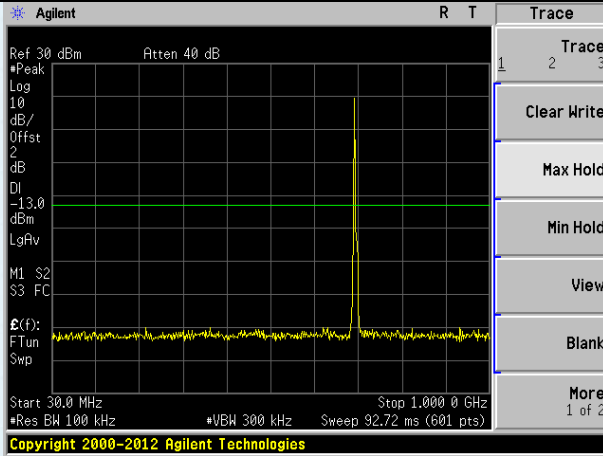

Lowest channel

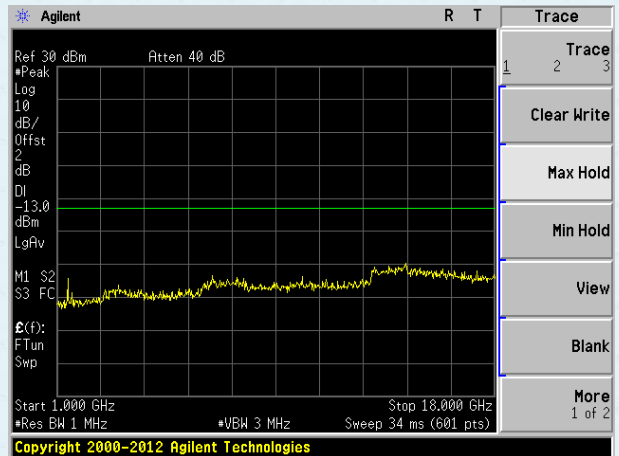
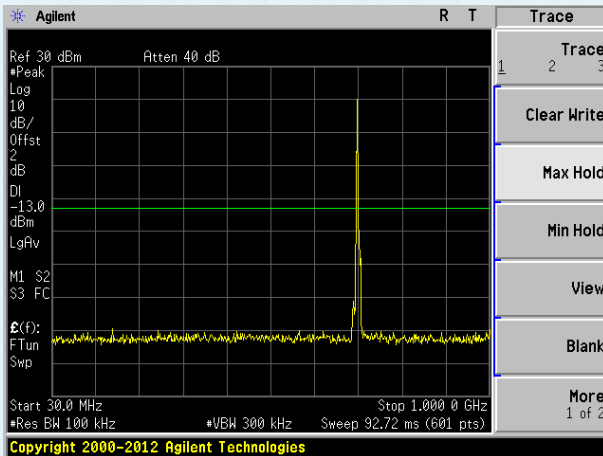

Middle channel

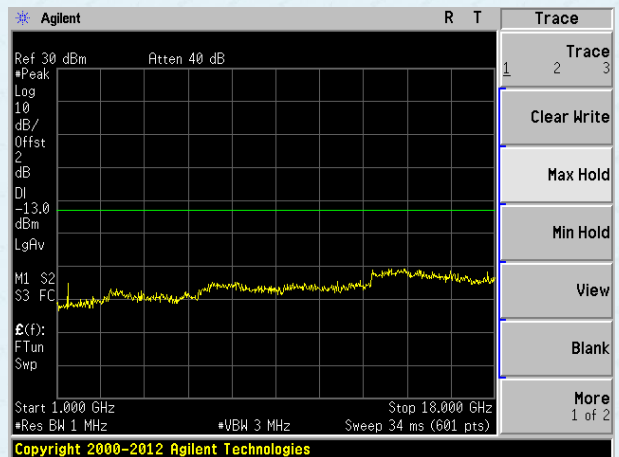
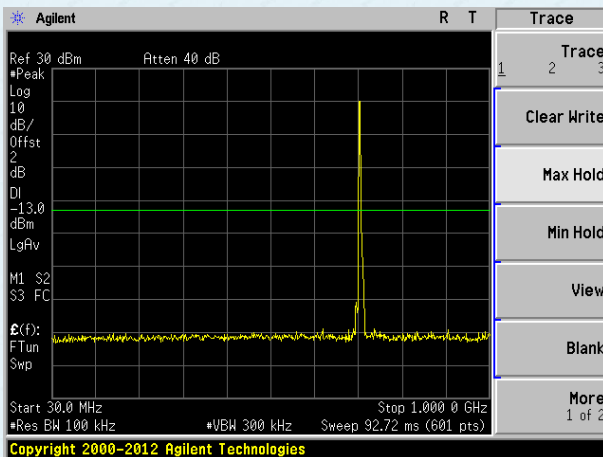

Highest channel

Test Mode: LTE Band 12 Channel Bandwidth: 10MHz RB size: 50#, RB offset: 0#

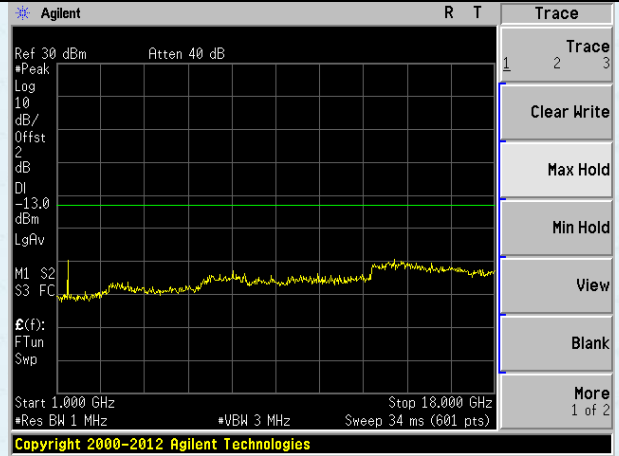
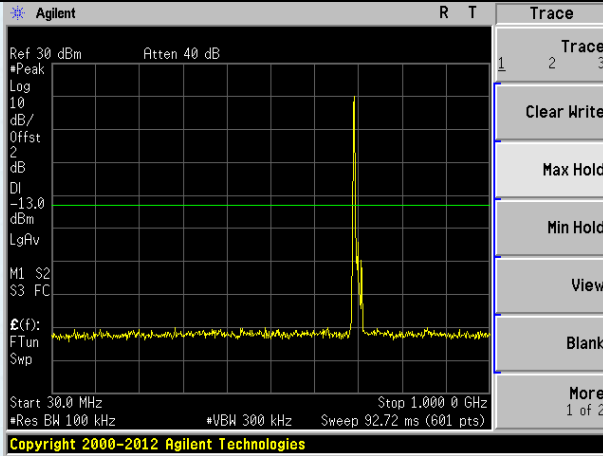

Lowest channel

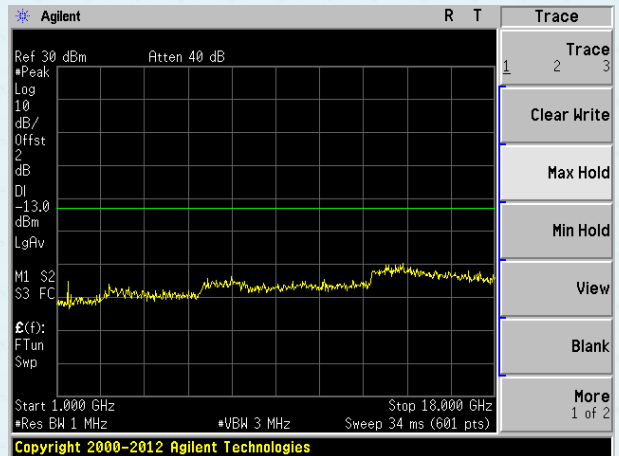
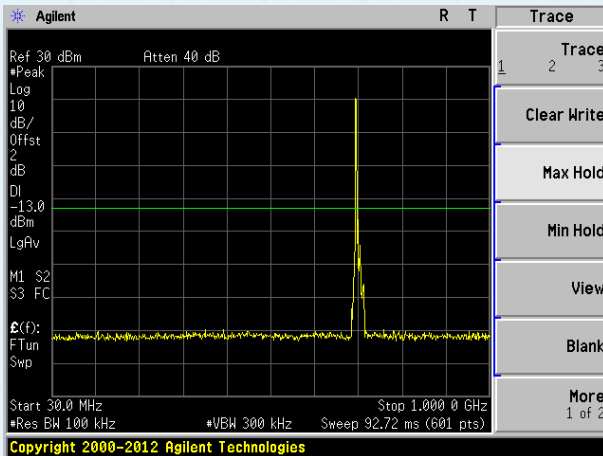

Middle channel

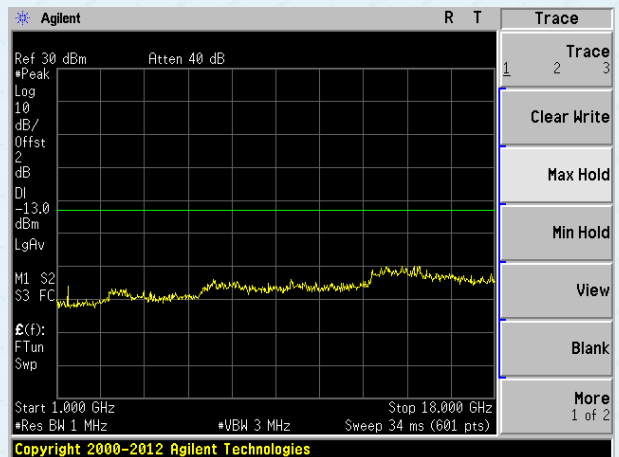
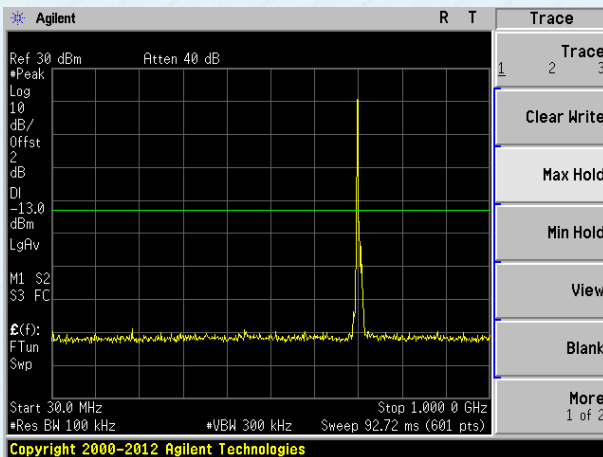

Highest channel

Band Edge:
LTE Band 2(QPSK mode):

1.4MHz Bandwidth (RB size:1# RB offset:0#)

1.4MHz Bandwidth (RB size:1# RB offset:5#)

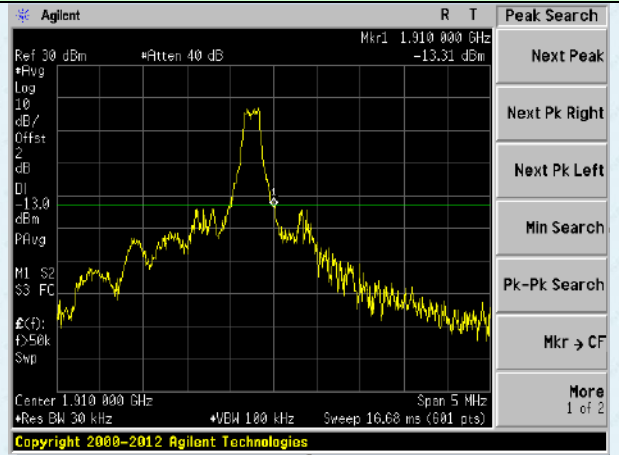
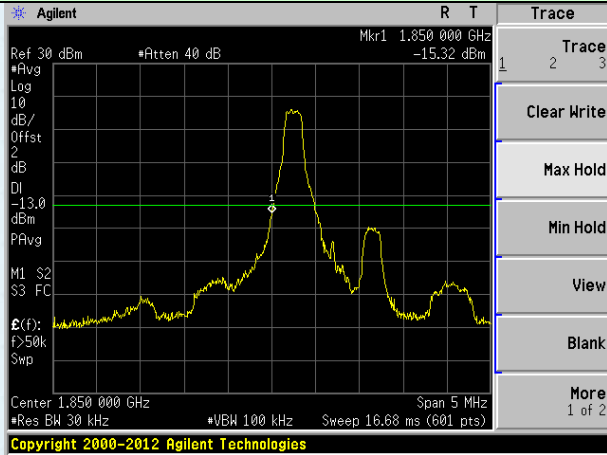

Lowest channel

Highest channel

1.4MHz Bandwidth (RB size:3# RB offset:0#)

1.4MHz Bandwidth (RB size:3# RB offset:2#)

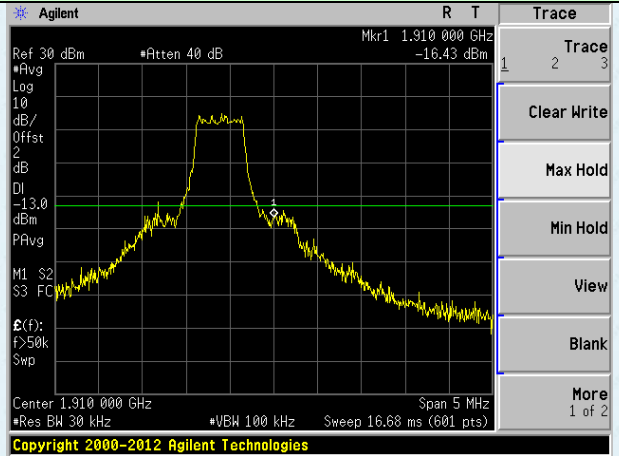
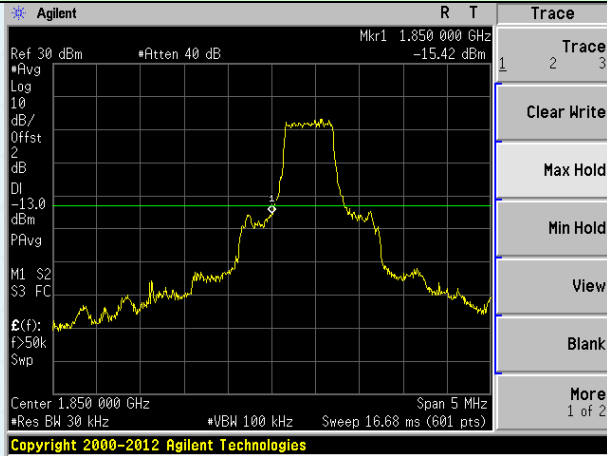

Lowest channel

Highest channel

1.4MHz Bandwidth (RB size:6# RB offset:0#)

1.4MHz Bandwidth (RB size:6# RB offset:0#)

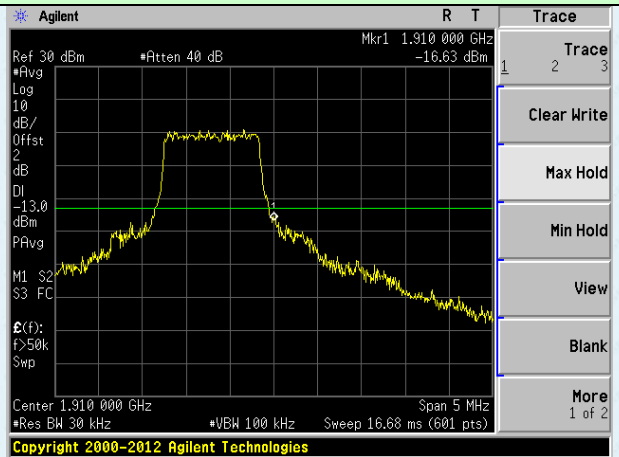
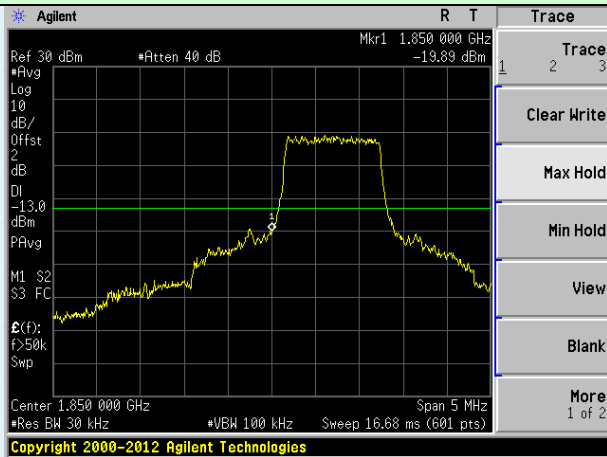

Lowest channel

Highest channel

3MHz Bandwidth (RB size:1# RB offset:0#) **3MHz Bandwidth (RB size:1# RB offset:14#)**

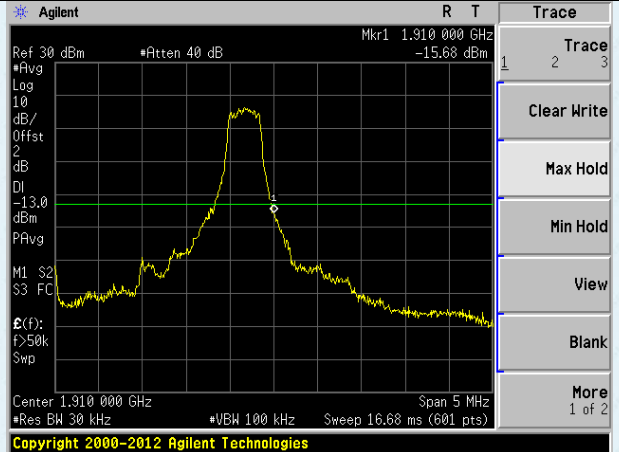
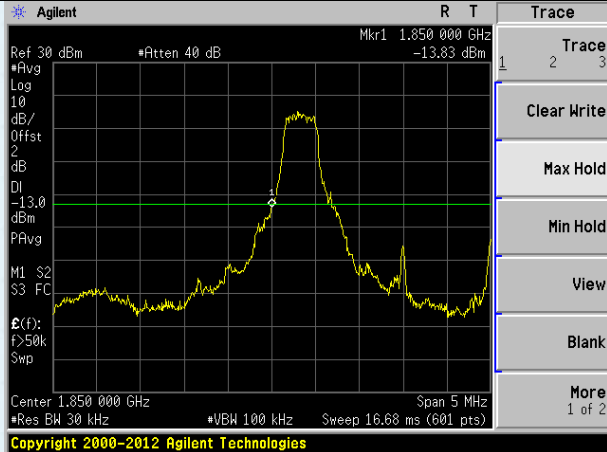

Lowest channel

Highest channel

3MHz Bandwidth (RB size:8# RB offset:0#) **3MHz Bandwidth (RB size:8# RB offset:7#)**

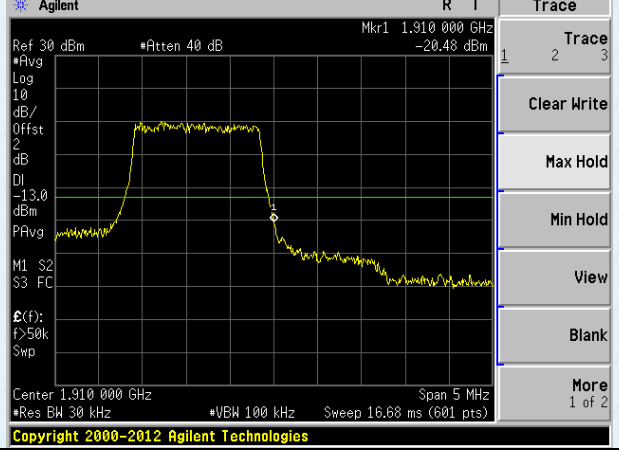
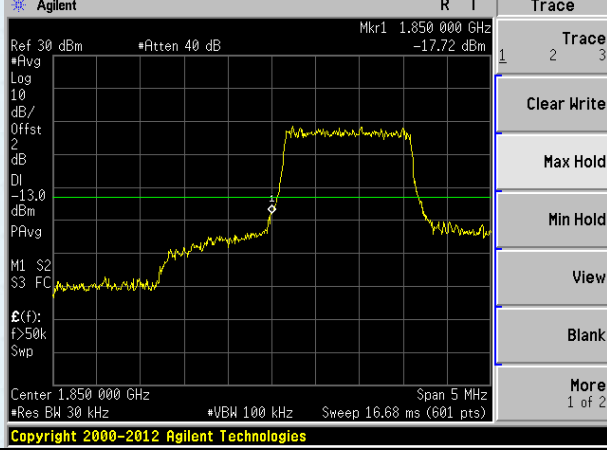

Lowest channel

Highest channel

3MHz Bandwidth (RB size:15# RB offset:0#) **3MHz Bandwidth (RB size:15# RB offset:0#)**

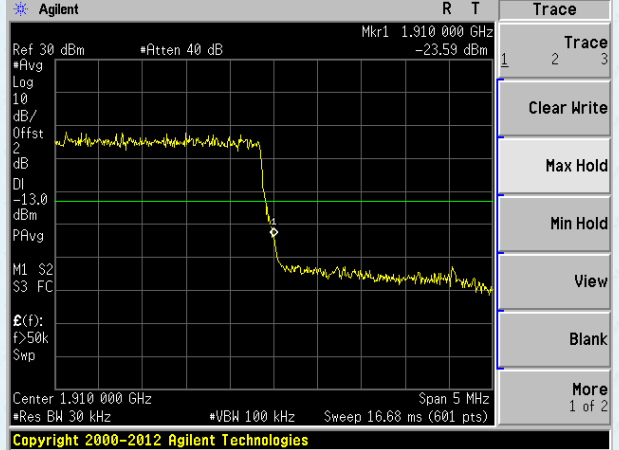
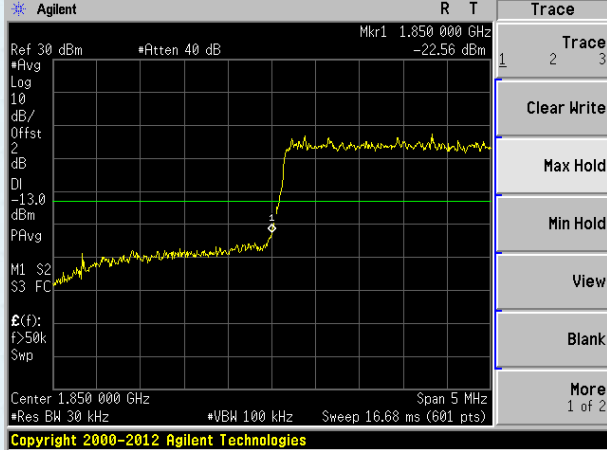

Lowest channel

Highest channel

5MHz Bandwidth (RB size:1# RB offset:0#) 5MHz Bandwidth (RB size:1# RB offset:24#)

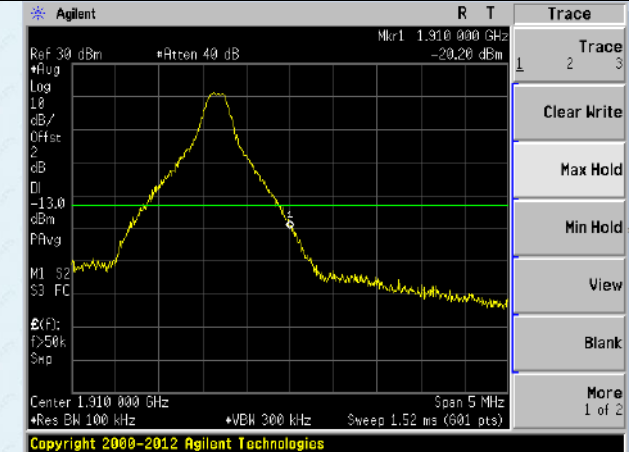
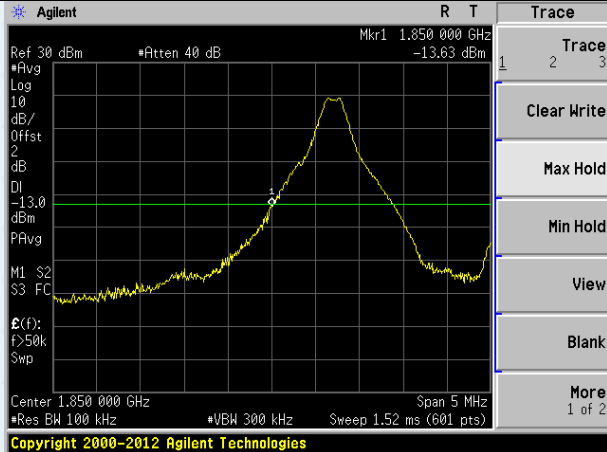

Lowest channel

Highest channel

5MHz Bandwidth (RB size:12# RB offset:0#) 5MHz Bandwidth (RB size:12# RB offset:13#)

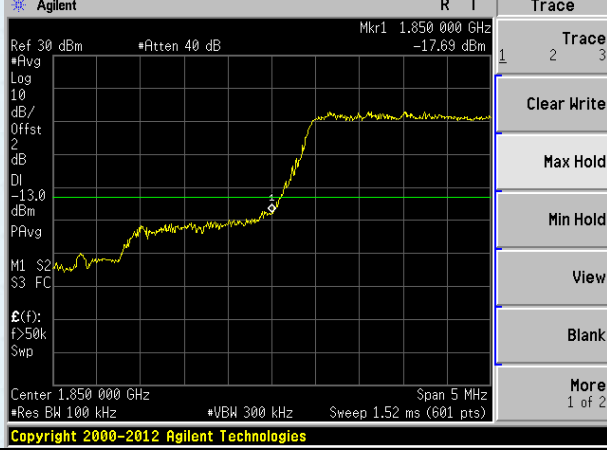

Lowest channel

Highest channel

5MHz Bandwidth (RB size:25# RB offset:0#) 5MHz Bandwidth (RB size:25# RB offset:0#)

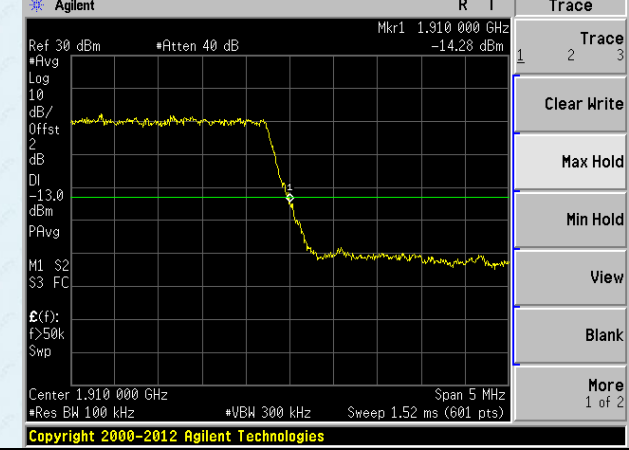
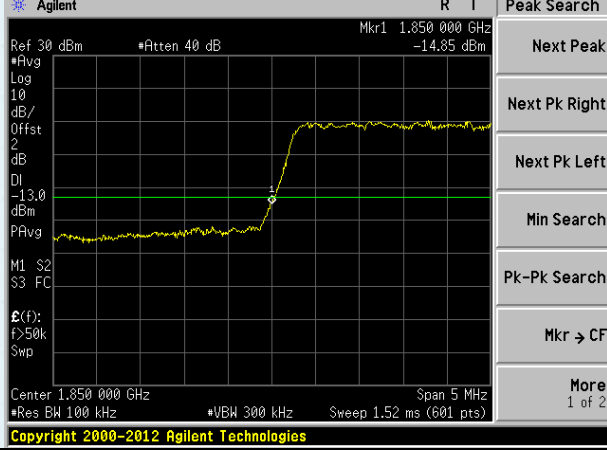

Lowest channel

Highest channel

10MHz Bandwidth (RB size:1# RB offset:0#) 10MHz Bandwidth (RB size:1# RB offset:49#)

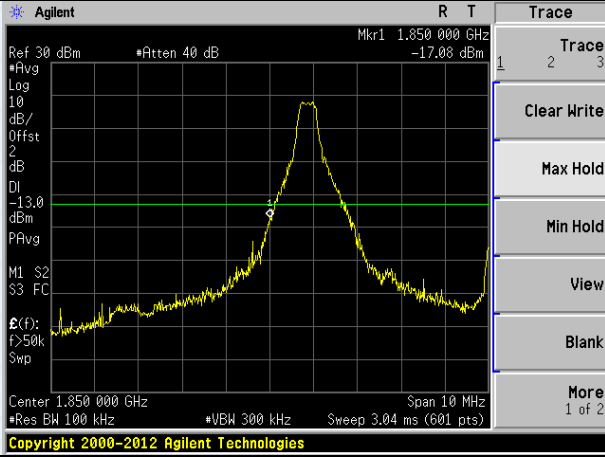

Lowest channel

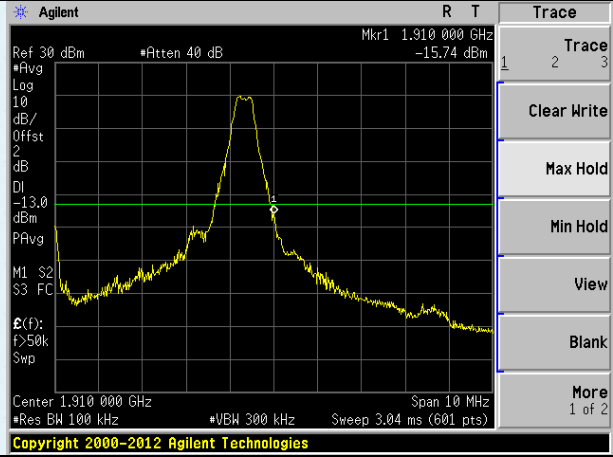

Highest channel

10MHz Bandwidth (RB size:25# RB offset:0#) 10MHz Bandwidth (RB size:25# RB offset:25#)

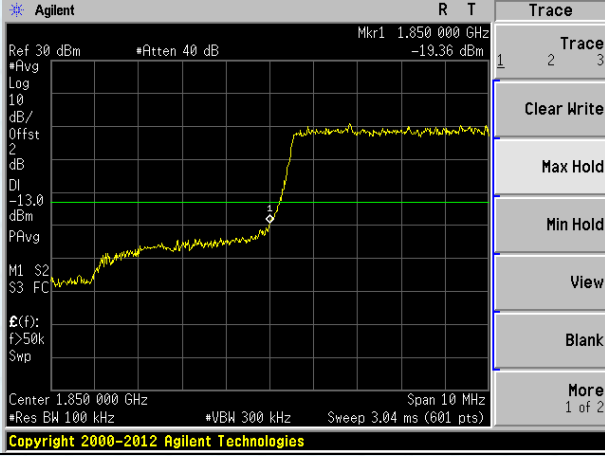

Lowest channel

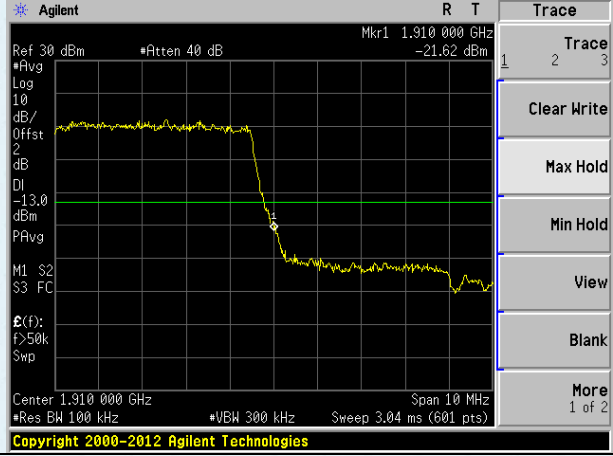

Highest channel

10MHz Bandwidth (RB size:50# RB offset:0#) 10MHz Bandwidth (RB size:50# RB offset:0#)

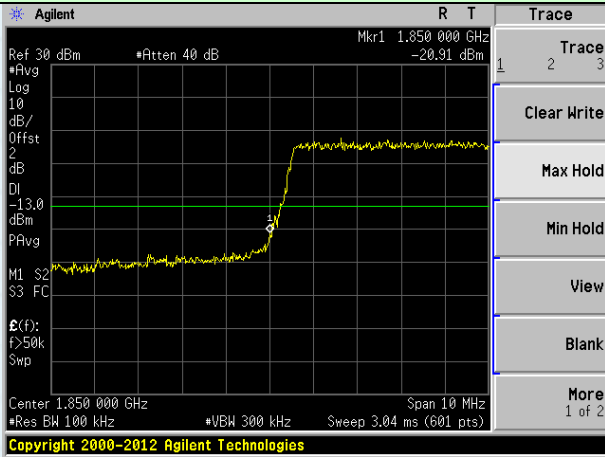

Lowest channel

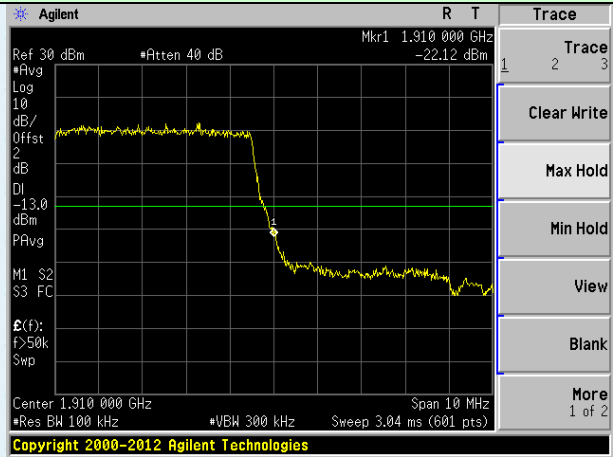

Highest channel

15MHz Bandwidth (RB size:1# RB offset:0#) 15MHz Bandwidth (RB size:1# RB offset:74#)

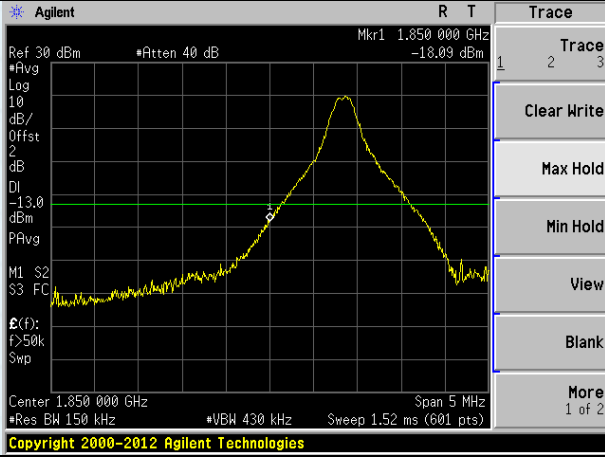

Lowest channel

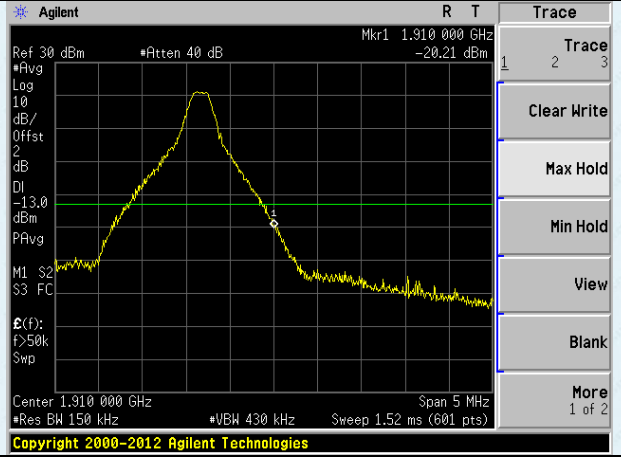

Highest channel

15MHz Bandwidth (RB size:36# RB offset:0#) 15MHz Bandwidth (RB size:36# RB offset:39#)

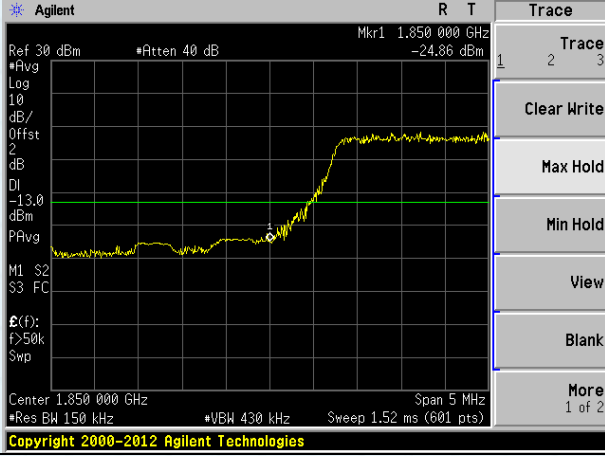

Lowest channel

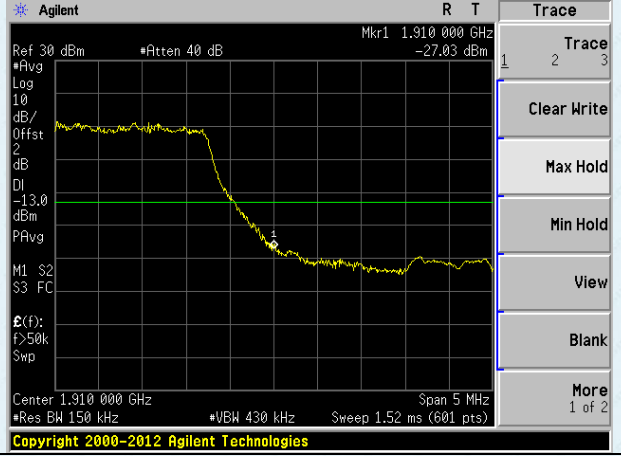

Highest channel

15MHz Bandwidth (RB size:75# RB offset:0#) 15MHz Bandwidth (RB size:75# RB offset:0#)

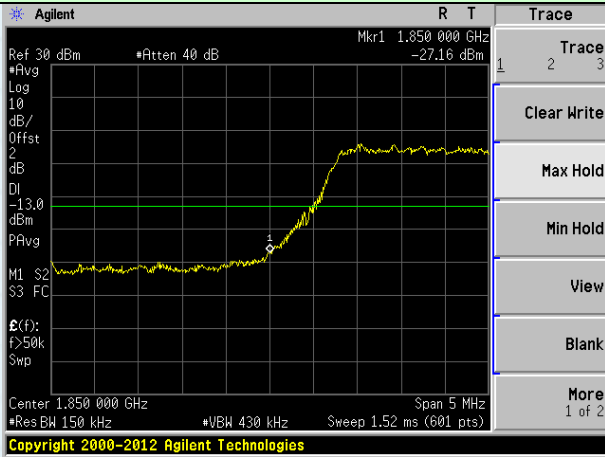

Lowest channel

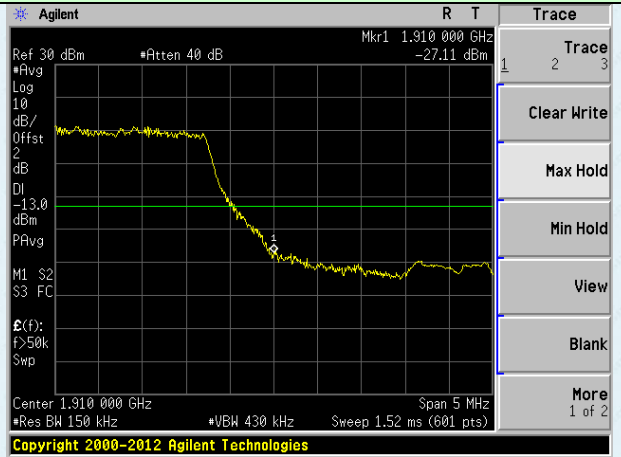

Highest channel

20MHz Bandwidth (RB size:1# RB offset:0#) 20MHz Bandwidth (RB size:1# RB offset:99#)

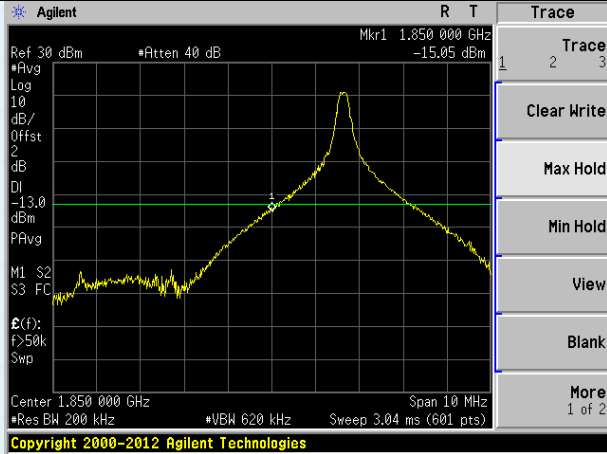

Lowest channel

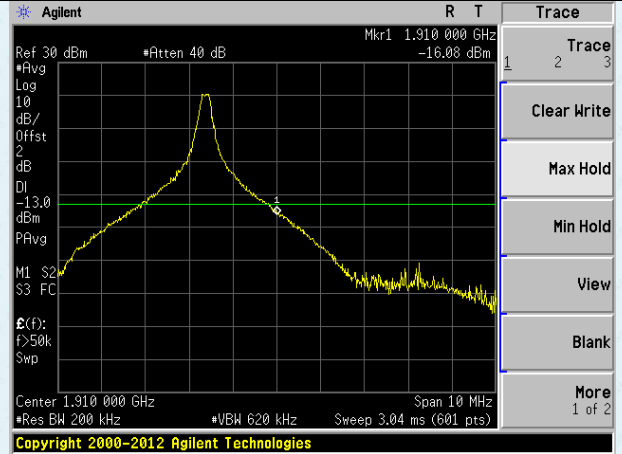

Highest channel

20MHz Bandwidth (RB size:50# RB offset:0#) 20MHz Bandwidth (RB size:50# RB offset:50#)

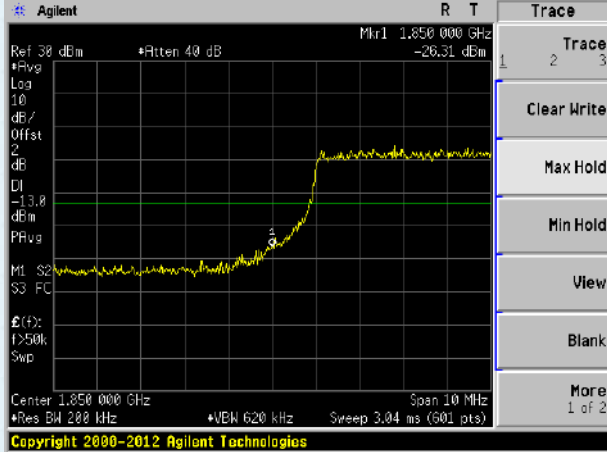

Lowest channel

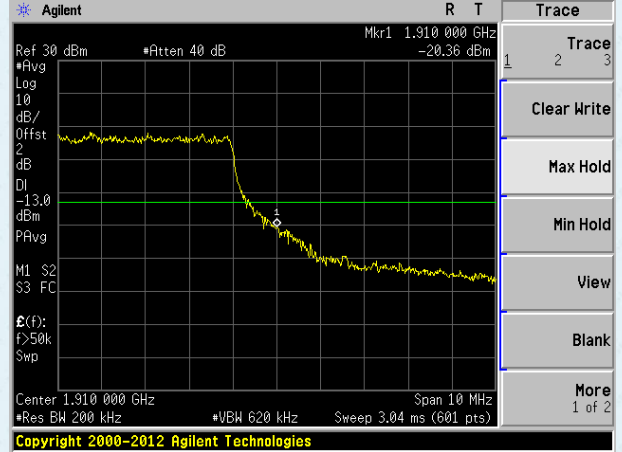

Highest channel

20MHz Bandwidth (RB size:100# RB offset:0#) 20MHz Bandwidth (RB size:100# RB offset:0#)

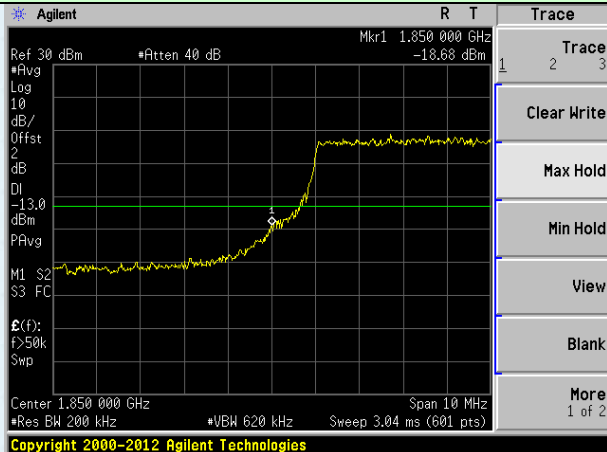

Lowest channel

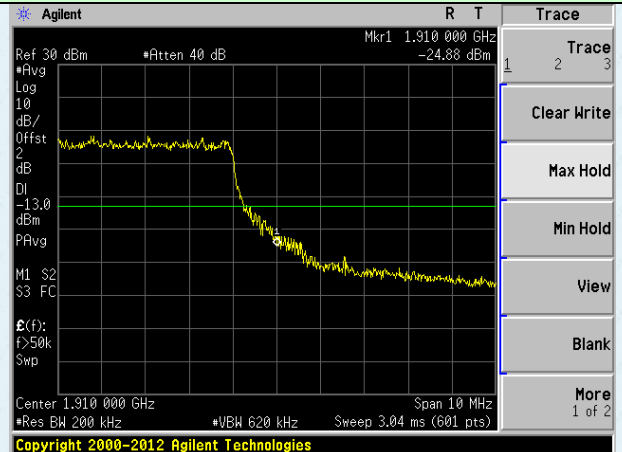

Highest channel

LTE Band 4(QPSK mode)

1.4MHz Bandwidth (RB size:1# RB offset:0#)

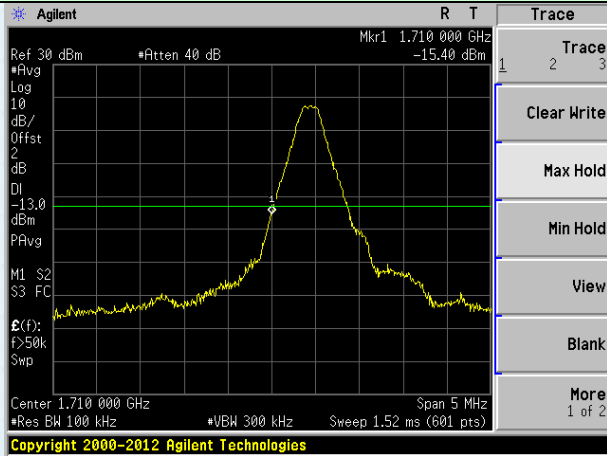

Lowest channel

1.4MHz Bandwidth (RB size:1# RB offset:5#)

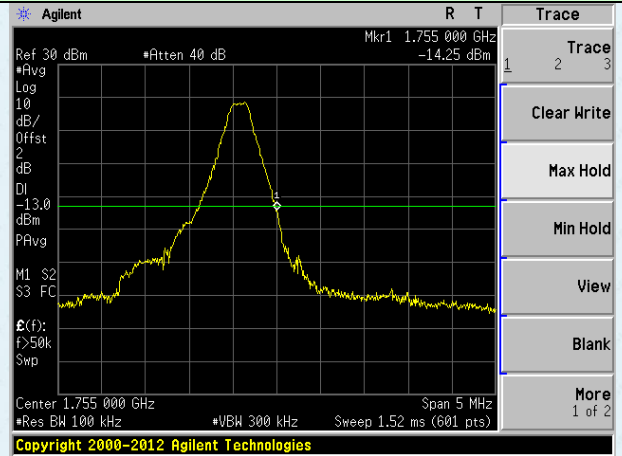

Highest channel

1.4MHz Bandwidth (RB size:3# RB offset:0#)

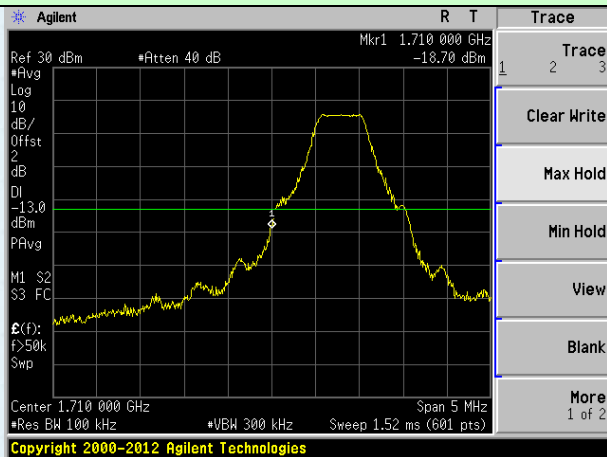

Lowest channel

1.4MHz Bandwidth (RB size:3# RB offset:2#)

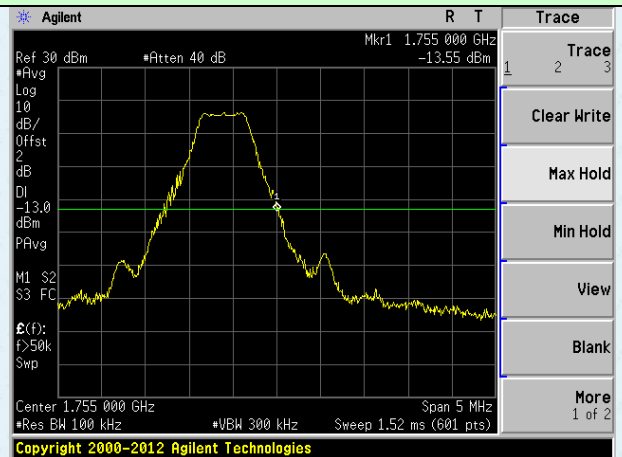

Highest channel

1.4MHz Bandwidth (RB size:6# RB offset:0#)

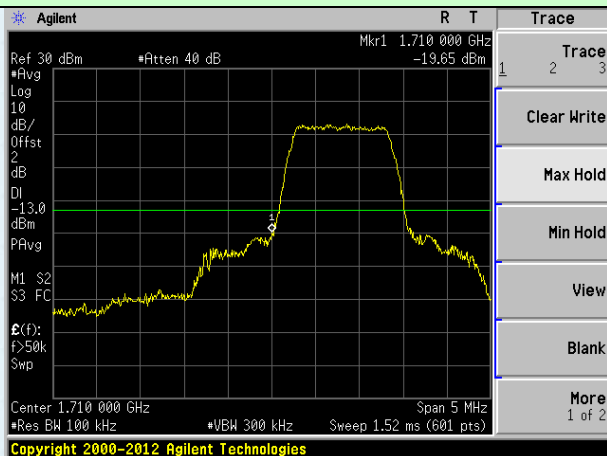

Lowest channel

1.4MHz Bandwidth (RB size:6# RB offset:0#)

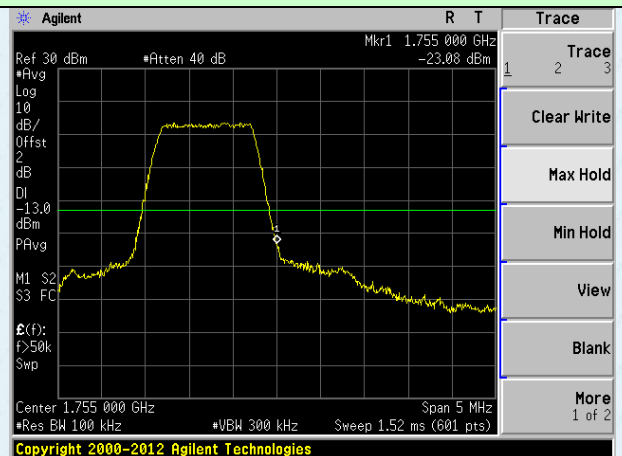

Highest channel

3MHz Bandwidth (RB size:1# RB offset:0#) **3MHz Bandwidth (RB size:1# RB offset:14#)**

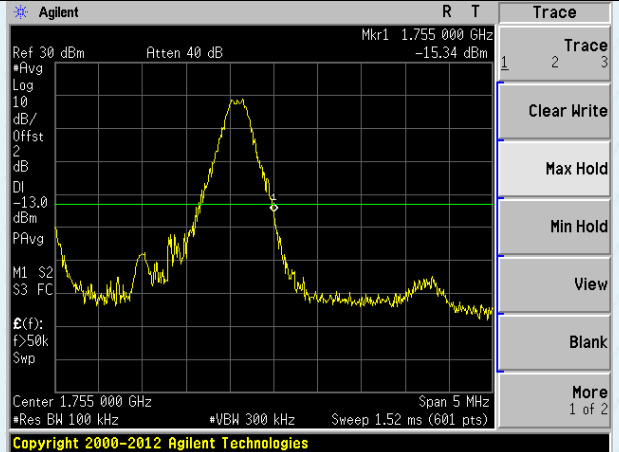
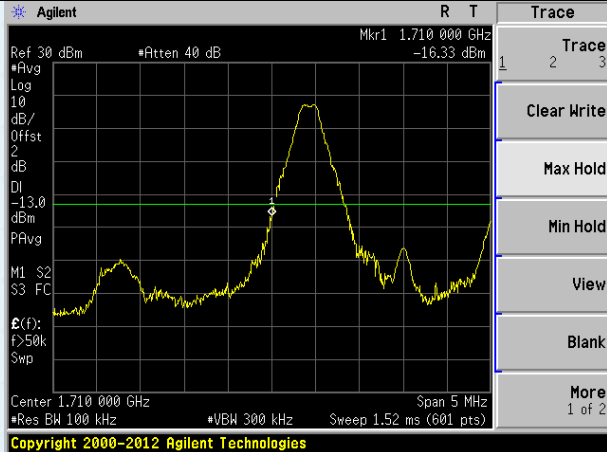

Lowest channel

Highest channel

3MHz Bandwidth (RB size:8# RB offset:0#) **3MHz Bandwidth (RB size:8# RB offset:7#)**

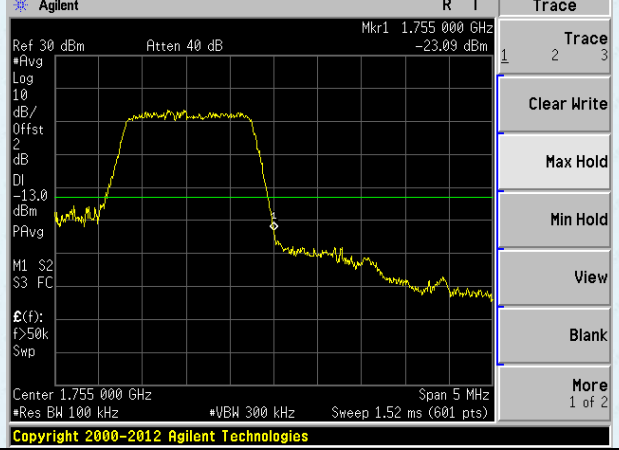
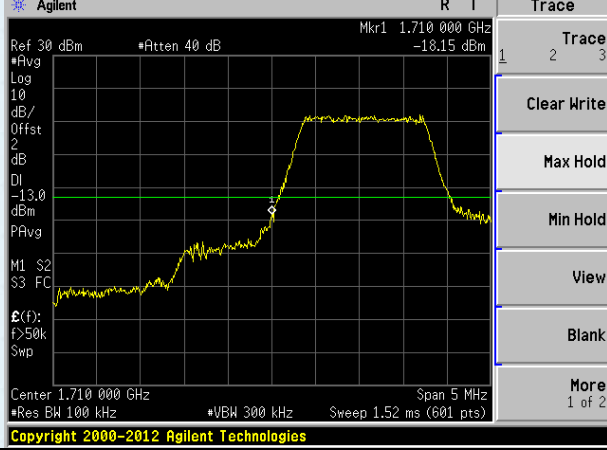

Lowest channel

Highest channel

3MHz Bandwidth (RB size:15# RB offset:0#) **3MHz Bandwidth (RB size:15# RB offset:0#)**

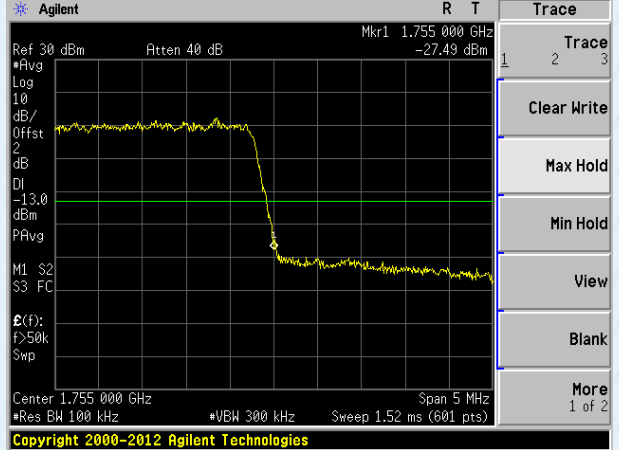
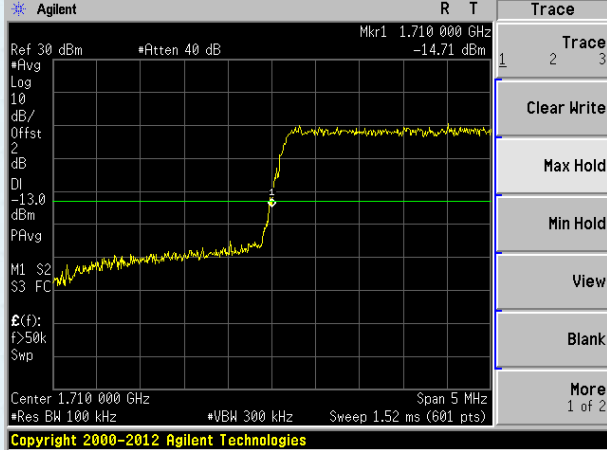

Lowest channel

Highest channel

5MHz Bandwidth (RB size:1# RB offset:0#) 5MHz Bandwidth (RB size:1# RB offset:24#)

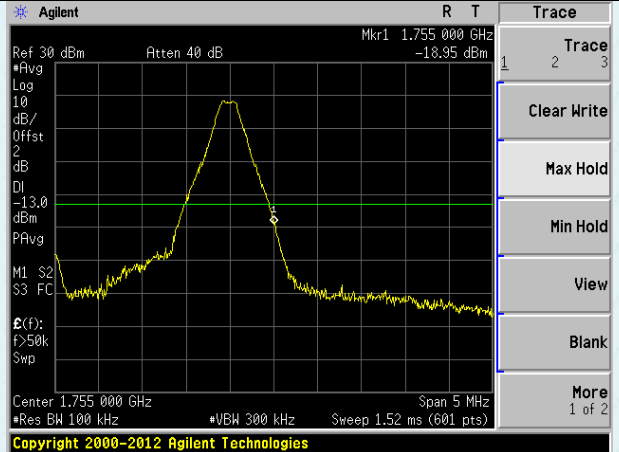
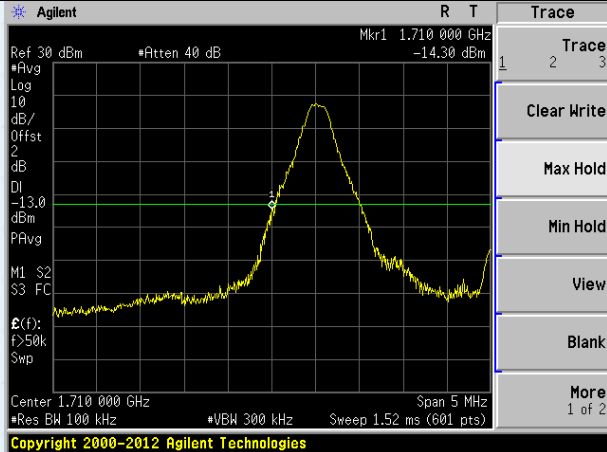

Lowest channel

Highest channel

5MHz Bandwidth (RB size:12# RB offset:0#) 5MHz Bandwidth (RB size:12# RB offset:13#)

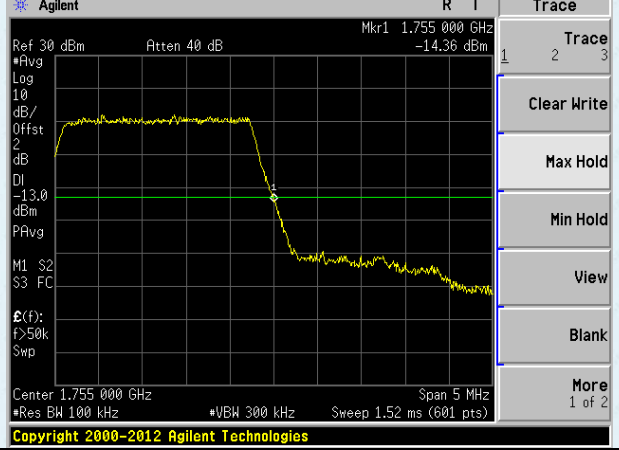
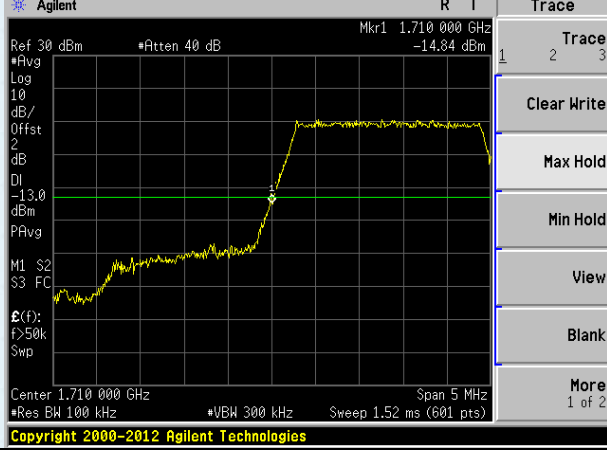

Lowest channel

Highest channel

5MHz Bandwidth (RB size:25# RB offset:0#) 5MHz Bandwidth (RB size:25# RB offset:0#)

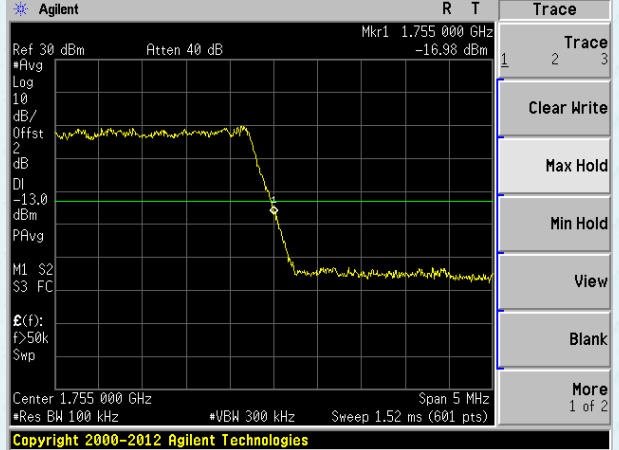
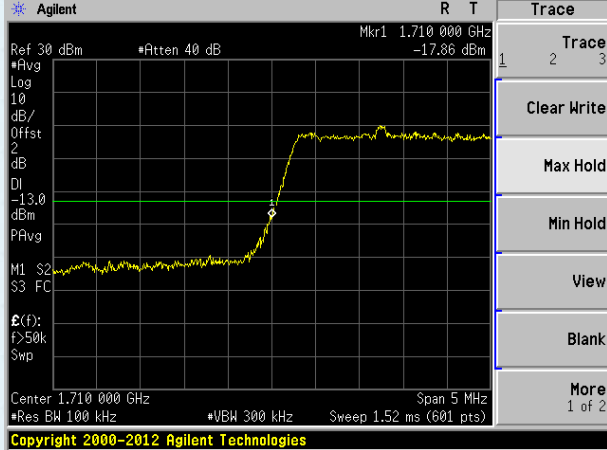

Lowest channel

Highest channel

10MHz Bandwidth (RB size:1# RB offset:0#) 10MHz Bandwidth (RB size:1# RB offset:49#)

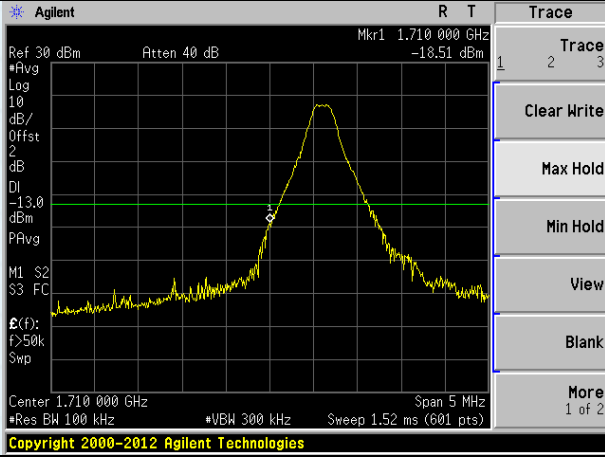

Lowest channel

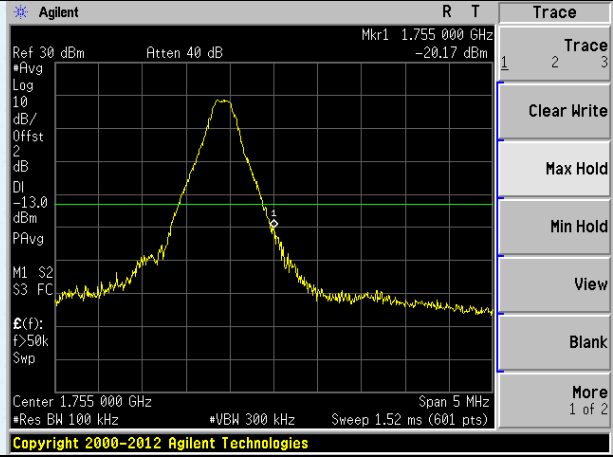

Highest channel

10MHz Bandwidth (RB size:25# RB offset:0#) 10MHz Bandwidth (RB size:25# RB offset:25#)

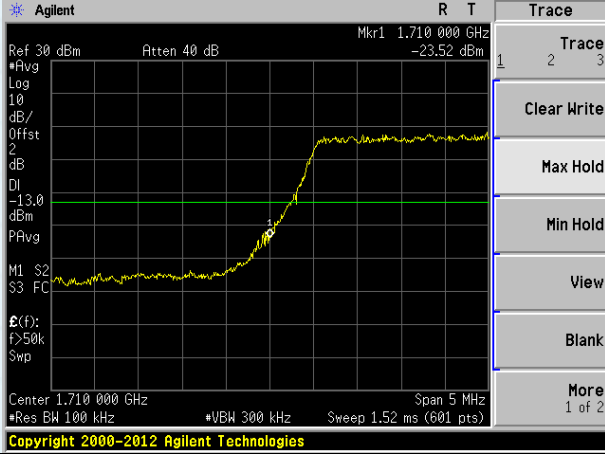

Lowest channel

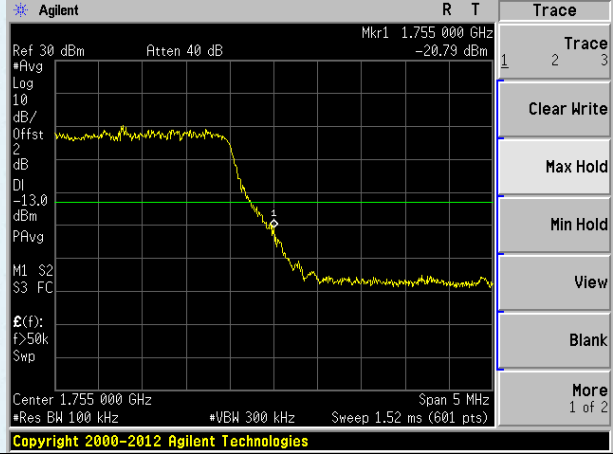

Highest channel

10MHz Bandwidth (RB size:50# RB offset:0#) 10MHz Bandwidth (RB size:50# RB offset:0#)

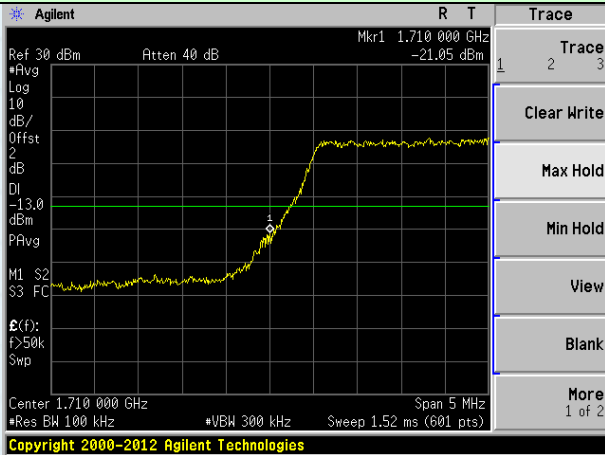

Lowest channel

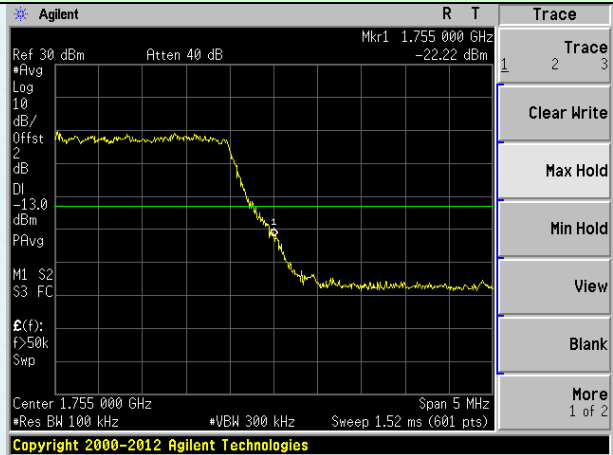

Highest channel

15MHz Bandwidth (RB size:1# RB offset:0#) 15MHz Bandwidth (RB size:1# RB offset:74#)

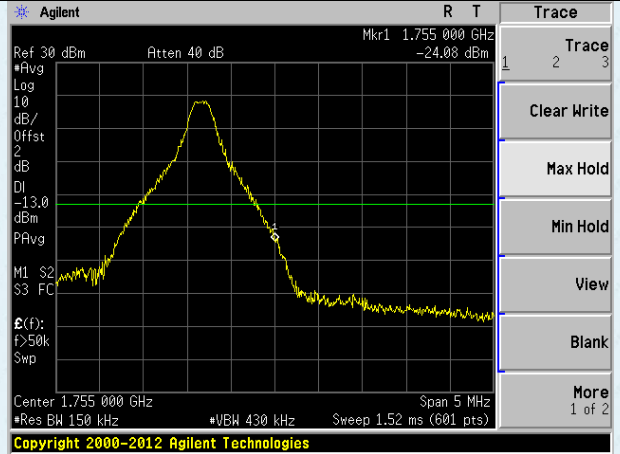
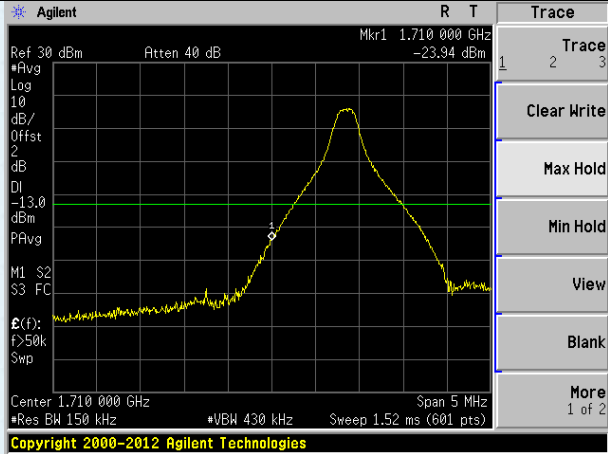

Lowest channel

Highest channel

15MHz Bandwidth (RB size:36# RB offset:0#) 15MHz Bandwidth (RB size:36# RB offset:39#)

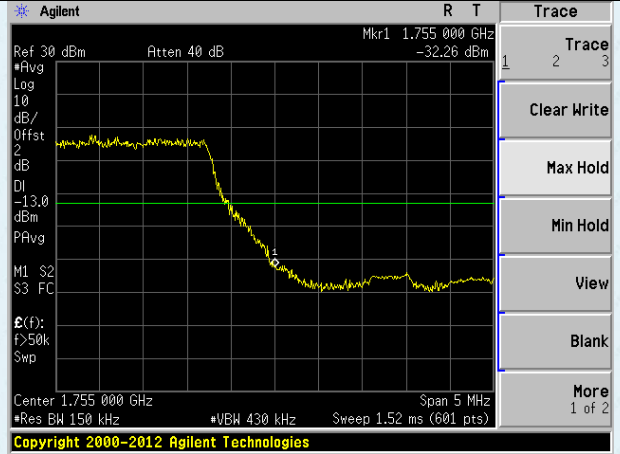
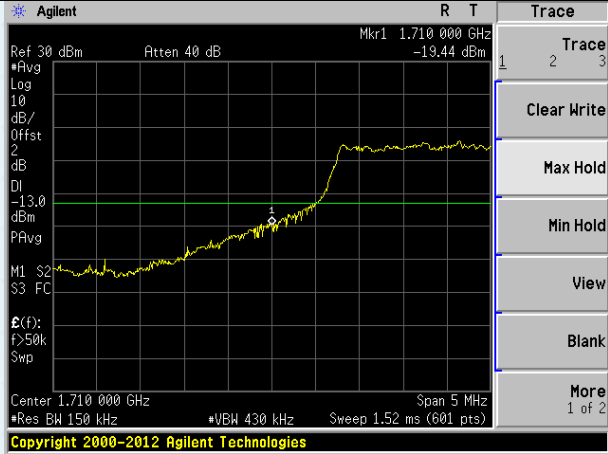

Lowest channel

Highest channel

15MHz Bandwidth (RB size:75# RB offset:0#) 15MHz Bandwidth (RB size:75# RB offset:0#)

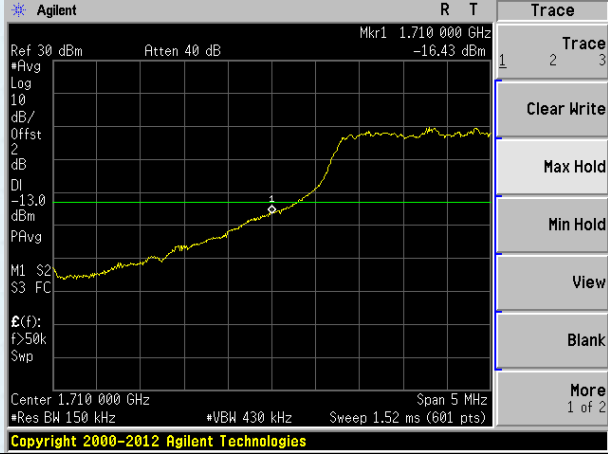

Lowest channel

Highest channel

20MHz Bandwidth (RB size:1# RB offset:0#) 20MHz Bandwidth (RB size:1# RB offset:99#)

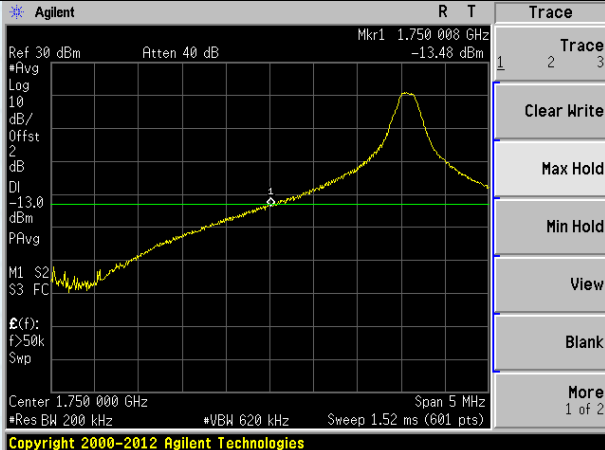

Lowest channel

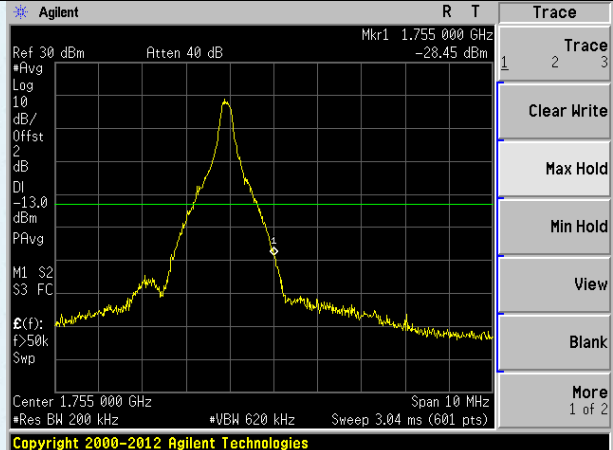

Highest channel

20MHz Bandwidth (RB size:50# RB offset:0#) 20MHz Bandwidth (RB size:50# RB offset:50#)

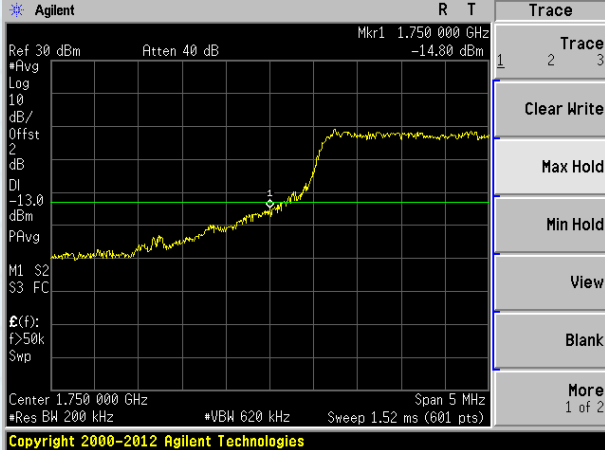

Lowest channel

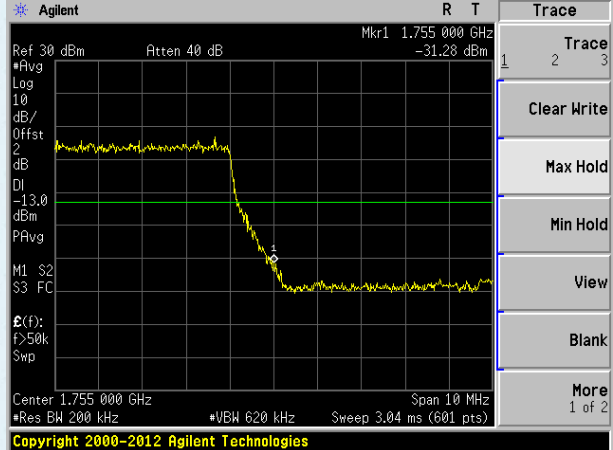

Highest channel

20MHz Bandwidth (RB size:100# RB offset:0#) 20MHz Bandwidth (RB size:100# RB offset:0#)

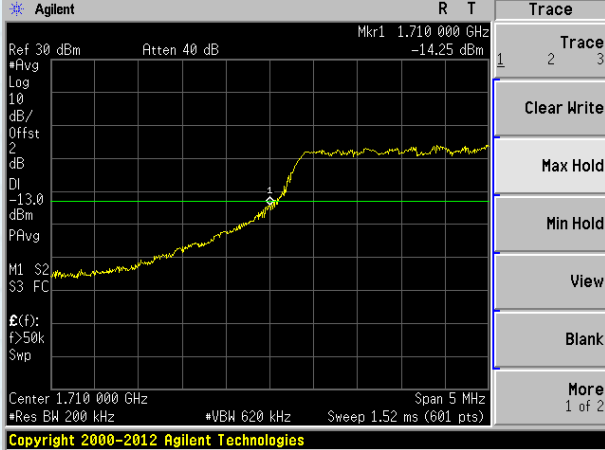

Lowest channel

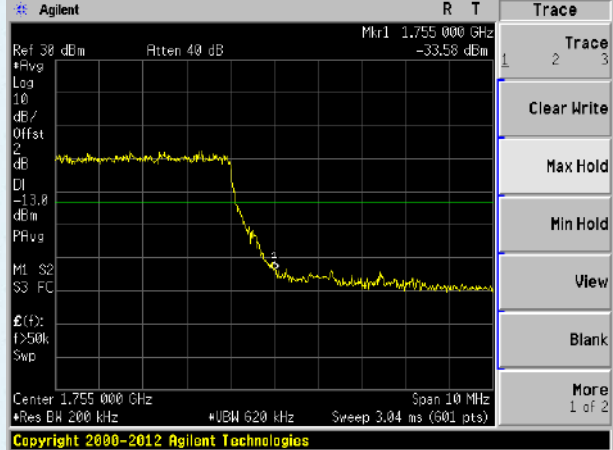

Highest channel

LTE Band 12(QPSK mode)

1.4MHz Bandwidth (RB size:1# RB offset:0#)

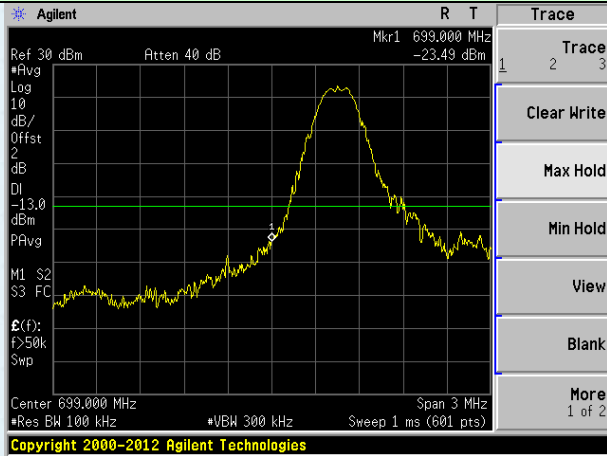

Lowest channel

1.4MHz Bandwidth (RB size:1# RB offset:5#)

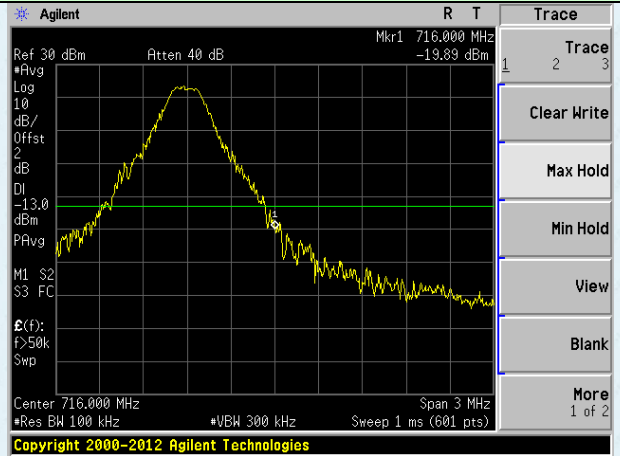

Highest channel

1.4MHz Bandwidth (RB size:3# RB offset:0#)

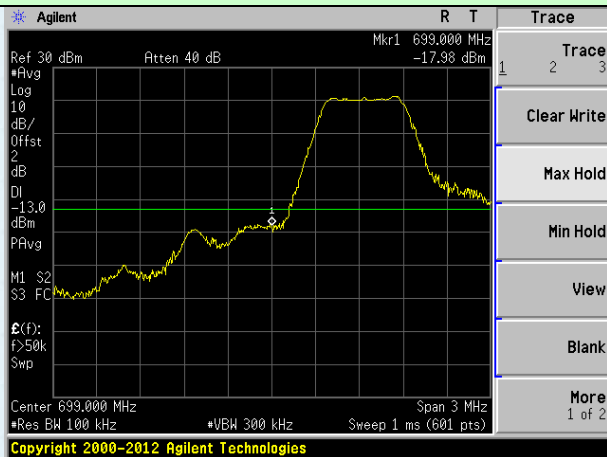

Lowest channel

1.4MHz Bandwidth (RB size:3# RB offset:2#)



Highest channel

1.4MHz Bandwidth (RB size:6# RB offset:0#)

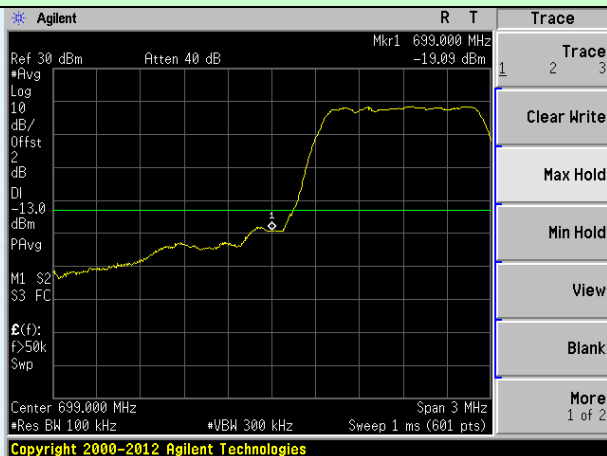

Lowest channel

1.4MHz Bandwidth (RB size:6# RB offset:0#)

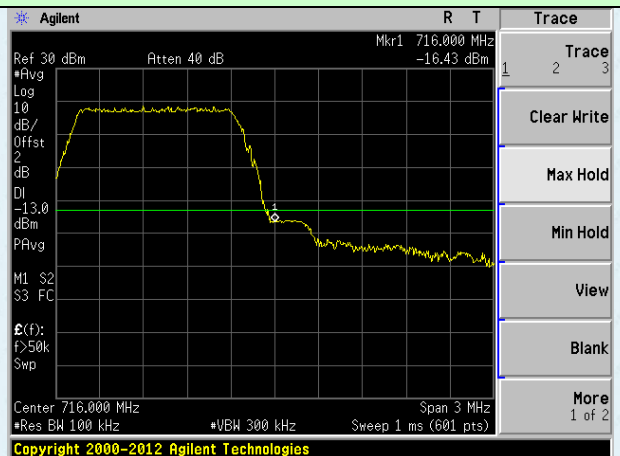

Highest channel

3MHz Bandwidth (RB size:1# RB offset:0#) **3MHz Bandwidth (RB size:1# RB offset:14#)**



Lowest channel

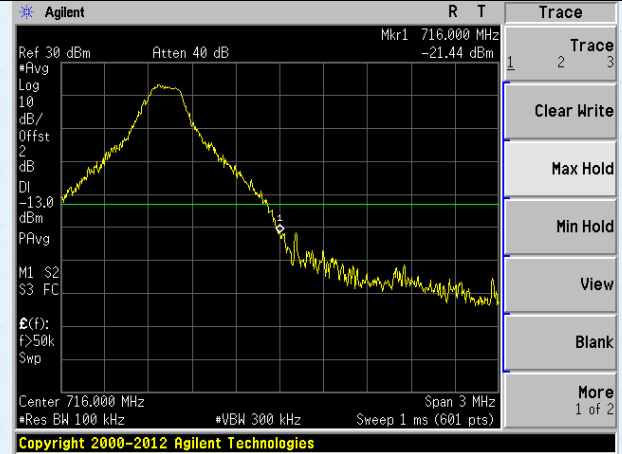

Highest channel

3MHz Bandwidth (RB size:8# RB offset:0#) **3MHz Bandwidth (RB size:8# RB offset:7#)**

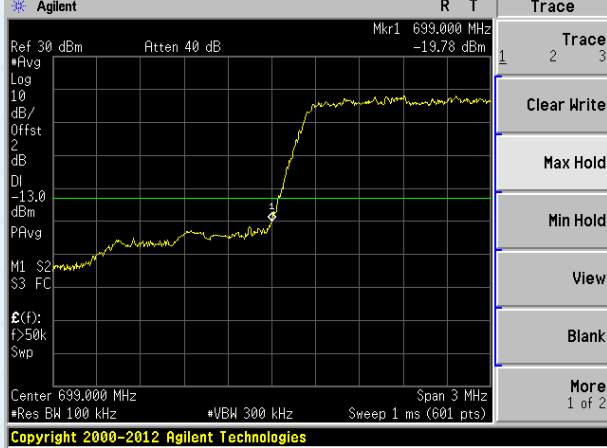

Lowest channel

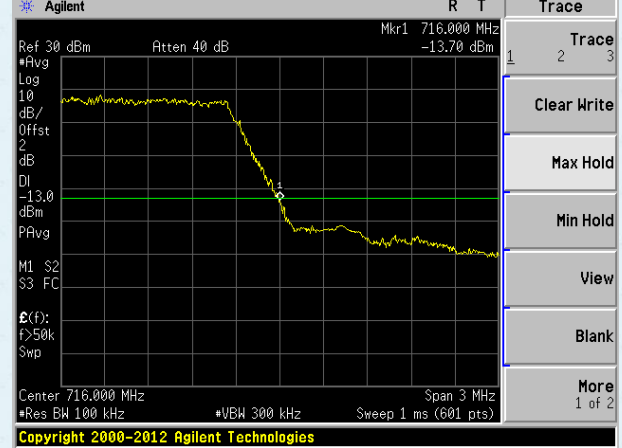

Highest channel

3MHz Bandwidth (RB size:15# RB offset:0#) **3MHz Bandwidth (RB size:15# RB offset:0#)**

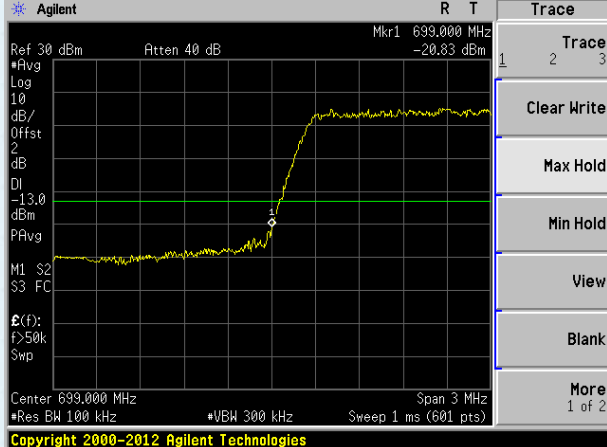

Lowest channel

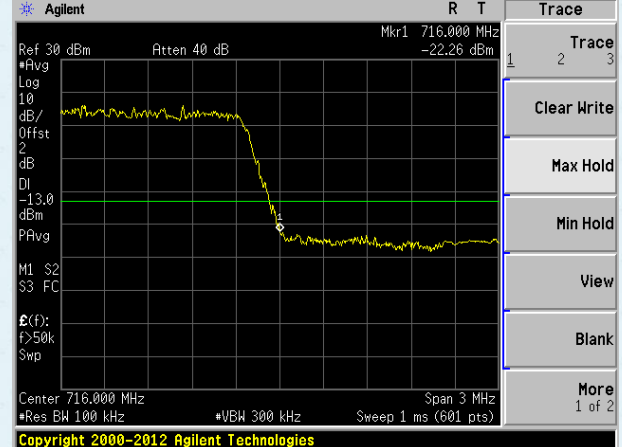

Highest channel

5MHz Bandwidth (RB size:1# RB offset:0#) 5MHz Bandwidth (RB size:1# RB offset:24#)

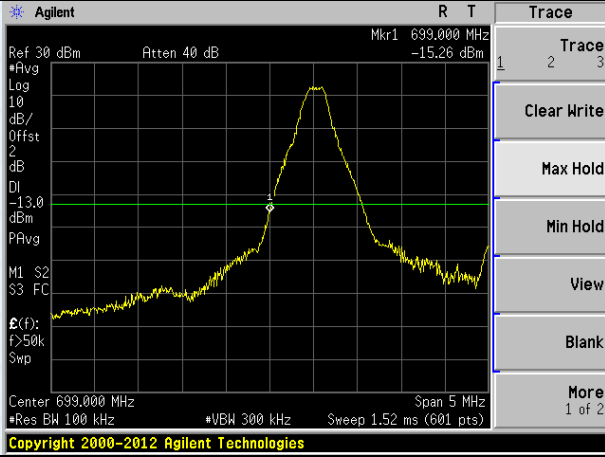

Lowest channel

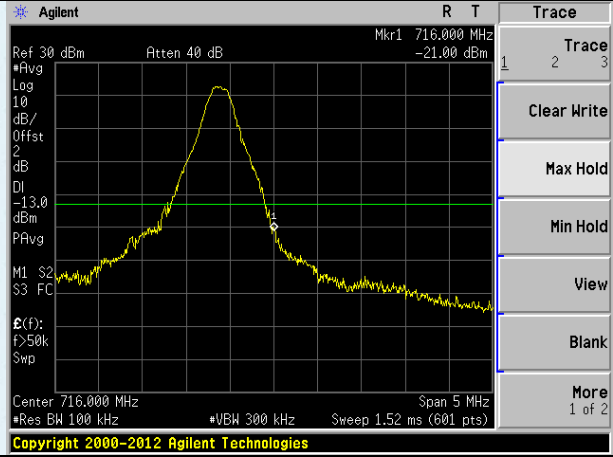

Highest channel

5MHz Bandwidth (RB size:12# RB offset:0#) 5MHz Bandwidth (RB size:12# RB offset:13#)

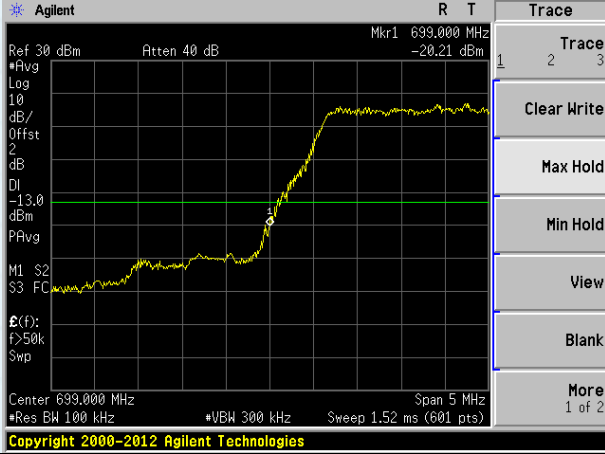

Lowest channel

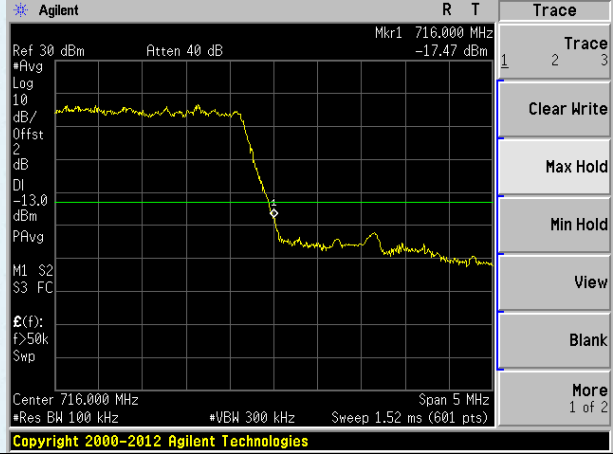

Highest channel

5MHz Bandwidth (RB size:25# RB offset:0#) 5MHz Bandwidth (RB size:25# RB offset:0#)

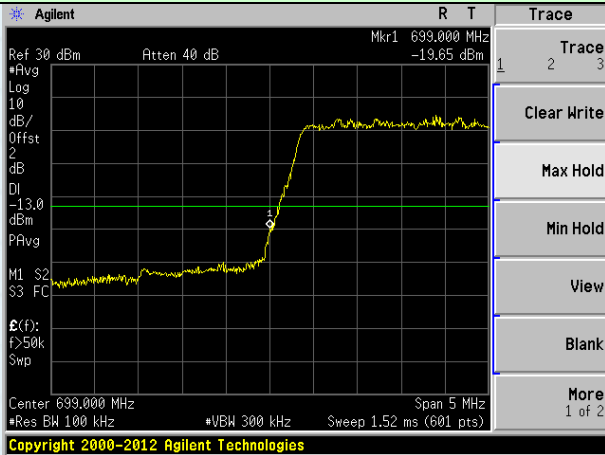

Lowest channel

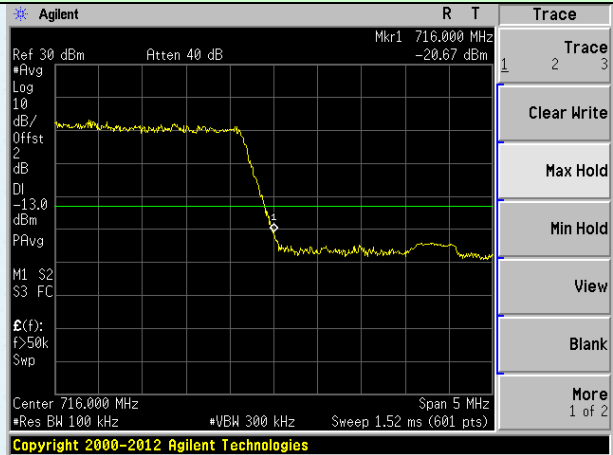

Highest channel

10MHz Bandwidth (RB size:1# RB offset:0#) 10MHz Bandwidth (RB size:1# RB offset:49#)

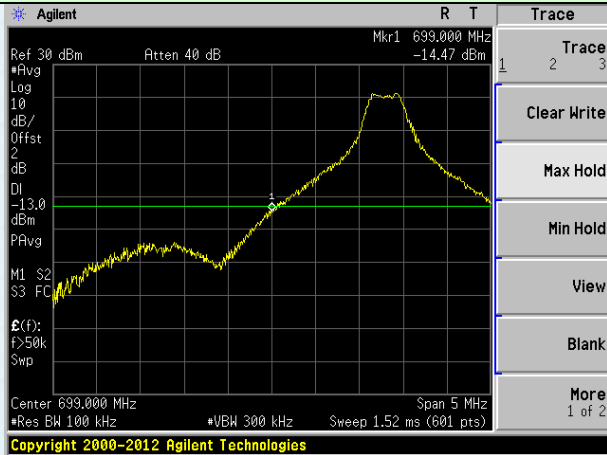

Lowest channel

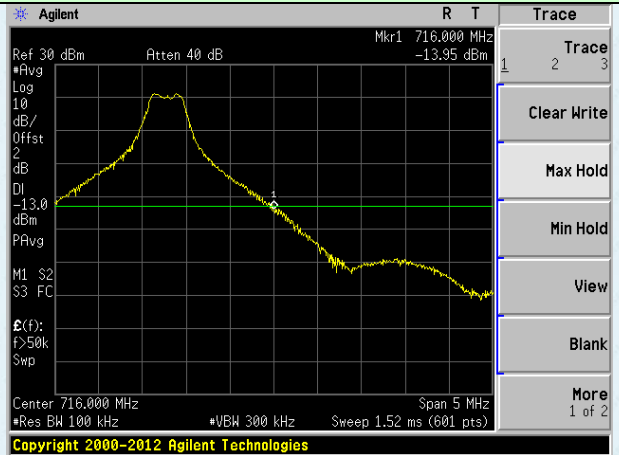

Highest channel

10MHz Bandwidth (RB size:25# RB offset:0#) 10MHz Bandwidth (RB size:25# RB offset:25#)

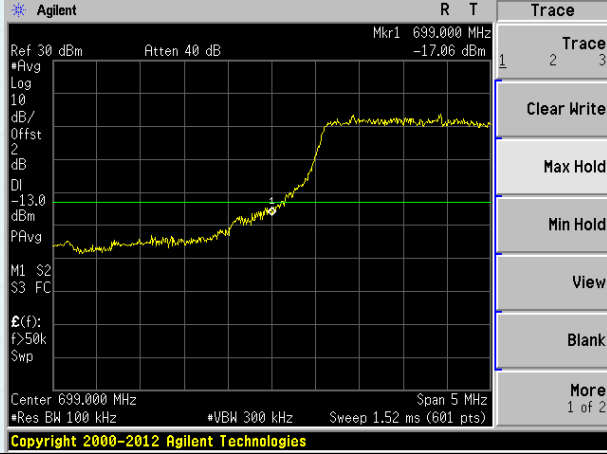

Lowest channel

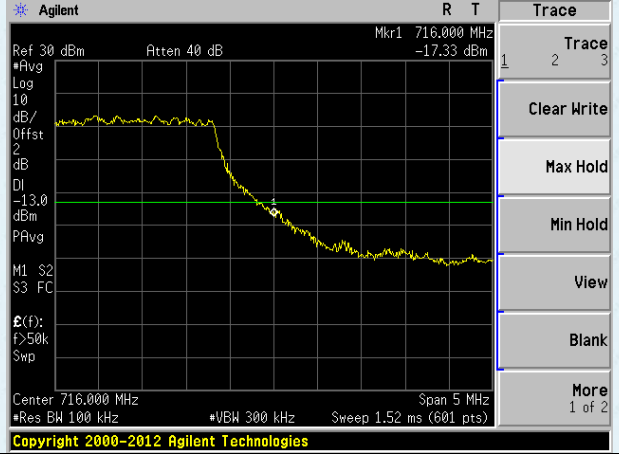

Highest channel

10MHz Bandwidth (RB size:50# RB offset:0#) 10MHz Bandwidth (RB size:50# RB offset:0#)

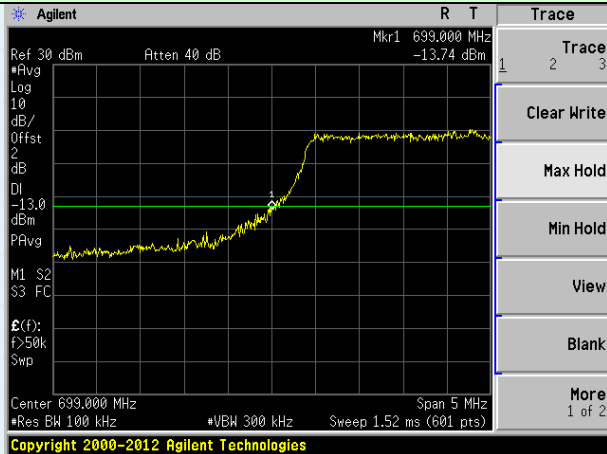

Lowest channel

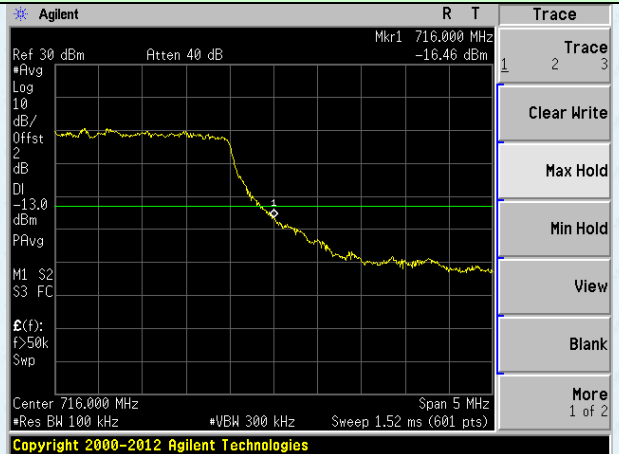

Highest channel

LTE Band 2 (16QAM mode):

1.4MHz Bandwidth (RB size:1# RB offset:0#)

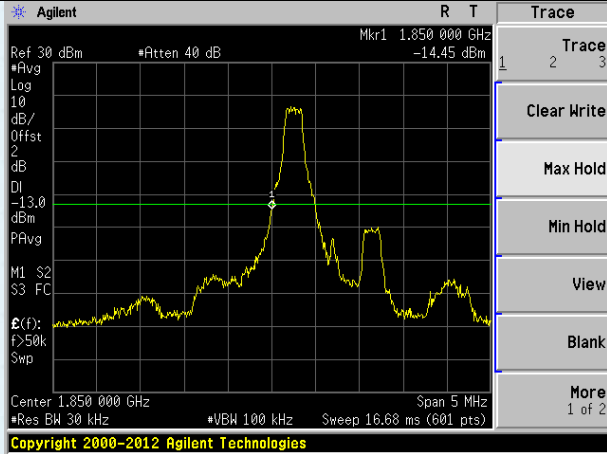

Lowest channel

1.4MHz Bandwidth (RB size:1# RB offset:5#)

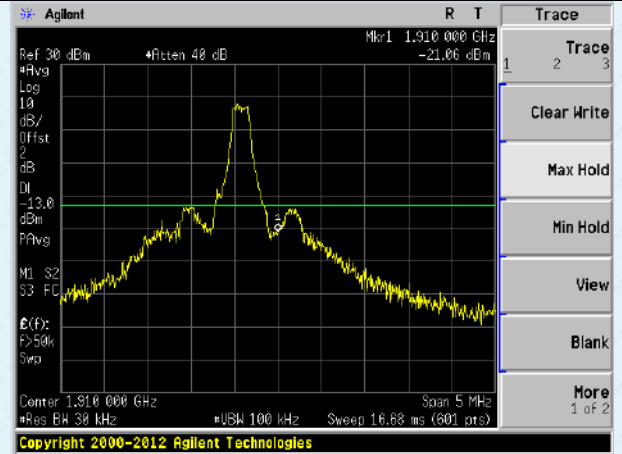

Highest channel

1.4MHz Bandwidth (RB size:3# RB offset:0#)

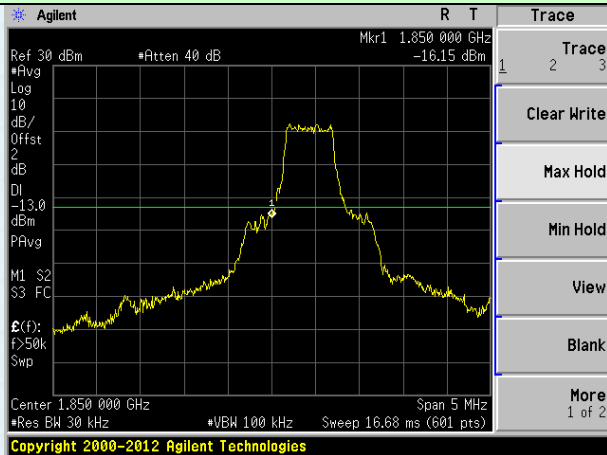

Lowest channel

1.4MHz Bandwidth (RB size:3# RB offset:2#)

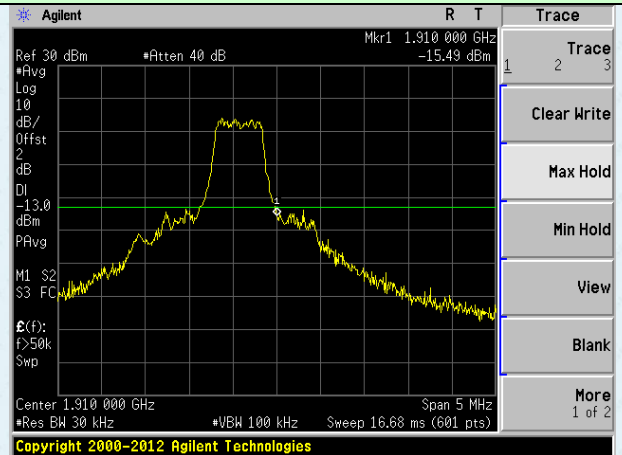

Highest channel

1.4MHz Bandwidth (RB size:6# RB offset:0#)

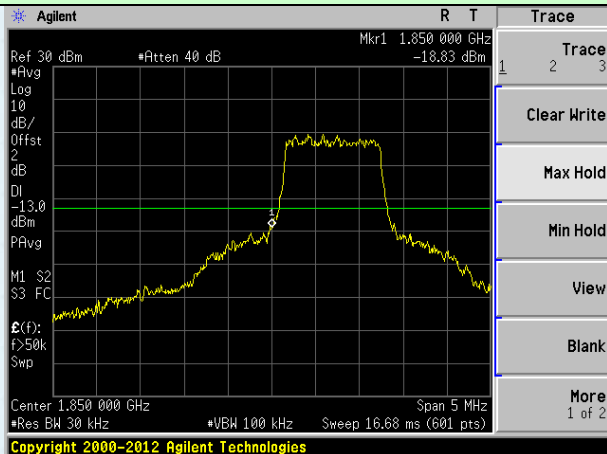

Lowest channel

1.4MHz Bandwidth (RB size:6# RB offset:0#)

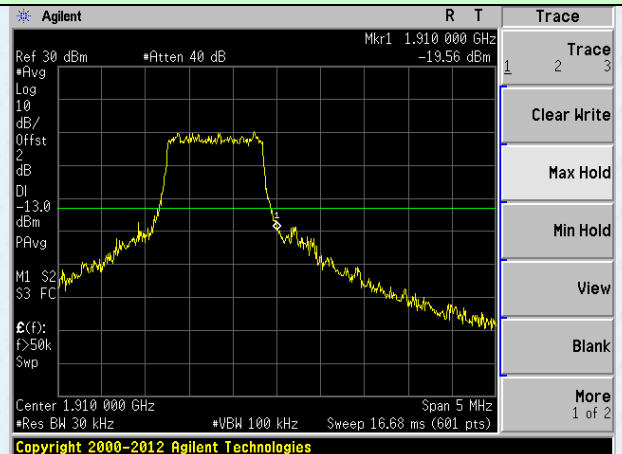

Highest channel

3MHz Bandwidth (RB size:1# RB offset:0#) 3MHz Bandwidth (RB size:1# RB offset:14#)

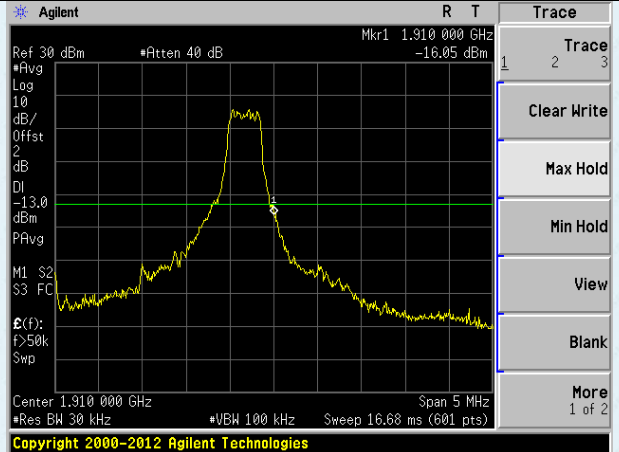
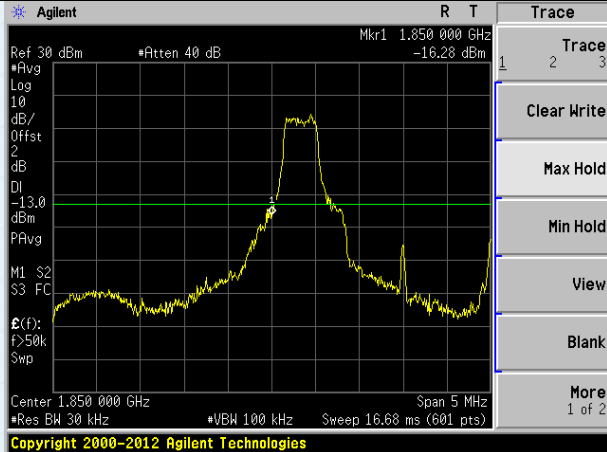

Lowest channel

Highest channel

3MHz Bandwidth (RB size:8# RB offset:0#) 3MHz Bandwidth (RB size:8# RB offset:7#)

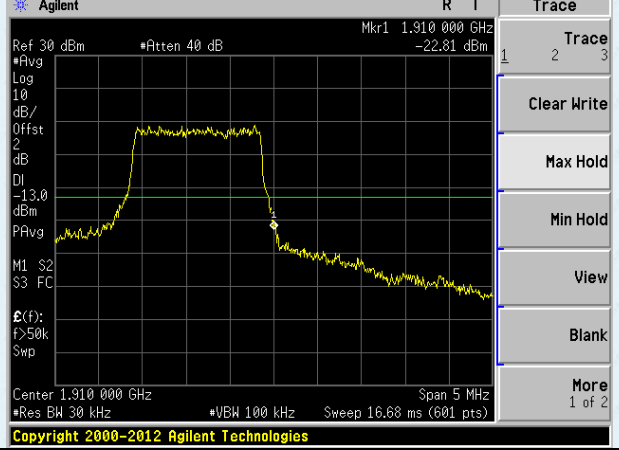
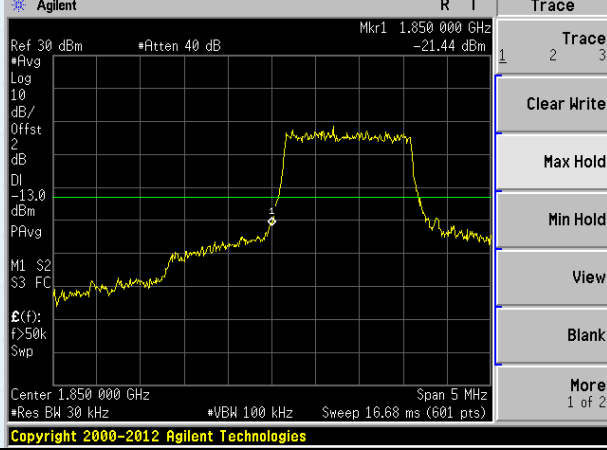

Lowest channel

Highest channel

3MHz Bandwidth (RB size:15# RB offset:0#) 3MHz Bandwidth (RB size:15# RB offset:0#)

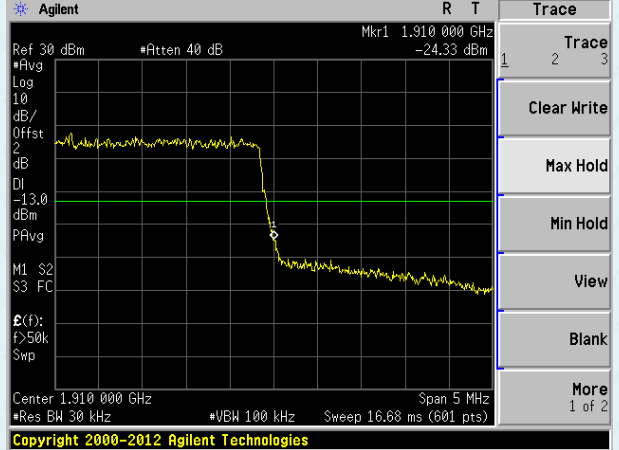
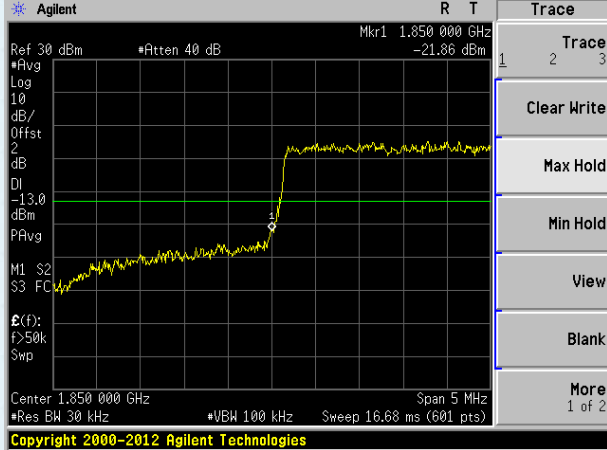

Lowest channel

Highest channel

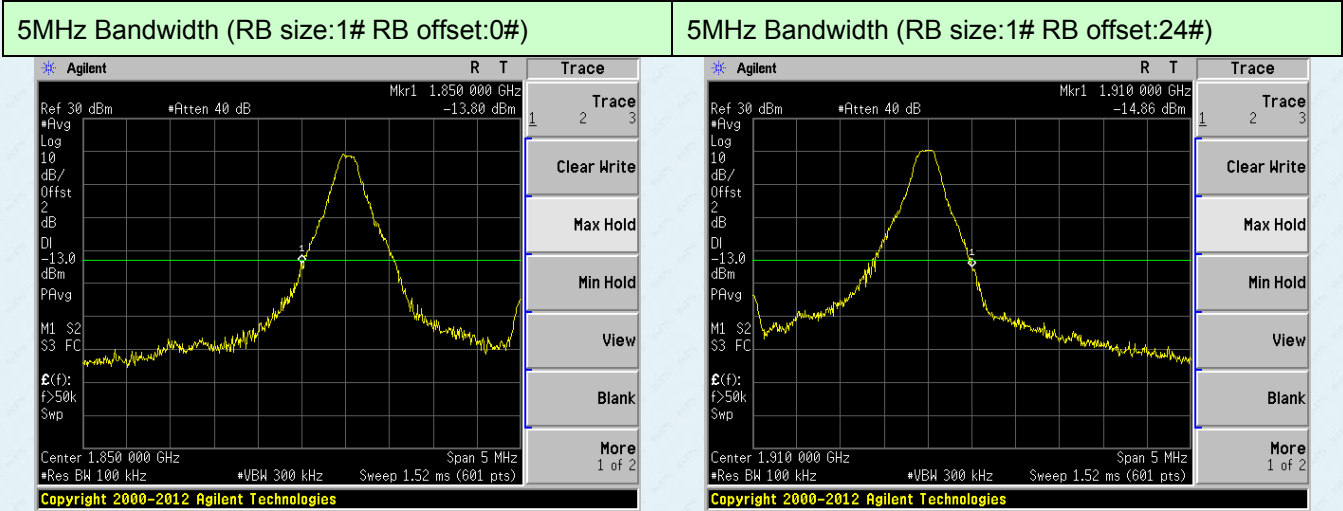

Lowest channel

Highest channel

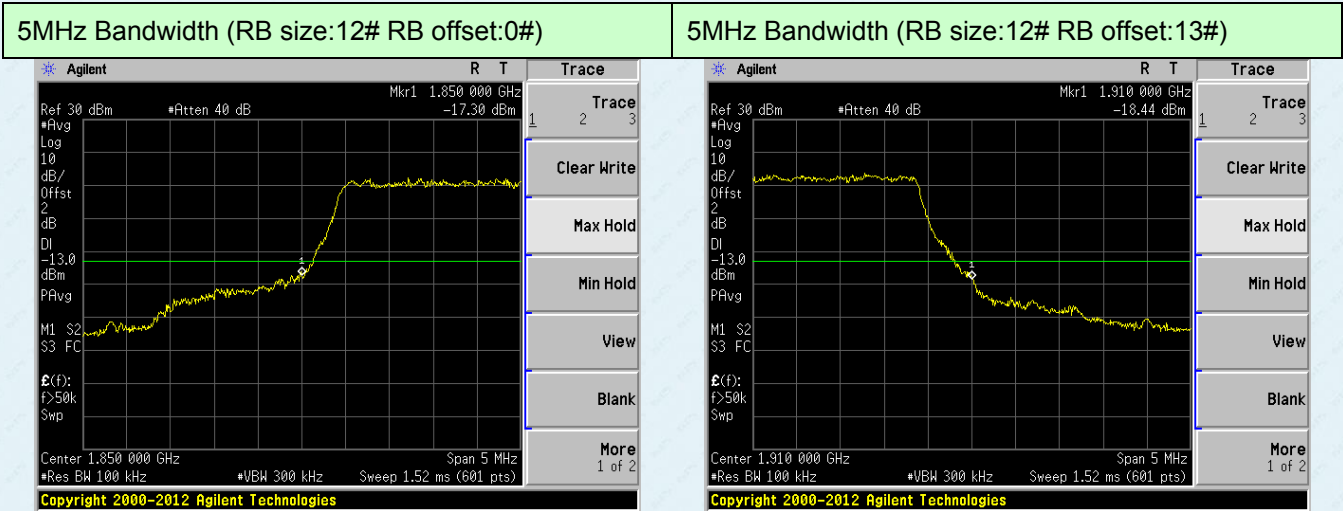

Lowest channel

Highest channel

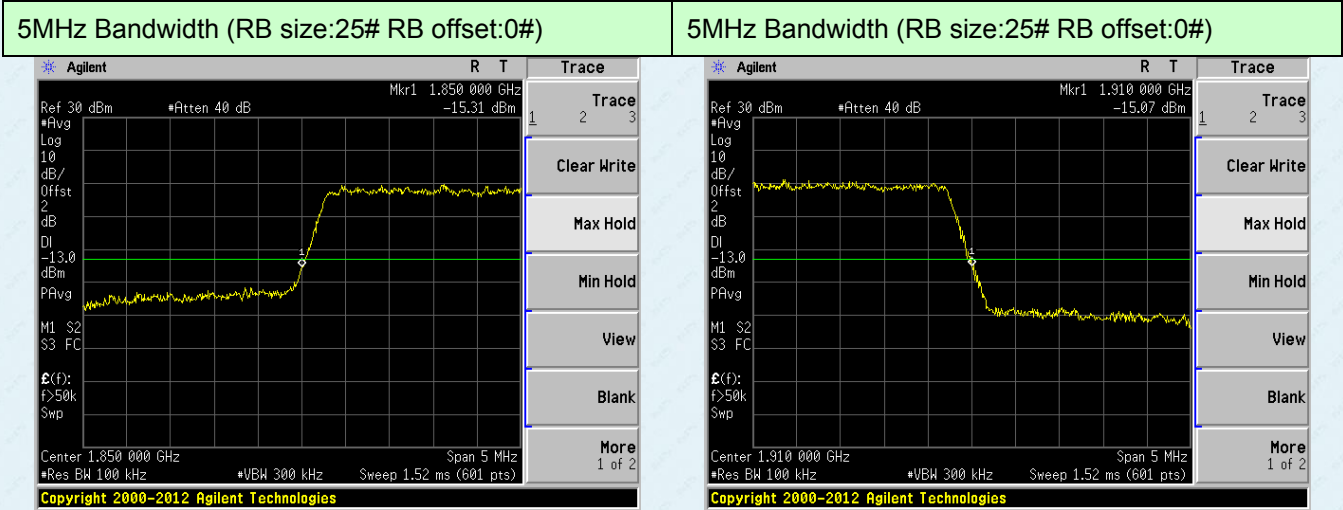

Lowest channel

Highest channel

10MHz Bandwidth (RB size:1# RB offset:0#) 10MHz Bandwidth (RB size:1# RB offset:49#)

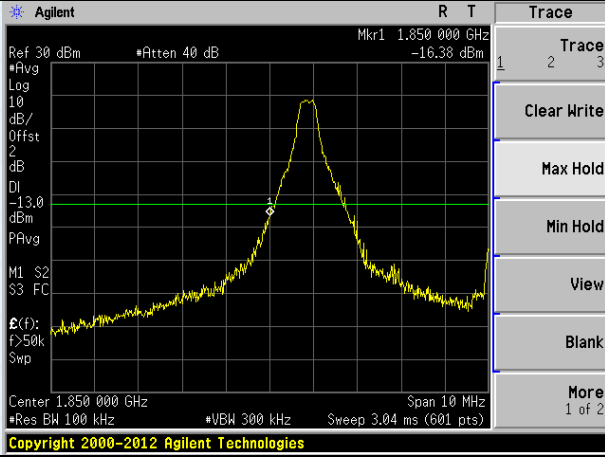

Lowest channel

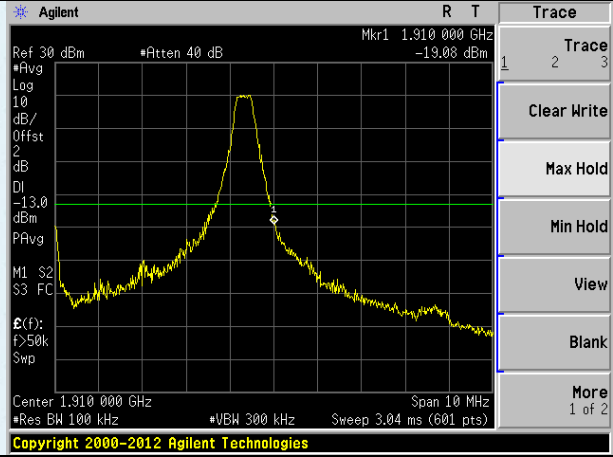

Highest channel

10MHz Bandwidth (RB size:25# RB offset:0#) 10MHz Bandwidth (RB size:25# RB offset:25#)

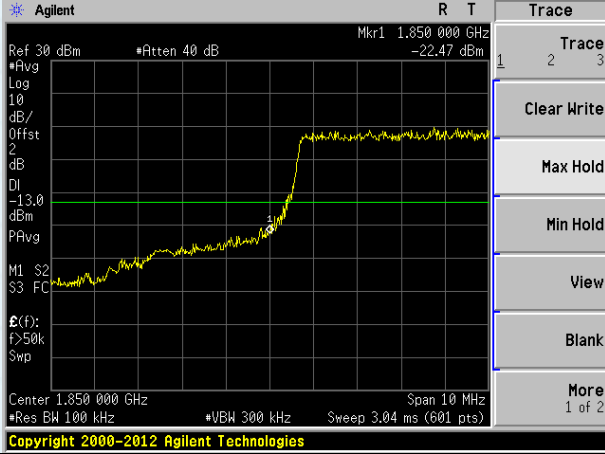

Lowest channel

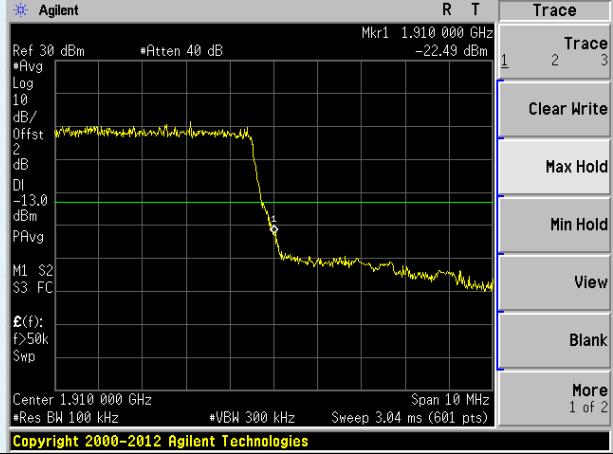

Highest channel

10MHz Bandwidth (RB size:50# RB offset:0#) 10MHz Bandwidth (RB size:50# RB offset:0#)

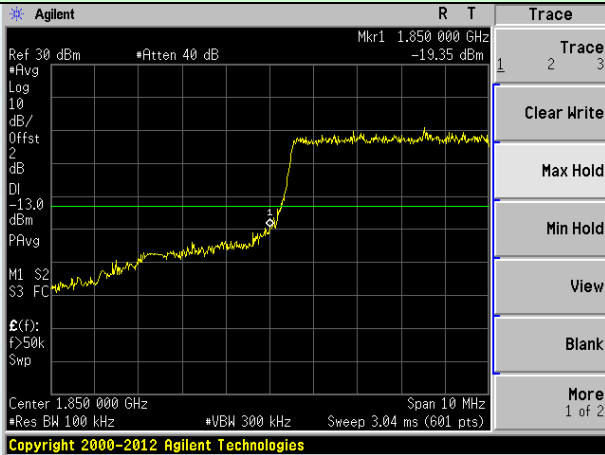

Lowest channel

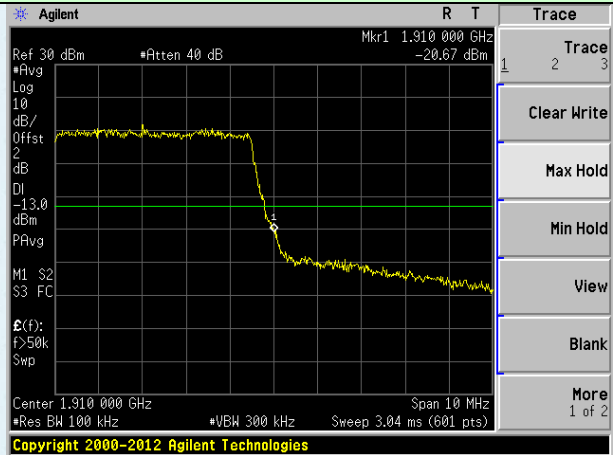

Highest channel

15MHz Bandwidth (RB size:1# RB offset:0#) 15MHz Bandwidth (RB size:1# RB offset:74#)

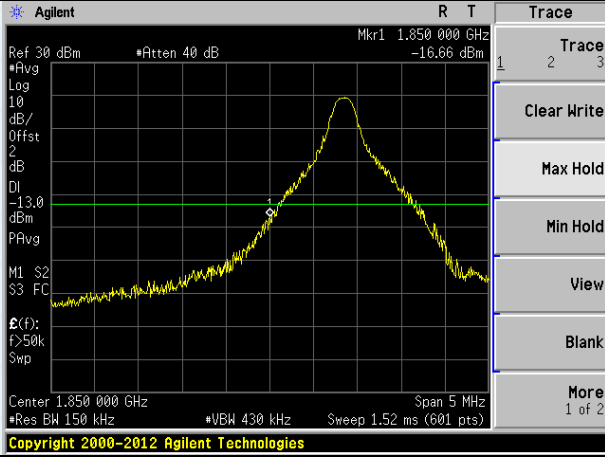

Lowest channel

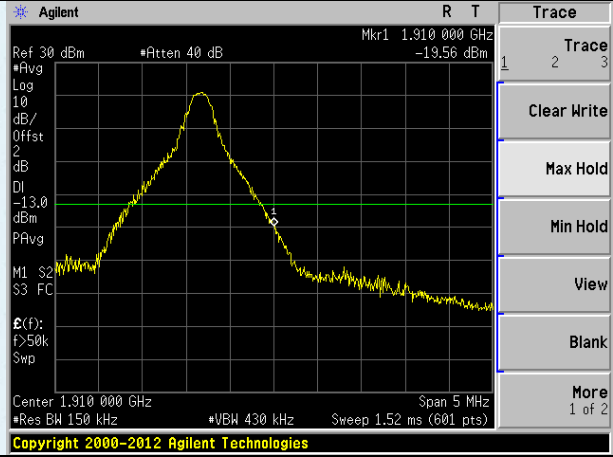

Highest channel

15MHz Bandwidth (RB size:36# RB offset:0#) 15MHz Bandwidth (RB size:36# RB offset:39#)

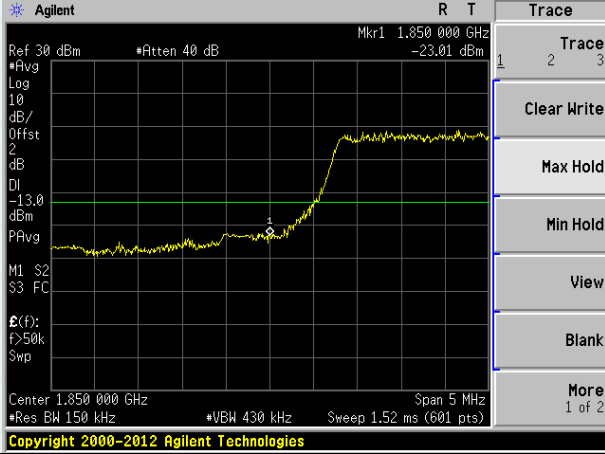

Lowest channel

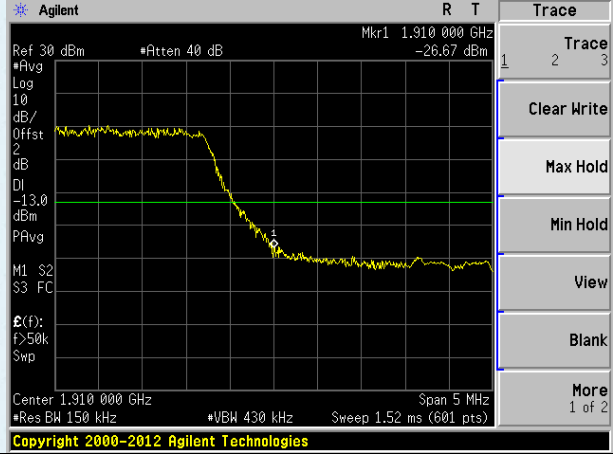

Highest channel

15MHz Bandwidth (RB size:75# RB offset:0#) 15MHz Bandwidth (RB size:75# RB offset:0#)

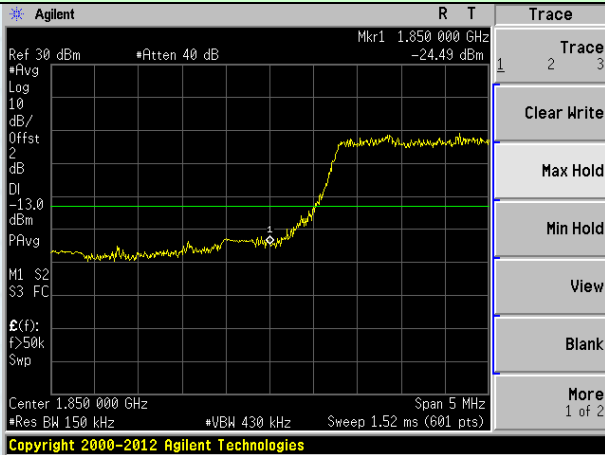

Lowest channel

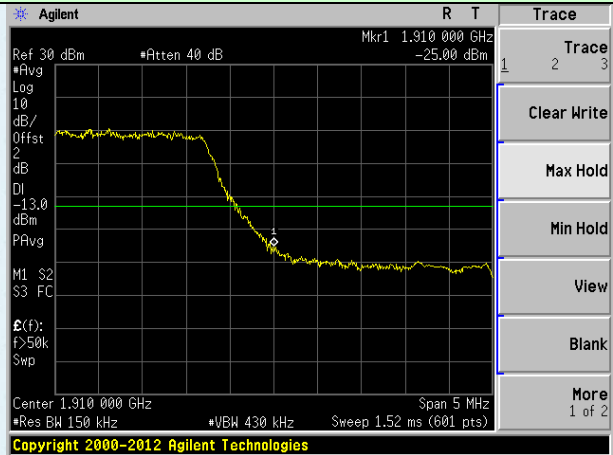

Highest channel

20MHz Bandwidth (RB size:1# RB offset:0#) 20MHz Bandwidth (RB size:1# RB offset:99#)

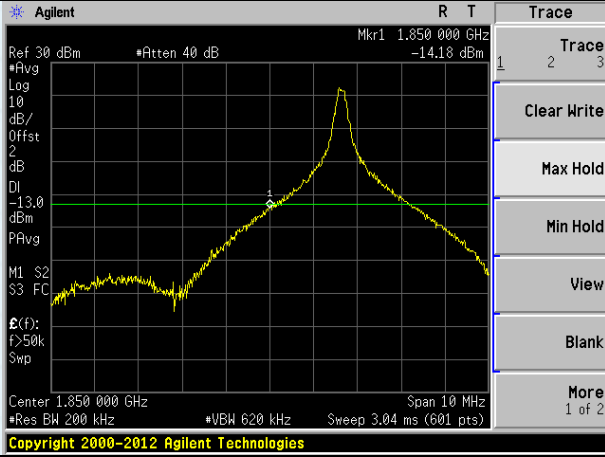

Lowest channel

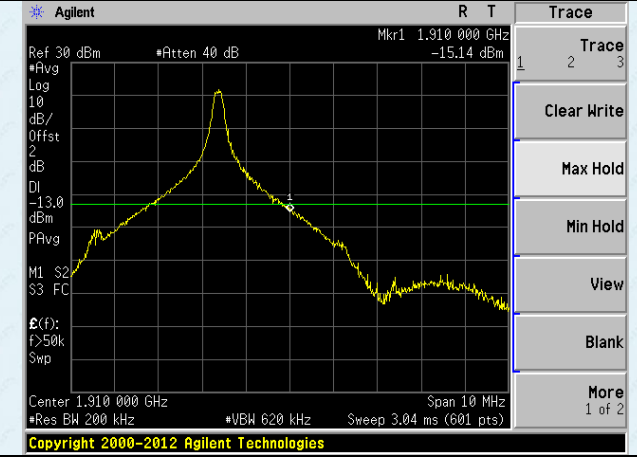

Highest channel

20MHz Bandwidth (RB size:50# RB offset:0#) 20MHz Bandwidth (RB size:50# RB offset:50#)

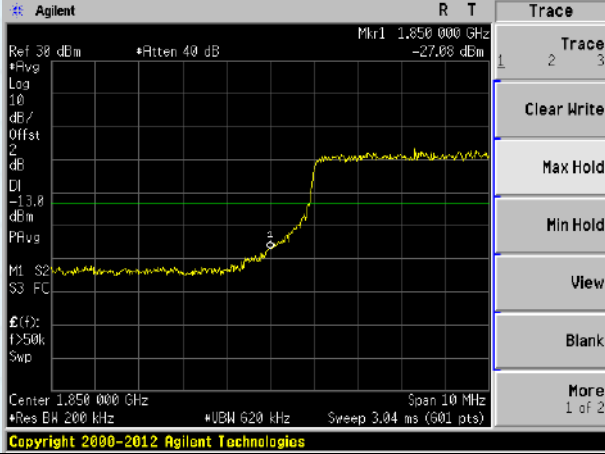

Lowest channel

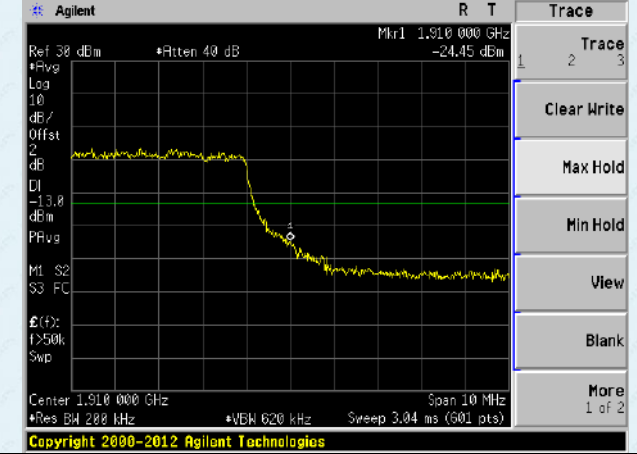

Highest channel

20MHz Bandwidth (RB size:100# RB offset:0#) 20MHz Bandwidth (RB size:100# RB offset:0#)

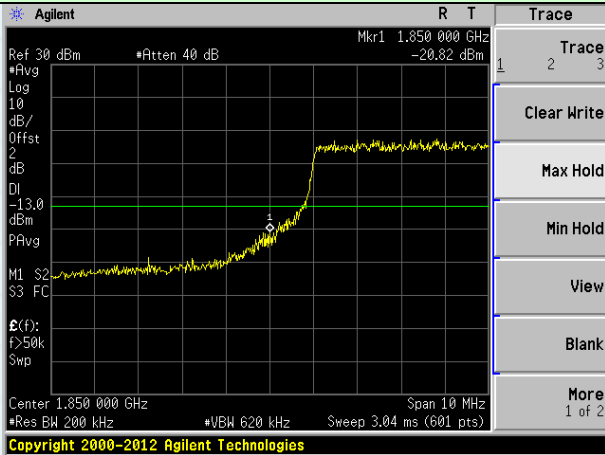

Lowest channel

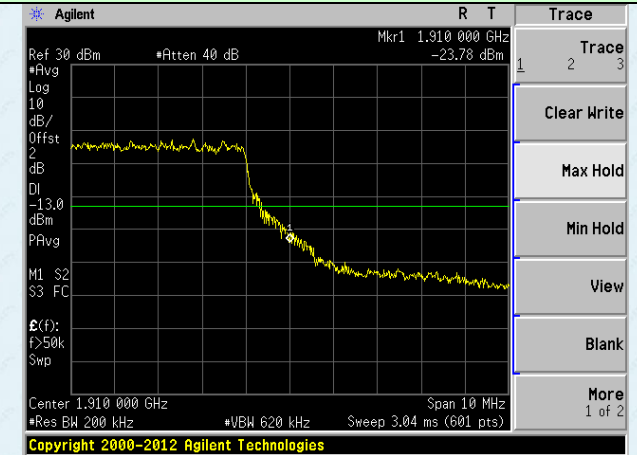

Highest channel

LTE Band 4 (16QAM mode):

1.4MHz Bandwidth (RB size:1# RB offset:0#)

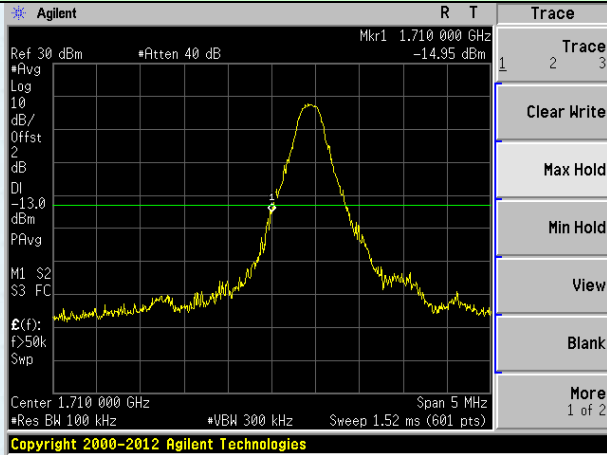

Lowest channel

1.4MHz Bandwidth (RB size:1# RB offset:5#)

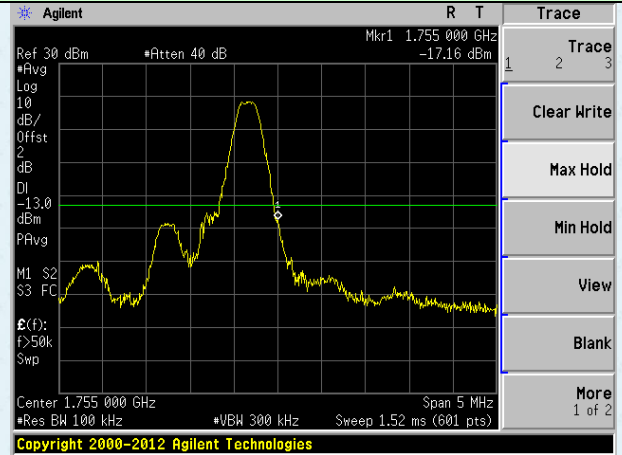

Highest channel

1.4MHz Bandwidth (RB size:3# RB offset:0#)

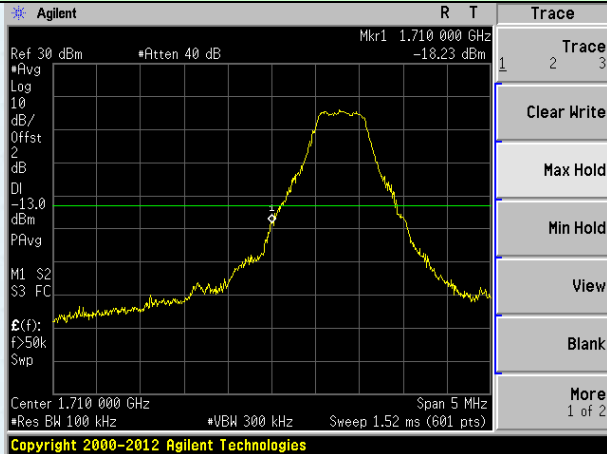

Lowest channel

1.4MHz Bandwidth (RB size:3# RB offset:2#)

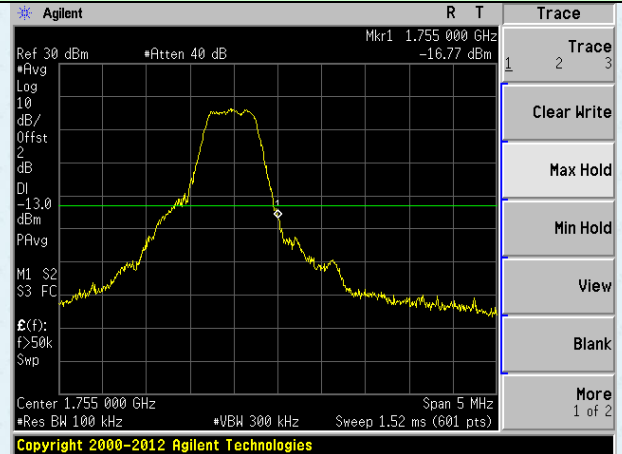

Highest channel

1.4MHz Bandwidth (RB size:6# RB offset:0#)

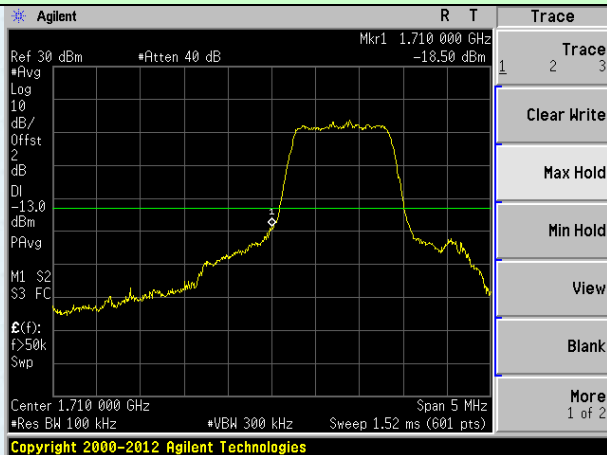

Lowest channel

1.4MHz Bandwidth (RB size:6# RB offset:0#)

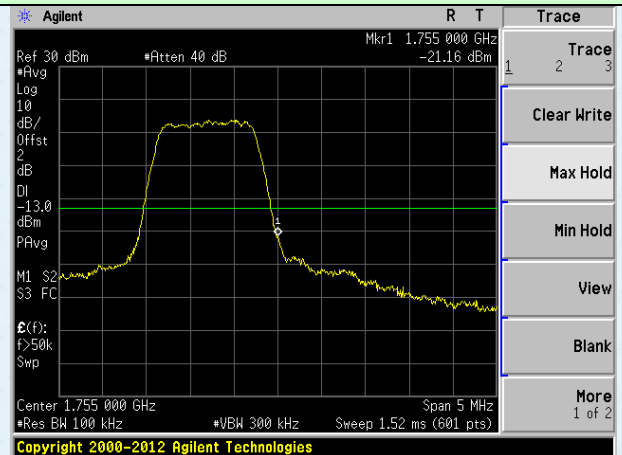

Highest channel

3MHz Bandwidth (RB size:1# RB offset:0#) **3MHz Bandwidth (RB size:1# RB offset:14#)**

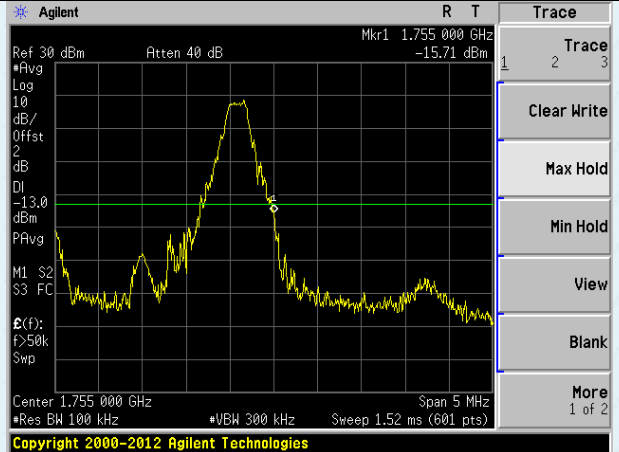
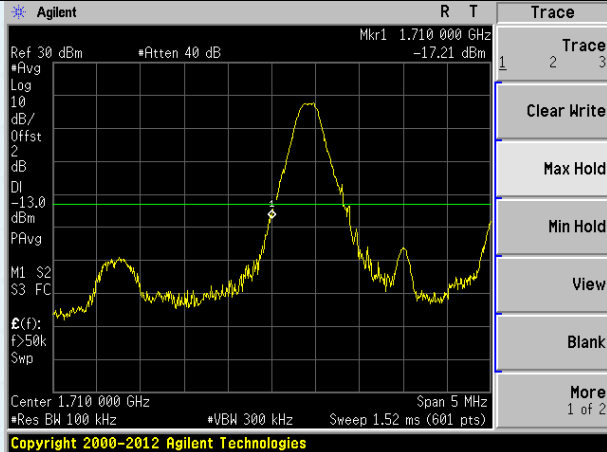

Lowest channel

Highest channel

3MHz Bandwidth (RB size:8# RB offset:0#) **3MHz Bandwidth (RB size:8# RB offset:7#)**

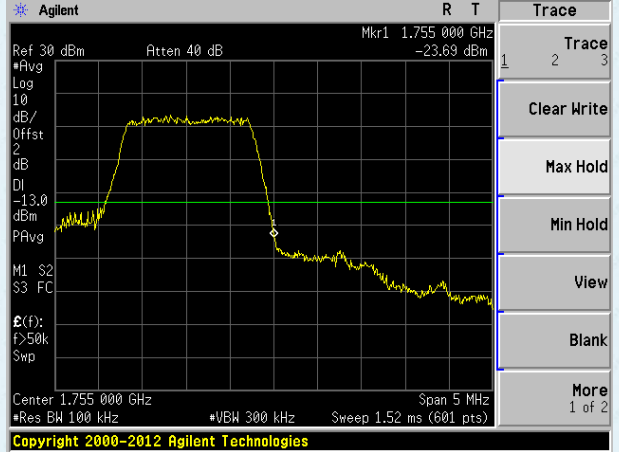
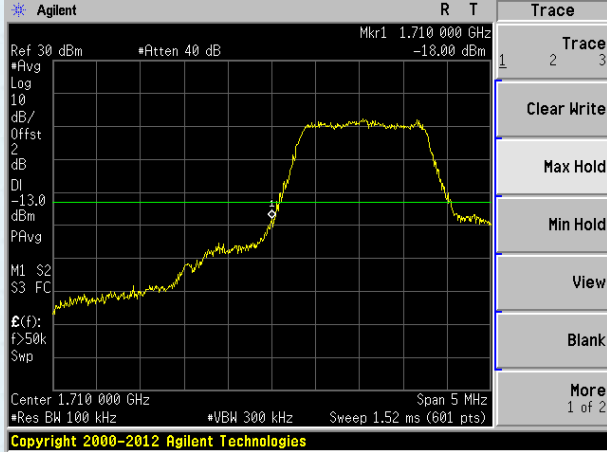

Lowest channel

Highest channel

3MHz Bandwidth (RB size:15# RB offset:0#) **3MHz Bandwidth (RB size:15# RB offset:0#)**

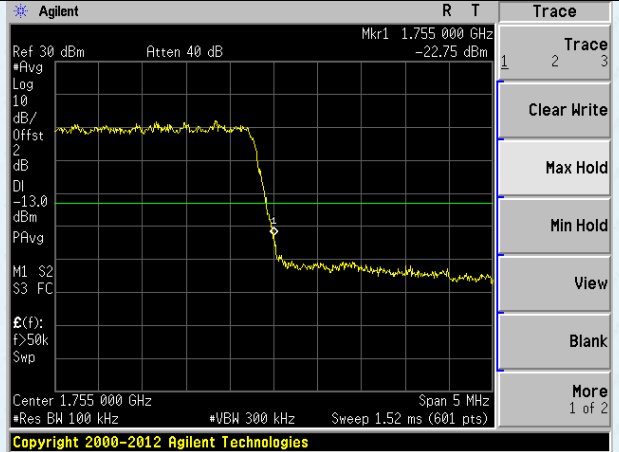
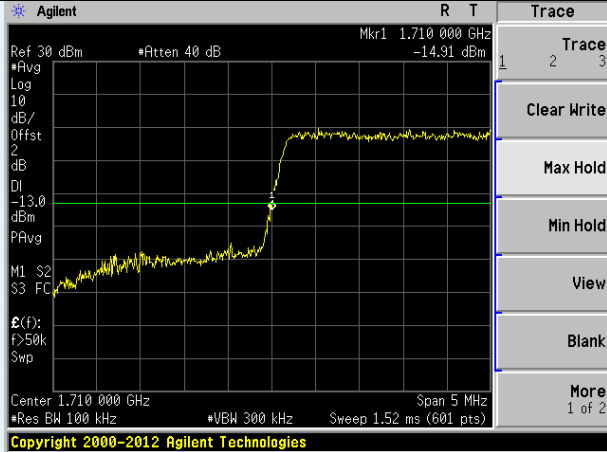

Lowest channel

Highest channel

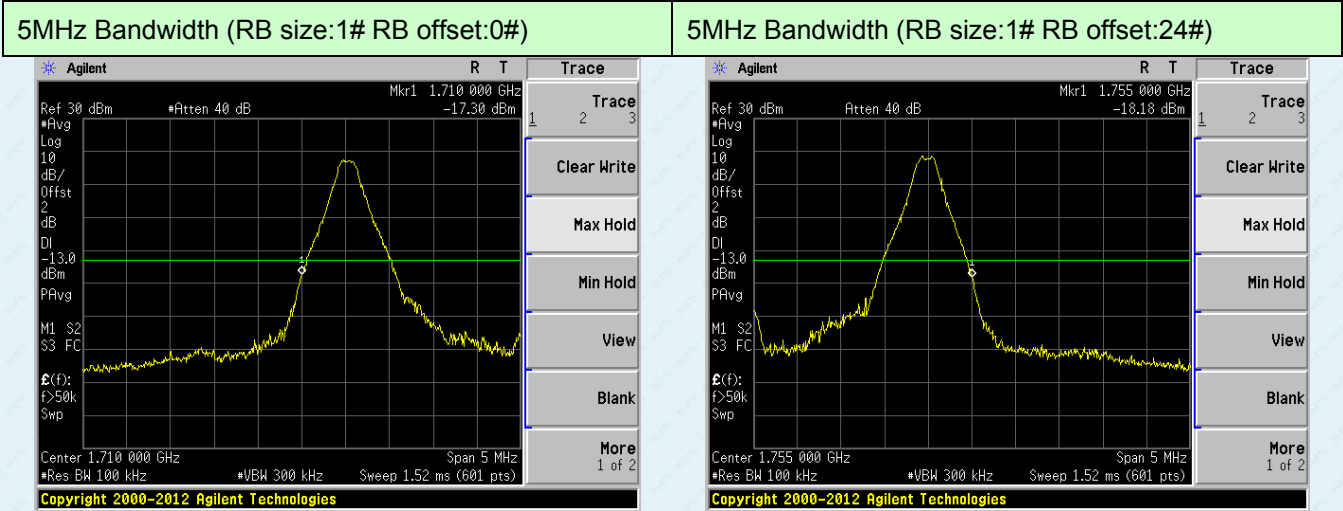

Lowest channel

Highest channel

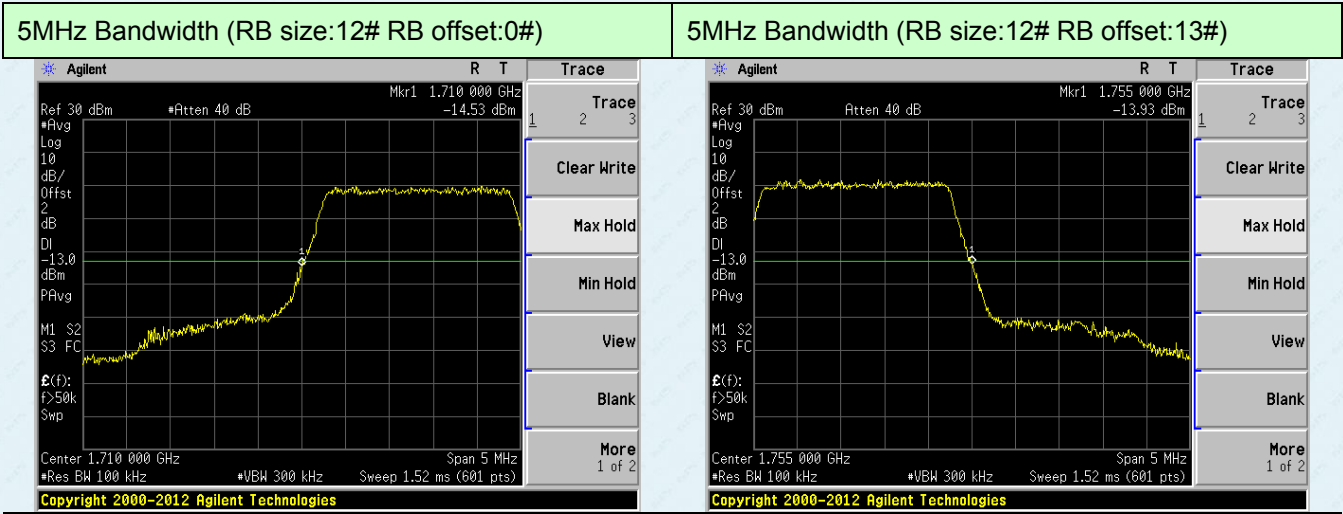

Lowest channel

Highest channel

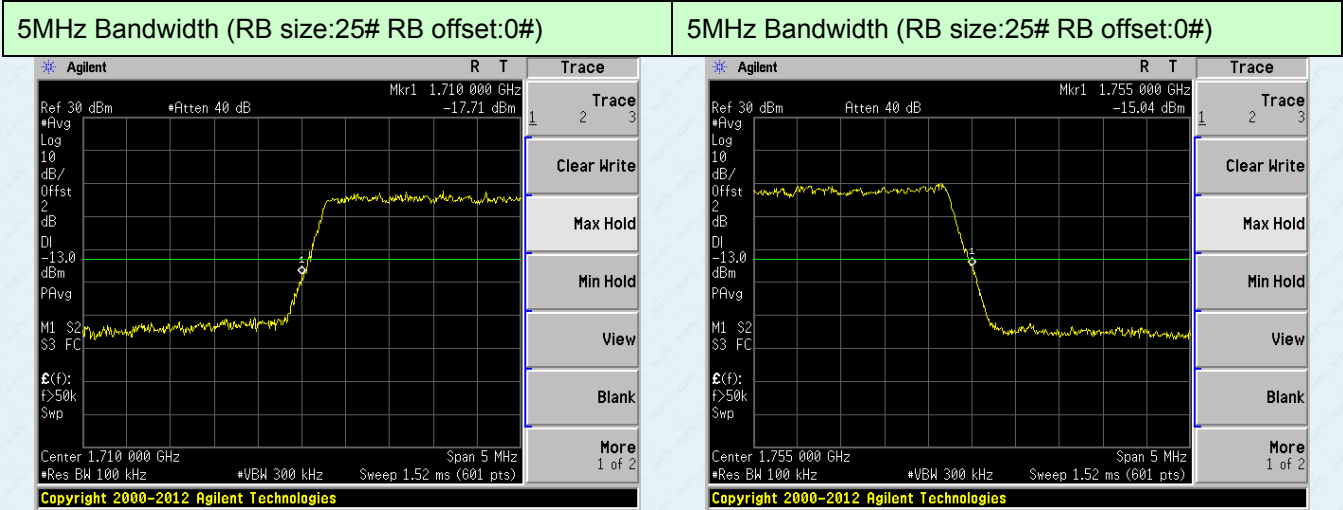

Lowest channel

Highest channel

10MHz Bandwidth (RB size:1# RB offset:0#) 10MHz Bandwidth (RB size:1# RB offset:49#)

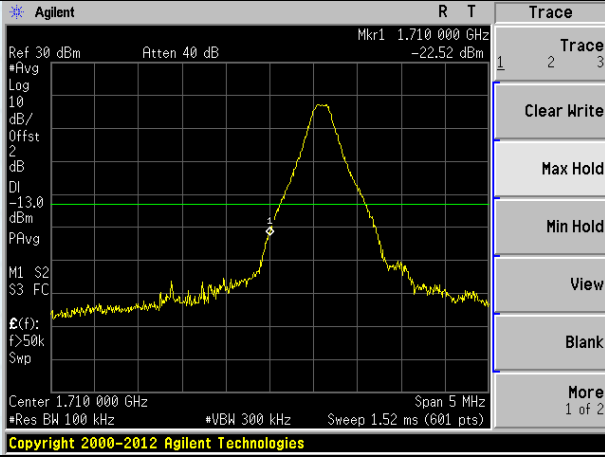

Lowest channel

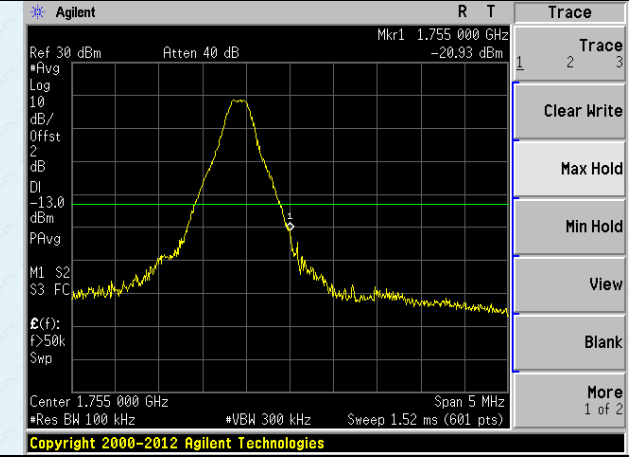

Highest channel

10MHz Bandwidth (RB size:25# RB offset:0#) 10MHz Bandwidth (RB size:25# RB offset:25#)

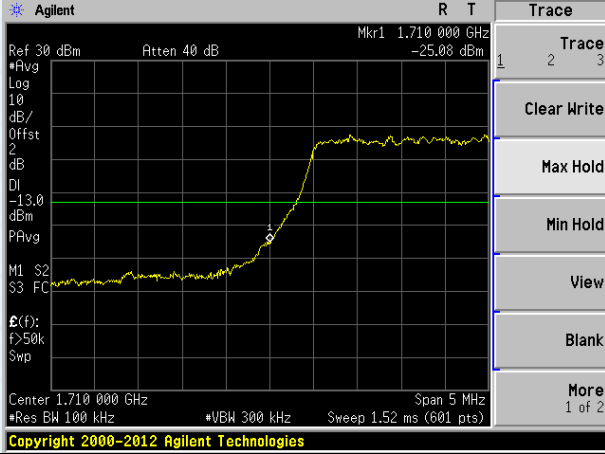

Lowest channel

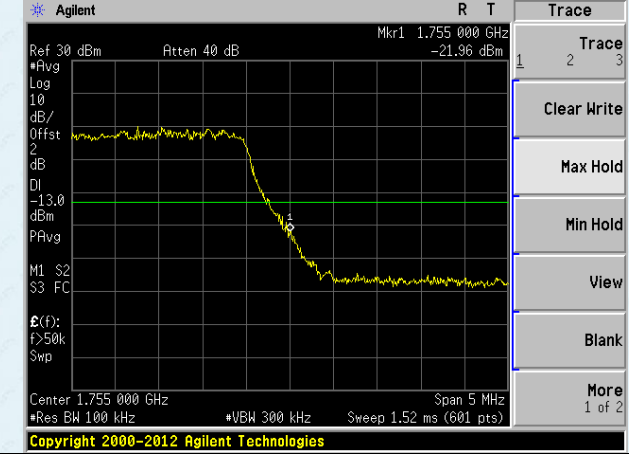

Highest channel

10MHz Bandwidth (RB size:50# RB offset:0#) 10MHz Bandwidth (RB size:50# RB offset:0#)

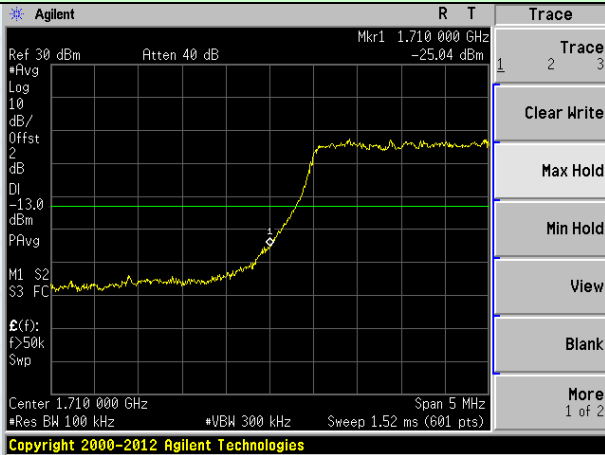

Lowest channel

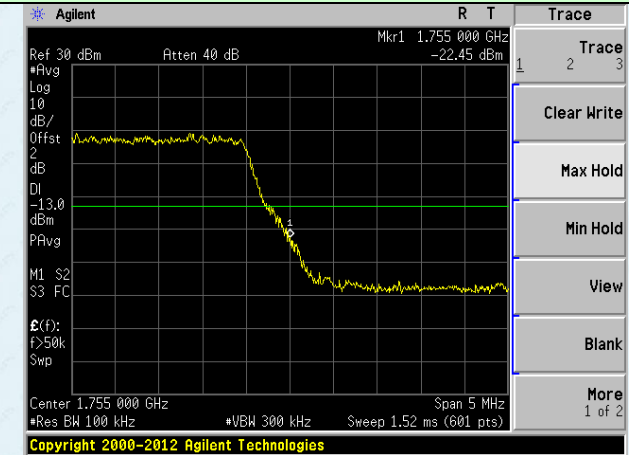

Highest channel

15MHz Bandwidth (RB size:1# RB offset:0#) 15MHz Bandwidth (RB size:1# RB offset:74#)

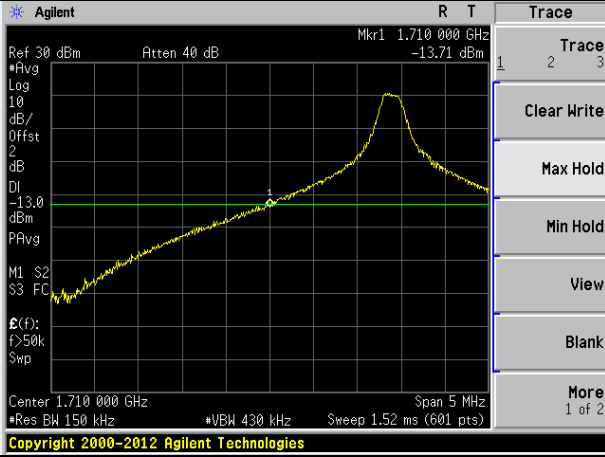

Lowest channel

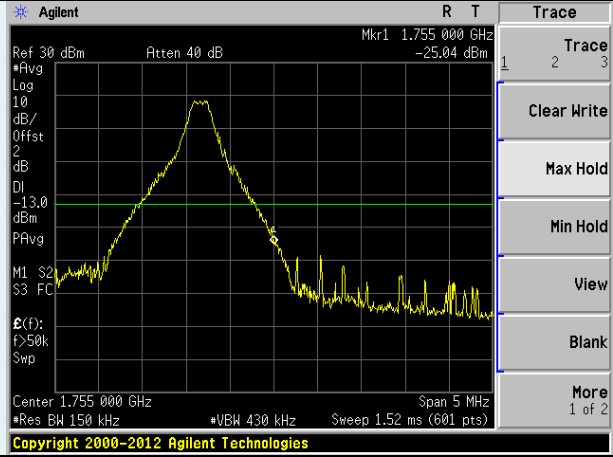

Highest channel

15MHz Bandwidth (RB size:36# RB offset:0#) 15MHz Bandwidth (RB size:36# RB offset:39#)

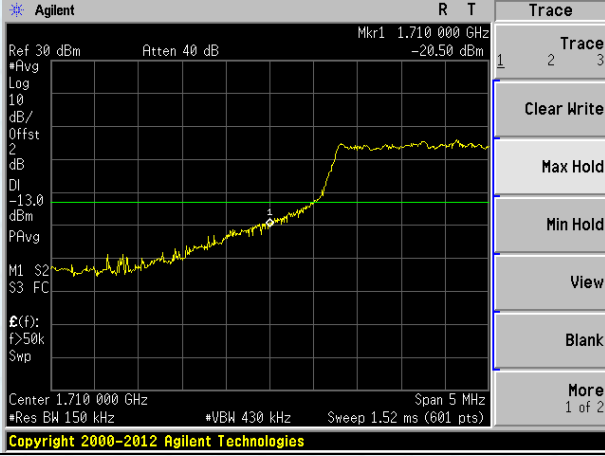

Lowest channel

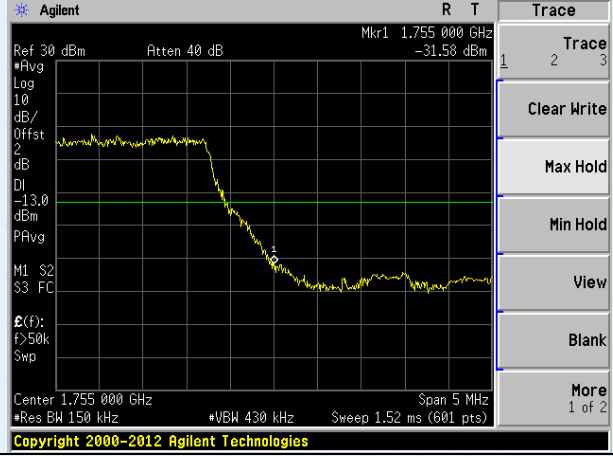

Highest channel

15MHz Bandwidth (RB size:75# RB offset:0#) 15MHz Bandwidth (RB size:75# RB offset:0#)

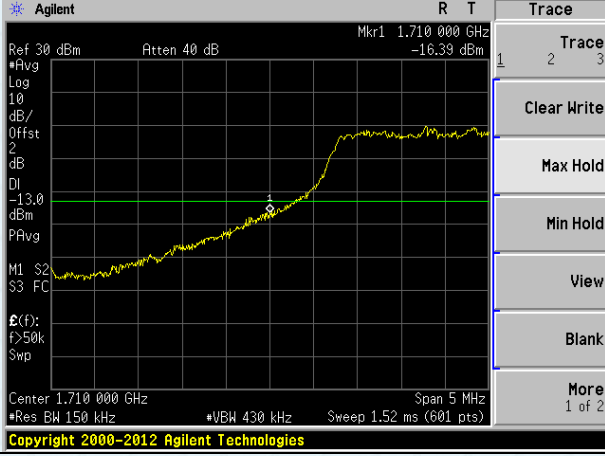

Lowest channel



Highest channel

20MHz Bandwidth (RB size:1# RB offset:0#) 20MHz Bandwidth (RB size:1# RB offset:99#)

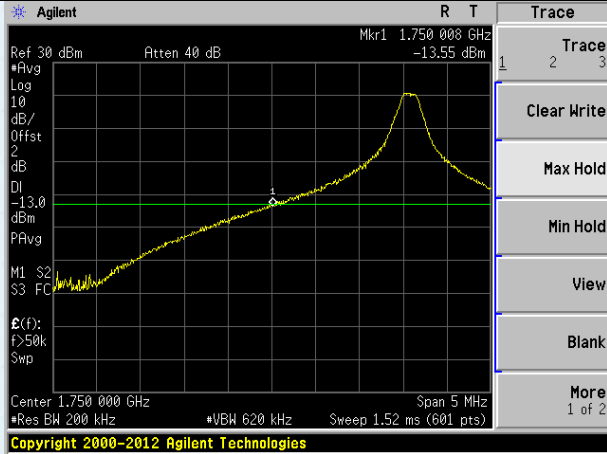

Lowest channel

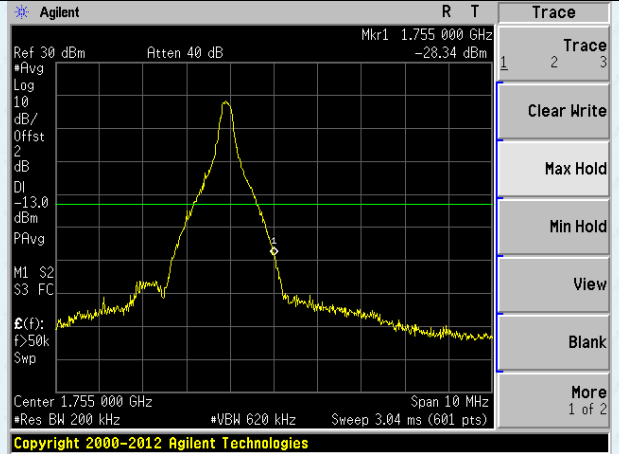

Highest channel

20MHz Bandwidth (RB size:50# RB offset:0#) 20MHz Bandwidth (RB size:50# RB offset:50#)

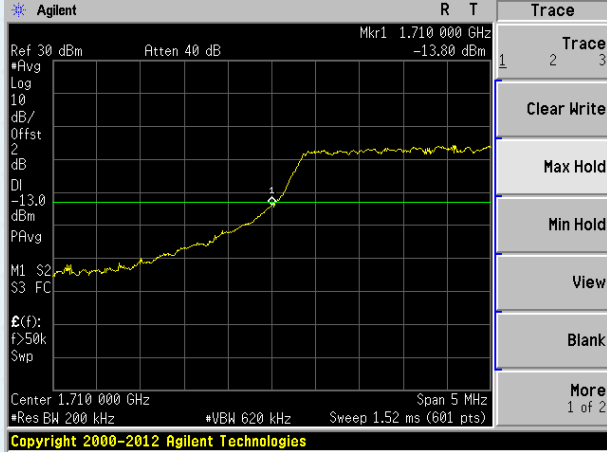

Lowest channel

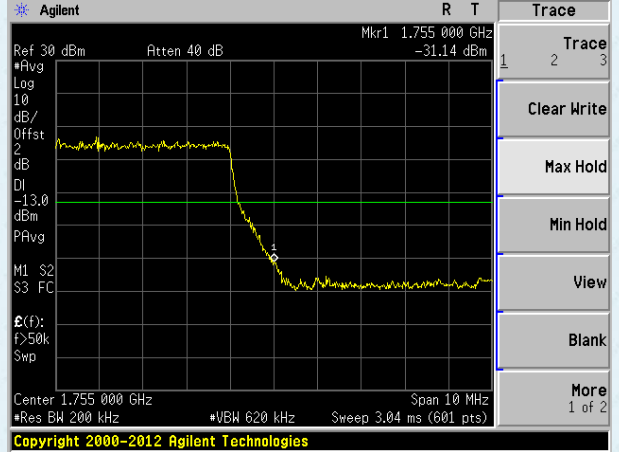

Highest channel

20MHz Bandwidth (RB size:100# RB offset:0#) 20MHz Bandwidth (RB size:100# RB offset:0#)

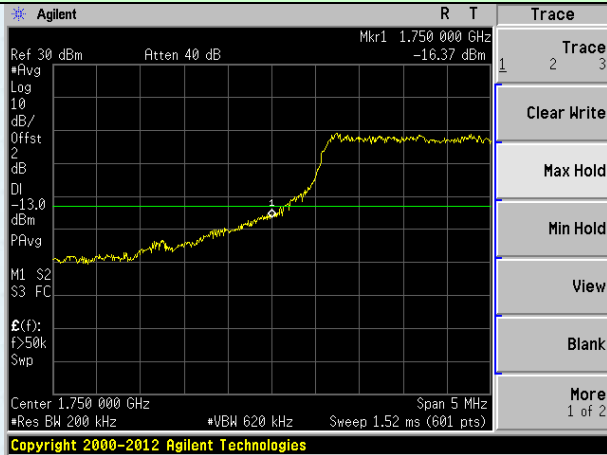

Lowest channel

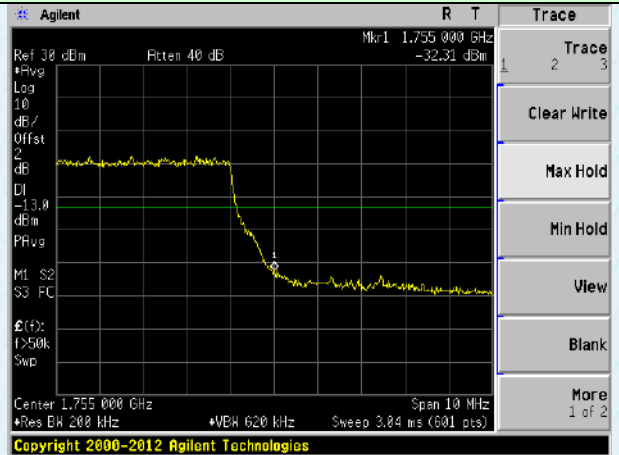

Highest channel

LTE Band 12 (16QAM mode):

1.4MHz Bandwidth (RB size:1# RB offset:0#)

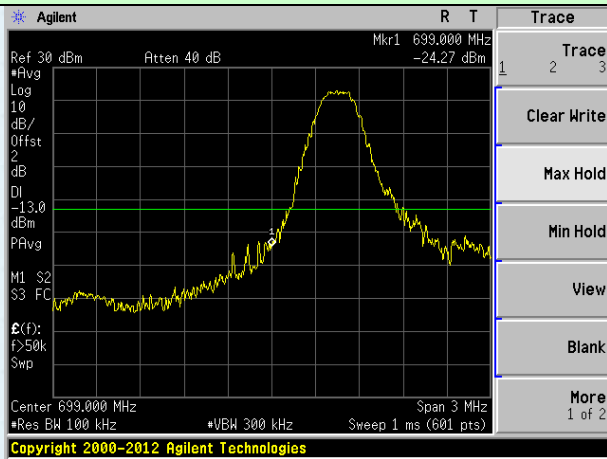

Lowest channel

1.4MHz Bandwidth (RB size:1# RB offset:5#)

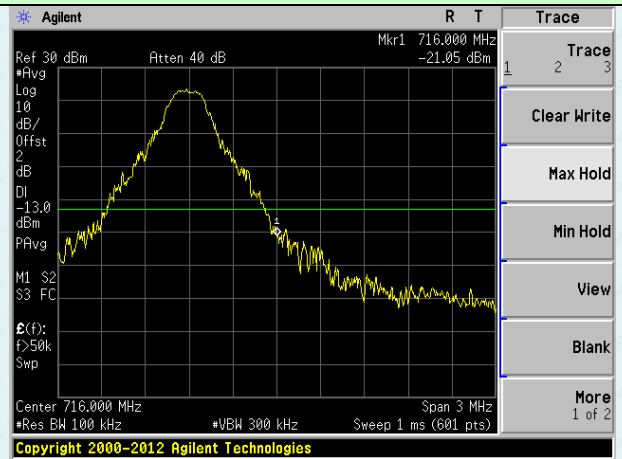

Highest channel

1.4MHz Bandwidth (RB size:3# RB offset:0#)



Lowest channel

1.4MHz Bandwidth (RB size:3# RB offset:2#)



Highest channel

1.4MHz Bandwidth (RB size:6# RB offset:0#)

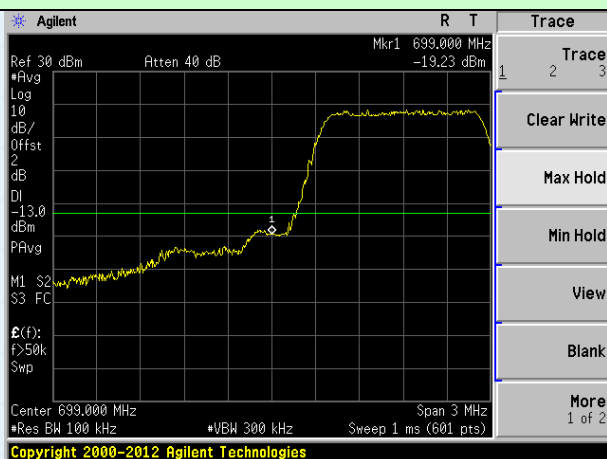

Lowest channel

1.4MHz Bandwidth (RB size:6# RB offset:0#)

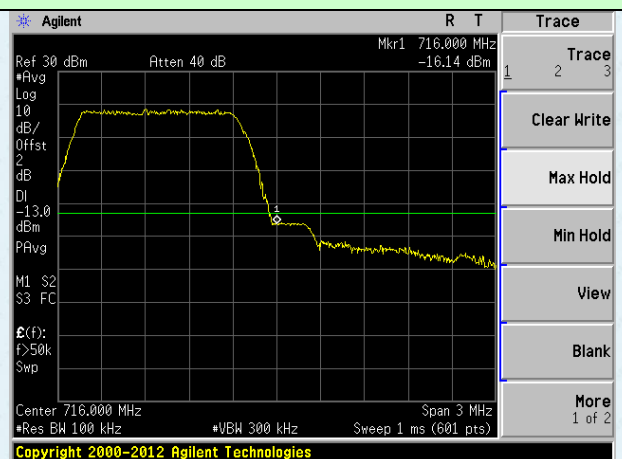

Highest channel

3MHz Bandwidth (RB size:1# RB offset:0#) **3MHz Bandwidth (RB size:1# RB offset:14#)**

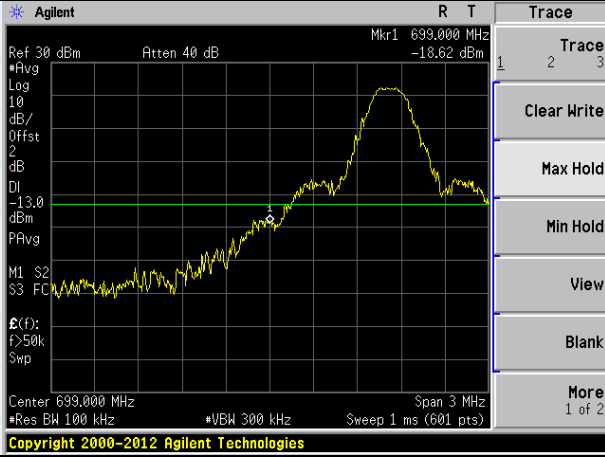

Lowest channel

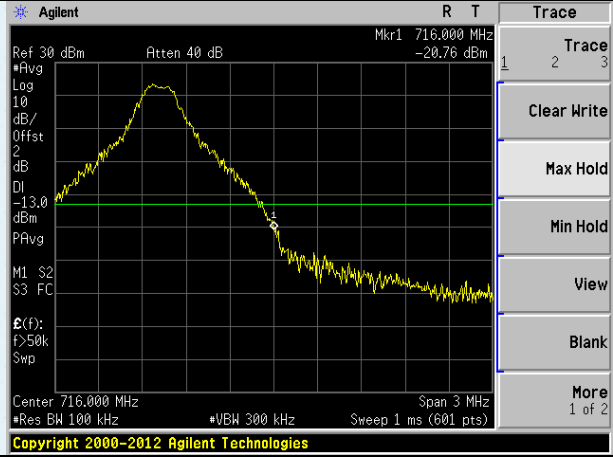

Highest channel

3MHz Bandwidth (RB size:8# RB offset:0#) **3MHz Bandwidth (RB size:8# RB offset:7#)**

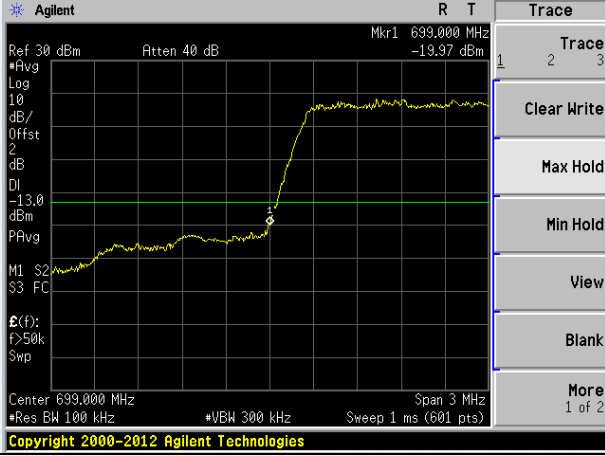

Lowest channel

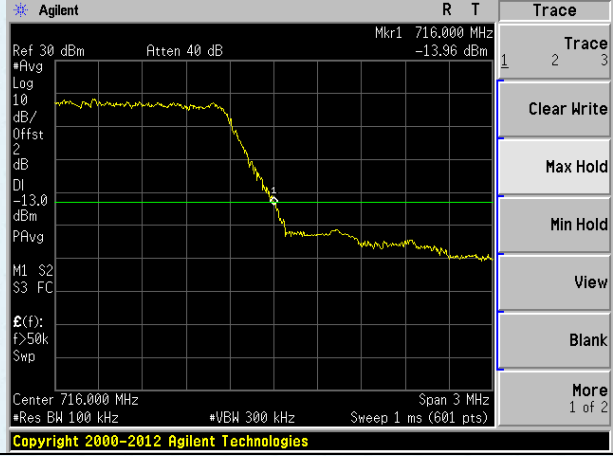

Highest channel

3MHz Bandwidth (RB size:15# RB offset:0#) **3MHz Bandwidth (RB size:15# RB offset:0#)**

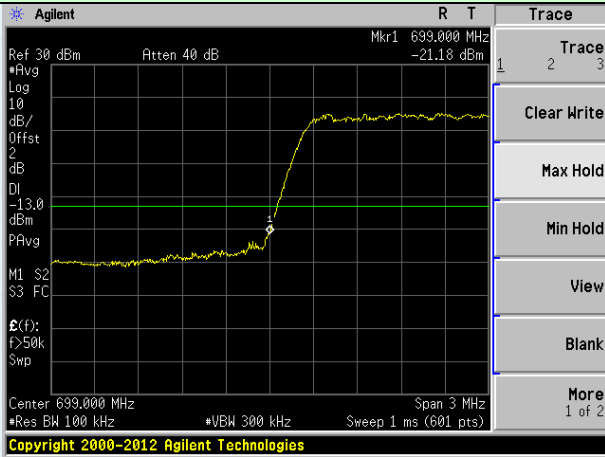

Lowest channel

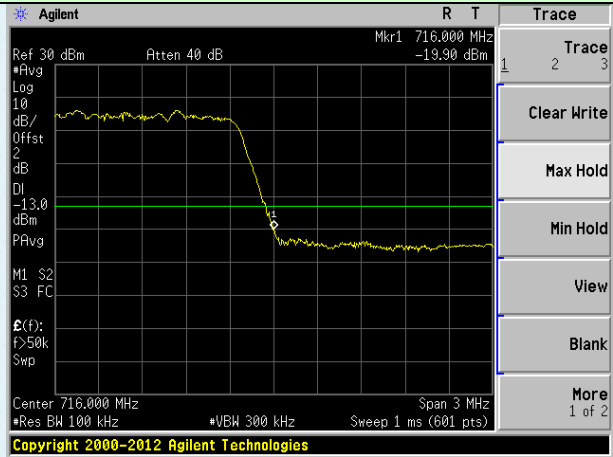

Highest channel

5MHz Bandwidth (RB size:1# RB offset:0#) 5MHz Bandwidth (RB size:1# RB offset:24#)

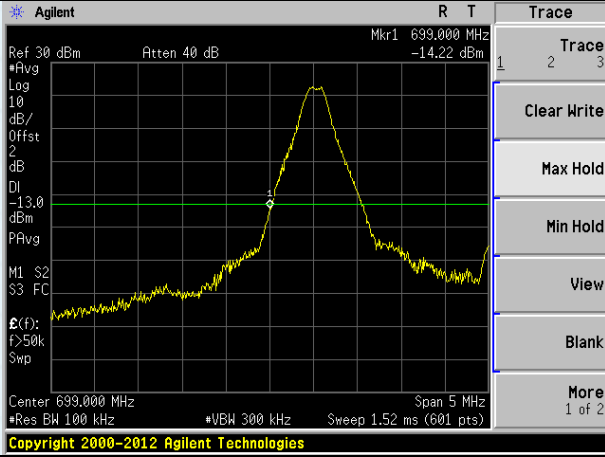

Lowest channel

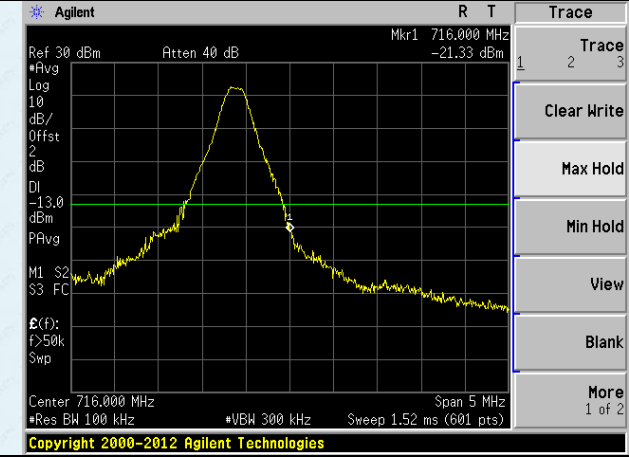

Highest channel

5MHz Bandwidth (RB size:12# RB offset:0#) 5MHz Bandwidth (RB size:12# RB offset:13#)

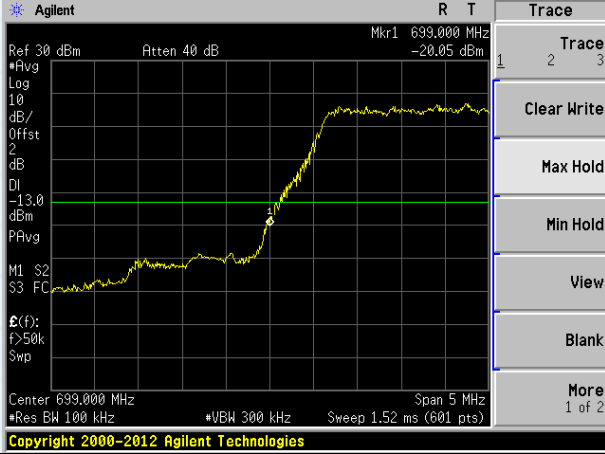

Lowest channel

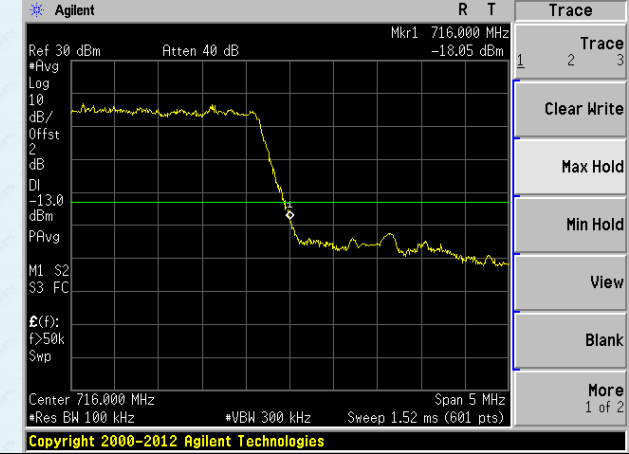

Highest channel

5MHz Bandwidth (RB size:25# RB offset:0#) 5MHz Bandwidth (RB size:25# RB offset:0#)

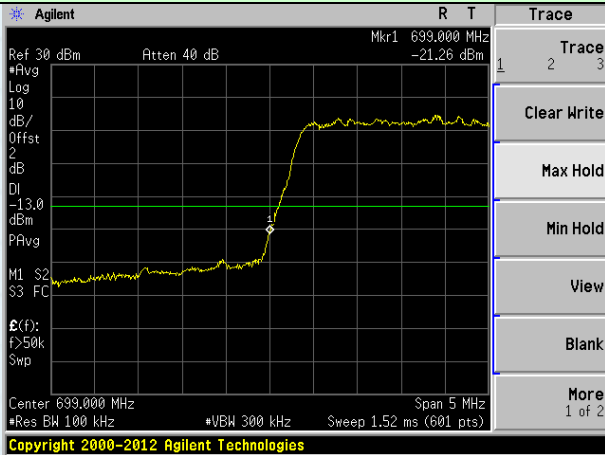

Lowest channel



Highest channel

10MHz Bandwidth (RB size:1# RB offset:0#)

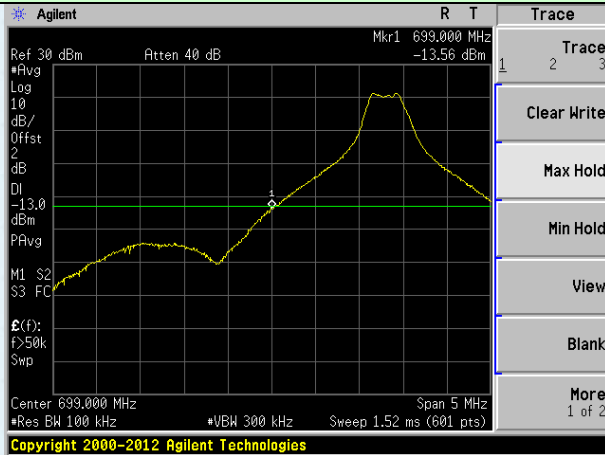

Lowest channel

10MHz Bandwidth (RB size:1# RB offset:49#)

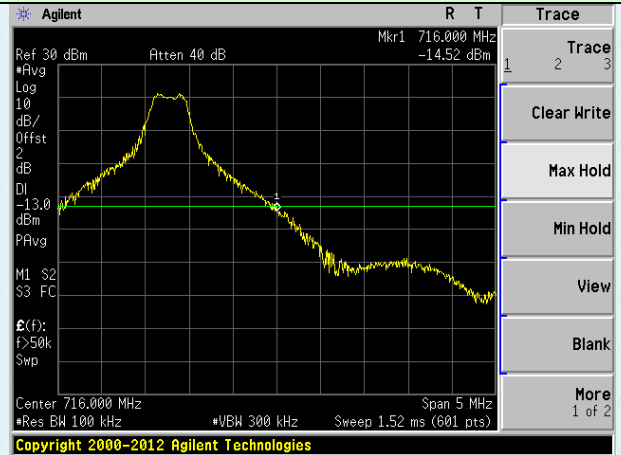

Highest channel

10MHz Bandwidth (RB size:25# RB offset:0#)

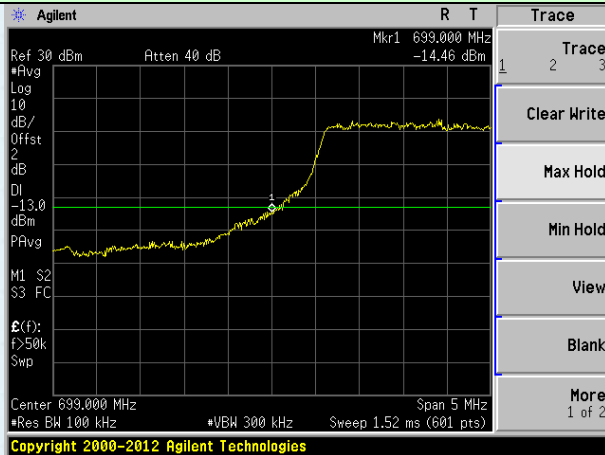

Lowest channel

10MHz Bandwidth (RB size:25# RB offset:25#)

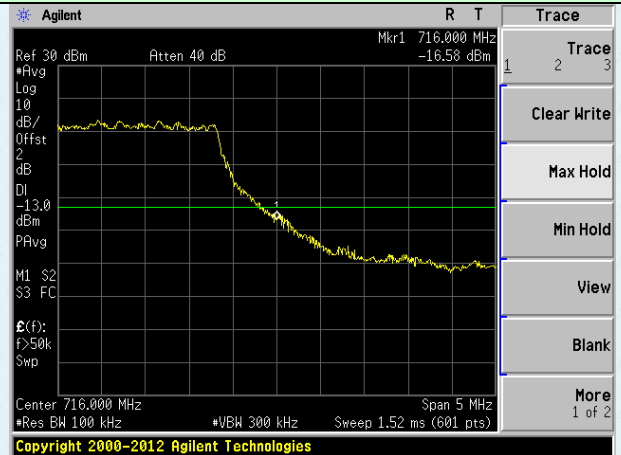

Highest channel

10MHz Bandwidth (RB size:50# RB offset:0#)

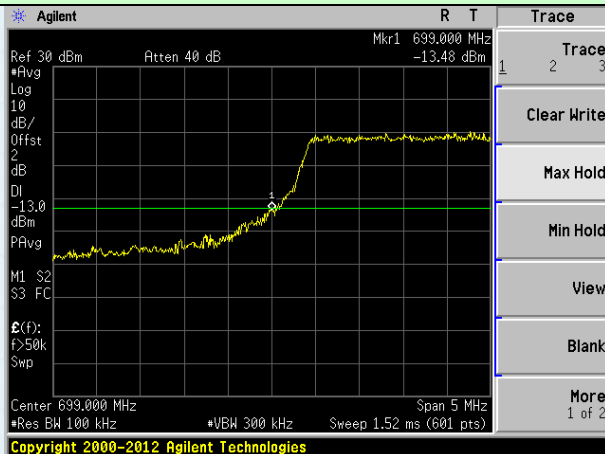

Lowest channel

10MHz Bandwidth (RB size:50# RB offset:0#)

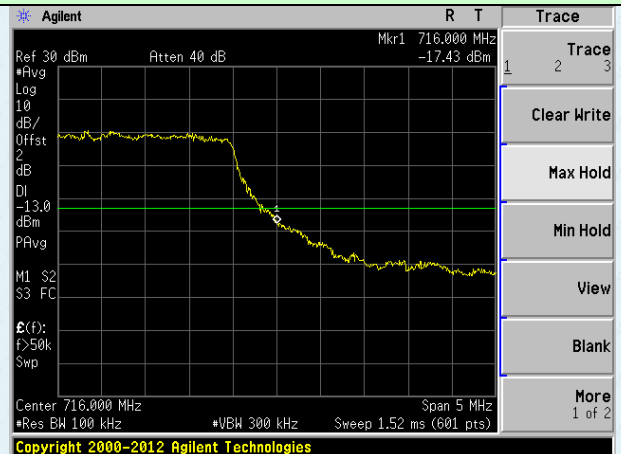

Highest channel

7.8 Field strength of spurious radiation measurement

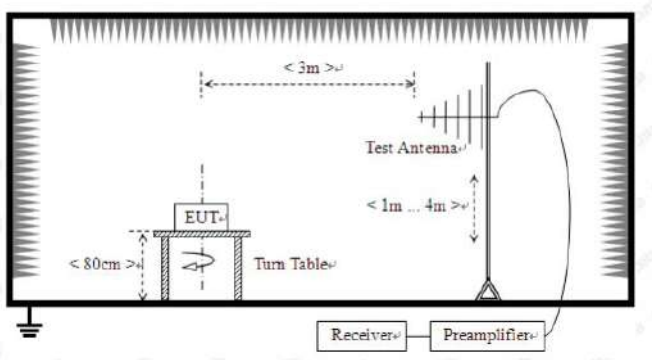
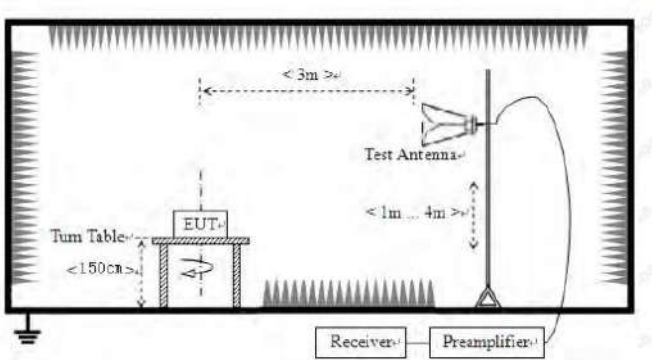
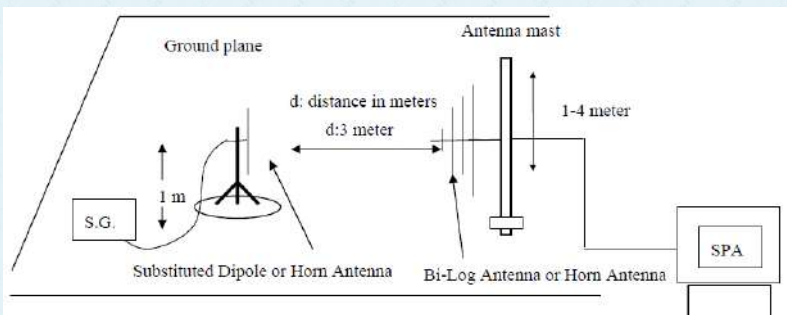
Test Requirement:	Part 24.238 (a); FCC Part 27.53(h)/(g)
Test Method:	FCC part2.1053 and ANSI C63.26:2015
Limit:	Band 2/4/12:-13dBm
Test setup:	<p>Below 1GHz</p>  <p>Above 1GHz</p>  <p>Substituted method:</p> 
Test Instruments:	Refer to section 6.0 for details
Test mode:	Refer to section 7.1 for details
Test results:	Pass

Measurement Data

LTE Band 2 @20MHz, QPSK								
Channel	Frequency(MHz)	Polarization	SGP [dBm]	Substitution Gain[dBi]	Cable loss[dB]	EIRP (dBm)	Limit (dBm)	Over Limit (dBm)
Lowest	3720	H	-46.36	13.13	3.89	-37.12	-13	-24.12
	5580	H	-52.64	11.62	5.28	-46.3	-13	-33.3
	7440	H	-47.6	10.22	6.77	-44.15	-13	-31.15
	3720	V	-50.41	13.13	3.89	-41.17	-13	-28.17
	5580	V	-51.5	11.62	5.28	-45.16	-13	-32.16
	7440	V	-49.33	10.22	6.77	-45.88	-13	-32.88
Middle	3760	H	-51.81	13.13	3.9	-42.58	-13	-29.58
	5640	H	-47.09	11.62	5.33	-40.8	-13	-27.8
	7520	H	-47.93	10.22	6.82	-44.53	-13	-31.53
	3760	V	-53.99	13.13	3.9	-44.76	-13	-31.76
	5640	V	-49.66	11.62	5.33	-43.37	-13	-30.37
	7520	V	-55.74	10.22	6.82	-52.34	-13	-39.34
Highest	3800	H	-51.28	13.13	3.92	-42.07	-13	-29.07
	5700	H	-55.68	11.62	5.37	-49.43	-13	-36.43
	7600	H	-54.4	10.22	6.81	-50.99	-13	-37.99
	3800	V	-49.31	13.13	3.92	-40.1	-13	-27.1
	5700	V	-52.36	11.62	5.37	-46.11	-13	-33.11
	7600	V	-51.94	10.22	6.81	-48.53	-13	-35.53

Remark:

1. Spurious emissions within 30-1000MHz were found more than 20dB below limit
2. QPSK and 16QAM models for all bandwidth have been tested, just the worst case was recorded in report.

LTE Band 4 @20MHz, QPSK								
Channel	Frequency(MHz)	Polarization	SGP [dBm]	Substitution Gain[dBi]	Cable loss[dB]	EIRP (dBm)	Limit (dBm)	Over Limit (dBm)
Lowest	3440	H	-46.66	11.96	3.69	-38.39	-13	-25.39
	5160	H	-48.69	10.11	4.96	-43.54	-13	-30.54
	6880	H	-52.65	10.37	6.14	-48.42	-13	-35.42
	3440	V	-47.61	8.96	3.69	-42.34	-13	-29.34
	5160	V	-49.19	10.11	4.96	-44.04	-13	-31.04
	6880	V	-55.84	10.37	6.14	-51.61	-13	-38.61
Middle	3465	H	-54.6	8.96	3.71	-49.35	-13	-36.35
	5197.5	H	-54.89	10.11	4.99	-49.77	-13	-36.77
	6930	H	-47.6	10.37	6.18	-43.41	-13	-30.41
	3465	V	-53.2	8.96	3.71	-47.95	-13	-34.95
	5197.5	V	-55.34	10.11	4.99	-50.22	-13	-37.22
	6930	V	-47.38	10.37	6.18	-43.19	-13	-30.19
Highest	3490	H	-53.41	8.96	3.72	-48.17	-13	-35.17
	5235	H	-49.79	10.11	5.02	-44.7	-13	-31.7
	6980	H	-52.85	10.37	6.23	-48.71	-13	-35.71
	3490	V	-51.93	8.96	3.72	-46.69	-13	-33.69
	5235	V	-50.76	10.11	5.02	-45.67	-13	-32.67
	6980	V	-47.32	10.37	6.23	-43.18	-13	-30.18

Remark:

1. Spurious emissions within 30-1000MHz were found more than 20dB below limit
2. QPSK and 16QAM models for all bandwidth have been tested, just the worst case was recorded in report.

LTE Band 12 @10MHz, QPSK								
Channel	Frequency(MHz)	Polarization	SGP [dBm]	Substitution Gain[dBi]	Cable loss[dB]	ERP (dBm)	Limit (dBm)	Over Limit (dBm)
Lowest	1408	H	-47.88	-3.54	2.27	-55.84	-13	-42.84
	2112	H	-51.98	-3.31	2.35	-59.79	-13	-46.79
	2816	H	-51.02	-3.84	2.58	-59.59	-13	-46.59
	1408	V	-54.79	-3.54	2.27	-62.75	-13	-49.75
	2112	V	-47.05	-3.31	2.35	-54.86	-13	-41.86
	2816	V	-49.74	-3.84	2.58	-58.31	-13	-45.31
Middle	1415	H	-55.13	-3.54	2.27	-63.09	-13	-50.09
	2122.5	H	-53.29	-3.31	2.35	-61.1	-13	-48.1
	2830	H	-48.48	-3.84	2.58	-57.05	-13	-44.05
	1415	V	-53.14	-3.54	2.27	-61.1	-13	-48.1
	2122.5	V	-50.68	-3.31	2.35	-58.49	-13	-45.49
	2830	V	-50.62	-3.84	2.58	-59.19	-13	-46.19
Highest	1422	H	-49.04	-3.54	2.27	-57	-13	-44
	2133	H	-51.54	-3.31	2.35	-59.35	-13	-46.35
	2844	H	-52.67	-3.84	2.58	-61.24	-13	-48.24
	1422	V	-48.82	-3.54	2.27	-56.78	-13	-43.78
	2133	V	-47.59	-3.31	2.35	-55.4	-13	-42.4
	2844	V	-48.12	-3.84	2.58	-56.69	-13	-43.69

Remark:

1. Spurious emissions within 30-1000MHz were found more than 20dB below limit
2. QPSK and 16QAM models for all bandwidth have been tested, just the worst case was recorded in report.

7.9 Frequency stability V.S. Temperature measurement

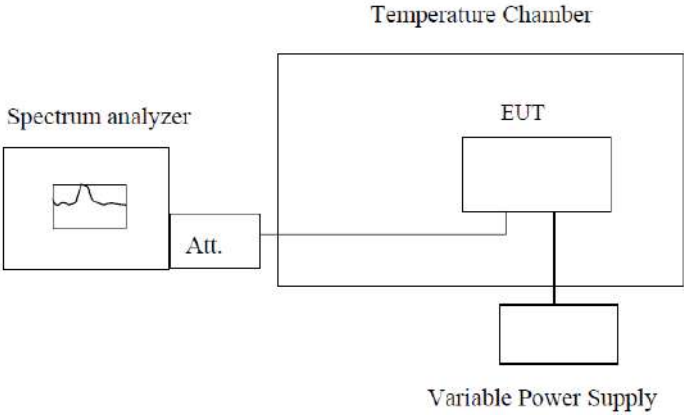
Test Requirement:	FCC Part2.1055(a)(1)(b)
Test Method:	FCC Part2.1055(a)(1)(b)
Limit:	2.5ppm
Test setup:	 <p>Note : Measurement setup for testing on Antenna connector</p>
Test procedure:	<ol style="list-style-type: none"> 1. The equipment under test was connected to an external DC power supply and input rated voltage. 2. RF output was connected to a frequency counter or spectrum analyzer via feed through attenuators. 3. The EUT was placed inside the temperature chamber. 4. Set the spectrum analyzer RBW low enough to obtain the desired frequency resolution and measure EUT 25°C operating frequency as reference frequency. 5. Turn EUT off and set the chamber temperature to -20°C . After the temperature stabilized for approximately 30 minutes recorded the frequency. 6. Repeat step measure with 10°C increased per stage until the highest temperature of +50°C reached.
Test Instruments:	Refer to section 6.0 for details
Test mode:	Refer to section 7.1 for details
Test results:	Pass

Modulation Mode: 16QAM Mode

Reference Frequency: LTE Band 2 Middle channel=18900 channel=1880MHz					
Power supplied (Vdc)	Temperature (°C)	Frequency error		Limit (ppm)	Result
		Hz	ppm		
12	-20	42	0.0224	2.5	Pass
	-10	36	0.0193		
	0	31	0.0163		
	10	35	0.0186		
	20	31	0.0163		
	30	48	0.0254		
	40	43	0.0231		
	50	42	0.0224		
Reference Frequency: LTE Band 4 Middle channel=20175 channel=1732.5MHz					
Power supplied (Vdc)	Temperature (°C)	Frequency error		Limit (ppm)	Result
		Hz	ppm		
12	-20	18	0.0101	2.5	Pass
	-10	14	0.0080		
	0	12	0.0066		
	10	13	0.0073		
	20	10	0.0059		
	30	24	0.0136		
	40	19	0.0108		
	50	18	0.0101		
Reference Frequency: LTE Band 12 Middle channel=23095 channel=707.5MHz					
Power supplied (Vdc)	Temperature (°C)	Frequency error		Limit (ppm)	Result
		Hz	ppm		
12	-20	46	0.0654	2.5	Pass
	-10	38	0.0538		
	0	31	0.0441		
	10	38	0.0538		
	20	33	0.0460		
	30	56	0.0789		
	40	48	0.0673		
	50	45	0.0634		

7.10 Frequency stability V.S. Voltage measurement

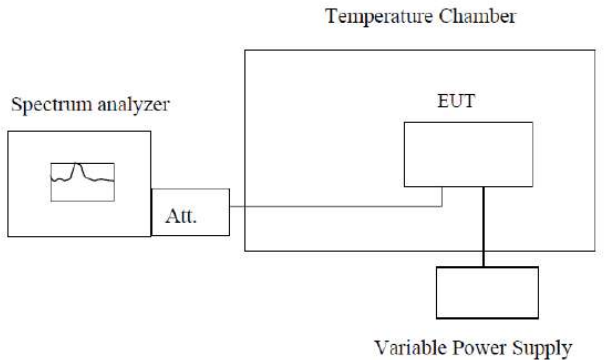
Test Requirement:	FCC Part2.1055(d)(1)(2)
Test Method:	FCC Part2.1055(d)(1)(2)
Limit:	2.5ppm
Test setup:	 <p style="text-align: center;">Temperature Chamber</p> <p style="text-align: center;">Spectrum analyzer</p> <p style="text-align: center;">Att.</p> <p style="text-align: center;">EUT</p> <p style="text-align: center;">Variable Power Supply</p> <p>Note : Measurement setup for testing on Antenna connector</p>
Test procedure:	<ol style="list-style-type: none"> 1. Set chamber temperature to 25°C . Use a variable DC power source to power the EUT and set the voltage to rated voltage. 2. Set the spectrum analyzer RBW low enough to obtain the desired frequency resolution and recorded the frequency. 3. Reduce the input voltage to specified extreme voltage variation (+/- 15%) and endpoint, record the maximum frequency change.
Test Instruments:	Refer to section 6.0 for details
Test mode:	Refer to section 7.1 for details
Test results:	Pass

Measurement Data

Modulation Mode: QPSK Mode

Reference Frequency: LTE Band 2 Middle channel=18900 channel=1880MHz					
Temperature (°C)	Power supplied (Vdc)	Frequency error		Limit (ppm)	Result
		Hz	ppm		
25	12	19	0.0100	2.5	Pass
	24	24	0.0125		
Reference Frequency: LTE Band 4 Middle channel=20175 channel=1732.5MHz					
Temperature (°C)	Power supplied (Vdc)	Frequency error		Limit (ppm)	Result
		Hz	ppm		
25	12	25	0.0144	2.5	Pass
	24	17	0.0097		
Reference Frequency: LTE Band 12 Middle channel=23095 channel=707.5MHz					
Temperature (°C)	Power supplied (Vdc)	Frequency error		Limit (ppm)	Result
		Hz	ppm		
25	12	23	0.0326	2.5	Pass
	24	31	0.0434		

Modulation Mode: 16QAM Mode

Reference Frequency: LTE Band 2 Middle channel=18900 channel=1880MHz					
Temperature (°C)	Power supplied (Vdc)	Frequency error		Limit (ppm)	Result
		Hz	ppm		
25	12	20	0.0107	2.5	Pass
	24	23	0.0120		
Reference Frequency: LTE Band 4 Middle channel=20175 channel=1732.5MHz					
Temperature (°C)	Power supplied (Vdc)	Frequency error		Limit (ppm)	Result
		Hz	ppm		
25	12	26	0.0152	2.5	Pass
	24	18	0.0102		
Reference Frequency: LTE Band 12 Middle channel=23095 channel=707.5MHz					
Temperature (°C)	Power supplied (Vdc)	Frequency error		Limit (ppm)	Result
		Hz	ppm		
25	4.25	23	0.0319	2.5	Pass
	3.40	30	0.0419		

8 Test Setup Photo

Reference to the **appendix I** for details.

9 EUT Constructional Details

Reference to the **appendix II** for details

-----End-----